



Shenzhen Global Test Service Co.,Ltd.

1F, Building No. 13A, Zhonghaixin Science and Technology City, No.12,6 Road, Ganli Industrial Park, Buji Street, Longgang District, Shenzhen, Guangdong

FCC PART 27TEST REPORT

FCC Part 27

Report Reference No.....: GTSR17042018-LTE Band 7

FCC ID.....: RQQHLT-ORBITUT

Compiled by
(position+printed name+signature)..: File administrators Jimmy Wang

Supervised by
(position+printed name+signature)..: Test Engineer Peter Xiao

Approved by
(position+printed name+signature)..: Manager Sam Wang

Date of issue.....: April. 28, 2017

Representative Laboratory Name .: Shenzhen Global Test Service Co.,Ltd.

Address: 1F, Building No. 13A, Zhonghaixin Science and Technology City,
No.12,6 Road, Ganli Industrial Park, Buji Street, Longgang District,
Shenzhen, Guangdong

Applicant's name: HYUNDAI CORPORATION

Address: 25,Yulgok-ro 2-Gil, Jongno-gu, Seoul, South Korea

Test specification

Standard: **FCC CFR Title 47 Part 2, Part 27**
EIA/TIA 603-D: 2010
KDB 971168 D01

TRF Originator.....: Shenzhen Global Test Service Co.,Ltd.

Shenzhen Global Test Service Co.,Ltd.All rights reserved.

This publication may be reproduced in whole or in part for non-commercial purposes as long as the Shenzhen Global Test Service Co.,Ltd.as copyright owner and source of the material. Shenzhen Global Test Service Co.,Ltd.takes no responsibility for and will not assume liability for damages resulting from the reader's interpretation of the reproduced material due to its placement and context.

Test item description Mobile Phone

Trade Mark: HYUNDAI

Manufacturer.....: Shenzhen Rainbow Time Technology Co.,Ltd

Model/Type reference.....: ORBIT

Listed Models: /

Modulation Type: QPSK, 16QAM

Rating: DC 3.80V

Hardware version: V1_02_C00SEA

Software version.....: V1.0

Result.....: **PASS**

TEST REPORT

Test Report No. : GTSR17042018-LTE Band 7	April. 28, 2017
	Date of issue

Equipment under Test : Mobile Phone

Model /Type : ORBIT

Listed Models : /

Applicant : **HYUNDAI CORPORATION**

Address : 25,Yulgok-ro 2-Gil, Jongno-gu, Seoul, South Korea

Manufacturer : **Shenzhen Rainbow Time Technology Co.,Ltd**

Address : Room 905, ChangHong Technology Building, Science and
Technology Park, Nanshan District, Shenzhen, China

Test Result:	PASS
---------------------	-------------

The test report merely corresponds to the test sample.
It is not permitted to copy extracts of these test result without the written permission of the test laboratory.

Contents

1.	<u>TEST STANDARDS</u>	<u>4</u>
2.	<u>SUMMARY</u>	<u>5</u>
2.1.	General Remarks	5
2.2.	Product Description	5
2.3.	Equipment under Test	5
2.4.	Short description of the Equipment under Test (EUT)	5
2.5.	EUT configuration	6
2.6.	Related Submittal(s) / Grant (s)	6
2.7.	Modifications	6
2.8.	Test Environment	6
3.	<u>TEST ENVIRONMENT</u>	<u>7</u>
3.1.	Address of the test laboratory	7
3.2.	Test Facility	7
3.3.	Environmental conditions	7
3.4.	Test Description	8
3.5.	Equipments Used during the Test	8
4.	<u>TEST CONDITIONS AND RESULTS.....</u>	<u>9</u>
4.1.	Output Power	9
4.2.	Peak-to-Average Ratio (PAR)	14
4.3.	Occupied Bandwidth and Emission Bandwidth	19
4.4.	Band Edge compliance	24
4.5.	Spurious Emission on Antenna Port	29
4.6.	Radiated Spurious Emission	42
4.7.	Frequency Stability	48
5.	<u>TEST SETUP PHOTOS OF THE EUT</u>	<u>50</u>
6.	<u>EXTERNAL AND INTERNAL PHOTOS OF THE EUT</u>	<u>50</u>

1. TEST STANDARDS

The tests were performed according to following standards:

[FCC Part 27\(10-1-12 Edition\)](#): MISCELLANEOUS WIRELESS COMMUNICATIONS SERVICES
[TIA/EIA 603 D June 2010](#): Land Mobile FM or PM Communications Equipment Measurement and Performance Standards.

[47 CFR FCC Part 15 Subpart B](#): - Unintentional Radiators

[FCC Part 2](#): FREQUENCY ALLOCATIONS AND RADIO TREATY MATTERS; GENERAL RULES AND REGULATIONS

[ANSI C63.4:2014](#): Methods of Measurement of Radio-Noise Emissions from Low-Voltage Electrical and Electronic Equipment in the Range of 9 kHz to 40 GHz

[FCCKDB971168D01](#) PowerMeasLicenseDigitalSystems

2. SUMMARY

2.1. General Remarks

Date of receipt of test sample	:	April. 05, 2017
Testing commenced on	:	April. 05, 2017
Testing concluded on	:	April. 28, 2017

2.2. Product Description

The **HYUNDAI CORPORATION**'s Model:ORBIT or the "EUT" as referred to in this report; more general information as follows, for more details, refer to the user's manual of the EUT.

Name of EUT	Mobile Phone
Model/Type reference:	ORBIT
List Model:	/
Power supply:	DC 3.80V
Adapter Information	Model: Y-5204B-2A Input: AC100-240V~50/60Hz 0.3A Output:DC5V/2000mA
Modulation Type	QPSK,16QAM
Antenna Type	Internal
Antenna Gain	-1.26 dBi
Operation Frequency Band	LTE Band 7
Operation frequency	LTE Band 7: 2502.5~2567.5 MHz
LTE Release	R7
Hardware version	V1_02_C00SEA
Software version	V1.0
Extreme temp. Tolerance	-30°C to +50°C
Extreme vol. Limits	3.40VDC to 4.20VDC (nominal: 3.80VDC)

2.3. Equipment under Test

Power supply system utilised

Power supply voltage	:	<input type="radio"/> 120V/ 60 Hz	<input type="radio"/> 115V/60Hz
		<input type="radio"/> 12 V DC	<input type="radio"/> 24 V DC
		<input checked="" type="radio"/> Other (specified in blank below)	

DC 3.80V

2.4. Short description of the Equipment under Test (EUT)

This is a Mobile Phone .

For more details, refer to the user's manual of the EUT.

2.5. EUT configuration

The following peripheral devices and interface cables were connected during the measurement:

● - supplied by the manufacturer

○ - supplied by the lab

<input type="radio"/>	/	M/N :	/
		Manufacturer:	/

2.6. Related Submittal(s) / Grant (s)

This submittal(s) (test report) is intended for **FCC ID: RQQHLT-ORBITUT** filing to comply with FCC Part 27, Rules.

2.7. Modifications

No modifications were implemented to meet testing criteria.

2.8. Test Environment

EnvironmentParameter	SelectedValuesDuringTests	
Relative Humidity	Ambient	
Temperature	TN	Ambient
Voltage	VL	3.40V
	VN	3.80V
	VH	4.20V

NOTE:VL=lowerextreme testvoltageVN=nominalvoltage
 VH=upperextreme testvoltageTN=normaltemperature

3. TEST ENVIRONMENT

3.1. Address of the test laboratory

Shenzhen Global Test Service Co.,Ltd.

1F, Building No. 13A, Zhonghaixin Science and Technology City, No.12,6 Road, Ganli Industrial Park, Buji Street, Longgang District, Shenzhen, Guangdong

Shenzhen CTL Testing Technology Co., Ltd.

1/F.-A, Baisha Technology Park, No.3011, Shahexi Road, Nanshan District, Shenzhen, Guangdong, China

3.2. Test Facility

The test facility is recognized, certified, or accredited by the following organizations:

FCC-Registration No.: 964637

Shenzhen Global Test Service Co.,Ltd EMC Laboratory has been registered and fully described in a report filed with the (FCC) Federal Communications Commission. The acceptance letter from the FCC is maintained in our files. Registration 964637, Jul 24, 2015.

CNAS-Lab Code: L8169

Shenzhen Global Test Service Co.,Ltd. has been assessed and proved to be in compliance with CNAS-CL01 Accreditation Criteria for Testing and Calibration Laboratories (identical to ISO/IEC 17025: 2005 General Requirements) for the Competence of Testing and Calibration Laboratories. Date of Registration: Dec. 11, 2015. Valid time is until Dec. 10, 2018.

FCC-Registration No.: 970318

Shenzhen CTL Testing Technology Co., Ltd. EMC Laboratory has been registered and fully described in a report filed with the (FCC) Federal Communications Commission. The acceptance letter from the FCC is maintained in our files. Registration 970318, December 19, 2013.

3.3. Environmental conditions

During the measurement the environmental conditions were within the listed ranges:

Temperature:	15-35 ° C
Humidity:	30-60 %
Atmospheric pressure:	950-1050mbar

3.4. Test Description

Test Item	FCCRuleNo.	Requirements	Verdict
Effective(Isotropic)RadiatedOutput Power	§2.1046, §27.50(d)	EIRP \leq 1W;	Pass
Peak-AverageRatio	§2.1046, §27.50(d)	Limit \leq 13dB	Pass
ModulationCharacteristics	§2.1047	Digitalmodulation	N/A
Bandwidth	§2.1049	OBW: Nolimit. EBW: Nolimit.	Pass
BandEdgesCompliance	§2.1051, §27.53(h)	\leq -13dBm/1%*EBW, in1MHzbandsimmediately outsideandadjacent to Thefrequency block.	Pass
SpuriousEmissionatAntennaTerminals	§2.1051, §27.53(h)	\leq -13dBm/1MHz, from9kHzto10 th harmonicsbutoutsideauthorized operatingfrequency ranges.	Pass
Field Strengthof Spurious Radiation	§2.1055, §27.54	Withinauthorizedbands of operation/frequency block.	Pass
Frequency Stability	§2.1053, §27.53(h)	\leq -13dBm/1MHz.	Pass

NOTE 1:For the verdict,the“N/A”denotes“not applicable”,the“N/T”denotes “nottested”.

3.5. Equipments Used during the Test

Test Equipment	Manufacturer	Model No.	Serial No.	Calibration Date	Calibration Due Date
Bilog Antenna	Sunol Sciences Corp.	JB1	A061713	2016/06/02	2017/06/01
Bilog Antenna	Sunol Sciences Corp.	JB1	A061719	2016/06/02	2017/06/01
EMI Test Receiver	R&S	ESCI	101102	2016/06/26	2017/06/25
Spectrum Analyzer	Agilent	N9020A	MY48010425	2016/06/17	2017/06/16
Controller	EM Electronics	Controller EM 1000	N/A	2016/05/21	2017/05/20
Horn Antenna	Sunol Sciences Corp.	DRH-118	A062013	2016/05/19	2017/05/18
Horn Antenna	Sunol Sciences Corp.	DRH-118	A062014	2016/05/19	2017/05/18
Active Loop Antenna	SCHWARZBECK	FMZB1519	1519-037	2016/05/19	2017/05/18
Amplifier	Agilent	8349B	3008A02306	2016/05/19	2017/05/18
Amplifier	Agilent	8447D	2944A10176	2016/05/19	2017/05/18
Temperature/ Humidity Meter	Gangxing	CTH-608	02	2016/05/20	2017/05/19
High-Pass Filter	K&L	9SH10-2700/X12750-O/O	N/A	2016/05/20	2017/05/19
High-Pass Filter	K&L	41H10-1375/U12750-O/O	N/A	2016/05/20	2017/05/19
RF Cable	HUBER+SUHNER	RG214	N/A	2016/05/20	2017/05/19
Data acquisition card	Agilent	U2531A	TW53323507	2016/05/20	2017/05/19
Power Sensor	Agilent	U2021XA	MY5365004	2016/05/20	2017/05/19
Radio Communication Tester	R&S	CMW500	A130101034	2016/06/02	2017/06/01

Note: The calibration interval was one year.

4. TEST CONDITIONS AND RESULTS

4.1. Output Power

TEST APPLICABLE

During the process of testing, the EUT was controlled via R&S Digital Radio Communication tester (CMW500) to ensure max power transmission and proper modulation. This result contains output power and EIRP measurements for the EUT. In all cases, output power is within the specified limits

4.1.1. Conducted Output Power

TEST CONFIGURATION

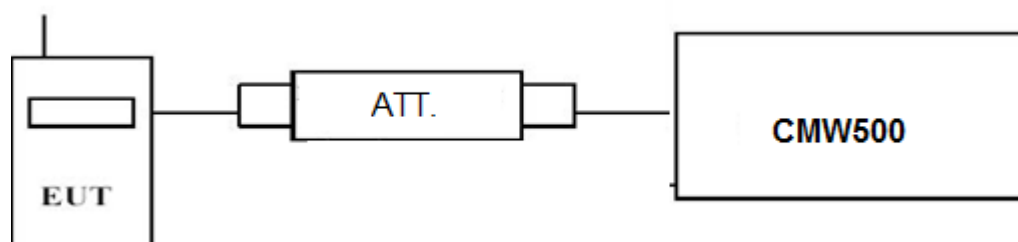

TEST PROCEDURE

Conducted Power Measurement:

- Place the EUT on a bench and set it in transmitting mode.
- Connect a low loss RF cable from the antenna port to a CMW500 by an Att.
- EUT Communicate with CMW500 then selects a channel for testing.
- Add a correction factor to the display CMW500, and then test.

TEST RESULTS

Remark:

- We were tested all RB Configuration refer 3GPP TS136 521 for each Channel Bandwidth of LTE FDD Band 7;
- The EUT supports two SIM card SIM1 and SIM2. For GSM,the SIM 1 and SIM 2 both support GSM.For WCDMA/LTE,Only SIM 1 support WCDMA/LTE.

LTE FDD Band 7				
TX Channel Bandwidth	Frequency (MHz)	RB Size/Offset	Average Power [dBm]	
			QPSK	16QAM
5 MHz	2502.5	1 RB low	22.15	21.39
		1 RB high	22.00	21.23
		50% RB mid	21.16	20.27
		100% RB	21.02	20.18
	2535.0	1 RB low	22.18	21.45
		1 RB high	22.12	21.38
		50% RB mid	21.15	20.32
		100% RB	21.12	20.19
	2567.5	1 RB low	22.03	21.12
		1 RB high	21.85	20.89
		50% RB mid	21.30	20.37
		100% RB	21.25	20.31
10 MHz	2505.0	1 RB low	21.71	21.05
		1 RB high	21.02	20.03
		50% RB mid	20.91	20.14
		100% RB	20.78	20.01
	2535.0	1 RB low	21.84	21.30
		1 RB high	20.78	20.04

	2565.0	50% RB mid	20.83	19.69
		100% RB	20.89	20.17
		1 RB low	21.34	20.62
		1 RB high	21.07	20.57
		50% RB mid	21.09	20.04
		100% RB	21.06	20.10
15 MHz	2507.5	1 RB low	21.71	21.08
		1 RB high	21.27	20.31
		50% RB mid	20.76	19.79
		100% RB	20.68	19.60
	2535.0	1 RB low	21.85	21.23
		1 RB high	21.33	20.70
		50% RB mid	20.62	19.65
		100% RB	20.87	19.86
	2562.5	1 RB low	20.85	19.87
		1 RB high	21.19	20.50
		50% RB mid	21.12	20.08
		100% RB	20.81	19.78
20 MHz	2510.0	1 RB low	20.62	19.77
		1 RB high	20.60	19.72
		50% RB mid	20.46	19.60
		100% RB	20.49	19.65
	2535.0	1 RB low	22.00	21.57
		1 RB high	21.48	19.62
		50% RB mid	20.50	19.65
		100% RB	20.65	19.75
	2560.0	1 RB low	20.69	19.92
		1 RB high	21.04	20.62
		50% RB mid	21.15	19.95
		100% RB	20.59	19.82

4.1.2. Radiated Output Power

LIMIT

According to §27.50 (d) (4): Fixed, mobile, and portable (hand-held) stations operating in the 1710–1755 MHz band are limited to 1 watt EIRP.

TEST CONFIGURATION

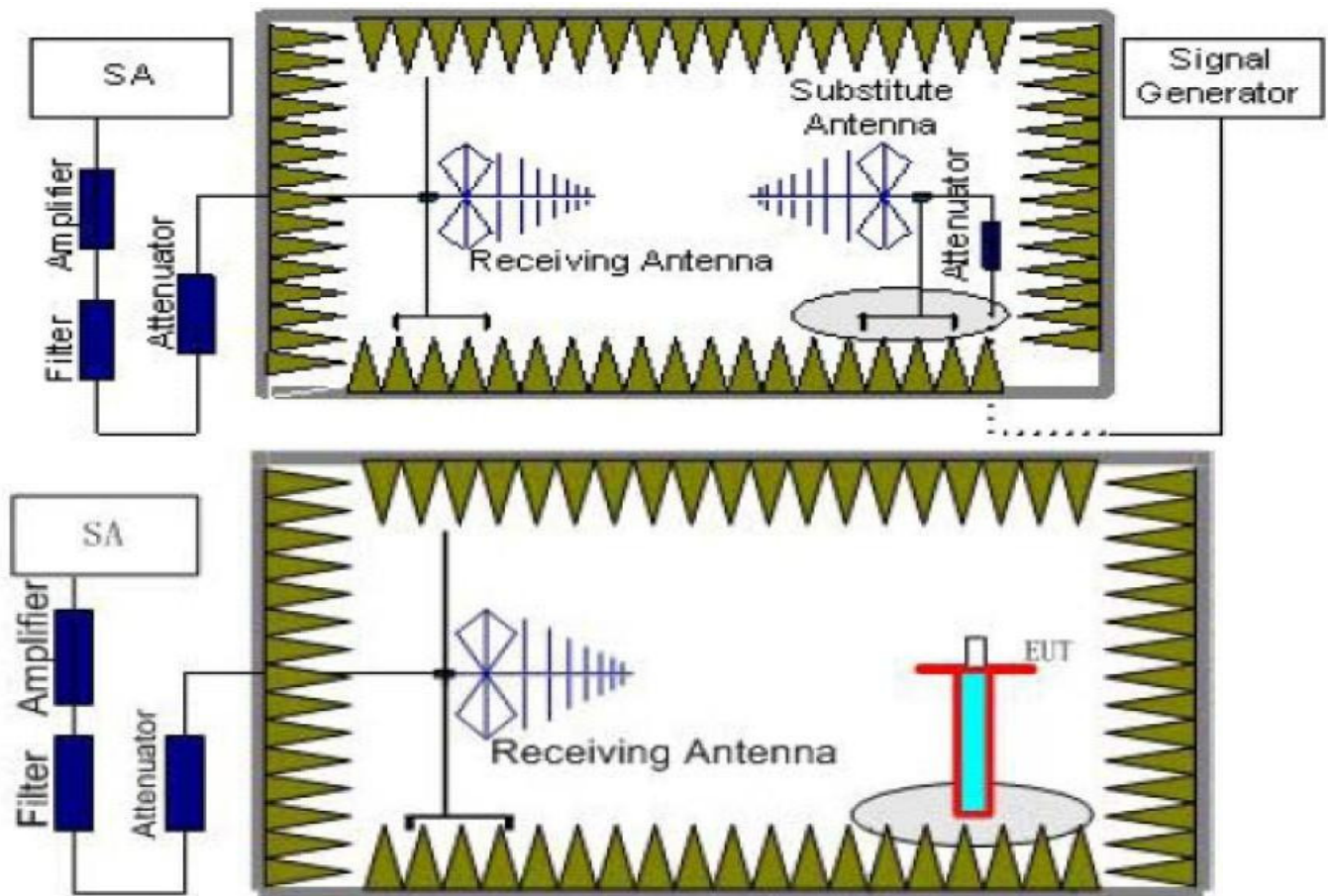

TEST PROCEDURE

1. EUT was placed on a 1.50 meter high non-conductive stand at a 3 meter test distance from the receive antenna. A receiving antenna was placed on the antenna mast 3 meters from the EUT for emission measurements. The height of receiving antenna is 1.50m. Detected emissions were maximized at each frequency by rotating the EUT through 360° and adjusting the receiving antenna polarization. The radiated emission measurements of all transmit frequencies in three channels (High, Middle, Low) were measured with peak detector.
2. A log-periodic antenna or double-ridged waveguide horn antenna shall be substituted in place of the EUT. The log-periodic antenna will be driven by a signal generator and the level will be adjusted till the same power value on the spectrum analyzer or receiver. The level of the spurious emissions can be calculated through the level of the signal generator, cable loss, the gain of the substitution antenna and the reading of the spectrum analyzer or receiver.
3. The EUT is then put into continuously transmitting mode at its maximum power level during the test. Set Test Receiver or Spectrum RBW=1MHz, VBW=3MHz, And the maximum value of the receiver should be recorded as (P_r).
4. The EUT shall be replaced by a substitution antenna. In the chamber, an substitution antenna for the frequency band of interest is placed at the reference point of the chamber. An RF Signal source for the frequency band of interest is connected to the substitution antenna with a cable that has been constructed to not interfere with the radiation pattern of the antenna. A power (P_{Mea}) is applied to the input of the substitution antenna, and adjust the level of the signal generator output until the value of the receiver reach the previously recorded (P_r). The power of signal source (P_{Mea}) is recorded. The test should be performed by rotating the test item and adjusting the receiving antenna polarization.

- A amplifier should be connected to the Signal Source output port. And the cable should be connect between the Amplifier and the Substitution Antenna. The cable loss (P_{cl}), the Substitution Antenna Gain (G_a) and the Amplifier Gain (P_{Ag}) should be recorded after test.

The measurement results are obtained as described below:

$$\text{Power(EIRP)} = P_{\text{Mea}} - P_{\text{Ag}} - P_{\text{cl}} + G_a$$

We used SMF100A microwave signal generator which signal level can up to 33dBm,so we not used power Amplifier for substitution test; The measurement results are amend as described below:

$$\text{Power(EIRP)} = P_{\text{Mea}} - P_{\text{cl}} + G_a$$

- This value is EIRP since the measurement is calibrated using an antenna of known gain (2.15 dBi) and known input power.
- ERP can be calculated from EIRP by subtracting the gain of the dipole, $\text{ERP} = \text{EIRP} - 2.15\text{dBi}$.

TEST RESULTS

Remark:

- We measured all RB Configuration refer 3GPP TS136 521 for each Channel Bandwidth of LTE FDD Band 7; recorded worst case for each Channel Bandwidth of LTE FDD Band 7.
- $\text{EIRP} = P_{\text{Mea}}(\text{dBm}) - P_{\text{cl}}(\text{dB}) + P_{\text{Ag}}(\text{dB}) + G_a(\text{dBi})$
- The EUT supports two SIM card SIM1 and SIM2. For GSM, the SIM 1 and SIM 2 both support GSM. For WCDMA/LTE, Only SIM 1 support WCDMA/LTE.
- We measured both Horizontal and Vertical direction, recorded worst case direction.
- Test site: Shenzhen CTL Testing Technology Co., Ltd

LTE FDD Band 7_Channel Bandwidth 5MHz_QPSK

Frequency (MHz)	P_{Mea} (dBm)	P_{cl} (dB)	G_a Antenna Gain(dB)	P_{Ag} (dB)	Burst Average EIRP (dBm)	Limit (dBm)	Margin (dB)	Polarization
2502.5	-21.63	3.06	9.68	34.8	19.79	30	10.21	V
2535	-21.15	3.17	9.68	34.8	20.16	30	9.84	V
2567.5	-22.38	3.22	9.75	34.8	18.95	30	11.05	V

LTE FDD Band 7_Channel Bandwidth 10MHz_QPSK

Frequency (MHz)	P_{Mea} (dBm)	P_{cl} (dB)	G_a Antenna Gain(dB)	P_{Ag} (dB)	Burst Average EIRP (dBm)	Limit (dBm)	Margin (dB)	Polarization
2505	-22.43	3.06	9.68	34.8	18.99	30	11.01	V
2535	-21.04	3.17	9.68	34.8	20.27	30	9.73	V
2565	-22.55	3.22	9.75	34.8	18.78	30	11.22	V

LTE FDD Band 7_Channel Bandwidth 15MHz_QPSK

Frequency (MHz)	P_{Mea} (dBm)	P_{cl} (dB)	G_a Antenna Gain(dB)	P_{Ag} (dB)	Burst Average EIRP (dBm)	Limit (dBm)	Margin (dB)	Polarization
2507.5	-21.95	3.06	9.68	34.8	19.47	30	10.53	V
2535	-20.90	3.17	9.68	34.8	20.41	30	9.59	V
2562.5	-21.53	3.22	9.75	34.8	19.80	30	10.20	V

LTE FDD Band 7_Channel Bandwidth 20MHz_QPSK

Frequency (MHz)	P_{Mea} (dBm)	P_{cl} (dB)	G_a Antenna Gain(dB)	P_{Ag} (dB)	Burst Average EIRP (dBm)	Limit (dBm)	Margin (dB)	Polarization
2510	-21.94	3.06	9.68	34.8	19.48	30	10.52	V
2535	-21.29	3.17	9.68	34.8	20.02	30	9.98	V
2560	-22.27	3.22	9.75	34.8	19.06	30	10.94	V

LTE FDD Band 7_Channel Bandwidth 5MHz_16QAM

Frequency (MHz)	P _{Mea} (dBm)	P _{cl} (dB)	G _a Antenna Gain(dB)	P _{Aq} (dB)	Burst Average EIRP (dBm)	Limit (dBm)	Margin (dB)	Polarization
2502.5	-22.21	3.06	9.68	34.8	19.21	30	10.79	V
2535	-21.62	3.17	9.68	34.8	19.69	30	10.31	V
2567.5	-22.64	3.22	9.75	34.8	18.69	30	11.31	V

LTE FDD Band 7_Channel Bandwidth 10MHz_16QAM

Frequency (MHz)	P _{Mea} (dBm)	P _{cl} (dB)	G _a Antenna Gain(dB)	P _{Aq} (dB)	Burst Average EIRP (dBm)	Limit (dBm)	Margin (dB)	Polarization
2505	-22.54	3.06	9.68	34.8	18.88	30	11.12	V
2535	-22.11	3.17	9.68	34.8	19.20	30	10.80	V
2565	-22.35	3.22	9.75	34.8	18.98	30	11.02	V

LTE FDD Band 7_Channel Bandwidth 15MHz_16QAM

Frequency (MHz)	P _{Mea} (dBm)	P _{cl} (dB)	G _a Antenna Gain(dB)	P _{Aq} (dB)	Burst Average EIRP (dBm)	Limit (dBm)	Margin (dB)	Polarization
2507.5	-22.54	3.06	9.68	34.8	18.88	30	11.12	V
2535	-22.16	3.17	9.68	34.8	19.15	30	10.85	V
2562.5	-22.35	3.06	9.68	34.8	19.07	30	10.93	V

LTE FDD Band 7_Channel Bandwidth 20MHz_16QAM

Frequency (MHz)	P _{Mea} (dBm)	P _{cl} (dB)	G _a Antenna Gain(dB)	P _{Aq} (dB)	Burst Average EIRP (dBm)	Limit (dBm)	Margin (dB)	Polarization
2510	-22.19	3.06	9.68	34.8	19.23	30	10.77	V
2535	-21.43	3.17	9.68	34.8	19.88	30	10.12	V
2560	-22.06	3.22	9.75	34.8	19.27	30	10.73	V

4.2. Peak-to-Average Ratio (PAR)

LIMIT

The Peak-to-Average Ratio (PAR) of the transmission may not exceed 13 dB.

TEST CONFIGURATION

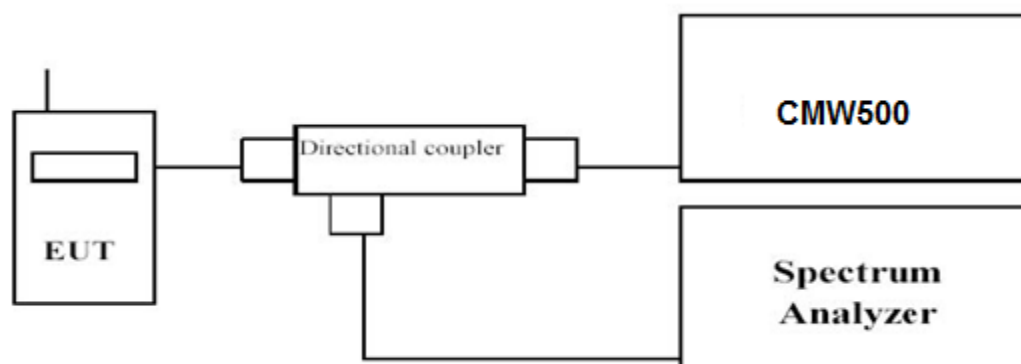

TEST PROCEDURE

1. Refer to instrument's analyzer instruction manual for details on how to use the power statistics/CCDF function;
2. Set resolution/measurement bandwidth \geq signal's occupied bandwidth;
3. Set the number of counts to a value that stabilizes the measured CCDF curve;
4. Set the measurement interval as follows:
 - 1). for continuous transmissions, set to 1 ms,
 - 2). for burst transmissions, employ an external trigger that is synchronized with the EUT burst timing sequence, or use the internal burst trigger with a trigger level that allows the burst to stabilize and set the measurement interval to a time that is less than or equal to the burst duration.
5. Record the maximum PAPR level associated with a probability of 0.1%.

TEST RESULTS

Remark: The EUT supports two SIM card SIM1 and SIM2. For GSM, the SIM 1 and SIM 2 both support GSM. For WCDMA/LTE, Only SIM 1 support WCDMA/LTE. We were tested all RB Configuration refer 3GPP TS136 521 for each Channel Bandwidth of LTE FDD Band 7; recorded worst case for each Channel Bandwidth of LTE FDD Band 7.

LTE FDD Band 7				
TX Channel Bandwidth	Frequency (MHz)	RB Size/Offset	PAPR(dB)	
			QPSK	16QAM
5 MHz	2502.5	1RB#0	2.74	2.65
	2535.0		2.76	2.70
	2567.5		2.19	2.71
10 MHz	2505.0	1RB#0	5.08	6.08
	2535.0		3.80	6.39
	2565.0		5.39	6.45
15 MHz	2507.5	1RB#0	5.59	5.75
	2535.0		5.25	5.69
	2562.5		5.14	5.72
20 MHz	2510.0	1RB#0	7.41	6.16
	2535.0		6.62	6.06
	2560.0		6.45	6.15

LTE FDD Band 7-5MHz Channel Bandwidth PAPR

QPSK

16QAM

Low Channel

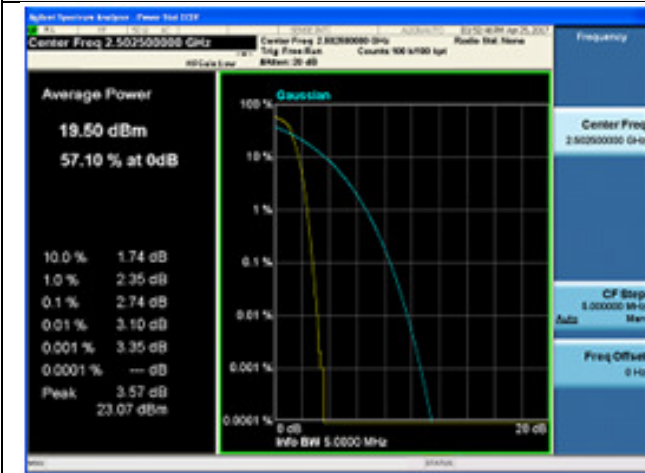

1RB#0

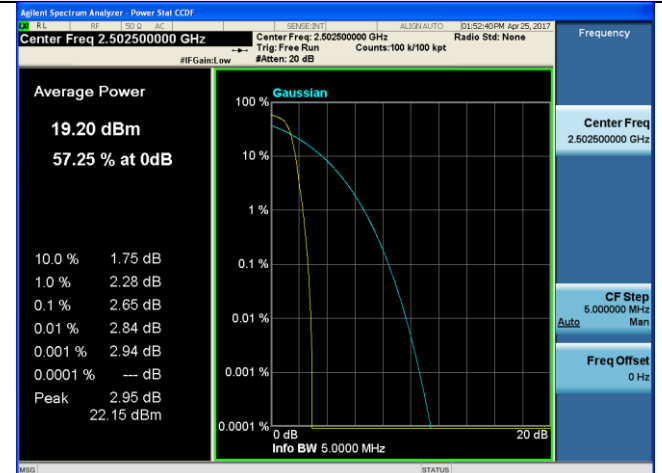

1RB#0

Middle Channel

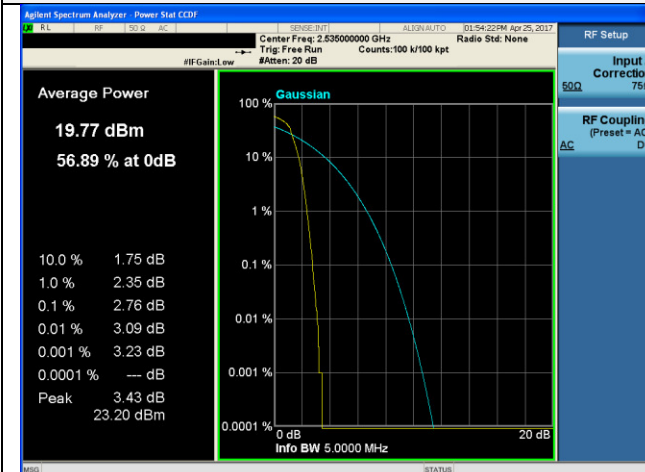

1RB#0

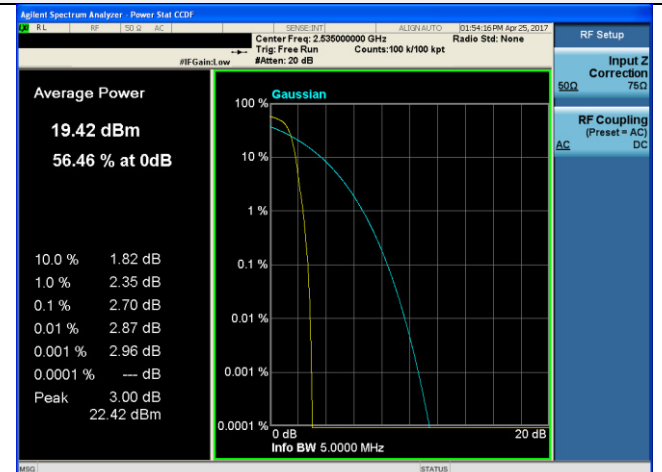

1RB#0

High Channel

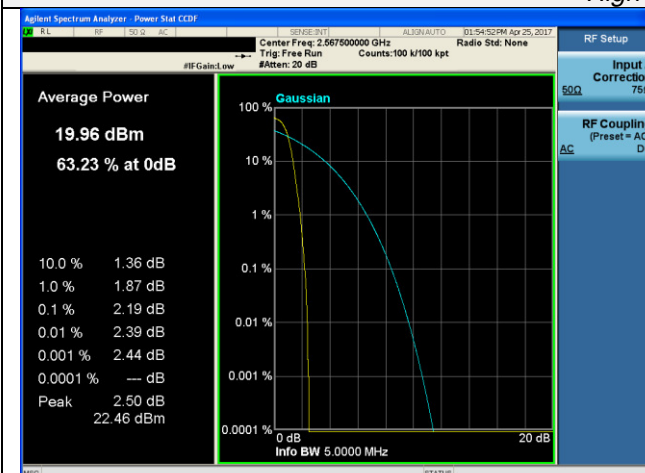

1RB#0

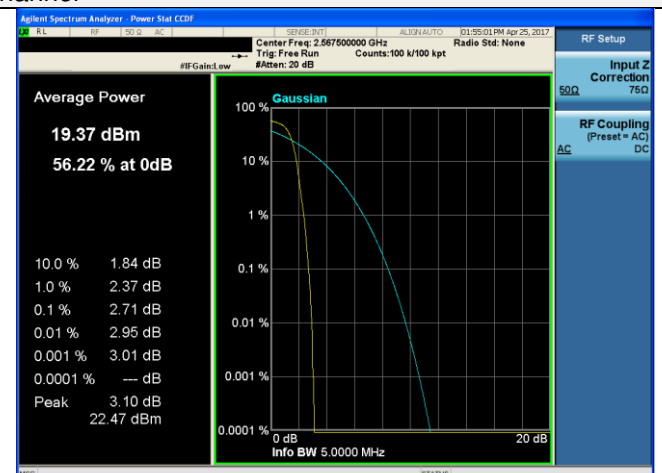

1RB#0

LTE FDD Band 7- 10 MHz Channel Bandwidth PAPR

QPSK

16QAM

Low Channel

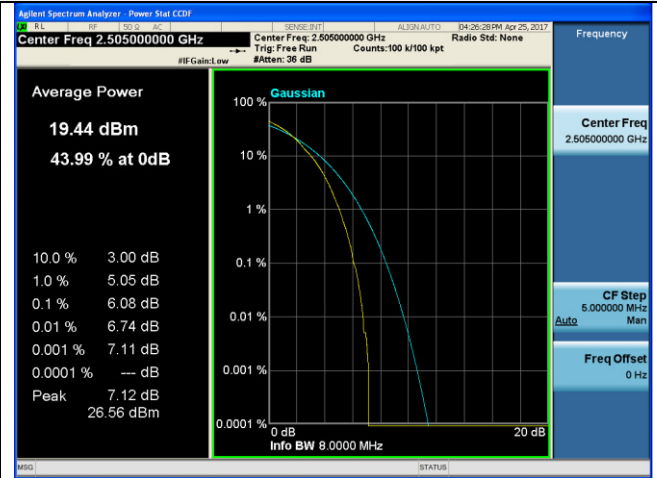
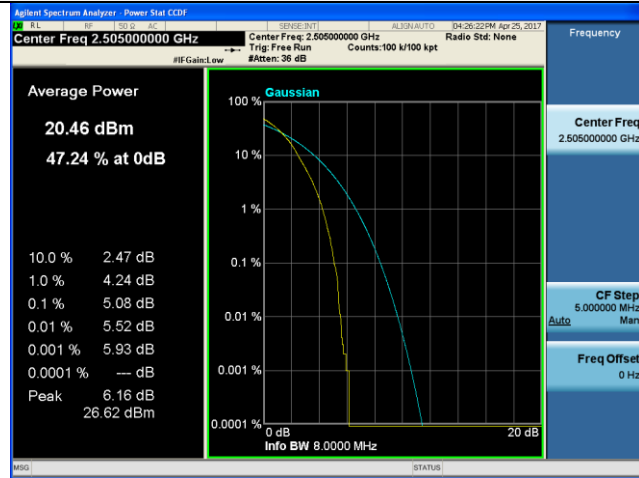

1RB#0

1RB#0

Middle Channel

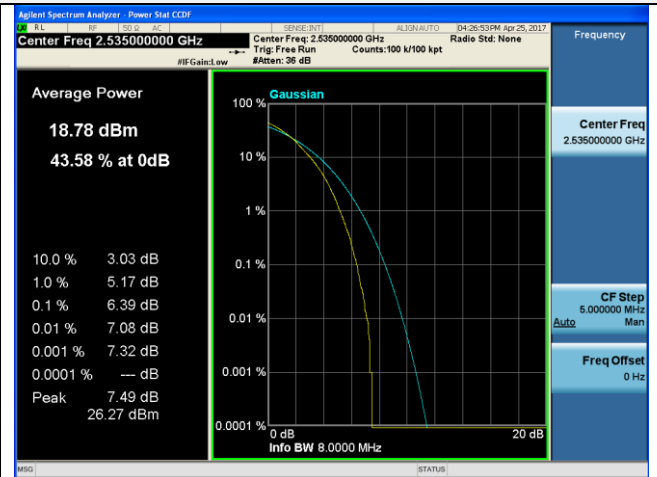
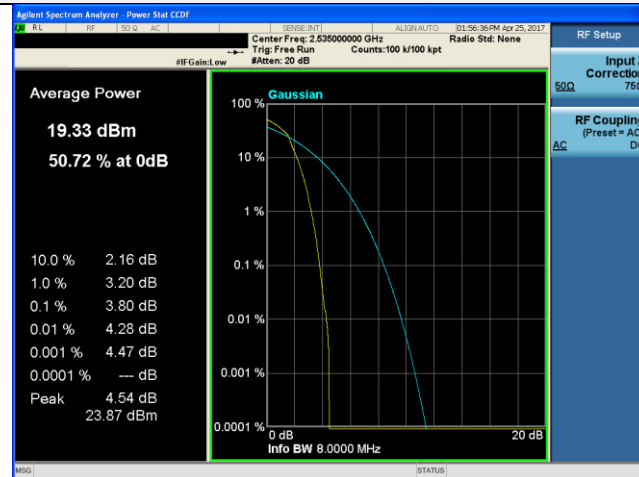

1RB#0

1RB#0

High Channel

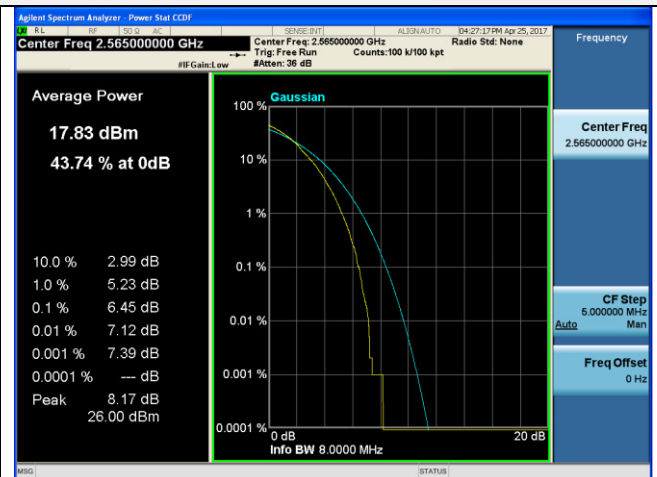
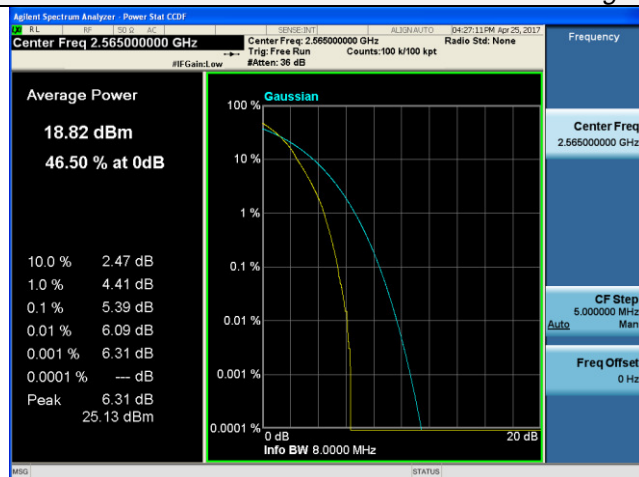

1RB#0

1RB#0

LTE FDD Band 7- 15 MHz Channel Bandwidth PAPR

QPSK

16QAM

Low Channel

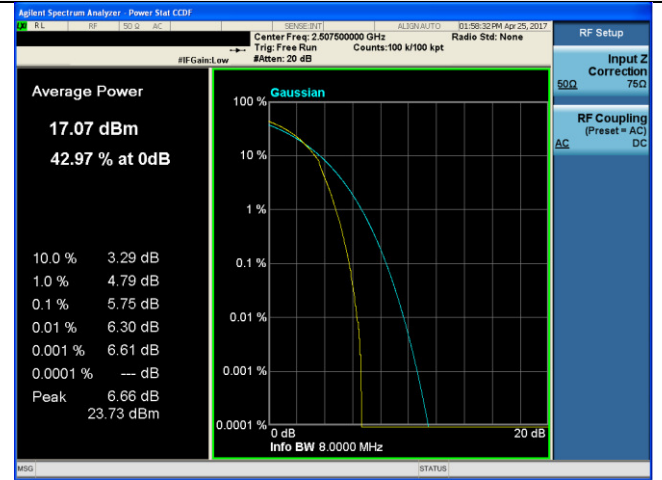
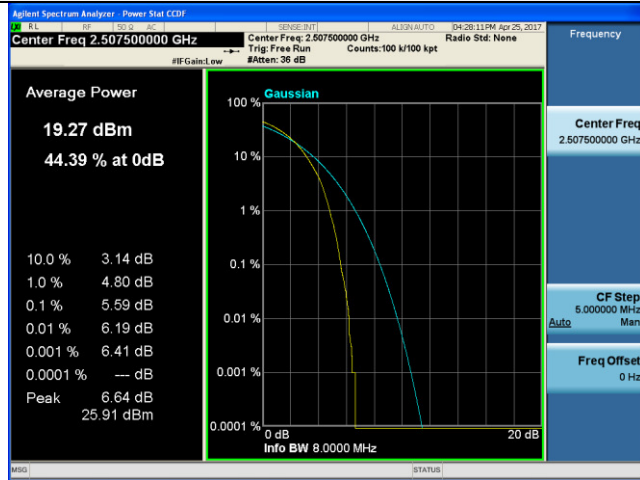

1RB#0

1RB#0

Middle Channel

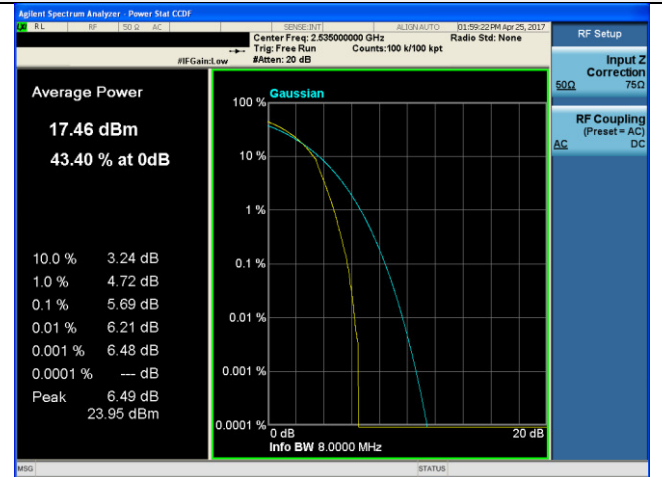
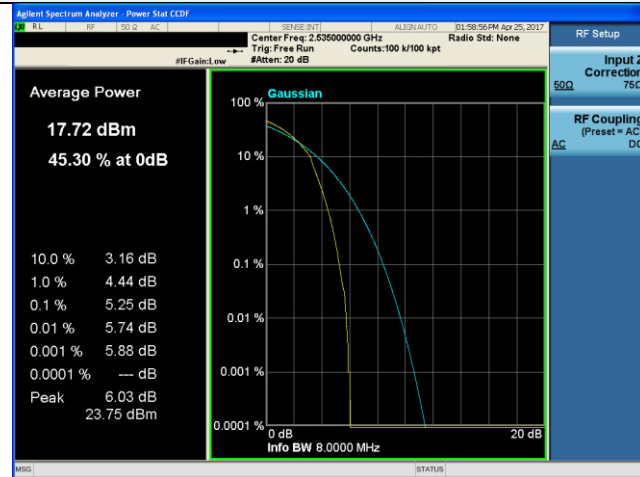

1RB#0

1RB#0

High Channel

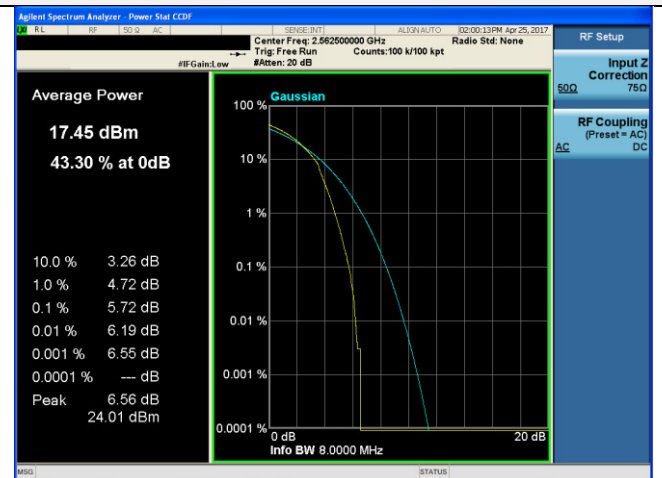
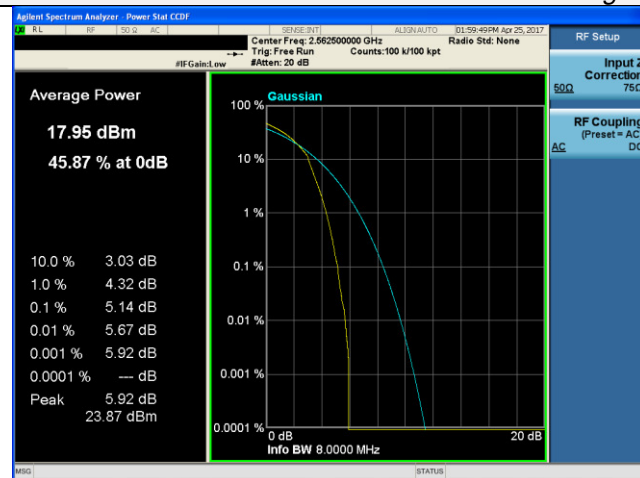

1RB#0

1RB#0

LTE FDD Band 7– 20 MHz Channel Bandwidth PAPR

QPSK

16QAM

Low Channel

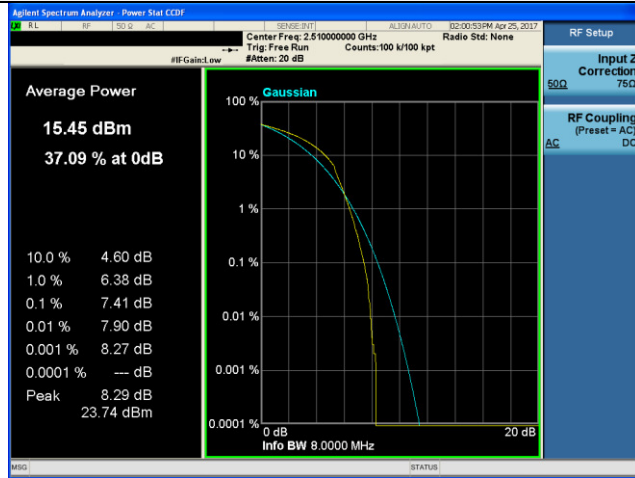

1RB#0

1RB#0

Middle Channel

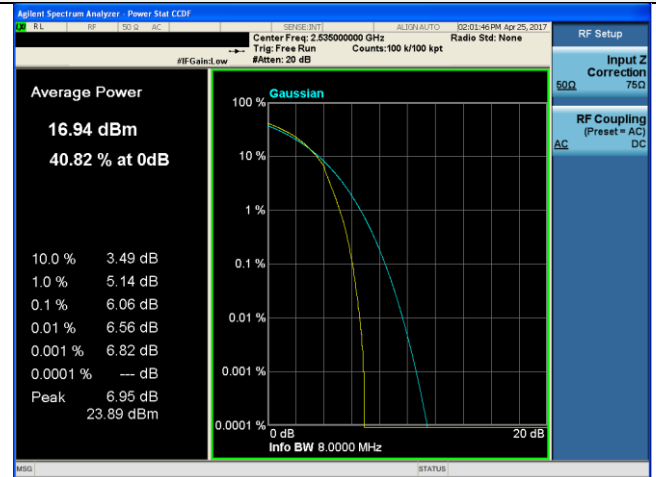
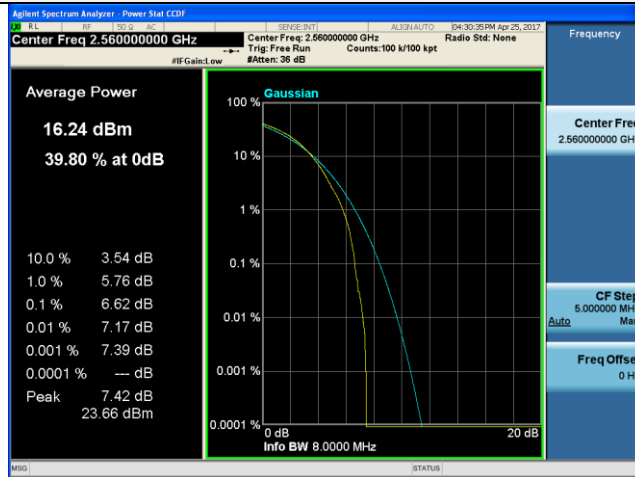

1RB#0

1RB#0

High Channel

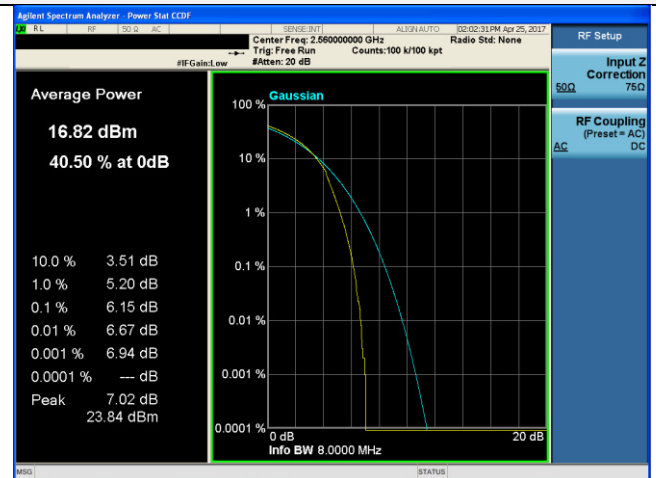
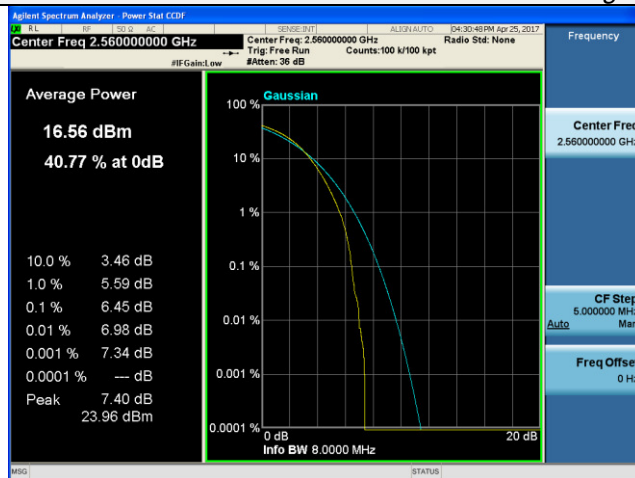

1RB#0

1RB#0

4.3. Occupied Bandwidth and Emission Bandwidth

LIMIT

N/A

TEST CONFIGURATION

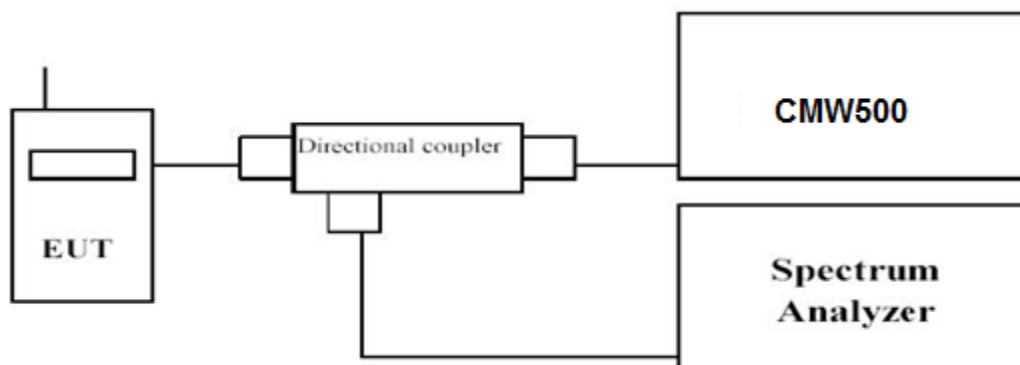

TEST PROCEDURE

The transmitter output was connected to a calibrated coaxial cable and coupler, the other end of which was connected to a spectrum analyzer. The occupied bandwidth was measured with the spectrum analyzer at low, middle and high channel in each band. The -26dBc Emission bandwidth was also measured and recorded. Set RBW was set to about 1% of emission BW, VBW ≥ 3 times RBW. -26dBc display line was placed on the screen (or 99% bandwidth), the occupied bandwidth is the delta frequency between the two points where the display line intersects the signal trace.

TEST RESULTS

Remark: The EUT supports two SIM card SIM1 and SIM2. For GSM, the SIM 1 and SIM 2 both support GSM. For WCDMA/LTE, Only SIM 1 support WCDMA/LTE. We were tested all RB Configuration refer 3GPP TS136 521 for each Channel Bandwidth of LTE FDD Band 7; recorded worst case for each Channel Bandwidth of LTE FDD Band 7.

LTE FDD Band 7						
TX Channel Bandwidth	RB Size/Offset	Frequency (MHz)	-26dBc Emission bandwidth (MHz)		99% Occupied bandwidth (MHz)	
			QPSK	16QAM	QPSK	16QAM
5 MHz	25RB#0	2502.5	4.814	4.847	4.4896	4.4967
		2535.0	4.782	4.829	4.4888	4.5029
		2567.5	4.822	4.829	4.4870	4.4960
10 MHz	50RB#0	2505.0	9.677	9.701	9.0293	9.0342
		2535.0	9.687	9.699	9.0219	9.0445
		2565.0	9.684	9.712	9.0342	9.0390
15 MHz	75RB#0	2507.5	14.22	14.20	13.458	13.447
		2535.0	14.21	14.20	13.472	13.457
		2562.5	14.21	14.21	13.477	13.469
20 MHz	100RB#0	2510.0	19.00	19.00	17.925	17.928
		2535.0	19.02	19.00	17.953	17.946
		2560.0	18.97	18.98	17.968	17.973

LTE FDD Band 7 – 5 MHz Channel Bandwidth Occupied Bandwidth and Emission Bandwidth

QPSK

16QAM

Low Channel

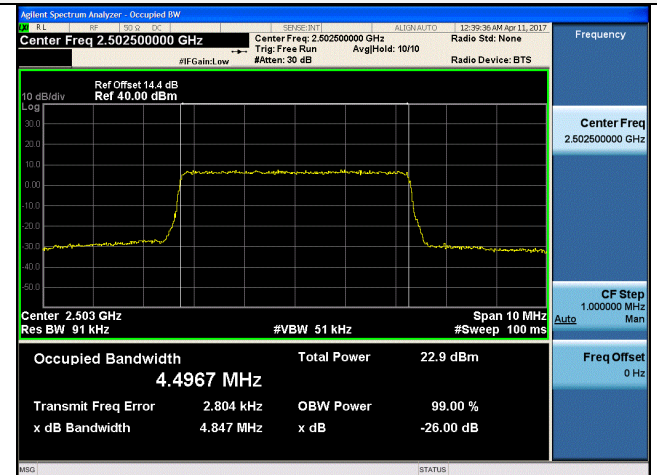
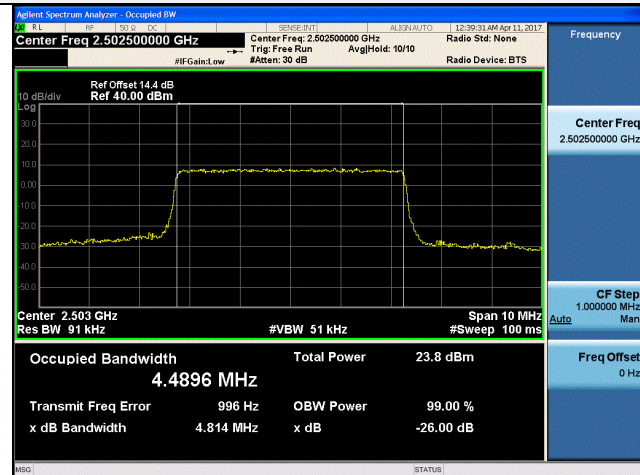

25RB#0

25RB#0

Middle Channel

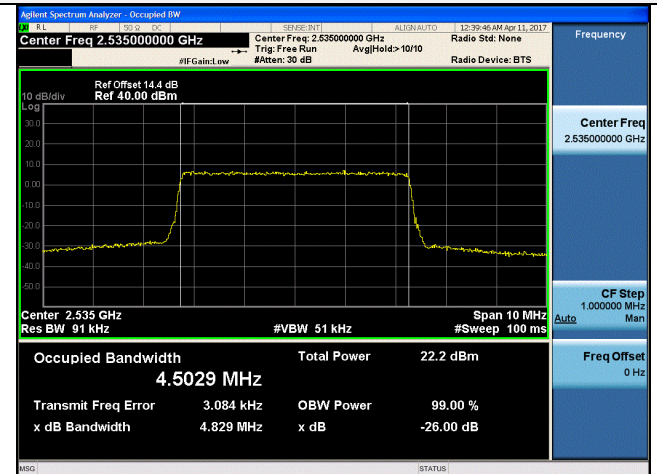
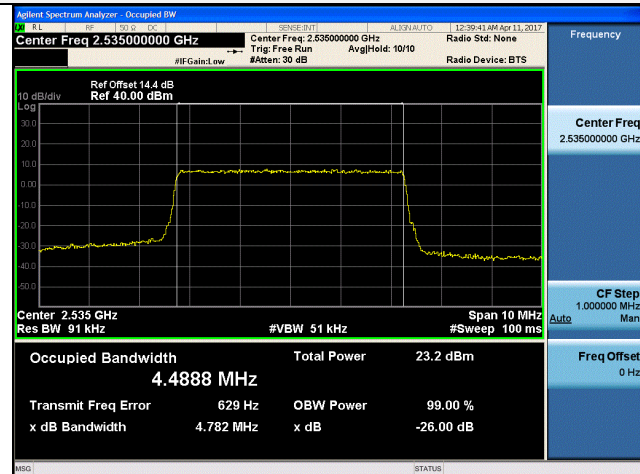

25RB#0

25RB#0

High Channel

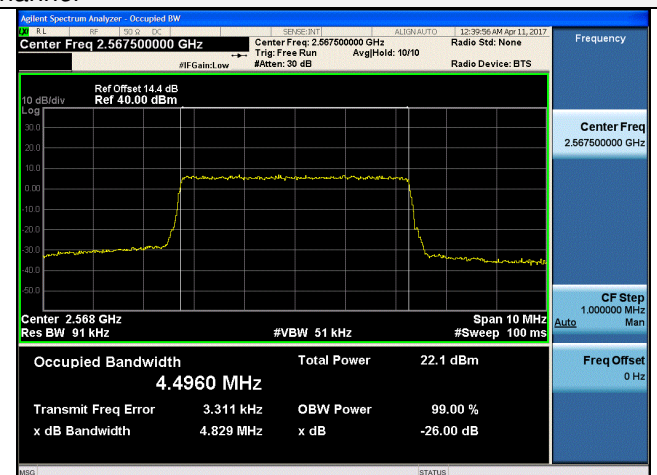
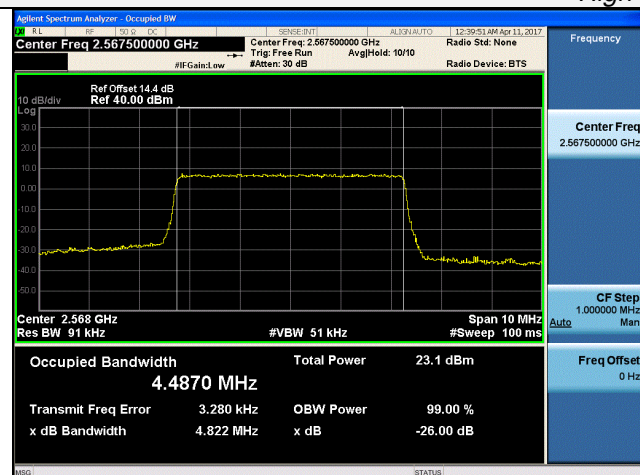

25RB#0

25RB#0

LTE FDD Band 7 – 10 MHz Channel Bandwidth Occupied Bandwidth and Emission Bandwidth

QPSK

16QAM

Low Channel

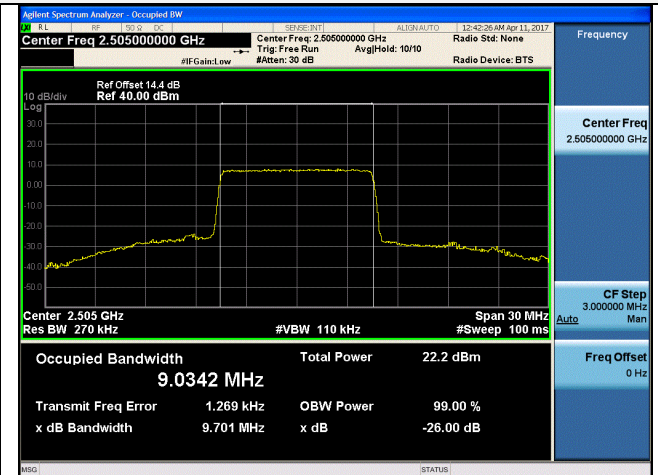
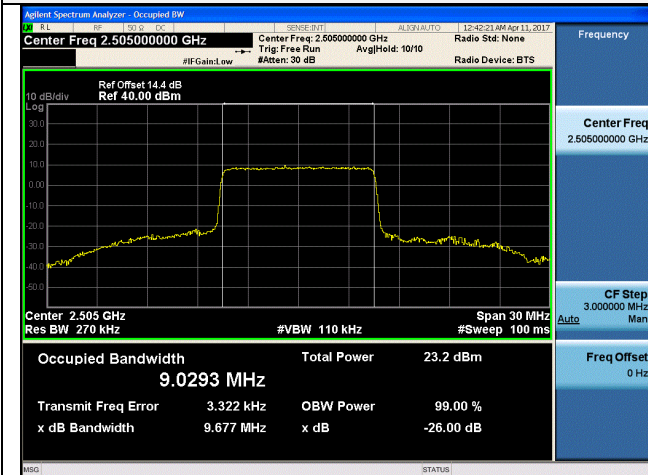

50RB#0

50RB#0

Middle Channel

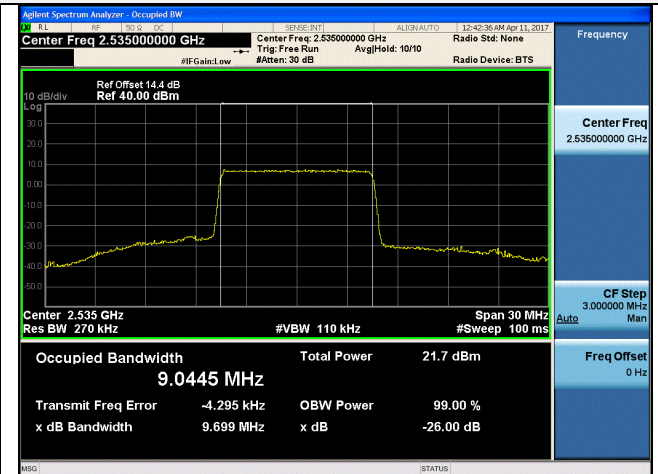
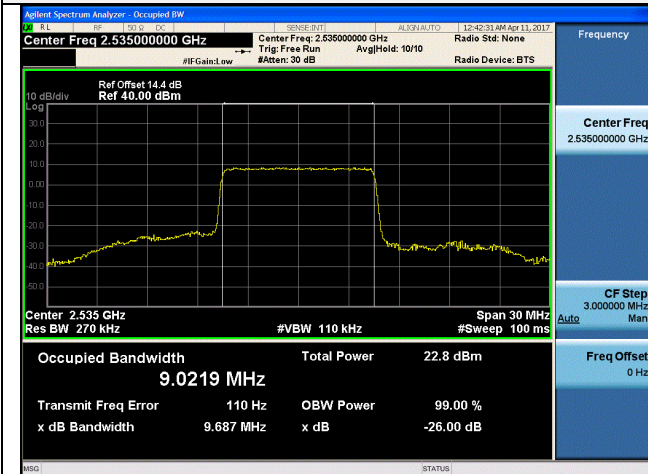

50RB#0

50RB#0

High Channel

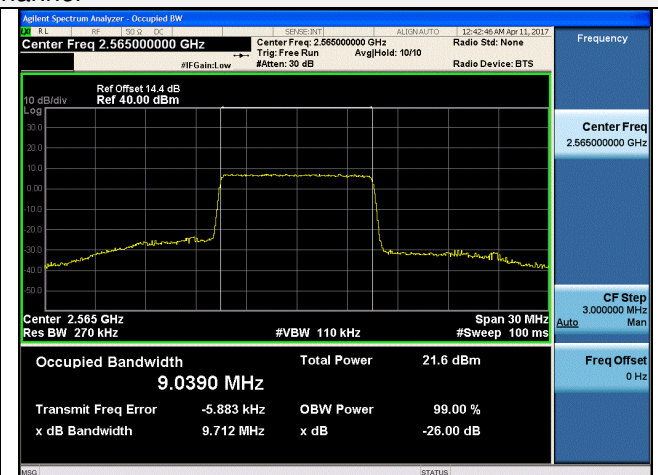
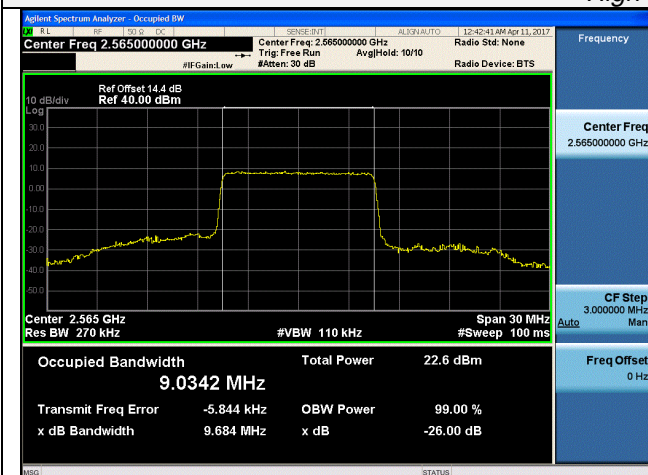

50RB#0

50RB#0

LTE FDD Band 7 – 15 MHz Channel Bandwidth Occupied Bandwidth and Emission Bandwidth

QPSK

16QAM

Low Channel

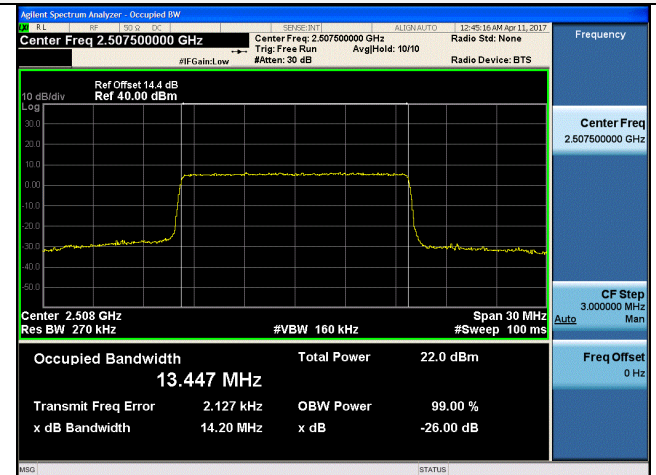
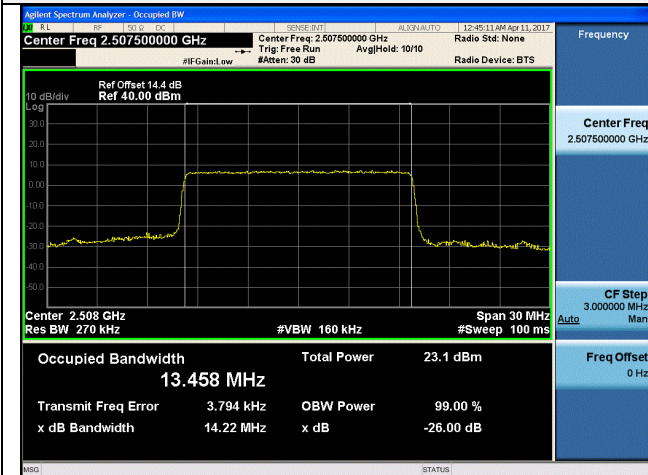

75RB#0

75RB#0

Middle Channel

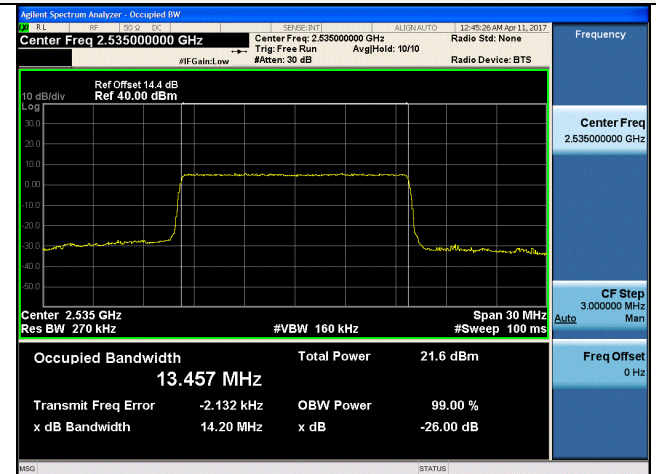
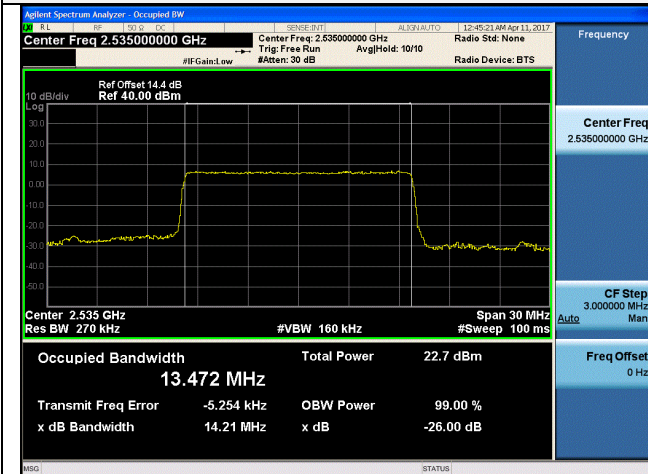

75RB#0

75RB#0

High Channel

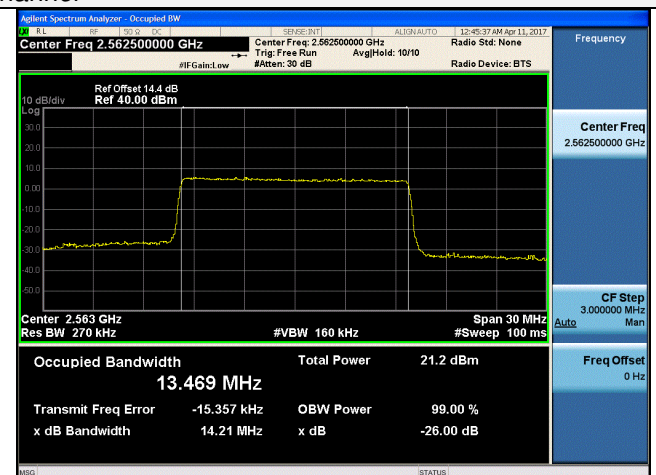
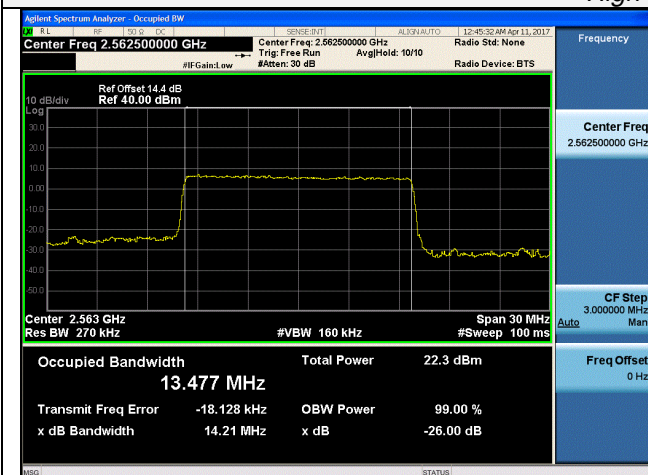

75RB#0

75RB#0

LTE FDD Band 7 – 20 MHz Channel Bandwidth Occupied Bandwidth and Emission Bandwidth

QPSK

16QAM

Low Channel

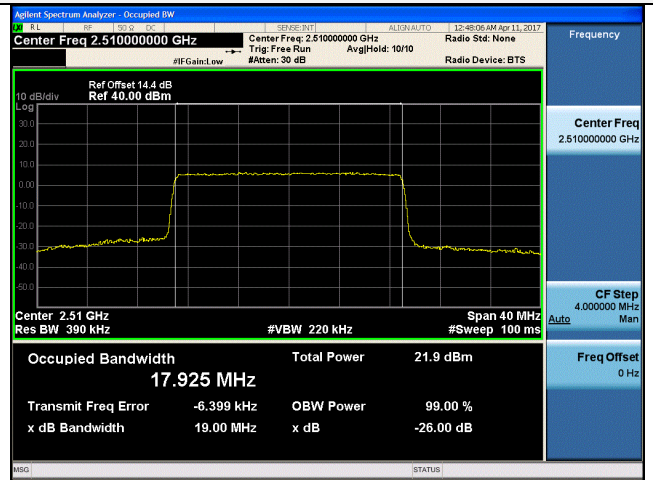
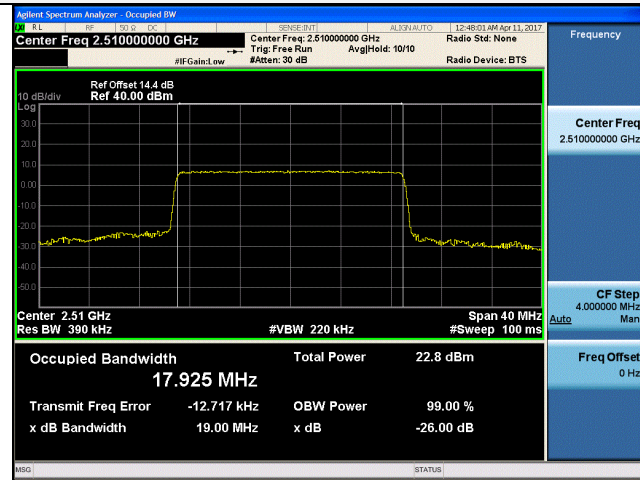

100RB#0

100RB#0

Middle Channel

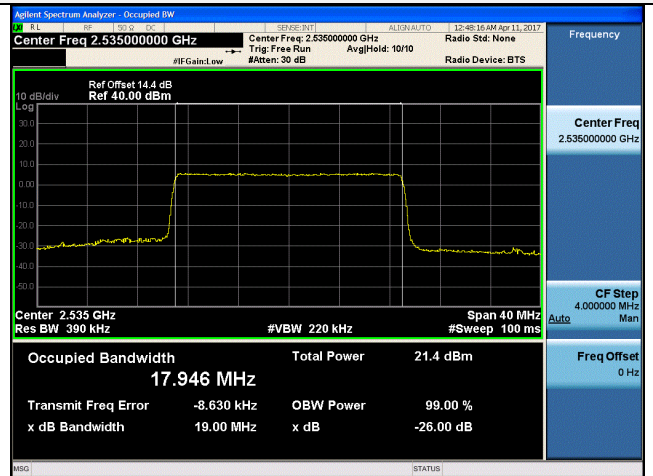
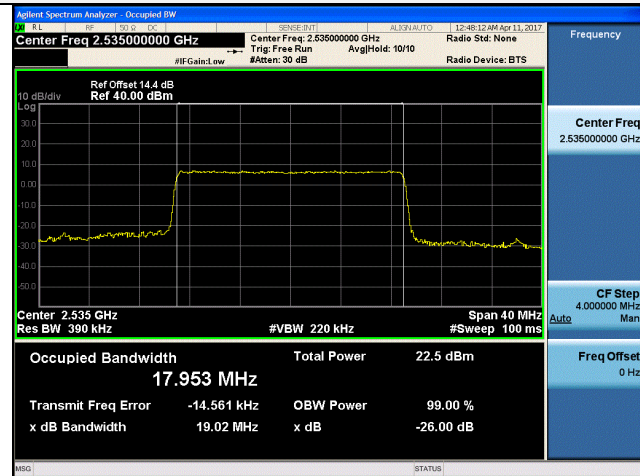

100RB#0

100RB#0

High Channel

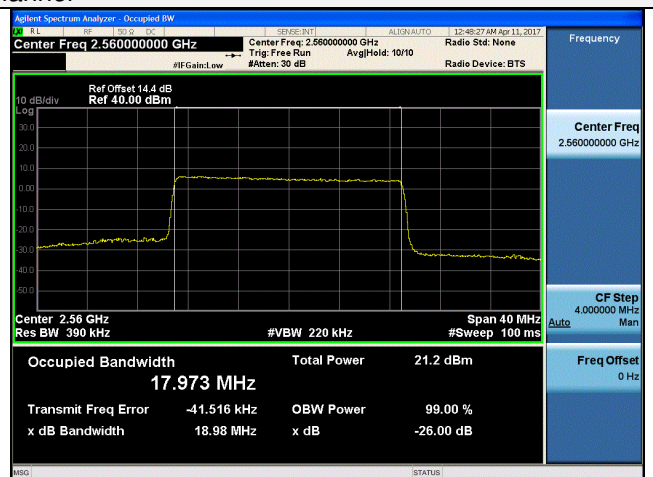
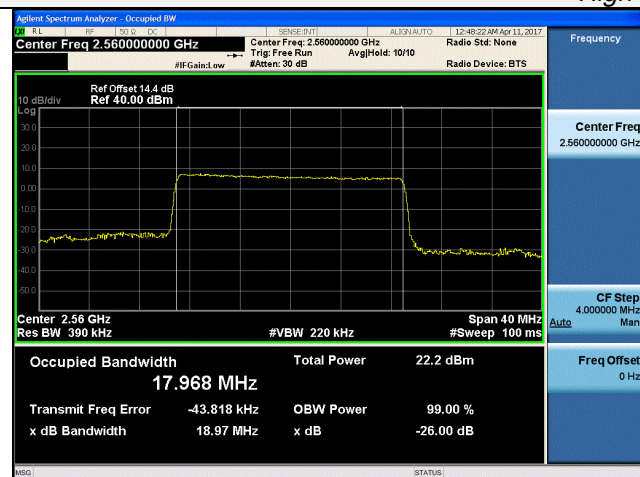

100RB#0

100RB#0

4.4. Band Edge compliance

LIMIT

According to §27.53(h): For operations in the 1710–1755 MHz and 2110–2155 MHz bands, the power of any emission outside a licensee's frequency block shall be attenuated below the transmitter power (P) by at least $43 + 10 \log_{10}(P)$ dB.

TEST CONFIGURATION

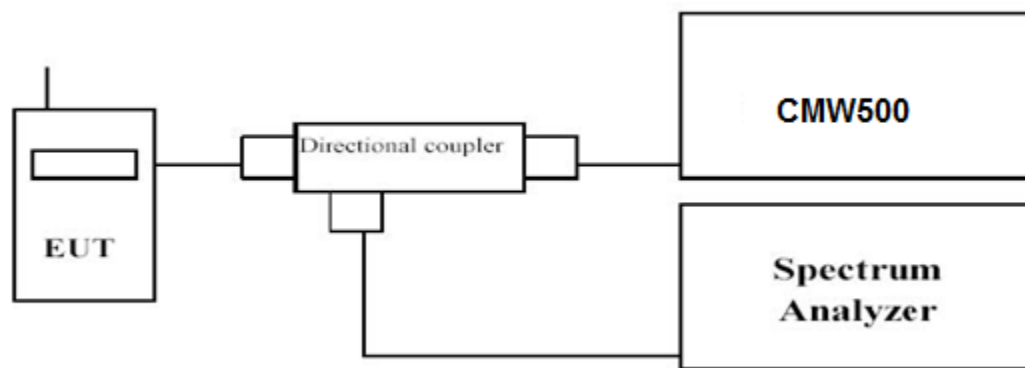

TEST PROCEDURE

1. The transmitter output port was connected to base station.
2. The RF output of EUT was connected to the power meter by RF cable and attenuator, the path loss was compensated to the results for each measurement.
3. Set EUT at maximum power through base station.
4. Select lowest and highest channels for each band and different modulation.
5. Measure Band edge using RMS (Average) detector by spectrum

TEST RESULTS

Remark: The EUT supports two SIM card SIM1 and SIM2. For GSM, the SIM 1 and SIM 2 both support GSM. For WCDMA/LTE, Only SIM 1 support WCDMA/LTE. We were tested all RB Configuration refer 3GPP TS136 521 for each Channel Bandwidth of LTE FDD Band 7; recorded worst case for each Channel Bandwidth of LTE FDD Band 7.

LTE FDD Band 7 – 5 MHz Channel Bandwidth Band Edge Compliance

QPSK

16QAM

Low Channel

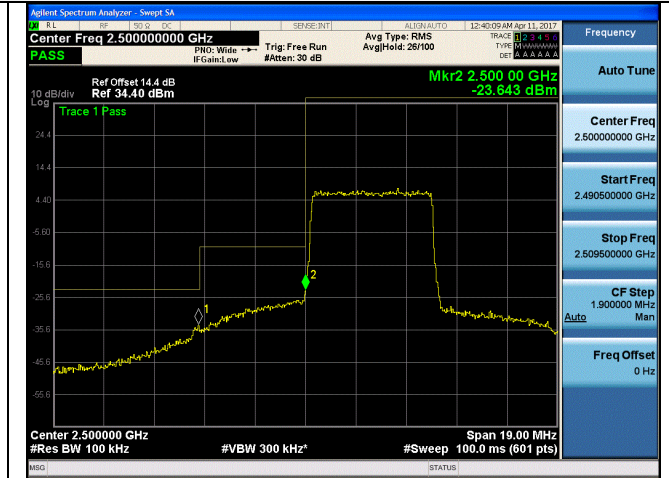
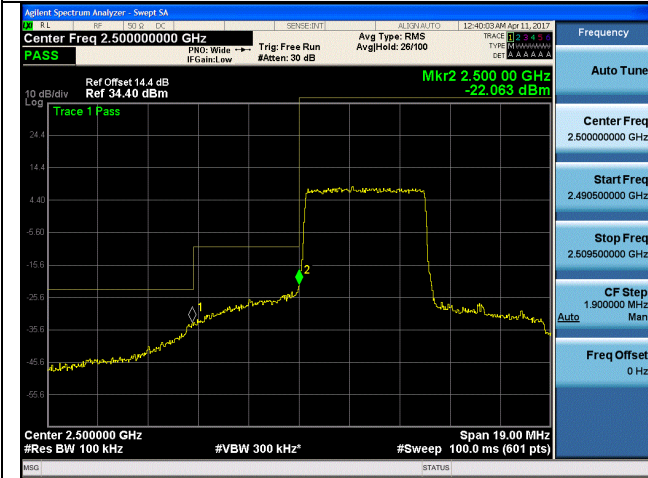

25RB#0

25RB#0

High Channel

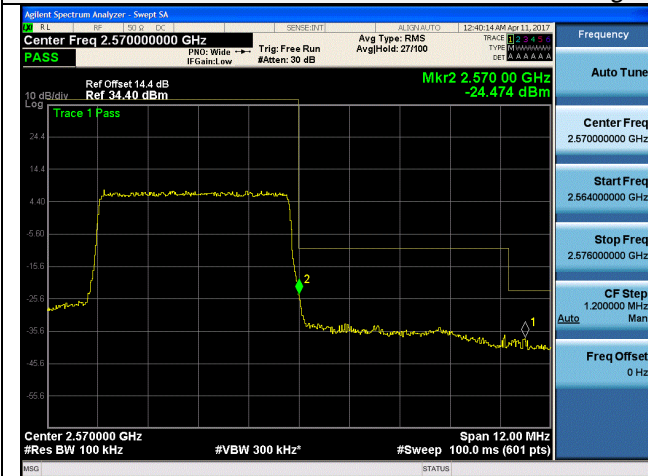

25RB#0

25RB#0

LTE FDD Band 7 – 10 MHz Channel Bandwidth Band Edge Compliance

QPSK

16QAM

Low Channel

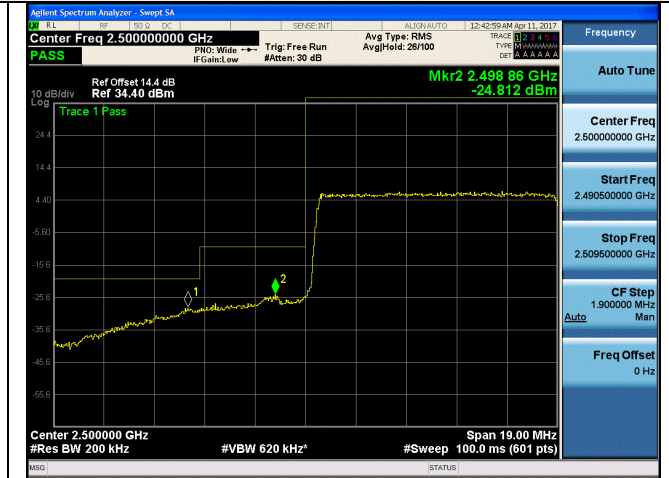
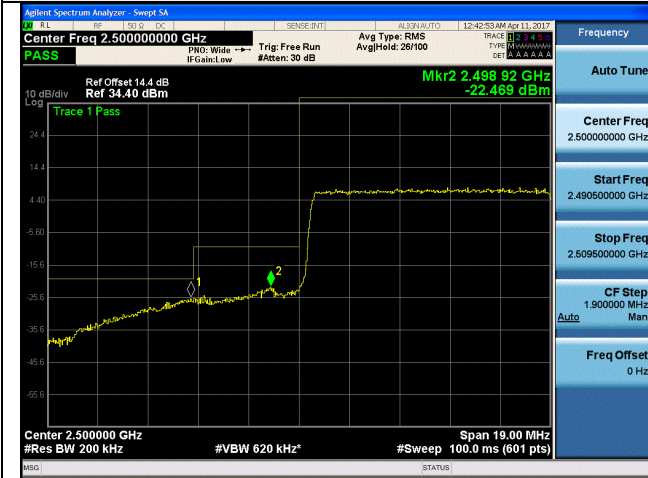

50RB#0

50RB#0

High Channel



50RB#0

50RB#0

LTE FDD Band 7 – 15 MHz Channel Bandwidth Band Edge Compliance

QPSK

16QAM

Low Channel

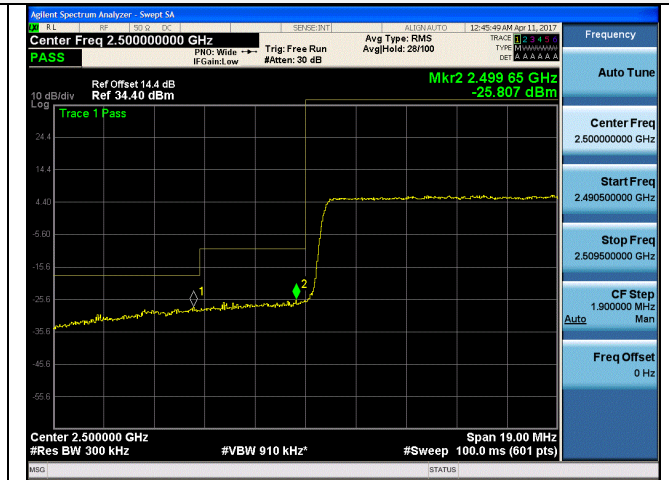
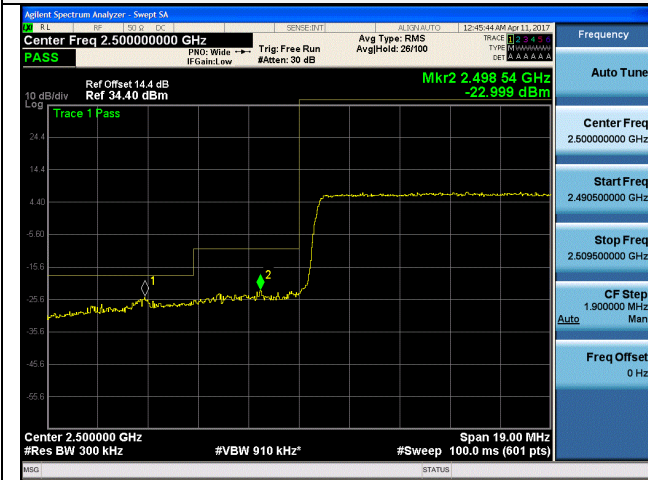

75RB#0

75RB#0

High Channel

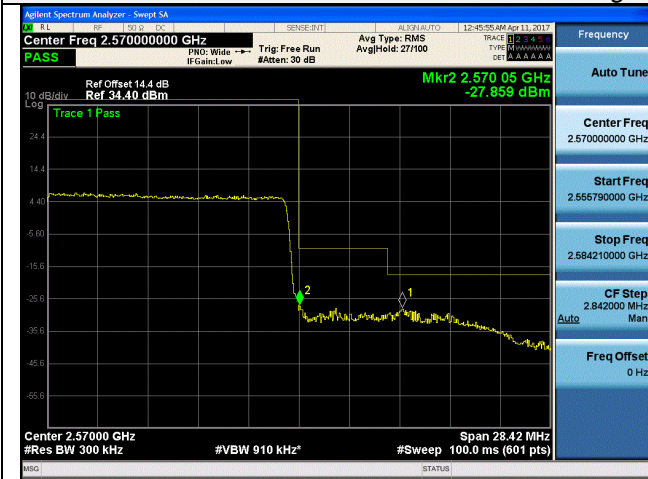

75RB#0

75RB#0

LTE FDD Band 7 – 20 MHz Channel Bandwidth Band Edge Compliance

QPSK

16QAM

Low Channel

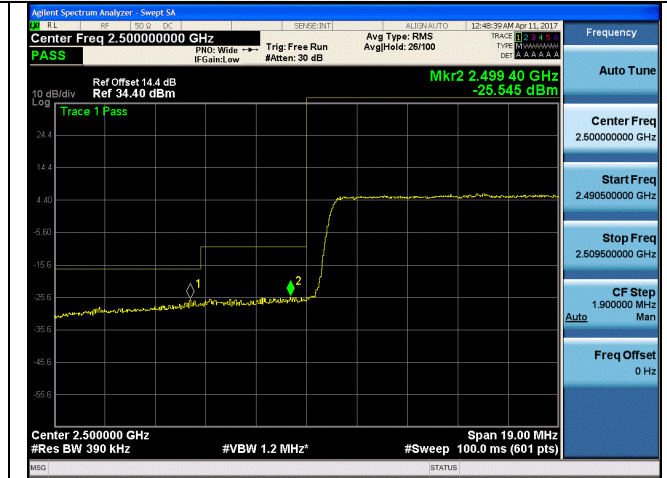
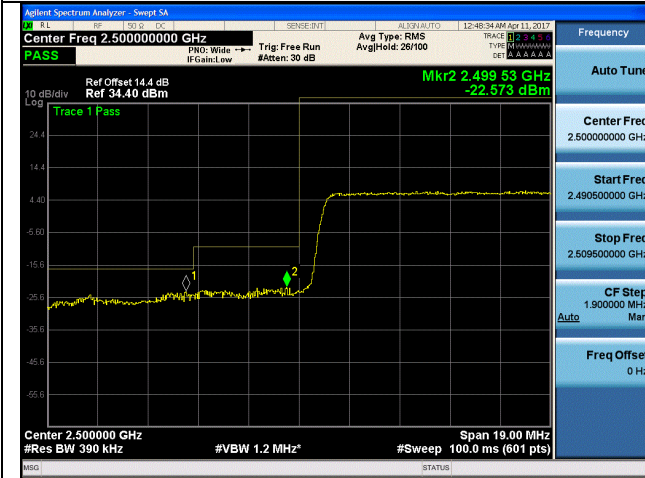

100RB#0

100RB#0

High Channel

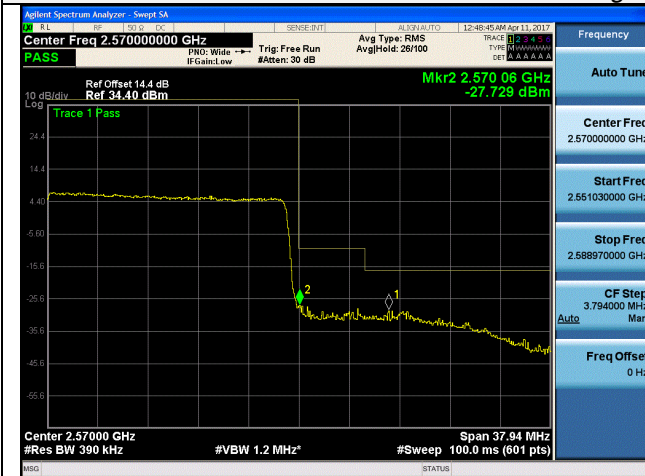

100RB#0

100RB#0

4.5. Spurious Emission on Antenna Port

LIMIT

According to §27.53(h): For operations in the 1710–1755 MHz and 2110–2155 MHz bands, the power of any emission outside a licensee’s frequency block shall be attenuated below the transmitter power (P) by at least $43 + 10 \log_{10}(P)$ dB.

TEST CONFIGURATION

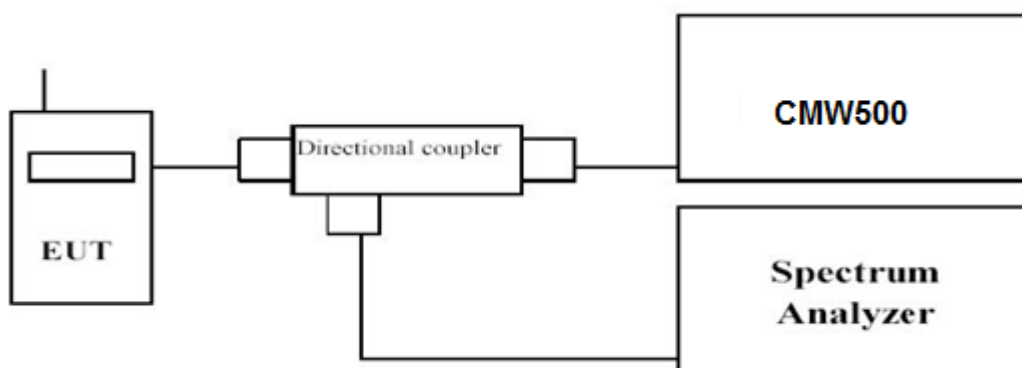

TEST PROCEDURE

The EUT was setup according to EIA/TIA 603D

- a. Place the EUT on a bench and set it in transmitting mode.
- b. Connect a low loss RF cable from the antenna port to a spectrum analyzer and CMW500 by a Directional Couple.
- c. EUT Communicate with CMW500, then select a channel for testing.
- d. Add a correction factor to the display of spectrum, and then test.
- e. The resolution bandwidth of the spectrum analyzer was set sufficient scans were taken to show the out of band Emission if any up to 10th harmonic.
- f. Please refer to following tables for test antenna conducted emissions.

Working Frequency	Sub range (GHz)	RBW	VBW	Sweep time (s)
LTE FDD Band 7	0.000009~0.000015	1KHz	3KHz	Auto
	0.000015~0.03	10KHz	30KHz	Auto
	0.03~4	1 MHz	3 MHz	Auto
	4~26	1 MHz	3 MHz	Auto

TEST RESULTS

Remark: The EUT supports two SIM card SIM1 and SIM2. For GSM, the SIM 1 and SIM 2 both support GSM. For WCDMA/LTE, Only SIM 1 support WCDMA/LTE. We were tested all RB Configuration refer 3GPP TS136 521 for each Channel Bandwidth of LTE FDD Band 7; recorded worst case for each Channel Bandwidth of LTE FDD Band 7.

LTE FDD Band 2-5 MHz Channel Bandwidth
 Low Channel
 QPSK

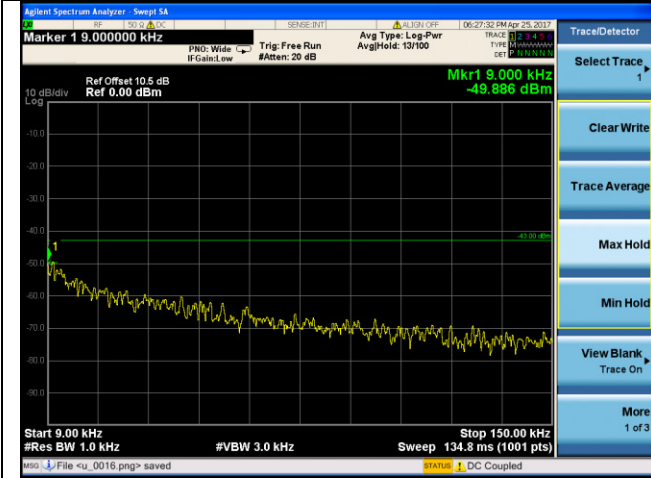

9KHz~150KHz

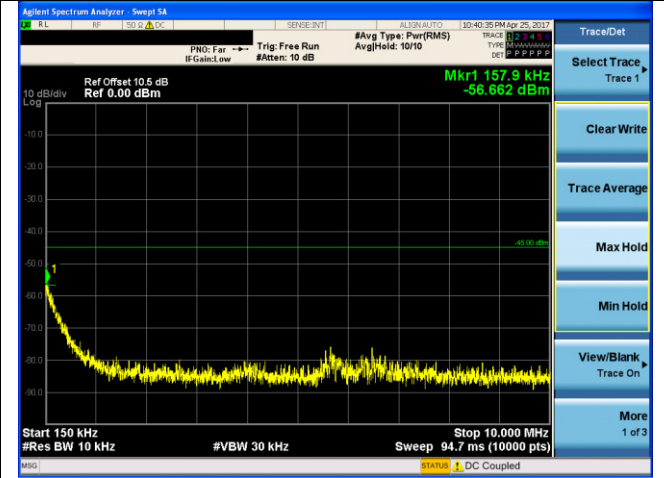

150KHz~10MHz

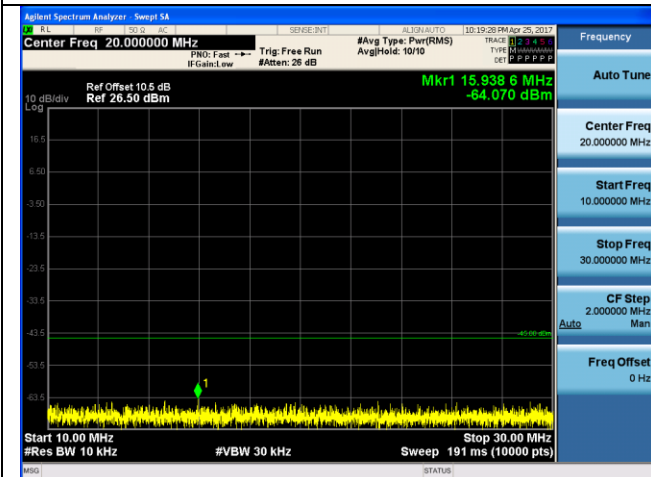

10MHz~30MHz

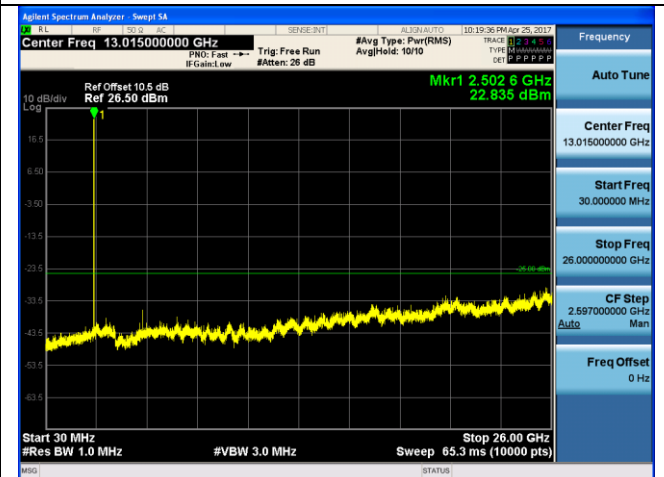

30MHz ~26 GHz

LTE FDD Band 2-5 MHz Channel Bandwidth

Middle Channel

QPSK

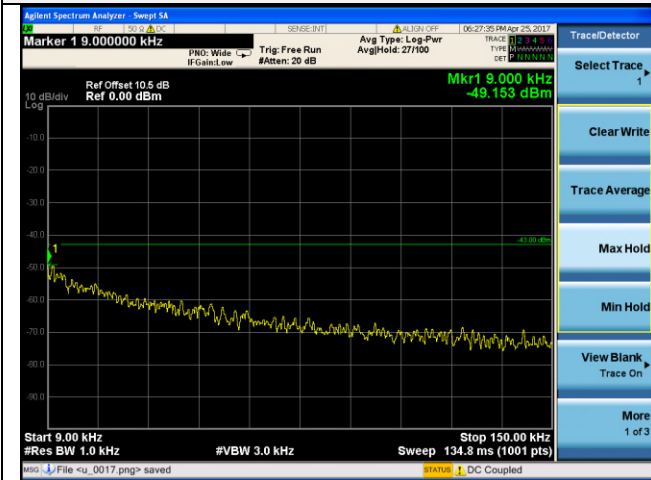

9KHz~150KHz

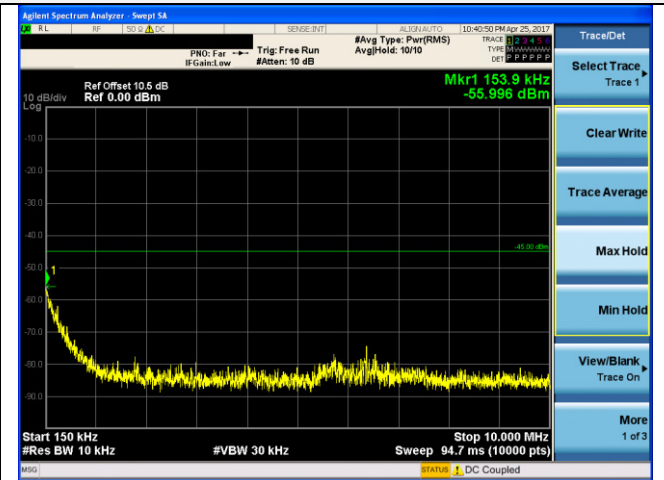

150KHz~10MHz

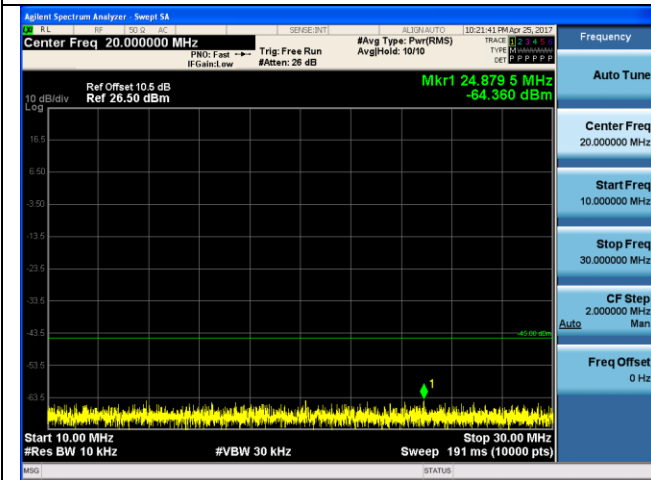

10MHz~30MHz

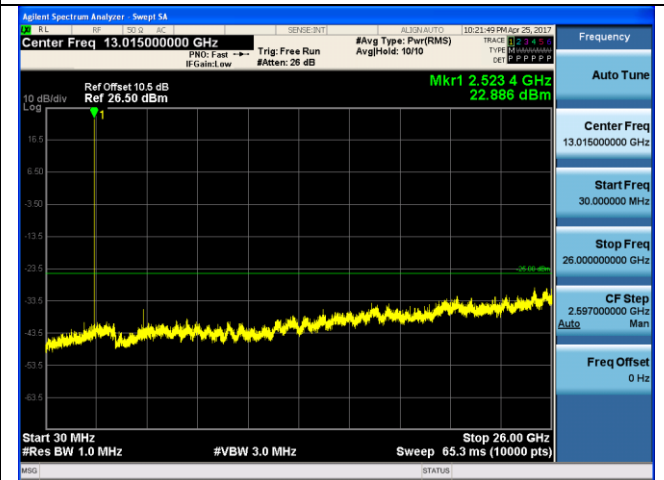

30MHz ~26 GHz

LTE FDD Band 2-5 MHz Channel Bandwidth

High Channel

QPSK

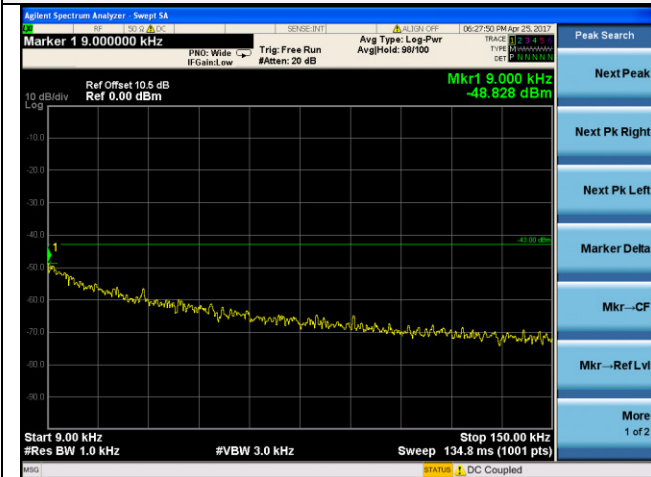

9KHz~150KHz

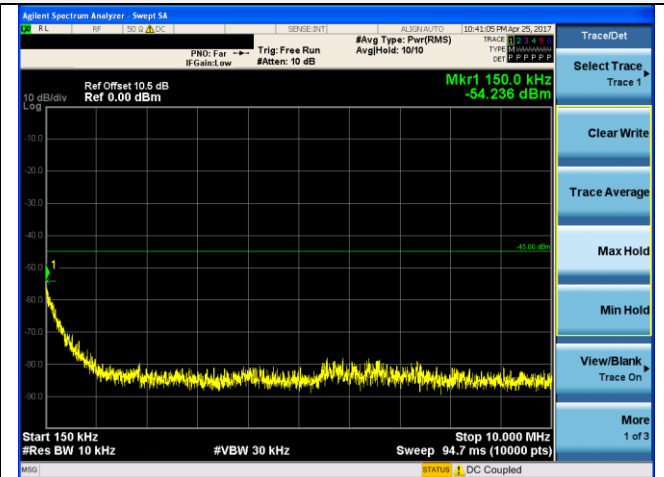

150KHz~10MHz

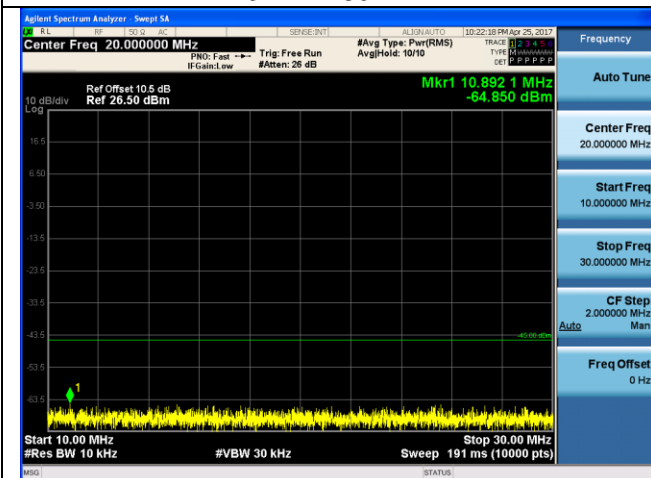

10MHz~30MHz

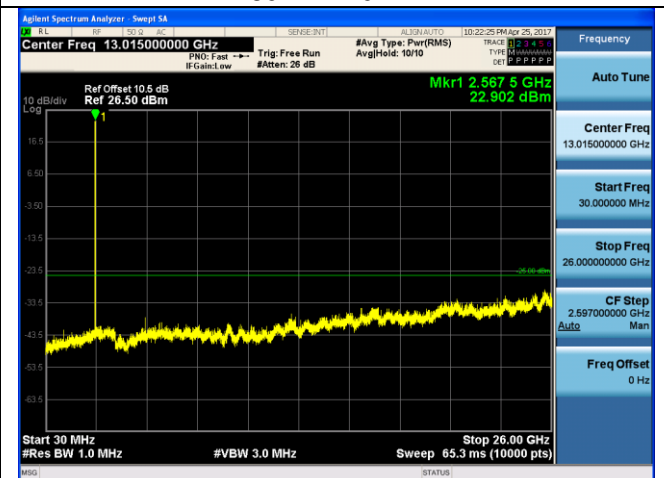

30MHz ~26 GHz