



**Shenzhen Global Test Service Co.,Ltd.**

1F, Building No. 13A, Zhonghaixin Science and Technology City, No.12,6 Road, Ganli Industrial Park, Buji Street, Longgang District, Shenzhen, Guangdong

**FCC PART 24TEST REPORT**

**Part 24 Subpart E**

**Report Reference No.....: GTSR17042018-LTE Band 2**

**FCC ID.....: RQQHLT-ORBITUT**

Compiled by  
( position+printed name+signature)..: File administrators Jimmy Wang

Supervised by  
( position+printed name+signature)..: Test Engineer Peter Xiao

Approved by  
( position+printed name+signature)..: Manager Sam Wang

Date of issue.....: April. 28, 2017

**Representative Laboratory Name .: Shenzhen Global Test Service Co.,Ltd.**

Address .....: 1F, Building No. 13A, Zhonghaixin Science and Technology City,  
No.12,6 Road, Ganli Industrial Park, Buji Street, Longgang District,  
Shenzhen, Guangdong

**Applicant's name.....: HYUNDAI CORPORATION**

Address .....: 25,Yulgok-ro 2-Gil, Jongno-gu, Seoul, South Korea

**Test specification .....**

Standard .....: **FCC CFR Title 47 Part 2, Part 24E**  
**EIA/TIA 603-D: 2010**  
**KDB 971168 D01**

TRF Originator.....: Shenzhen Global Test Service Co.,Ltd.

**Shenzhen Global Test Service Co.,Ltd.All rights reserved.**

This publication may be reproduced in whole or in part for non-commercial purposes as long as the Shenzhen Global Test Service Co.,Ltd.as copyright owner and source of the material. Shenzhen Global Test Service Co.,Ltd.takes no responsibility for and will not assume liability for damages resulting from the reader's interpretation of the reproduced material due to its placement and context.

**Test item description .....** Mobile Phone

Trade Mark .....: HYUNDAI

**Manufacturer.....: Shenzhen Rainbow Time Technology Co.,Ltd**

Model/Type reference.....: ORBIT

Listed Models .....: /

Modulation Type .....: QPSK, 16QAM

Rating .....: DC 3.80V

Hardware version .....: V1\_02\_C00SEA

Software version.....: V1.0

Result.....: **PASS**

**TEST REPORT**

<b>Test Report No. :</b> <b>GTSR17042018-LTE Band 2</b>	April.28, 2017
	Date of issue

Equipment under Test            :      Mobile Phone

Model /Type                        :      ORBIT

Listed Models                     :      /

**Applicant**                         :      **HYUNDAI CORPORATION**

Address                              :      25,Yulgok-ro 2-Gil, Jongno-gu, Seoul, South Korea

**Manufacturer**                    :      **Shenzhen Rainbow Time Technology Co.,Ltd**

Address                              :      Room 905, ChangHong Technology Building, Science and  
Technology Park, Nanshan District, Shenzhen, China

<b>Test Result:</b>	<b>PASS</b>
---------------------	-------------

The test report merely corresponds to the test sample.

It is not permitted to copy extracts of these test result without the written permission of the test laboratory.

## Contents

<b><u>1</u></b>	<b><u>TEST STANDARDS .....</u></b>	<b><u>4</u></b>
<b><u>2</u></b>	<b><u>SUMMARY .....</u></b>	<b><u>5</u></b>
2.1	General Remarks	5
2.2	Product Description	5
2.3	Equipment under Test	5
2.4	Short description of the Equipment under Test (EUT)	5
2.5	EUT configuration	6
2.6	Related Submittal(s) / Grant (s)	6
2.7	Modifications	6
2.8	Test Environments	6
<b><u>3</u></b>	<b><u>TEST ENVIRONMENT .....</u></b>	<b><u>7</u></b>
3.1	Address of the test laboratory	7
3.2	Test Facility	7
3.3	Environmental conditions	7
3.4	Test Description	8
3.5	Equipments Used during the Test	9
<b><u>4</u></b>	<b><u>TEST CONDITIONS AND RESULTS.....</u></b>	<b><u>10</u></b>
4.1	Output Power	10
4.2	Peak-to-Average Ratio (PAR)	16
4.3	Occupied Bandwidth and Emission Bandwidth	23
4.4	Band Edge compliance	30
4.5	Spurious Emission on Antenna Port	37
4.6	Radiated Spurious Emission	56
4.7	Frequency Stability	64
<b><u>5</u></b>	<b><u>TEST SETUP PHOTOS OF THE EUT .....</u></b>	<b><u>66</u></b>
<b><u>6</u></b>	<b><u>EXTERNAL AND INTERNAL PHOTOS OF THE EUT .....</u></b>	<b><u>66</u></b>

# **1 TEST STANDARDS**

The tests were performed according to following standards:

[FCC Part 24](#) :PUBLIC MOBILE SERVICES

[TIA/EIA 603 D June 2010](#):Land Mobile FM or PM Communications Equipment Measurement and Performance Standards.

[47 CFR FCC Part 15 Subpart B](#): - Unintentional Radiators

[FCC Part 2](#): FREQUENCY ALLOCA-TIONS AND RADIO TREATY MAT-TERS; GENERAL RULES AND REG-ULATIONS

[KDB971168 D01:v02r02](#)MEASUREMENT GUIDANCE FOR CERTIFICATION OF LICENSED DIGITAL TRANSMITTERS

[ANSI C63.4:2014](#):Methods of Measurement of Radio-Noise Emissions from Low-Voltage Electrical and Electronic Equipment in the Range of 9 kHz to 40 GHz



## 2 SUMMARY

### 2.1 General Remarks

Date of receipt of test sample	:	April. 05, 2017
Testing commenced on	:	April. 05, 2017
Testing concluded on	:	April. 28, 2017

### 2.2 Product Description

The **HYUNDAI CORPORATION**'s Model:ORBIT or the "EUT" as referred to in this report; more general information as follows, for more details, refer to the user's manual of the EUT.

Name of EUT	Mobile Phone
Model/Type reference:	ORBIT
List Model:	/
Power supply:	DC 3.80V
Adapter Information	Model: Y-5204B-2A Input: AC100-240V~50/60Hz 0.3A Output:DC5V/2000mA
Modulation Type	QPSK,16QAM
Antenna Type	Internal
Antenna Gain	-1.01dBi
Operation Frequency Band	LTE Band 2
Operation frequency	LTE Band 2: 1850.7~1909.3 MHz
LTE Release	R7
Hardware version	V1_02_C00SEA
Software version	V1.0
Extreme temp. Tolerance	-30°C to +50°C
Extreme vol. Limits	3.40VDC to 4.20VDC (nominal: 3.80VDC)

### 2.3 Equipment under Test

#### Power supply system utilised

Power supply voltage	:	<input type="radio"/> 120V/ 60 Hz	<input type="radio"/> 115V/60Hz
		<input type="radio"/> 12 V DC	<input type="radio"/> 24 V DC
		<input checked="" type="radio"/> Other (specified in blank below)	

DC 3.80V

### 2.4 Short description of the Equipment under Test (EUT)

This is a Mobile Phone .

For more details, refer to the user's manual of the EUT.

### 2.5 EUT configuration

The following peripheral devices and interface cables were connected during the measurement:

- - supplied by the manufacturer
- - supplied by the lab

○ /		M/N :	
		Manufacturer:	

### 2.6 Related Submittal(s) / Grant (s)

This submittal(s) (test report) is intended for **FCC ID: RQQLT-ORBITUT** filing to comply with FCC Part 24, Rules.

### 2.7 Modifications

No modifications were implemented to meet testing criteria.

### 2.8 Test Environments

EnvironmentParameter	SelectedValuesDuringTests	
Relative Humidity	Ambient	
Temperature	TN	Ambient
Voltage	VL	3.40V
	VN	3.80V
	VH	4.20V

NOTE:VL=lowerextreme testvoltageVN=nominalvoltage  
 VH=upperextreme testvoltageTN=normaltemperature

### **3 TEST ENVIRONMENT**

#### **3.1 Address of the test laboratory**

**Shenzhen Global Test Service Co.,Ltd.**

1F, Building No. 13A, Zhonghaixin Science and Technology City, No.12,6 Road, Ganli Industrial Park, Buji Street, Longgang District, Shenzhen, Guangdong

**Shenzhen CTL Testing Technology Co., Ltd.**

1/F.-A, Baisha Technology Park, No.3011, Shahexi Road, Nanshan District, Shenzhen, Guangdong, China

#### **3.2 Test Facility**

The test facility is recognized, certified, or accredited by the following organizations:

**FCC-Registration No.: 964637**

Shenzhen Global Test Service Co.,Ltd EMC Laboratory has been registered and fully described in a report filed with the (FCC) Federal Communications Commission. The acceptance letter from the FCC is maintained in our files. Registration 964637, Jul 24, 2015.

**CNAS-Lab Code: L8169**

Shenzhen Global Test Service Co.,Ltd. has been assessed and proved to be in compliance with CNAS-CL01 Accreditation Criteria for Testing and Calibration Laboratories (identical to ISO/IEC 17025: 2005 General Requirements) for the Competence of Testing and Calibration Laboratories. Date of Registration: Dec. 11, 2015. Valid time is until Dec. 10, 2018.

**FCC-Registration No.: 970318**

Shenzhen CTL Testing Technology Co., Ltd. EMC Laboratory has been registered and fully described in a report filed with the (FCC) Federal Communications Commission. The acceptance letter from the FCC is maintained in our files. Registration 970318, December 19, 2013.

#### **3.3 Environmental conditions**

During the measurement the environmental conditions were within the listed ranges:

Temperature:	15-35 ° C
Humidity:	30-60 %
Atmospheric pressure:	950-1050mbar

### 3.4 Test Description

Test Item	FCCRuleNo.	Requirements	Verdict
Effective(Isotropic)RadiatedOutputPower	§2.1046, §24.232	EIRP $\leq 2W$	Pass
Peak-AverageRatio	§2.1046, §24.232	FCC:Limits $\leq 13dB$	Pass
ModulationCharacteristics	§2.1047	Digitalmodulation	N/A
Bandwidth	§2.1049	OBW: Nolimit. EBW: Nolimit.	Pass
BandEdgesCompliance	§2.1051, §24.238	$\leq -13dBm/1\%*EBW$ , In1MHzbandsimmediatelyoutsideandadjacentto Thefrequency block.	Pass
SpuriousEmissionatAntennaTerminals	§2.1051, §24.238	$\leq -13dBm/1MHz$ , from9kHzto10thharmonicsbut outsideauthorized Operatingfrequency ranges.	Pass
Field Strengthof Spurious Radiation	§2.1053, §24.238	$\leq -13dBm/1MHz$ .	Pass
Frequency Stability	§2.1055, §24.235	FCC:withinauthorizedfrequency block.	Pass
NOTE 1:For theverdict,the“N/A”denotes“not applicable”,the“N/T”denotes “nottested”.			

Remark: The measurement uncertainty is not included in the test result.

### 3.5 Equipments Used during the Test

Test Equipment	Manufacturer	Model No.	Serial No.	Calibration Date	Calibration Due Date
Bilog Antenna	Sunol Sciences Corp.	JB1	A061713	2016/06/02	2017/06/01
Bilog Antenna	Sunol Sciences Corp.	JB1	A061719	2016/06/02	2017/06/01
EMI Test Receiver	R&S	ESCI	101102	2016/06/26	2017/06/25
Spectrum Analyzer	Agilent	N9020A	MY48010425	2016/06/17	2017/06/16
Controller	EM Electronics	Controller EM 1000	N/A	2016/05/21	2017/05/20
Horn Antenna	Sunol Sciences Corp.	DRH-118	A062013	2016/05/19	2017/05/18
Horn Antenna	Sunol Sciences Corp.	DRH-118	A062014	2016/05/19	2017/05/18
Active Loop Antenna	SCHWARZBECK	FMZB1519	1519-037	2016/05/19	2017/05/18
Amplifier	Agilent	8349B	3008A02306	2016/05/19	2017/05/18
Amplifier	Agilent	8447D	2944A10176	2016/05/19	2017/05/18
Temperature/ Humidity Meter	Gangxing	CTH-608	02	2016/05/20	2017/05/19
High-Pass Filter	K&L	9SH10-2700/X12750-O/O	N/A	2016/05/20	2017/05/19
High-Pass Filter	K&L	41H10-1375/U12750-O/O	N/A	2016/05/20	2017/05/19
RF Cable	HUBER+SUHNER	RG214	N/A	2016/05/20	2017/05/19
Data acquisition card	Agilent	U2531A	TW53323507	2016/05/20	2017/05/19
Power Sensor	Agilent	U2021XA	MY5365004	2016/05/20	2017/05/19
Radio Communication Tester	R&S	CMW500	A130101034	2016/06/02	2017/06/01

Note: The calibration interval was one year.

## 4 TEST CONDITIONS AND RESULTS

### 4.1 Output Power

#### 4.1.1 Conducted Output Power

##### TEST APPLICABLE

During the process of testing, the EUT was controlled via R&S Digital Radio Communication tester (CMW500) to ensure max power transmission and proper modulation. This result contains output power and EIRP measurements for the EUT. In all cases, output power is within the specified limits.

##### TEST CONFIGURATION

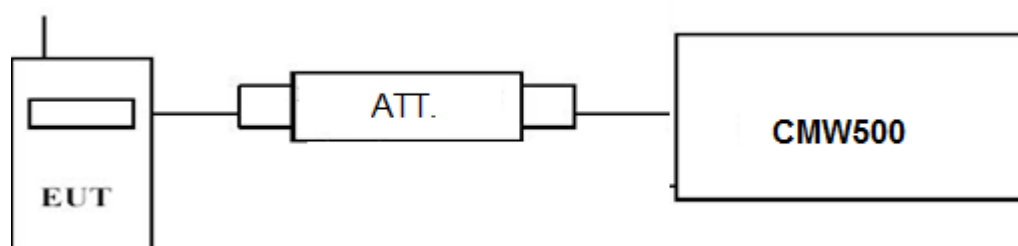

##### TEST PROCEDURE

###### **Conducted Power Measurement:**

- Place the EUT on a bench and set it in transmitting mode.
- Connect a low loss RF cable from the antenna port to a CMW500 by an Att.
- EUT Communicate with CMW500 then selects a channel for testing.
- Add a correction factor to the display CMW500, and then test.

##### TEST RESULTS

Remark:

- We were tested all RB Configuration refer 3GPP TS136 521 for each Channel Bandwidth of LTE FDD Band 2;
- The EUT supports two SIM card SIM1 and SIM2. For GSM,the SIM 1 and SIM 2 both support GSM.For WCDMA/LTE,Only SIM 1 support WCDMA/LTE.

<i>LTE FDD Band 2</i>				
TX Channel Bandwidth	Frequency (MHz)	RB Size/Offset	Burst Average Power [dBm]	
			QPSK	16QAM
1.4 MHz	1850.7	1 RB low	22.65	21.87
		1 RB high	22.48	21.71
		50% RB mid	22.40	21.48
		100% RB	21.45	20.46
	1880.0	1 RB low	22.75	22.03
		1 RB high	22.73	22.01
		50% RB mid	22.75	21.67
		100% RB	21.72	20.69
	1909.3	1 RB low	22.60	21.71
		1 RB high	22.62	21.74
		50% RB mid	22.65	21.57
		100% RB	21.73	20.72
3 MHz	1851.5	1 RB low	21.82	21.13
		1 RB high	21.87	21.19
		50% RB mid	20.93	19.98
		100% RB	21.95	20.91
	1880.0	1 RB low	22.77	22.02
		1 RB high	22.72	22.00

		50% RB mid	21.81	20.75	
		100% RB	21.75	20.77	
		1908.5	1 RB low	22.62	21.76
			1 RB high	22.25	21.55
			50% RB mid	21.68	20.62
			100% RB	21.65	20.63
5 MHz	1852.5	1 RB low	21.73	20.99	
		1 RB high	21.82	21.05	
		50% RB mid	21.55	20.46	
		100% RB	21.48	20.45	
	1880.0	1 RB low	22.87	22.01	
		1 RB high	22.76	21.93	
		50% RB mid	21.80	20.87	
		100% RB	21.78	20.79	
	1907.5	1 RB low	22.75	21.86	
		1 RB high	22.18	21.35	
		50% RB mid	21.75	20.78	
		100% RB	22.17	21.37	
10 MHz	1855.0	1 RB low	21.62	20.84	
		1 RB high	22.15	21.63	
		50% RB mid	21.25	20.27	
		100% RB	21.16	20.22	
	1880.0	1 RB low	22.82	22.17	
		1 RB high	22.76	22.02	
		50% RB mid	21.80	20.82	
		100% RB	21.82	20.85	
	1905.0	1 RB low	22.13	21.31	
		1 RB high	21.55	20.86	
		50% RB mid	21.28	20.24	
		100% RB	21.76	20.69	
15 MHz	1857.5	1 RB low	21.62	20.85	
		1 RB high	22.62	21.88	
		50% RB mid	21.33	20.27	
		100% RB	21.17	20.19	
	1880.0	1 RB low	22.89	21.40	
		1 RB high	22.79	21.95	
		50% RB mid	21.97	20.89	
		100% RB	21.95	20.88	
	1902.5	1 RB low	22.44	21.65	
		1 RB high	21.81	21.13	
		50% RB mid	21.46	20.38	
		100% RB	21.40	20.27	
20 MHz	1860.0	1 RB low	21.66	20.89	
		1 RB high	22.91	22.06	
		50% RB mid	21.86	20.80	
		100% RB	21.72	20.84	
	1880.0	1 RB low	23.02	22.32	
		1 RB high	22.60	21.90	
		50% RB mid	22.01	21.05	
		100% RB	21.84	20.85	
	1900.0	1 RB low	22.52	21.75	
		1 RB high	21.57	20.92	
		50% RB mid	21.05	20.18	
		100% RB	21.12	20.23	

## 4.1.2. Radiated Output Power

### LIMIT

This is the test for the maximum radiated power from the EUT.

Rule Part 24.232(b) specifies, "Mobile/portable stations are limited to 2 watts e.i.r.p.

### TEST CONFIGURATION

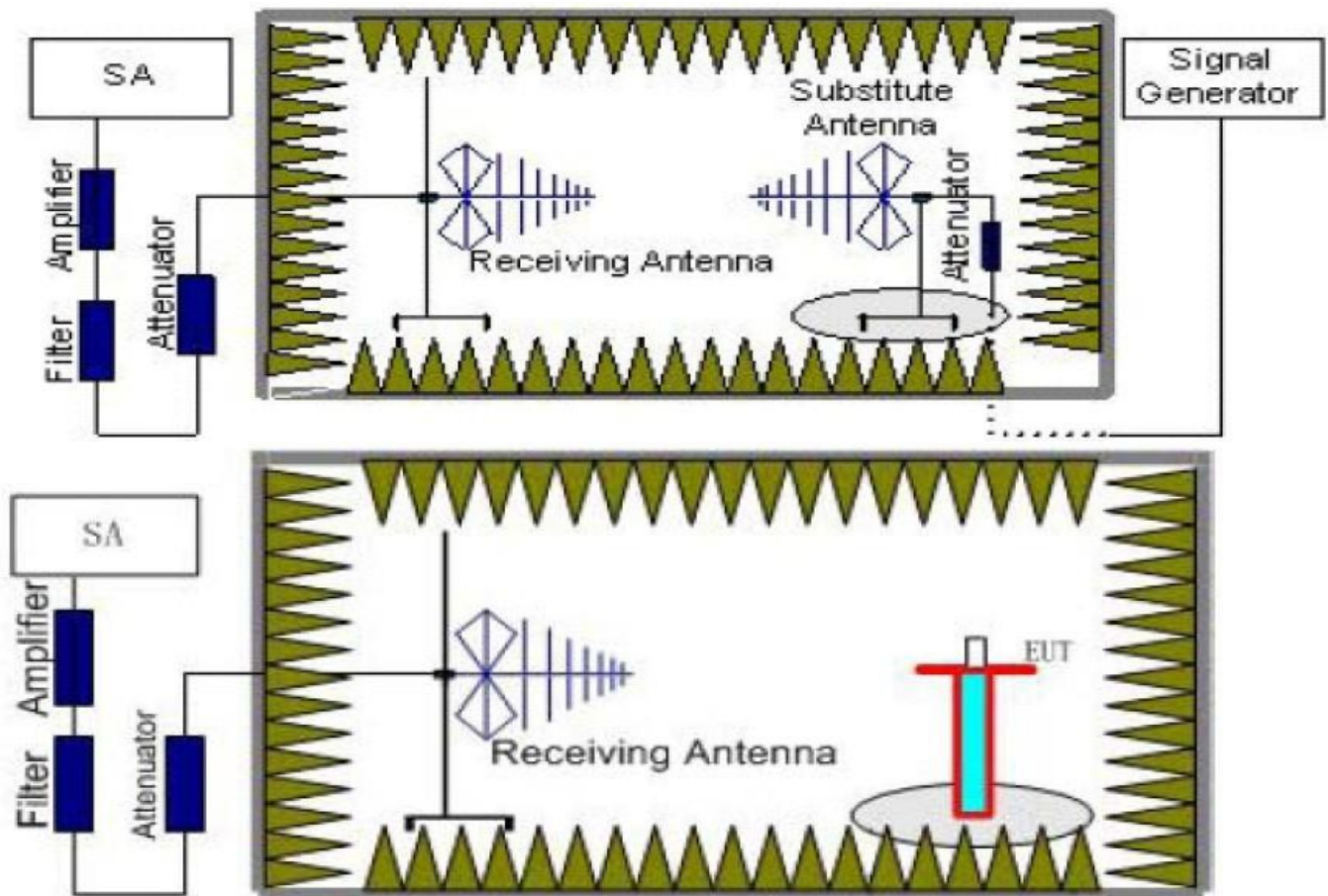

### TEST PROCEDURE

1. EUT was placed on a 1.50 meter high non-conductive stand at a 3 meter test distance from the receive antenna. A receiving antenna was placed on the antenna mast 3 meters from the EUT for emission measurements. The height of receiving antenna is 1.50m. Detected emissions were maximized at each frequency by rotating the EUT through 360° and adjusting the receiving antenna polarization. The radiated emission measurements of all transmit frequencies in three channels (High, Middle, Low) were measured with peak detector.
2. A log-periodic antenna or double-ridged waveguide horn antenna shall be substituted in place of the EUT. The log-periodic antenna will be driven by a signal generator and the level will be adjusted till the same power value on the spectrum analyzer or receiver. The level of the spurious emissions can be calculated through the level of the signal generator, cable loss, the gain of the substitution antenna and the reading of the spectrum analyzer or receiver.
3. The EUT is then put into continuously transmitting mode at its maximum power level during the test. Set Test Receiver or Spectrum RBW=1MHz, VBW=3MHz, And the maximum value of the receiver should be recorded as ( $P_r$ ).
4. The EUT shall be replaced by a substitution antenna. In the chamber, an substitution antenna for the frequency band of interest is placed at the reference point of the chamber. An RF Signal source for the frequency band of interest is connected to the substitution antenna with a cable that has been constructed to not interfere with the radiation pattern of the antenna. A power ( $P_{Mea}$ ) is applied to the input of the substitution antenna, and adjust the level of the signal generator output until the value of the receiver reach the previously recorded ( $P_r$ ). The power of signal source ( $P_{Mea}$ ) is recorded. The test should be performed by rotating the test item and adjusting the receiving antenna polarization.



5. A amplifier should be connected to the Signal Source output port. And the cable should be connect between the Amplifier and the Substitution Antenna. The cable loss ( $P_{cl}$ ), the Substitution Antenna Gain ( $G_a$ ) and the Amplifier Gain ( $P_{Ag}$ ) should be recorded after test.

The measurement results are obtained as described below:

$$\text{Power(EIRP)} = P_{\text{Mea}} - P_{\text{Ag}} - P_{\text{cl}} + G_a$$

We used SMF100A microwave signal generator which signal level can up to 33dBm, so we not used power Amplifier for substitution test; The measurement results are amend as described below:

$$\text{Power(EIRP)} = P_{\text{Mea}} - P_{\text{cl}} + G_a$$

6. This value is EIRP since the measurement is calibrated using an antenna of known gain (2.15 dBi) and known input power.
7. ERP can be calculated from EIRP by subtracting the gain of the dipole,  $\text{ERP} = \text{EIRP} - 2.15\text{dBi}$ .

## TEST RESULTS

### Radiated Measurement:

Remark:

- We measured all RB Configuration refer 3GPP TS136 521 for each Channel Bandwidth of LTE FDD Band 2; recorded worst case for each Channel Bandwidth of LTE FDD Band 2.
- $\text{EIRP} = P_{\text{Mea}}(\text{dBm}) - P_{\text{cl}}(\text{dB}) + P_{\text{Ag}}(\text{dB}) + G_a(\text{dBi})$
- The EUT supports two SIM card SIM1 and SIM2. For GSM, the SIM 1 and SIM 2 both support GSM. For WCDMA/LTE, Only SIM 1 support WCDMA/LTE.
- We measured both Horizontal and Vertical direction, recorded worst case direction.
- Test site: Shenzhen CTL Testing Technology Co., Ltd

#### LTE FDD Band 2\_Channel Bandwidth 1.4MHz\_QPSK

Frequency (MHz)	$P_{\text{Mea}}$ (dBm)	$P_{\text{cl}}$ (dB)	$G_a$ Antenna Gain(dB)	$P_{\text{Ag}}$ (dB)	Burst Average EIRP (dBm)	Limit (dBm)	Margin (dB)	Polarization
1850.7	-20.56	3.41	10.24	33.60	19.87	33.01	13.14	V
1880.0	-19.14	3.49	10.24	33.60	21.21	33.01	11.80	V
1909.3	-19.75	3.55	10.23	33.60	20.53	33.01	12.48	V

#### LTE FDD Band 2\_Channel Bandwidth 3MHz\_QPSK

Frequency (MHz)	$P_{\text{Mea}}$ (dBm)	$P_{\text{cl}}$ (dB)	$G_a$ Antenna Gain(dB)	$P_{\text{Ag}}$ (dB)	Burst Average EIRP (dBm)	Limit (dBm)	Margin (dB)	Polarization
1851.5	-20.82	3.41	10.24	33.60	20.20	33.01	12.81	V
1880.0	-19.55	3.49	10.24	33.60	20.49	33.01	12.52	V
1908.5	-19.44	3.55	10.23	33.60	20.59	33.01	12.42	V

#### LTE FDD Band 2\_Channel Bandwidth 5MHz\_QPSK

Frequency (MHz)	$P_{\text{Mea}}$ (dBm)	$P_{\text{cl}}$ (dB)	$G_a$ Antenna Gain(dB)	$P_{\text{Ag}}$ (dB)	Burst Average EIRP (dBm)	Limit (dBm)	Margin (dB)	Polarization
1852.5	-20.80	3.41	10.24	33.60	19.63	33.01	13.38	V
1880.0	-18.90	3.49	10.24	33.60	21.45	33.01	11.56	V
1907.5	-19.41	3.55	10.23	33.60	20.87	33.01	12.14	V

#### LTE FDD Band 2\_Channel Bandwidth 10MHz\_QPSK

Frequency (MHz)	$P_{\text{Mea}}$ (dBm)	$P_{\text{cl}}$ (dB)	$G_a$ Antenna Gain(dB)	$P_{\text{Ag}}$ (dB)	Burst Average EIRP (dBm)	Limit (dBm)	Margin (dB)	Polarization
1855.0	-20.75	3.41	10.24	33.60	19.68	33.01	13.33	V
1880.0	-19.91	3.49	10.24	33.60	20.44	33.01	12.57	V
1905.0	-19.49	3.55	10.23	33.60	20.79	33.01	12.22	V

*LTE FDD Band 2\_Channel Bandwidth 15MHz\_QPSK*

Frequency (MHz)	P <sub>Mea</sub> (dBm)	P <sub>cl</sub> (dB)	G <sub>a</sub> Antenna Gain(dB)	P <sub>Aq</sub> (dB)	Burst Average EIRP (dBm)	Limit (dBm)	Margin (dB)	Polarization
1857.5	-20.60	3.41	10.24	33.60	19.83	33.01	13.18	V
1880.0	-19.80	3.49	10.24	33.60	20.55	33.01	12.46	V
1902.5	-19.82	3.55	10.23	33.60	20.46	33.01	12.55	V

*LTE FDD Band 2\_Channel Bandwidth 20MHz\_QPSK*

Frequency (MHz)	P <sub>Mea</sub> (dBm)	P <sub>cl</sub> (dB)	G <sub>a</sub> Antenna Gain(dB)	P <sub>Aq</sub> (dB)	Burst Average EIRP (dBm)	Limit (dBm)	Margin (dB)	Polarization
1860.0	-19.64	3.41	10.24	33.60	20.79	33.01	12.22	V
1880.0	-19.80	3.49	10.24	33.60	20.55	33.01	12.46	V
1900.0	-20.61	3.55	10.23	33.60	19.67	33.01	13.34	V

*LTE FDD Band 2\_Channel Bandwidth 1.4MHz\_16QAM*

Frequency (MHz)	P <sub>Mea</sub> (dBm)	P <sub>cl</sub> (dB)	G <sub>a</sub> Antenna Gain(dB)	P <sub>Aq</sub> (dB)	Burst Average EIRP (dBm)	Limit (dBm)	Margin (dB)	Polarization
1850.7	-21.51	3.41	10.24	33.60	18.92	33.01	14.09	V
1880.0	-21.07	3.49	10.24	33.60	19.28	33.01	13.73	V
1909.3	-20.81	3.55	10.23	33.60	19.47	33.01	13.54	V

*LTE FDD Band 2\_Channel Bandwidth 3MHz\_16QAM*

Frequency (MHz)	P <sub>Mea</sub> (dBm)	P <sub>cl</sub> (dB)	G <sub>a</sub> Antenna Gain(dB)	P <sub>Aq</sub> (dB)	Burst Average EIRP (dBm)	Limit (dBm)	Margin (dB)	Polarization
1851.5	-21.89	3.41	10.24	33.60	18.54	33.01	14.47	V
1880.0	-20.93	3.49	10.24	33.60	19.42	33.01	13.59	V
1908.5	-21.40	3.55	10.23	33.60	18.88	33.01	14.13	V

*LTE FDD Band 2\_Channel Bandwidth 5MHz\_16QAM*

Frequency (MHz)	P <sub>Mea</sub> (dBm)	P <sub>cl</sub> (dB)	G <sub>a</sub> Antenna Gain(dB)	P <sub>Aq</sub> (dB)	Burst Average EIRP (dBm)	Limit (dBm)	Margin (dB)	Polarization
1852.5	-22.01	3.41	10.24	33.60	18.42	33.01	14.59	V
1880.0	-21.13	3.49	10.24	33.60	19.22	33.01	13.79	V
1907.5	-20.55	3.55	10.23	33.60	19.73	33.01	13.28	V

*LTE FDD Band 2\_Channel Bandwidth 10MHz\_16QAM*

Frequency (MHz)	P <sub>Mea</sub> (dBm)	P <sub>cl</sub> (dB)	G <sub>a</sub> Antenna Gain(dB)	P <sub>Aq</sub> (dB)	Burst Average EIRP (dBm)	Limit (dBm)	Margin (dB)	Polarization
1855.0	-22.02	3.41	10.24	33.60	14.6	33.01	14.60	V
1880.0	-21.02	3.49	10.24	33.60	13.68	33.01	13.68	V
1905.0	-21.10	3.55	10.23	33.60	13.83	33.01	13.83	V

*LTE FDD Band 2\_Channel Bandwidth 15MHz\_16QAM*

Frequency (MHz)	P <sub>Mea</sub> (dBm)	P <sub>cl</sub> (dB)	G <sub>a</sub> Antenna Gain(dB)	P <sub>Aq</sub> (dB)	Burst Average EIRP (dBm)	Limit (dBm)	Margin (dB)	Polarization
1857.5	-22.01	3.41	10.24	33.60	18.42	33.01	14.59	V
1880.0	-21.05	3.49	10.24	33.60	19.30	33.01	13.71	V
1902.5	-21.29	3.55	10.23	33.60	18.99	33.01	14.02	V

*LTE FDD Band 2\_Channel Bandwidth 20MHz\_16QAM*

Frequency (MHz)	P <sub>Mea</sub> (dBm)	P <sub>cl</sub> (dB)	G <sub>a</sub> Antenna Gain(dB)	P <sub>Aq</sub> (dB)	Burst Average EIRP (dBm)	Limit (dBm)	Margin (dB)	Polarization
1860.0	-21.82	3.41	10.24	33.60	18.61	33.01	14.40	V
1880.0	-21.30	3.49	10.24	33.60	19.05	33.01	13.96	V
1900.0	-21.74	3.55	10.23	33.60	18.54	33.01	14.47	V

## 4.2 Peak-to-Average Ratio (PAR)

### LIMIT

The Peak-to-Average Ratio (PAR) of the transmission may not exceed 13 dB.

### TEST CONFIGURATION

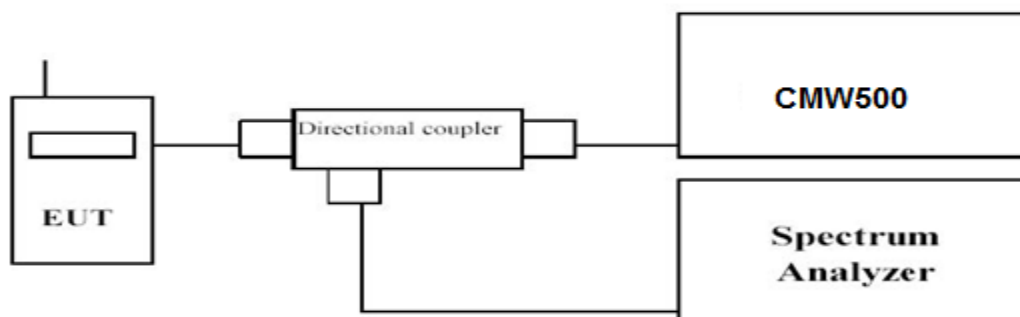

### TEST PROCEDURE

1. Refer to instrument’s analyzer instruction manual for details on how to use the power statistics/CCDF function;
2. Set resolution/measurement bandwidth  $\geq$  signal’s occupied bandwidth;
3. Set the number of counts to a value that stabilizes the measured CCDF curve;
4. Set the measurement interval as follows:
  - 1). for continuous transmissions, set to 1 ms,
  - 2). for burst transmissions, employ an external trigger that is synchronized with the EUT burst timing sequence, or use the internal burst trigger with a trigger level that allows the burst to stabilize and set the measurement interval to a time that is less than or equal to the burst duration.
5. Record the maximum PAPR level associated with a probability of 0.1%.

### TEST RESULTS

Remark: The EUT supports two SIM card SIM1 and SIM2. For GSM,the SIM 1 and SIM 2 both support GSM.For WCDMA/LTE,Only SIM 1 support WCDMA/LTE.We were tested all RB Configuration refer 3GPP TS136 521 for each Channel Bandwidth of LTE FDD Band 2; recorded worst case for each Channel Bandwidth of LTE FDD Band 2.

LTE FDD Band 2				
TX Channel Bandwidth	Frequency (MHz)	RB Size/Offset	PAPR(dB)	
			QPSK	16QAM
1.4 MHz	1850.7	1RB#0	1.90	3.47
	1880.0		3.78	2.26
	1909.3		2.01	3.07
3 MHz	1851.5	1RB#0	2.15	2.48
	1880.0		2.18	2.47
	1908.5		2.22	2.62
5 MHz	1852.5	1RB#0	5.83	6.31
	1880.0		2.13	2.58
	1907.5		2.23	2.80
10 MHz	1855.0	1RB#0	4.79	5.79
	1880.0		4.82	5.78
	1905.0		4.92	5.84
15 MHz	1857.5	1RB#0	5.81	5.31
	1880.0		5.81	5.48
	1902.5		5.89	5.48
20 MHz	1860.0	1RB#0	2.54	6.99
	1880.0		5.39	5.62
	1900.0		5.54	5.91

LTE FDD Band 2 – 1.4 MHz Channel Bandwidth PAPR

QPSK

16QAM

Low Channel



1RB#0

1RB#0

Middle Channel



1RB#0

1RB#0

High Channel



1RB#0

1RB#0

LTE FDD Band 2-3MHz Channel BandwidthPAPR

QPSK

16QAM

Low Channel

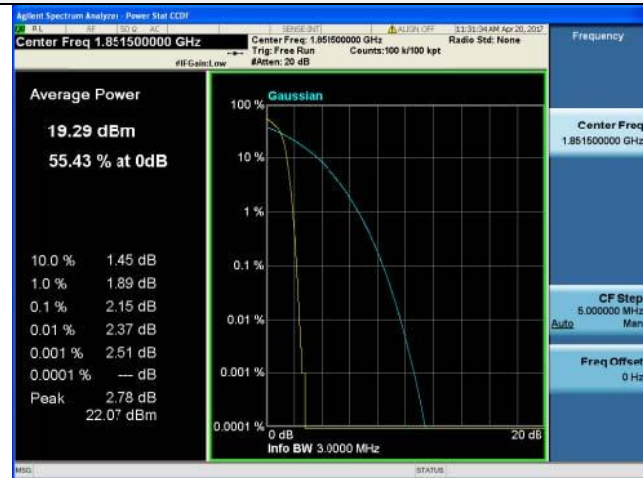

1RB#0



1RB#0

Middle Channel



1RB#0



1RB#0

High Channel



1RB#0



1RB#0



LTE FDD Band 2-5MHz Channel BandwidthPAPR

QPSK

16QAM

Low Channel



High Channel

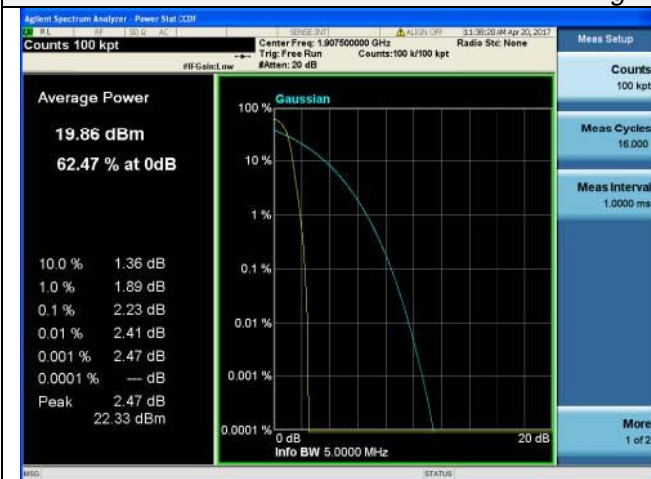

LTE FDD Band 2-10MHz Channel BandwidthPAPR

QPSK

16QAM

Low Channel



1RB#0



1RB#0

Middle Channel



1RB#0



1RB#0

High Channel



1RB#0



1RB#0



LTE FDD Band 2- 15 MHz Channel BandwidthPAPR

QPSK

16QAM

Low Channel

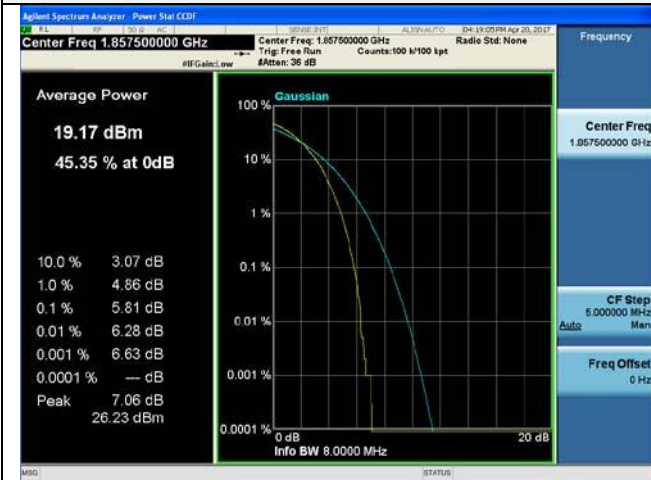

1RB#0



1RB#0

Middle Channel



1RB#0



1RB#0

High Channel



1RB#0



1RB#0

LTE FDD Band 2-20MHz Channel BandwidthPAPR

QPSK

16QAM

Low Channel



1RB#0



1RB#0

Middle Channel



1RB#0



1RB#0

High Channel



1RB#0



1RB#0

### 4.3 Occupied Bandwidth and Emission Bandwidth

**LIMIT**

N/A

**TEST CONFIGURATION**

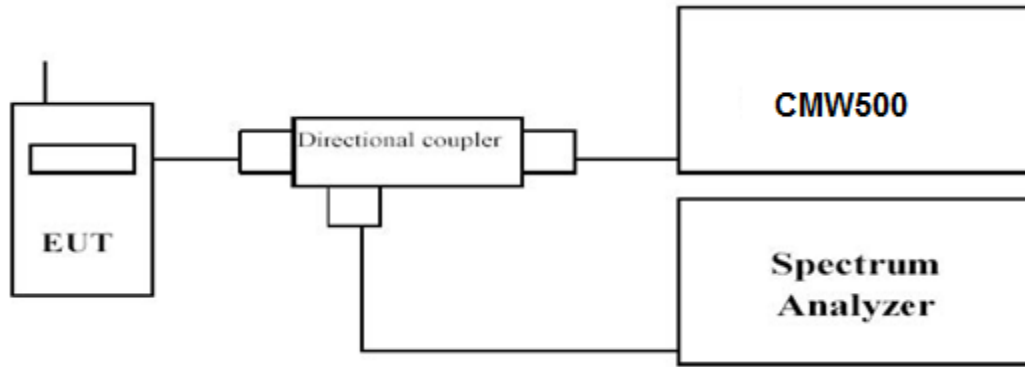

**TEST PROCEDURE**

The transmitter output was connected to a calibrated coaxial cable and coupler, the other end of which was connected to a spectrum analyzer. The occupied bandwidth was measured with the spectrum analyzer at low, middle and high channel in each band. The -26dBc Emission bandwidth was also measured and recorded. Set RBW was set to about 1% of emission BW, VBW ≥ 3 times RBW. -26dBc display line was placed on the screen (or 99% bandwidth), the occupied bandwidth is the delta frequency between the two points where the display line intersects the signal trace.

**TEST RESULTS**

Remark: The EUT supports two SIM card SIM1 and SIM2. For GSM, the SIM 1 and SIM 2 both support GSM. For WCDMA/LTE, Only SIM 1 support WCDMA/LTE. We were tested all RB Configuration refer 3GPP TS136 521 for each Channel Bandwidth of LTE FDD Band 2; recorded worst case for each Channel Bandwidth of LTE FDD Band 2.

LTE FDD Band 2						
TX Channel Bandwidth	RB Size/Offset	Frequency (MHz)	-26dBc Emission bandwidth (MHz)		99% Occupied bandwidth (MHz)	
			QPSK	16QAM	QPSK	16QAM
1.4 MHz	6RB#0	1850.7	1.255	1.256	1.0855	1.0811
		1880.0	1.253	1.253	1.0817	1.0822
		1909.3	1.261	1.242	1.0808	1.0817
3 MHz	15RB#0	1851.5	2.900	2.908	2.6856	2.6878
		1880.0	2.952	2.923	2.6852	2.6853
		1908.5	2.899	2.923	2.6866	2.6846
5 MHz	25RB#0	1852.5	4.839	4.832	4.4818	4.4818
		1880.0	4.826	4.827	4.4774	4.4700
		1907.5	4.819	4.830	4.4767	4.4606
10 MHz	50RB#0	1855.0	9.527	9.527	8.9409	8.9311
		1880.0	9.641	9.615	8.9400	8.9449
		1905.0	9.593	9.453	8.9408	8.9232
15 MHz	75RB#0	1857.5	14.11	14.06	13.391	13.381
		1880.0	14.36	14.06	13.303	13.383
		1902.5	14.18	14.02	13.300	13.399
20 MHz	100RB#0	1860.0	18.56	18.66	17.843	17.847
		1880.0	18.68	18.53	17.828	17.828
		1900.0	18.61	18.69	17.837	17.831



LTE FDD Band 2 – 1.4 MHz Channel Bandwidth Occupied Bandwidth and Emission Bandwidth

QPSK

16QAM

Low Channel



6RB#0

6RB#0

Middle Channel

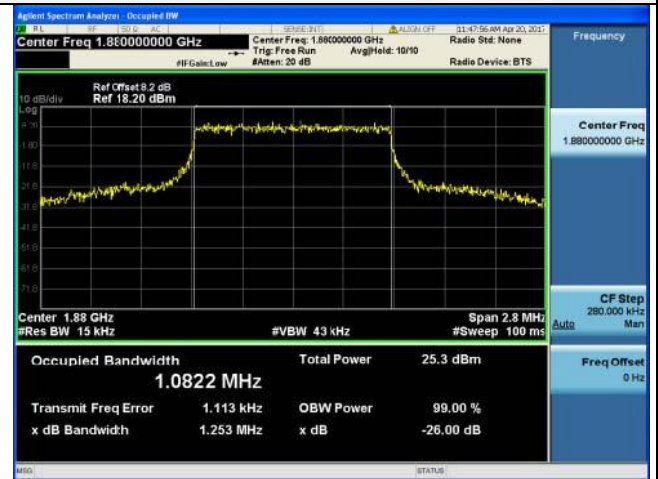
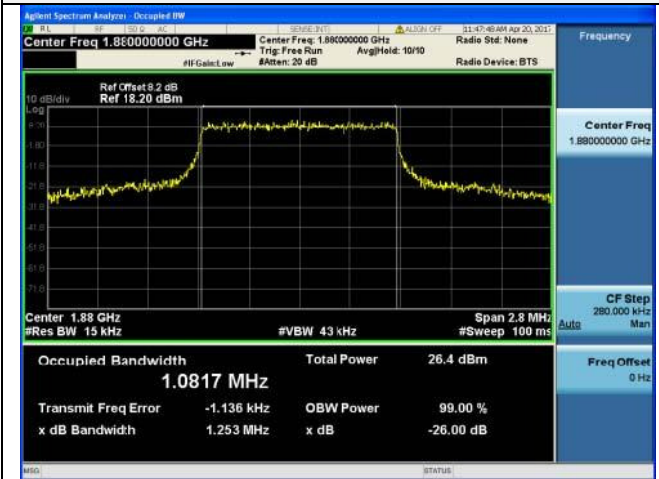

6RB#0

6RB#0

High Channel

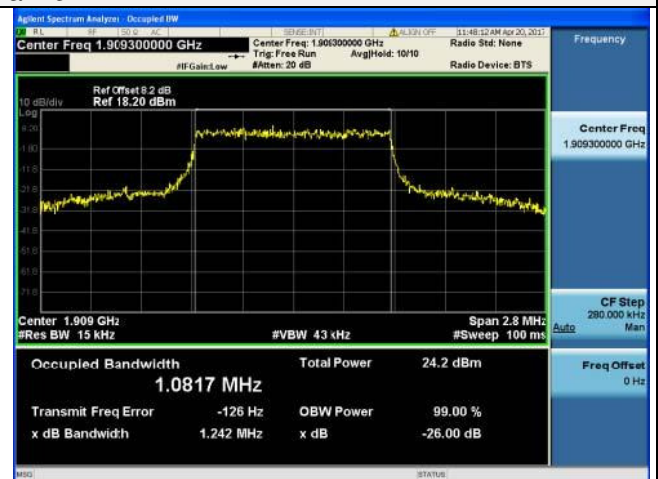
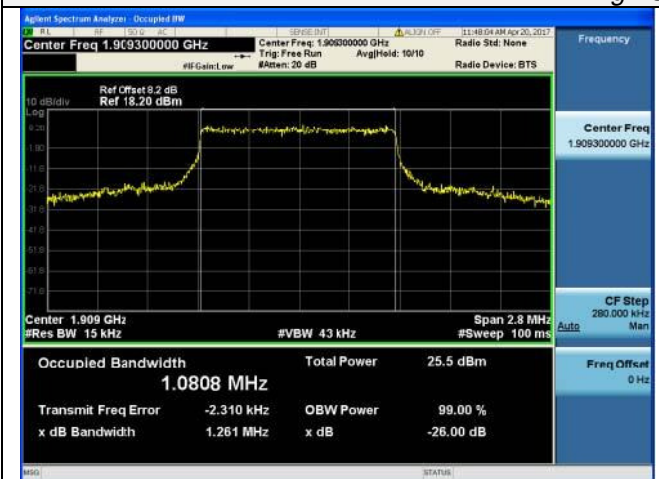

6RB#0

6RB#0

LTE FDD Band 2-3MHz Channel Bandwidth Occupied Bandwidth and Emission Bandwidth

QPSK

16QAM

Low Channel

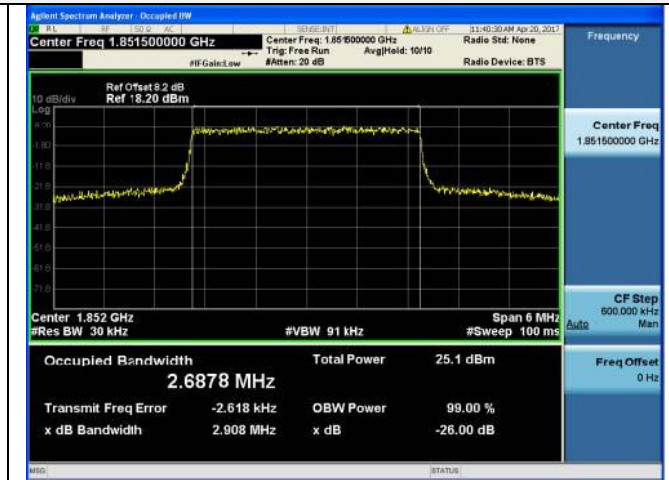
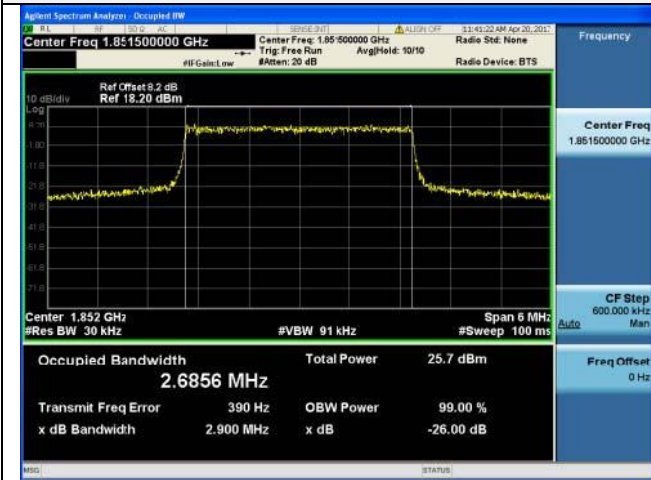

15RB#0

15RB#0

Middle Channel

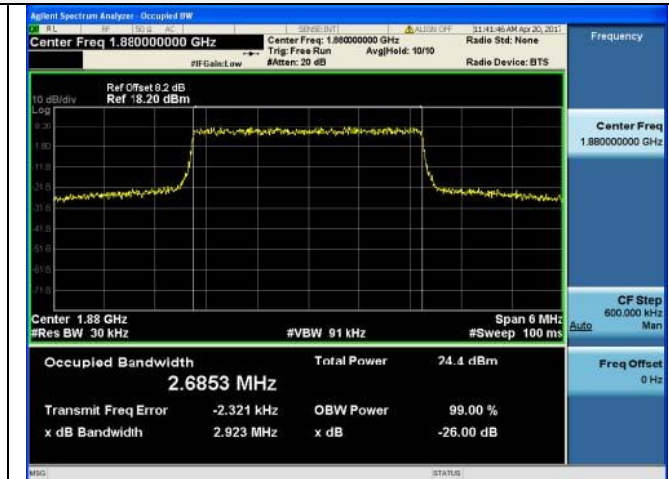
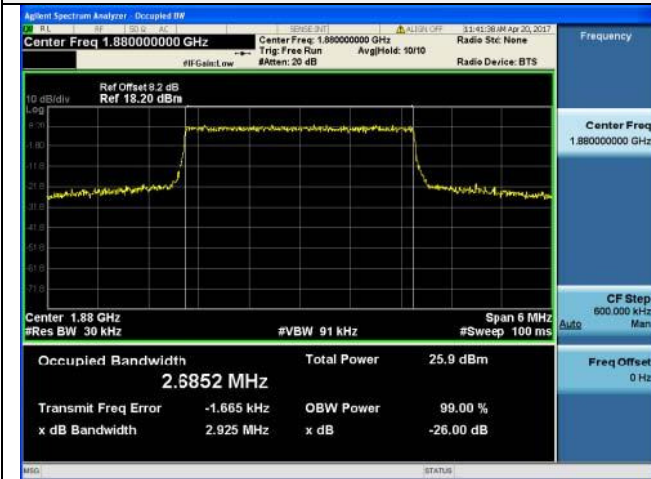

15RB#0

15RB#0

High Channel

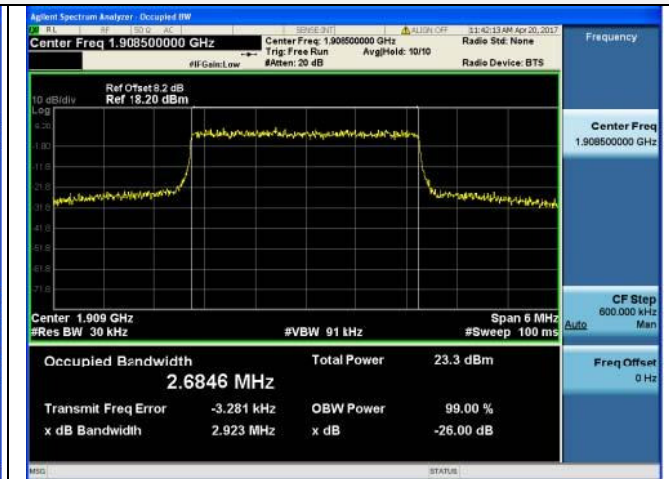
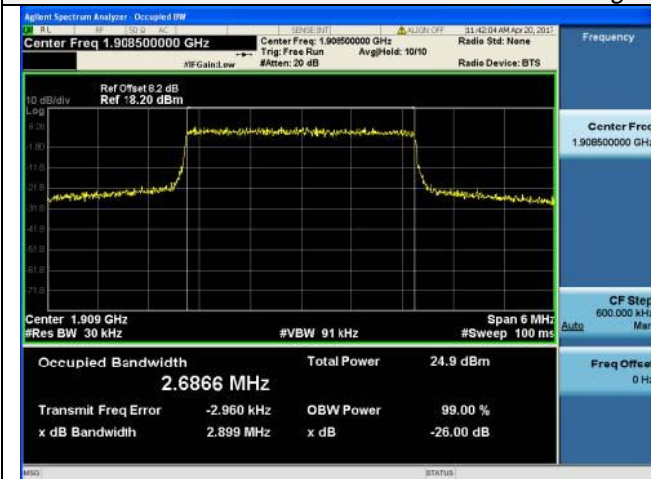

15RB#0

15RB#0

LTE FDD Band 2-5MHz Channel Bandwidth Occupied Bandwidth and Emission Bandwidth

QPSK

16QAM

Low Channel

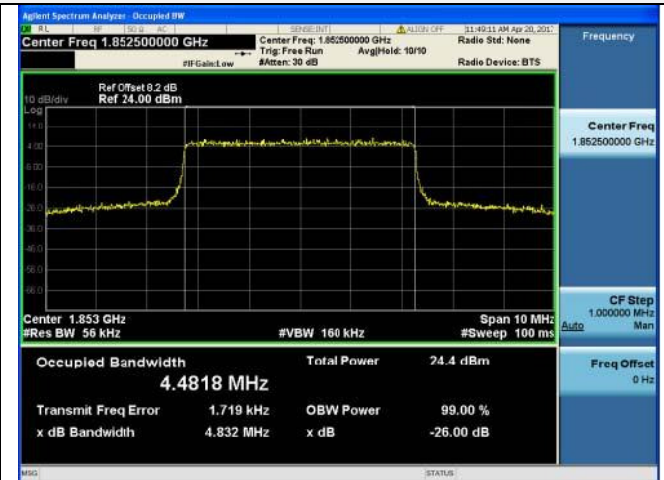
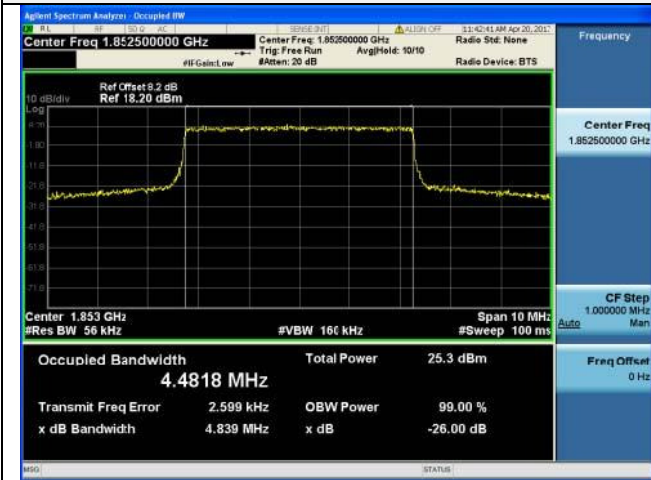

25RB#0

25RB#0

Middle Channel

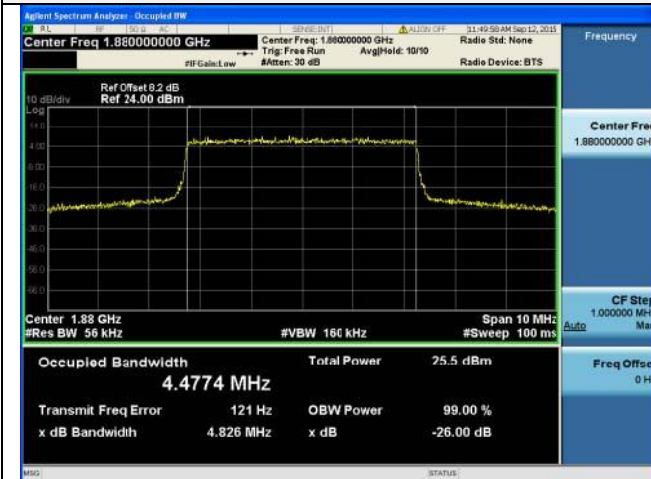

25RB#0

25RB#0

High Channel

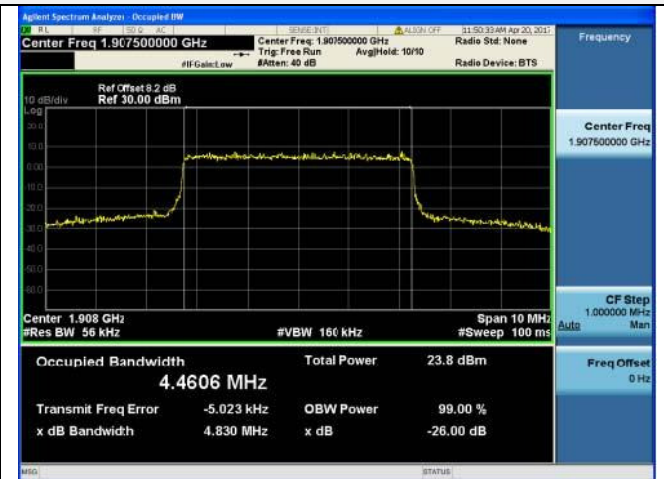
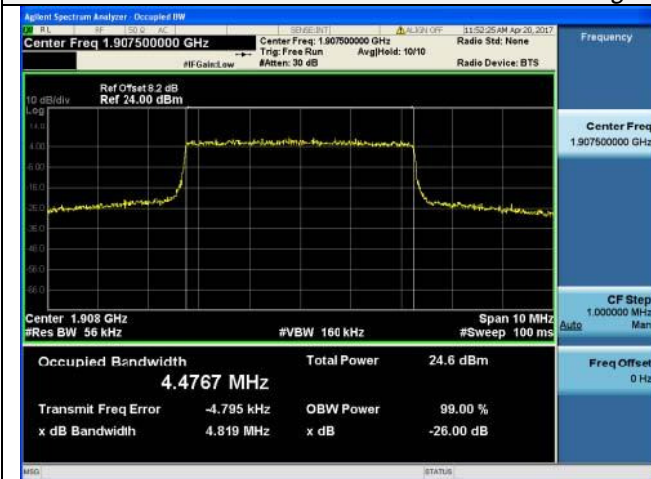

25RB#0

25RB#0



LTE FDD Band 2-10MHz Channel Bandwidth Occupied Bandwidth and Emission Bandwidth

QPSK

16QAM

Low Channel

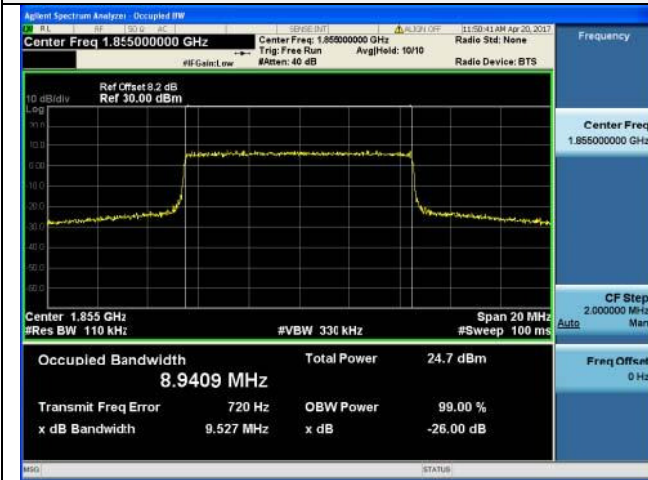

50RB#0

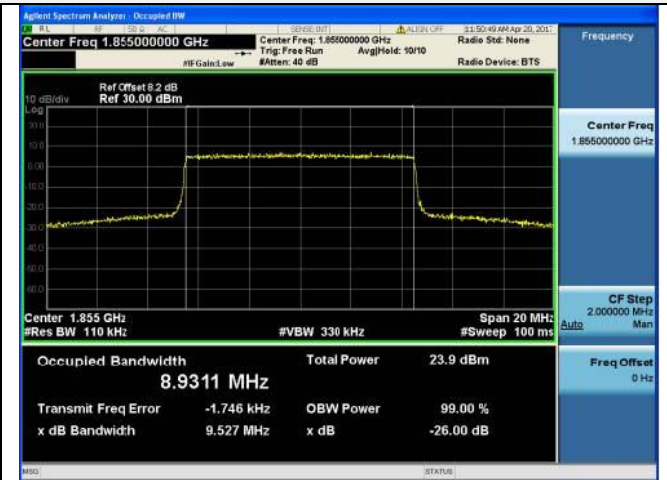

50RB#0

Middle Channel

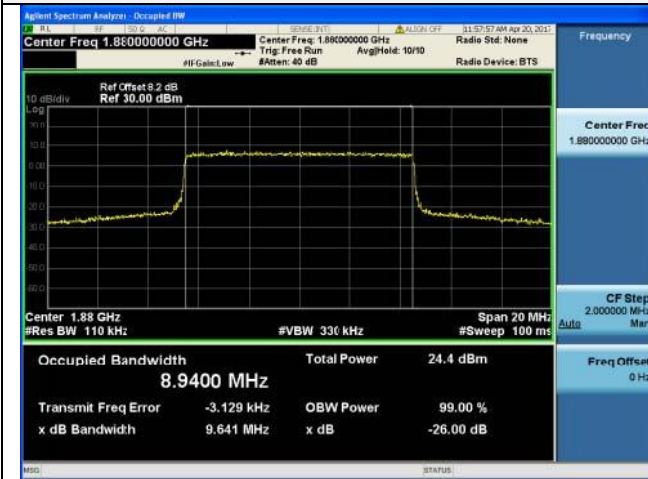

50RB#0

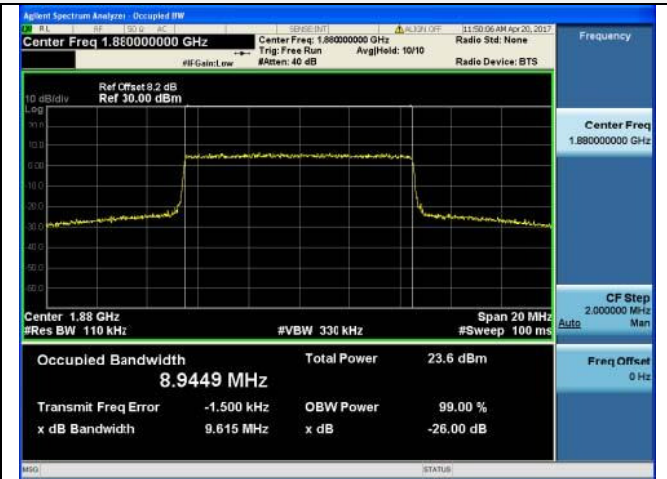

50RB#0

High Channel

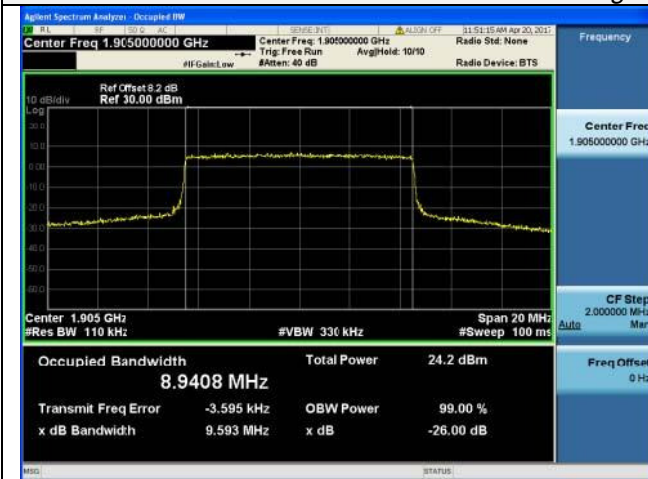

50RB#0



50RB#0

LTE FDD Band 2-15MHz Channel Bandwidth Occupied Bandwidth and Emission Bandwidth

QPSK

16QAM

Low Channel

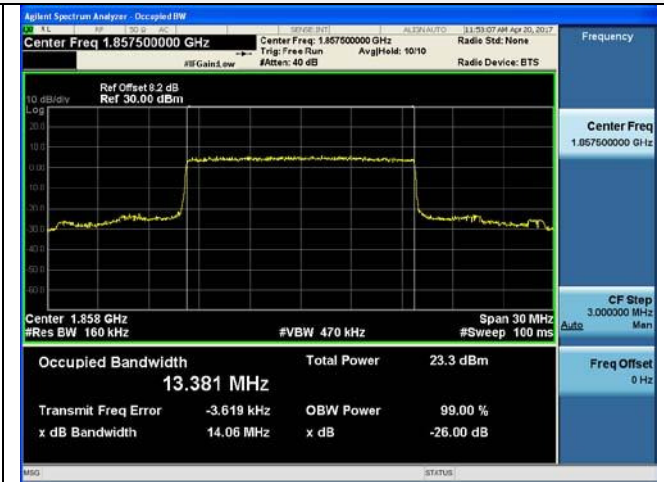
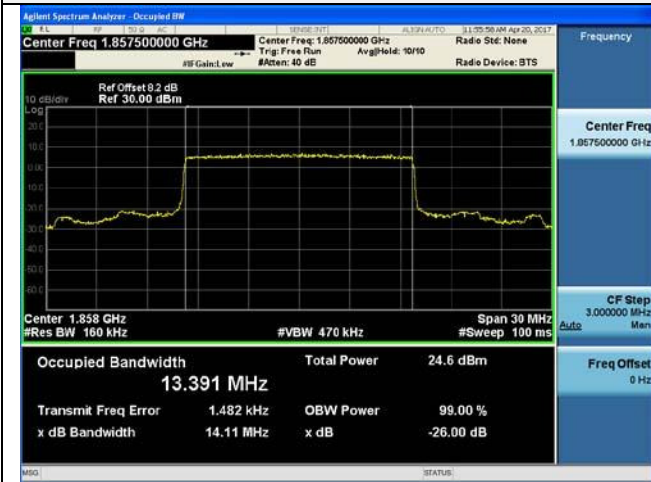

75RB#0

75RB#0

Middle Channel

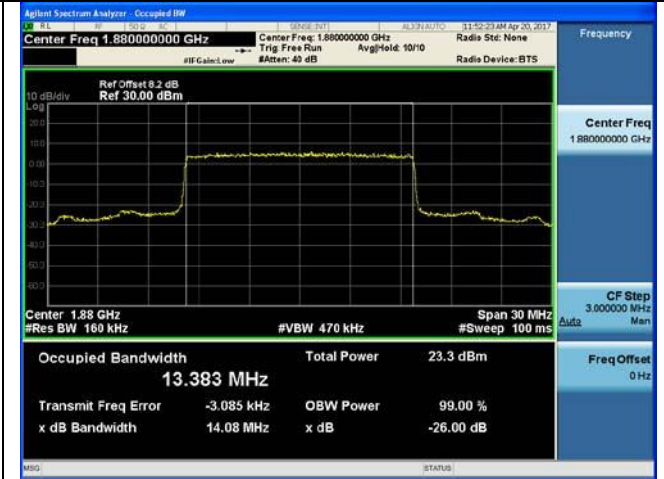
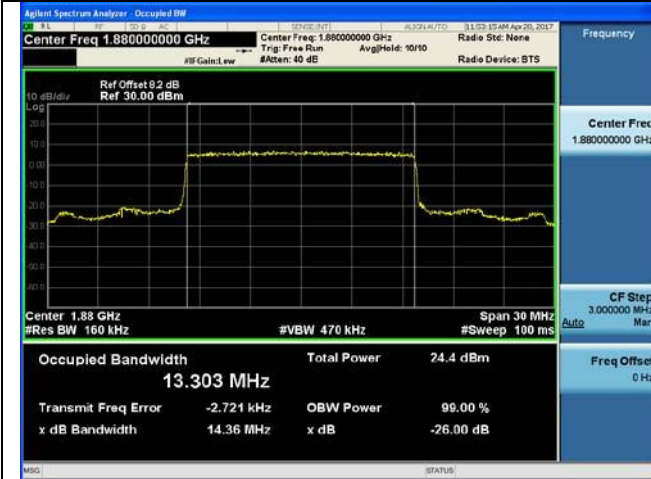

75RB#0

75RB#0

High Channel

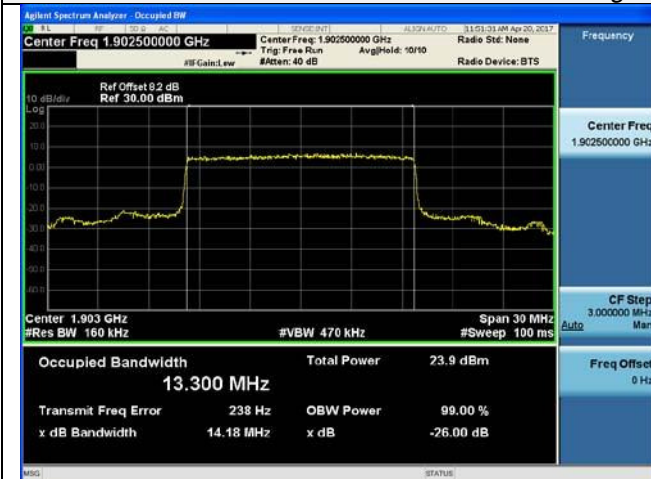

75RB#0

75RB#0



LTE FDD Band 2-20MHz Channel Bandwidth Occupied Bandwidth and Emission Bandwidth

QPSK

16QAM

Low Channel

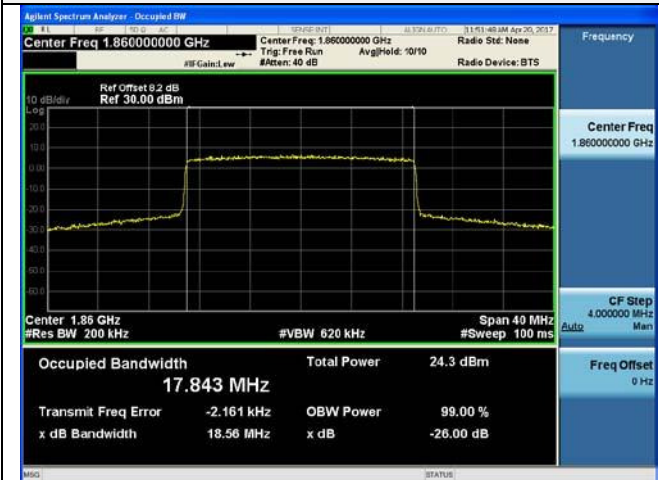

100RB#0

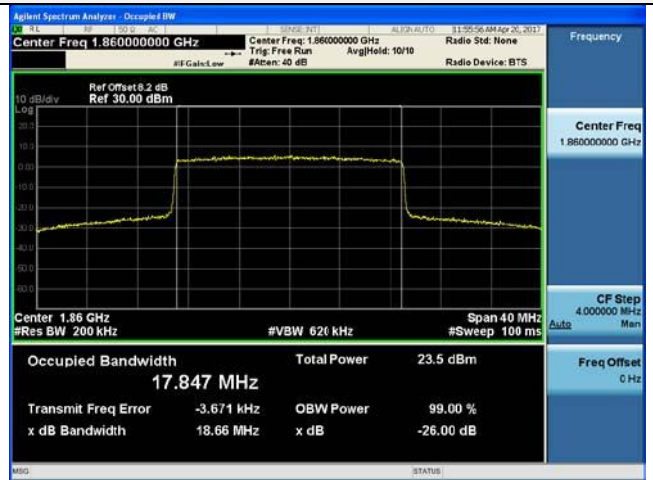

100RB#0

Middle Channel



100RB#0

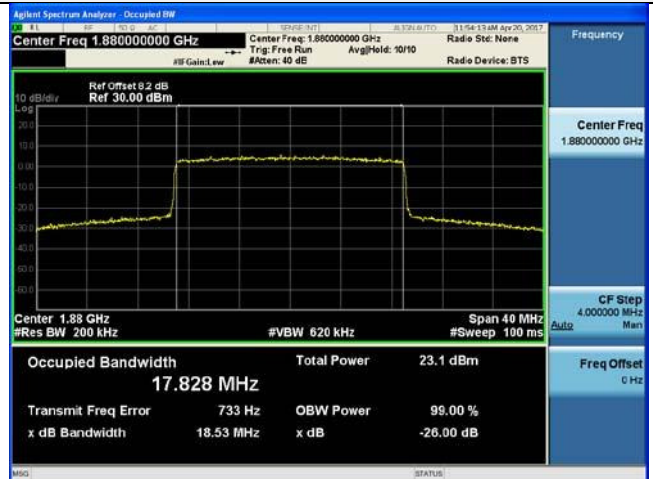

100RB#0

High Channel

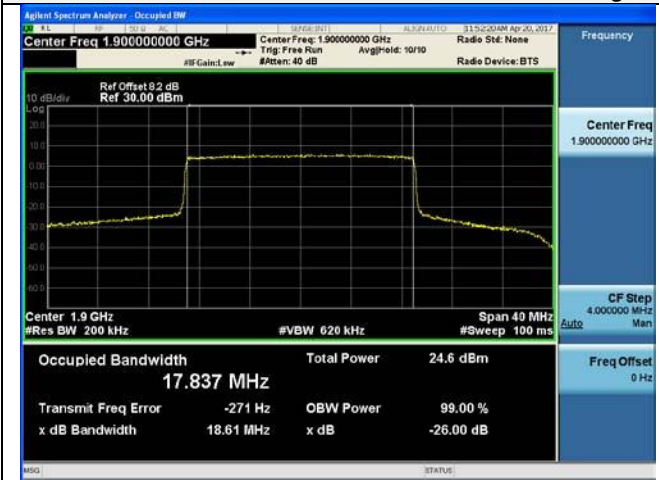

100RB#0



100RB#0

## 4.4 Band Edge compliance

### LIMIT

Per FCC §24.238 the power of any emission outside of the authorized operating frequency ranges must be attenuated below the transmitting power (P) by a factor of at least  $43 + 10\log(P)$  dB.

### TEST CONFIGURATION

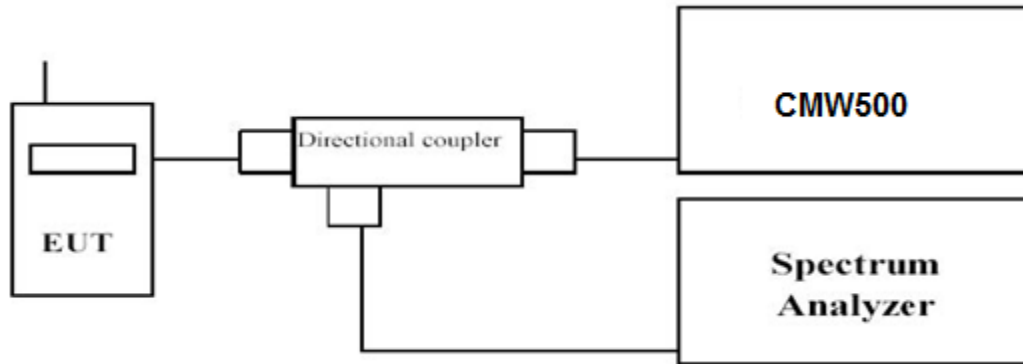

### TEST PROCEDURE

1. The transmitter output port was connected to base station.
2. The RF output of EUT was connected to the power meter by RF cable and attenuator, the path loss was compensated to the results for each measurement.
3. Set EUT at maximum power through base station.
4. Select lowest and highest channels for each band and different modulation.
5. Measure Band edge using RMS (Average) detector by spectrum

### TEST RESULTS

Remark: The EUT supports two SIM card SIM1 and SIM2. For GSM, the SIM 1 and SIM 2 both support GSM. For WCDMA/LTE, Only SIM 1 support WCDMA/LTE. We were tested all RB Configuration refer 3GPP TS136 521 for each Channel Bandwidth of LTE FDD Band 2; recorded worst case for each Channel Bandwidth of LTE FDD Band 2.

LTE FDD Band 2 – 1.4 MHz Channel Bandwidth Band Edge Compliance

QPSK

16QAM

Low Channel

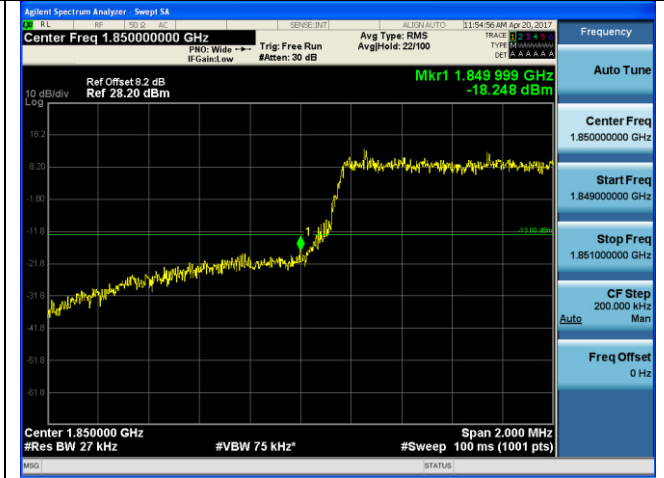
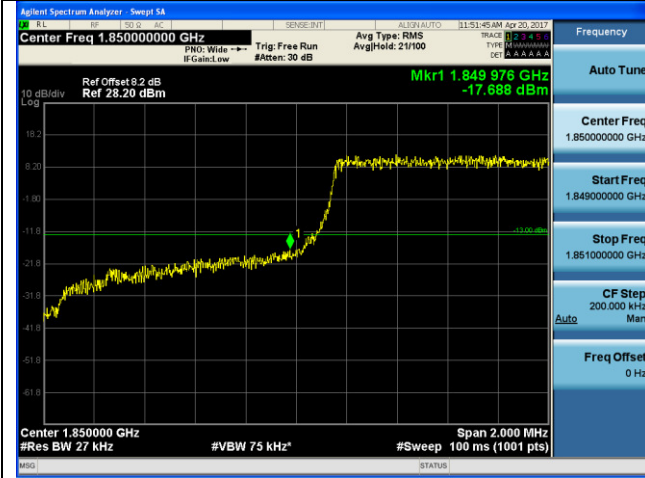

6RB#0

6RB#0

High Channel

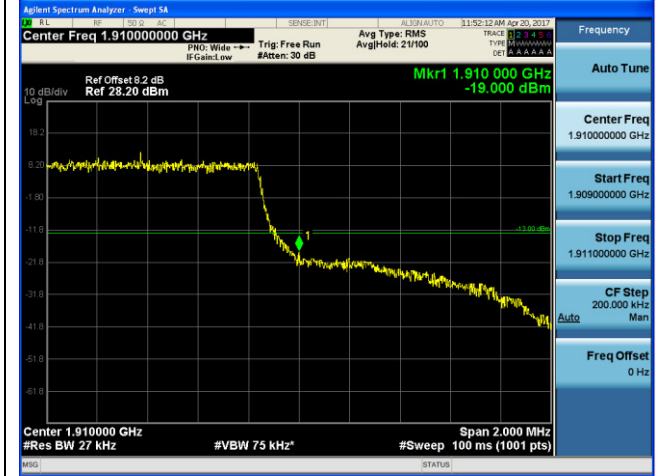
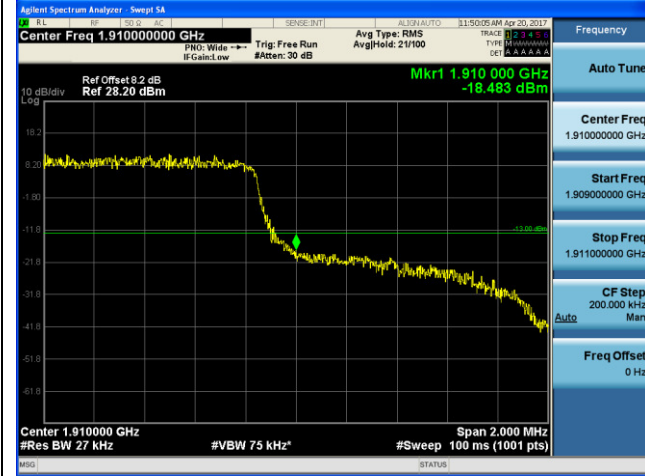

6RB#0

6RB#0

LTE FDD Band 2-3MHz Channel Bandwidth Band Edge Compliance

QPSK

16QAM

Low Channel

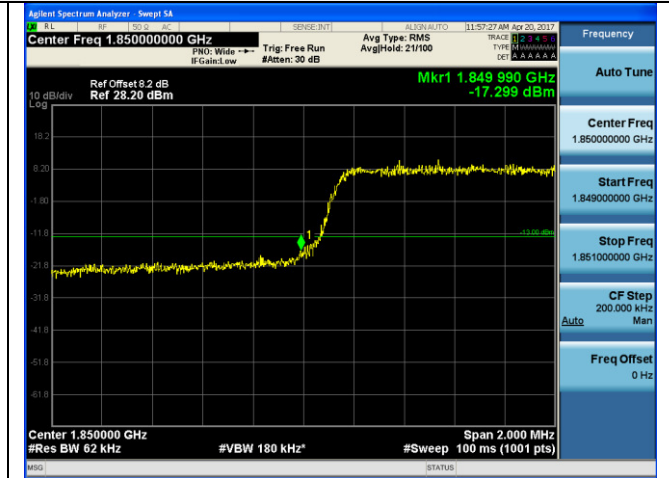
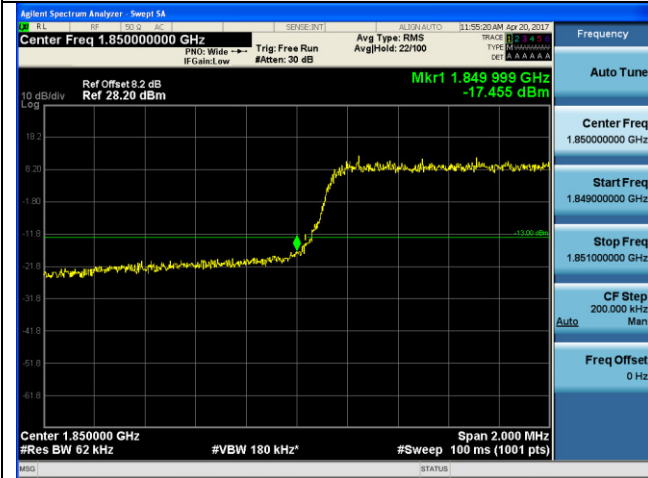

15RB#0

15RB#0

High Channel

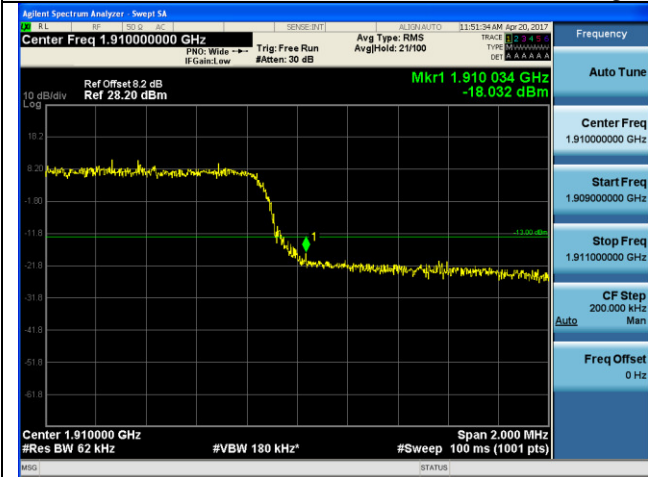

15RB#0

15RB#0

LTE FDD Band 2-5MHz Channel Bandwidth Band Edge Compliance

QPSK

16QAM

Low Channel

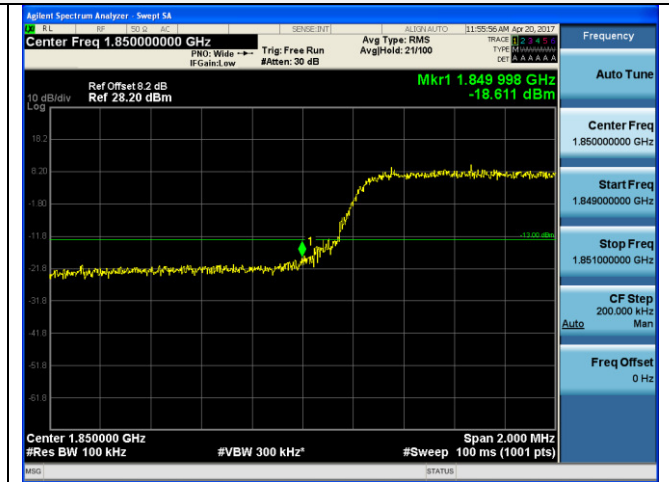

25RB#0

25RB#0

High Channel

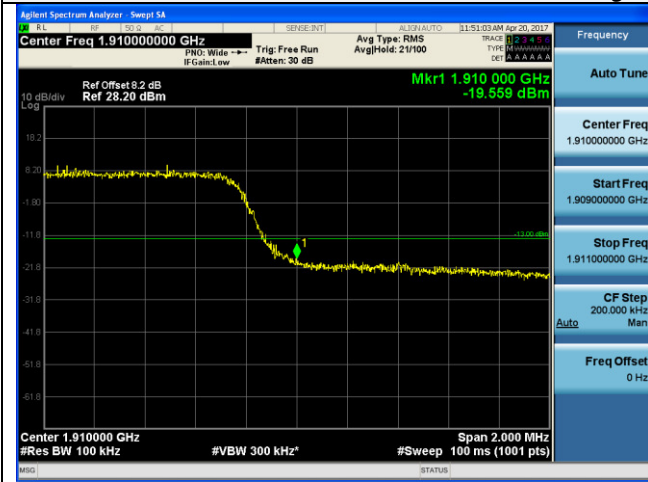

25RB#0

25RB#0

LTE FDD Band 2 – 10 MHz Channel Bandwidth Band Edge Compliance

QPSK

16QAM

Low Channel

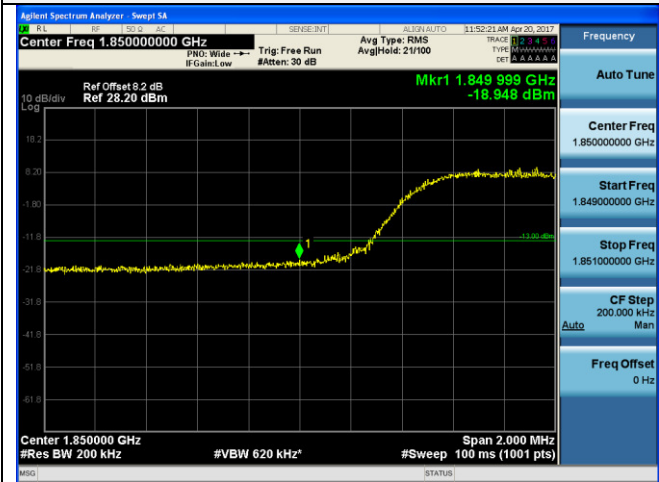

50RB#0



50RB#0

High Channel



50RB#0



50RB#0



LTE FDD Band 2–15MHz Channel Bandwidth Band Edge Compliance

QPSK

16QAM

Low Channel

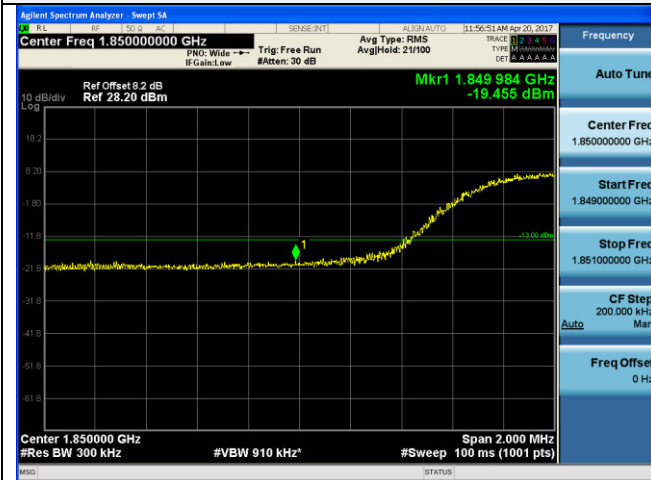

75RB#0

75RB#0

High Channel

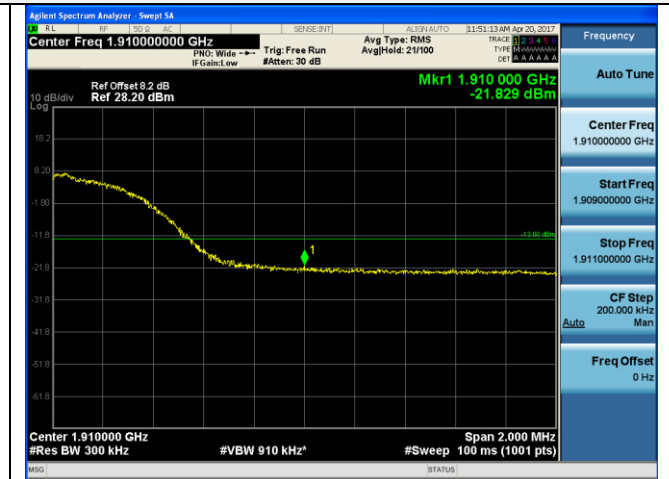
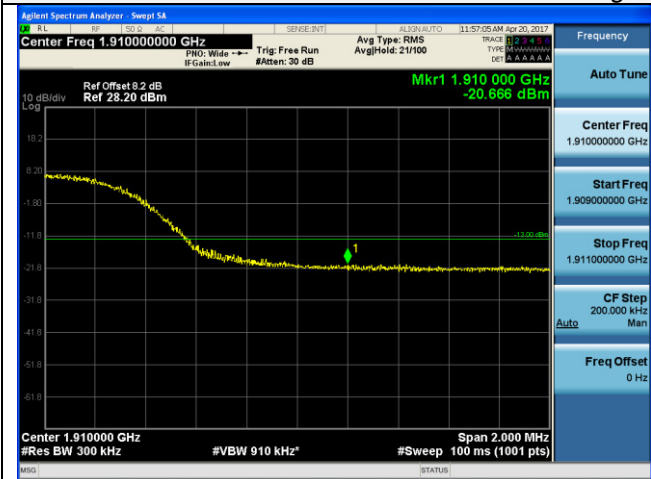

75RB#0

75RB#0

LTE FDD Band 2–20MHz Channel BandwidthBand Edge Compliance

QPSK

16QAM

Low Channel

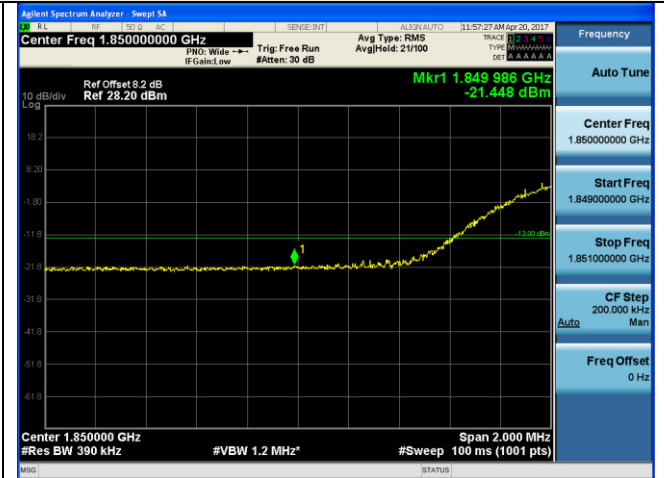
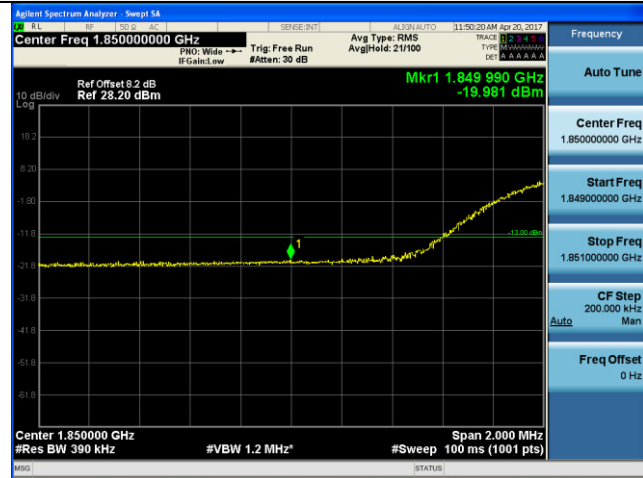

100RB#0

100RB#0

High Channel

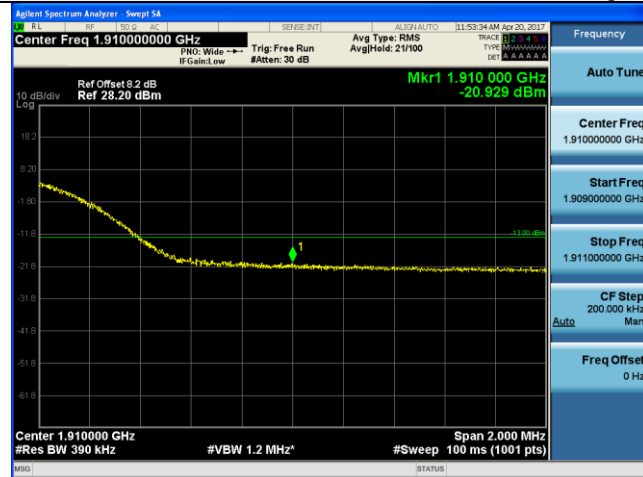

100RB#0

100RB#0



### 4.5 Spurious Emission on Antenna Port

#### LIMIT

Per FCC §24.238, the power of any emission outside of the authorized operating frequency ranges must be attenuated below the transmitting power (P) by a factor of at least  $43 + 10\log(P)$  dB.

#### TEST CONFIGURATION

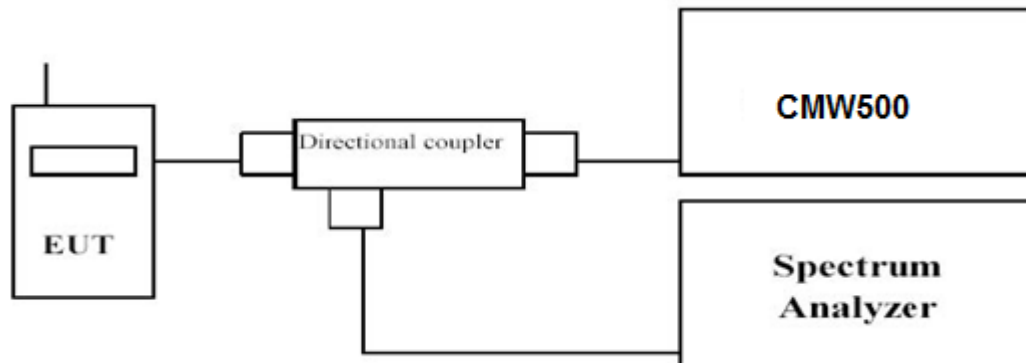

#### TEST PROCEDURE

The EUT was setup according to EIA/TIA 603D

- a. Place the EUT on a bench and set it in transmitting mode.
- b. Connect a low loss RF cable from the antenna port to a spectrum analyzer and CMW500 by a Directional Couple.
- c. EUT Communicate with CMW500, then select a channel for testing.
- d. Add a correction factor to the display of spectrum, and then test.
- e. The resolution bandwidth of the spectrum analyzer was set sufficient scans were taken to show the out of band Emission if any up to 10<sup>th</sup> harmonic.
- f. Please refer to following tables for test antenna conducted emissions.

Working Frequency	Sub range (GHz)	RBW	VBW	Sweep time (s)
LTE FDD Band 2	0.000009~0.000015	1KHz	3KHz	Auto
	0.000015~0.03	10KHz	30KHz	Auto
	0.03~4	1 MHz	3 MHz	Auto
	4~26	1 MHz	3 MHz	Auto

#### TEST RESULTS

Remark: The EUT supports two SIM card SIM1 and SIM2. For GSM, the SIM 1 and SIM 2 both support GSM. For WCDMA/LTE, Only SIM 1 support WCDMA/LTE. We were tested all RB Configuration refer 3GPP TS136 521 for each Channel Bandwidth of LTE FDD Band 2; recorded worst case for each Channel Bandwidth of LTE FDD Band 2.

LTE FDD Band 2-1.4MHz Channel Bandwidth

Low Channel

QPSK

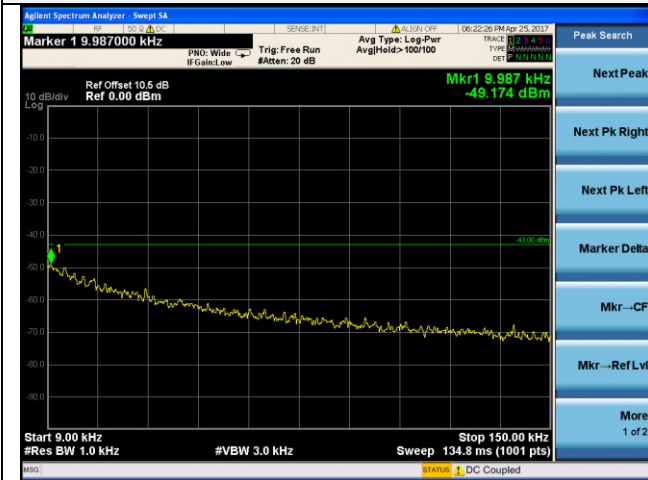

9KHz~150KHz

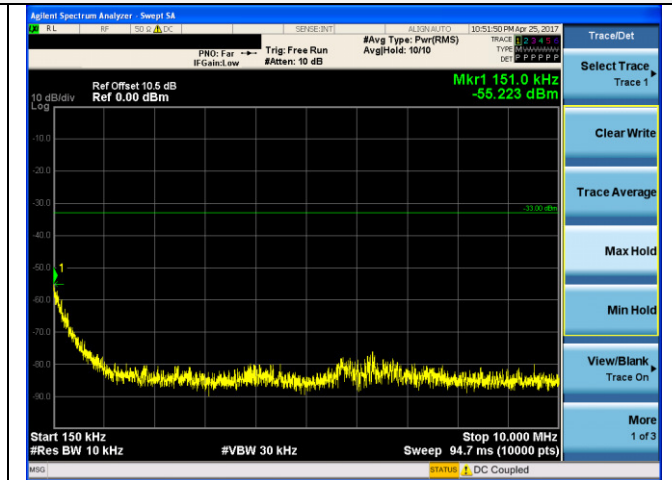

150KHz~10MHz

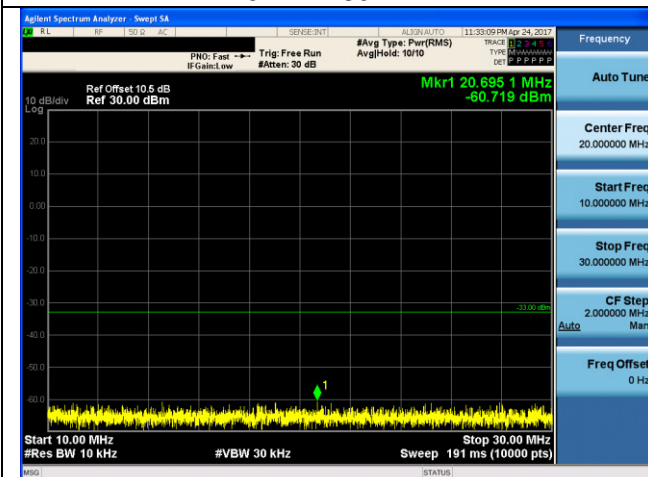

10MHz~30MHz

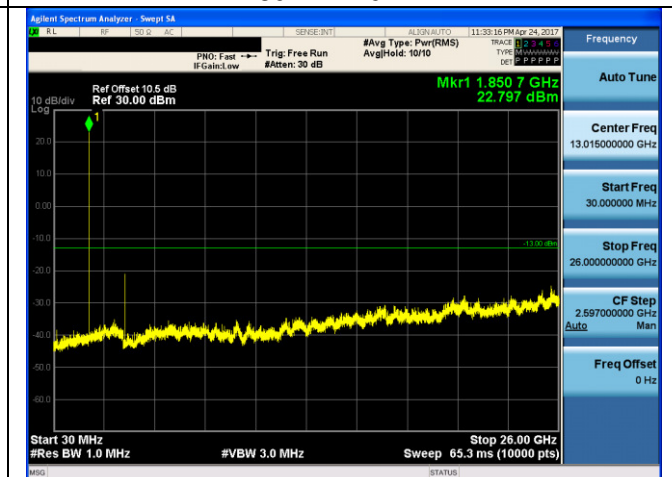

30MHz ~26 GHz

LTE FDD Band 2-1.4MHz Channel Bandwidth  
Middle Channel  
QPSK

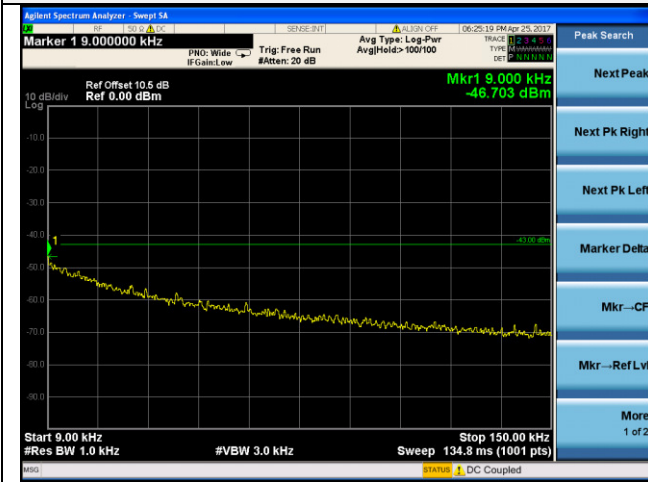

9KHz~150KHz

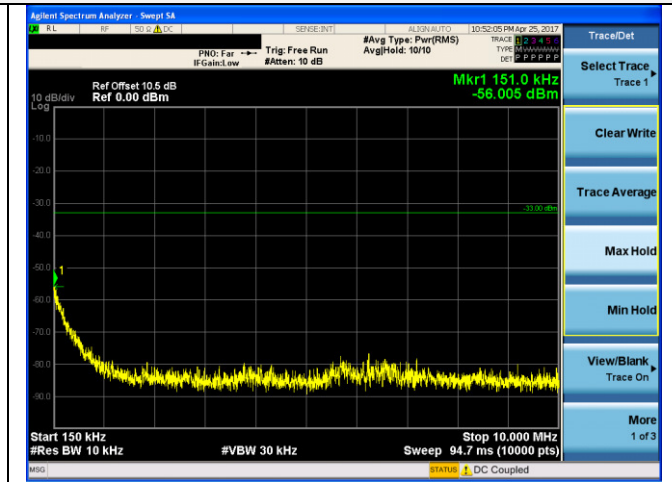

150KHz~10MHz

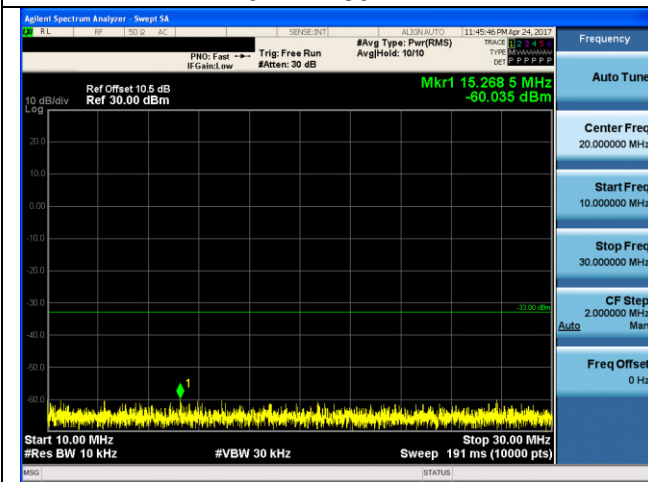

10MHz~30MHz

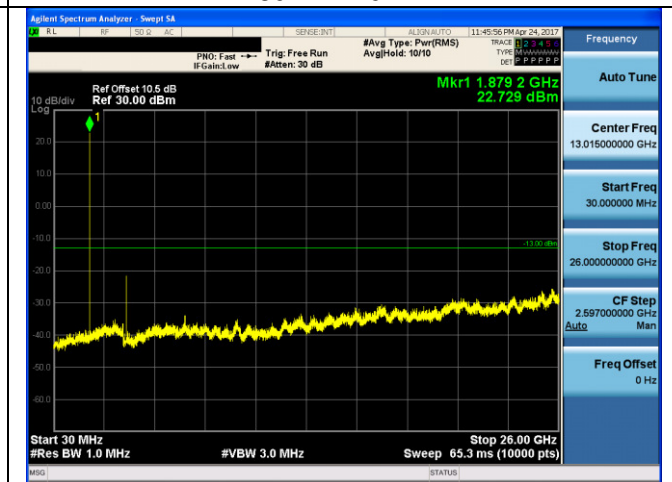

30MHz ~26 GHz

LTE FDD Band 2-1.4MHz Channel Bandwidth  
High Channel  
QPSK

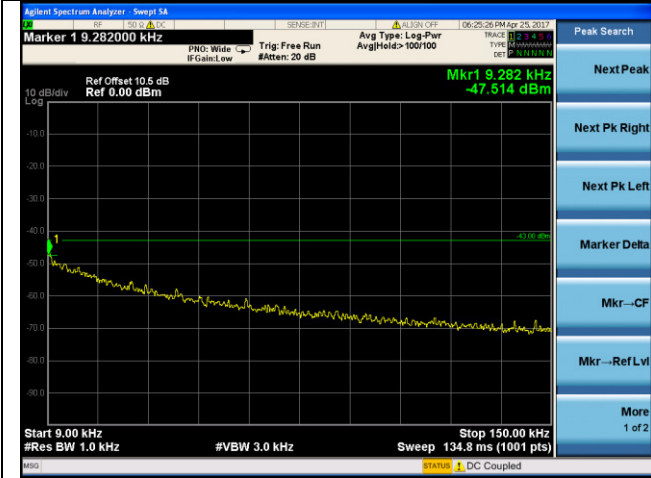

9KHz~150KHz

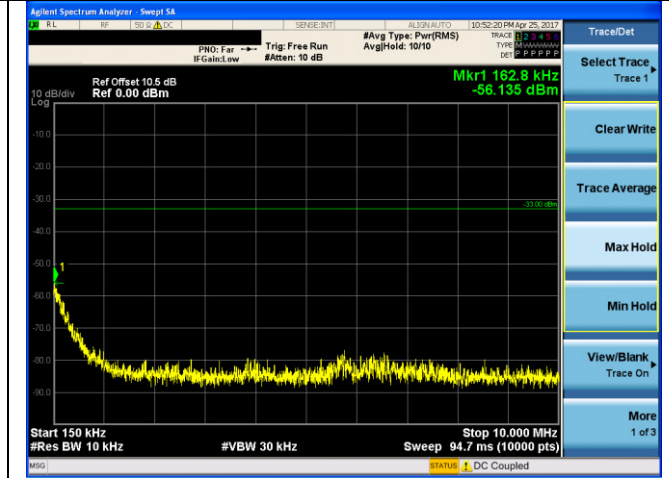

150KHz~10MHz

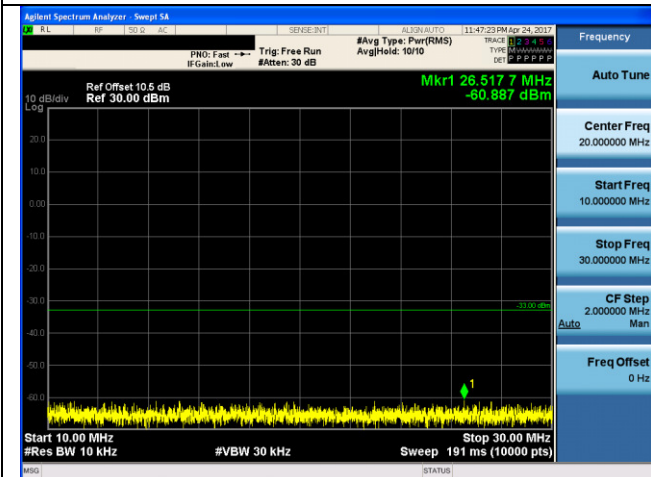

10MHz~30MHz

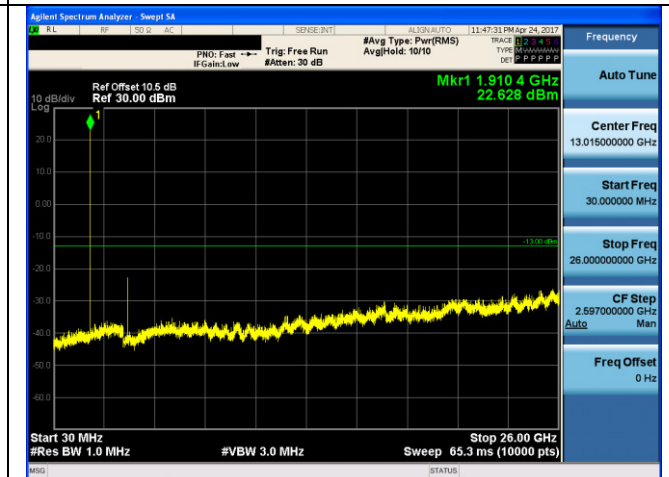

30MHz ~26 GHz