



Shenzhen Global Test Service Co.,Ltd.

1F, Building No. 13A, Zhonghaixin Science and Technology City, No.12,6 Road, Ganli Industrial Park, Buji Street, Longgang District, Shenzhen, Guangdong

FCC PART 22/24 TEST REPORT

FCC Part 22 /Part 24

Report Reference No.....: GTSR17042018-GSM

FCC ID.....: RQQHLT-ORBITUT

Compiled by
(position+printed name+signature)..: File administrators Jimmy Wang

Jimmy Wang

Supervised by
(position+printed name+signature)..: Test Engineer Peter Xiao

Peter Xiao

Approved by
(position+printed name+signature)..: Manager Sam Wang

Sam Wang

Date of issue.....: April. 28, 2017

Representative Laboratory Name .: Shenzhen Global Test Service Co.,Ltd.

Address: 1F, Building No. 13A, Zhonghaixin Science and Technology City, No.12,6 Road, Ganli Industrial Park, Buji Street, Longgang District, Shenzhen, Guangdong

Applicant's name.....: HYUNDAI CORPORATION

Address: 25,Yulgok-ro 2-Gil, Jongno-gu, Seoul, South Korea

Test specification

Standard.....: **FCC Part 22: PUBLIC MOBILE SERVICES**

FCC Part 24: PERSONAL COMMUNICATIONS SERVICES

Shenzhen Global Test Service Co.,Ltd. All rights reserved.

This publication may be reproduced in whole or in part for non-commercial purposes as long as the Shenzhen Global Test Service Co.,Ltd. is acknowledged as copyright owner and source of the material. Shenzhen Global Test Service Co.,Ltd. takes no responsibility for and will not assume liability for damages resulting from the reader's interpretation of the reproduced material due to its placement and context.

Test item description Mobile Phone

Trade Mark: HYUNDAI

Manufacturer.....: Shenzhen Rainbow Time Technology Co.,Ltd

Model/Type reference.....: ORBIT

Listed Models: /

Ratings: DC 3.80V

Modulation: GMSK

GPRS.....: Supported

Hardware version: V1_02_C00SEA

Software version: V1.0

Frequency.....: GSM 850MHz; PCS 1900MHz;

Result.....: **PASS**

TEST REPORT

Test Report No. :	GTSR17042018-GSM	April. 28, 2017
		Date of issue

Equipment under Test : Mobile Phone

Model /Type : ORBIT

Listed Models : /

Applicant : **HYUNDAI CORPORATION**

Address : 25,Yulgok-ro 2-Gil, Jongno-gu, Seoul, South Korea

Manufacturer : **Shenzhen Rainbow Time Technology Co.,Ltd**

Address : Room 905, ChangHong Technology Building, Science and Technology Park, Nanshan District, Shenzhen, China

Test Result:	PASS
---------------------	-------------

The test report merely corresponds to the test sample.
 It is not permitted to copy extracts of these test result without the written permission of the test laboratory.

Contents

<u>1</u>	<u>TEST STANDARDS</u>	<u>4</u>
<u>2</u>	<u>SUMMARY</u>	<u>5</u>
2.1	General Remarks	5
2.2	Product Description	5
2.3	Equipment under Test	5
2.4	Short description of the Equipment under Test (EUT)	6
2.5	EUT configuration	6
2.6	Related Submittal(s) / Grant (s)	6
2.7	Modifications	6
2.8	General Test Conditions/Configurations	6
<u>3</u>	<u>TEST ENVIRONMENT</u>	<u>7</u>
3.1	Address of the test laboratory	7
3.2	Test Facility	7
3.3	Environmental conditions	7
3.4	Test Description	8
3.5	Equipments Used during the Test	9
<u>4</u>	<u>TEST CONDITIONS AND RESULTS.....</u>	<u>10</u>
4.1	Output Power	10
4.2	Radiated Spurious Emission	14
4.3	Occupied Bandwidth and Emission Bandwidth	18
4.4	Band Edge Compliance	22
4.5	Spurious Emission on Antenna Port	25
4.6	Frequency Stability Test	34
4.7	Peak-to-Average Ratio (PAR)	37
<u>5</u>	<u>TEST SETUP PHOTOS OF THE EUT</u>	<u>40</u>
<u>6</u>	<u>EXTERNAL AND INTERNAL PHOTOS OF THE EUT</u>	<u>40</u>

1 TEST STANDARDS

The tests were performed according to following standards:

[FCC Part 22 \(10-1-12 Edition\)](#): PRIVATE LAND MOBILE RADIO SERVICES.

[FCC Part 24\(10-1-12 Edition\)](#): PUBLIC MOBILE SERVICES

[TIA/EIA 603 D June 2010](#): Land Mobile FM or PM Communications Equipment Measurement and Performance Standards.

2 SUMMARY

2.1 General Remarks

Date of receipt of test sample	:	April. 05, 2017
Testing commenced on	:	April. 05, 2017
Testing concluded on	:	April. 28, 2017

2.2 Product Description

Product Name:	Mobile Phone
Model/Type reference:	ORBIT
List Model:	/
Power supply:	DC 3.80V
Adapter Information	Model: Y-5204B-2A Input: AC100-240V~50/60Hz 0.3A Output:DC5V/2000mA
Modulation Type	GMSK
Antenna Type	Internal antenna
GSM/EDGE/GPRS	Supported GSM/GPRS/EDGE 8-PSK for EDGE only downlink
GSM/GPRS Power Class	GSM850:Power Class 4/ PCS1900:Power Class 1
GSM/GPRS Operation Frequency	GSM850 :824.2MHz-848.8MHz/PCS1900:1850.2MHz-1909.8MHz
GPRS Operation Frequency Band	GPRS850/GPRS1900
GPRS Multislot Class	Multi-slot Class 12
EGPRS Multislot Class	Multi-slot Class 12
Extreme temp. Tolerance	-30°C to +50°C
GPRS operation mode	Class B
Antenna gain:	GSM850: -0.85dbi,DCS1900: -1.07dbi

2.3 Equipment under Test

Power supply system utilised

Power supply voltage	:	<input type="radio"/> 120V / 60 Hz	<input type="radio"/> 230V / 50Hz
		<input type="radio"/> 12 V DC	<input type="radio"/> 24 V DC
		<input checked="" type="radio"/> Other (specified in blank below)	

DC3.80V

Test frequency list

Test Mode	TX/RX	RF Channel		
		Low(L)	Middle (M)	High (H)
GSM 850	TX	Channel 128	Channel 190	Channel 251
		824.2 MHz	836.6 MHz	848.8 MHz
	RX	Channel 128	Channel 190	Channel 251
		869.2 MHz	881.6 MHz	893.8 MHz
Test Mode	TX/RX	RF Channel		
GSM 1900	TX	Channel 512	Channel 661	Channel 810
		1850.2 MHz	1880.0 MHz	1909.8 MHz
	RX	Channel 512	Channel 661	Channel 810
		1930.2 MHz	1960.0 MHz	1989.8 MHz

2.4 Short description of the Equipment under Test (EUT)

This is a Mobile Phone.

For more details, refer to the user’s manual of the EUT.

2.5 EUT configuration

The following peripheral devices and interface cables were connected during the measurement:

● - supplied by the manufacturer

○ - supplied by the lab

○ /	M/N : /
	Manufacturer: /

2.6 Related Submittal(s) / Grant (s)

This submittal(s) (test report) is intended for **FCC ID: RQQLT-ORBITUT** filing to comply with FCC Part 22 and Part 24 Rules.

2.7 Modifications

No modifications were implemented to meet testing criteria.

2.8 General Test Conditions/Configurations

2.8.1 Test Modes

NOTE: The test mode(s) are selected according to relevant radio technology specifications.

Test Mode 1	GSM
Test Mode 2	GPRS

2.8.2 Test Environment

Environment Parameter	Selected Values During Tests	
Relative Humidity	Ambient	
Temperature	TN	Ambient
Voltage	VL	3.40V
	VN	3.80V
	VH	4.20V

NOTE: VL=lower extreme test voltage VN=nominal voltage
 VH=upper extreme test voltage TN=normal temperature

3 TEST ENVIRONMENT

3.1 Address of the test laboratory

Shenzhen Global Test Service Co.,Ltd.

1F, Building No. 13A, Zhonghaixin Science and Technology City, No.12,6 Road, Ganli Industrial Park, Buji Street, Longgang District, Shenzhen, Guangdong

Shenzhen CTL Testing Technology Co., Ltd.

1/F.-A, Baisha Technology Park, No.3011, Shahexi Road, Nanshan District, Shenzhen, Guangdong, China

3.2 Test Facility

The test facility is recognized, certified, or accredited by the following organizations:

FCC-Registration No.: 964637

Shenzhen Global Test Service Co.,Ltd EMC Laboratory has been registered and fully described in a report filed with the (FCC) Federal Communications Commission. The acceptance letter from the FCC is maintained in our files. Registration 964637, Jul 24, 2015.

CNAS-Lab Code: L8169

Shenzhen Global Test Service Co.,Ltd. has been assessed and proved to be in compliance with CNAS-CL01 Accreditation Criteria for Testing and Calibration Laboratories (identical to ISO/IEC 17025: 2005 General Requirements) for the Competence of Testing and Calibration Laboratories. Date of Registration: Dec. 11, 2015. Valid time is until Dec. 10, 2018.

FCC-Registration No.: 970318

Shenzhen CTL Testing Technology Co., Ltd. EMC Laboratory has been registered and fully described in a report filed with the (FCC) Federal Communications Commission. The acceptance letter from the FCC is maintained in our files. Registration 970318, December 19, 2013.

3.3 Environmental conditions

During the measurement the environmental conditions were within the listed ranges:

Temperature:	15-35 ° C
Humidity:	30-60 %
Atmospheric pressure:	950-1050mbar

3.4 Test Description

3.4.1 Cellular Band (824-849MHz paired with 869-894MHz)

Test Item	FCC Rule No.	Requirements	Verdict
Effective(Isotropic) Radiated Output Power	§2.1046, §22.913	FCC: ERP \leq 7W.	Pass
Modulation Characteristics	§2.1047	Digital modulation	N/A
Bandwidth	§2.1049	OBW: No limit. EBW: No limit.	Pass
Band Edges Compliance	§2.1051, §22.917	\leq -13dBm/1%*EBW, in 1MHz bands immediately outside and adjacent to The frequency block.	Pass
Spurious Emission at Antenna Terminals	§2.1051, §22.917	FCC: \leq -13dBm/100kHz, from 9kHz to 10th harmonics but outside authorized operating frequency ranges.	Pass
Field Strength of Spurious Radiation	§2.1053, §22.917	FCC: \leq -13dBm/100kHz.	Pass
Frequency Stability	§2.1055, §22.355	\leq \pm 2.5ppm.	Pass

NOTE 1: For the verdict, the "N/A" denotes "not applicable", the "N/T" de notes "not tested".

3.4.2 PCS Band (1850-1915MHz paired with 1930-1995MHz)

Test Item	FCC Rule No.	Requirements	Verdict
Effective(Isotropic) Radiated Output Power	§2.1046, §24.232	EIRP \leq 2W	Pass
Peak-Average Ratio	§2.1046, §24.232	FCC:Limit \leq 13dB	Pass
Modulation Characteristics	§2.1047	Digital modulation	N/A
Bandwidth	§2.1049	OBW: No limit. EBW: No limit.	Pass
Band Edges Compliance	§2.1051, §24.238	\leq -13dBm/1%*EBW, In 1MHz bands immediately outside and adjacent to The frequency block.	Pass
Spurious Emission at Antenna Terminals	§2.1051, §24.238	\leq -13dBm/1MHz, from 9kHz to10th harmonics but outside authorized Operating frequency ranges.	Pass
Field Strength of Spurious Radiation	§2.1053, §24.238	\leq -13dBm/1MHz.	Pass
Frequency Stability	§2.1055, §24.235	FCC: within authorized frequency block.	Pass

NOTE 1: For the verdict, the "N/A" denotes "not applicable", the "N/T" de notes "not tested".

Remark:

1. The measurement uncertainty is not included in the test result.

3.5 Equipments Used during the Test

Test Equipment	Manufacturer	Model No.	Serial No.	Calibration Date	Calibration Due Date
Bilog Antenna	Sunol Sciences Corp.	JB1	A061713	2016/06/02	2017/06/01
Bilog Antenna	Sunol Sciences Corp.	JB1	A061719	2016/06/02	2017/06/01
EMI Test Receiver	R&S	ESCI	101102	2016/06/26	2017/06/25
Spectrum Analyzer	Agilent	N9020A	MY48010425	2016/06/17	2017/06/16
Controller	EM Electronics	Controller EM 1000	N/A	2016/05/21	2017/05/20
Horn Antenna	Sunol Sciences Corp.	DRH-118	A062013	2016/05/19	2017/05/18
Horn Antenna	Sunol Sciences Corp.	DRH-118	A062014	2016/05/19	2017/05/18
Active Loop Antenna	SCHWARZBECK	FMZB1519	1519-037	2016/05/19	2017/05/18
Amplifier	Agilent	8349B	3008A02306	2016/05/19	2017/05/18
Amplifier	Agilent	8447D	2944A10176	2016/05/19	2017/05/18
Temperature/ Humidity Meter	Gangxing	CTH-608	02	2016/05/20	2017/05/19
High-Pass Filter	K&L	9SH10-2700/X12750-O/O	N/A	2016/05/20	2017/05/19
High-Pass Filter	K&L	41H10-1375/U12750-O/O	N/A	2016/05/20	2017/05/19
RF Cable	HUBER+SUHNER	RG214	N/A	2016/05/20	2017/05/19
Data acquisition card	Agilent	U2531A	TW53323507	2016/05/20	2017/05/19
Power Sensor	Agilent	U2021XA	MY5365004	2016/05/20	2017/05/19
Radio Communication Tester	R&S	CMU200	114353	2016/06/02	2017/06/01

Note: The Cal.Interval was one year.

4 TEST CONDITIONS AND RESULTS

4.1 Output Power

TEST APPLICABLE

During the process of testing, the EUT was controlled via R&S Digital Radio Communication tester (CMU200) to ensure max power transmission and proper modulation. This result contains output power and EIRP measurements for the EUT. In all cases, output power is within the specified limits.

4.1.1 Conducted Output Power

TEST CONFIGURATION

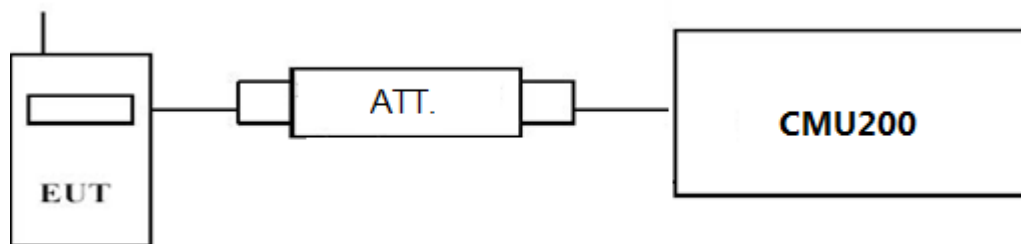

TEST PROCEDURE

Conducted Power Measurement:

- a) Place the EUT on a bench and set it in transmitting mode.
- b) Connect a low loss RF cable from the antenna port to a CMU200 by an Att.
- c) EUT Communicate with CMU200 then selects a channel for testing.
- d) Add a correction factor to the display CMU200, and then test.

TEST RESULTS

Remark: The EUT supports two SIM card SIM1 and SIM2. We tested two SIM and recorded the worst case at SIM1.

GSM 850		Burst Average Conducted power (dBm)		
		Channel/Frequency(MHz)		
		128/824.2	190/836.6	251/848.8
GSM		31.91	31.97	31.95
GPRS (GMSK)	1TX slot	31.94	31.99	32.97
	2TX slot	30.39	30.45	30.41
	3TX slot	28.25	28.31	28.29
	4TX slot	27.55	27.65	27.62
GSM 1900		Burst Average Conducted power (dBm)		
		Channel/Frequency(MHz)		
		512/1850.2	661/1880.0	810/1909.8
GSM		30.01	30.17	30.08
GPRS (GMSK)	1TX slot	29.95	30.09	30.02
	2TX slot	27.47	27.55	27.51
	3TX slot	26.32	26.42	26.37
	4TX slot	25.48	25.57	25.53

4.1.2 Radiated Output Power

TEST DESCRIPTION

This is the test for the maximum radiated power from the EUT.

Rule Part 24.232(c) specifies, "Mobile/portable stations are limited to 2 watts e.i.r.p. Peak power" and 24.232(e) specifies that "Peak transmit power must be measured over any interval of continuous transmission using instrumentation calibrated in terms of an rms-equivalent voltage." Rule Part 22.913(a) specifies "The ERP of mobile transmitters and auxiliary test transmitters must not exceed 7 Watts."

TEST CONFIGURATION

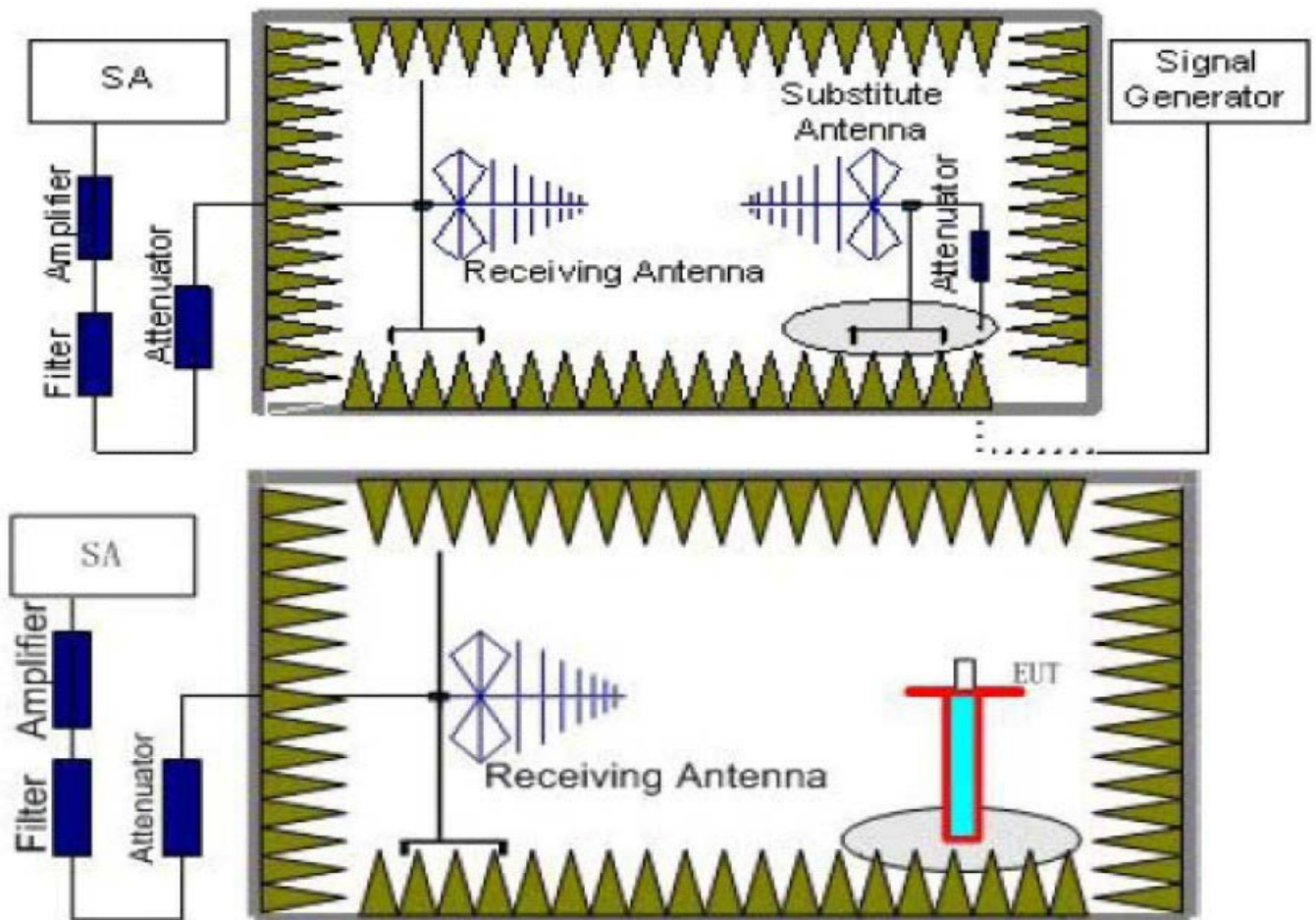

TEST PROCEDURE

1. EUT was placed on a 0.80 meter high non-conductive stand at a 3 meter test distance from the receive antenna. A receiving antenna was placed on the antenna mast 3 meters from the EUT for emission measurements. The height of receiving antenna is 0.80m. Detected emissions were maximized at each frequency by rotating the EUT through 360° and adjusting the receiving antenna polarization. The radiated emission measurements of all transmit frequencies in three channels (High, Middle, Low) were measured with peak detector.
2. A log-periodic antenna or double-ridged waveguide horn antenna shall be substituted in place of the EUT. The log-periodic antenna will be driven by a signal generator and the level will be adjusted till the same power value on the spectrum analyzer or receiver. The level of the spurious emissions can be calculated through the level of the signal generator, cable loss, the gain of the substitution antenna and the reading of the spectrum analyzer or receiver.
3. The EUT is then put into continuously transmitting mode at its maximum power level during the test. Set Test Receiver or Spectrum RBW=1MHz, VBW=3MHz, And the maximum value of the receiver should be recorded as (P_r).
4. The EUT shall be replaced by a substitution antenna. In the chamber, an substitution antenna for the frequency band of interest is placed at the reference point of the chamber. An RF Signal source for the frequency band of interest is connected to the substitution antenna with a cable that has been constructed to not interfere with the radiation pattern of the antenna. A power (P_{Mea}) is applied to the input of the

substitution antenna, and adjust the level of the signal generator output until the value of the receiver reach the previously recorded (P_r). The power of signal source (P_{Mea}) is recorded. The test should be performed by rotating the test item and adjusting the receiving antenna polarization.

5. A amplifier should be connected to the Signal Source output port. And the cable should be connect between the Amplifier and the Substitution Antenna. The cable loss (P_{cl}), the Substitution Antenna Gain (G_a) and the Amplifier Gain (P_{Ag}) should be recorded after test.

The measurement results are obtained as described below:

$$\text{Power(EIRP)} = P_{Mea} - P_{Ag} - P_{cl} + G_a$$

We used SMF100A microwave signal generator which signal level can up to 33dBm, so we not used power Amplifier for substitution test; The measurement results are amend as described below:

$$\text{Power(EIRP)} = P_{Mea} - P_{cl} + G_a$$

6. This value is EIRP since the measurement is calibrated using an antenna of known gain (2.15 dBi) and known input power.
7. ERP can be calculated from EIRP by subtracting the gain of the dipole, $ERP = EIRP - 2.15\text{dBi}$.

TEST LIMIT

According to 22.913(a) and 24.232(c), the ERP should be not exceed following table limits:

GSM850(GPRS850,EDGE850)		
Function	Power Step	Burst Peak ERP (dBm)
GSM	5	≤38.45dBm (7W)
GPRS	3	≤38.45dBm (7W)

PCS1900(GPRS1900,EDGE1900)		
Function	Power Step	Burst Peak EIRP (dBm)
GSM	0	≤33dBm (2W)
GPRS	3	≤33dBm (2W)

TEST RESULTS

Remark:

1. We were tested all Configuration refer 3GPP TS151 010.
2. $EIRP = P_{Mea}(\text{dBm}) - P_{cl}(\text{dB}) + P_{Ag}(\text{dB}) + G_a(\text{dBi})$
3. $ERP = EIRP - 2.15\text{dBi}$ as EIRP by subtracting the gain of the dipole.
4. We teted Horizontal and Vertical, and Recorded the worst data at the Vertical.
5. The EUT supports two SIM card SIM1 and SIM2. We tested two SIM and recorded the worst case at SIM1.

Test site: Shenzhen CTL Testing Technology Co., Ltd

GSM 850

Frequency (MHz)	P_{Mea} (dBm)	P_{cl} (dB)	G_a Antenna Gain(dB)	Correction (dB)	P_{Ag} (dB)	ERP (dBm)	Limit (dBm)	Margin (dB)	Polarization
824.20	-12.71	2.42	8.45	2.15	36.82	27.99	38.45	10.46	V
836.60	-12.46	2.46	8.45	2.15	36.82	28.20	38.45	10.25	V
848.80	-12.31	2.53	8.36	2.15	36.82	28.19	38.45	10.26	V

GSM 1900

Frequency (MHz)	P_{Mea} (dBm)	P_{cl} (dB)	G_a Antenna Gain(dB)	P_{Ag} (dB)	EIRP (dBm)	Limit (dBm)	Margin (dB)	Polarization
1850.20	-14.92	3.41	10.24	33.60	25.51	33.01	7.50	V
1880.00	-14.43	3.49	10.24	33.60	25.92	33.01	7.09	V
1909.80	-14.82	3.55	10.23	33.60	25.46	33.01	7.55	V

GPRS 850

Frequency (MHz)	P _{Mea} (dBm)	P _{cl} (dB)	G _a Antenna Gain(dB)	Correction (dB)	P _{Ag} (dB)	ERP (dBm)	Limit (dBm)	Margin (dB)	Polarization
824.20	-12.43	2.42	8.45	2.15	36.82	28.27	38.45	10.18	V
836.60	-12.17	2.46	8.45	2.15	36.82	28.49	38.45	9.96	V
848.80	-12.21	2.53	8.36	2.15	36.82	28.29	38.45	10.16	V

GPRS 1900

Frequency (MHz)	P _{Mea} (dBm)	P _{cl} (dB)	G _a Antenna Gain(dB)	P _{Ag} (dB)	EIRP (dBm)	Limit (dBm)	Margin (dB)	Polarization
1850.20	-14.74	3.41	10.24	33.60	25.69	33.01	7.32	V
1880.00	-14.36	3.49	10.24	33.60	25.99	33.01	7.02	V
1909.80	-14.68	3.55	10.23	33.60	25.60	33.01	7.41	V

4.2 Radiated Spurious Emission

TEST APPLICABLE

According to the TIA/EIA 603D:2010 test method, The Receiver or Spectrum was scanned from 30 MHz to the 10th harmonic of the highest frequency generated within the equipment, which is the transmitted carrier that can be as high as 1910 MHz. The resolution bandwidth is set as outlined in Part 24.238 and Part 22.917. The spectrum is scanned with the mobile station transmitting at carrier frequencies that pertain to low, mid and high channels of PCS1900 and GSM850.

TEST CONFIGURATION

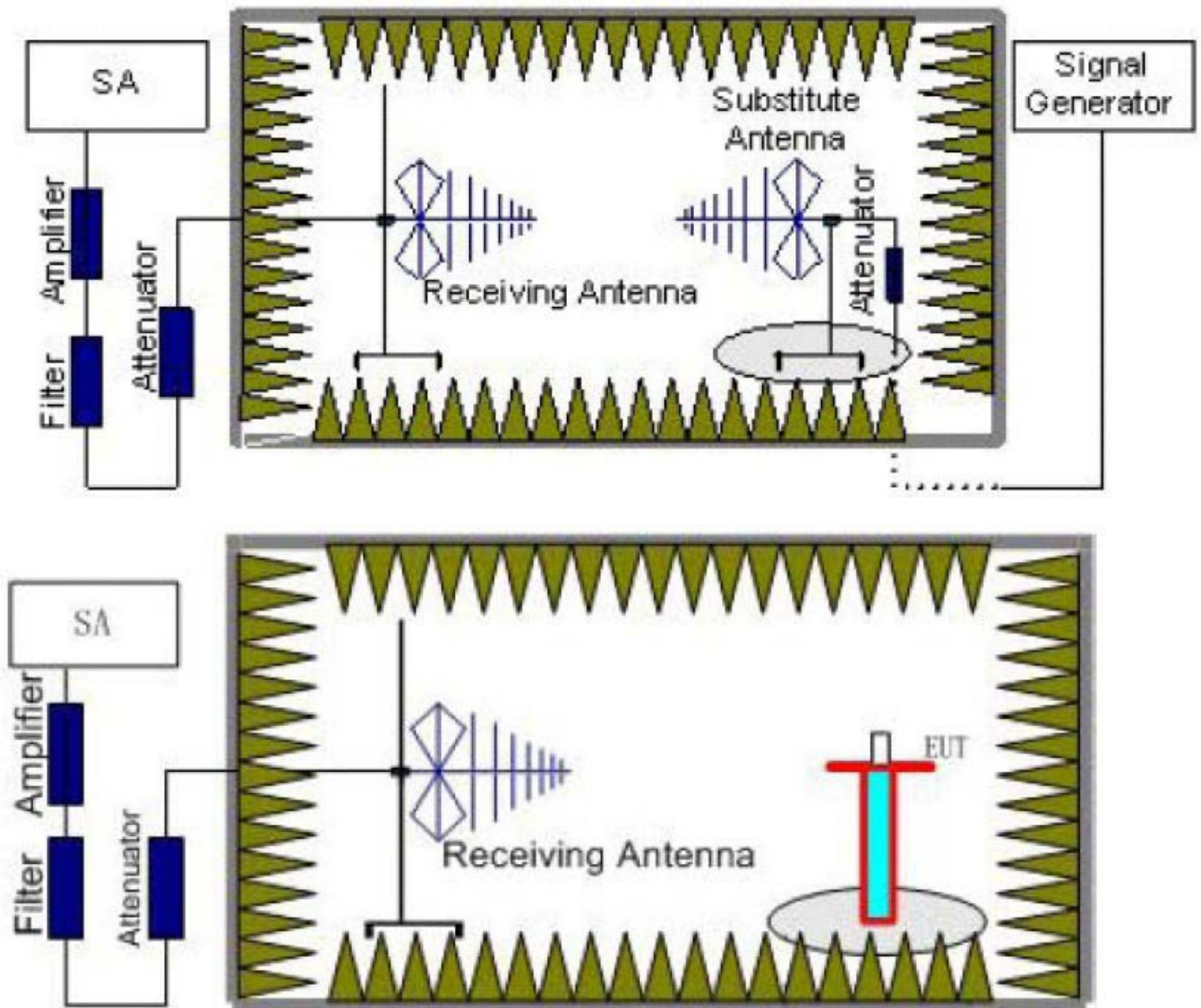

TEST PROCEDURE

1. EUT was placed on a 0.80 meter high non-conductive stand at a 3 meter test distance from the receive antenna. A receiving antenna was placed on the antenna mast 3 meters from the EUT for emission measurements. The height of receiving antenna is 0.80m. Detected emissions were maximized at each frequency by rotating the EUT through 360° and adjusting the receiving antenna polarization. The radiated emission measurements of all transmit frequencies in three channels (High, Middle, Low) were measured with peak detector.
2. A log-periodic antenna or double-ridged waveguide horn antenna shall be substituted in place of the EUT. The log-periodic antenna will be driven by a signal generator and the level will be adjusted till the same power value on the spectrum analyzer or receiver. The level of the spurious emissions can be calculated

through the level of the signal generator, cable loss, the gain of the substitution antenna and the reading of the spectrum analyzer or receiver.

3. The EUT is then put into continuously transmitting mode at its maximum power level during the test. Set Test Receiver or Spectrum RBW=1MHz,VBW=3MHz, And the maximum value of the receiver should be recorded as (P_r).
4. The EUT shall be replaced by a substitution antenna. In the chamber, an substitution antenna for the frequency band of interest is placed at the reference point of the chamber. An RF Signal source for the frequency band of interest is connected to the substitution antenna with a cable that has been constructed to not interfere with the radiation pattern of the antenna. A power (P_{Mea}) is applied to the input of the substitution antenna, and adjust the level of the signal generator output until the value of the receiver reach the previously recorded (P_r). The power of signal source (P_{Mea}) is recorded. The test should be performed by rotating the test item and adjusting the receiving antenna polarization.
5. A amplifier should be connected to the Signal Source output port. And the cable should be connect between the Amplifier and the Substitution Antenna. The cable loss (P_{cl}) ,the Substitution Antenna Gain (G_a) and the Amplifier Gain (P_{Ag}) should be recorded after test.
The measurement results are obtained as described below:
Power(EIRP)=P_{Mea}- P_{Ag} - P_{cl} + G_a
6. This value is EIRP since the measurement is calibrated using an antenna of known gain (2.15 dBi) and known input power.
7. ERP can be calculated from EIRP by subtracting the gain of the dipole, ERP = EIRP -2.15dBi.
8. In order to make sure test results more clearly,we set frequency range and sweep time for difference frequency range as follows table:

Working Frequency	Subrange (GHz)	RBW	VBW	Sweep time (s)
GSM 850	0.00009~0.15	1KHz	3KHz	30
	0.00015~0.03	10KHz	30KHz	10
	0.03~1	100KHz	300KHz	10
	1~2	1 MHz	3 MHz	2
	2~5	1 MHz	3 MHz	3
	5~8	1 MHz	3 MHz	3
	8~10	1 MHz	3 MHz	3
PCS 1900	0.00009~0.15	1KHz	3KHz	30
	0.00015~0.03	10KHz	30KHz	10
	0.03~1	100KHz	300KHz	10
	1~2	1 MHz	3 MHz	2
	2~5	1 MHz	3 MHz	3
	5~8	1 MHz	3 MHz	3
	8~11	1 MHz	3 MHz	3
	11~14	1 MHz	3 MHz	3
	14~18	1 MHz	3 MHz	3
18~20	1 MHz	3 MHz	2	

TEST LIMITS

According to 24.238 and 22.917 specify that the power of any emission outside of the authorized operating frequency ranges must be attenuated below the transmitting power (P) by a factor of at least 43 + 10 log(P) dB.

The specification that emissions shall be attenuated below the transmitter power (P) by at least 43 + 10 log (P) dB, translates in the relevant power range (1 to 0.001 W) to -13 dBm. At 1 W the specified minimum attenuation becomes 43 dB and relative to a 30 dBm (1 W) carrier becomes a limit of -13 dBm. At 0.001 W (0 dBm) the minimum attenuation is 13 dB, which again yields a limit of -13 dBm. In this way a translation of the specification from relative to absolute terms is carried out.

Frequency	Channel	Frequency Range	Verdict
GSM 850	Low	9KHz-10GHz	PASS
	Middle	9KHz -10GHz	PASS
	High	9KHz -10GHz	PASS
GSM 1900	Low	9KHz -20GHz	PASS
	Middle	9KHz -20GHz	PASS
	High	9KHz -20GHz	PASS

TEST RESULTS

Remark:

1. We were tested all refer 3GPP TS151 010.
2. $EIRP = P_{Mea}(dBm) - P_{cl}(dB) + G_a(dBi)$
3. We were not recorded other points as values lower than limits.
4. Margin = Limit – EIRP
5. The EUT supports two SIM card SIM1 and SIM2. We tested two SIM and recorded the worst case at SIM1.
6. We tested GSM and GPRS Mode, and recorded the worst case at the GSM Mode.

Test site: Shenzhen CTL Testing Technology Co., Ltd

GSM 850_Low Channel

Frequency (MHz)	P _{Mea} (dBm)	P _{cl} (dB)	Diatance	Ga Antenna Gain(dB)	Peak EIRP (dBm)	Limit (dBm)	Margin (dB)	Polarization
1648.4	-30.92	3.00	3.00	9.58	-24.34	-13.00	11.34	H
2472.6	-36.51	3.03	3.00	10.72	-28.82	-13.00	15.82	H
1648.4	-29.71	3.00	3.00	9.68	-23.03	-13.00	10.03	V
2472.6	-38.01	3.03	3.00	10.72	-30.32	-13.00	17.32	V

GSM 850_Middle Channel

Frequency (MHz)	P _{Mea} (dBm)	P _{cl} (dB)	Diatance	Ga Antenna Gain(dB)	EIRP (dBm)	Limit (dBm)	Margin (dB)	Polarization
1673.2	-29.94	3.00	3.00	9.58	-23.36	-13.00	10.36	H
2509.8	-38.24	3.03	3.00	10.72	-30.55	-13.00	17.55	H
1673.2	-31.07	3.00	3.00	9.68	-24.39	-13.00	11.39	V
2509.8	-37.61	3.03	3.00	10.72	-29.92	-13.00	16.92	V

GSM 850_High Channel

Frequency (MHz)	P _{Mea} (dBm)	P _{cl} (dB)	Diatance	Ga Antenna Gain(dB)	EIRP (dBm)	Limit (dBm)	Margin (dB)	Polarization
1697.6	-31.91	3.00	3.00	9.58	-25.33	-13.00	12.33	H
2546.4	-38.07	3.03	3.00	10.72	-30.38	-13.00	17.38	H
1697.6	-30.81	3.00	3.00	9.68	-24.13	-13.00	11.13	V
2546.4	-36.57	3.03	3.00	10.72	-28.88	-13.00	15.88	V

GSM 1900 Low Channel

Frequency (MHz)	P _{Mea} (dBm)	Pcl (dB)	Diatance	Ga Antenna Gain(dB)	Peak EIRP (dBm)	Limit (dBm)	Margin (dB)	Polarization
3700.4	-37.27	4.39	3.00	12.34	-29.32	-13.00	16.32	H
5550.6	-41.16	5.31	3.00	13.52	-32.95	-13.00	19.95	H
3700.4	-35.21	4.39	3.00	12.34	-27.26	-13.00	14.26	V
5550.6	-42.46	5.31	3.00	13.52	-34.25	-13.00	21.25	V

GSM 1900 Middle Channel

Frequency (MHz)	P _{Mea} (dBm)	Pcl (dB)	Diatance	Ga Antenna Gain(dB)	EIRP (dBm)	Limit (dBm)	Margin (dB)	Polarization
3760.0	-36.93	4.41	3.00	12.34	-29.00	-13.00	16.00	H
5640.0	-40.80	5.38	3.00	13.58	-32.60	-13.00	19.60	H
3760.0	-37.79	4.41	3.00	12.34	-29.86	-13.00	16.86	V
5640.0	-39.45	5.38	3.00	13.58	-31.25	-13.00	18.25	V

GSM 1900 High Channel

Frequency (MHz)	P _{Mea} (dBm)	Pcl (dB)	Diatance	Ga Antenna Gain(dB)	EIRP (dBm)	Limit (dBm)	Margin (dB)	Polarization
3819.6	-36.02	4.45	3.00	12.45	-28.02	-13.00	15.02	H
5729.4	-40.42	5.47	3.00	13.66	-32.23	-13.00	19.23	H
3819.6	-36.33	4.45	3.00	12.45	-28.33	-13.00	15.33	V
5729.4	-39.75	5.48	3.00	13.66	-31.57	-13.00	18.57	V

4.3 Occupied Bandwidth and Emission Bandwidth

TEST APPLICABLE

Similar to conducted emissions; occupied bandwidth measurements are only provided for selected frequencies in order to reduce the amount of submitted data. Data were taken at the extreme and mid frequencies of PCS1900 band and GSM850 band. The table below lists the measured 99% Bandwidth and -26dBc Bandwidth.

TEST CONFIGURATION

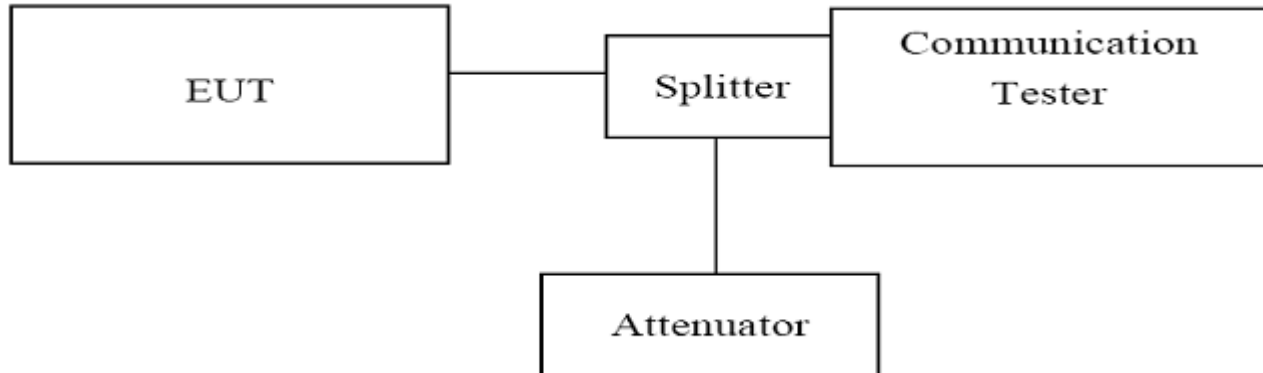

TEST PROCEDURE

1. The EUT was set up for the max output power with pseudo random data modulation;
2. The Occupied bandwidth and Emission Bandwidth were measured with Agilent Spectrum Analyzer N9030A (peak);
3. Set RBW=5.1KHz, VBW=51KHz, Span=1MHz, SWT=500ms;
4. Set SPA Max hold and View, Set 99% Occupied Bandwidth/ Set -26dBc Occupied Bandwidth
5. These measurements were done at 3 frequencies, 1850.20 MHz, 1880.00 MHz and 1909.80 MHz for PCS1900 band; 824.20MHz, 836.60 MHz and 848.80 MHz for GSM850 band. (Low, middle and high of operational frequency range).

TEST RESULTS

Remark: The EUT supports two SIM card SIM1 and SIM2. We tested two SIM and recorded the worst case at SIM1.

GSM 850				
Channel Number	Frequency (MHz)	Occupied Bandwidth (99% BW) (kHz)	Emission Bandwidth (26 dBc BW) (kHz)	Verdict
128	824.20	246.26	318.4	PASS
190	836.60	242.47	309.5	PASS
251	848.80	250.58	315.1	PASS

GSM 1900				
Channel Number	Frequency (MHz)	Occupied Bandwidth (99% BW) (kHz)	Emission Bandwidth (26 dBc BW) (kHz)	Verdict
512	1850.20	248.33	315.2	PASS
661	1880.00	248.41	318.1	PASS
810	1909.80	247.27	312.0	PASS

GPRS 850				
Channel Number	Frequency (MHz)	Occupied Bandwidth (99% BW) (kHz)	Emission Bandwidth (26 dBc BW) (kHz)	Verdict
128	824.20	246.72	317.8	PASS
190	836.60	246.77	315.4	PASS
251	848.80	239.13.	312.7	PASS

GPRS 1900				
Channel Number	Frequency (MHz)	Occupied Bandwidth (99% BW) (kHz)	Emission Bandwidth (26 dBc BW) (kHz)	Verdict
512	1850.20	246.91	317.3	PASS
661	1880.00	243.59	312.2	PASS
810	1909.80	246.45	315.8	PASS

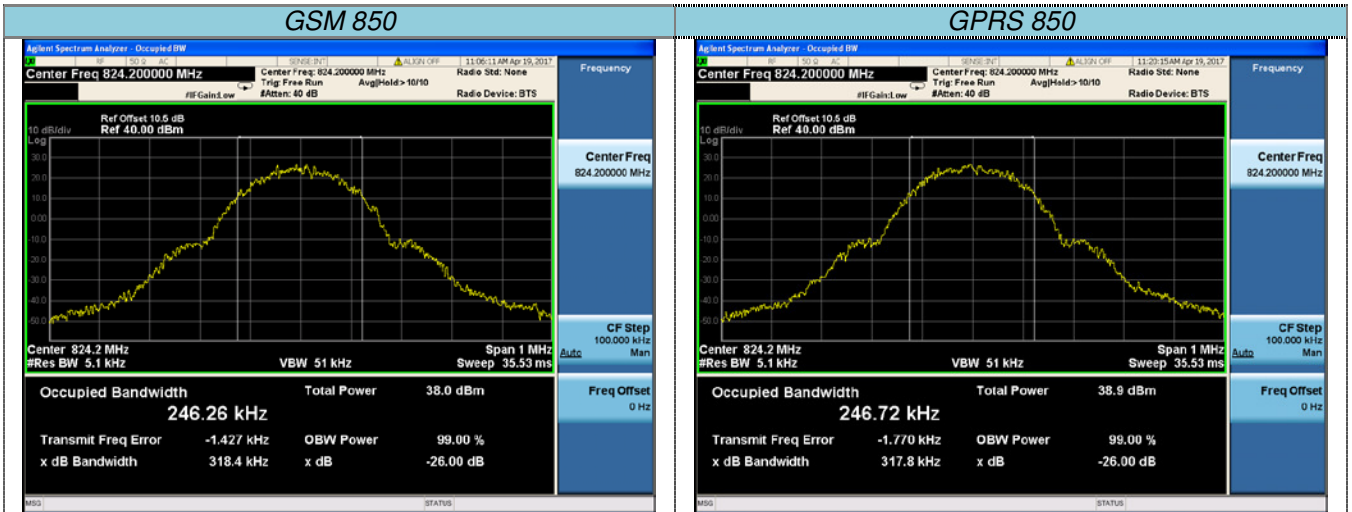

Channel 128

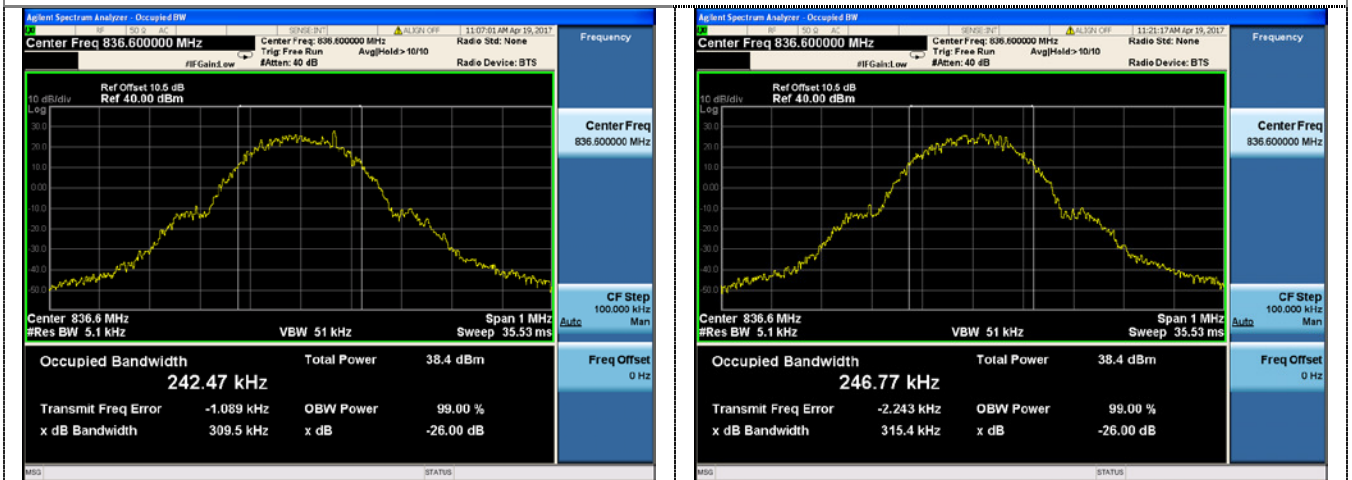

Channel 190

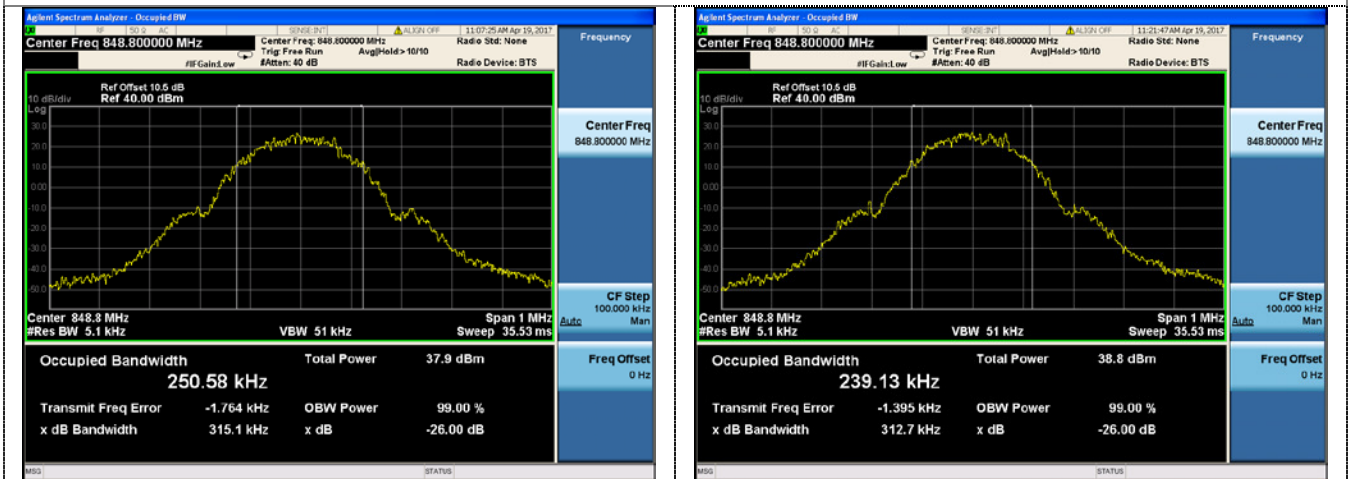

Channel 251

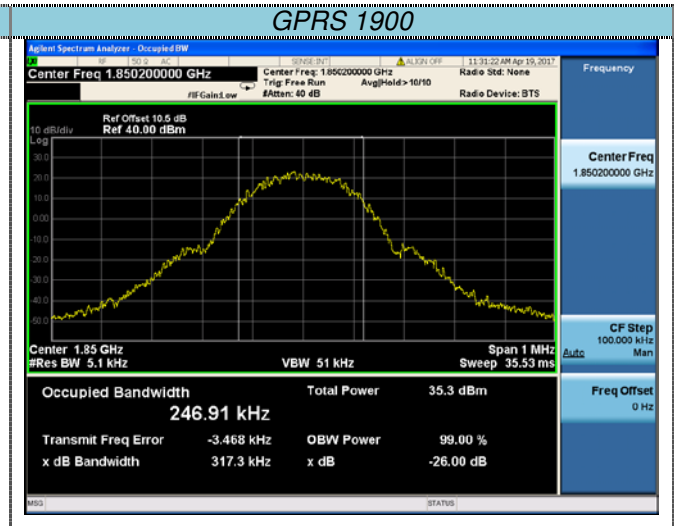
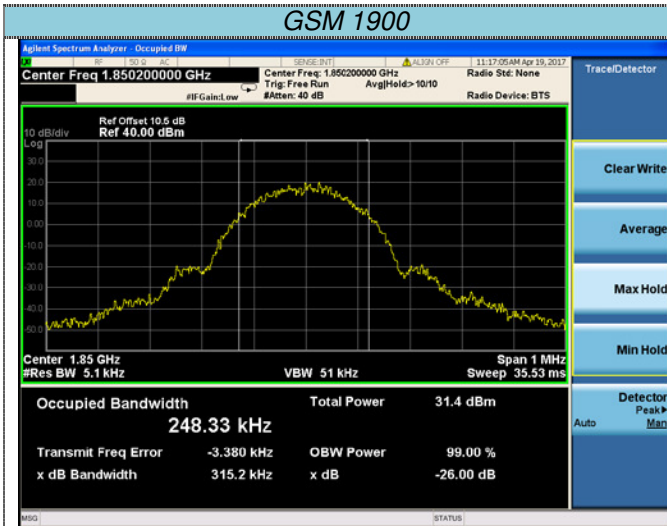

Channel 512

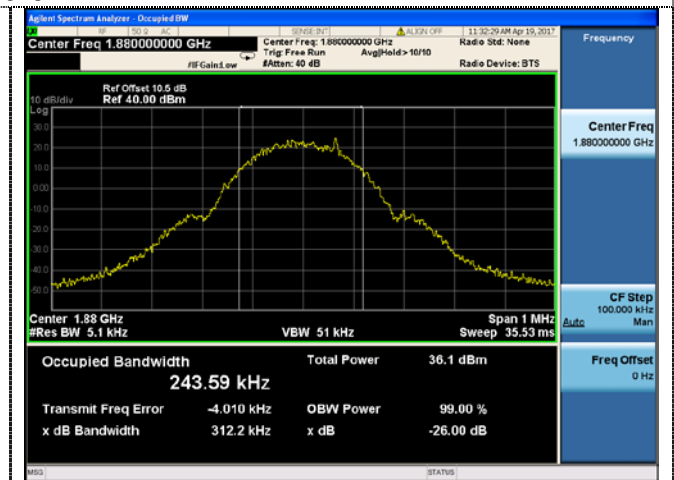
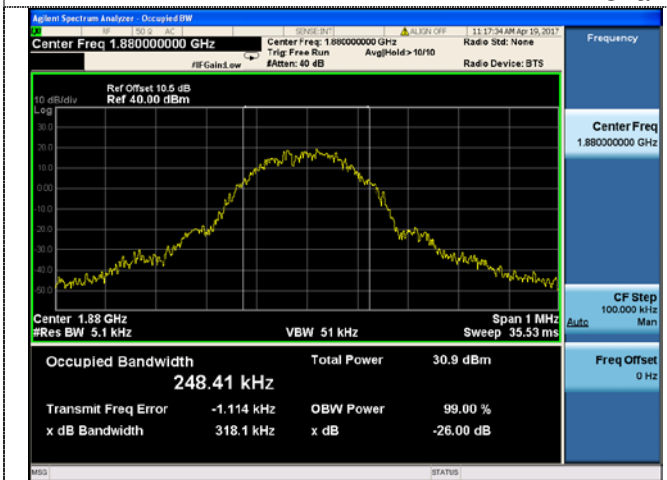

Channel 661

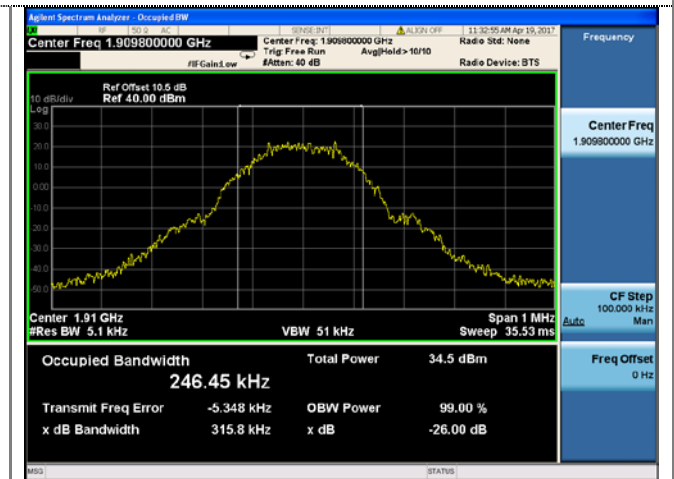
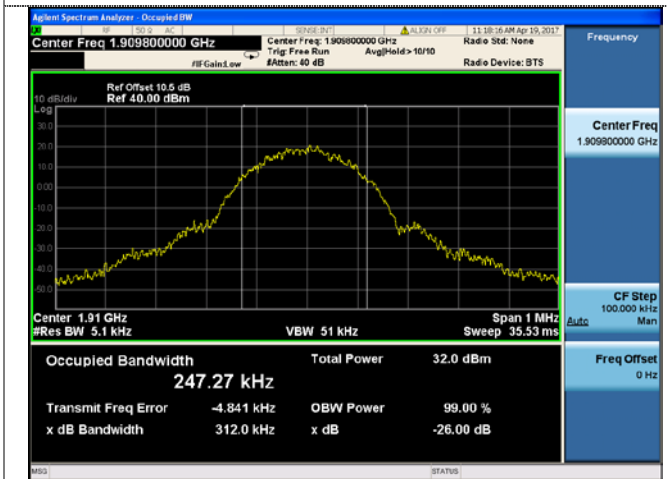

Channel 810

4.4 Band Edge Compliance

TEST APPLICABLE

During the process of testing, the EUT was controlled via Agilent Digital Radio Communication tester (CMU200) to ensure max power transmission and proper modulation.

TEST CONFIGURATION

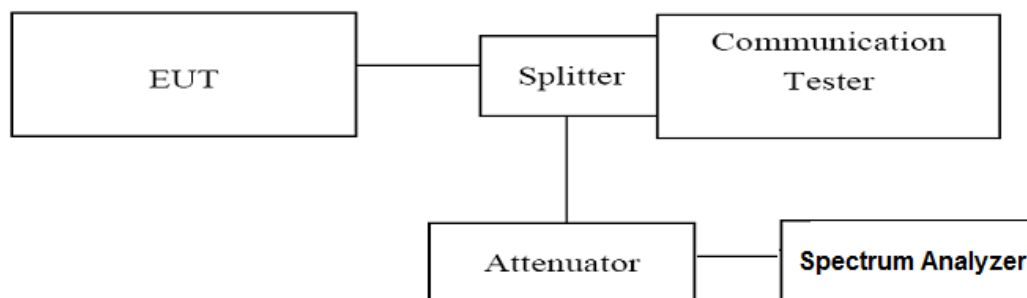

TEST PROCEDURE

1. The EUT was set up for the max output power with pseudo random data modulation;
2. The power was measured with Agilent Spectrum Analyzer N9030A;
3. Set RBW=5.1KHz, VBW=51KHz, Span=3MHz, SWT=300ms, Dector: RMS;
4. These measurements were done at 3 frequencies, 1850.20 MHz, 1880.00 MHz and 1909.80 MHz for PCS1900 band; 824.20 MHz, 836.60 MHz and 848.80 MHz for GSM850 band. (bottom, middle and top of operational frequency range).

TEST RESULTS

Remark: The EUT supports two SIM card SIM1 and SIM2. We tested two SIM and recorded the worst case at SIM1.

GSM 850					
Channel Number	Frequency (MHz)	Measurement Results		Limit (dBm)	Verdict
		Frequency (MHz)	Values (dBm)		
128	824.20	824.002	-14.691	-13.00	PASS
251	848.80	849.000	-14.687	-13.00	PASS

GSM 1900					
Channel Number	Frequency (MHz)	Measurement Results		Limit (dBm)	Verdict
		Frequency (MHz)	Values (dBm)		
512	1850.20	1850.000	-17.577	-13.00	PASS
810	1909.80	1910.001	-15.331	-13.00	PASS

GPRS 850					
Channel Number	Frequency (MHz)	Measurement Results		Limit (dBm)	Verdict
		Frequency (MHz)	Values (dBm)		
128	824.20	824.002	-16.080	-13.00	PASS
251	848.80	849.000	-15.675	-13.00	PASS

GPRS 1900					
Channel Number	Frequency (MHz)	Measurement Results		Limit (dBm)	Verdict
		Frequency (MHz)	Values (dBm)		
512	1850.20	1849.997	-17.998	-13.00	PASS
810	1909.80	1910.001	-16.161	-13.00	PASS

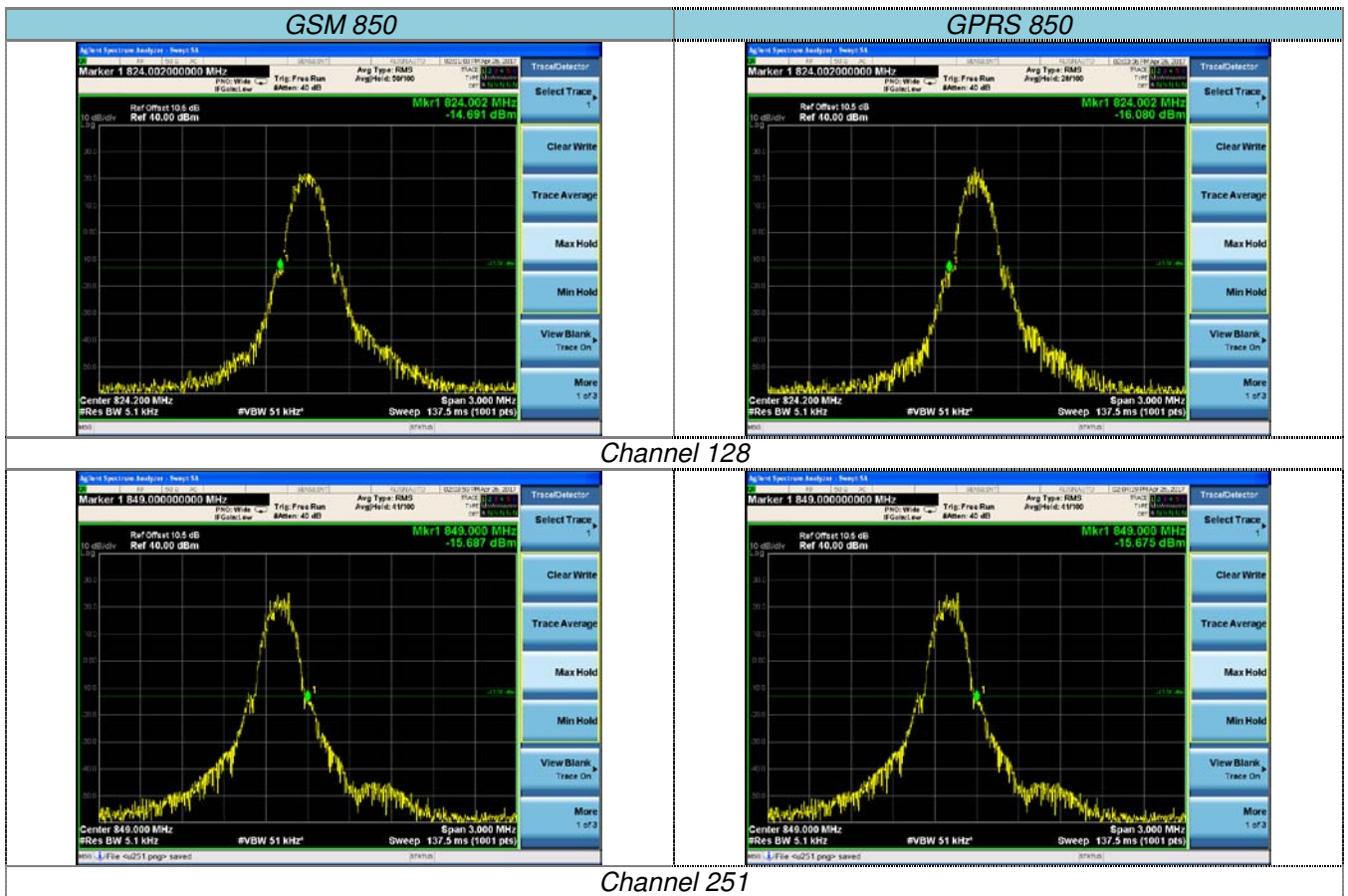

Channel 128

Channel 251

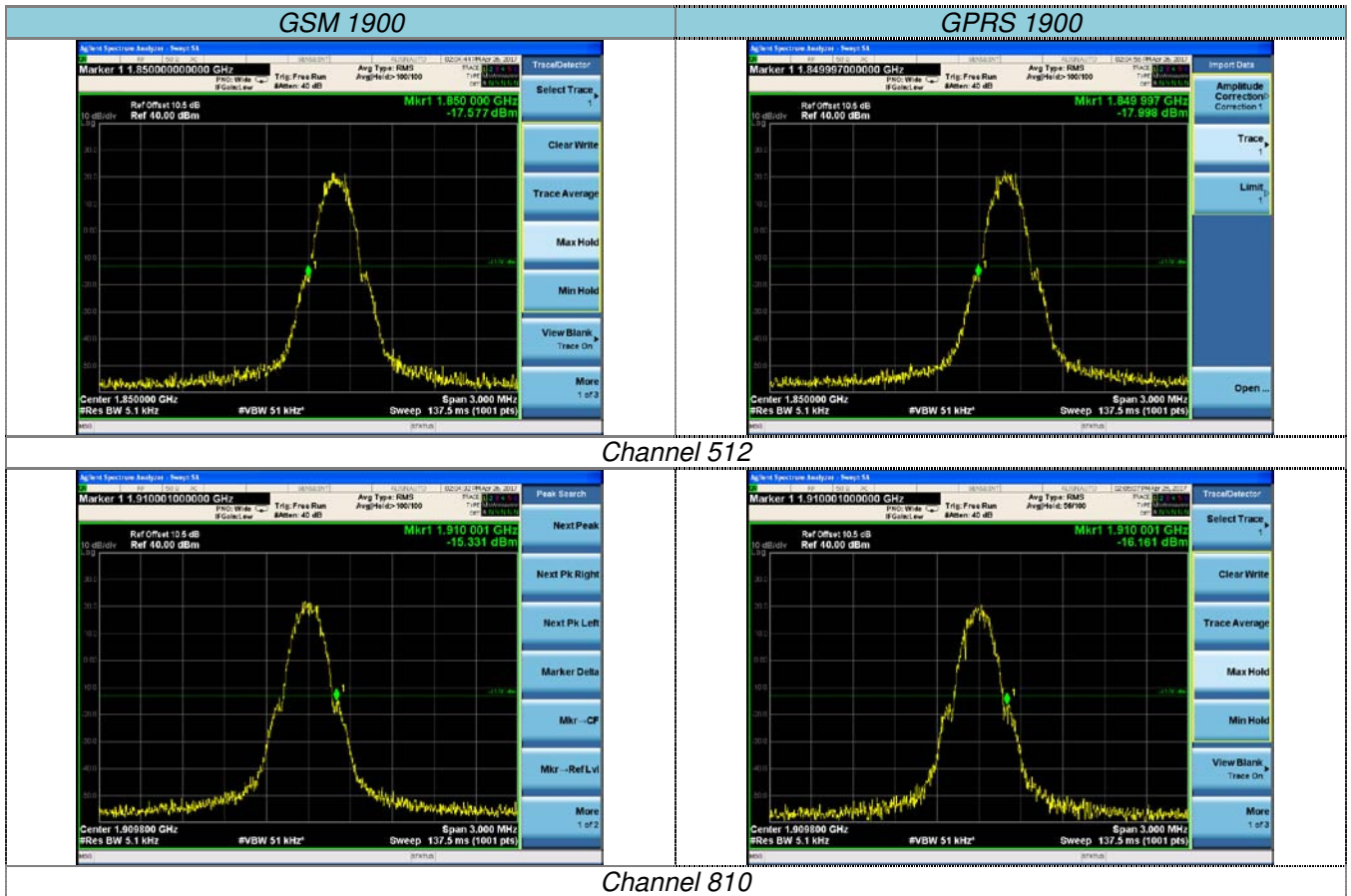

4.5 Spurious Emission on Antenna Port

TEST APPLICABLE

The following steps outline the procedure used to measure the conducted emissions from the EUT.

1. Determine frequency range for measurements: From CFR 2.1057 the spectrum should be investigated from the lowest radio frequency generated in the equipment up to at least the 10th harmonic of the carrier frequency. For the equipment of PCS1900 band, this equates to a frequency range of 9 KHz to 19.1 GHz, data taken from 9 KHz to 25 GHz. For GSM850, data taken from 9 KHz to 9 GHz.
2. The sweep time is set automatically by instrument itself. That should be the optimal sweep time for the span and the RBW. If the sweep time is too short, that is sweep is too fast, the sweep result is not accurate; if the sweep time is too long, that is sweep is too low, some frequency components may be lost. The instrument will give an optimal sweep time according the selected span and RBW.
3. The procedure to get the conducted spurious emission is as follows:
The trace mode is set to MaxHold to get the highest signal at each frequency;
Wait 25 seconds;
Get the result.
4. Determine EUT transmit frequencies: below outlines the band edge frequencies pertinent to conducted emissions testing.

TEST CONFIGURATION

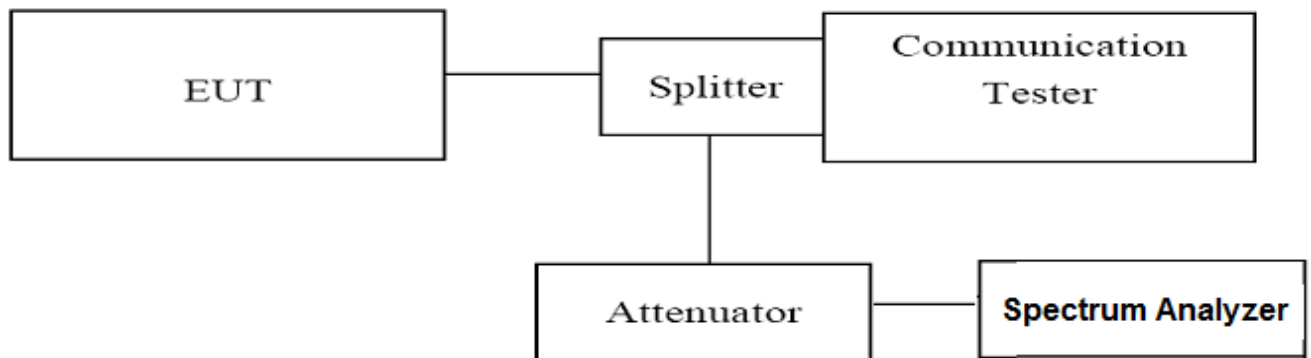

TEST PROCEDURE

1. The EUT was set up for the max output power with pseudo random data modulation;
2. The power was measured with Agilent Spectrum Analyzer N9030A (peak);
3. These measurements were done at 3 frequencies, 1850.20 MHz, 1880.00 MHz and 1909.80 MHz for PCS1900 band; 824.20 MHz, 836.60 MHz and 848.80 MHz for GSM850 band. (Low, middle and high of operational frequency range).

TEST LIMIT

Part 24.238 and Part 22.917 specify that the power of any emission outside of the authorized operating frequency ranges must be attenuated below the transmitting power (P) by a factor of at least $43 + 10 \log(P)$ dB.

The specification that emissions shall be attenuated below the transmitter power (P) by at least $43 + 10 \log(P)$ dB, translates in the relevant power range (1 to 0.001 W) to -13 dBm. At 1 W the specified minimum attenuation becomes 43 dB and relative to a 30 dBm (1 W) carrier becomes a limit of -13 dBm. At 0.001 W (0 dBm) the minimum attenuation is 13 dB, which again yields a limit of -13 dBm. In this way a translation of the specification from relative to absolute terms is carried out.

TEST RESULTS

Remark: The EUT supports two SIM card SIM1 and SIM2. We tested two SIM and recorded the worst case at SIM1. We tested GSM and GPRS mode and recorded the worst case at the GSM mode.

4.5.1 For GSM 850 Test Results

A. Test Verdict

Test Mode/ Channel	Frequency (MHz)	Frequency Range	Limit (dBm)	Verdict
GSM 850 /128	824.20	9KHz-150KHz	-13.00	PASS
		150KHz-30MHz	-13.00	PASS
		30MHz-3GHz	-13.00	PASS
		3GHz-9GHz	-13.00	PASS
GSM 850 /190	836.60	9KHz-150KHz	-13.00	PASS
		150KHz-30MHz	-13.00	PASS
		30MHz-3GHz	-13.00	PASS
		3GHz-9GHz	-13.00	PASS
GSM 850 /251	848.80	9KHz-150KHz	-13.00	PASS
		150KHz-30MHz	-13.00	PASS
		30MHz-3GHz	-13.00	PASS
		3GHz-9GHz	-13.00	PASS

Note:

1. In general, the worse case attenuation requirement shown above was applied.
2. "----" means that the emission level is too low to be measured or at least 20 dB down than the limit.

B. Test Plots

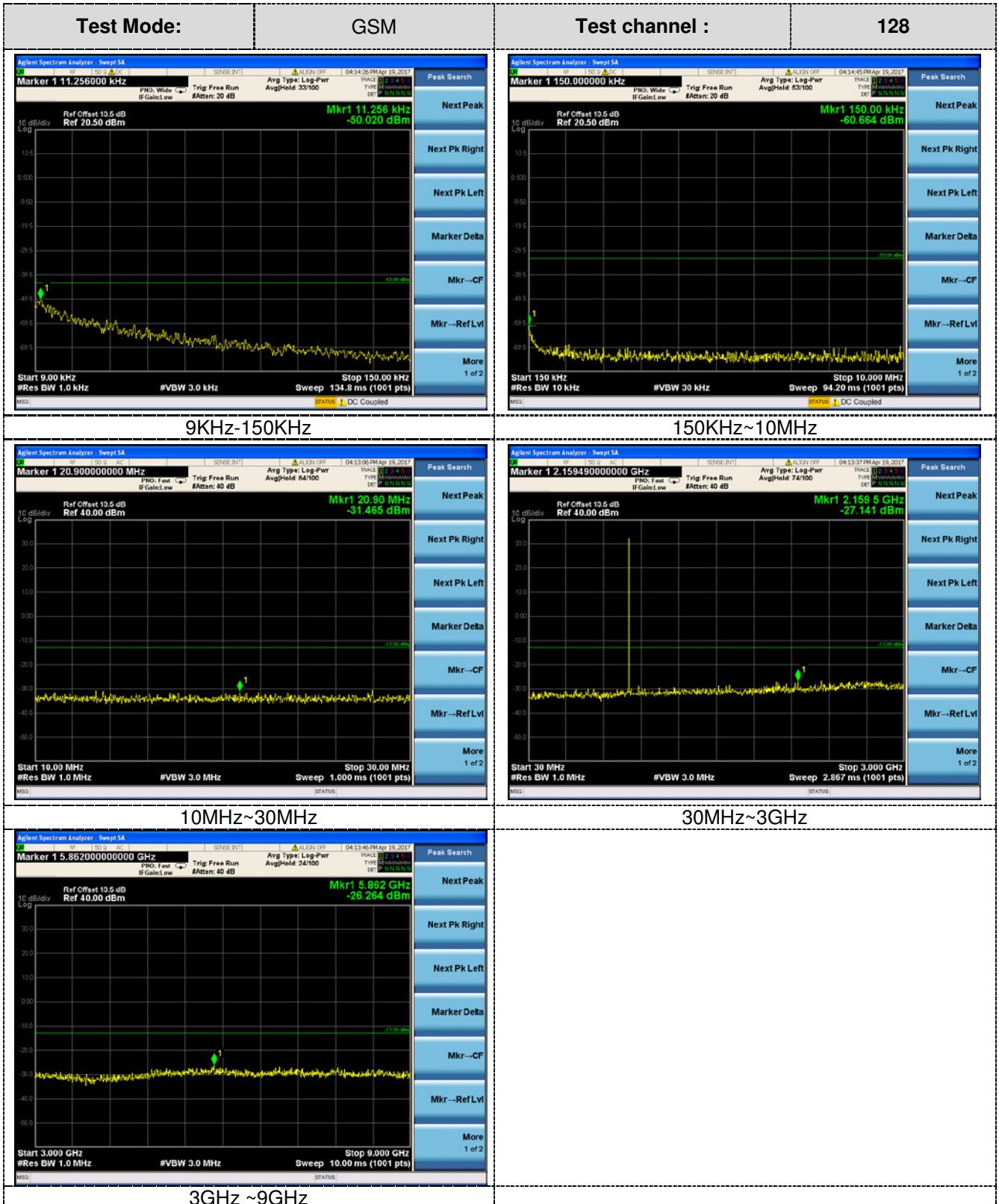

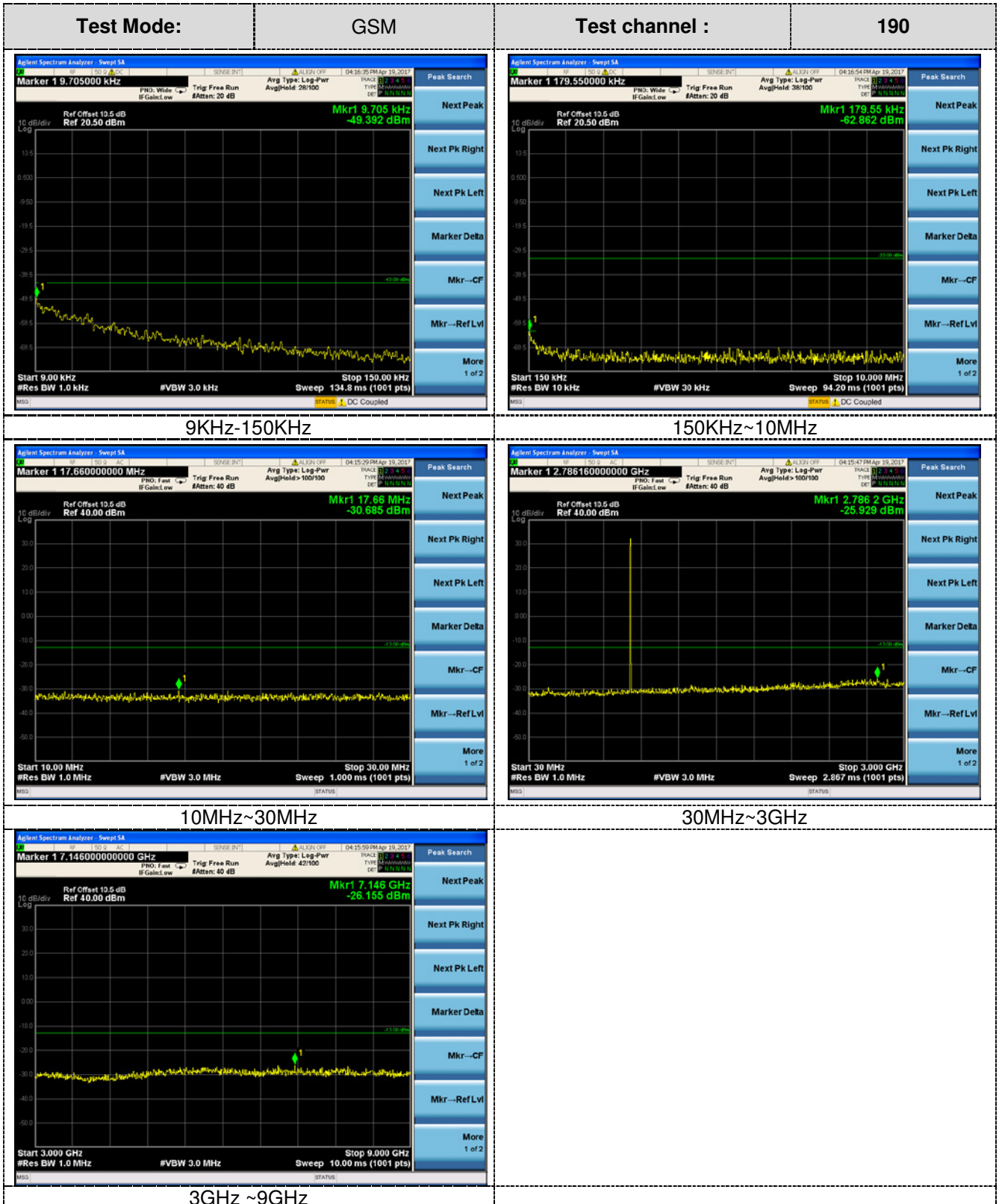

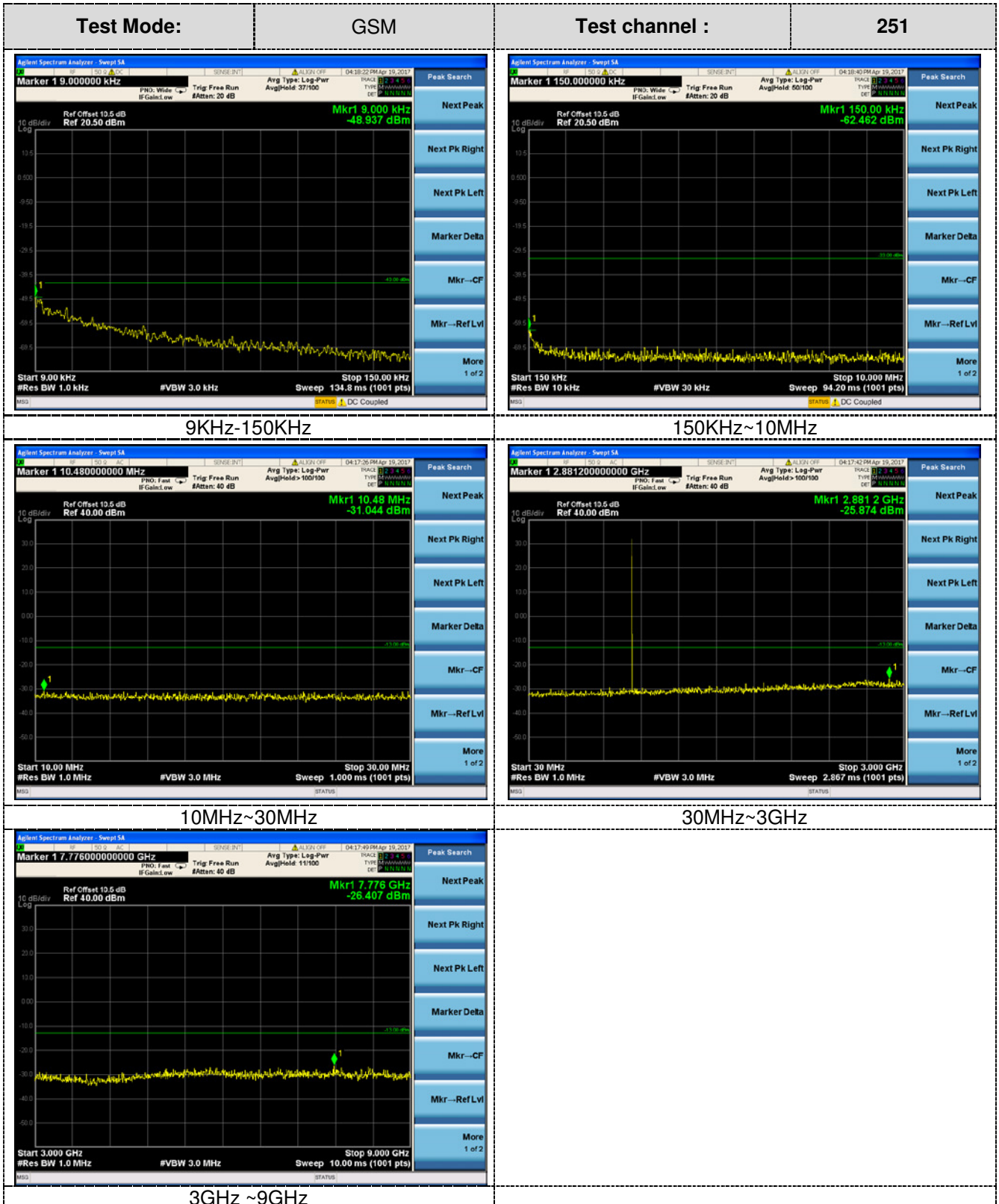

4.5.2 For GSM 1900 Test Results

A. Test Verdict

Test Mode/ Channel	Frequency (MHz)	Frequency Range	Limit (dBm)	Verdict
GSM 1900 /512	1850.20	9KHz-150KHz	-13.00	PASS
		150KHz-30MHz	-13.00	PASS
		30MHz -8GHz	-13.00	PASS
		8GHz-20GHz	-13.00	PASS
GSM 1900 /661	1880.00	9KHz-150KHz	-13.00	PASS
		150KHz-30MHz	-13.00	PASS
		30MHz -8GHz	-13.00	PASS
		8GHz-20GHz	-13.00	PASS
GSM 1900 /810	1909.80	9KHz-150KHz	-13.00	PASS
		150KHz-30MHz	-13.00	PASS
		30MHz -8GHz	-13.00	PASS
		8GHz-20GHz	-13.00	PASS

Note:

1. In general, the worse case attenuation requirement shown above was applied.
2. "----" means that the emission level is too low to be measured or at least 20 dB down than the limit.

B. Test Plots

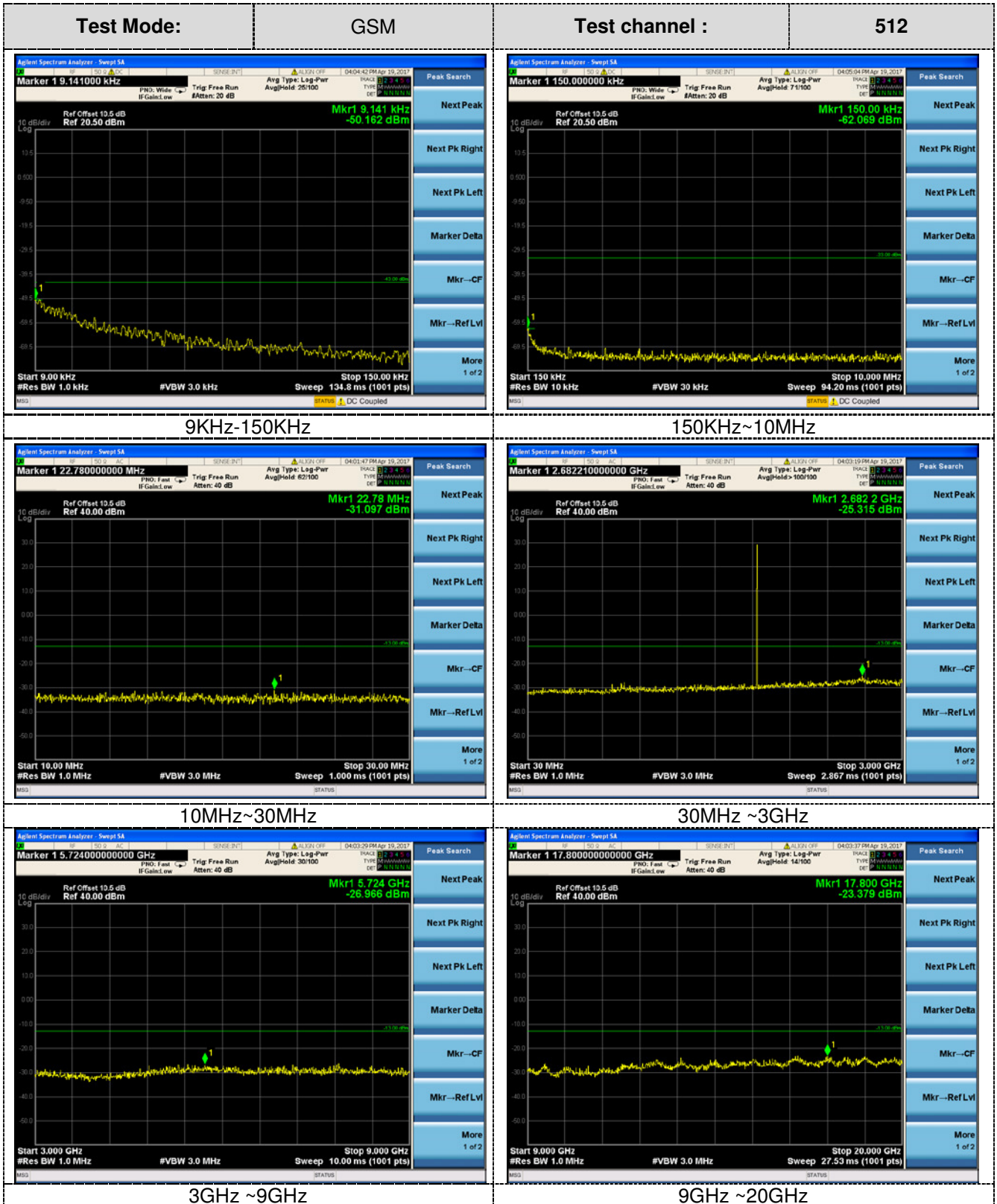

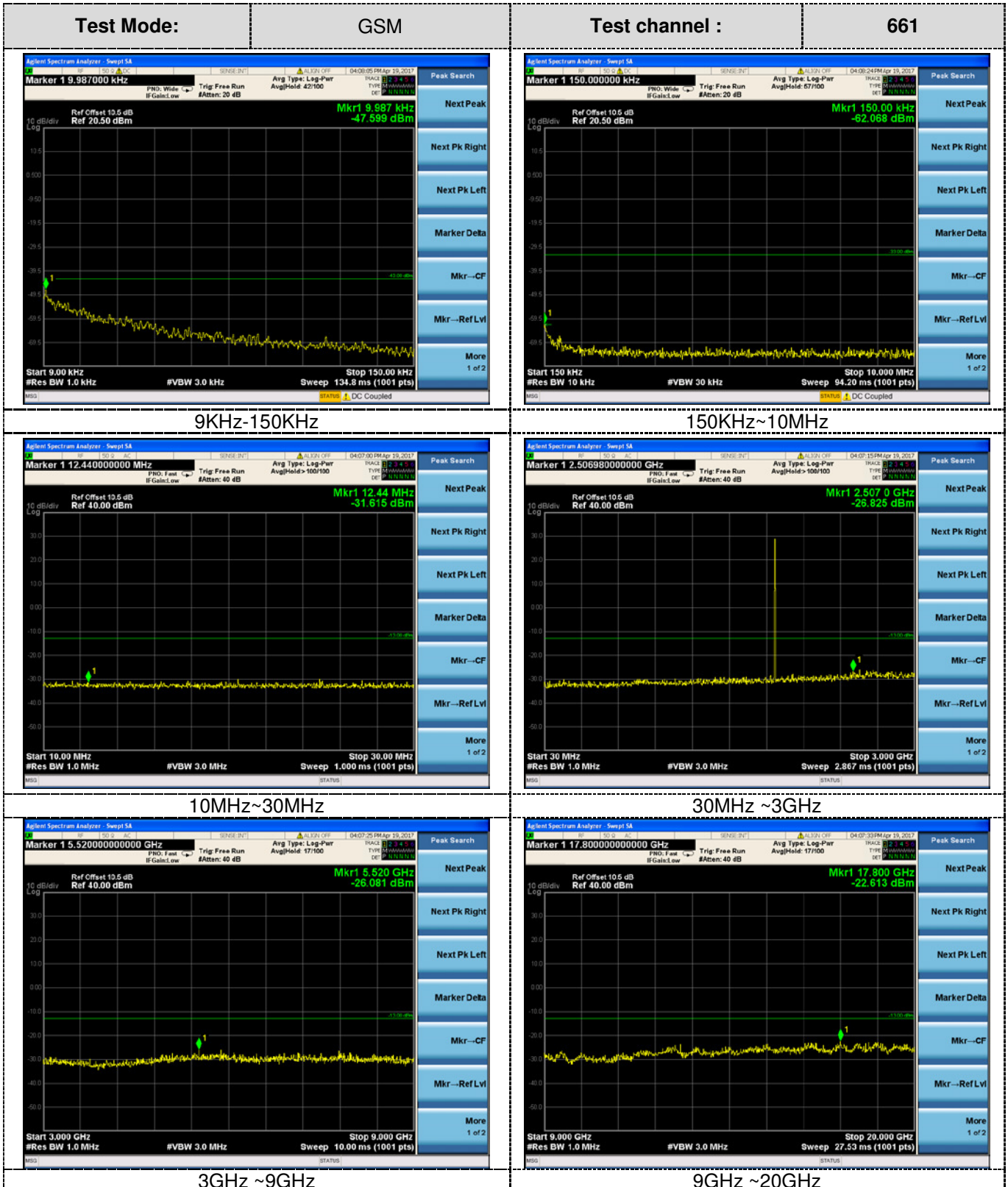

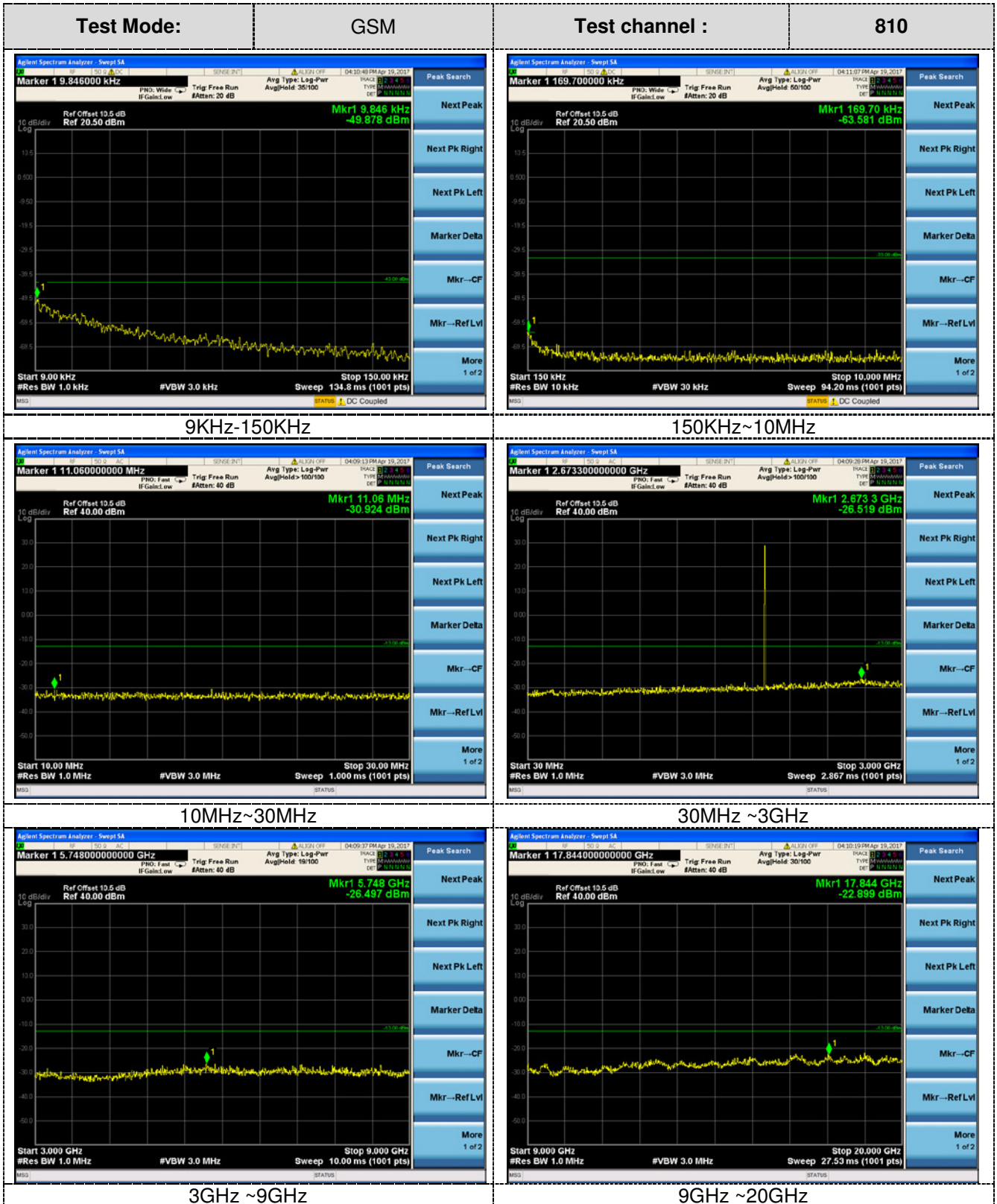

4.6 Frequency Stability Test

TEST APPLICABLE

1. According to FCC Part 2 Section 2.1055 (a)(1), the frequency stability shall be measured with variation of ambient temperature from -30°C to $+50^{\circ}\text{C}$ centigrade.
2. According to FCC Part 2 Section 2.1055 (E) (2), for battery powered equipment, the frequency stability shall be measured with reducing primary supply voltage to the battery operating end point, which is specified by the manufacture.
3. Vary primary supply voltage from 85 to 115 percent of the nominal value for other than hand carried voltage equipment and the end voltage point was 10.8V.

TEST PROCEDURE

In order to measure the carrier frequency under the condition of AFC lock, it is necessary to make measurements with the EUT in a "call mode". This is accomplished with the use of R&S CMU200 DIGITAL RADIO COMMUNICATION TESTER.

1. Measure the carrier frequency at room temperature;
2. Subject the EUT to overnight soak at -30°C ;
3. With the EUT, powered via nominal voltage, connected to the CMU200 and in a simulated call on middle channel of PCS 1900 and GSM850, measure the carrier frequency. These measurements should be made within 2 minutes of Powering up the EUT, to prevent significant self-warming;
4. Repeat the above measurements at 10°C increments from -30°C to $+50^{\circ}\text{C}$. Allow at least 0.5 hours at each temperature, unpowered, before making measurements;
5. Remeasure carrier frequency at room temperature with nominal voltage. Vary supply voltage from minimum voltage to maximum voltage, in 0.1Volt increments remeasuring carrier frequency at each voltage. Pause at nominal voltage for 0.5 hours unpowered, to allow any self-heating to stabilize, before continuing;
6. Subject the EUT to overnight soak at $+50^{\circ}\text{C}$;
7. With the EUT, powered via nominal voltage, connected to the CMU200 and in a simulated call on the centre channel, measure the carrier frequency. These measurements should be made within 2 minutes of Powering up the EUT, to prevent significant self-warming;
8. Repeat the above measurements at 10°C increments from $+50^{\circ}\text{C}$ to -30°C . Allow at least 0.5 hours at each temperature, unpowered, before making measurements;
9. At all temperature levels hold the temperature to $\pm 0.5^{\circ}\text{C}$ during the measurement procedure;

TEST CONFIGURATION

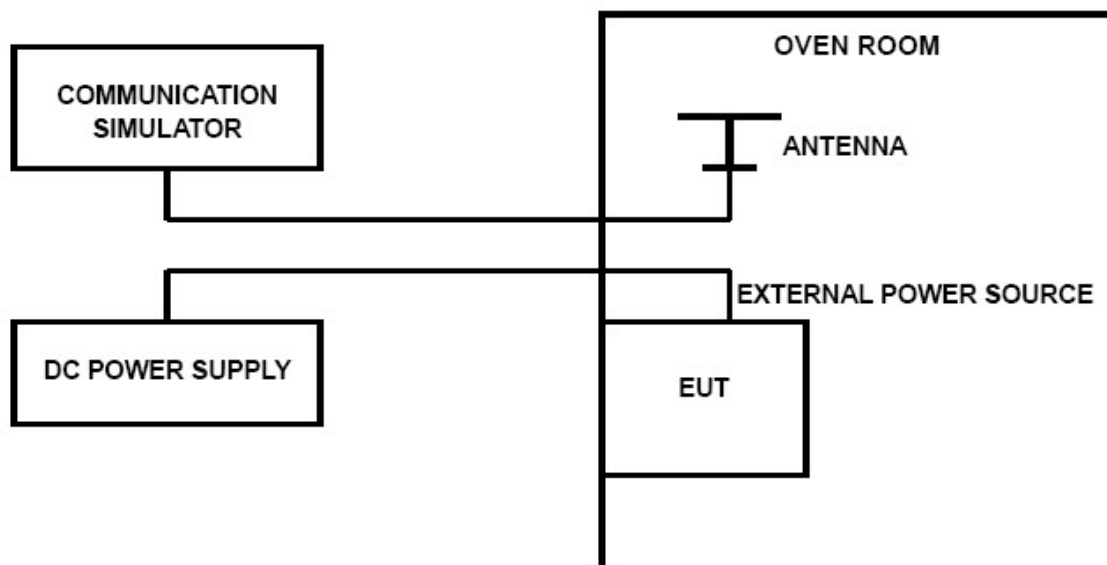

TEST LIMITS***For Hand carried battery powered equipment***

According to the JTC standard the frequency stability of the carrier shall be accurate to within 0.1 ppm of the received frequency from the base station. This accuracy is sufficient to meet Sec. 24.235, Frequency Stability. The frequency stability shall be sufficient to ensure that the fundamental emission stays within the authorized frequency block. As this transceiver is considered "Hand carried, battery powered equipment" Section 2.1055(d)(2) applies. This requires that the lower voltage for frequency stability testing be specified by the manufacturer. This transceiver is specified to operate with an input voltage of between 3.40VDC and 4.20VDC, with a nominal voltage of 3.80 DC. Operation above or below these voltage limits is prohibited by transceiver software in order to prevent improper operation as well as to protect components from overstress. These voltages represent a tolerance of -10 % and +12.5 %. For the purposes of measuring frequency stability these voltage limits are to be used.

For equipment powered by primary supply voltage

According to the JTC standard the frequency stability of the carrier shall be accurate to within 0.1 ppm of the received frequency from the base station. This accuracy is sufficient to meet Sec. 24.235, Frequency Stability. The frequency stability shall be sufficient to ensure that the fundamental emission stays within the authorized frequency block. For this EUT section 2.1055(d)(1) applies. This requires varying primary supply voltage from 85 to 115 percent of the nominal value for other than hand carried battery equipment.

TEST RESULTS

Remark: The EUT supports two SIM card SIM1 and SIM2. We tested two SIM and recorded the worst case at SIM1.

GSM 850 Middle channel=190 channel=836.6MHz					
DC Power	Temperature (°C)	Frequency error(Hz)	Frequency error(ppm)	Limit (ppm)	Verdict
3.40	25	17	0.020	2.50	PASS
3.80	25	25	0.030	2.50	PASS
4.20	25	19	0.023	2.50	PASS
3.80	-30	15	0.018	2.50	PASS
3.80	-20	21	0.025	2.50	PASS
3.80	-10	25	0.030	2.50	PASS
3.80	0	19	0.023	2.50	PASS
3.80	10	16	0.019	2.50	PASS
3.80	20	17	0.020	2.50	PASS
3.80	30	18	0.022	2.50	PASS
3.80	40	16	0.019	2.50	PASS
3.80	50	23	0.027	2.50	PASS

GSM 1900 Middle channel=661 channel=1880MHz					
DC Power	Temperature (°C)	Frequency error(Hz)	Frequency error(ppm)	Limit (ppm)	Verdict
3.40	25	36	0.019	2.50	PASS
3.80	25	36	0.019	2.50	PASS
4.20	25	37	0.020	2.50	PASS
3.80	-30	26	0.014	2.50	PASS
3.80	-20	28	0.015	2.50	PASS
3.80	-10	35	0.019	2.50	PASS
3.80	0	36	0.019	2.50	PASS
3.80	10	38	0.020	2.50	PASS
3.80	20	39	0.021	2.50	PASS
3.80	30	36	0.019	2.50	PASS
3.80	40	35	0.019	2.50	PASS
3.80	50	36	0.019	2.50	PASS

GPRS 850 Middle channel=190 channel=836.6MHz					
DC Power	Temperature (°C)	Frequency error(Hz)	Frequency error(ppm)	Limit (ppm)	Verdict
3.40	25	18	0.022	2.50	PASS
3.80	25	25	0.030	2.50	PASS
4.20	25	19	0.023	2.50	PASS
3.80	-30	16	0.019	2.50	PASS
3.80	-20	25	0.030	2.50	PASS
3.80	-10	26	0.031	2.50	PASS
3.80	0	19	0.023	2.50	PASS
3.80	10	23	0.027	2.50	PASS
3.80	20	21	0.025	2.50	PASS
3.80	30	15	0.018	2.50	PASS
3.80	40	18	0.022	2.50	PASS
3.80	50	17	0.020	2.50	PASS

GPRS 1900 Middle channel=661 channel=1880MHz					
DC Power	Temperature (°C)	Frequency error(Hz)	Frequency error(ppm)	Limit (ppm)	Verdict
3.40	25	35	0.019	2.50	PASS
3.80	25	39	0.021	2.50	PASS
4.20	25	25	0.013	2.50	PASS
3.80	-30	36	0.019	2.50	PASS
3.80	-20	38	0.020	2.50	PASS
3.80	-10	39	0.021	2.50	PASS
3.80	0	33	0.018	2.50	PASS
3.80	10	39	0.021	2.50	PASS
3.80	20	35	0.019	2.50	PASS
3.80	30	37	0.020	2.50	PASS
3.80	40	39	0.021	2.50	PASS
3.80	50	33	0.018	2.50	PASS

4.7 Peak-to-Average Ratio (PAR)

LIMIT

The Peak-to-Average Ratio (PAR) of the transmission may not exceed 13 dB.

TEST CONFIGURATION

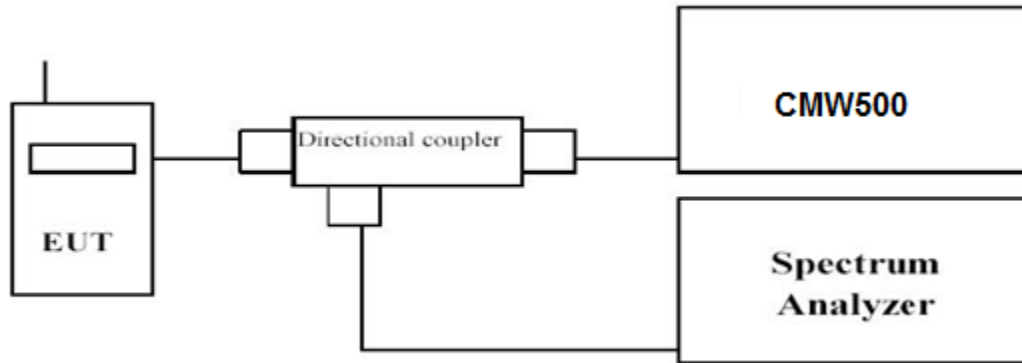

TEST PROCEDURE

Use spectrum to measure the total peak power and record as P_{Pk}. Use spectrum to measure the total average power and record as P_{Avg}. Both the peak and average power levels must be expressed in the same logarithmic units (e.g., dBm).

Determine the PAPR from:

$$PAPR (dB) = P_{Pk} (dBm) - P_{Avg} (dBm).$$

TEST RESULTS

Remark: The EUT supports two SIM card SIM1 and SIM2. We tested two SIM and recorded the worst case at SIM1.

	GSM 850	GPRS 850
Frequency (MHz)	Measured (dB)	Measured (dB)
824.20	10.02	9.93
836.60	9.56	9.87
848.80	9.84	9.13

	GSM 1900	GPRS 1900
Frequency (MHz)	Measured (dB)	Measured (dB)
1850.20	9.98	10.01
1880.00	9.30	9.82
1909.80	9.63	9.90

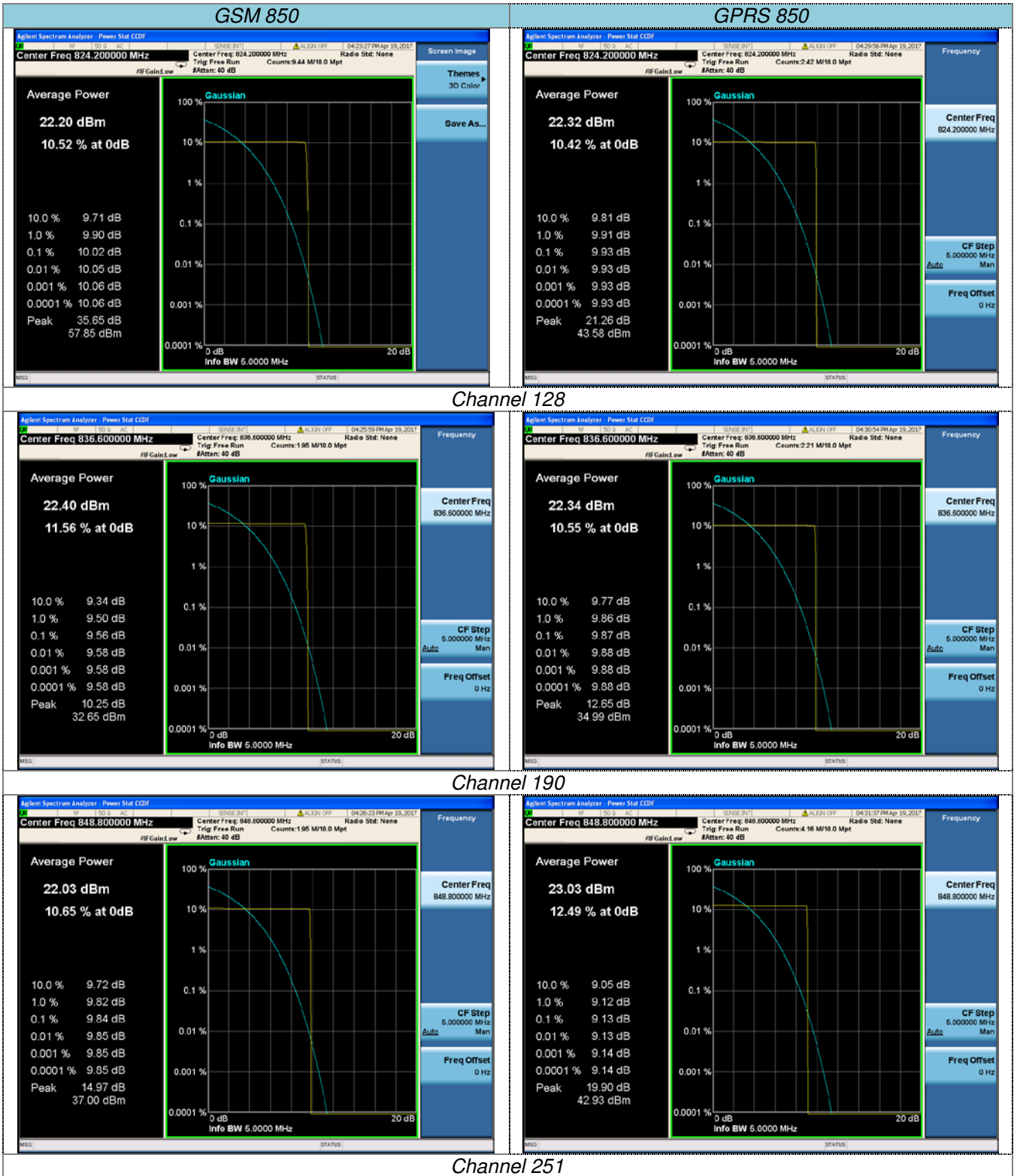

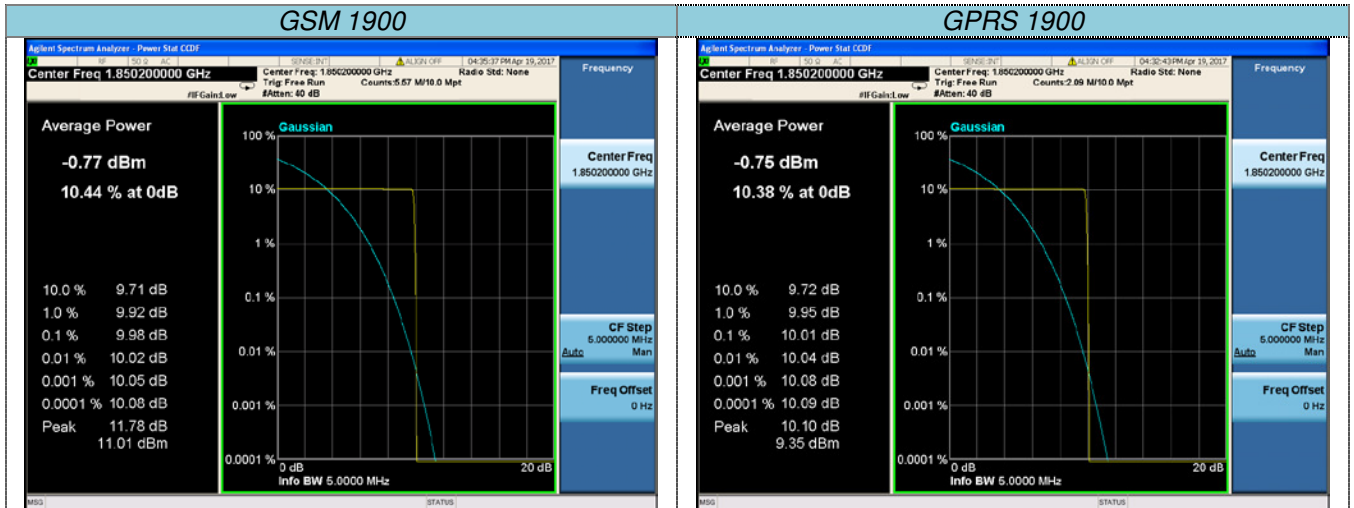

Channel 512

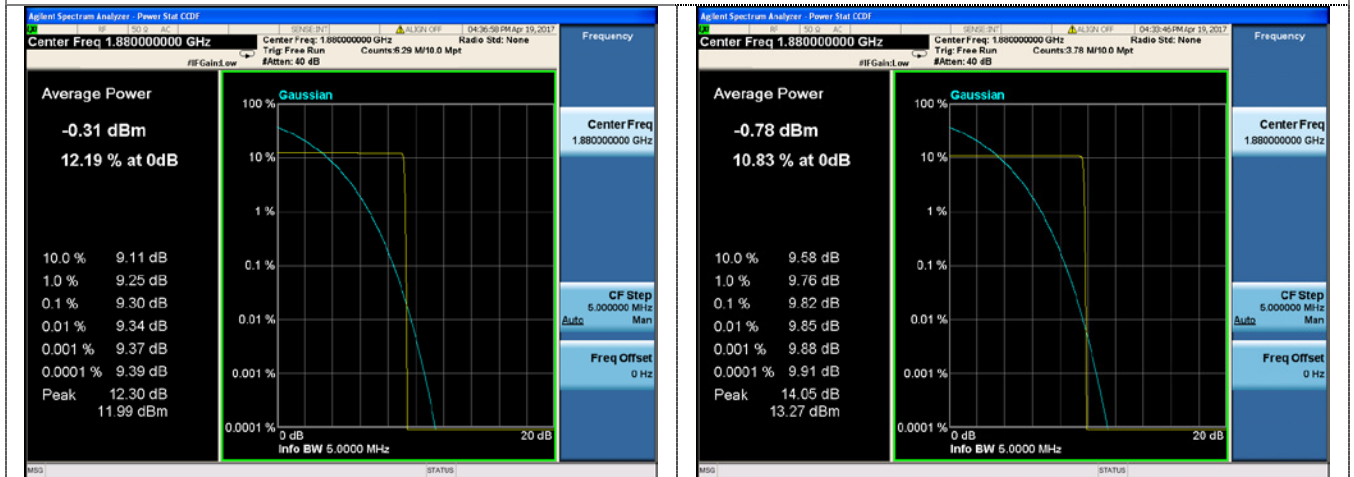

Channel 661

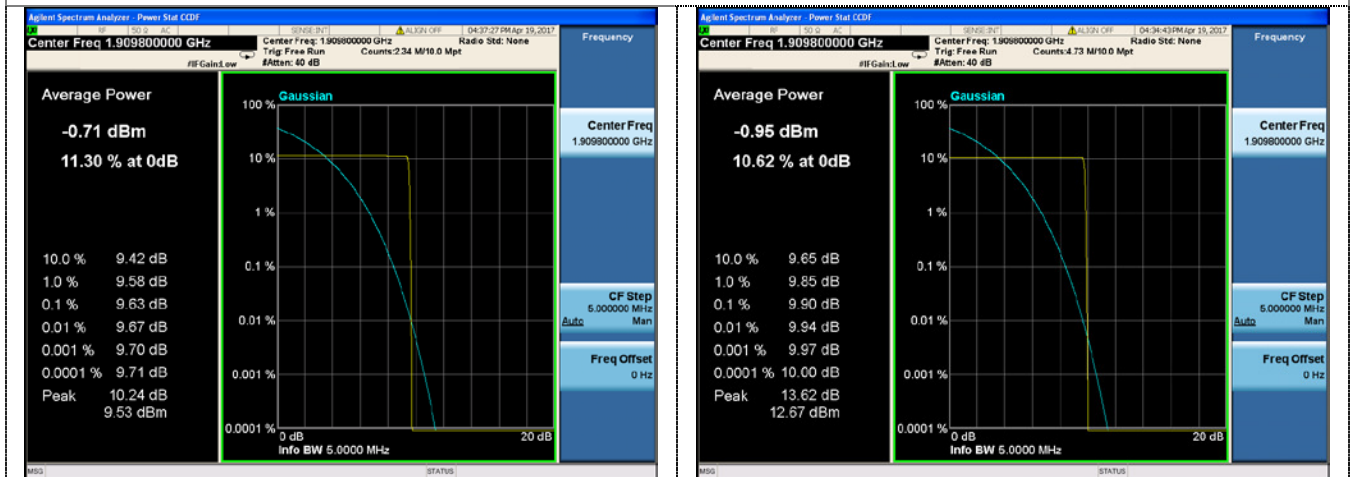

Channel 810

5 Test Setup Photos of the EUT



6 External and Internal Photos of the EUT

Reference to the test report No. GTSR17042018-BLE

.....**End of Report**.....