



FCC PART 15 SUBPART C TEST REPORT

FCC PART 15.247

Report Reference No......: **GTSR17042018-WIFI**

FCC ID..... : **RQQHLT-ORBITUT**

Compiled by
 (position+printed name+signature)..: File administrators Jimmy Wang

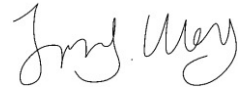

Supervised by
 (position+printed name+signature)..: Test Engineer Peter Xiao



Approved by
 (position+printed name+signature)..: Manager Sam Wang



Date of issue.....: May. 11, 2017

Representative Laboratory Name .: **Shenzhen Global Test Service Co.,Ltd.**

Address: 1F, Building No. 13A, Zhonghaixin Science and Technology City,
 No.12,6 Road, Ganli Industrial Park, Buji Street, Longgang District,
 Shenzhen, Guangdong

Applicant's name: **HYUNDAI CORPORATION**

Address: 25,Yulgok-ro 2-Gil, Jongno-gu, Seoul, South Korea

Test specification

Standard: **FCC Part 15.247: Operation within the bands 902-928 MHz,
 2400-2483.5 MHz and 5725-5850 MHz**

Shenzhen Global Test Service Co.,Ltd. All rights reserved.

This publication may be reproduced in whole or in part for non-commercial purposes as long as the Shenzhen Global Test Service Co.,Ltd. is acknowledged as copyright owner and source of the material. Shenzhen Global Test Service Co.,Ltd. takes no responsibility for and will not assume liability for damages resulting from the reader's interpretation of the reproduced material due to its placement and context.

Test item description: Mobile Phone

Trade Mark: HYUNDAI

Manufacturer: Shenzhen Rainbow Time Technology Co.,Ltd

Model/Type reference.....: ORBIT

Listed Models: /

Operation Frequency.....: From 2412MHz to 2462MHz

Hardware Version: V1_02_C00SEA

Software Version: V1.0

Rating: DC 3.80V

Result.....: **PASS**

TEST REPORT

Test Report No. :	GTSR17042018-WIFI	May. 11, 2017
		Date of issue

Equipment under Test : Mobile Phone

Model /Type : ORBIT

Listed Models : /

Applicant : **HYUNDAI CORPORATION**

Address : 25,Yulgok-ro 2-Gil, Jongno-gu, Seoul, South Korea

Manufacturer : **Shenzhen Rainbow Time Technology Co.,Ltd**

Address : Room 905, ChangHong Technology Building, Science and Technology Park, Nanshan District, Shenzhen, China

Test Result:	PASS
---------------------	-------------

The test report merely corresponds to the test sample.
 It is not permitted to copy extracts of these test result without the written permission of the test laboratory.

Contents

1.	<u>TEST STANDARDS</u>	<u>4</u>
2.	<u>SUMMARY</u>	<u>5</u>
2.1.	General Remarks	5
2.2.	Product Description	5
2.3.	Equipment Under Test	5
2.4.	Short description of the Equipment under Test (EUT)	5
2.5.	EUT operation mode	6
2.6.	Block Diagram of Test Setup	6
2.7.	Related Submittal(s) / Grant (s)	6
2.8.	Modifications	6
3.	<u>TEST ENVIRONMENT</u>	<u>7</u>
3.1.	Address of the test laboratory	7
3.2.	Test Facility	7
3.3.	Environmental conditions	7
3.4.	Test Description	8
3.5.	Statement of the measurement uncertainty	9
3.6.	Equipments Used during the Test	10
4.	<u>TEST CONDITIONS AND RESULTS.....</u>	<u>11</u>
4.1.	AC Power Conducted Emission	11
4.2.	Radiated Emission.....	14
4.3.	Maximum Peak Output Power.....	23
4.4.	Power Spectral Density	24
4.5.	6dB Bandwidth	27
4.6.	Band Edge Compliance of RF Emission	30
4.7.	Spurious RF Conducted Emission	35
4.8.	Antenna Requirement.....	48
5.	<u>TEST SETUP PHOTOS OF THE EUT</u>	<u>49</u>
6.	<u>EXTERNAL AND INTERNAL PHOTOS OF THE EUT</u>	<u>50</u>

1. TEST STANDARDS

The tests were performed according to following standards:

[FCC Rules Part 15.247](#): Frequency Hopping, Direct Spread Spectrum and Hybrid Systems that are in operation within the bands of 902-928 MHz, 2400-2483.5 MHz, and 5725-5850 MHz.

[ANSI C63.10-2013](#): American National Standard for Testing Unlicensed Wireless Devices

[KDB558074 D01 V04](#): GUIDANCE FOR PERFORMING COMPLIANCE MEASUREMENTS ON DIGITAL TRANSMISSION SYSTEMS (DTS) OPERATING UNDER SECTION 15.247

2. SUMMARY

2.1. General Remarks

Date of receipt of test sample	:	April. 05, 2017
Testing commenced on	:	April. 05, 2017
Testing concluded on	:	May. 11, 2017

2.2. Product Description

Name of EUT	Mobile Phone
Model Number	ORBIT
Listed Models	/
FCC ID	RQQHLT-ORBITUT
Power Supply	Battery DC 3.80V
Adapter Information	Model: Y-5204B-2A Input: AC100-240V~50/60Hz 0.3A Output:DC5V/2000mA
Supported type:	802.11b/802.11g/802.11n HT20/802.11n HT40
Modulation:	IEEE 802.11b: DSSS(CCK,DQPSK,DBPSK) IEEE 802.11g: OFDM(64QAM, 16QAM, QPSK, BPSK) IEEE 802.11n HT20: OFDM (64QAM, 16QAM, QPSK,BPSK) IEEE 802.11n HT40: OFDM (64QAM, 16QAM, QPSK,BPSK)
Operation frequency:	IEEE 802.11b:2412-2462MHz IEEE 802.11g:2412-2462MHz IEEE 802.11n HT20:2412-2462MHz IEEE 802.11n HT40:2422-2452MHz
Antenna Type	Internal Antenna
Antenna gain	-0.50dBi

2.3. Equipment Under Test

Power supply system utilised

Power supply voltage	:	<input type="radio"/> 230V / 50 Hz	<input type="radio"/> 120V / 60Hz
		<input type="radio"/> 12 V DC	<input type="radio"/> 24 V DC
		<input checked="" type="radio"/> Other (specified in blank below)	

DC 3.80V

2.4. Short description of the Equipment under Test (EUT)

This is a Mobile Phone .

For more details, refer to the user's manual of the EUT.

2.5. EUT operation mode

The application provider specific test software to control sample in continuous TX and RX (Duty Cycle >98%) for testing meet KDB558074 test requirement.

IEEE 802.11b/g/n: Thirteen channels are provided to the EUT.

Channel	Frequency(MHz)	Channel	Frequency(MHz)
1	2412	8	2447
2	2417	9	2452
3	2422	10	2457
4	2427	11	2462
5	2432		
6	2437		
7	2442		

2.6. Block Diagram of Test Setup

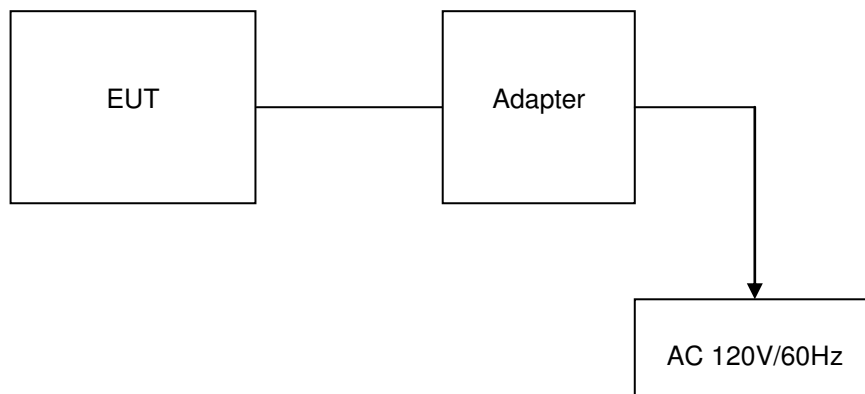

2.7. Related Submittal(s) / Grant (s)

This submittal(s) (test report) is intended for **FCC ID: RQQLT-ORBITUT** filing to comply with Section 15.247 of the FCC Part 15, Subpart C Rules.

2.8. Modifications

No modifications were implemented to meet testing criteria.

3. TEST ENVIRONMENT

3.1. Address of the test laboratory

Shenzhen Global Test Service Co.,Ltd.

1F, Building No. 13A, Zhonghaixin Science and Technology City, No.12,6 Road, Ganli Industrial Park, Buji Street, Longgang District, Shenzhen, Guangdong

Shenzhen CTL Testing Technology Co.,Ltd.

1/F.-A, Baisha Technology Park, No.3011, Shahexi Road, Nanshan District, Shenzhen, Guangdong, China

3.2. Test Facility

The test facility is recognized, certified, or accredited by the following organizations:

FCC-Registration No.: 964637

Shenzhen Global Test Service Co.,Ltd EMC Laboratory has been registered and fully described in a report filed with the (FCC) Federal Communications Commission. The acceptance letter from the FCC is maintained in our files. Registration 964637, Jul 24, 2015.

CNAS-Lab Code: L8169

Shenzhen Global Test Service Co.,Ltd. has been assessed and proved to be in compliance with CNAS-CL01 Accreditation Criteria for Testing and Calibration Laboratories (identical to ISO/IEC 17025: 2005 General Requirements) for the Competence of Testing and Calibration Laboratories. Date of Registration: Dec. 11, 2015. Valid time is until Dec. 10, 2018.

FCC-Registration No.: 970318

Shenzhen CTL Testing Technology Co., Ltd. EMC Laboratory has been registered and fully described in a report filed with the (FCC) Federal Communications Commission. The acceptance letter from the FCC is maintained in our files. Registration 970318, December 19, 2013.

3.3. Environmental conditions

During the measurement the environmental conditions were within the listed ranges:

Temperature:	15-35 ° C
Humidity:	30-60 %
Atmospheric pressure:	950-1050mbar

3.4. Test Description

Test Specification clause	Test case	Test Mode	Test Channel	Recorded In Report		Pass	Fail	NA	NP	Remark
§15.247(b)(4)	Antenna gain	802.11b	<input checked="" type="checkbox"/> Lowest <input checked="" type="checkbox"/> Middle <input checked="" type="checkbox"/> Highest	802.11b	<input checked="" type="checkbox"/> Lowest <input checked="" type="checkbox"/> Middle <input checked="" type="checkbox"/> Highest	<input checked="" type="checkbox"/>	<input type="checkbox"/>	<input type="checkbox"/>	<input type="checkbox"/>	complies
§15.247(e)	Power spectral density	802.11b 802.11g 802.11n HT20 802.11n HT40	<input checked="" type="checkbox"/> Lowest <input checked="" type="checkbox"/> Middle <input checked="" type="checkbox"/> Highest	802.11b 802.11g 802.11n HT20 802.11n HT40	<input checked="" type="checkbox"/> Lowest <input checked="" type="checkbox"/> Middle <input checked="" type="checkbox"/> Highest	<input checked="" type="checkbox"/>	<input type="checkbox"/>	<input type="checkbox"/>	<input type="checkbox"/>	complies
§15.247(a)(2)	Spectrum bandwidth – 6 dB bandwidth	802.11b 802.11g 802.11n HT20 802.11n HT40	<input checked="" type="checkbox"/> Lowest <input checked="" type="checkbox"/> Middle <input checked="" type="checkbox"/> Highest	802.11b 802.11g 802.11n HT20 802.11n HT40	<input checked="" type="checkbox"/> Lowest <input checked="" type="checkbox"/> Middle <input checked="" type="checkbox"/> Highest	<input checked="" type="checkbox"/> <input checked="" type="checkbox"/>	<input type="checkbox"/>	<input type="checkbox"/>	<input type="checkbox"/>	complies
§15.247(b)(1)	Maximum output power	802.11b 802.11g 802.11n HT20 802.11n HT40	<input checked="" type="checkbox"/> Lowest <input checked="" type="checkbox"/> Middle <input checked="" type="checkbox"/> Highest	802.11b 802.11g 802.11n HT20 802.11n HT40	<input checked="" type="checkbox"/> Lowest <input checked="" type="checkbox"/> Middle <input checked="" type="checkbox"/> Highest	<input checked="" type="checkbox"/> <input checked="" type="checkbox"/> <input checked="" type="checkbox"/>	<input type="checkbox"/>	<input type="checkbox"/>	<input type="checkbox"/>	complies
§15.247(d)	Band edge compliance conducted	802.11b 802.11g 802.11n HT20 802.11n HT40	<input checked="" type="checkbox"/> Lowest <input checked="" type="checkbox"/> Highest	802.11b 802.11g 802.11n HT20 802.11n HT40	<input checked="" type="checkbox"/> Lowest <input checked="" type="checkbox"/> Highest	<input checked="" type="checkbox"/> <input checked="" type="checkbox"/>	<input type="checkbox"/>	<input type="checkbox"/>	<input type="checkbox"/>	complies
§15.205	Band edge compliance radiated	802.11b 802.11g 802.11n HT20 802.11n HT40	<input checked="" type="checkbox"/> Lowest <input checked="" type="checkbox"/> Highest	802.11b 802.11g 802.11n HT20 802.11n HT40	<input checked="" type="checkbox"/> Lowest <input checked="" type="checkbox"/> Highest	<input checked="" type="checkbox"/>	<input type="checkbox"/>	<input type="checkbox"/>	<input type="checkbox"/>	complies
§15.247(d)	TX spurious emissions conducted	802.11b 802.11g 802.11n HT20 802.11n HT40	<input checked="" type="checkbox"/> Lowest <input checked="" type="checkbox"/> Middle <input checked="" type="checkbox"/> Highest	802.11b 802.11g 802.11n HT20 802.11n HT40	<input checked="" type="checkbox"/> Lowest <input checked="" type="checkbox"/> Middle <input checked="" type="checkbox"/> Highest	<input checked="" type="checkbox"/> <input checked="" type="checkbox"/>	<input type="checkbox"/>	<input type="checkbox"/>	<input type="checkbox"/>	complies
§15.247(d)	TX spurious emissions radiated	802.11b 802.11g 802.11n HT20 802.11n HT40	<input checked="" type="checkbox"/> Lowest <input checked="" type="checkbox"/> Middle <input checked="" type="checkbox"/> Highest	802.11b 802.11g 802.11n HT20 802.11n HT40	<input checked="" type="checkbox"/> Lowest <input checked="" type="checkbox"/> Middle <input checked="" type="checkbox"/> Highest	<input checked="" type="checkbox"/>	<input type="checkbox"/>	<input type="checkbox"/>	<input type="checkbox"/>	complies
§15.109	RX spurious emissions radiated	-/-	-/-	-/-	-/-	<input type="checkbox"/>	<input type="checkbox"/>	<input checked="" type="checkbox"/>	<input type="checkbox"/>	complies
§15.209(a)	TX spurious Emissions radiated < 30 MHz	802.11b 802.11g 802.11n HT20 802.11n HT40	-/-	802.11b	-/-	<input checked="" type="checkbox"/>	<input type="checkbox"/>	<input type="checkbox"/>	<input type="checkbox"/>	complies
§15.107(a) §15.207	Conducted Emissions < 30 MHz	802.11b 802.11g 802.11n HT20 802.11n HT40	-/-	802.11b	-/-	<input checked="" type="checkbox"/>	<input type="checkbox"/>	<input type="checkbox"/>	<input type="checkbox"/>	complies

Remark:

- The measurement uncertainty is not included in the test result.
- NA = Not Applicable; NP = Not Performed

Preliminary tests were performed in different data rate to find the worst radiated emission. The data rate shown in the table below is the worst-case rate with respect to the specific test item. Investigation has been done on all the possible configurations for searching the worst cases. The following table is a list of the test modes shown in this test report.

Test Items	Mode	Data Rate	Channel
Maximum Peak Conducted Output Power Power Spectral Density 6dB Bandwidth Spurious RF conducted emission Radiated Emission 9kHz~1GHz& Radiated Emission 1GHz~10 th Harmonic	11b/DSSS	1 Mbps	1/6/11
	11g/OFDM	6 Mbps	1/6/11
	11n(20MHz)/OFDM	6.5Mbps	1/6/11
	11n(40MHz)/OFDM	13.5 Mbps	3/6/9
Band Edge	11b/DSSS	1 Mbps	1/11
	11g/OFDM	6 Mbps	1/11
	11n(20MHz)/OFDM	6.5Mbps	1/11
	11n(40MHz)/OFDM	13.5 Mbps	3/9

3.5. Statement of the measurement uncertainty

The data and results referenced in this document are true and accurate. The reader is cautioned that there may be errors within the calibration limits of the equipment and facilities. The measurement uncertainty was calculated for all measurements listed in this test report acc. to CISPR 16 - 4 „Specification for radio disturbance and immunity measuring apparatus and methods – Part 4: Uncertainty in EMC Measurements“ and is documented in the Shenzhen Global Test Service Co.,Ltd quality system acc. to DIN EN ISO/IEC 17025. Furthermore, component and process variability of devices similar to that tested may result in additional deviation. The manufacturer has the sole responsibility of continued compliance of the device.

Hereafter the best measurement capability for Shenzhen GTS laboratory is reported:

Test	Range	Measurement Uncertainty	Notes
Radiated Emission	30~1000MHz	4.10 dB	(1)
Radiated Emission	1~18GHz	4.32 dB	(1)
Radiated Emission	18-40GHz	5.54 dB	(1)
Conducted Disturbance	0.15~30MHz	3.12 dB	(1)

- (1) This uncertainty represents an expanded uncertainty expressed at approximately the 95% confidence level using a coverage factor of k=2.

3.6. Equipments Used during the Test

Test Equipment	Manufacturer	Model No.	Serial No.	Calibration Date	Calibration Due Date
LISN	R&S	ENV216	3560.6550.08	2016/05/28	2017/05/27
LISN	R&S	ESH2-Z5	893606/008	2016/05/27	2017/05/26
Bilog Antenna	Sunol Sciences Corp.	JB1	A061713	2016/06/02	2017/06/01
EMI Test Receiver	R&S	ESCI	101102	2016/06/26	2017/06/25
Spectrum Analyzer	Agilent	N9020A	MY48010425	2016/06/17	2017/06/16
Controller	EM Electronics	Controller EM 1000	N/A	2016/05/21	2017/05/20
Horn Antenna	Sunol Sciences Corp.	DRH-118	A062013	2016/05/19	2017/05/18
Active Loop Antenna	SCHWARZBECK	FMZB1519	1519-037	2016/05/19	2017/05/18
Amplifier	Agilent	8349B	3008A02306	2016/05/19	2017/05/18
Amplifier	Agilent	8447D	2944A10176	2016/05/19	2017/05/18
Temperature/Humidity Meter	Gangxing	CTH-608	02	2016/05/20	2017/05/19
High-Pass Filter	K&L	9SH10-2700/X12750-O/O	N/A	2016/05/20	2017/05/19
High-Pass Filter	K&L	41H10-1375/U12750-O/O	N/A	2016/05/20	2017/05/19
Data acquisition card	Agilent	U2531A	TW53323507	2016/05/20	2017/05/19
Power Sensor	Agilent	U2021XA	MY5365004	2016/05/20	2017/05/19
RF Cable	HUBER+SUHNER	RG214	N/A	2016/05/20	2017/05/19

Note: The Cal.Interval was one year.

4. TEST CONDITIONS AND RESULTS

4.1. AC Power Conducted Emission

TEST CONFIGURATION

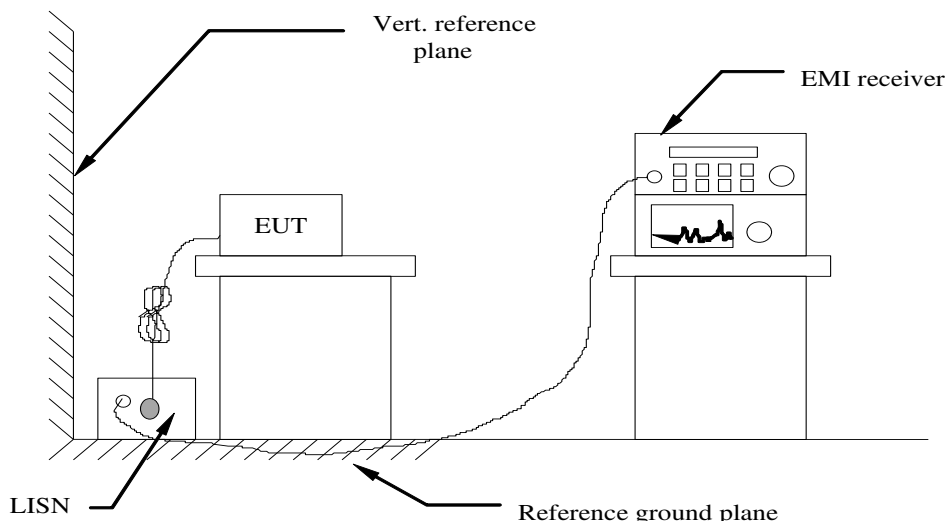

TEST PROCEDURE

- 1 The equipment was set up as per the test configuration to simulate typical actual usage per the user's manual. The EUT is a tabletop system, a wooden table with a height of 0.8 meters is used and is placed on the ground plane as per ANSI C63.10-2013.
- 2 Support equipment, if needed, was placed as per ANSI C63.10-2013
- 3 All I/O cables were positioned to simulate typical actual usage as per ANSI C63.10-2013
- 4 The EUT received DC 5V power from adapter, the adapter received AC120V/60Hz and AC 240V/60Hz power through a Line Impedance Stabilization Network (LISN) which supplied power source and was grounded to the ground plane.
- 5 All support equipments received AC power from a second LISN, if any.
- 6 The EUT test program was started. Emissions were measured on each current carrying line of the EUT using a spectrum Analyzer / Receiver connected to the LISN powering the EUT. The LISN has two monitoring points: Line 1 (Hot Side) and Line 2 (Neutral Side). Two scans were taken: one with Line 1 connected to Analyzer / Receiver and Line 2 connected to a 50 ohm load; the second scan had Line 1 connected to a 50 ohm load and Line 2 connected to the Analyzer / Receiver.
- 7 Analyzer / Receiver scanned from 150 KHz to 30MHz for emissions in each of the test modes.
- 8 During the above scans, the emissions were maximized by cable manipulation.

AC Power Conducted Emission Limit

For intentional device, according to § 15.207(a) AC Power Conducted Emission Limits is as following :

Frequency range (MHz)	Limit (dBuV)	
	Quasi-peak	Average
0.15-0.5	66 to 56*	56 to 46*
0.5-5	56	46
5-30	60	50

* Decreases with the logarithm of the frequency.

TEST RESULTS

Remark: We measured Conducted Emission at 802.11b/802.11g/802.11n HT20/802.11n HT40 mode in AC 120V/60Hz and 240V/60Hz, the worst case was recorded .

Power supply:	DC 5V from Adapter AC 120V/60Hz	Polarization	L
---------------	------------------------------------	--------------	---

SCAN TABLE: "Voltage (9K-30M)FIN"
 Short Description: 150K-30M Voltage

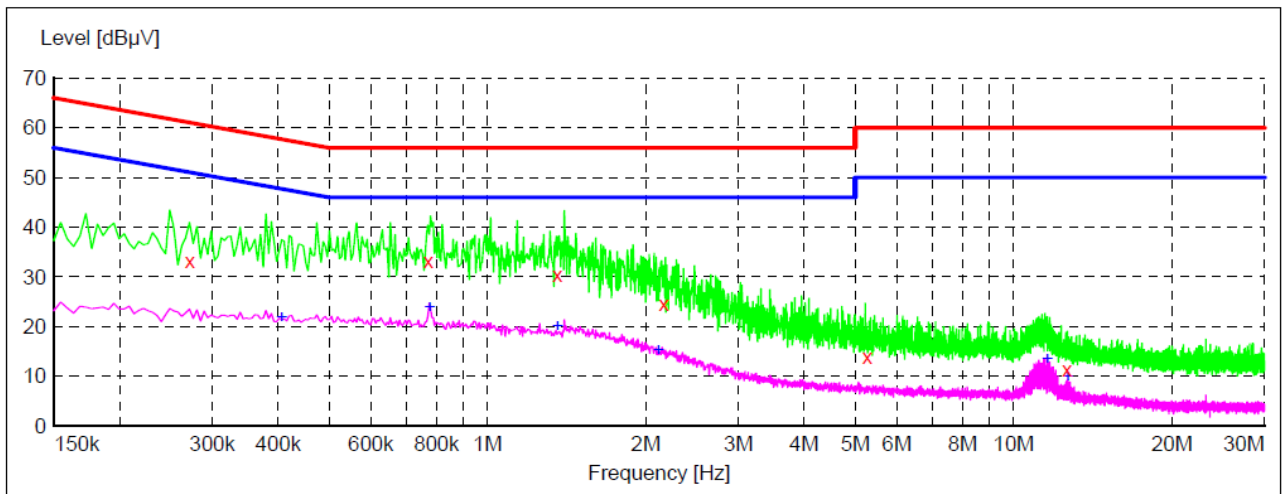

x x x MES GTS170424115_fin

MEASUREMENT RESULT: "GTS170424115_fin"

4/24/2017 10:58AM

Frequency MHz	Level dBµV	Transd dB	Limit dBµV	Margin dB	Detector	Line	PE
0.271500	33.20	9.9	61	27.9	QP	L1	GND
0.771000	33.20	9.7	56	22.8	QP	L1	GND
1.356000	30.40	9.6	56	25.6	QP	L1	GND
2.161500	24.60	9.5	56	31.4	QP	L1	GND
5.266500	13.80	9.3	60	46.2	QP	L1	GND
12.624000	11.40	8.5	60	48.6	QP	L1	GND

MEASUREMENT RESULT: "GTS170424115_fin2"

4/24/2017 10:58AM

Frequency MHz	Level dBµV	Transd dB	Limit dBµV	Margin dB	Detector	Line	PE
0.406500	21.80	9.8	48	25.9	AV	L1	GND
0.775500	23.70	9.7	46	22.3	AV	L1	GND
1.360500	19.90	9.6	46	26.1	AV	L1	GND
2.112000	15.10	9.5	46	30.9	AV	L1	GND
11.602500	13.50	8.6	50	36.5	AV	L1	GND
12.691500	9.90	8.5	50	40.1	AV	L1	GND

Power supply:	DC 5V from Adapter AC 120V/60Hz	Polarization	N
---------------	------------------------------------	--------------	---

SCAN TABLE: "Voltage (9K-30M) FIN"
 Short Description: 150K-30M Voltage

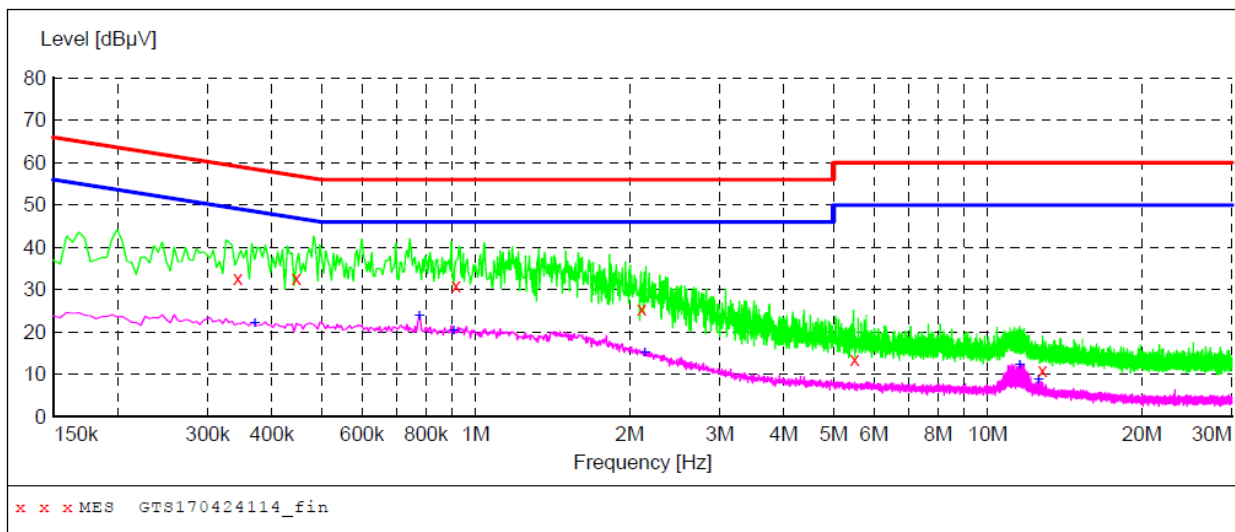

MEASUREMENT RESULT: "GTS170424114_fin"

4/24/2017 10:54AM

Frequency MHz	Level dBµV	Transd dB	Limit dBµV	Margin dB	Detector	Line	PE
0.343500	32.70	9.9	59	26.4	QP	N	GND
0.447000	32.70	9.8	57	24.2	QP	N	GND
0.915000	31.00	9.6	56	25.0	QP	N	GND
2.112000	25.40	9.5	56	30.6	QP	N	GND
5.491500	13.60	9.3	60	46.4	QP	N	GND
12.804000	10.90	8.5	60	49.1	QP	N	GND

MEASUREMENT RESULT: "GTS170424114_fin2"

4/24/2017 10:54AM

Frequency MHz	Level dBµV	Transd dB	Limit dBµV	Margin dB	Detector	Line	PE
0.370500	22.10	9.9	49	26.4	AV	N	GND
0.775500	23.70	9.7	46	22.3	AV	N	GND
0.906000	20.30	9.6	46	25.7	AV	N	GND
2.139000	14.90	9.5	46	31.1	AV	N	GND
11.544000	12.00	8.6	50	38.0	AV	N	GND
12.570000	8.60	8.5	50	41.4	AV	N	GND

4.2. Radiated Emission

TEST CONFIGURATION

Frequency range 9 KHz – 30MHz

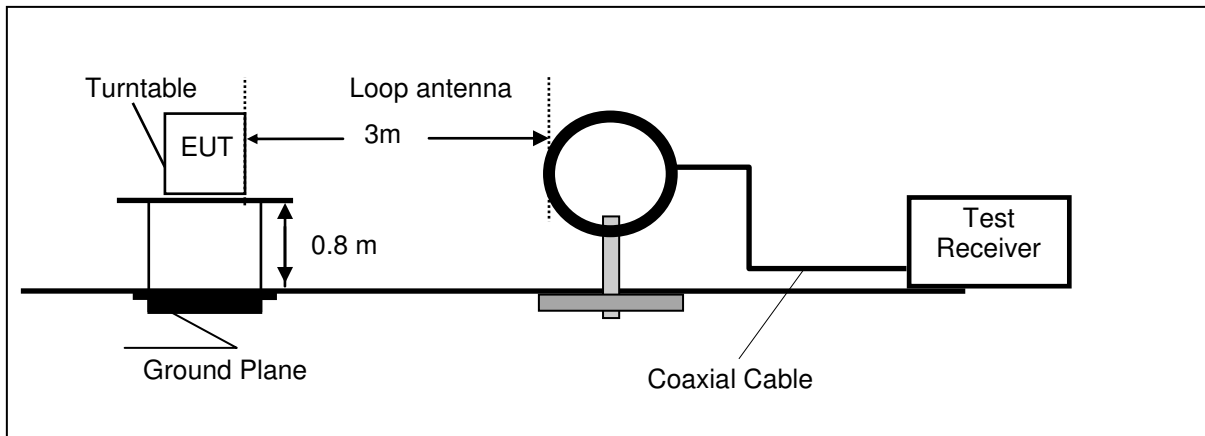

Frequency range 30MHz – 1000MHz

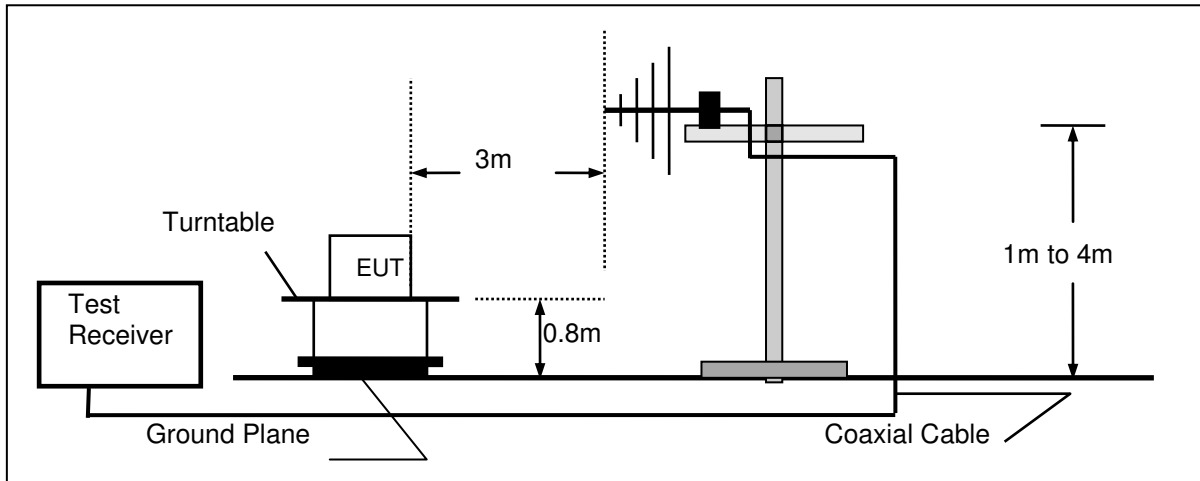

Frequency range above 1GHz-25GHz

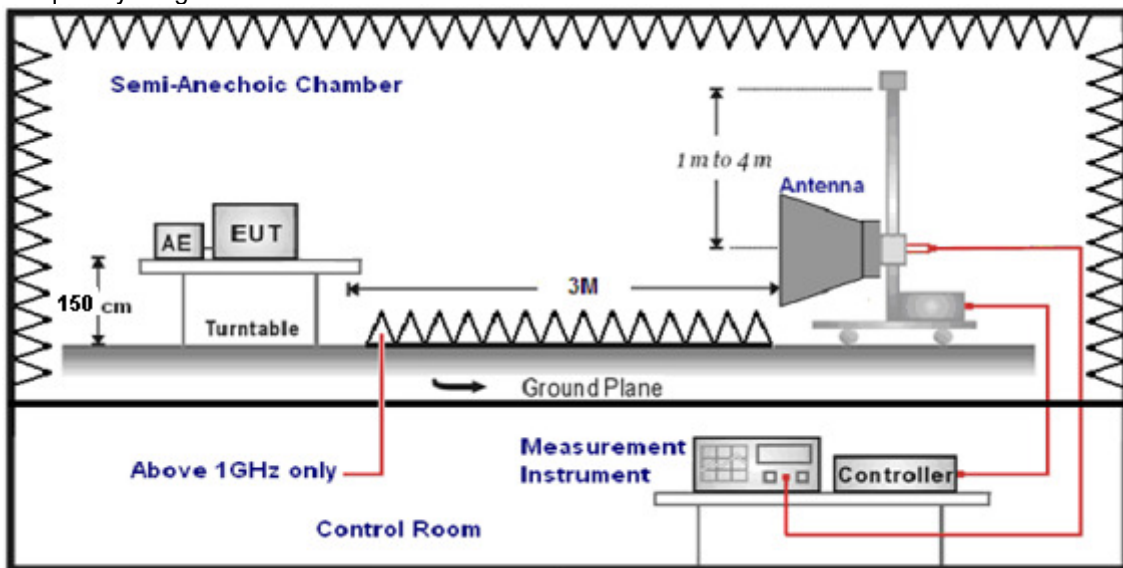

TEST PROCEDURE

1. The EUT was placed on a turn table which is 0.8m above ground plane when testing frequency range 9 KHz –1GHz;the EUT was placed on a turn table which is 1.5m above ground plane when testing frequency range 1GHz – 25GHz.
2. Maximum procedure was performed by raising the receiving antenna from 1m to 4m and rotating the turn table from 0° to 360° to acquire the highest emissions from EUT.
3. And also, each emission was to be maximized by changing the polarization of receiving antenna both horizontal and vertical.
4. Repeat above procedures until all frequency measurements have been completed.
5. The EUT minimum operation frequency was 32.768KHz and maximum operation frequency was 2480MHz.so radiated emission test frequency band from 9KHz to 25GHz.
6. The distance between test antenna and EUT as following table states:

Test Frequency range	Test Antenna Type	Test Distance
9KHz-30MHz	Active Loop Antenna	3
30MHz-1GHz	Ultra-Broadband Antenna	3
1GHz-18GHz	Double Ridged Horn Antenna	3
18GHz-25GHz	Horn Antenna	1

7. Setting test receiver/spectrum as following table states:

Test Frequency range	Test Receiver/Spectrum Setting	Detector
9KHz-150KHz	RBW=200Hz/VBW=3KHz,Sweep time=Auto	QP
150KHz-30MHz	RBW=9KHz/VBW=100KHz,Sweep time=Auto	QP
30MHz-1GHz	RBW=120KHz/VBW=1000KHz,Sweep time=Auto	QP
1GHz-40GHz	Peak Value: RBW=1MHz/VBW=3MHz, Sweep time=Auto Average Value: RBW=1MHz/VBW=10Hz, Sweep time=Auto	Peak

Field Strength Calculation

The field strength is calculated by adding the Antenna Factor and Cable Factor and subtracting the Amplifier Gain and Duty Cycle Correction Factor(if any) from the measured reading. The basic equation with a sample calculation is as follows:

$$FS = RA + AF + CL - AG$$

Where FS = Field Strength	CL = Cable Attenuation Factor (Cable Loss)
RA = Reading Amplitude	AG = Amplifier Gain
AF = Antenna Factor	

$$\text{Transd}=AF +CL-AG$$

RADIATION LIMIT

For intentional device, according to § 15.209(a), the general requirement of field strength of radiated emission from intentional radiators at a distance of 3 meters shall not exceed the following table. According to § 15.247(d), in any 100kHz bandwidth outside the frequency band in which the EUT is operating, the radio frequency power that is produced by the intentional radiator shall be at least 20dB below that in the100kHz bandwidth within the band that contains the highest level of desired power.

The pre-test have done for the EUT in three axes and found the worst emission at position shown in test setup photos.

Frequency (MHz)	Distance (Meters)	Radiated (dBµV/m)	Radiated (µV/m)
0.009-0.49	3	$20\log(2400/F(\text{KHz}))+40\log(300/3)$	$2400/F(\text{KHz})$
0.49-1.705	3	$20\log(24000/F(\text{KHz}))+40\log(30/3)$	$24000/F(\text{KHz})$
1.705-30	3	$20\log(30)+40\log(30/3)$	30
30-88	3	40.0	100
88-216	3	43.5	150
216-960	3	46.0	200
Above 960	3	54.0	500

TEST RESULTS

Remark: We measured Radiated Emission at 802.11b/802.11g/802.11n HT20/802.11n HT40 mode from 9 KHz to 25GHz in AC 120V/60Hz and AC 240V/60Hz and recorded worst case at 802.11b mode.
 Test site: Shenzhen CTL Testing Technology Co., Ltd

For 9 KHz-30MHz

Frequency (MHz)	Corrected Reading (dBuV/m)@3m	FCC Limit (dBuV/m) @3m	Margin (dB)	Detector	Result
0.27	50.45	98.98	48.53	QP	PASS
0.65	43.86	71.35	27.49	QP	PASS
18.26	45.02	69.54	24.52	QP	PASS
23.42	44.32	69.54	25.22	QP	PASS

For 30MHz-1GHz

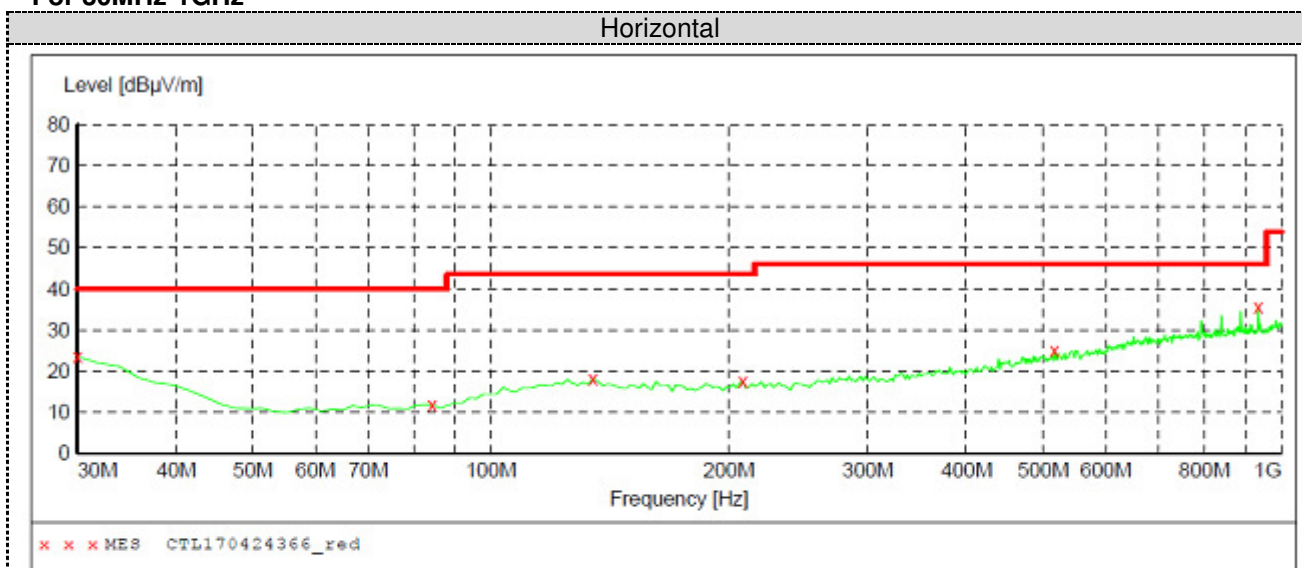

MEASUREMENT RESULT: "CTL170424366_red"

4/24/2017 12:21PM

Frequency MHz	Level dBuV/m	Transd dB	Limit dBuV/m	Margin dB	Det.	Height cm	Azimuth deg	Polarization
30.000000	23.50	20.8	40.0	16.5	PK	100	62.6	HORIZONTAL
84.320000	12.00	8.8	40.0	28.0	PK	100	18.0	HORIZONTAL
134.760000	18.20	14.4	43.5	25.3	PK	100	36.2	HORIZONTAL
208.480000	17.60	14.0	43.5	25.9	PK	100	126.8	HORIZONTAL
516.940000	25.10	20.3	46.0	20.9	PK	100	200.0	HORIZONTAL
935.980000	35.80	26.3	46.0	10.2	PK	100	261.0	HORIZONTAL

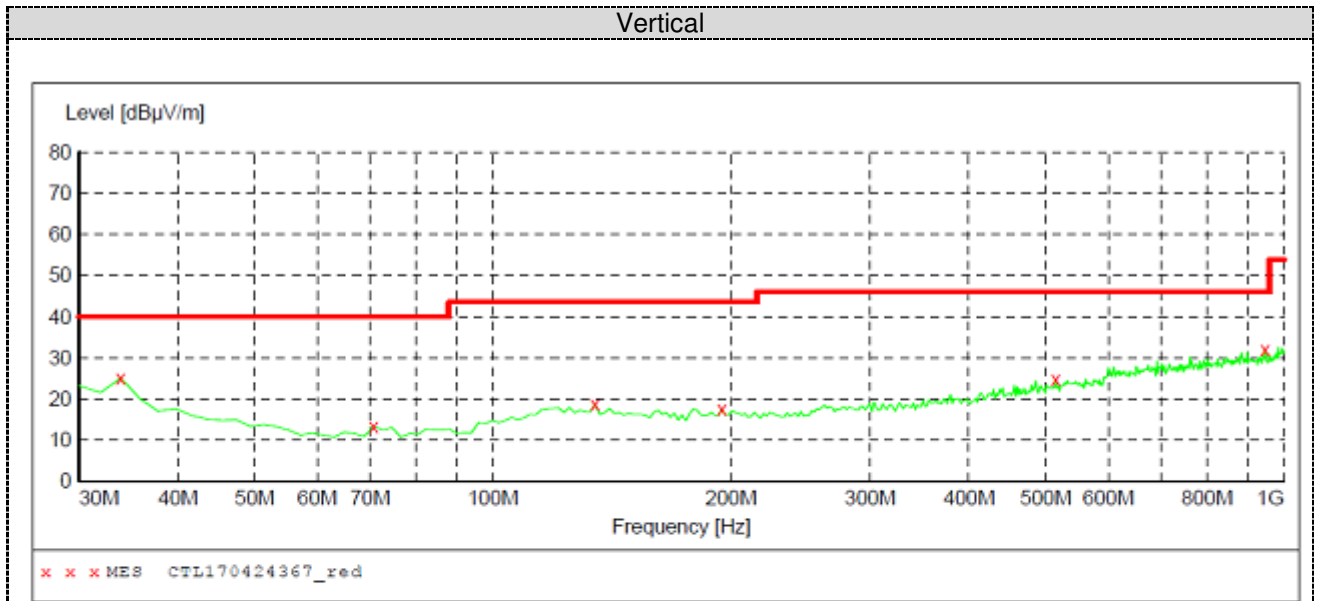

MEASUREMENT RESULT: "CTL170424367_red"

4/24/2017 12:22PM

Frequency MHz	Level dBµV/m	Transd dB	Limit dBµV/m	Margin dB	Det.	Height cm	Azimuth deg	Polarization
33.880000	25.10	17.7	40.0	14.9	PK	100	18.2	VERTICAL
70.740000	13.30	8.2	40.0	26.7	PK	100	36.0	VERTICAL
134.760000	18.70	14.4	43.5	24.8	PK	100	118.0	VERTICAL
194.900000	17.60	13.2	43.5	25.9	PK	100	165.8	VERTICAL
515.000000	24.80	20.3	46.0	21.2	PK	100	196.0	VERTICAL
947.620000	32.10	26.5	46.0	13.9	PK	100	269.0	VERTICAL

For 1GHz to 25GHz

802.11b Mode (above 1GHz)

Frequency(MHz):				2412			Polarity:			HORIZONTAL		
No.	Frequency (MHz)	Emission Level (dBuV/m)		Limit (dBuV/m)	Margin (dB)	Antenna Height (m)	Table Angle (Degree)	Raw Value (dBuV)	Antenna Factor (dB/m)	Cable Factor (dB)	Pre-amplifier	Correction Factor (dB/m)
1	4824	54.97	PK	74	19.03	1.00	129	52.87	31.6	7.00	36.5	2.10
1	4824	40.73	AV	54	13.27	1.00	129	38.63	31.6	7.00	36.5	2.10
2	7236	52.86	PK	74	21.14	1.00	216	41.93	37.33	8.90	35.3	10.93
2	7236	40.59	AV	54	13.41	1.00	216	29.66	37.33	8.90	35.3	10.93

Frequency(MHz):				2412			Polarity:			VERTICAL		
No.	Frequency (MHz)	Emission Level (dBuV/m)		Limit (dBuV/m)	Margin (dB)	Antenna Height (m)	Table Angle (Degree)	Raw Value (dBuV)	Antenna Factor (dB/m)	Cable Factor (dB)	Pre-amplifier	Correction Factor (dB/m)
1	4824	56.96	PK	74	17.04	1.00	159	54.86	31.60	7.00	36.50	2.10
1	4824	42.78	AV	54	11.22	1.00	159	40.68	31.60	7.00	36.50	2.10
2	7236	52.39	PK	74	21.61	1.00	261	41.46	37.33	8.90	35.30	10.93
2	7236	42.99	AV	54	11.01	1.00	261	32.06	37.33	8.90	35.30	10.93

Frequency(MHz):				2437			Polarity:			HORIZONTAL		
No.	Frequency (MHz)	Emission Level (dBuV/m)		Limit (dBuV/m)	Margin (dB)	Antenna Height (m)	Table Angle (Degree)	Raw Value (dBuV)	Antenna Factor (dB/m)	Cable Factor (dB)	Pre-amplifier	Correction Factor (dB/m)
1	4874.00	58.95	PK	74.00	15.05	1.00	235	56.83	31.02	7.60	36.5	2.12
1	4874.00	40.35	AV	54.00	13.65	1.00	235	38.23	31.02	7.60	36.5	2.12
2	7311.00	55.92	PK	74.00	18.08	1.00	165	44.84	37.28	8.60	34.8	11.08
2	7311.00	40.90	AV	54.00	13.10	1.00	165	29.82	37.28	8.60	34.8	11.08

Frequency(MHz):				2437			Polarity:			VERTICAL		
No.	Frequency (MHz)	Emission Level (dBuV/m)		Limit (dBuV/m)	Margin (dB)	Antenna Height (m)	Table Angle (Degree)	Raw Value (dBuV)	Antenna Factor (dB/m)	Cable Factor (dB)	Pre-amplifier	Correction Factor (dB/m)
1	4874.00	59.27	PK	74.00	14.73	1.00	205	57.15	31.02	7.60	36.5	2.12
1	4874.00	42.02	AV	54.00	11.98	1.00	205	39.90	31.02	7.60	36.5	2.12
2	7311.00	54.34	PK	74.00	19.66	1.00	296	43.26	37.28	8.60	34.8	11.08
2	7311.00	41.95	AV	54.00	12.05	1.00	296	30.87	37.28	8.60	34.8	11.08

Frequency(MHz):				2462			Polarity:			HORIZONTAL		
No.	Frequency (MHz)	Emission Level (dBuV/m)		Limit (dBuV/m)	Margin (dB)	Antenna Height (m)	Table Angle (Degree)	Raw Value (dBuV)	Antenna Factor (dB/m)	Cable Factor (dB)	Pre-amplifier	Correction Factor (dB/m)
1	4924.00	60.33	PK	74.00	13.67	1.00	132	57.13	31.58	7.82	36.2	3.20
1	4924.00	41.05	AV	54.00	12.95	1.00	132	37.85	31.58	7.82	36.2	3.20
2	7386.00	55.97	PK	74.00	18.03	1.00	228	44.03	38.51	8.73	35.3	11.94
2	7386.00	40.04	AV	54.00	13.96	1.00	228	28.10	38.51	8.73	35.3	11.94

Frequency(MHz):				2462			Polarity:			VERTICAL		
No.	Frequency (MHz)	Emission Level (dBuV/m)		Limit (dBuV/m)	Margin (dB)	Antenna Height (m)	Table Angle (Degree)	Raw Value (dBuV)	Antenna Factor (dB/m)	Cable Factor (dB)	Pre-amplifier (dB)	Correction Factor (dB/m)
1	4924.00	58.34	PK	74.00	15.66	1.00	137	55.14	31.58	7.82	36.2	3.20
1	4924.00	40.86	AV	54.00	13.14	1.00	137	37.66	31.58	7.82	36.2	3.20
2	7386.00	53.94	PK	74.00	20.06	1.00	279	42.00	38.51	8.73	35.3	11.94
2	7386.00	41.97	AV	54.00	12.03	1.00	279	30.03	38.51	8.73	35.3	11.94

802.11g Mode (above 1GHz)

Frequency(MHz):				2412			Polarity:			HORIZONTAL		
No.	Frequency (MHz)	Emission Level (dBuV/m)		Limit (dBuV/m)	Margin (dB)	Antenna Height (m)	Table Angle (Degree)	Raw Value (dBuV)	Antenna Factor (dB/m)	Cable Factor (dB)	Pre-amplifier	Correction Factor (dB/m)
1	4824	60.41	PK	74	13.59	1.00	82	58.31	31.6	7.00	36.5	2.10
1	4824	43.18	AV	54	10.82	1.00	82	41.08	31.6	7.00	36.5	2.10
2	7236	53.09	PK	74	20.91	1.00	169	42.16	37.33	8.90	35.3	10.93
2	7236	39.72	AV	54	14.28	1.00	169	28.79	37.33	8.90	35.3	10.93

Frequency(MHz):				2412			Polarity:			VERTICAL		
No.	Frequency (MHz)	Emission Level (dBuV/m)		Limit (dBuV/m)	Margin (dB)	Antenna Height (m)	Table Angle (Degree)	Raw Value (dBuV)	Antenna Factor (dB/m)	Cable Factor (dB)	Pre-amplifier	Correction Factor (dB/m)
1	4824	60.47	PK	74	13.53	1.00	113	58.37	31.60	7.00	36.50	2.10
1	4824	41.13	AV	54	12.87	1.00	113	39.03	31.60	7.00	36.50	2.10
2	7236	54.37	PK	74	19.63	1.00	170	43.44	37.33	8.90	35.30	10.93
2	7236	41.00	AV	54	13.00	1.00	170	30.07	37.33	8.90	35.30	10.93

Frequency(MHz):				2437			Polarity:			HORIZONTAL		
No.	Frequency (MHz)	Emission Level (dBuV/m)		Limit (dBuV/m)	Margin (dB)	Antenna Height (m)	Table Angle (Degree)	Raw Value (dBuV)	Antenna Factor (dB/m)	Cable Factor (dB)	Pre-amplifier	Correction Factor (dB/m)
1	4874.00	59.20	PK	74.00	14.80	1.00	121	57.10	31.02	7.60	36.5	2.12
1	4874.00	41.60	AV	54.00	12.40	1.00	121	39.48	31.02	7.60	36.5	2.12
2	7311.00	54.18	PK	74.00	19.82	1.00	218	43.10	37.28	8.60	34.8	11.08
2	7311.00	41.92	AV	54.00	12.08	1.00	218	30.84	37.28	8.60	34.8	11.08

Frequency(MHz):				2437			Polarity:			VERTICAL		
No.	Frequency (MHz)	Emission Level (dBuV/m)		Limit (dBuV/m)	Margin (dB)	Antenna Height (m)	Table Angle (Degree)	Raw Value (dBuV)	Antenna Factor (dB/m)	Cable Factor (dB)	Pre-amplifier	Correction Factor (dB/m)
1	4874.00	59.42	PK	74.00	14.58	1.00	135	57.30	31.02	7.60	36.5	2.12
1	4874.00	41.97	AV	54.00	12.03	1.00	135	39.85	31.02	7.60	36.5	2.12
2	7311.00	56.55	PK	74.00	17.45	1.00	252	45.47	37.28	8.60	34.8	11.08
2	7311.00	40.51	AV	54.00	13.49	1.00	252	29.43	37.28	8.60	34.8	11.08

Frequency(MHz):				2462			Polarity:			HORIZONTAL		
No.	Frequency (MHz)	Emission Level (dBuV/m)		Limit (dBuV/m)	Margin (dB)	Antenna Height (m)	Table Angle (Degree)	Raw Value (dBuV)	Antenna Factor (dB/m)	Cable Factor (dB)	Pre-amplifier	Correction Factor (dB/m)
1	4924.00	60.07	PK	74.00	13.93	1.00	126	56.87	31.58	7.82	36.2	3.20
1	4924.00	41.88	AV	54.00	12.12	1.00	126	38.68	31.58	7.82	36.2	3.20
2	7386.00	54.40	PK	74.00	19.60	1.00	249	42.46	38.51	8.73	35.3	11.94
2	7386.00	40.31	AV	54.00	13.69	1.00	249	28.37	38.51	8.73	35.3	11.94

Frequency(MHz):				2462			Polarity:			VERTICAL		
No.	Frequency (MHz)	Emission Level (dBuV/m)		Limit (dBuV/m)	Margin (dB)	Antenna Height (m)	Table Angle (Degree)	Raw Value (dBuV)	Antenna Factor (dB/m)	Cable Factor (dB)	Pre-amplifier	Correction Factor (dB/m)
1	4924.00	60.61	PK	74.00	13.39	1.00	119	57.41	31.58	7.82	36.2	3.20
1	4924.00	41.64	AV	54.00	12.36	1.00	119	38.44	31.58	7.82	36.2	3.20
2	7386.00	55.62	PK	74.00	18.38	1.00	256	43.68	38.51	8.73	35.3	11.94
2	7386.00	41.46	AV	54.00	12.54	1.00	256	29.52	38.51	8.73	35.3	11.94

802.11n HT20 Mode (above 1GHz)

Frequency(MHz):				2412			Polarity:			HORIZONTAL		
No.	Frequency (MHz)	Emission Level (dBuV/m)		Limit (dBuV/m)	Margin (dB)	Antenna Height (m)	Table Angle (Degree)	Raw Value (dBuV)	Antenna Factor (dB/m)	Cable Factor (dB)	Pre-amplifier	Correction Factor (dB/m)
1	4824	58.57	PK	74	15.43	1.00	106	56.47	31.6	7.00	36.5	2.10
1	4824	41.09	AV	54	12.91	1.00	106	38.99	31.6	7.00	36.5	2.10
2	7236	56.12	PK	74	17.88	1.00	182	45.19	37.33	8.90	35.3	10.93
2	7236	41.51	AV	54	12.49	1.00	182	30.58	37.33	8.90	35.3	10.93

Frequency(MHz):				2412			Polarity:			VERTICAL		
No.	Frequency (MHz)	Emission Level (dBuV/m)		Limit (dBuV/m)	Margin (dB)	Antenna Height (m)	Table Angle (Degree)	Raw Value (dBuV)	Antenna Factor (dB/m)	Cable Factor (dB)	Pre-amplifier	Correction Factor (dB/m)
1	4824	59.93	PK	74	14.07	1.00	159	57.83	31.60	7.00	36.50	2.10
1	4824	41.99	AV	54	12.01	1.00	159	39.89	31.60	7.00	36.50	2.10
2	7236	54.34	PK	74	19.66	1.00	252	43.41	37.33	8.90	35.30	10.93
2	7236	41.21	AV	54	12.79	1.00	252	30.28	37.33	8.90	35.30	10.93

Frequency(MHz):				2437			Polarity:			HORIZONTAL		
No.	Frequency (MHz)	Emission Level (dBuV/m)		Limit (dBuV/m)	Margin (dB)	Antenna Height (m)	Table Angle (Degree)	Raw Value (dBuV)	Antenna Factor (dB/m)	Cable Factor (dB)	Pre-amplifier	Correction Factor (dB/m)
1	4874.00	57.23	PK	74.00	16.77	1.00	129	55.11	31.02	7.60	36.5	2.12
1	4874.00	40.47	AV	54.00	13.53	1.00	129	38.35	31.02	7.60	36.5	2.12
2	7311.00	54.10	PK	74.00	19.90	1.00	253	43.02	37.28	8.60	34.8	11.08
2	7311.00	42.16	AV	54.00	11.84	1.00	253	31.08	37.28	8.60	34.8	11.08

Frequency(MHz):				2437			Polarity:			VERTICAL		
No.	Frequency (MHz)	Emission Level (dBuV/m)		Limit (dBuV/m)	Margin (dB)	Antenna Height (m)	Table Angle (Degree)	Raw Value (dBuV)	Antenna Factor (dB/m)	Cable Factor (dB)	Pre-amplifier	Correction Factor (dB/m)
1	4874.00	60.38	PK	74.00	13.62	1.00	68	58.26	31.02	7.60	36.5	2.12
1	4874.00	43.00	AV	54.00	11.00	1.00	68	40.88	31.02	7.60	36.5	2.12
2	7311.00	54.45	PK	74.00	19.55	1.00	157	43.37	37.28	8.60	34.8	11.08
2	7311.00	40.52	AV	54.00	13.48	1.00	157	29.44	37.28	8.60	34.8	11.08

Frequency(MHz):				2462			Polarity:			HORIZONTAL		
No.	Frequency (MHz)	Emission Level (dBuV/m)		Limit (dBuV/m)	Margin (dB)	Antenna Height (m)	Table Angle (Degree)	Raw Value (dBuV)	Antenna Factor (dB/m)	Cable Factor (dB)	Pre-amplifier	Correction Factor (dB/m)
1	4924.00	58.45	PK	74.00	15.55	1.00	156	55.25	31.58	7.82	36.2	3.20
1	4924.00	41.39	AV	54.00	12.61	1.00	156	38.19	31.58	7.82	36.2	3.20
2	7386.00	55.44	PK	74.00	18.56	1.00	242	43.50	38.51	8.73	35.3	11.94
2	7386.00	42.07	AV	54.00	11.93	1.00	242	30.13	38.51	8.73	35.3	11.94

Frequency(MHz):				2462			Polarity:			VERTICAL		
No.	Frequency (MHz)	Emission Level (dBuV/m)		Limit (dBuV/m)	Margin (dB)	Antenna Height (m)	Table Angle (Degree)	Raw Value (dBuV)	Antenna Factor (dB/m)	Cable Factor (dB)	Pre-amplifier	Correction Factor (dB/m)
1	4924.00	58.89	PK	74.00	15.11	1.00	129	55.69	31.58	7.82	36.2	3.20
1	4924.00	41.19	AV	54.00	12.81	1.00	129	37.99	31.58	7.82	36.2	3.20
2	7386.00	55.45	PK	74.00	18.55	1.00	272	43.51	38.51	8.73	35.3	11.94
2	7386.00	42.47	AV	54.00	11.53	1.00	272	30.53	38.51	8.73	35.3	11.94

802.11n HT40 Mode (above 1GHz)

Frequency(MHz):				2422			Polarity:			HORIZONTAL		
No.	Frequency (MHz)	Emission Level (dBuV/m)		Limit (dBuV/m)	Margin (dB)	Antenna Height (m)	Table Angle (Degree)	Raw Value (dBuV)	Antenna Factor (dB/m)	Cable Factor (dB)	Pre-amplifier	Correction Factor (dB/m)
1	4844	50.76	PK	74	23.24	1.00	192	48.62	31.62	7.02	36.5	2.14
1	4844	40.71	AV	54	13.29	1.00	192	38.57	31.62	7.02	36.5	2.14
2	7266	49.34	PK	74	24.66	1.00	136	38.36	37.35	8.93	35.3	10.98
2	7266	41.06	AV	54	12.94	1.00	136	30.08	37.35	8.93	35.3	10.98

Frequency(MHz):				2422			Polarity:			VERTICAL		
No.	Frequency (MHz)	Emission Level (dBuV/m)		Limit (dBuV/m)	Margin (dB)	Antenna Height (m)	Table Angle (Degree)	Raw Value (dBuV)	Antenna Factor (dB/m)	Cable Factor (dB)	Pre-amplifier	Correction Factor (dB/m)
1	4844	49.85	PK	74	24.15	1.00	119	47.71	31.62	7.02	36.5	2.14
1	4844	39.52	AV	54	14.48	1.00	119	37.38	31.62	7.02	36.5	2.14
2	7266	49.13	PK	74	24.87	1.00	257	38.15	37.35	8.93	35.3	10.98
2	7266	40.55	AV	54	13.45	1.00	257	29.57	37.35	8.93	35.3	10.98

Frequency(MHz):				2437			Polarity:			HORIZONTAL		
No.	Frequency (MHz)	Emission Level (dBuV/m)		Limit (dBuV/m)	Margin (dB)	Antenna Height (m)	Table Angle (Degree)	Raw Value (dBuV)	Antenna Factor (dB/m)	Cable Factor (dB)	Pre-amplifier	Correction Factor (dB/m)
1	4874.00	48.73	PK	74.00	25.27	1.00	276	46.61	31.02	7.60	36.5	2.12
1	4874.00	39.64	AV	54.00	14.36	1.00	276	37.52	31.02	7.60	36.5	2.12
2	7311.00	48.95	PK	74.00	25.05	1.00	128	37.87	37.28	8.60	34.8	11.08
2	7311.00	40.60	AV	54.00	13.40	1.00	128	29.52	37.28	8.60	34.8	11.08

Frequency(MHz):				2437			Polarity:			VERTICAL		
No.	Frequency (MHz)	Emission Level (dBuV/m)		Limit (dBuV/m)	Margin (dB)	Antenna Height (m)	Table Angle (Degree)	Raw Value (dBuV)	Antenna Factor (dB/m)	Cable Factor (dB)	Pre-amplifier	Correction Factor (dB/m)
1	4874.00	48.79	PK	74.00	25.21	1.00	105	46.67	31.02	7.60	36.5	2.12
1	4874.00	39.67	AV	54.00	14.33	1.00	105	37.55	31.02	7.60	36.5	2.12
2	7311.00	47.73	PK	74.00	26.27	1.00	207	36.65	37.28	8.60	34.8	11.08
2	7311.00	39.66	AV	54.00	14.34	1.00	207	28.58	37.28	8.60	34.8	11.08

Frequency(MHz):				2452			Polarity:			HORIZONTAL		
No.	Frequency (MHz)	Emission Level (dBuV/m)		Limit (dBuV/m)	Margin (dB)	Antenna Height (m)	Table Angle (Degree)	Raw Value (dBuV)	Antenna Factor (dB/m)	Cable Factor (dB)	Pre-amplifier	Correction Factor (dB/m)
1	4904.00	49.59	PK	74.00	24.41	1.00	179	46.44	31.55	7.80	36.2	3.15
1	4904.00	40.43	AV	54.00	13.57	1.00	179	37.28	31.55	7.80	36.2	3.15
2	7356.00	49.91	PK	74.00	24.09	1.00	225	38.05	38.47	8.69	35.3	11.86
2	7356.00	39.18	AV	54.00	14.82	1.00	225	27.32	38.47	8.69	35.3	11.86

Frequency(MHz):				2452			Polarity:			VERTICAL		
No.	Frequency (MHz)	Emission Level (dBuV/m)		Limit (dBuV/m)	Margin (dB)	Antenna Height (m)	Table Angle (Degree)	Raw Value (dBuV)	Antenna Factor (dB/m)	Cable Factor (dB)	Pre-amplifier	Correction Factor (dB/m)
1	4904.00	49.05	PK	74.00	24.95	1.00	152	45.90	31.55	7.80	36.2	3.15
1	4904.00	39.59	AV	54.00	14.41	1.00	152	36.44	31.55	7.80	36.2	3.15
2	7356.00	49.95	PK	74.00	24.05	1.00	269	38.09	38.47	8.69	35.3	11.86
2	7356.00	40.86	AV	54.00	13.14	1.00	269	29.00	38.47	8.69	35.3	11.86

REMARKS:

1. Emission level (dBuV/m) = Raw Value (dBuV) + Correction Factor (dB/m)
2. Correction Factor (dB/m) = Antenna Factor (dB/m) + Cable Factor (dB) - Pre-amplifier Factor
3. Margin value = Limit value - Emission level.
4. -- Mean the PK detector measured value is below average limit.
5. The other emission levels were very low against the limit.

4.3. Maximum Peak Output Power

TEST CONFIGURATION

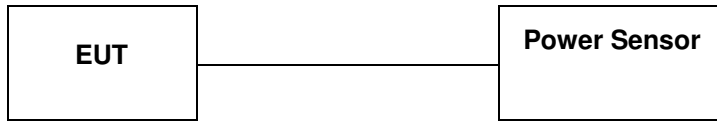

TEST PROCEDURE

According to KDB558074 D01 DTS Measurement Guidance Section 9.1 Maximum peak conducted output power, 9.1.2. and Average conducted output power, 9.2.3.1.

The maximum peak conducted output power may be measured using a broadband peak RF power meter. The power meter shall have a video bandwidth that is greater than or equal to the DTS bandwidth and shall utilize a fast-responding diode detector.

The maximum Average conducted output power may be measured using a wideband RF power meter with a thermocouple detector or equivalent. The power meter shall have a video bandwidth that is greater than or equal to the DTS bandwidth and shall utilize a fast-responding diode detector.

LIMIT

The Maximum Peak Output Power Measurement is 30dBm.

TEST RESULTS

Type	Channel	Output power PK (dBm)	Output power AV (dBm)	Limit (dBm)	Result
802.11b	01	18.12	15.02	30.00	Pass
	06	18.31	15.23		
	11	18.54	15.47		
802.11g	01	19.57	15.32	30.00	Pass
	06	19.68	15.47		
	11	19.82	15.56		
802.11n(HT20)	01	19.97	15.75	30.00	Pass
	06	20.03	15.82		
	11	20.13	15.96		
802.11n(HT40)	03	19.48	14.39	30.00	Pass
	06	19.24	14.20		
	09	19.17	14.08		

Note: 1.The test results including the cable lose.

Duty cycle used in all test items: 100%

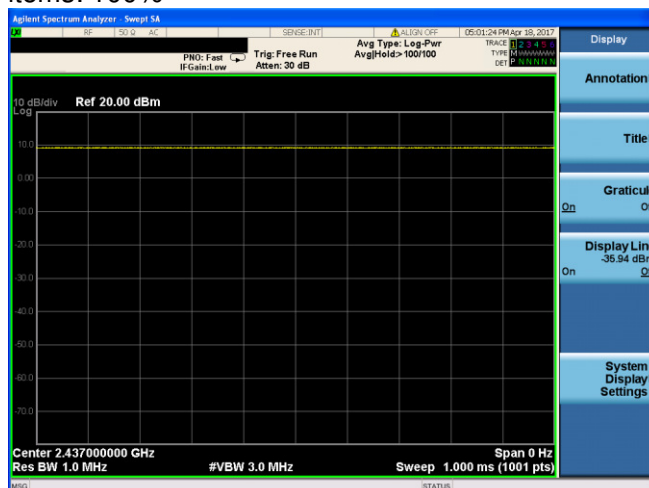

4.4. Power Spectral Density

TEST CONFIGURATION

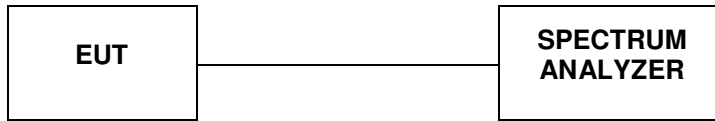

TEST PROCEDURE

According to KDB 558074 D01 Method PKPSD (peak PSD) This procedure shall be used if maximum peak conducted output power was used to demonstrate compliance, and is optional if the maximum conducted (average) output power was used to demonstrate compliance.

1. Set analyzer center frequency to DTS channel center frequency.
2. Set the span to 1.5 times the DTS bandwidth.
3. Set the RBW to: 3 kHz ≤ RBW ≤ 100 kHz.
4. Set the VBW ≥ 3 RBW.
5. Detector = peak.
6. Sweep time = auto couple.
7. Trace mode = max hold.
8. Allow trace to fully stabilize.
9. Use the peak marker function to determine the maximum amplitude level within the RBW.
10. If measured value exceeds limit, reduce RBW (no less than 3 kHz) and repeat.

LIMIT

For digitally modulated systems, the power spectral density conducted from the intentional radiator to the antenna shall not be greater than 8 dBm in any 3 kHz band during any time interval of continuous transmission.

TEST RESULTS

Type	Channel	Power Spectral Density (dBm/3KHz)	Limit (dBm/3KHz)	Result
802.11b	01	-13.842	8.00	Pass
	06	-13.315		
	11	-13.504		
802.11g	01	-14.218	8.00	Pass
	06	-14.378		
	11	-14.672		
802.11n(HT20)	01	-14.739	8.00	Pass
	06	-14.683		
	11	-14.729		
802.11n(HT40)	03	-18.717	8.00	Pass
	06	-19.055		
	09	-19.576		

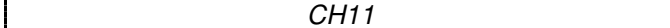
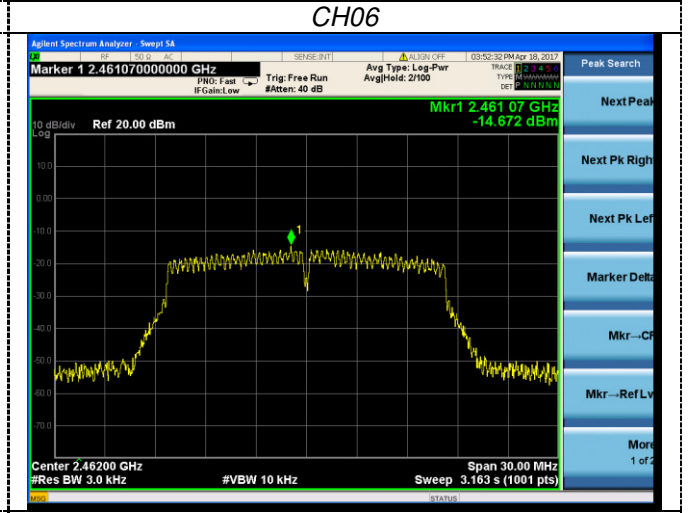
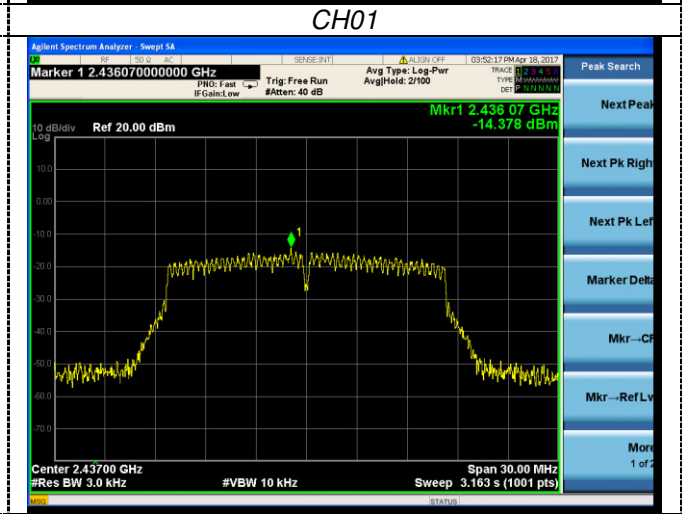
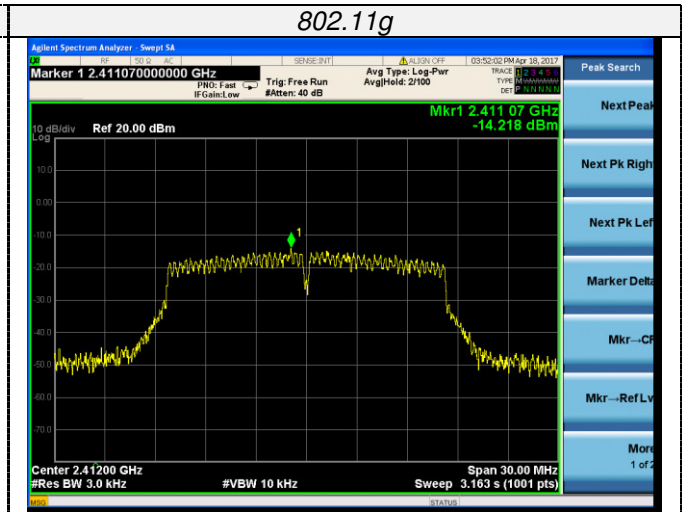
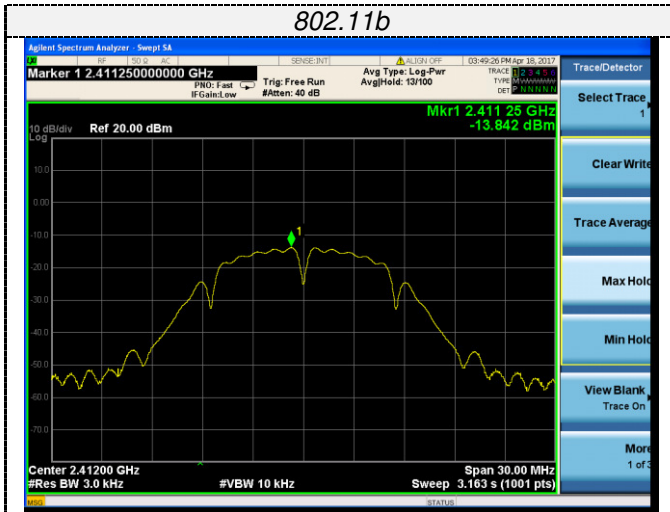

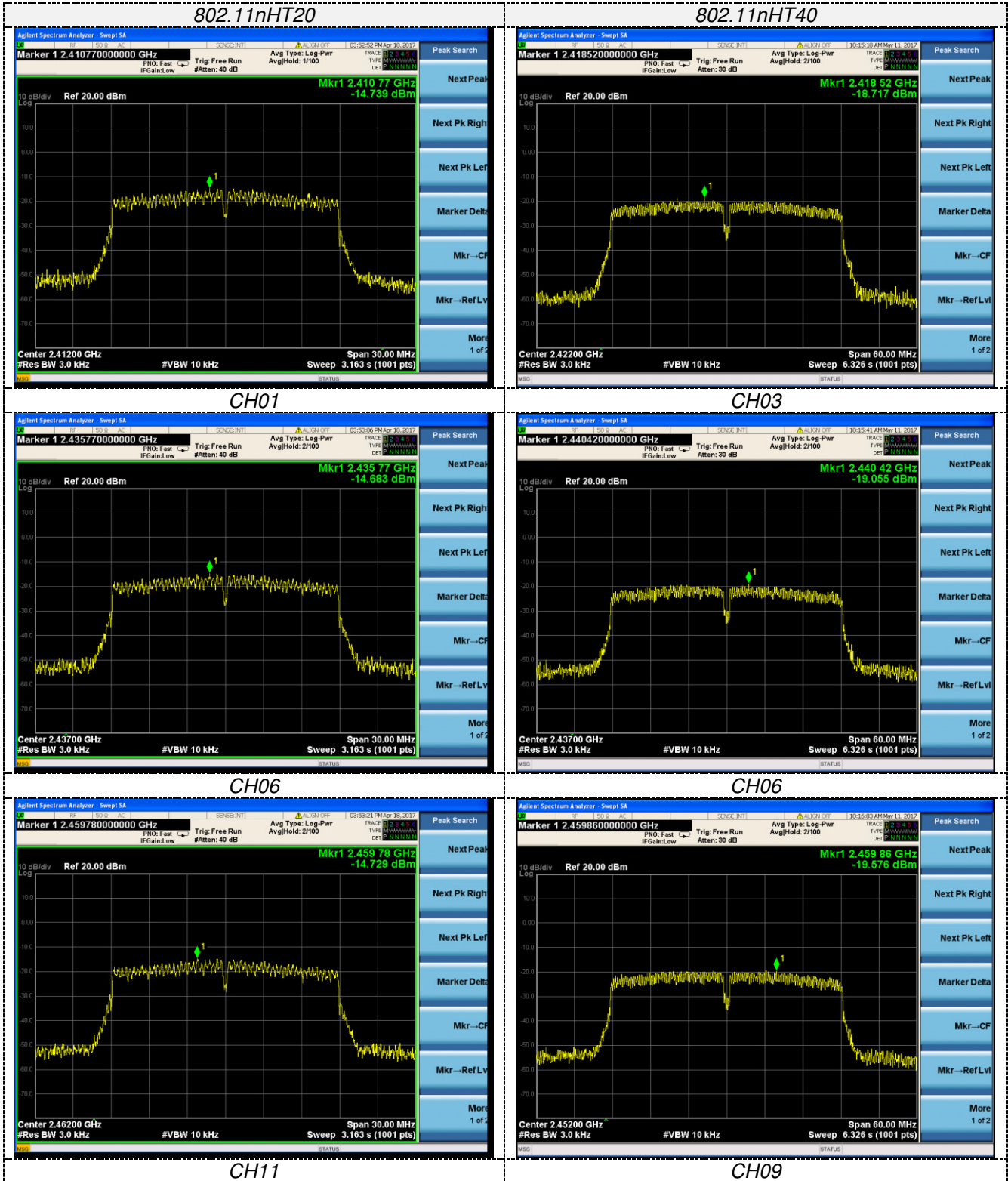

4.5. 6dB Bandwidth

TEST CONFIGURATION

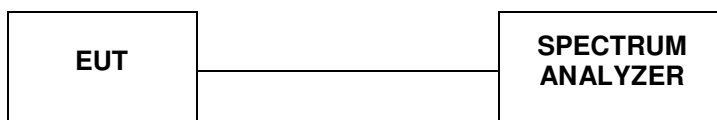

TEST PROCEDURE

The transmitter output was connected to the spectrum analyzer through an attenuator. The bandwidth of the fundamental frequency was measured by spectrum analyzer with RBW=100 KHz and VBW=300KHz. The 6dB bandwidth is defined as the total spectrum the power of which is higher than peak power minus 6dB. According to KDB558074 for one of the following procedures may be used to determine the modulated DTS device signal bandwidth.

1. Set RBW = 100 kHz.
2. Set the video bandwidth (VBW) ≥ 3 RBW.
3. Detector = Peak.
4. Trace mode = max hold.
5. Sweep = auto couple.
6. Allow the trace to stabilize.
7. Measure the maximum width of the emission that is constrained by the frequencies associated with the two outermost amplitude points (upper and lower frequencies) that are attenuated by 6 dB relative to the maximum level measured in the fundamental emission.

LIMIT

For digital modulation systems, the minimum 6 dB bandwidth shall be at least 500 kHz

TEST RESULTS

Type	Channel	6dB Bandwidth (MHz)	Limit (KHz)	Result
802.11b	01	9.166	≥ 500	Pass
	06	9.162		
	11	9.259		
802.11g	01	16.39	≥ 500	Pass
	06	16.36		
	11	16.38		
802.11nHT20	01	17.62	≥ 500	Pass
	06	17.62		
	11	17.61		
802.11nHT40	03	36.09	≥ 500	Pass
	06	36.37		
	09	36.36		

802.11b

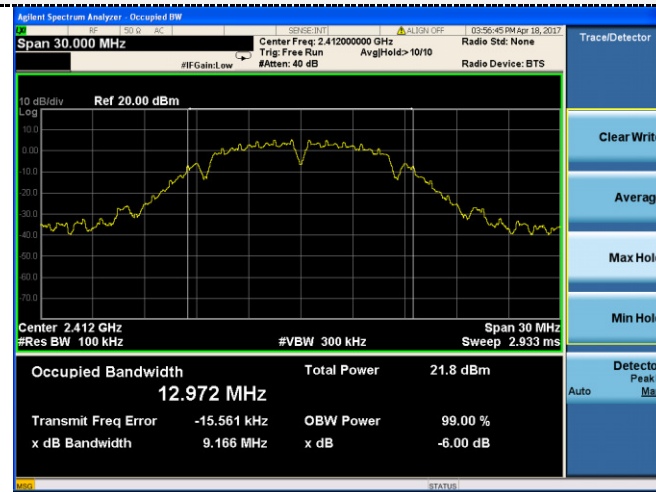

802.11g

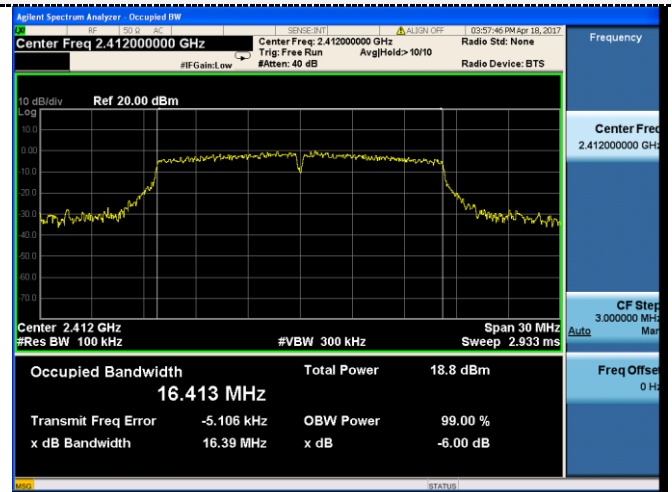

CH01

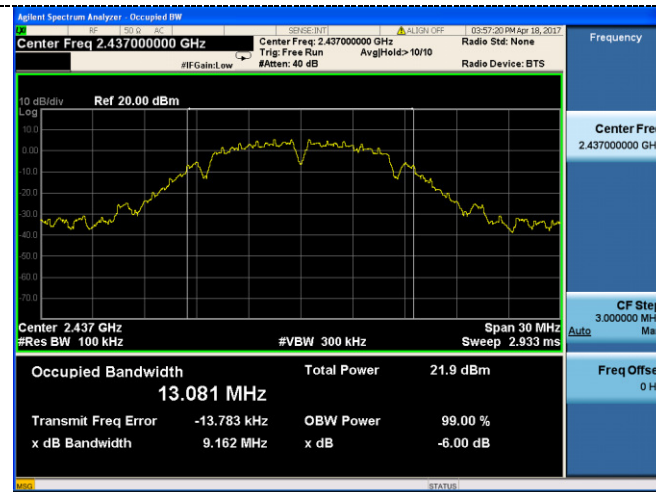

CH01

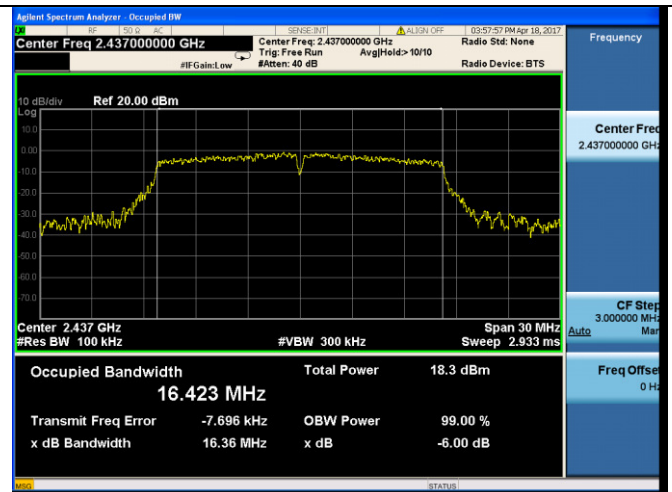

CH06

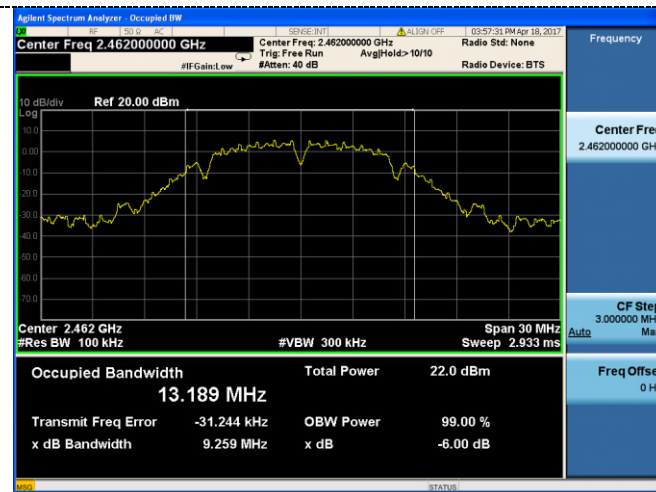

CH06

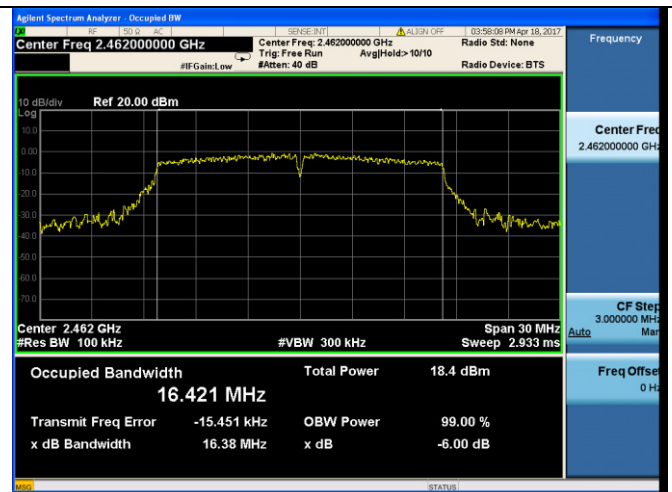

CH11

CH11

802.11n HT20

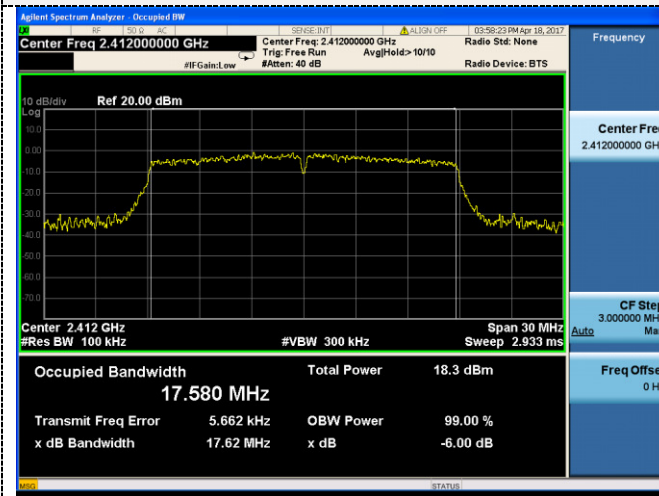

802.11n HT40

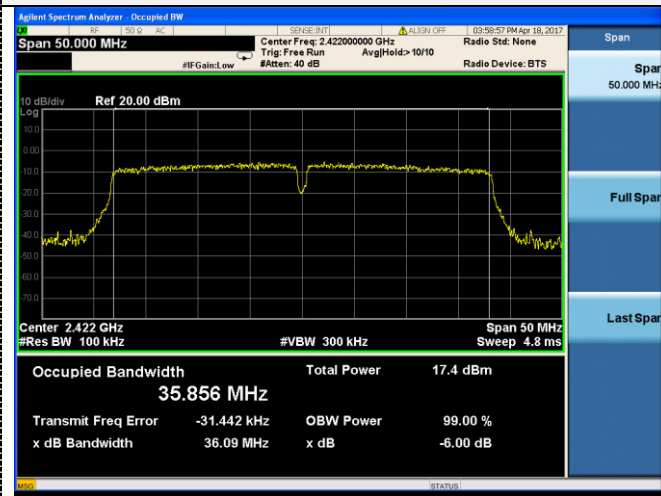

CH01

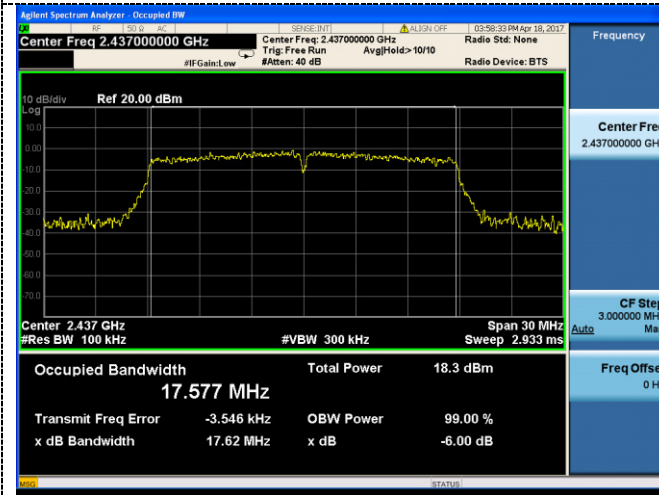

CH03

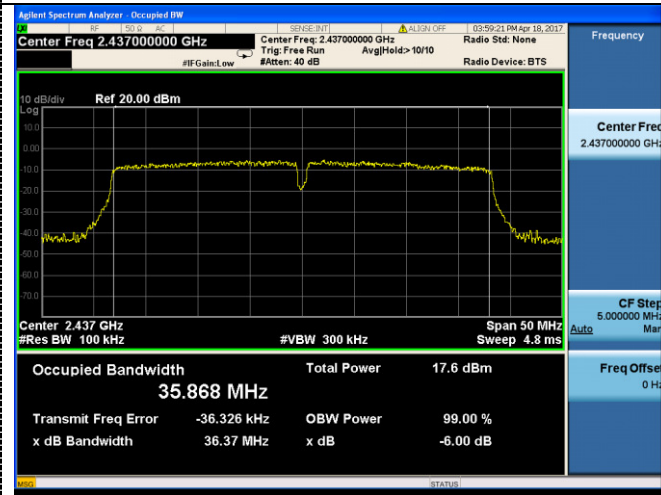

CH06

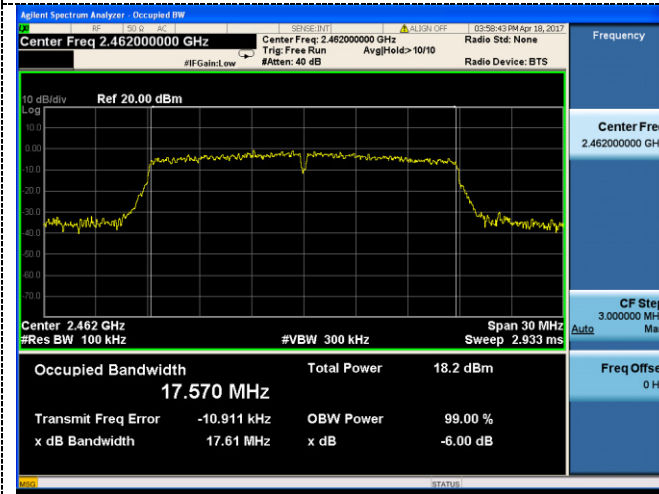

CH06

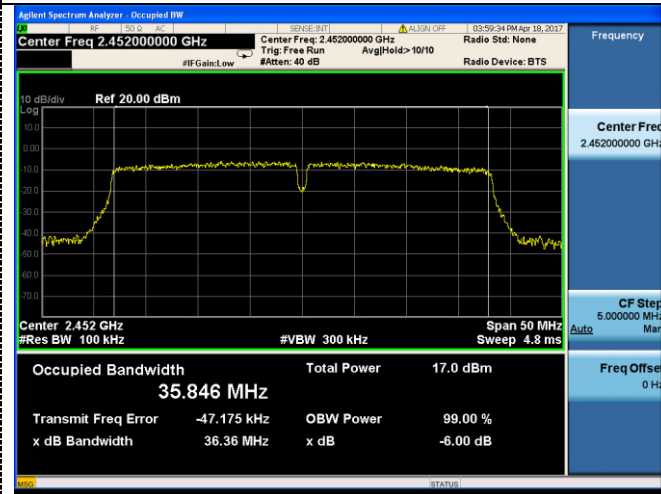

CH11

CH09

4.6. Band Edge Compliance of RF Emission

TEST REQUIREMENT

In any 100 kHz bandwidth outside the frequency band in which the spread spectrum or digitally modulated intentional radiator is operating, the radio frequency power that is produced by the intentional radiator shall be at least 20 dB below that in the 100 kHz bandwidth within the band that contains the highest level of the desired power, based on either an RF conducted or a radiated measurement, provided the transmitter demonstrates compliance with the peak conducted power limits. If the transmitter complies with the conducted power limits based on the use of RMS averaging over a time interval, as permitted under paragraph (b)(3) of this section, the attenuation required under this paragraph shall be 30 dB instead of 20 dB. Attenuation below the general limits specified in §15.209(a) is not required. In addition, radiated emissions which fall in the restricted bands, as defined in §15.205(a), must also comply with the radiated emission limits specified in §15.209(a) (see §15.205(c)).

TEST PROCEDURE

According to KDB 558074 D01 for Antenna-port conducted measurement. Antenna-port conducted measurements may also be used as an alternative to radiated measurements for demonstrating compliance in the restricted frequency bands. If conducted measurements are performed, then proper impedance matching must be ensured and an additional radiated test for cabinet/case spurious emissions is required.

1. Check the calibration of the measuring instrument using either an internal calibrator or a known signal from an external generator.
2. Remove the antenna from the EUT and then connect to a low loss RF cable from the antenna port to a EMI test receiver, then turn on the EUT and make it operate in transmitting mode. Then set it to Low Channel and High Channel within its operating range, and make sure the instrument is operated in its linear range.
3. Set both RBW and VBW of spectrum analyzer to 100 kHz with a convenient frequency span including 100kHz bandwidth from band edge, for Radiated emissions restricted band RBW=1MHz, VBW=3MHz for peak detector and RBW=1MHz, VBW=10Hz for average detector.
4. Measure the highest amplitude appearing on spectral display and set it as a reference level. Plot the graph with marking the highest point and edge frequency.
5. Repeat above procedures until all measured frequencies were complete.
6. Measure the conducted output power (in dBm) using the detector specified by the appropriate regulatory agency (see 12.2.2, 12.2.3, and 12.2.4 for guidance regarding measurement procedures for determining quasi-peak, peak, and average conducted output power, respectively).
7. Add the maximum transmit antenna gain (in dBi) to the measured output power level to determine the EIRP level (see 12.2.5 for guidance on determining the applicable antenna gain)
8. Add the appropriate maximum ground reflection factor to the EIRP level (6 dB for frequencies \leq 30 MHz, 4.7 dB for frequencies between 30 MHz and 1000 MHz, inclusive and 0 dB for frequencies $>$ 1000 MHz).
9. For devices with multiple antenna-ports, measure the power of each individual chain and sum the EIRP of all chains in linear terms (e.g., Watts, mW).
10. Convert the resultant EIRP level to an equivalent electric field strength using the following relationship:

$$E = \text{EIRP} - 20\log D + 104.8$$

where:

E = electric field strength in dB μ V/m,

EIRP = equivalent isotropic radiated power in dBm

D = specified measurement distance in meters.

11. Since the out-of-band characteristics of the EUT transmit antenna will often be unknown, the use of a conservative antenna gain value is necessary. Thus, when determining the EIRP based on the measured conducted power, the upper bound on antenna gain for a device with a single RF output shall be selected as the maximum in-band gain of the antenna across all operating bands, or 2 dBi, whichever is greater. However, for devices that operate in multiple frequency bands while using the same transmit antenna, the highest gain of the antenna within the operating band nearest in frequency to the restricted band emission being measured may be used in lieu of the overall highest gain when the emission is at a frequency that is within 20 percent of the nearest band edge frequency, but in no case shall a value less than 2 dBi be used.
12. Compare the resultant electric field strength level to the applicable regulatory limit.
13. Perform radiated spurious emission test dures until all measured frequencies were complete.

LIMIT

Below -20dB of the highest emission level in operating band.

Radiated emissions which fall in the restricted bands, as defined in § 15.205(a), must also comply with the radiated emission limits specified in § 15.209(a).

TEST RESULTS

Remark: Test site: Shenzhen CTL Testing Technology Co., Ltd.

4.6.1 For Radiated Bandedge Measurement

802.11b

Frequency(MHz):			2412			Polarity:			HORIZONTAL		
Frequency (MHz)	Emission Level (dBuV/m)		Limit (dBuV/m)	Margin (dB)	Antenna Height (m)	Table Angle (Degree)	Raw Value (dBuV)	Antenna Factor (dB/m)	Cable Factor (dB)	Pre-amplifier	Correction Factor (dB/m)
2390.00	55.00	PK	74.00	19.00	1.00	79	60.31	27.49	3.32	36.12	-5.31
2390.00	41.93	AV	54.00	12.07	1.00	79	47.24	27.49	3.32	36.12	-5.31
Frequency(MHz):			2412			Polarity:			VERTICAL		
Frequency (MHz)	Emission Level (dBuV/m)		Limit (dBuV/m)	Margin (dB)	Antenna Height (m)	Table Angle (Degree)	Raw Value (dBuV)	Antenna Factor (dB/m)	Cable Factor (dB)	Pre-amplifier	Correction Factor (dB/m)
2390.00	57.05	PK	74.00	16.95	1.00	128	62.36	27.49	3.32	36.12	-5.31
2390.00	41.87	AV	54.00	12.13	1.00	128	47.18	27.49	3.32	36.12	-5.31
Frequency(MHz):			2462			Polarity:			HORIZONTAL		
Frequency (MHz)	Emission Level (dBuV/m)		Limit (dBuV/m)	Margin (dB)	Antenna Height (m)	Table Angle (Degree)	Raw Value (dBuV)	Antenna Factor (dB/m)	Cable Factor (dB)	Pre-amplifier	Correction Factor (dB/m)
2483.50	57.54	PK	74.00	16.46	1.00	215	63.26	27.45	3.38	36.55	-5.72
2483.50	40.91	AV	54.00	13.09	1.00	215	46.63	27.45	3.38	36.55	-5.72
Frequency(MHz):			2462			Polarity:			VERTICAL		
Frequency (MHz)	Emission Level (dBuV/m)		Limit (dBuV/m)	Margin (dB)	Antenna Height (m)	Table Angle (Degree)	Raw Value (dBuV)	Antenna Factor (dB/m)	Cable Factor (dB)	Pre-amplifier	Correction Factor (dB/m)
2483.50	58.38	PK	74.00	15.62	1.00	162	64.10	27.45	3.38	36.55	-5.72
2483.50	40.63	AV	54.00	13.37	1.00	162	46.35	27.45	3.38	36.55	-5.72

802.11g

Frequency(MHz):			2412			Polarity:			HORIZONTAL		
Frequency (MHz)	Emission Level (dBuV/m)		Limit (dBuV/m)	Margin (dB)	Antenna Height (m)	Table Angle (Degree)	Raw Value (dBuV)	Antenna Factor (dB/m)	Cable Factor (dB)	Pre-amplifier	Correction Factor (dB/m)
2390.00	58.39	PK	74.00	15.61	1.00	139	63.70	27.49	3.32	36.12	-5.31
2390.00	42.13	AV	54.00	11.87	1.00	139	47.44	27.49	3.32	36.12	-5.31
Frequency(MHz):			2412			Polarity:			VERTICAL		
Frequency (MHz)	Emission Level (dBuV/m)		Limit (dBuV/m)	Margin (dB)	Antenna Height (m)	Table Angle (Degree)	Raw Value (dBuV)	Antenna Factor (dB/m)	Cable Factor (dB)	Pre-amplifier	Correction Factor (dB/m)
2390.00	59.61	PK	74.00	14.39	1.00	227	64.92	27.49	3.32	36.12	-5.31
2390.00	40.75	AV	54.00	13.25	1.00	227	46.06	27.49	3.32	36.12	-5.31
Frequency(MHz):			2462			Polarity:			HORIZONTAL		
Frequency (MHz)	Emission Level (dBuV/m)		Limit (dBuV/m)	Margin (dB)	Antenna Height (m)	Table Angle (Degree)	Raw Value (dBuV)	Antenna Factor (dB/m)	Cable Factor (dB)	Pre-amplifier	Correction Factor (dB/m)
2483.50	57.19	PK	74.00	16.81	1.00	165	62.91	27.45	3.38	36.55	-5.72
2483.50	42.38	AV	54.00	11.62	1.00	165	48.10	27.45	3.38	36.55	-5.72
Frequency(MHz):			2462			Polarity:			VERTICAL		
Frequency (MHz)	Emission Level (dBuV/m)		Limit (dBuV/m)	Margin (dB)	Antenna Height (m)	Table Angle (Degree)	Raw Value (dBuV)	Antenna Factor (dB/m)	Cable Factor (dB)	Pre-amplifier	Correction Factor (dB/m)
2483.50	55.69	PK	74.00	18.31	1.00	90	61.41	27.45	3.38	36.55	-5.72
2483.50	41.99	AV	54.00	12.01	1.00	90	47.71	27.45	3.38	36.55	-5.72

802.11n HT20

Frequency(MHz):			2412			Polarity:			HORIZONTAL		
Frequency (MHz)	Emission Level (dBuV/m)		Limit (dBuV/m)	Margin (dB)	Antenna Height (m)	Table Angle (Degree)	Raw Value (dBuV)	Antenna Factor (dB/m)	Cable Factor (dB)	Pre-amplifier	Correction Factor (dB/m)
2390.00	50.69	PK	74.00	23.31	1.00	179	56.00	27.49	3.32	36.12	-5.31
2390.00	41.94	AV	54.00	12.06	1.00	179	47.25	27.49	3.32	36.12	-5.31
Frequency(MHz):			2412			Polarity:			VERTICAL		
Frequency (MHz)	Emission Level (dBuV/m)		Limit (dBuV/m)	Margin (dB)	Antenna Height (m)	Table Angle (Degree)	Raw Value (dBuV)	Antenna Factor (dB/m)	Cable Factor (dB)	Pre-amplifier	Correction Factor (dB/m)
2390.00	51.51	PK	74.00	22.49	1.00	213	56.82	27.49	3.32	36.12	-5.31
2390.00	42.62	AV	54.00	11.38	1.00	213	47.93	27.49	3.32	36.12	-5.31
Frequency(MHz):			2462			Polarity:			HORIZONTAL		
Frequency (MHz)	Emission Level (dBuV/m)		Limit (dBuV/m)	Margin (dB)	Antenna Height (m)	Table Angle (Degree)	Raw Value (dBuV)	Antenna Factor (dB/m)	Cable Factor (dB)	Pre-amplifier	Correction Factor (dB/m)
2483.50	50.57	PK	74.00	23.43	1.00	112	56.29	27.45	3.38	36.55	-5.72
2483.50	42.50	AV	54.00	11.50	1.00	112	48.22	27.45	3.38	36.55	-5.72
Frequency(MHz):			2462			Polarity:			VERTICAL		
Frequency (MHz)	Emission Level (dBuV/m)		Limit (dBuV/m)	Margin (dB)	Antenna Height (m)	Table Angle (Degree)	Raw Value (dBuV)	Antenna Factor (dB/m)	Cable Factor (dB)	Pre-amplifier	Correction Factor (dB/m)
2483.50	50.08	PK	74.00	23.92	1.00	162	55.80	27.45	3.38	36.55	-5.72
2483.50	43.25	AV	54.00	10.75	1.00	167	48.97	27.45	3.38	36.55	-5.72

802.11n HT40

Frequency(MHz):			2422			Polarity:			HORIZONTAL		
Frequency (MHz)	Emission Level (dBuV/m)		Limit (dBuV/m)	Margin (dB)	Antenna Height (m)	Table Angle (Degree)	Raw Value (dBuV)	Antenna Factor (dB/m)	Cable Factor (dB)	Pre-amplifier	Correction Factor (dB/m)
2390.00	48.93	PK	74.00	25.07	1.00	229	54.24	27.49	3.32	36.12	-5.31
2390.00	40.65	AV	54.00	13.35	1.00	229	45.96	27.49	3.32	36.12	-5.31
Frequency(MHz):			2422			Polarity:			VERTICAL		
Frequency (MHz)	Emission Level (dBuV/m)		Limit (dBuV/m)	Margin (dB)	Antenna Height (m)	Table Angle (Degree)	Raw Value (dBuV)	Antenna Factor (dB/m)	Cable Factor (dB)	Pre-amplifier	Correction Factor (dB/m)
2390.00	50.61	PK	74.00	23.39	1.00	177	55.92	27.49	3.32	36.12	-5.31
2390.00	41.08	AV	54.00	12.92	1.00	177	46.39	27.49	3.32	36.12	-5.31
Frequency(MHz):			2452			Polarity:			HORIZONTAL		
Frequency (MHz)	Emission Level (dBuV/m)		Limit (dBuV/m)	Margin (dB)	Antenna Height (m)	Table Angle (Degree)	Raw Value (dBuV)	Antenna Factor (dB/m)	Cable Factor (dB)	Pre-amplifier	Correction Factor (dB/m)
2483.50	51.47	PK	74.00	22.53	1.00	116	57.19	27.45	3.38	36.55	-5.72
2483.50	41.68	AV	54.00	12.32	1.00	116	47.40	27.45	3.38	36.55	-5.72
Frequency(MHz):			2452			Polarity:			VERTICAL		
Frequency (MHz)	Emission Level (dBuV/m)		Limit (dBuV/m)	Margin (dB)	Antenna Height (m)	Table Angle (Degree)	Raw Value (dBuV)	Antenna Factor (dB/m)	Cable Factor (dB)	Pre-amplifier	Correction Factor (dB/m)
2483.50	51.59	PK	74.00	22.41	1.00	224	57.31	27.45	3.38	36.55	-5.72
2483.50	41.62	AV	54.00	12.38	1.00	224	47.34	27.45	3.38	36.55	-5.72

4.6.2 For Conducted Bandedge Measurement

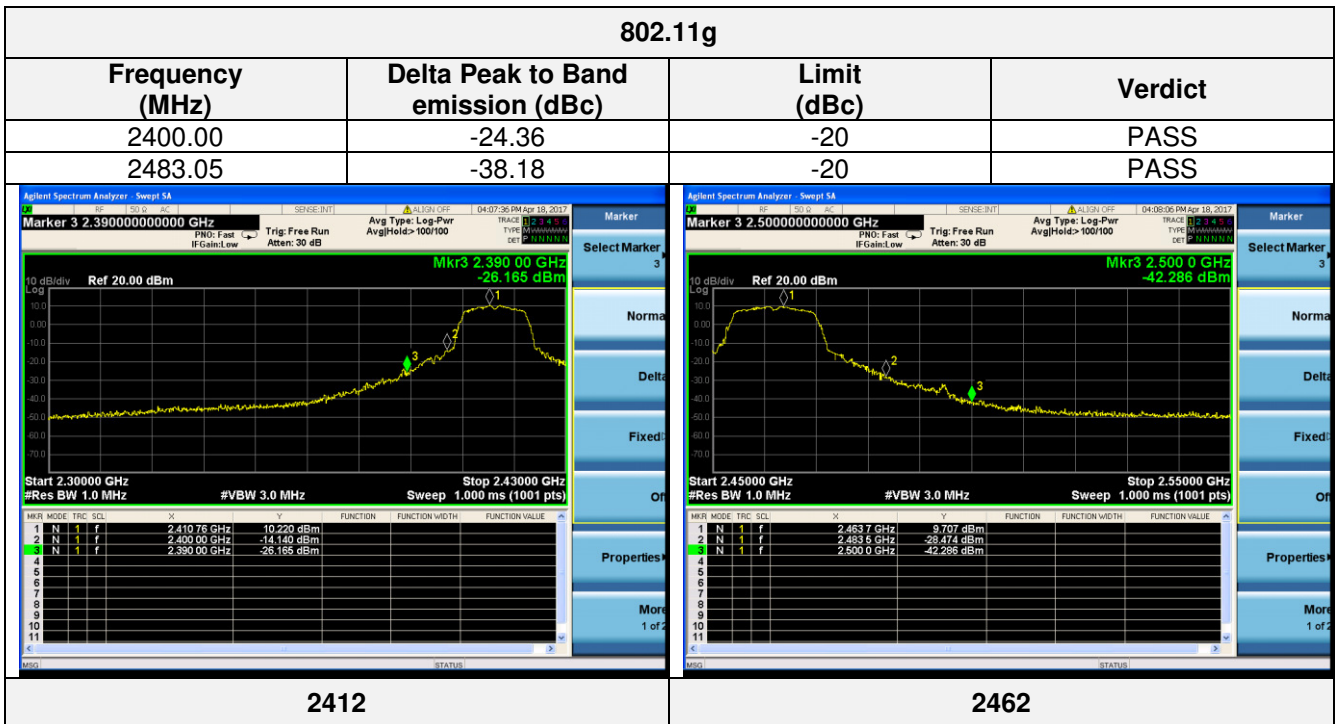
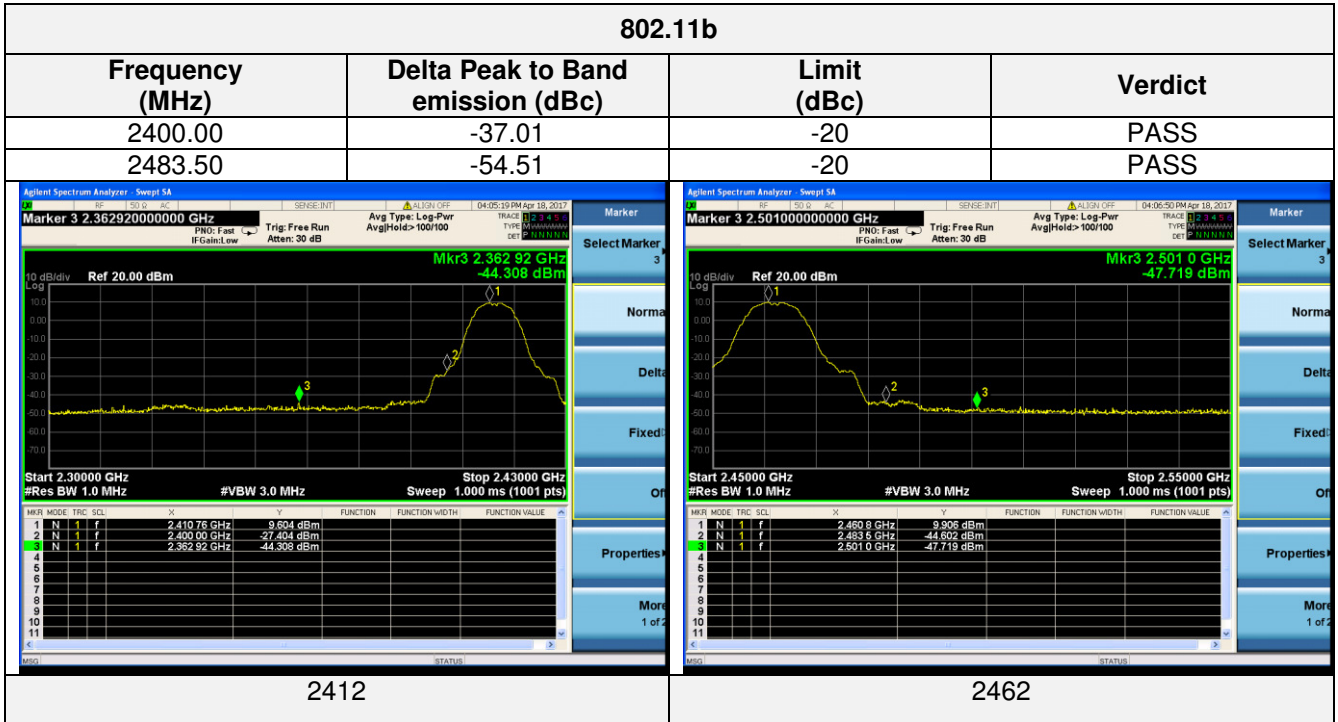

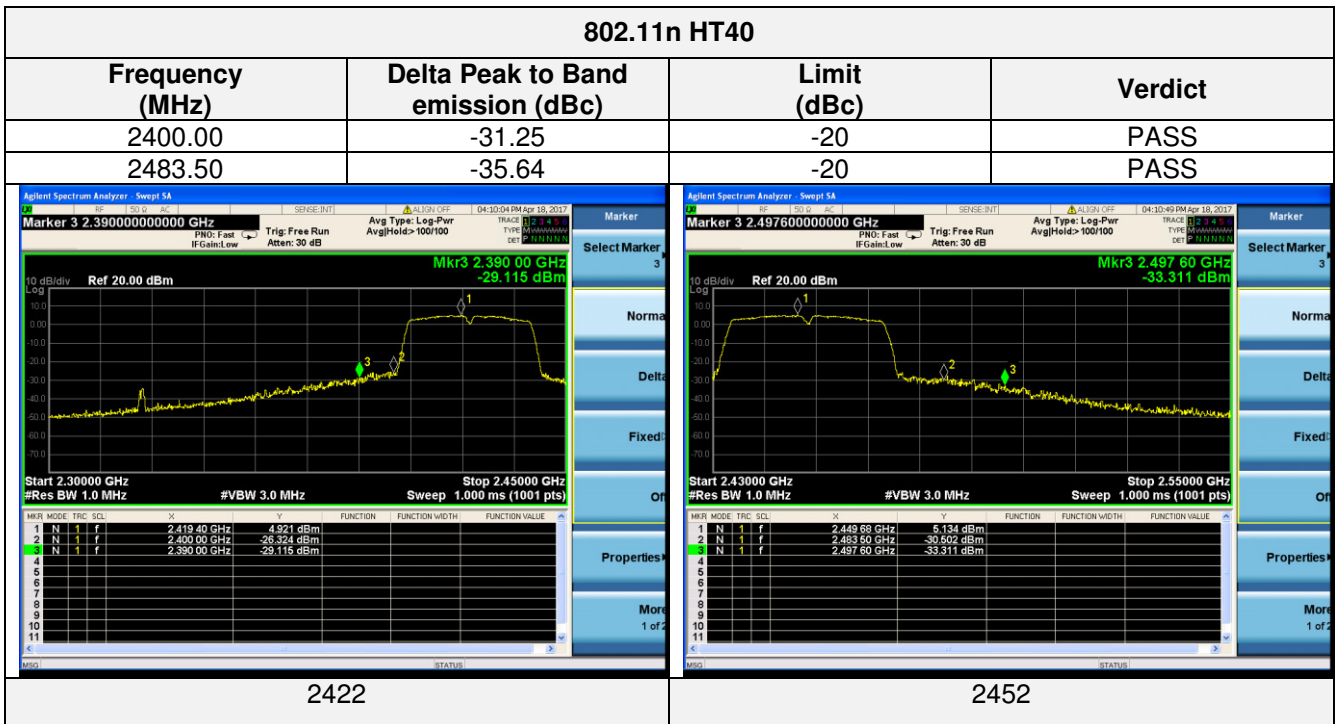
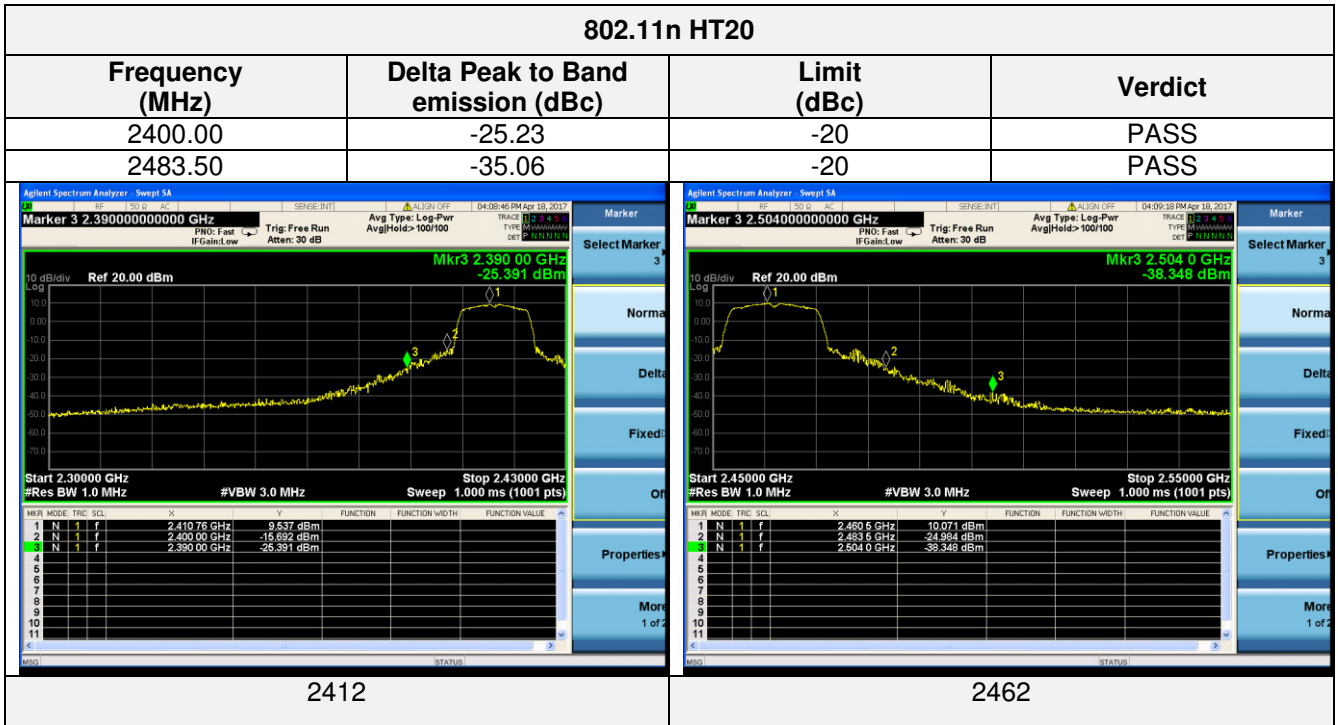

4.7. Spurious RF Conducted Emission

TEST CONFIGURATION

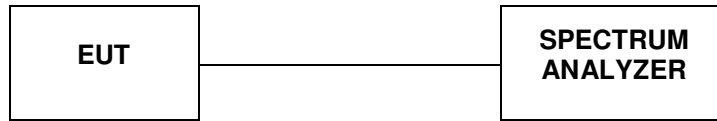

TEST PROCEDURE

The Spurious RF conducted emissions compliance of RF radiated emission should be measured by following the guidance in ANSI C63.10-2013, For 9KHz-150kHz, Set RBW=1kHz and VBW= 3KHz;For 150KHz-10MHz, Set RBW=10kHz and VBW= 30KHz;For 10MHz-25GHz ,Set RBW=100kHz and VBW= 300KHz in order to measure the peak field strength, and measure frequency range from 9KHz to 25GHz.

LIMIT

1. Below -20dB of the highest emission level in operating band.
2. Fall in the restricted bands listed in section 15.205. The maximum permitted average field strength is listed in section 15.209.
3. For below 30MHz, For 9KHz-150kHz, 150K-10MHz, We use the RBW 1KHz, 10KHz, So the limit need to be calculated by " $10\lg(BW1/BW2)$ ". for example For 9KHz-150kHz, RBW 1KHz, The Limit= the highest emission level-20-10log(100/1)= the highest emission level-40.

TEST RESULTS

Remark: The measurement frequency range is from 9KHz to the 10th harmonic of the fundamental frequency. The lowest, middle and highest channels are tested to verify the spurious emissions and band edge measurement data.

Test Mode:

802.11b

Test channel :

01

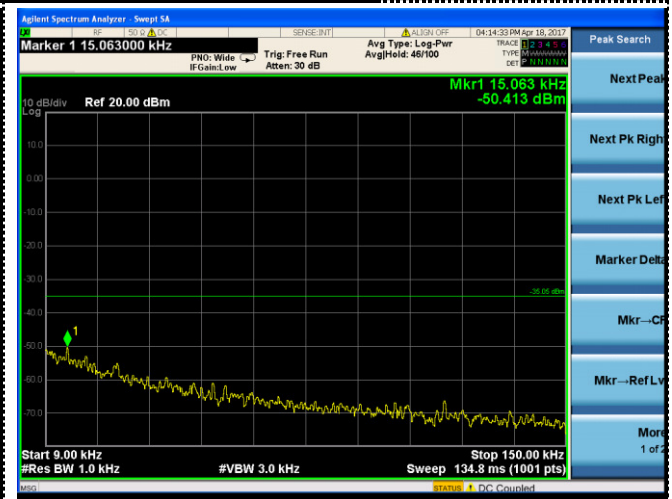

2412

9KHz~150KHz

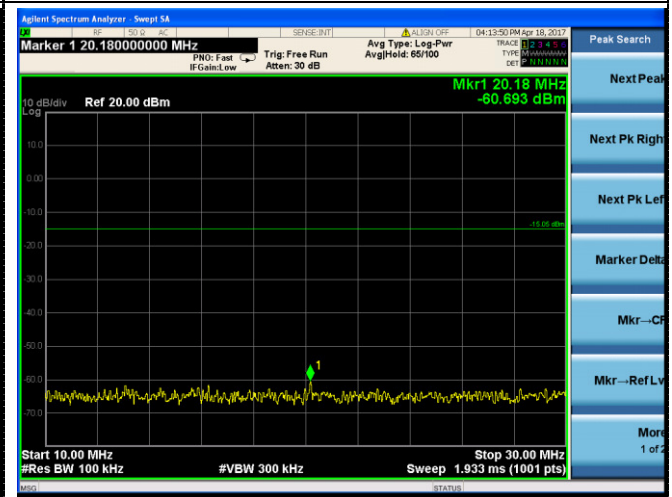
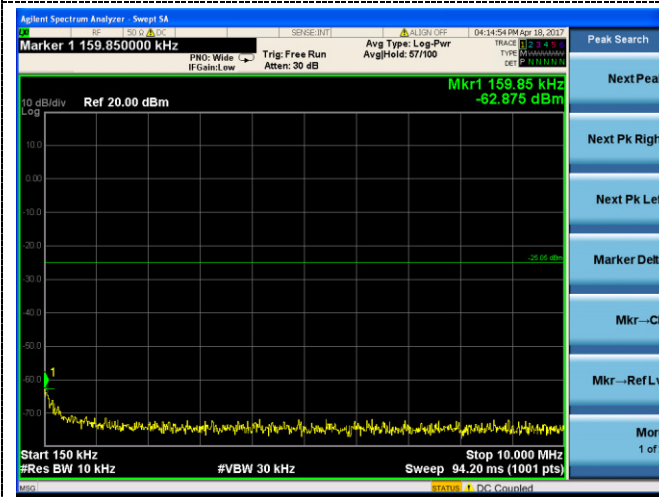

150KHz~10MHz

10MHz~30MHz

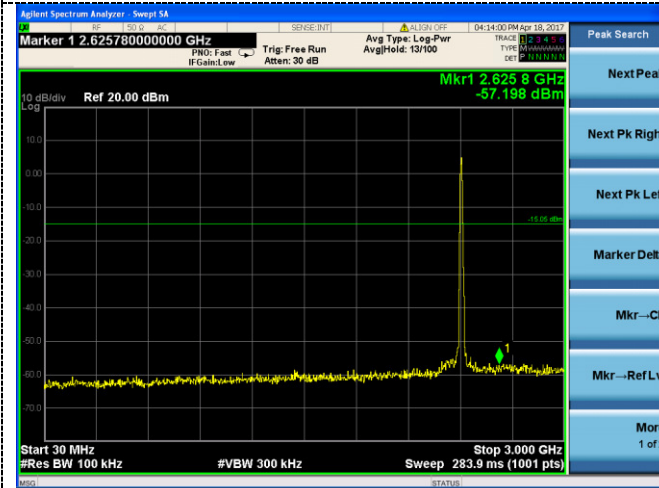

30MHz~3GHz

3GHz~25GHz



