



Shenzhen Global Test Service Co.,Ltd.

No.7-101 and 8A-104,Building 7 and 8,DCC Cultural and Creative Garden No.98,Pingxin North Road,Shangmugu,Pinghu Street, Longgang District,Shenzhen,Guangdong,China

TEST REPORT

FCC Part 27

Report Reference No......: **GTS20200923017-1-3**
FCC ID.....: **RQQHLT-L622TA**

Compiled by
 (position+printed name+signature) .: File administrators Jimmy Wang

Supervised by
 (position+printed name+signature) .: Test Engineer Aaron Tan

Approved by
 (position+printed name+signature) .: Manager Jason Hu

Date of issue.....: Oct.23, 2020

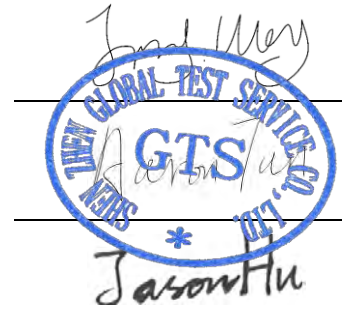

Testing Laboratory Name: **Shenzhen Global Test Service Co.,Ltd.**

Address: No.7-101 and 8A-104,Building 7 and 8,DCC Cultural and Creative Garden No.98,Pingxin North Road,Shangmugu,Pinghu Street, Longgang District,Shenzhen,Guangdong,China

Applicant's name: **Hyundai Corporation**

Address: 25,Yulgok-ro 2-Gil, Jongno-gu, Seoul, South Korea

Test specification:

Standard: **FCC CFR Title 47 Part 2, Part 24E**
ANSI/TIA-603-E-2016
KDB 971168 D01

Shenzhen Global Test Service Co.,Ltd. All rights reserved.

This publication may be reproduced in whole or in part for non-commercial purposes as long as the Shenzhen Global Test Service Co.,Ltd. is acknowledged as copyright owner and source of the material. Shenzhen Global Test Service Co.,Ltd.takes no responsibility for and will not assume liability for damages resulting from the reader's interpretation of the reproduced material due to its placement and context.

Test item description.....: Smart phone

Trade Mark: HYUNDAI

Manufacturer.....: **Shenzhen Tinno Mobile Technology Corp**

Model/Type reference.....: L622

Listed Models: N/A

Ratings: DC 3.85V from battery

Modulation: QPSK, 16QAM

Hardware version: V1.0

Software version: HYUNDAI_L622_V1.1.3

Frequency.....: E-UTRA FDD Band 2, 4, 5, 7, 17

Result.....: **PASS**

TEST REPORT

Test Report No. :	GTS20200923017-1-3	Oct.23, 2020
		Date of issue

Equipment under Test : Smart phone

Model /Type : L622

Listed Models : N/A

Applicant : **Hyundai Corporation**

Address : 25,Yulgok-ro 2-Gil, Jongno-gu, Seoul, South Korea

Manufacturer : **Shenzhen Tinno Mobile Technology Corp**

Address : 4/F.,H-3 Building,OCT Eastern Industrial Park. NO.1
XiangShan East Road.,Nan Shan District,Shenzhen,P.R.China

Test result	Pass *
--------------------	---------------

* In the configuration tested, the EUT complied with the standards specified page 4.

The test report merely corresponds to the test sample.

It is not permitted to copy extracts of these test result without the written permission of the test laboratory.

Contents

1	SUMMARY	4
1.1	TEST STANDARDS	4
1.2	TEST DESCRIPTION	4
1.3	ADDRESS OF THE TEST LABORATORY	4
1.4	TEST FACILITY	4
1.5	STATEMENT OF THE MEASUREMENT UNCERTAINTY	5
2	GENERAL INFORMATION	6
2.1	GENERAL REMARKS	6
2.2	GENERAL DESCRIPTION OF EUT	6
2.3	DESCRIPTION OF TEST MODES AND TEST FREQUENCY	6
2.4	EQUIPMENTS USED DURING THE TEST	7
2.5	RELATED SUBMITTAL(S) / GRANT (S)	8
2.6	MODIFICATIONS	8
2.7	ENVIRONMENTAL CONDITIONS	8
3	TEST CONDITIONS AND RESULTS	9
3.1	OUTPUT POWER	9
3.2	PEAK-TO-AVERAGE RATIO (PAR)	16
3.3	OCCUPIED BANDWIDTH AND EMISSION BANDWIDTH	24
3.4	BAND EDGE COMPLIANCE	31
3.5	SPURIOUS EMISSION	37
3.6	FREQUENCY STABILITY UNDER TEMPERATURE & VOLTAGE VARIATIONS	61
4	TEST SETUP PHOTOS OF THE EUT	63
5	PHOTOS OF THE EUT	63

1 SUMMARY

1.1 TEST STANDARDS

The tests were performed according to following standards:

[FCC Part 2](#): FREQUENCY ALLOCATIONS AND RADIO TREATY MATTERS; GENERAL RULES AND REGULATIONS

[FCC Part 27](#): MISCELLANEOUS WIRELESS COMMUNICATIONS SERVICES

[ANSI/TIA-603-E-2016](#): Land Mobile FM or PM Communications Equipment Measurement and Performance Standards.

[ANSI C63.26-2015](#): IEEE/ANSI Standard for Compliance Testing of Transmitters Used in Licensed Radio Services

[FCC KDB971168D01](#) Power Meas License Digital Systems

1.2 Test Description

Test Item	Section in CFR 47	Result
RF Output Power	Part 2.1046 Part 27.50(d)(4)	Pass
Peak-to-Average Ratio	Part 27.50(d)(4)	Pass
99% & -26 dB Occupied Bandwidth	Part 2.1049 Part 27.53(h)	Pass
Spurious Emissions at Antenna Terminal	Part 2.1051 Part 27.53(h)	Pass
Field Strength of Spurious Radiation	Part 2.1053 Part 27.53(h)	Pass
Out of band emission, Band Edge	Part 2.1051 Part 27.53(h)	Pass
Frequency stability	Part 2.1055 Part 27.54	Pass

1.3 Address of the test laboratory

Shenzhen Global Test Service Co.,Ltd.

No.7-101 and 8A-104, Building 7 and 8, DCC Cultural and Creative Garden, No.98, Pingxin North Road, Shangmugu Community, Pinghu Street, Longgang District, Shenzhen, Guangdong

The 3m-Semi anechoic test site fulfils CISPR 16-1-4 according to ANSI C63.4:2014 and CISPR 16-1-4:2010 SVSWR requirement for radiated emission above 1GHz.

1.4 Test Facility

The test facility is recognized, certified, or accredited by the following organizations:

FCC-Registration No.: 165725

Shenzhen Global Test Service Co.,Ltd EMC Laboratory has been registered and fully described in a report filed with the (FCC) Federal Communications Commission. The acceptance letter from the FCC is maintained in our files.

A2LA-Lab Cert. No.: 4758.01

Shenzhen Global Test Service Co.,Ltd. EMC Laboratory has been accredited by A2LA for technical competence in the field of electrical testing, and proved to be in compliance with ISO/IEC 17025: 2005 General Requirements for the Competence of Testing and Calibration Laboratories and any additional program requirements in the identified field of testing.

CNAS-Lab Code: L8169

Shenzhen Global Test Service Co.,Ltd. has been assessed and proved to be in compliance with CNAS-CL01 Accreditation Criteria for Testing and Calibration Laboratories (identical to ISO/IEC 17025: 2005 General Requirements) for the Competence of Testing and Calibration Laboratories. Date of Registration: Dec. 11, 2015. Valid time is until Dec. 10, 2024.

1.5 Statement of the measurement uncertainty

The data and results referenced in this document are true and accurate. The reader is cautioned that there may be errors within the calibration limits of the equipment and facilities. The measurement uncertainty was calculated for all measurements listed in this test report acc. to TR-100028-01 "Electromagnetic compatibility and Radio spectrum Matters (ERM); Uncertainties in the measurement of mobile radio equipment characteristics; Part 1" and TR-100028-02 "Electromagnetic compatibility and Radio spectrum Matters (ERM); Uncertainties in the measurement of mobile radio equipment characteristics; Part 2" and is documented in the Shenzhen Global Test Service Co.,Ltd. quality system acc. to DIN EN ISO/IEC 17025. Furthermore, component and process variability of devices similar to that tested may result in additional deviation. The manufacturer has the sole responsibility of continued compliance of the device.

Hereafter the best measurement capability for Shenzhen Global Test Service Co.,Ltd. is reported:

Test	Range	Measurement Uncertainty	Notes
Radiated Emission	30~1000MHz	4.10 dB	(1)
Radiated Emission	1~18GHz	4.32 dB	(1)
Radiated Emission	18-40GHz	5.54 dB	(1)
Conducted Disturbance	0.15~30MHz	3.12 dB	(1)
Conducted Power	9KHz~18GHz	0.61 dB	(1)
Spurious RF Conducted Emission	9KHz~40GHz	1.22 dB	(1)
Band Edge Compliance of RF Emission	9KHz~40GHz	1.22 dB	(1)
Occupied Bandwidth	9KHz~40GHz	-	(1)

(1) This uncertainty represents an expanded uncertainty expressed at approximately the 95% confidence level using a coverage factor of $k=1.96$.

2 GENERAL INFORMATION

2.1 General Remarks

Date of receipt of test sample	:	Sep. 20, 2020
Testing commenced on	:	Sep. 21, 2020
Testing concluded on	:	Oct. 23, 2020

2.2 General Description of EUT

Product Name:	Smart phone
Model/Type reference:	L622
Power supply:	DC 3.85V from battery
Adaper information:	Model: AS5015A Input: AC100-240V 50/60Hz Output: DC5.0V---1.55A
Testing sample ID :	GTS20200923017-1-1#(Engineer sample), GTS20200923017-1-2#(Normal sample)
LTE	
Operation Band:	E-UTRA Band 2, band 4, band5, band7, band17
Support Bandwidth:	Band 2: 1.4MHz, 3MHz, 5MHz, 10MHz, 15MHz,20MHz Band 4: 1.4MHz, 3MHz,5MHz,10MHz,15MHz,20MHz Band 5: 1.4MHz,3MHz,5MHz,10MHz, Band 7: 5MHz,10MHz,15MHz,20MHz Band 17: 5MHz, 10MHz
TX/RXFrequency Range:	Band 2: 1850MHz-1910MHz/1930MHz-1990MHz Band 4: 1710MHz-1755MHz/2110MHz-2155MHz Band 5: 824MHz-849MHz/869MHz-894MHz Band 7: 2500MHz-2570MHz/2620MHz-2690MHz Band 17: 704MHz-716 MHz/734MHz-746MHz
Modulation Type:	QPSK, 16QAM
Release Version:	Release 9
Category:	Cat 4
Antenna Type:	FPC antenna
Antenna Gain:	0.90dBi

Note: For more details, refer to the user's manual of the EUT.

2.3 Description of Test Modes and Test Frequency

The EUT has been tested under typical operating condition. The CMW500 used to control the EUT staying in continuous transmitting and receiving mode for testing. Regards to the frequency band operation: the lowest, middle and highest frequency of channel were selected to perform the test, then shown on this report.

2.4 Equipments Used during the Test

Test Equipment	Manufacturer	Model No.	Serial No.	Calibration Date	Calibration Due Date
LISN	R&S	ENV216	3560.6550.0 8	2020/09/19	2021/09/18
LISN	R&S	ESH2-Z5	893606/008	2020/09/19	2021/09/18
EMI Test Receiver	R&S	ESPI3	101841-cd	2020/09/19	2021/09/18
EMI Test Receiver	R&S	ESCI7	101102	2020/09/19	2021/09/18
Spectrum Analyzer	Agilent	N9020A	MY48010425	2020/09/19	2021/09/18
Spectrum Analyzer	R&S	FSV40	100019	2020/09/19	2021/09/18
Vector Signal generator	Agilent	N5181A	MY49060502	2020/09/19	2021/09/18
Signal generator	Agilent	E4421B	3610AO1069	2020/09/19	2021/09/18
Climate Chamber	ESPEC	EL-10KA	A20120523	2020/09/19	2021/09/18
Controller	EM Electronics	Controller EM 1000	N/A	N/A	N/A
Horn Antenna	Schwarzbeck	BBHA 9120D	01622	2020/09/19	2021/09/18
Active Loop Antenna	Beijing Da Ze Technology Co.,Ltd.	ZN30900C	15006	2020/10/11	2021/10/10
Bilog Antenna	Schwarzbeck	VULB9163	000976	2020/05/26	2021/05/25
Broadband Horn Antenna	SCHWARZBEC K	BBHA 9170	791	2020/09/19	2021/09/18
Amplifier	Schwarzbeck	BBV 9743	#202	2020/09/19	2021/09/18
Amplifier	Schwarzbeck	BBV9179	9719-025	2020/09/19	2021/09/18
Amplifier	EMCI	EMC051845B	980355	2020/09/19	2021/09/18
Temperature/Humidity Meter	Gangxing	CTH-608	02	2020/09/19	2021/09/18
High-Pass Filter	K&L	9SH10-2700/X12750-O/O	KL142031	2020/09/19	2021/09/18
High-Pass Filter	K&L	41H10-1375/U12750-O/O	KL142032	2020/09/19	2021/09/18
RF Cable(below 1GHz)	HUBER+SUHN ER	RG214	RE01	2020/09/19	2021/09/18
RF Cable(above 1GHz)	HUBER+SUHN ER	RG214	RE02	2020/09/19	2021/09/18
Data acquisition card	Agilent	U2531A	TW5332350 7	2020/09/19	2021/09/18
Power Sensor	Agilent	U2021XA	MY5365004	2020/09/19	2021/09/18
Test Control Unit	Tonscend	JS0806-1	178060067	2020/06/20	2021/06/19
Automated filter bank	Tonscend	JS0806-F	19F8060177	2020/06/20	2021/06/19
EMI Test Software	Tonscend	JS1120-1	Ver 2.6.8.0518	/	/

EMI Test Software	Tonscend	JS1120-3	Ver 2.5.77.0418	/	/
EMI Test Software	Tonscend	JS32-CE	Ver 2.5	/	/
EMI Test Software	Tonscend	JS32-RE	Ver 2.5.1.8	/	/

Note: The Cal.Interval was one year.

2.5 Related Submittal(s) / Grant (s)

This submittal(s) (test report) is intended for FCC ID: RQQHLT-L622TA filing to comply with of the FCC Part 27 Rules.

2.6 Modifications

No modifications were implemented to meet testing criteria.

2.7 Environmental conditions

During the measurement the environmental conditions were within the listed ranges:

Normal Temperature:	25°C
Relative Humidity:	55 %
Air Pressure:	101 kPa

3 TEST CONDITIONS AND RESULTS

3.1 Output Power

LIMIT

According to §27.50 (d) (4): Fixed, mobile, and portable (hand- held) stations operating in the 1710–1755 MHz band are limited to 1 watt EIRP.

TEST CONFIGURATION

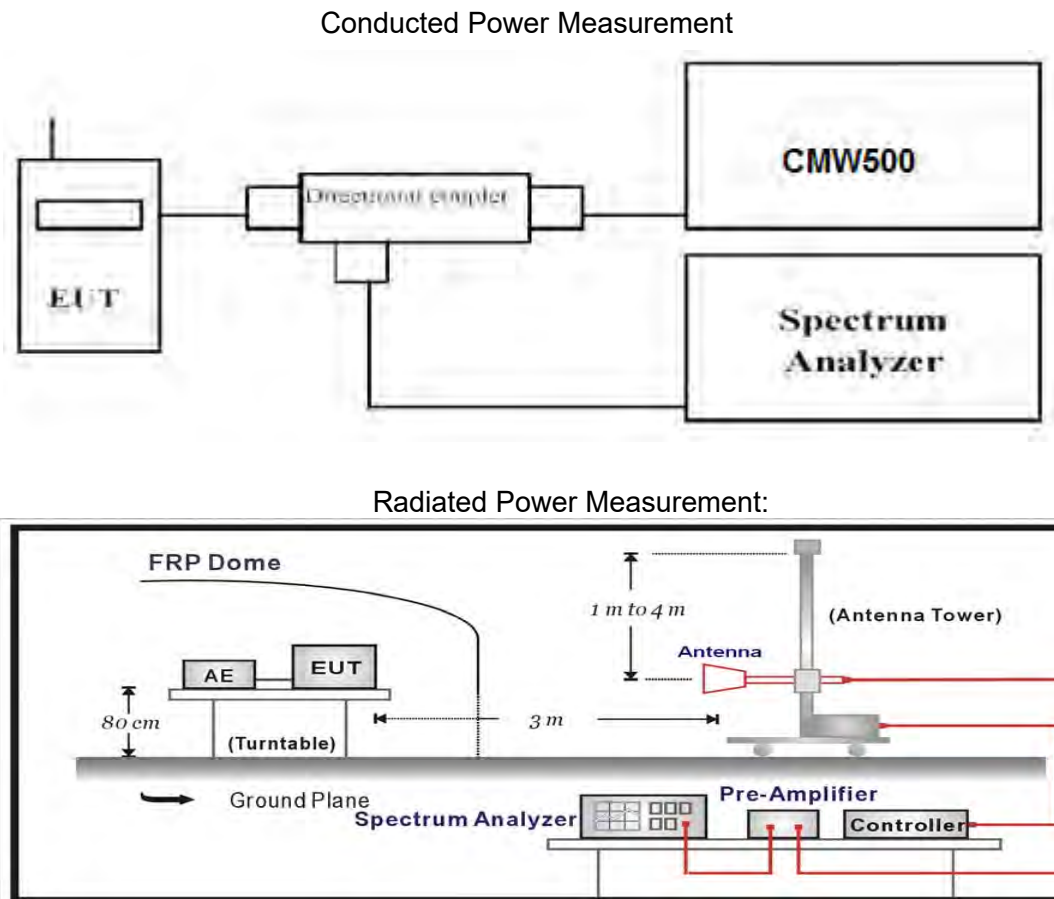

TEST PROCEDURE

The EUT was setup according to EIA/TIA 603D

Conducted Power Measurement:

- Place the EUT on a bench and set it in transmitting mode.
- Connect a low loss RF cable from the antenna port to a spectrum analyzer and CMW500 by a Directional Coupler.
- EUT Communicate with CMW500 then selects a channel for testing.
- Add a correction factor to the display of spectrum, and then test.

Radiated Power Measurement:

- The EUT shall be placed at the specified height on a support, and in the position closest to normal use as declared by provider.
- The test antenna shall be oriented initially for vertical polarization and shall be chosen to correspond to the frequency of the transmitter
- The output of the test antenna shall be connected to the measuring receiver.
- The transmitter shall be switched on and the measuring receiver shall be tuned to the frequency of the transmitter under test.
- The test antenna shall be raised and lowered through the specified range of height until a maximum signal level is detected by the measuring receiver.

- f) The transmitter shall then be rotated through 360° in the horizontal plane, until the maximum signal level is detected by the measuring receiver.
- g) The test antenna shall be raised and lowered again through the specified range of height until a maximum signal level is detected by the measuring receiver.
- h) The maximum signal level detected by the measuring receiver shall be noted.
- i) The transmitter shall be replaced by a substitution antenna.
- j) The substitution antenna shall be orientated for vertical polarization and the length of the substitution antenna shall be adjusted to correspond to the frequency of the transmitter.
- k) The substitution antenna shall be connected to a calibrated signal generator.
- l) If necessary, the input attenuator setting of the measuring receiver shall be adjusted in order to increase the sensitivity of the measuring receiver.
- m) The test antenna shall be raised and lowered through the specified range of height to ensure that the maximum signal is received.
- n) The input signal to the substitution antenna shall be adjusted to the level that produces a level detected by the measuring receiver, that is equal to the level noted while the transmitter radiated power was measured, corrected for the change of input attenuator setting of the measuring receiver.
- o) The measurement shall be repeated with the test antenna and the substitution antenna orientated for horizontal polarization.
- p) The measure of the effective radiated power is the larger of the two levels recorded at the input to the substitution antenna, corrected for gain of the substitution antenna if necessary.
- q) Test site anechoic chamber refer to ANSI C63.4.

TEST RESULTS

Conducted Measurement:

<i>LTE FDD Band 4</i>					
TX Channel Bandwidth	RB Size/Offset	Frequency (MHz)	Average Power [dBm]		
			QPSK	16QAM	
1.4 MHz	1 RB low	1710.7	23.48	22.50	
		1732.5	22.66	21.69	
		1754.3	23.05	22.06	
	1 RB mid	1710.7	22.82	21.90	
		1732.5	23.09	22.24	
		1754.3	23.41	22.46	
	1 RB high	1710.7	23.07	21.95	
		1732.5	22.66	21.62	
		1754.3	22.67	21.60	
	50% RB low	1710.7	23.27	22.34	
		1732.5	23.44	22.52	
		1754.3	22.86	21.72	
	50% RB mid	1710.7	22.77	21.68	
		1732.5	23.43	22.41	
		1754.3	23.15	22.19	
	50% RB High	1710.7	22.59	21.63	
		1732.5	22.67	21.66	
		1754.3	22.55	21.41	
	100% RB	1710.7	23.42	22.42	
		1732.5	22.78	21.89	
		1754.3	23.23	22.08	
	3 MHz	1 RB low	1711.5	23.02	22.12
			1732.5	23.11	22.10
			1753.5	22.92	21.98
		1 RB mid	1711.5	23.05	21.90
			1732.5	22.55	21.55
			1753.5	22.72	21.73
1 RB high		1711.5	23.04	22.05	
		1732.5	23.00	21.86	
		1753.5	23.45	22.34	
50% RB low		1711.5	22.91	21.87	
		1732.5	22.89	22.03	
		1753.5	23.31	22.37	
50% RB mid		1711.5	22.84	21.95	
		1732.5	22.90	21.93	
		1753.5	22.53	21.57	
50% RB High		1711.5	23.24	22.35	
		1732.5	23.08	22.11	
		1753.5	23.33	22.27	
100% RB		1711.5	22.70	21.72	
		1732.5	23.05	22.03	
		1753.5	22.91	22.05	
5 MHz		1 RB low	1712.5	23.18	22.14
			1732.5	23.15	22.10
			1752.5	22.92	22.05
		1 RB mid	1712.5	23.50	22.56
			1732.5	23.28	22.34
			1752.5	23.05	22.06
	1 RB high	1712.5	22.97	21.82	
		1732.5	22.52	21.67	
		1752.5	22.54	21.39	

	50% RB low	1712.5	23.50	22.60	
		1732.5	22.89	21.80	
		1752.5	23.47	22.50	
	50% RB mid	1712.5	23.26	22.12	
		1732.5	22.60	21.63	
		1752.5	23.31	22.46	
	50% RB High	1712.5	23.22	22.17	
		1732.5	23.39	22.51	
		1752.5	22.96	21.94	
	100% RB	1712.5	23.25	22.30	
		1732.5	22.62	21.67	
		1752.5	23.50	22.51	
10 MHz	1 RB low	1715.0	22.65	21.70	
		1732.5	23.31	22.23	
		1750.0	22.95	22.06	
	1 RB mid	1715.0	23.01	22.07	
		1732.5	22.99	21.86	
		1750.0	22.61	21.48	
	1 RB high	1715.0	22.75	21.71	
		1732.5	23.41	22.35	
		1750.0	22.54	21.65	
	50% RB low	1715.0	23.48	22.43	
		1732.5	22.75	21.81	
		1750.0	22.77	21.71	
	50% RB mid	1715.0	22.83	21.80	
		1732.5	22.98	21.93	
		1750.0	23.14	22.14	
	50% RB High	1715.0	22.50	21.47	
		1732.5	22.58	21.47	
		1750.0	23.41	22.36	
	100% RB	1715.0	22.63	21.52	
		1732.5	23.21	22.35	
		1750.0	23.16	22.04	
	15 MHz	1 RB low	1717.5	23.43	22.33
			1732.5	22.94	21.81
			1747.5	23.16	22.01
1 RB mid		1717.5	23.44	22.53	
		1732.5	22.92	21.77	
		1747.5	22.91	21.84	
1 RB high		1717.5	22.80	21.79	
		1732.5	23.33	22.48	
		1747.5	22.66	21.81	
50% RB low		1717.5	22.99	21.97	
		1732.5	22.84	21.87	
		1747.5	23.41	22.33	
50% RB mid		1717.5	23.02	22.10	
		1732.5	23.43	22.34	
		1747.5	23.28	22.27	
50% RB High		1717.5	22.90	21.89	
		1732.5	23.44	22.49	
		1747.5	23.07	22.14	
100% RB		1717.5	22.85	21.77	
		1732.5	23.06	22.14	
		1747.5	22.84	21.85	
20 MHz		1 RB low	1720.0	23.22	22.24
			1732.5	23.36	22.30
			1745.0	23.46	22.31

	1 RB mid	1720.0	23.10	22.22
		1732.5	23.50	22.39
		1745.0	23.48	22.50
	1 RB high	1720.0	22.66	21.69
		1732.5	23.05	22.06
		1745.0	22.82	21.90
	50% RB low	1720.0	23.09	22.24
		1732.5	23.41	22.46
		1745.0	23.07	21.95
	50% RB mid	1720.0	22.66	21.62
		1732.5	22.67	21.60
		1745.0	23.27	22.34
	50% RB High	1720.0	23.44	22.52
		1732.5	22.86	21.72
		1745.0	22.77	21.68
	100% RB	1720.0	23.43	22.41
		1732.5	23.15	22.19
		1745.0	22.59	21.63

Radiated Measurement:

Remark:

1. We were tested all RB Configuration refer 3GPP TS136 521 for each Channel Bandwidth of LTE FDD Band 4; recorded worst case for each Channel Bandwidth of LTE FDD Band 4.
2. $EIRP = P_{Mea}(dBm) - P_{cl}(dB) + P_{Ag}(dB) + G_a(dBi)$

LTE FDD Band 4_Channel Bandwidth 1.4MHz_QPSK

Frequency (MHz)	P _{Mea} (dBm)	P _{cl} (dB)	G _a Antenna Gain(dB)	P _{Ag} (dB)	EIRP (dBm)	Limit (dBm)	Margin (dB)	Polarization
1710.7	-19.79	2.75	8.98	35.70	22.14	30.00	7.86	V
1732.5	-19.68	2.81	9.15	35.70	22.36	30.00	7.64	V
1754.3	-19.97	2.85	9.47	35.70	22.35	30.00	7.65	V

LTE FDD Band 4_Channel Bandwidth 3MHz_QPSK

Frequency (MHz)	P _{Mea} (dBm)	P _{cl} (dB)	G _a Antenna Gain(dB)	P _{Ag} (dB)	EIRP (dBm)	Limit (dBm)	Margin (dB)	Polarization
1711.5	-20.19	2.75	8.98	35.70	21.74	30.00	8.26	V
1732.5	-19.59	2.81	9.15	35.70	22.45	30.00	7.55	V
1753.5	-20.01	2.85	9.47	35.70	22.31	30.00	7.69	V

LTE FDD Band 4_Channel Bandwidth 5MHz_QPSK

Frequency (MHz)	P _{Mea} (dBm)	P _{cl} (dB)	G _a Antenna Gain(dB)	P _{Ag} (dB)	EIRP (dBm)	Limit (dBm)	Margin (dB)	Polarization
1712.5	-20.24	2.75	8.98	35.70	21.69	30.00	8.31	V
1732.5	-19.85	2.81	9.15	35.70	22.19	30.00	7.81	V
1752.5	-20.45	2.85	9.47	35.70	21.87	30.00	8.13	V

LTE FDD Band 4_Channel Bandwidth 10MHz_QPSK

Frequency (MHz)	P _{Mea} (dBm)	P _{cl} (dB)	G _a Antenna Gain(dB)	P _{Ag} (dB)	EIRP (dBm)	Limit (dBm)	Margin (dB)	Polarization
1715.0	-20.02	2.75	8.98	35.70	21.91	30.00	8.09	V
1732.5	-19.75	2.81	9.15	35.70	22.29	30.00	7.71	V
1750.0	-20.30	2.85	9.47	35.70	22.02	30.00	7.98	V

LTE FDD Band 4_Channel Bandwidth 15MHz_QPSK

Frequency (MHz)	P _{Mea} (dBm)	P _{cl} (dB)	G _a Antenna Gain(dB)	P _{Ag} (dB)	EIRP (dBm)	Limit (dBm)	Margin (dB)	Polarization
1717.5	-20.28	2.75	8.98	35.70	21.65	30.00	8.35	V
1732.5	-19.92	2.81	9.15	35.70	22.12	30.00	7.88	V
1747.5	-20.39	2.85	9.47	35.70	21.93	30.00	8.07	V

LTE FDD Band 4_Channel Bandwidth 20MHz_QPSK

Frequency (MHz)	P _{Mea} (dBm)	P _{cl} (dB)	G _a Antenna Gain(dB)	P _{Ag} (dB)	EIRP (dBm)	Limit (dBm)	Margin (dB)	Polarization
1720.0	-19.93	2.75	8.98	35.70	22.00	30.00	8.00	V
1732.5	-20.28	2.81	9.15	35.70	21.76	30.00	8.24	V
1745.0	-20.70	2.85	9.47	35.70	21.62	30.00	8.38	V

LTE FDD Band 4_Channel Bandwidth 1.4MHz_16QAM

Frequency (MHz)	P _{Mea} (dBm)	P _{cl} (dB)	G _a Antenna Gain(dB)	P _{Ag} (dB)	EIRP (dBm)	Limit (dBm)	Margin (dB)	Polarization
1710.7	-20.82	2.75	8.98	35.70	21.11	30.00	8.89	V
1732.5	-21.44	2.81	9.15	35.70	20.60	30.00	9.40	V
1754.3	-21.80	2.85	9.47	35.70	20.52	30.00	9.48	V

LTE FDD Band 4_Channel Bandwidth 3MHz_16QAM

Frequency (MHz)	P _{Mea} (dBm)	P _{cl} (dB)	G _a Antenna Gain(dB)	P _{Ag} (dB)	EIRP (dBm)	Limit (dBm)	Margin (dB)	Polarization
1711.5	-21.40	2.75	8.98	35.70	20.53	30.00	9.47	V
1732.5	-21.53	2.81	9.15	35.70	20.51	30.00	9.49	V
1753.5	-20.82	2.85	9.47	35.70	21.50	30.00	8.50	V

LTE FDD Band 4_Channel Bandwidth 5MHz_16QAM

Frequency (MHz)	P _{Mea} (dBm)	P _{cl} (dB)	G _a Antenna Gain(dB)	P _{Ag} (dB)	EIRP (dBm)	Limit (dBm)	Margin (dB)	Polarization
1712.5	-20.47	2.75	8.98	35.70	21.46	30.00	8.54	V
1732.5	-20.73	2.81	9.15	35.70	21.31	30.00	8.69	V
1752.5	-21.48	2.85	9.47	35.70	20.84	30.00	9.16	V

LTE FDD Band 4_Channel Bandwidth 10MHz_16QAM

Frequency (MHz)	P _{Mea} (dBm)	P _{cl} (dB)	G _a Antenna Gain(dB)	P _{Ag} (dB)	EIRP (dBm)	Limit (dBm)	Margin (dB)	Polarization
1715.0	-21.32	2.75	8.98	35.70	20.61	30.00	9.39	V
1732.5	-20.88	2.81	9.15	35.70	21.16	30.00	8.84	V
1750.0	-21.01	2.85	9.47	35.70	21.31	30.00	8.69	V

LTE FDD Band 4_Channel Bandwidth 15MHz_16QAM

Frequency (MHz)	P _{Mea} (dBm)	P _{cl} (dB)	G _a Antenna Gain(dB)	P _{Ag} (dB)	EIRP (dBm)	Limit (dBm)	Margin (dB)	Polarization
1717.5	-21.20	2.75	8.98	35.70	20.73	30.00	9.27	V
1732.5	-20.76	2.81	9.15	35.70	21.28	30.00	8.72	V
1747.5	-21.23	2.85	9.47	35.70	21.09	30.00	8.91	V

LTE FDD Band 4_Channel Bandwidth 20MHz_16QAM

Frequency (MHz)	P _{Mea} (dBm)	P _{cl} (dB)	G _a Antenna Gain(dB)	P _{Ag} (dB)	EIRP (dBm)	Limit (dBm)	Margin (dB)	Polarization
1720.0	-20.46	2.75	8.98	35.70	21.47	30.00	8.53	V
1732.5	-20.94	2.81	9.15	35.70	21.10	30.00	8.90	V
1745.0	-21.40	2.85	9.47	35.70	20.92	30.00	9.08	V

3.2 Peak-to-Average Ratio (PAR)

LIMIT

The Peak-to-Average Ratio (PAR) of the transmission may not exceed 13 dB.

TEST CONFIGURATION

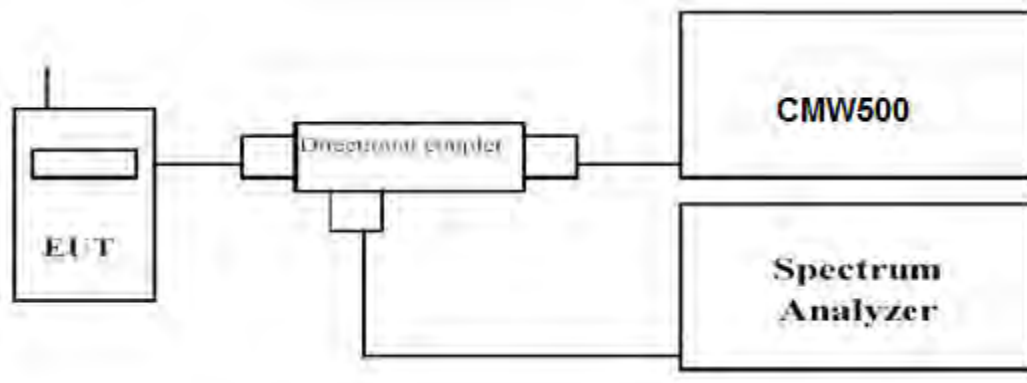

TEST PROCEDURE

1. Refer to instrument's analyzer instruction manual for details on how to use the power statistics/CCDF function;
2. Set resolution/measurement bandwidth \geq signal's occupied bandwidth;
3. Set the number of counts to a value that stabilizes the measured CCDF curve;
4. Set the measurement interval as follows:
 - 1). for continuous transmissions, set to 1 ms,
 - 2). for burst transmissions, employ an external trigger that is synchronized with the EUT burst timing sequence, or use the internal burst trigger with a trigger level that allows the burst to stabilize and set the measurement interval to a time that is less than or equal to the burst duration.
5. Record the maximum PAPR level associated with a probability of 0.1%.

TEST RESULTS*Remark:*

1. We were tested all RB Configuration refer 3GPP TS136 521 for each Channel Bandwidth of LTE FDD Band 4; recorded worst case for each Channel Bandwidth of LTE FDD Band 4.

<i>LTE FDD Band 4</i>				
TX Channel Bandwidth	Frequency (MHz)	RB Size/Offset	PAPR (dB)	
			QPSK	16QAM
1.4 MHz	1710.7	1RB#0	4.38	5.30
	1732.5		5.04	5.91
	1754.3		4.23	5.28
3 MHz	1711.5	1RB#0	5.10	5.94
	1732.5		4.90	5.77
	1753.5		4.90	5.77
5 MHz	1712.5	1RB#0	5.13	5.94
	1732.5		4.96	5.77
	1752.5		5.04	5.80
10 MHz	1715.0	1RB#0	5.10	5.91
	1732.5		4.99	5.86
	1750.0		5.16	5.97
15 MHz	1717.5	1RB#0	5.25	5.94
	1732.5		5.22	5.94
	1747.5		5.48	6.09
20 MHz	1720.0	1RB#0	4.99	5.88
	1732.5		5.10	5.94
	1745.0		5.22	6.12

LTE FDD Band 4-1.4MHz Channel Bandwidth PAPR

QPSK

16QAM

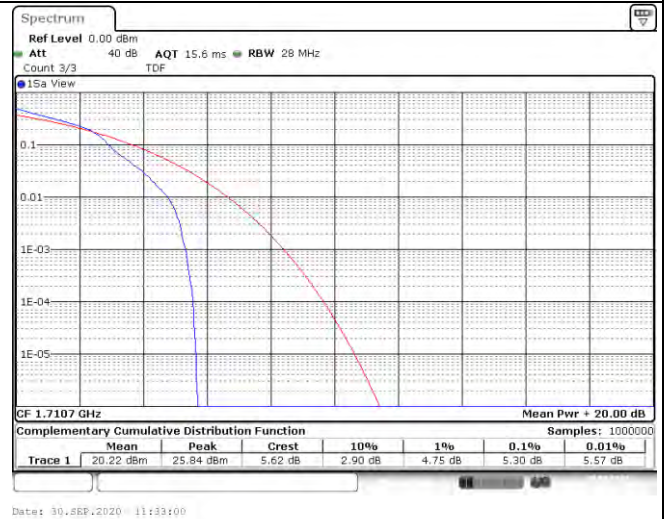
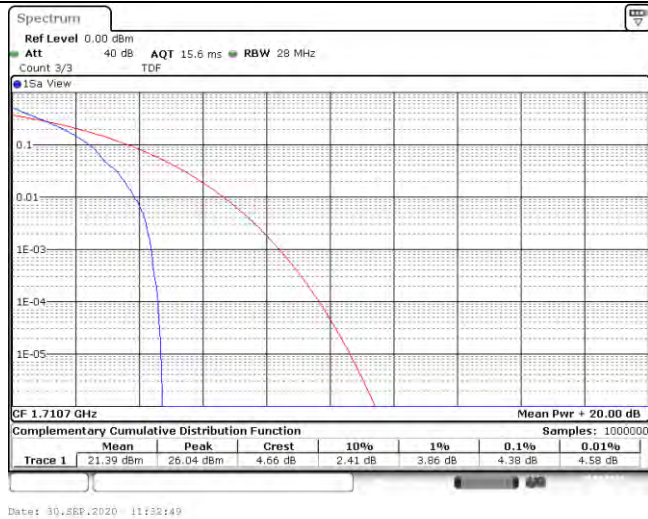

1RB#0

1RB#0

Low Channel

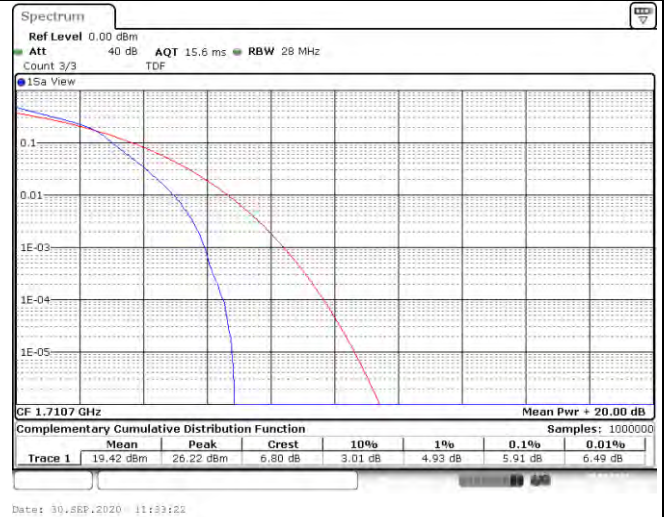

1RB#0

1RB#0

Middle Channel

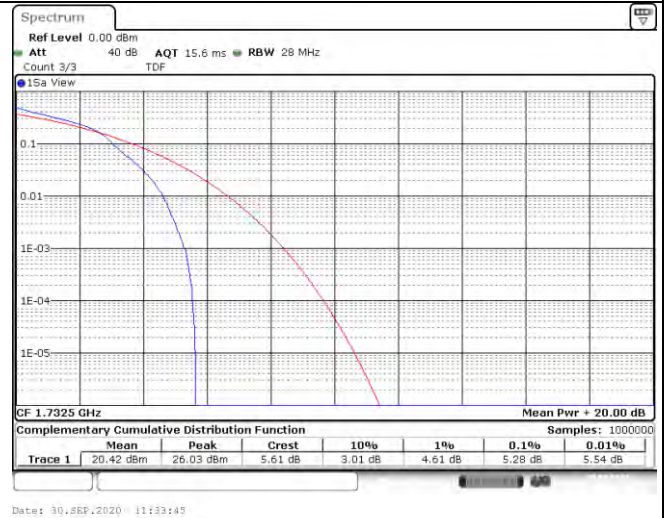

1RB#0

1RB#0

High Channel

LTE FDD Band 4-3MHz Channel Bandwidth PAPR

QPSK

16QAM

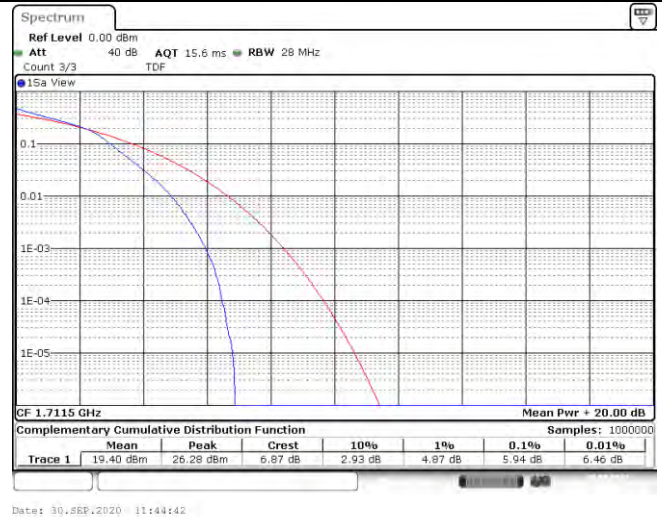

1RB#0

1RB#0

Low Channel



1RB#0

1RB#0

Middle Channel

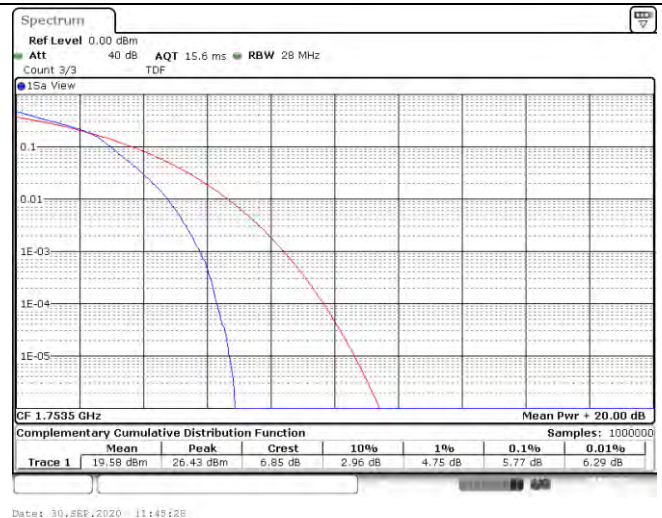
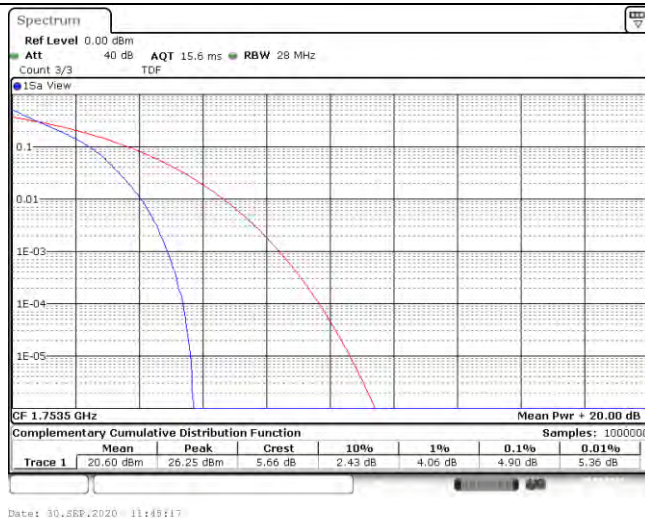

1RB#0

1RB#0

High Channel

LTE FDD Band 4-5MHz Channel Bandwidth PAPR

QPSK

16QAM

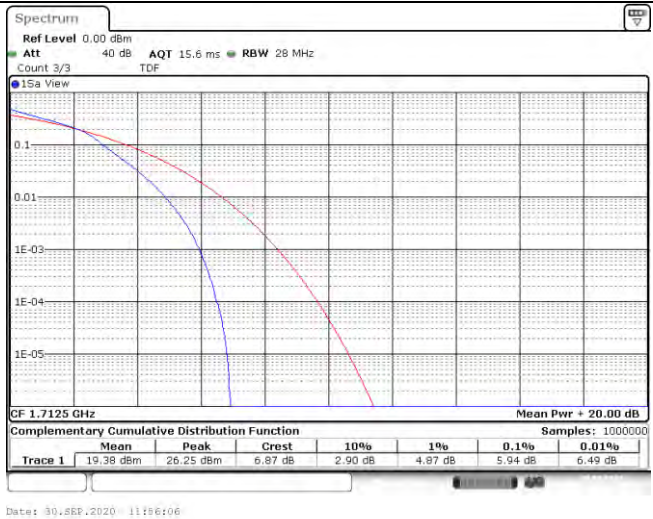
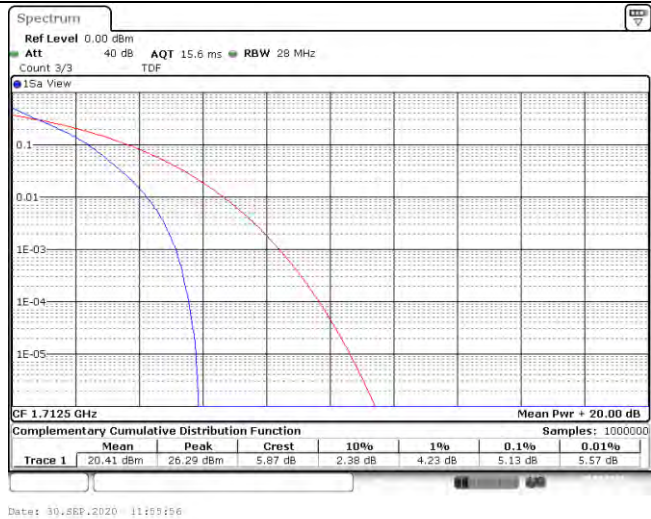

1RB#0

1RB#0

Low Channel

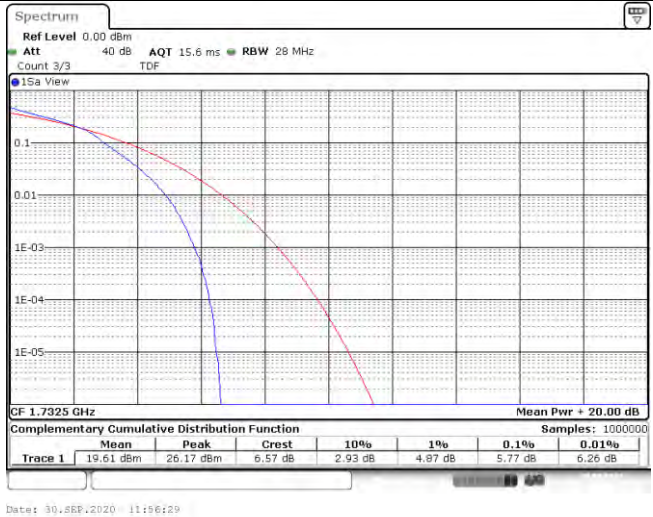
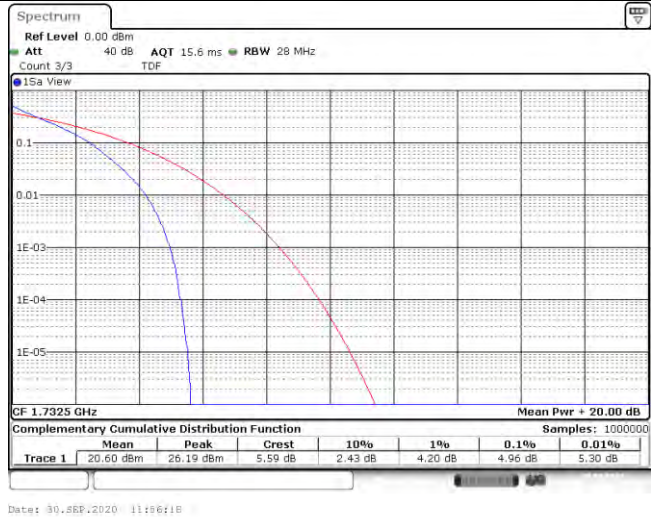

1RB#0

1RB#0

Middle Channel

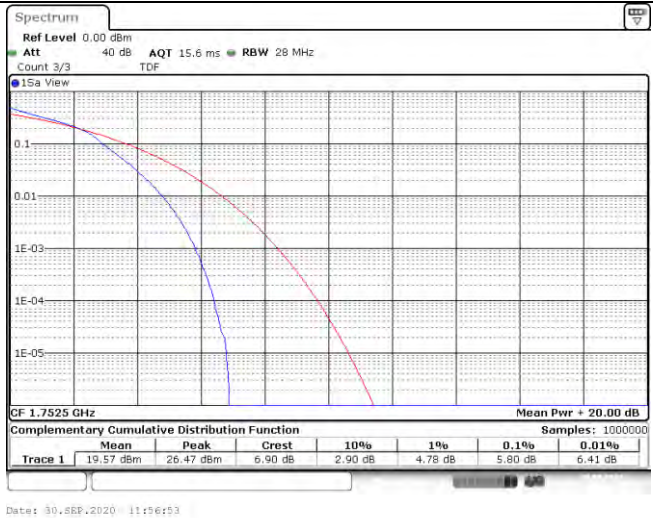

1RB#0

1RB#0

High Channel

LTE FDD Band 4-10MHz Channel Bandwidth PAPR

QPSK

16QAM



1RB#0

1RB#0

Low Channel



1RB#0

1RB#0

Middle Channel

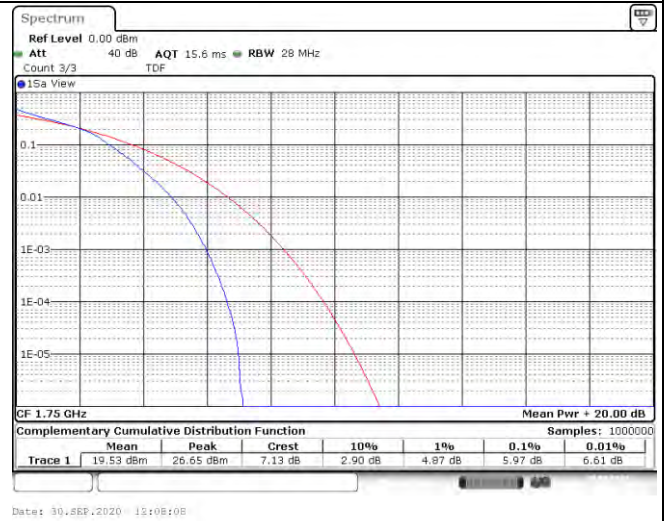
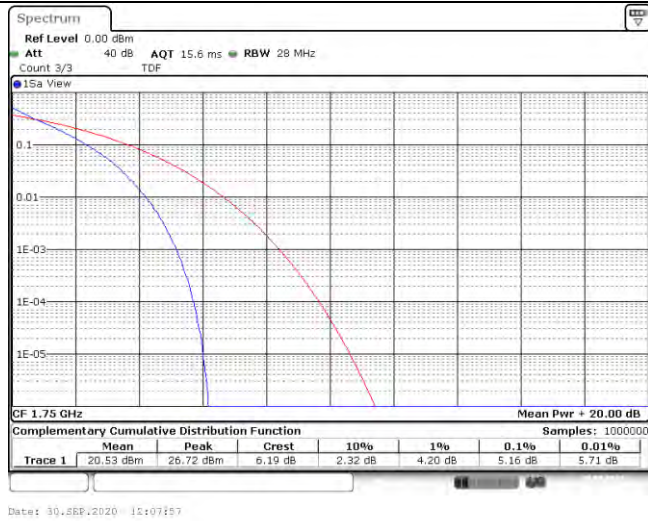

1RB#0

1RB#0

High Channel

LTE FDD Band 4-15MHz Channel Bandwidth PAPR

QPSK

16QAM

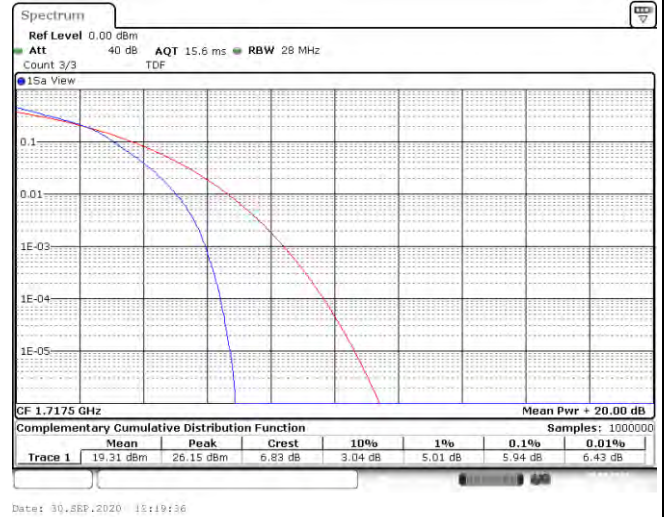
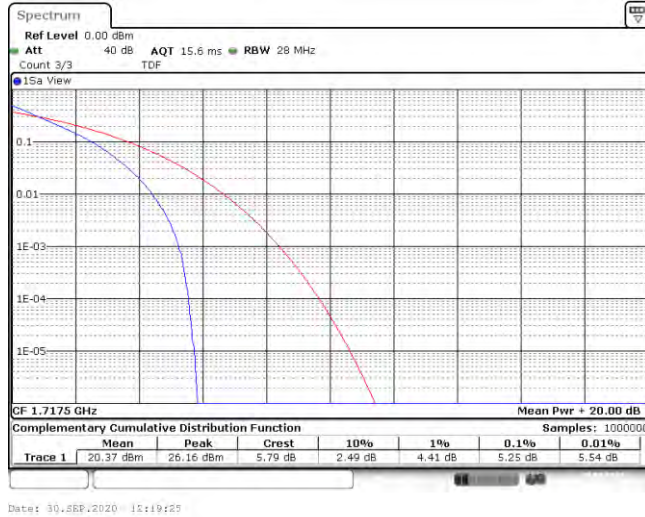

1RB#0

1RB#0

Low Channel

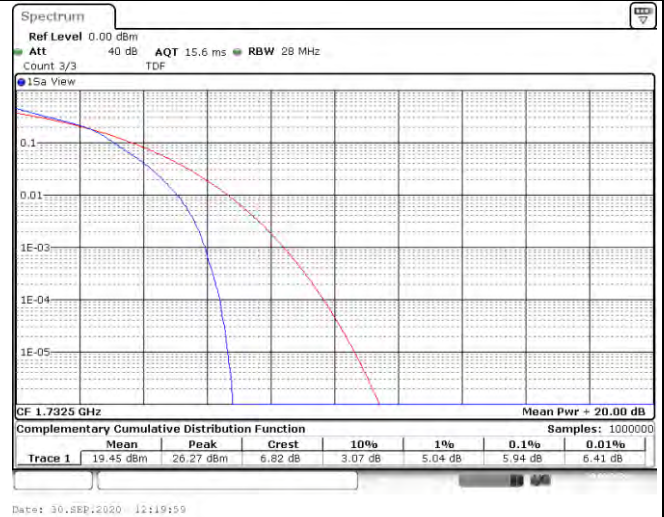

1RB#0

1RB#0

Middle Channel

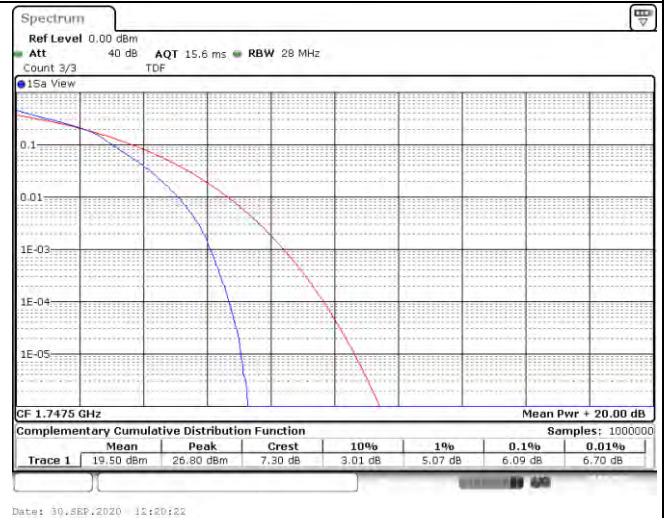
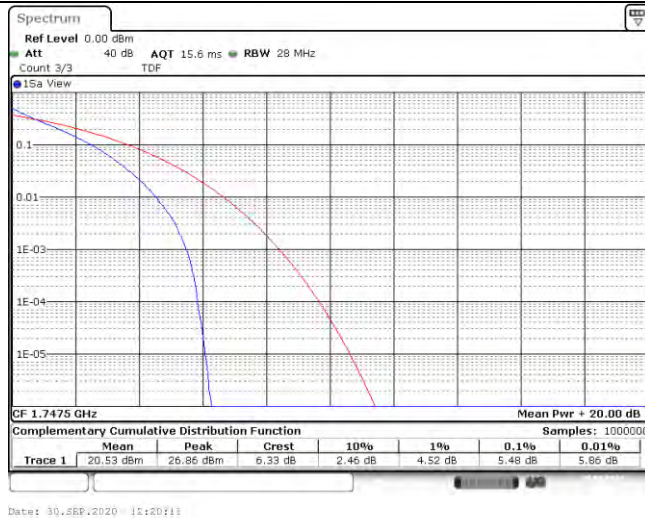

1RB#0

1RB#0

High Channel

LTE FDD Band 4-20MHz Channel Bandwidth PAPR

QPSK

16QAM

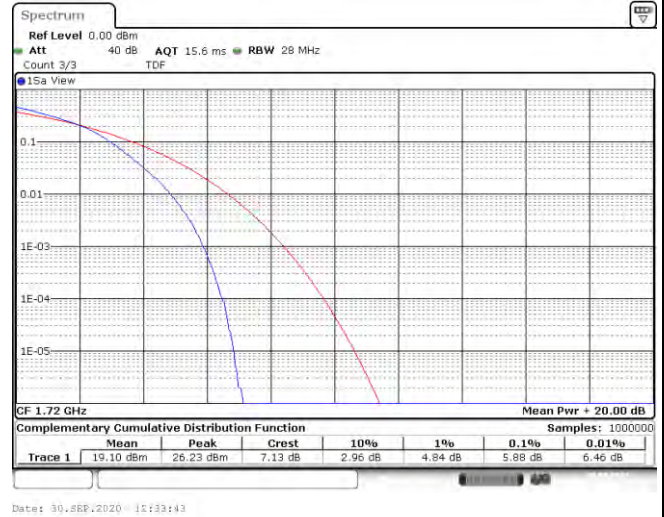
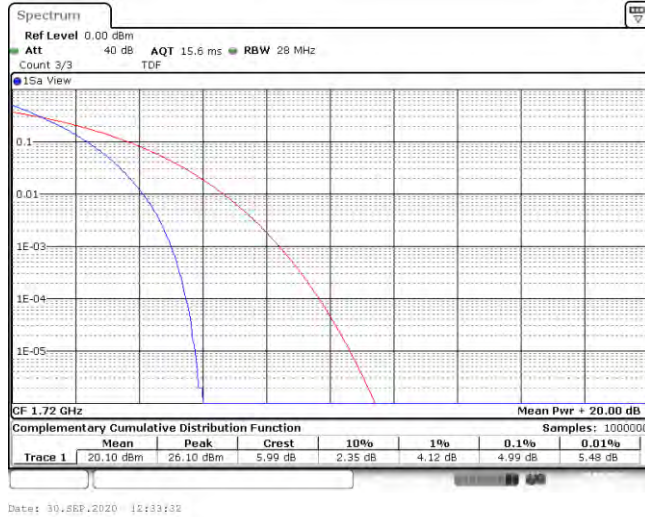

1RB#0

1RB#0

Low Channel

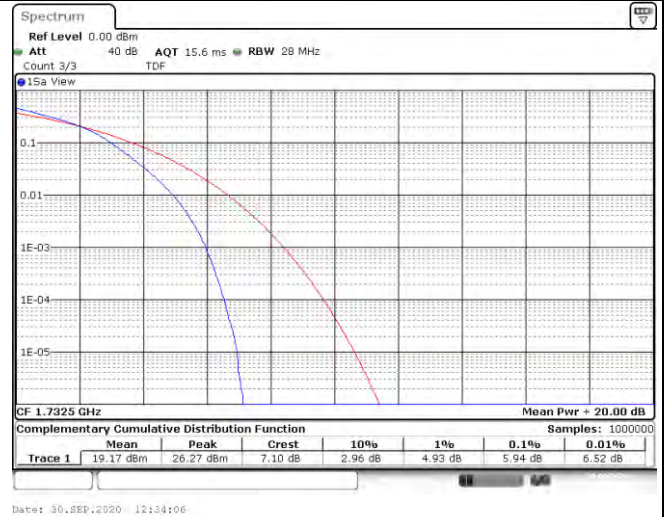

1RB#0

1RB#0

Middle Channel

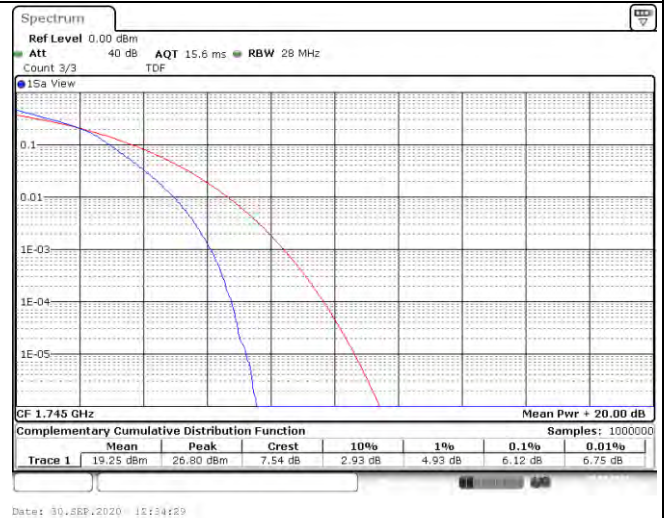

1RB#0

1RB#0

High Channel

3.3 Occupied Bandwidth and Emission Bandwidth

LIMIT

N/A

TEST CONFIGURATION

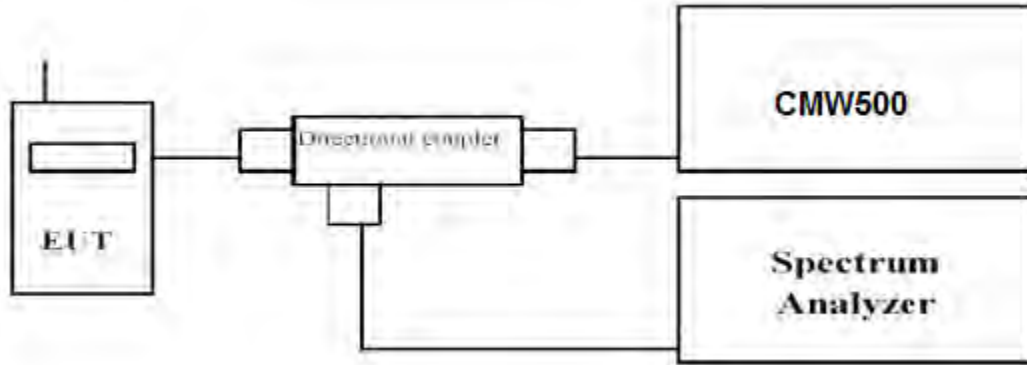

TEST PROCEDURE

The transmitter output was connected to a calibrated coaxial cable and coupler, the other end of which was connected to a spectrum analyzer. The occupied bandwidth was measured with the spectrum analyzer at low, middle and high channel in each band. The -26dBc Emission bandwidth was also measured and recorded.

Set RBW was set to about 1% of emission BW, VBW≥3 times RBW.

-26dBc display line was placed on the screen (or 99% bandwidth), the occupied bandwidth is the delta frequency between the two points where the display line intersects the signal trace.

TEST RESULTS

Remark:

1. We were tested all RB Configuration refer 3GPP TS136 521 for each Channel Bandwidth of LTE FDD Band 4; recorded worst case for each Channel Bandwidth of LTE FDD Band 4.

LTE FDD Band 4						
TX Channel Bandwidth	RB Size/Offset	Frequency (MHz)	-26dBc Emission bandwidth (MHz)		99% Occupied bandwidth (MHz)	
			QPSK	16QAM	QPSK	16QAM
1.4 MHz	6RB#0	1710.7	1.305	1.315	1.093	1.098
		1732.5	1.305	1.285	1.098	1.088
		1754.3	1.315	1.325	1.093	1.098
3 MHz	15RB#0	1711.5	2.92	2.93	2.686	2.676
		1732.5	2.92	2.93	2.686	2.686
		1753.5	2.93	2.91	2.686	2.676
5 MHz	25RB#0	1712.5	4.96	4.93	4.496	4.486
		1732.5	4.94	4.98	4.486	4.496
		1752.5	4.96	4.96	4.505	4.496
10 MHz	50RB#0	1715.0	9.833	9.767	8.952	8.985
		1732.5	9.867	9.833	8.952	8.985
		1750.0	9.9	9.767	8.985	9.018
15 MHz	75RB#0	1717.5	14.75	14.85	13.527	13.428
		1732.5	14.85	14.8	13.428	13.478
		1747.5	14.85	14.75	13.478	13.478
20 MHz	100RB#0	1720.0	19.667	19.733	18.037	18.103
		1732.5	19.8	19.667	18.037	18.037
		1745.0	19.667	19.8	18.037	18.103

LTE FDD Band 4-1.4MHz Channel Bandwidth

QPSK

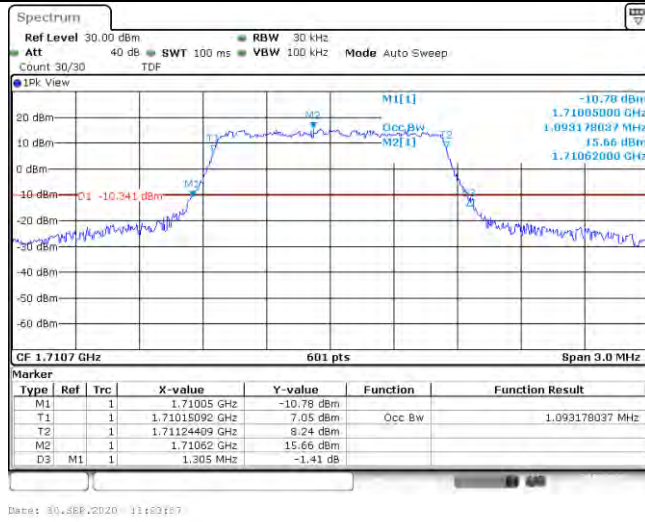

16QAM

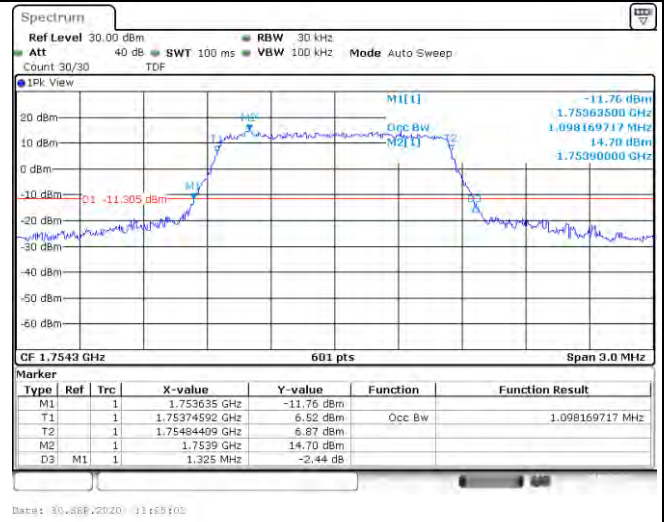

6RB#0

6RB#0

Low Channel

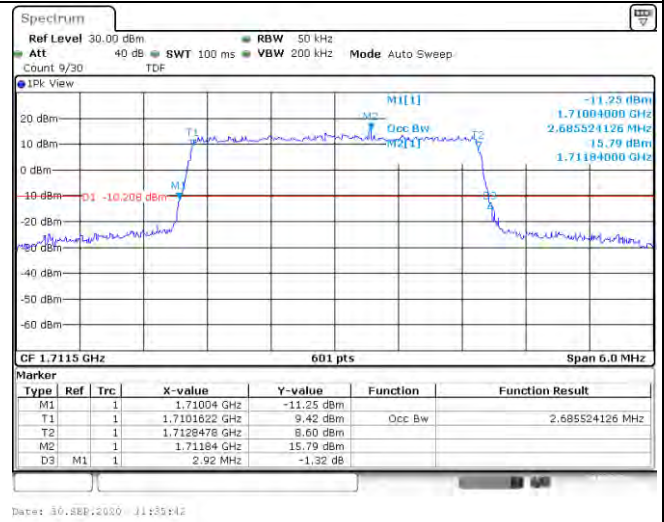
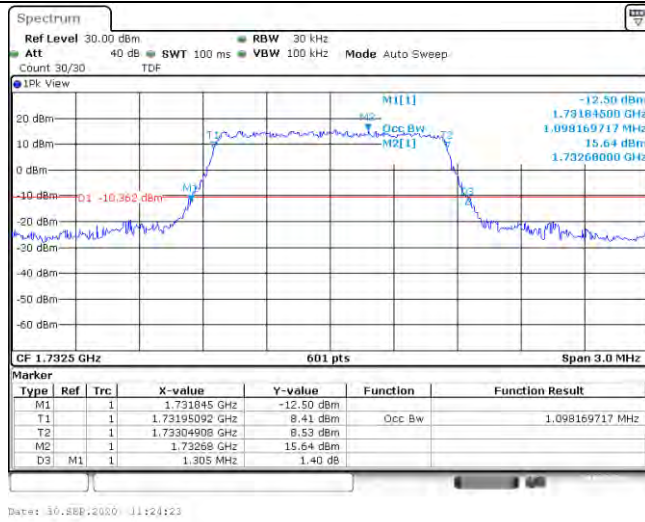

6RB#0

6RB#0

Middle Channel

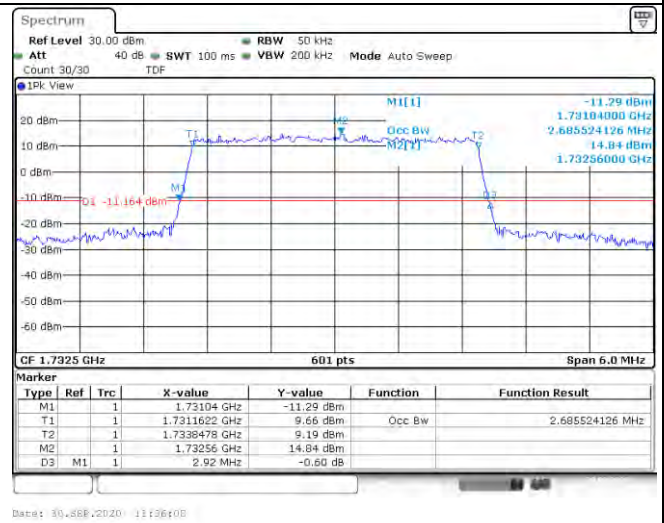
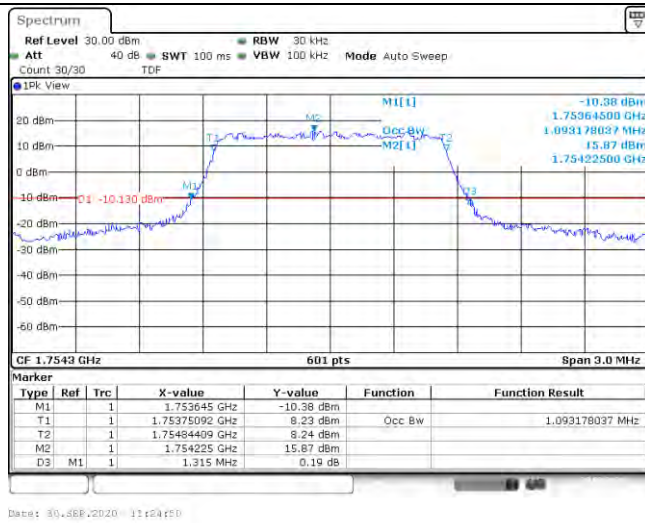

6RB#0

6RB#0

High Channel

LTE FDD Band 4-3MHz Channel Bandwidth

QPSK

16QAM

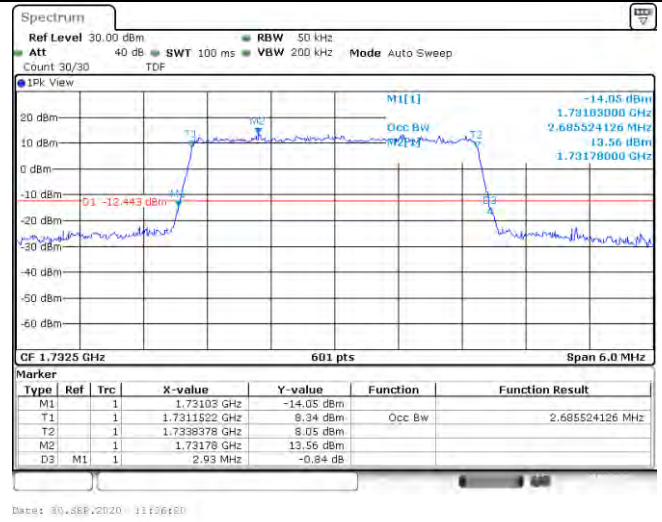
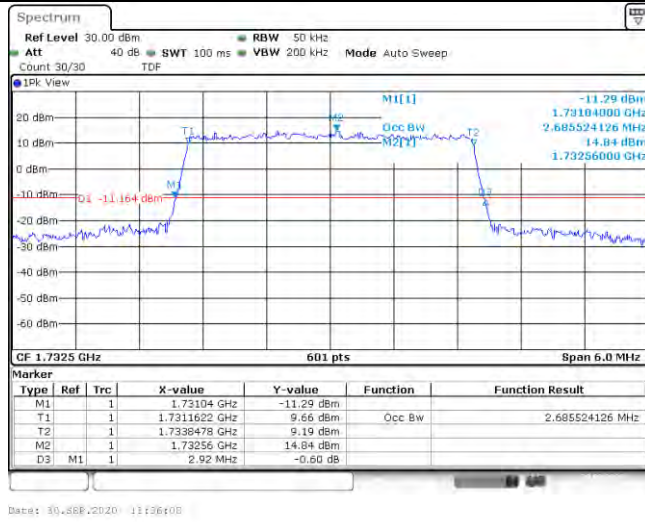

15RB#0

15RB#0

Low Channel

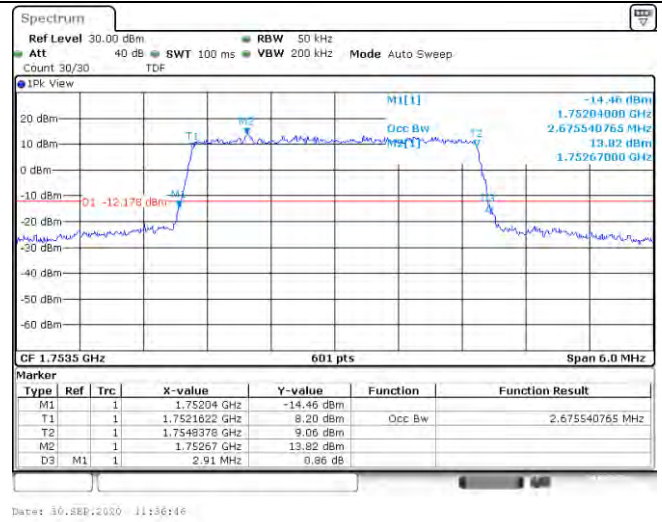
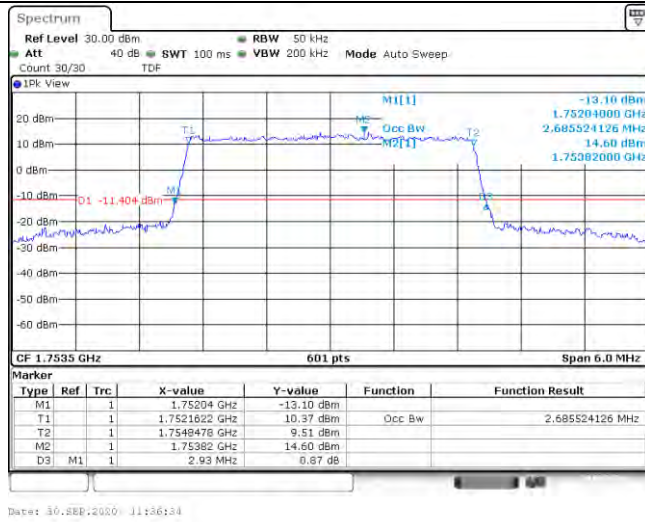

15RB#0

15RB#0

Middle Channel

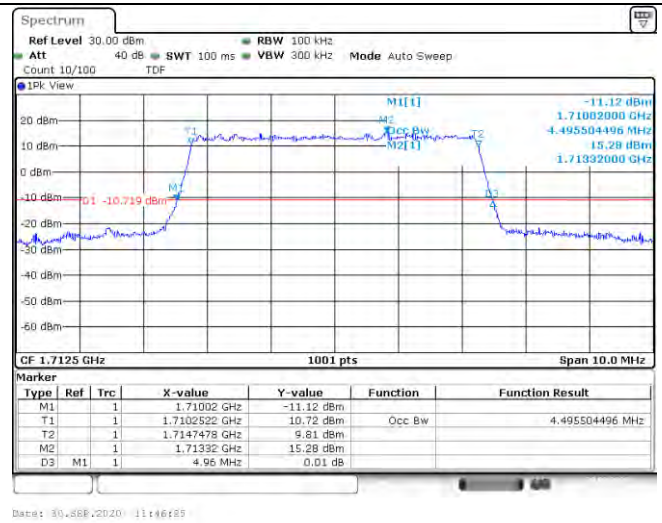
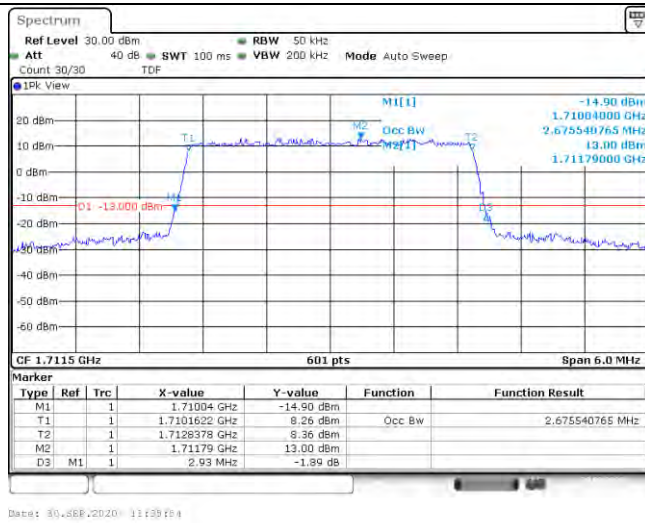

15RB#0

15RB#0

High Channel

LTE FDD Band 4-5MHz Channel Bandwidth

QPSK

16QAM

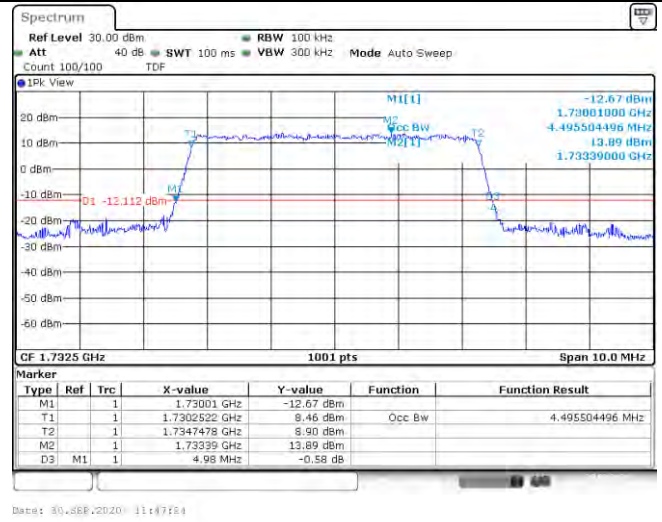
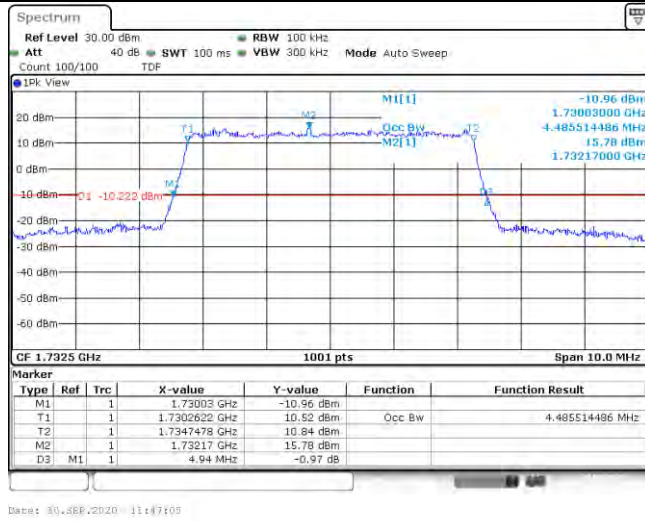

25RB#0

25RB#0

Low Channel

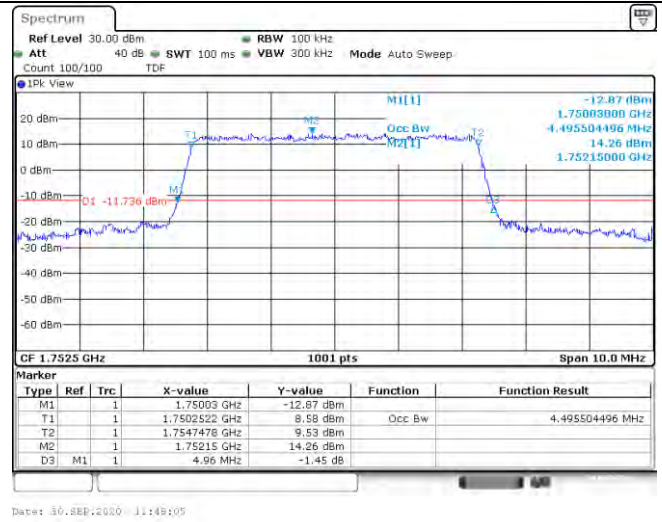
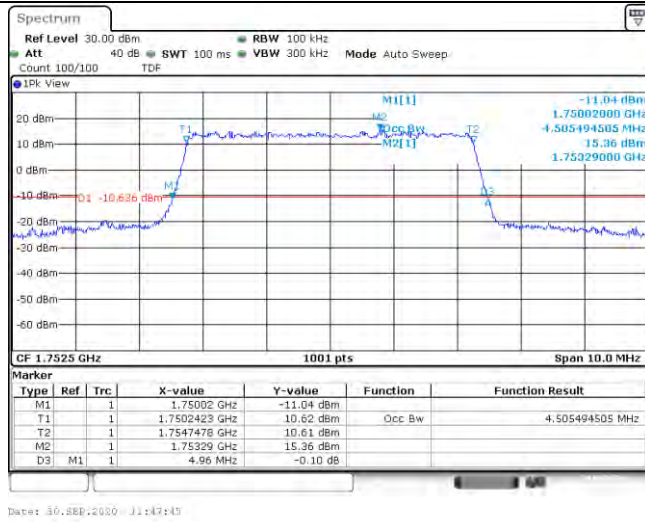

25RB#0

25RB#0

Middle Channel

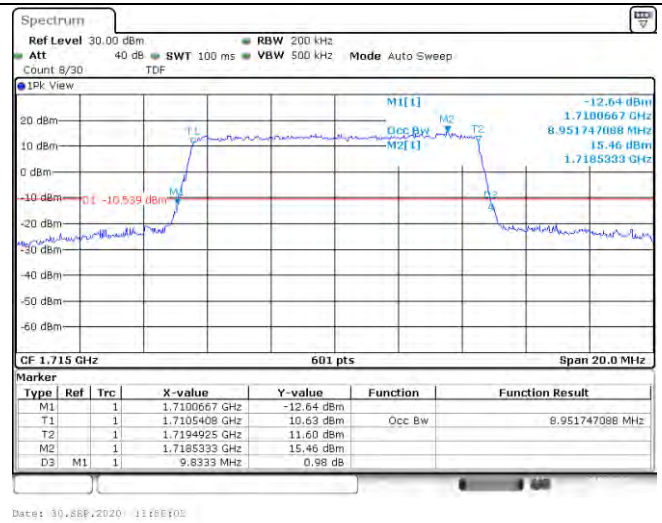
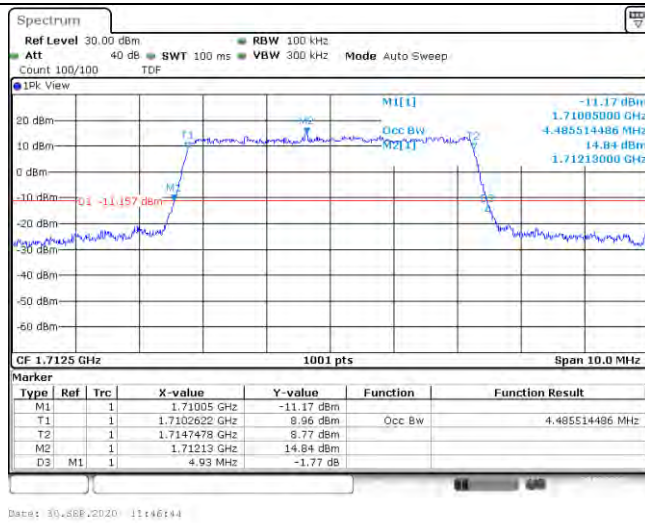

25RB#0

25RB#0

High Channel LTE FDD Band 4-10MHz Channel Bandwidth

QPSK

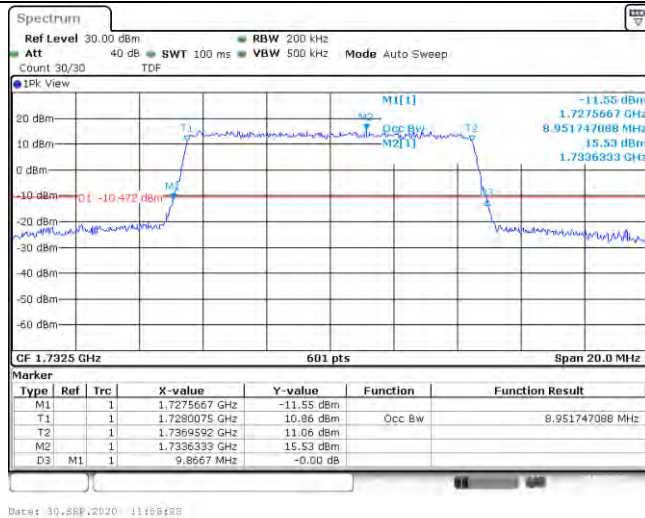

16QAM

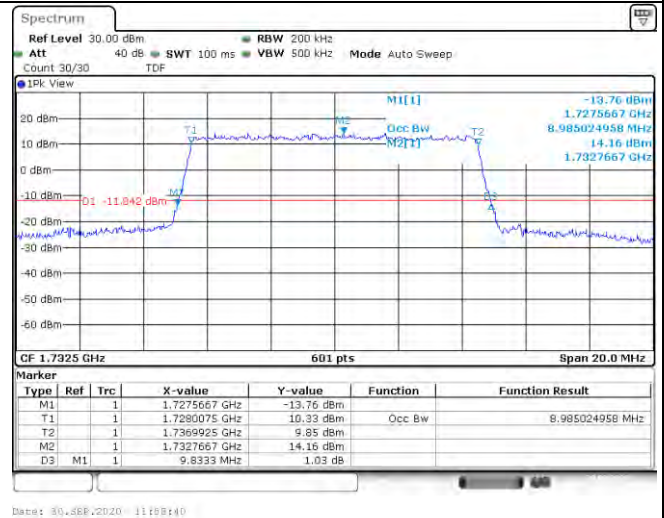

50RB#0

50RB#0

Low Channel

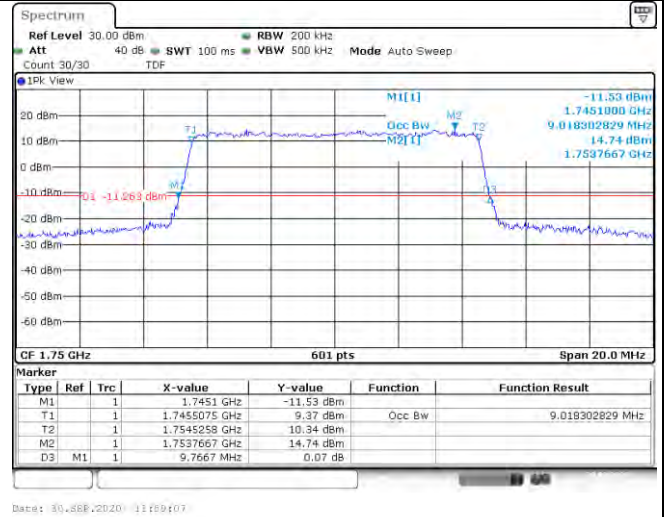
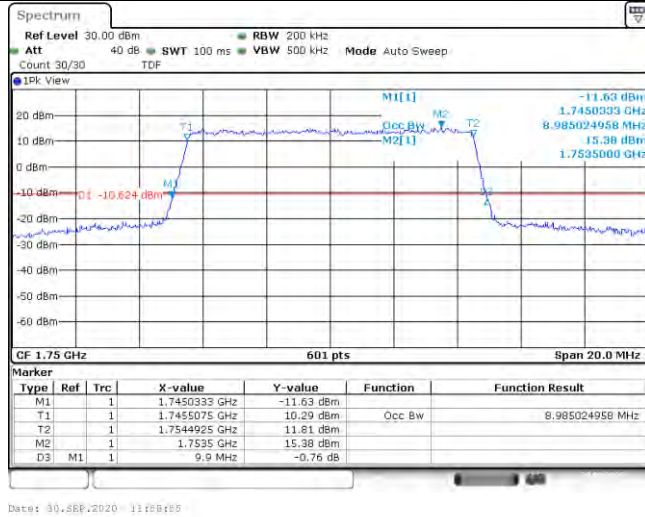

50RB#0

50RB#0

Middle Channel

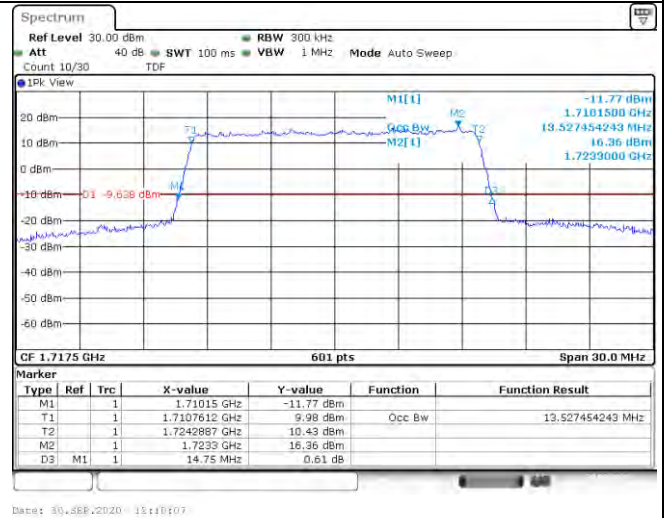
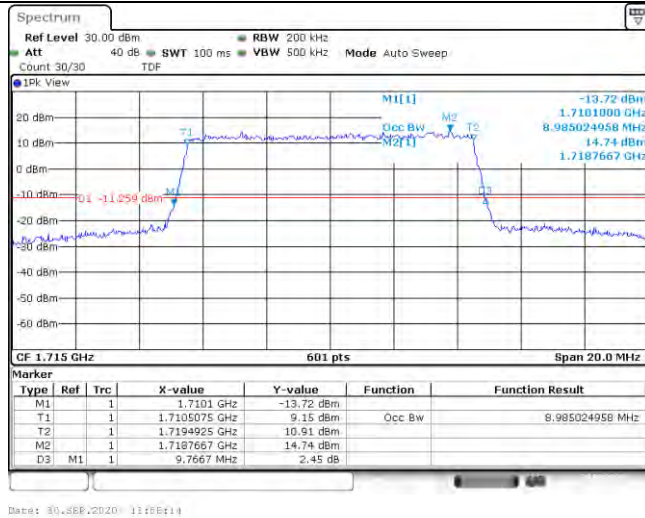

50RB#0

50RB#0

High Channel

LTE FDD Band 4-15MHz Channel Bandwidth

QPSK

16QAM

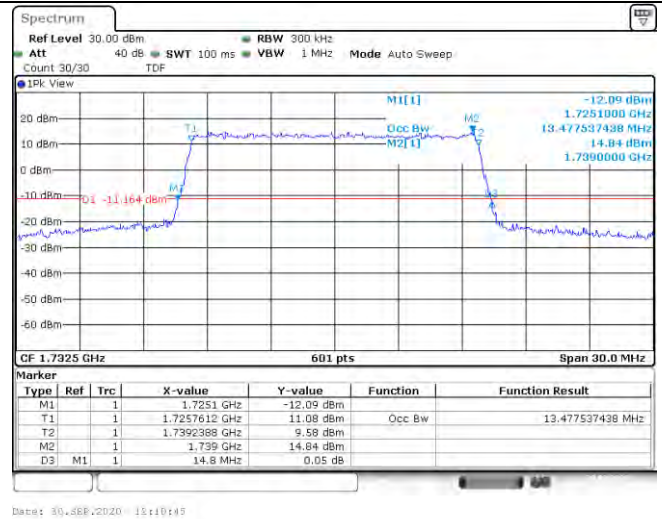
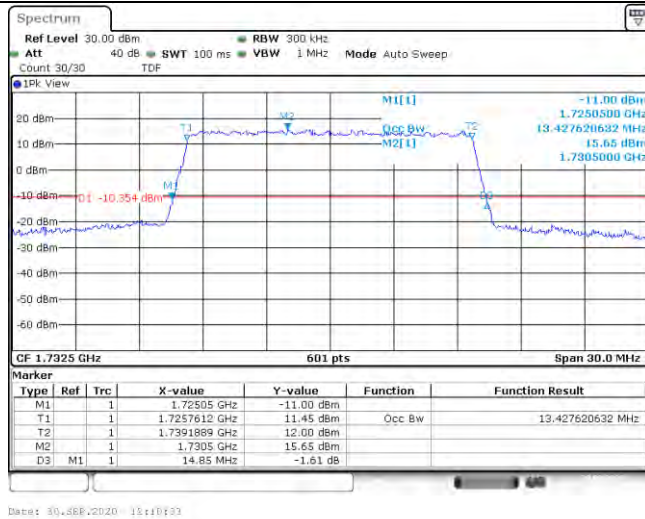

75RB#0

75RB#0

Low Channel

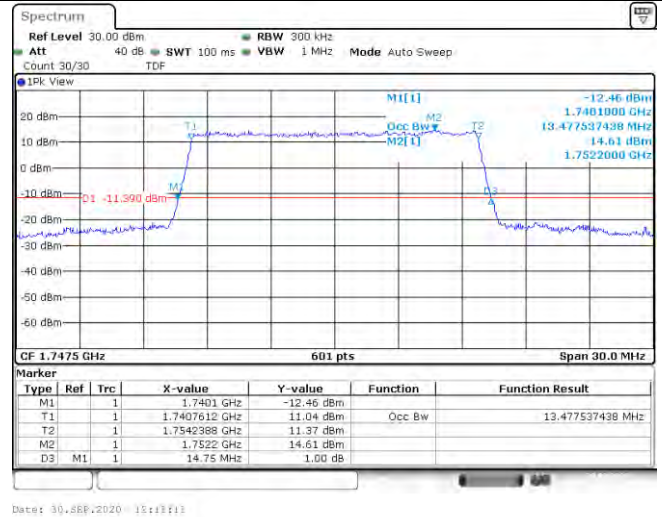
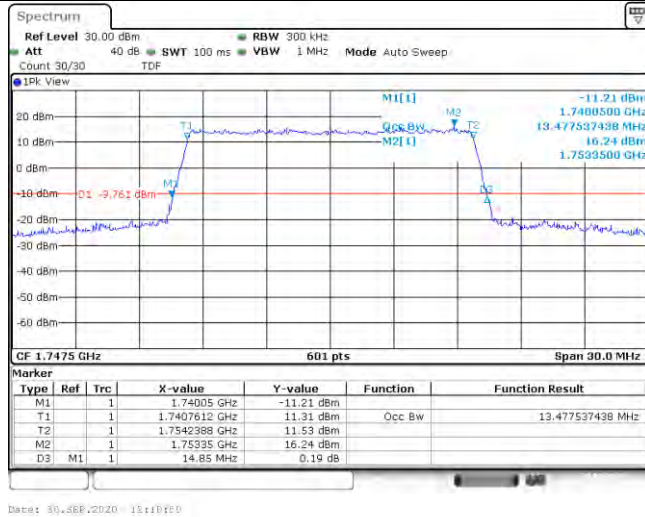

75RB#0

75RB#0

Middle Channel

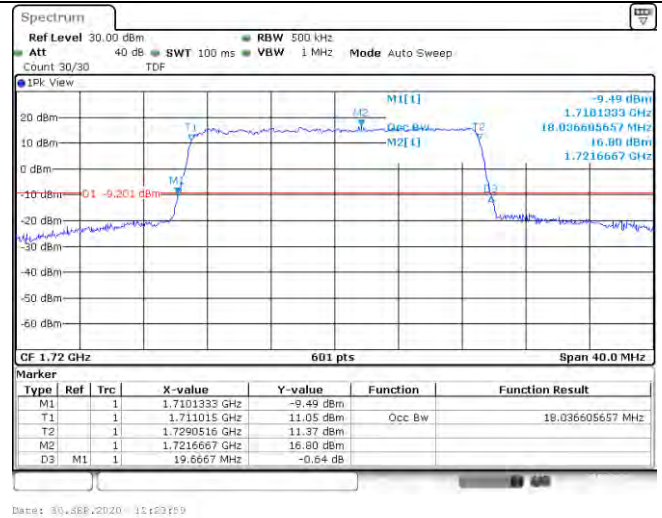
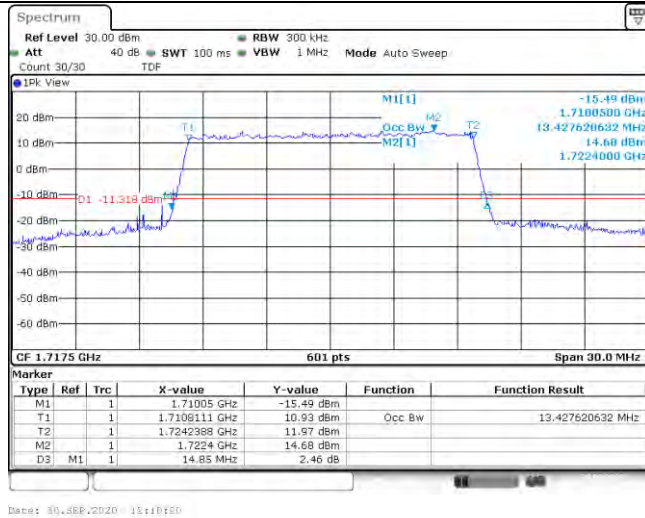

75RB#0

75RB#0

High Channel

LTE FDD Band 4-20MHz Channel Bandwidth

QPSK

16QAM

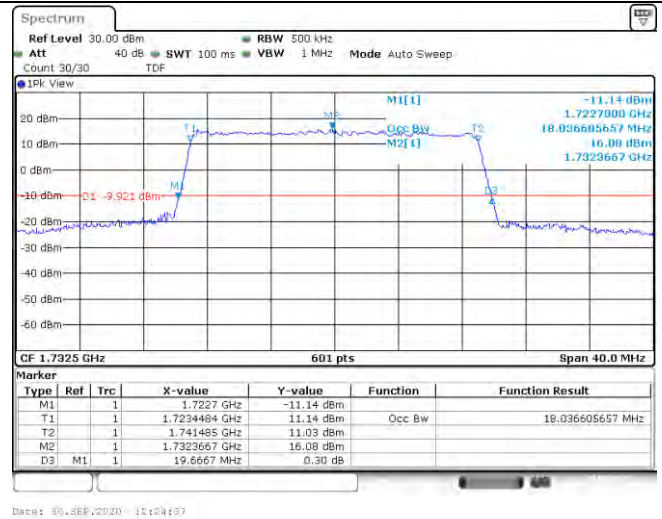
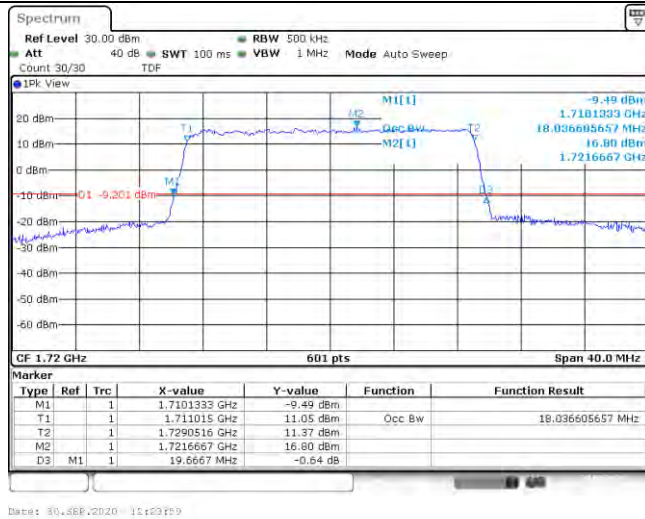

100RB#0

100RB#0

Low Channel

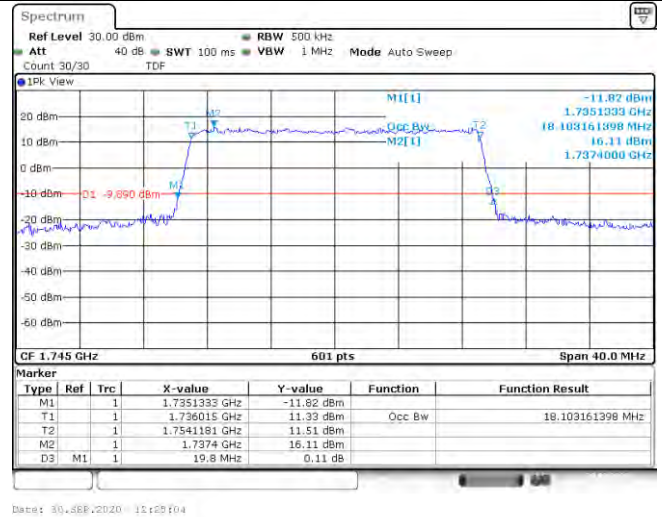
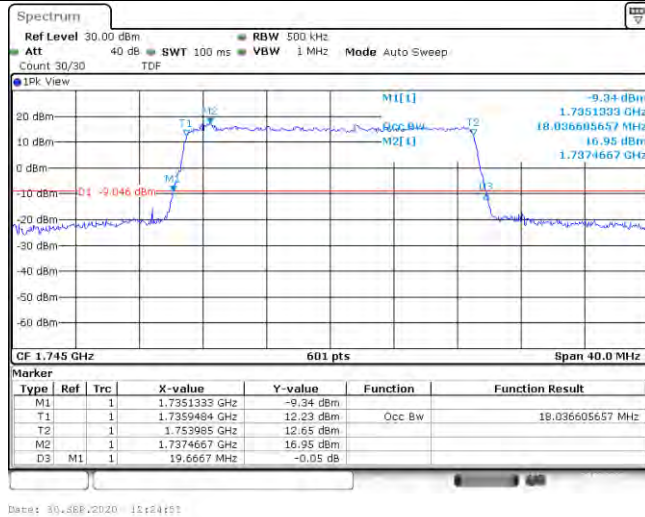

100RB#0

100RB#0

Middle Channel

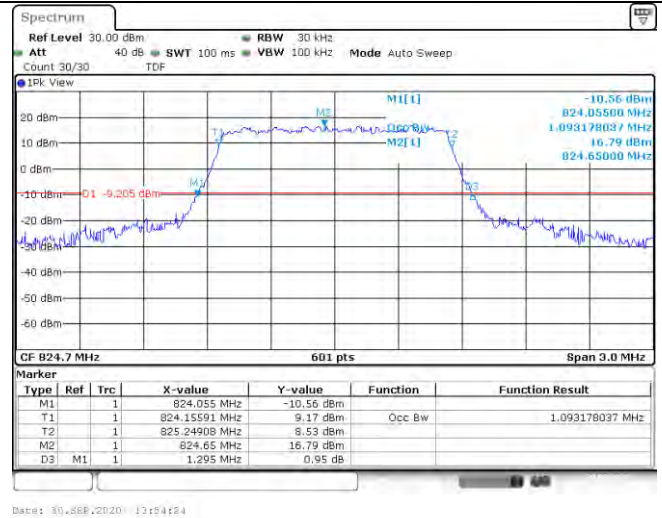
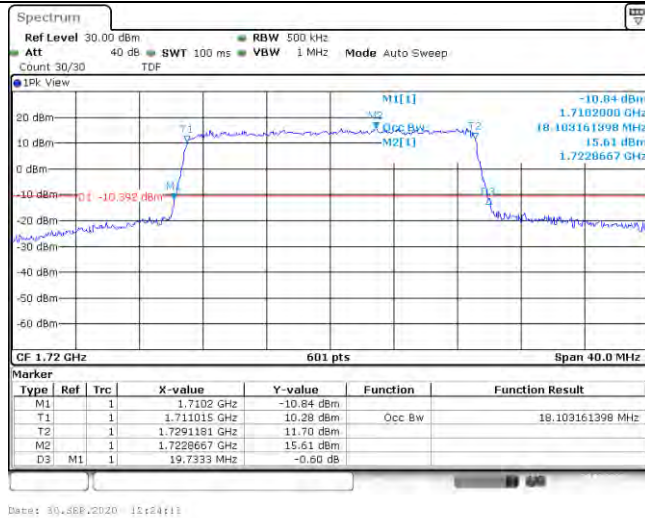

100RB#0

100RB#0

High Channel

3.4 Band Edge compliance

LIMIT

According to §27.53 (h): For operations in the 1710–1755 MHz and 2110–2155 MHz bands, the power of any emission outside a licensee’s frequency block shall be attenuated below the transmitter power (P) by at least $43 + 10 \log_{10}(P)$ dB.

TEST CONFIGURATION

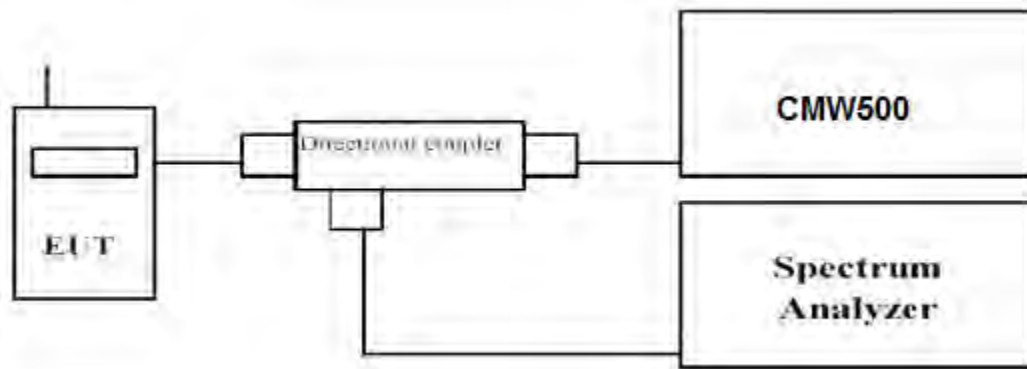

TEST PROCEDURE

1. The transmitter output port was connected to base station.
2. The RF output of EUT was connected to the power meter by RF cable and attenuator, the path loss was compensated to the results for each measurement.
3. Set EUT at maximum power through base station.
4. Select lowest and highest channels for each band and different modulation.
5. Measure Band edge using RMS (Average) detector by spectrum

TEST RESULTS

Remark:

1. We were tested all RB Configuration refer 3GPP TS136 521 for each Channel Bandwidth of LTE FDD Band 4; recorded worst case for each Channel Bandwidth of LTE FDD Band 4.

LTE FDD Band 4-1.4MHz Channel Bandwidth Band Edge Compliance

QPSK

16QAM

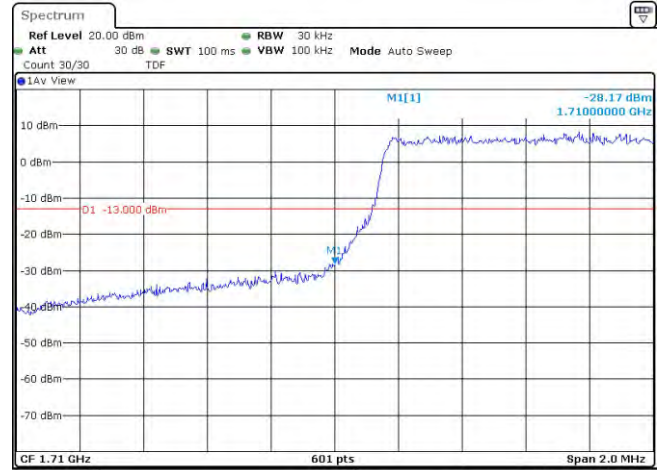
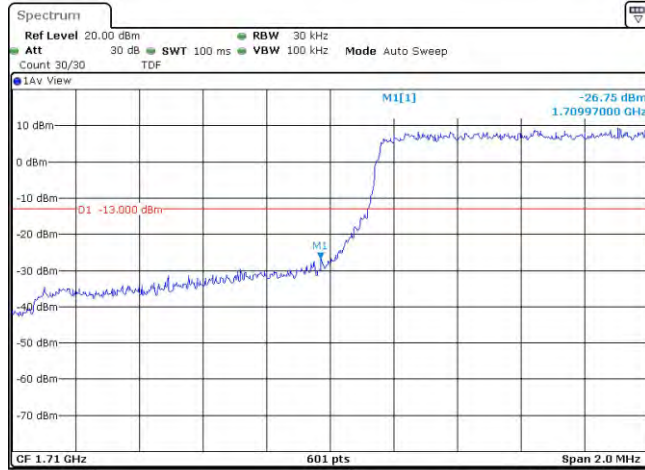

Date: 21.OCT.2020 19:36:46

Date: 21.OCT.2020 19:36:56

6RB#0

6RB#0

Low Channel

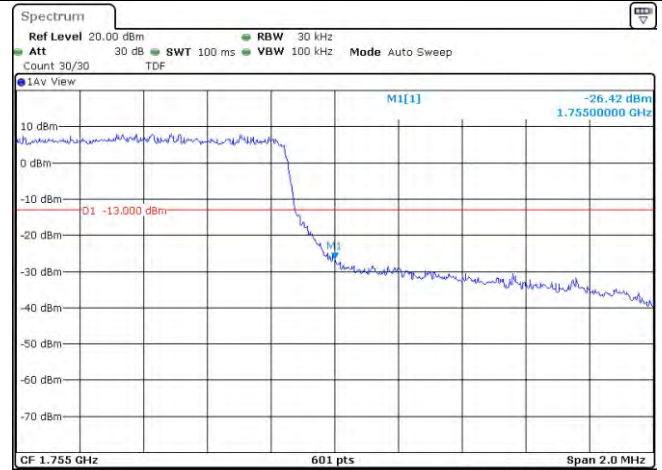
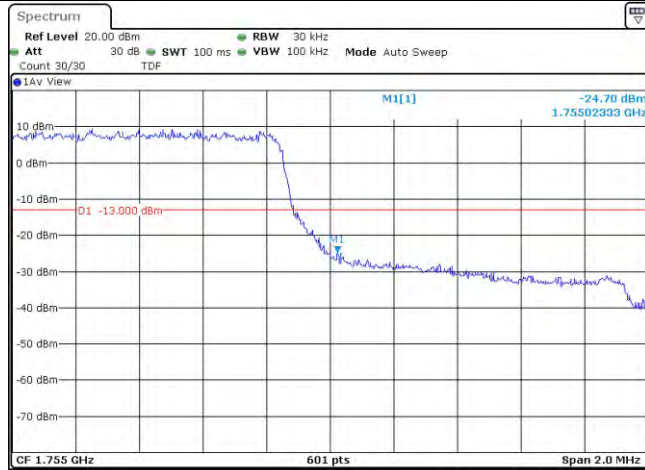

Date: 21.OCT.2020 19:37:08

Date: 21.OCT.2020 19:37:18

6RB#0

6RB#0

High Channel

LTE FDD Band 4-3MHz Channel Bandwidth Band Edge Compliance

QPSK

16QAM

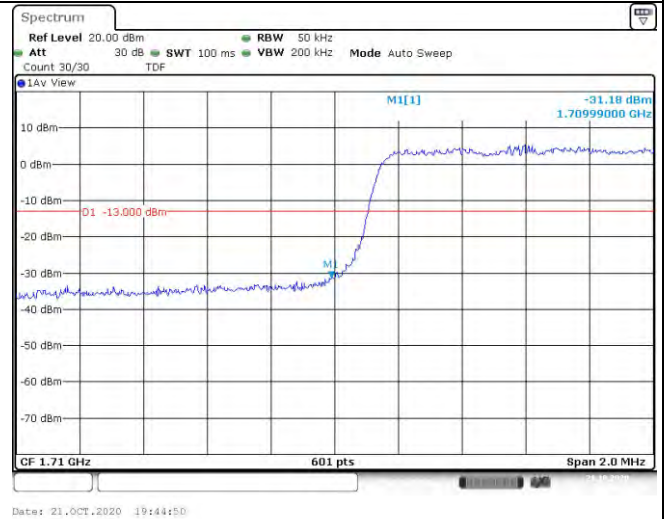
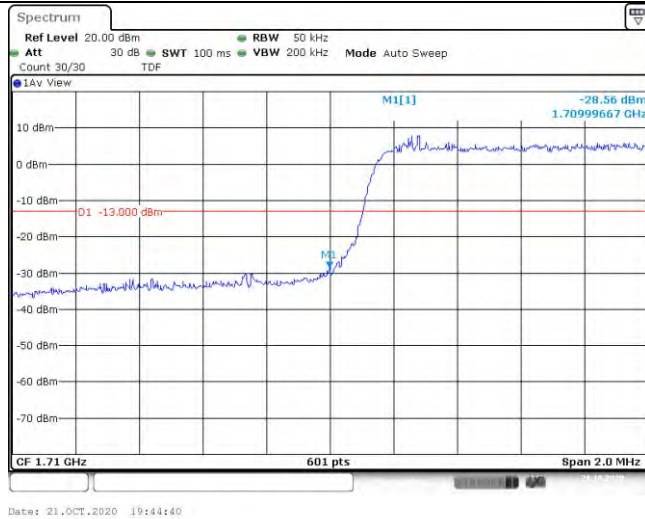

15RB#0

15RB#0

Low Channel

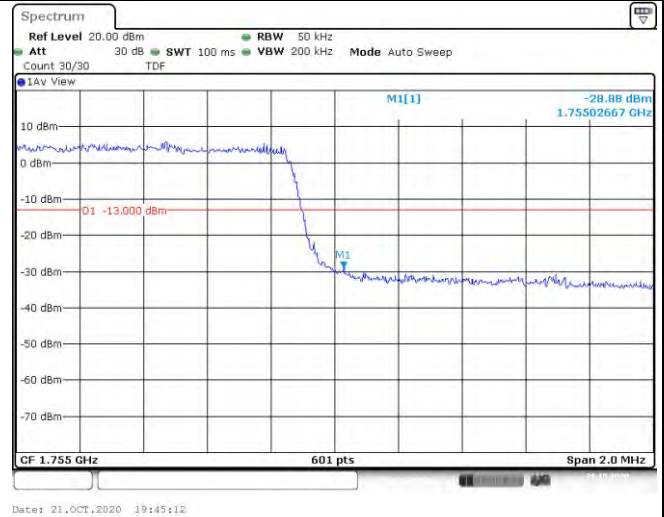
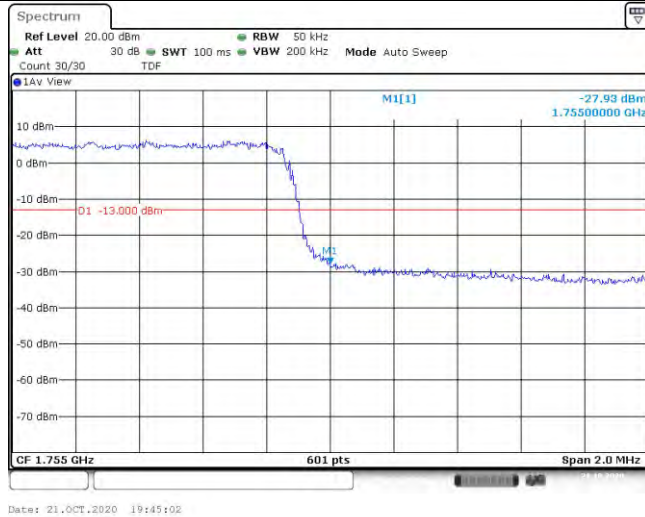

15RB#0

15RB#0

High Channel

LTE FDD Band 4-5MHz Channel Bandwidth Band Edge Compliance

QPSK

16QAM

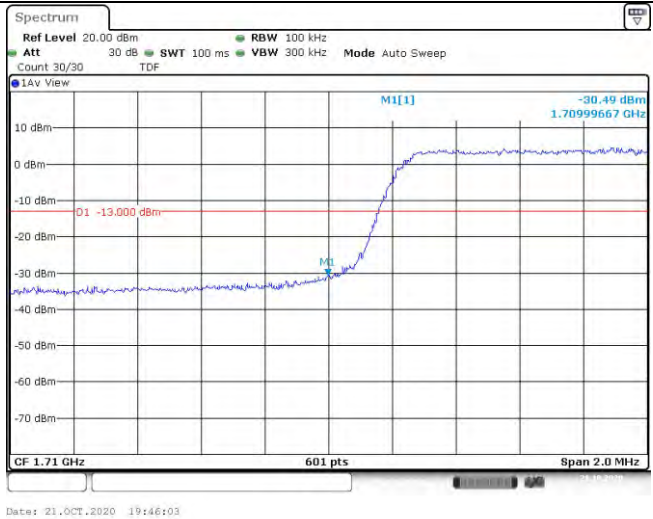
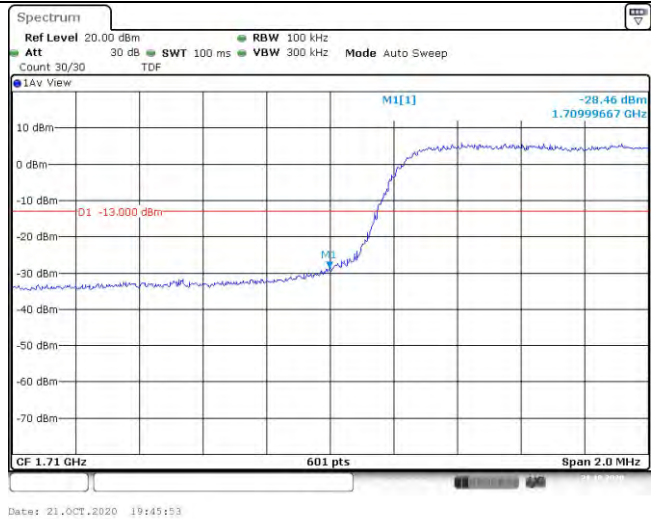

25RB#0

25RB#0

Low Channel

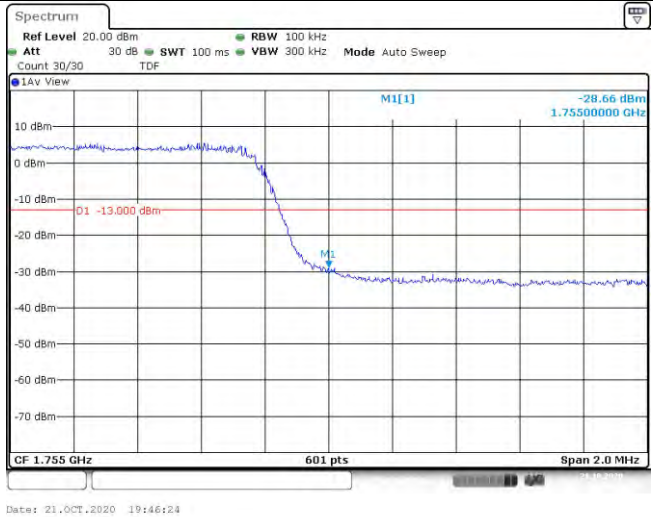
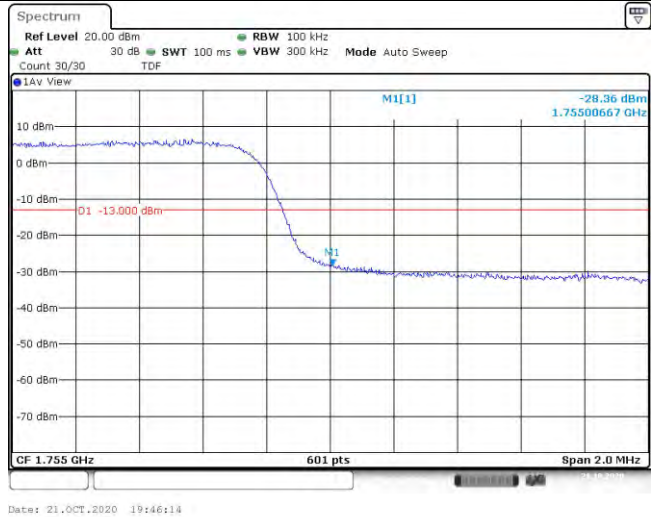

25RB#0

25RB#0

High Channel

LTE FDD Band 4-10MHz Channel Bandwidth Band Edge Compliance

QPSK

16QAM

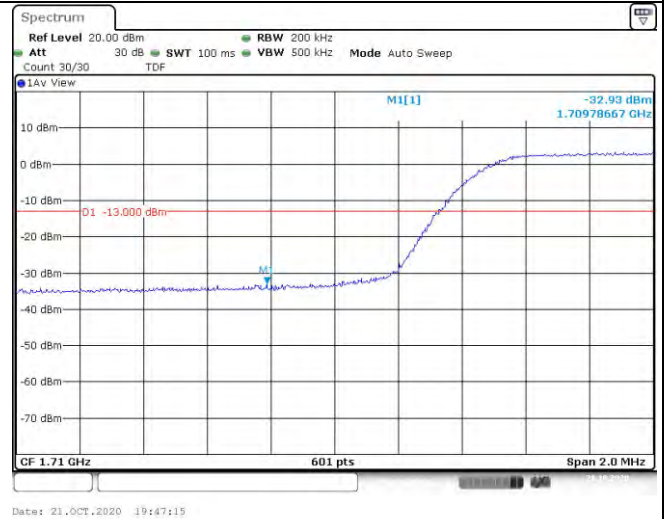
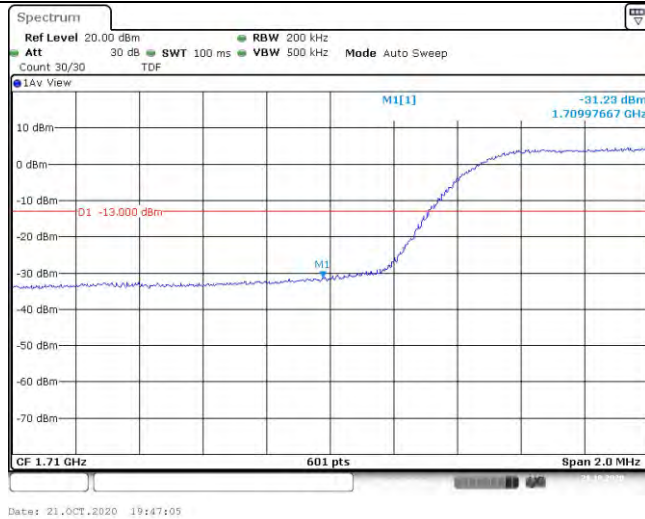

50RB#0

50RB#0

Low Channel

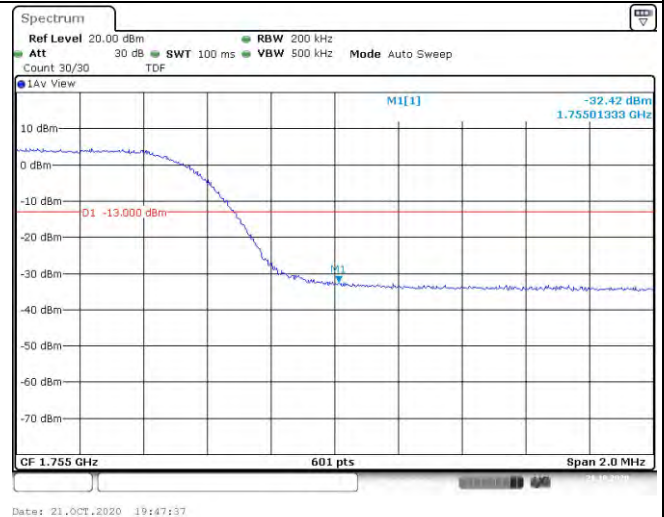
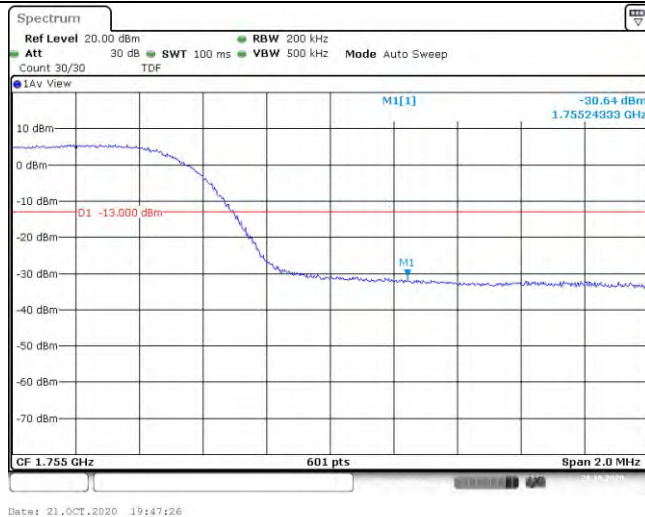

50RB#0

50RB#0

High Channel

LTE FDD Band 4-15MHz Channel Bandwidth Band Edge Compliance

QPSK

16QAM

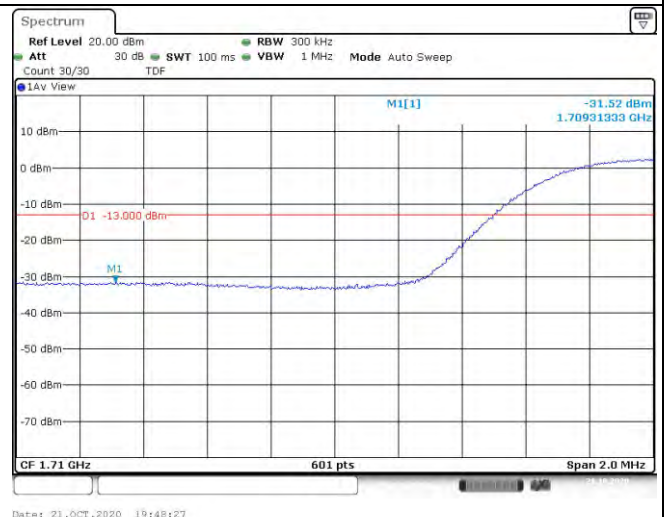
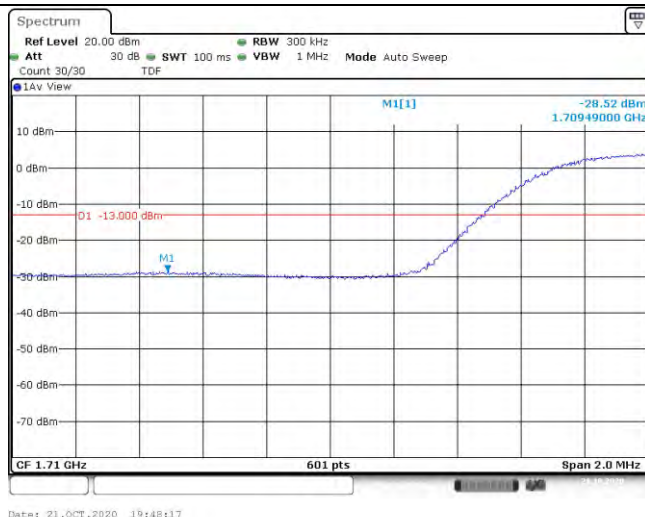

75RB#0

75RB#0

Low Channel

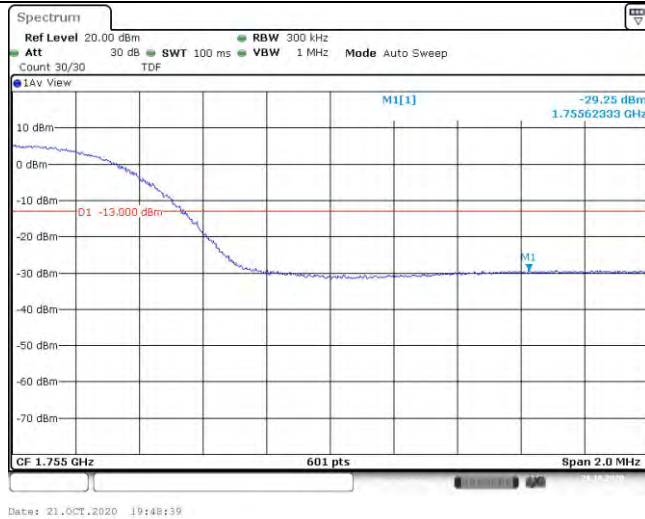

75RB#0

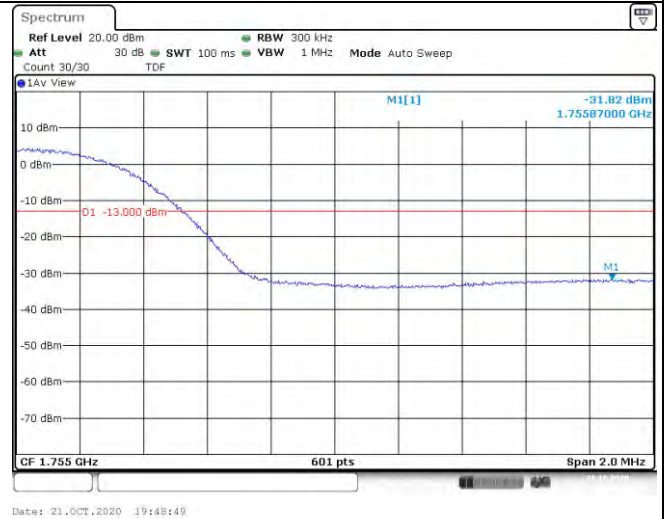

75RB#0

High Channel

LTE FDD Band 4-20MHz Channel Bandwidth Band Edge Compliance

QPSK

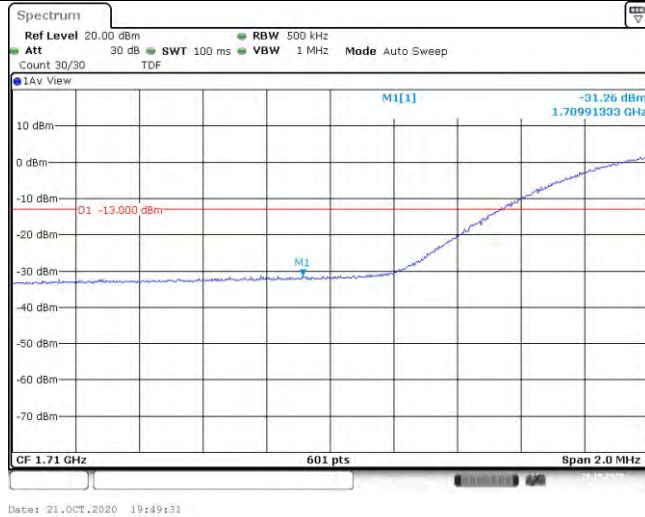

100RB#0

16QAM

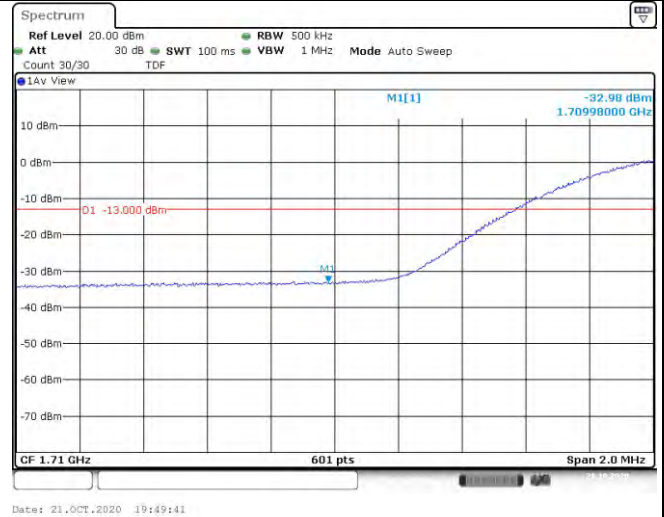

100RB#0

Low Channel

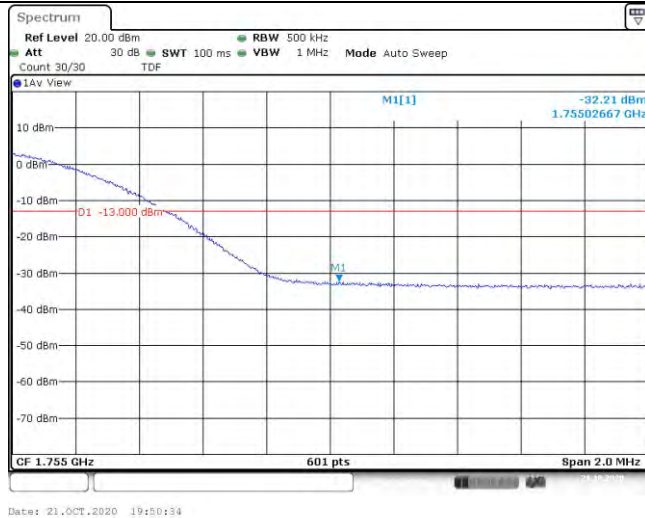

100RB#0

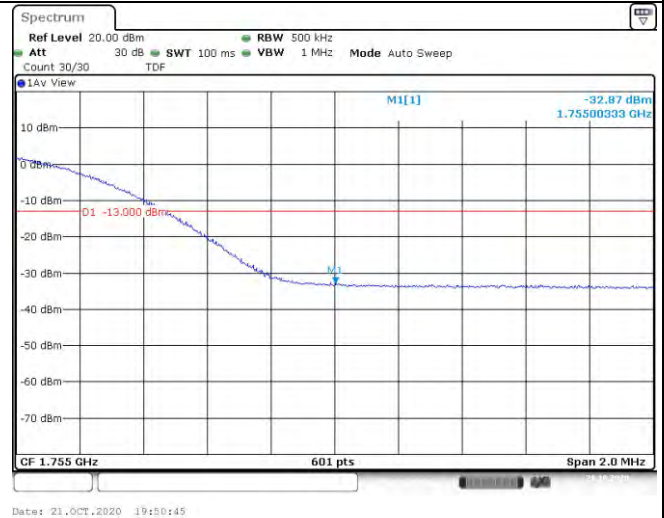

100RB#0

High Channel

3.5 Spurious Emission

LIMIT

According to §27.53 (h): For operations in the 1710–1755 MHz and 2110–2155 MHz bands, the power of any emission outside a licensee's frequency block shall be attenuated below the transmitter power (P) by at least $43 + 10 \log_{10}(P)$ dB.

TEST CONFIGURATION

Conducted Spurious Measurement:

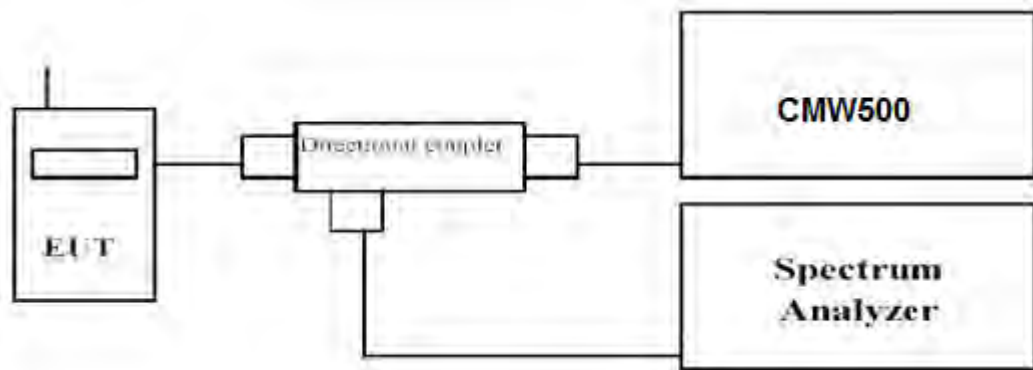

Radiated Spurious Measurement:

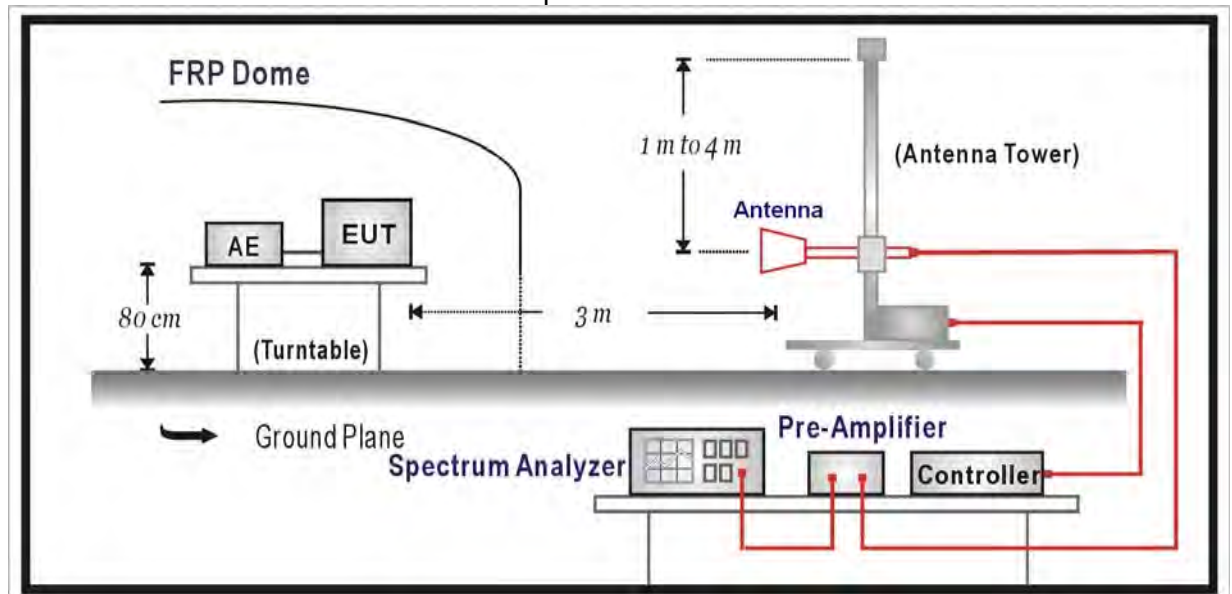

TEST PROCEDURE

The EUT was setup according to EIA/TIA 603D

Conducted Spurious Measurement:

- Place the EUT on a bench and set it in transmitting mode.
- Connect a low loss RF cable from the antenna port to a spectrum analyzer and CMW500 by a Directional Coupler.
- EUT Communicate with CMW500 then selects a channel for testing.
- Add a correction factor to the display of spectrum, and then test.
- The resolution bandwidth of the spectrum analyzer was set sufficient scans were taken to show the out of band Emission if any up to 10th harmonic.

Radiated Spurious Measurement:

- a. The EUT shall be placed at the specified height on a support, and in the position closest to normal use as declared by provider.
- b. The test antenna shall be oriented initially for vertical polarization and shall be chosen to correspond to the frequency of the transmitter
- c. The output of the test antenna shall be connected to the measuring receiver.
- d. The transmitter shall be switched on and the measuring receiver shall be tuned to the frequency of the transmitter under test.
- e. The test antenna shall be raised and lowered through the specified range of height until a maximum signal level is detected by the measuring receiver.
- f. The transmitter shall then be rotated through 360° in the horizontal plane, until the maximum signal level is detected by the measuring receiver.
- g. The test antenna shall be raised and lowered again through the specified range of height until a maximum signal level is detected by the measuring receiver.
- h. The maximum signal level detected by the measuring receiver shall be noted.
- i. The transmitter shall be replaced by a substitution antenna.
- j. The substitution antenna shall be orientated for vertical polarization and the length of the substitution antenna shall be adjusted to correspond to the frequency of the transmitter.
- k. The substitution antenna shall be connected to a calibrated signal generator.
- l. If necessary, the input attenuator setting of the measuring receiver shall be adjusted in order to increase the sensitivity of the measuring receiver.
- m. The test antenna shall be raised and lowered through the specified range of height to ensure that the maximum signal is received.
- n. The input signal to the substitution antenna shall be adjusted to the level that produces a level detected by the measuring receiver, that is equal to the level noted while the transmitter radiated power was measured, corrected for the change of input attenuator setting of the measuring receiver.
- o. The measurement shall be repeated with the test antenna and the substitution antenna orientated for horizontal polarization.
- p. The measure of the effective radiated power is the larger of the two levels recorded at the input to the substitution antenna, corrected for gain of the substitution antenna if necessary.
- q. The resolution bandwidth of the spectrum analyzer was set at 100 kHz for Part 22 and 1MHz for Part 24. The frequency range was checked up to 10th harmonic.
- r. Test site anechoic chamber refer to ANSI C63.

TEST RESULTS*Remark:*

1. *We were tested all RB Configuration refer 3GPP TS136 521 for each Channel Bandwidth of LTE FDD Band 4; recorded worst case for each Channel Bandwidth of LTE FDD Band 4.*

Conducted Measurement:

LTE FDD Band 4-1.4MHz Channel Bandwidth Low Channel 1RB#0

QPSK

16QAM

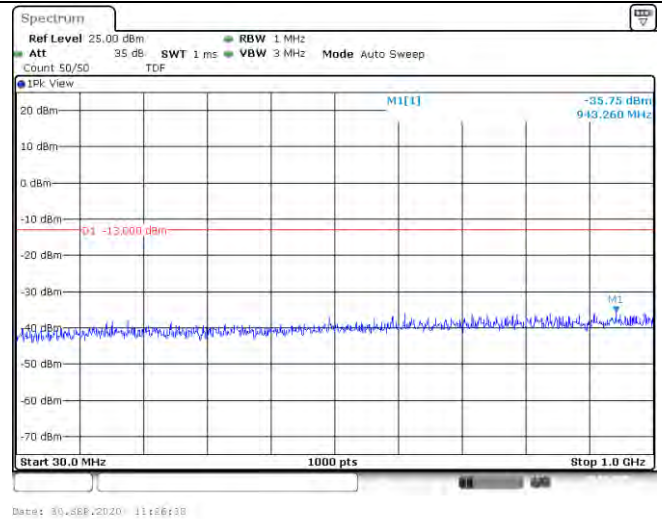
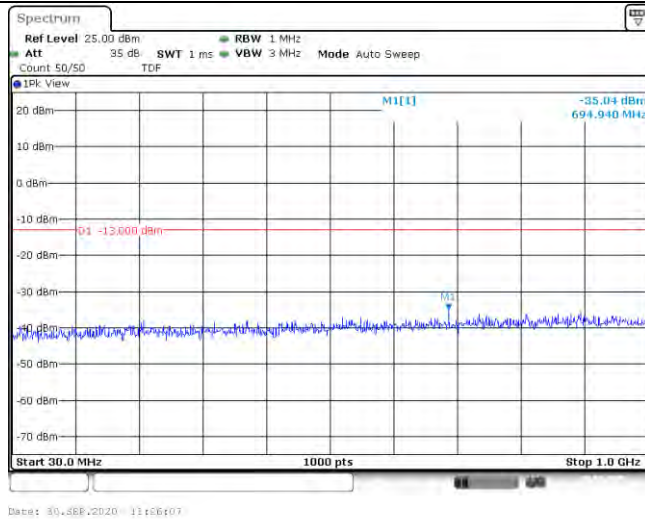

30MHz~1GHz

1GHz~2GHz

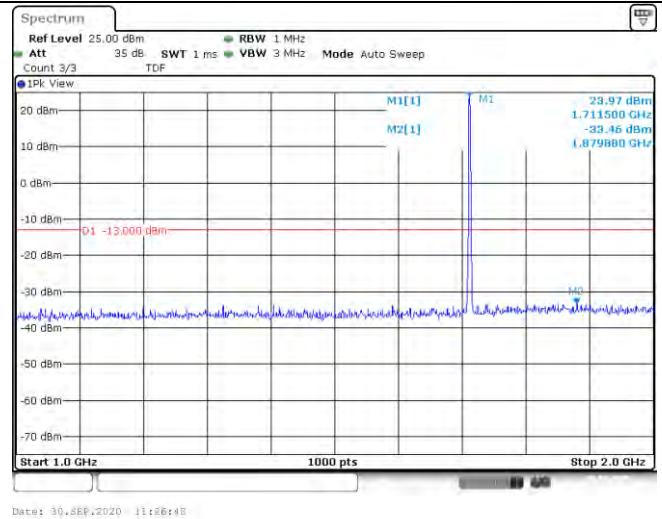
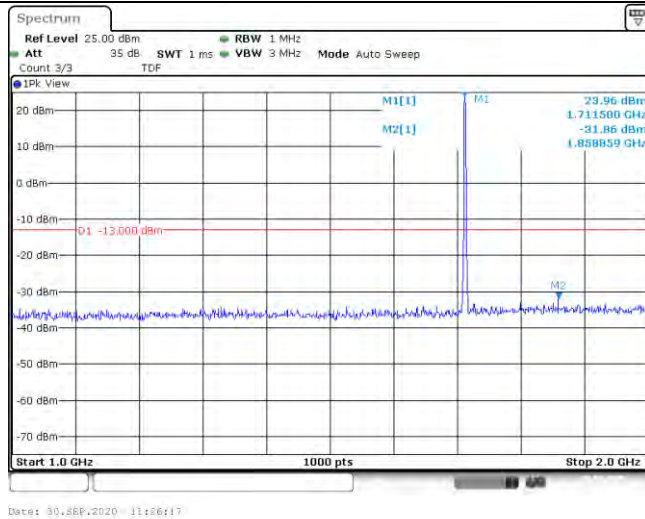

1GHz~2GHz

1GHz~2GHz

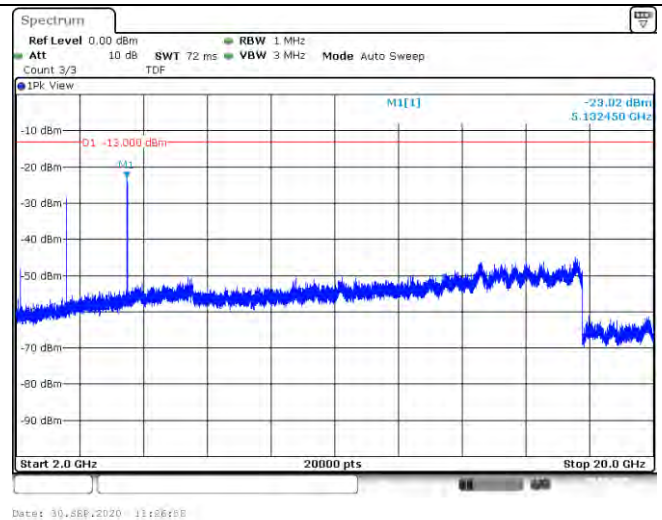
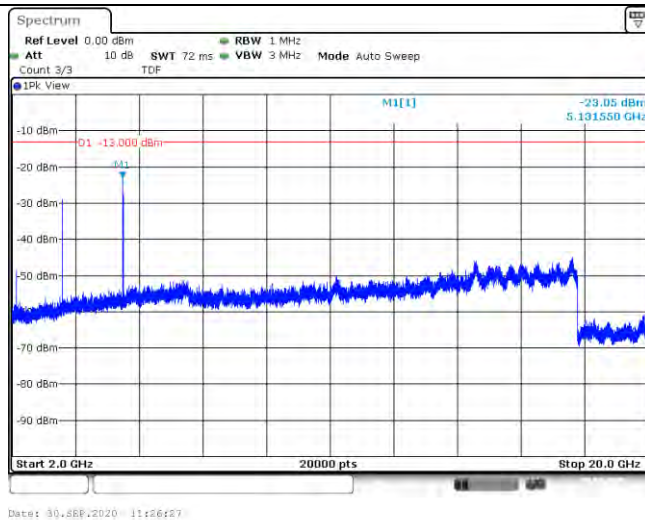

2GHz ~20GHz

2GHz ~20GHz

LTE FDD Band 4-1.4MHz Channel Bandwidth Middle Channel 1RB#0

QPSK

16QAM

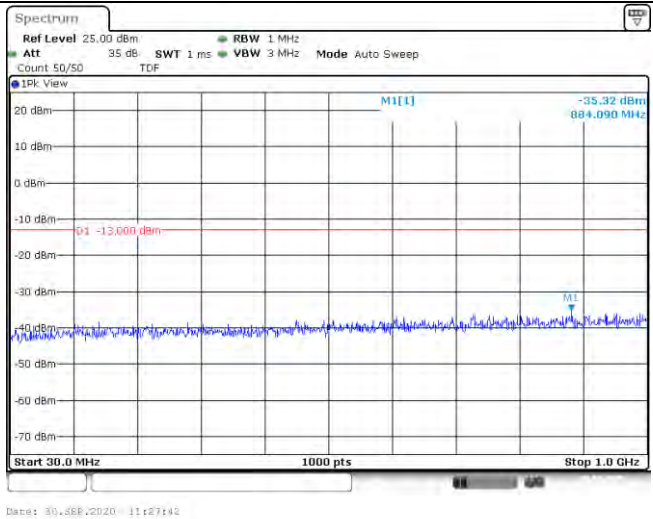
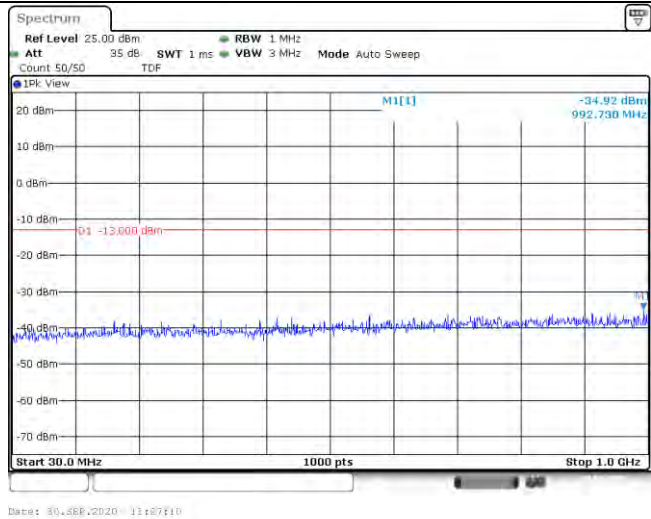

30MHz~1GHz

1GHz~2GHz

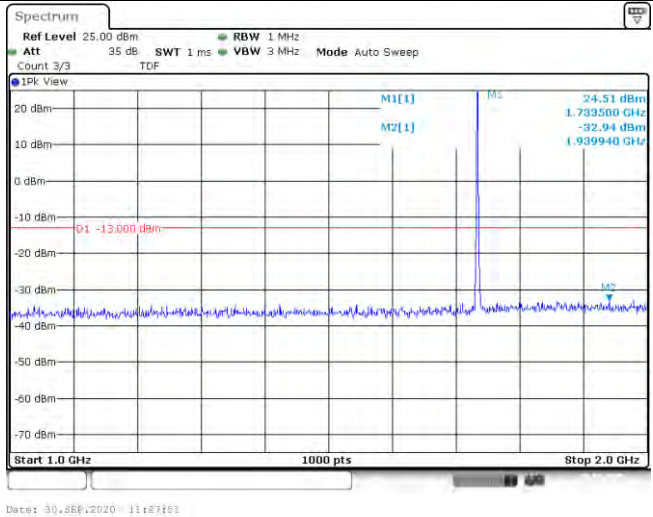
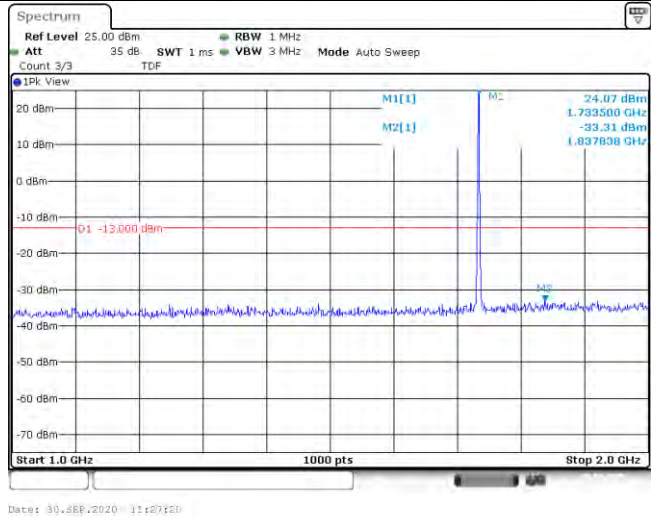

1GHz~2GHz

1GHz~2GHz

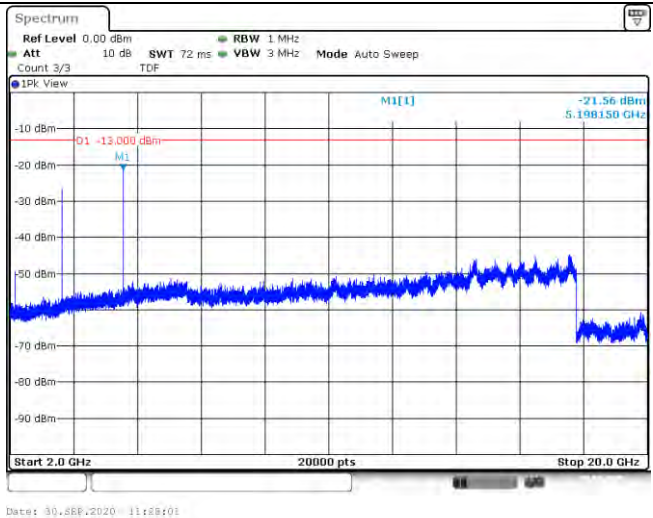
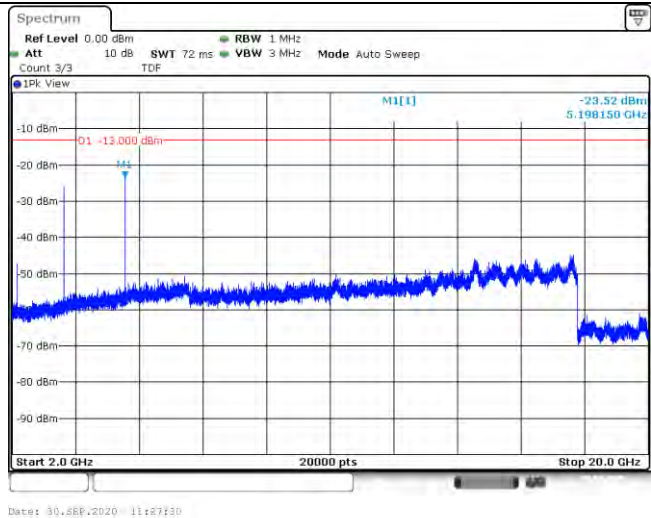

2GHz ~20GHz

2GHz ~20GHz

LTE FDD Band 4-1.4MHz Channel Bandwidth High Channel 1RB#0

QPSK

16QAM

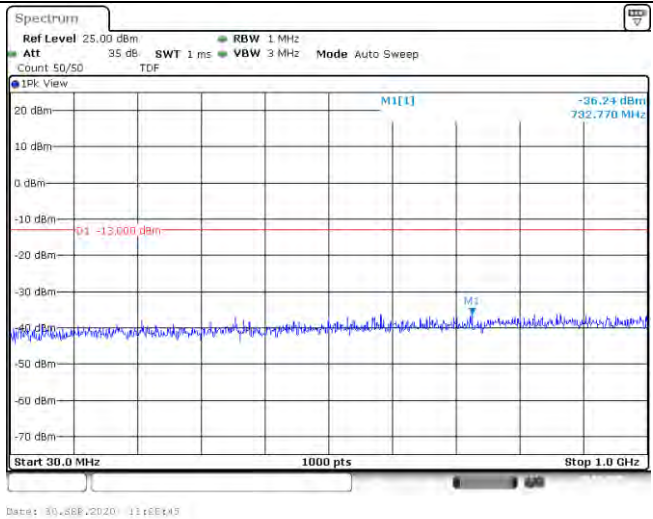
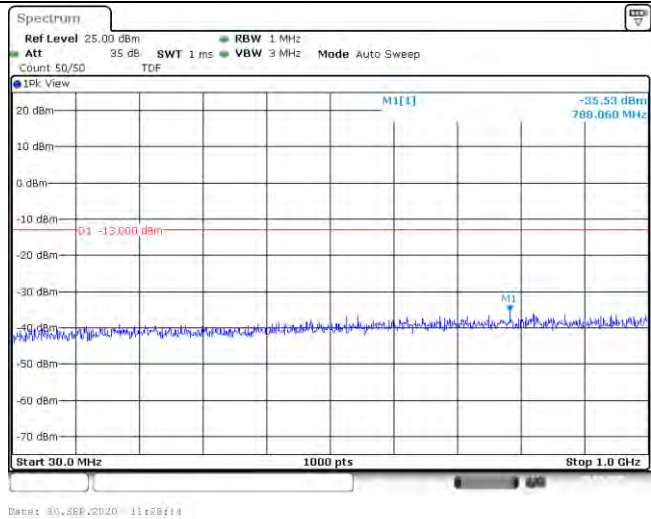

30MHz~1GHz

1GHz~2GHz

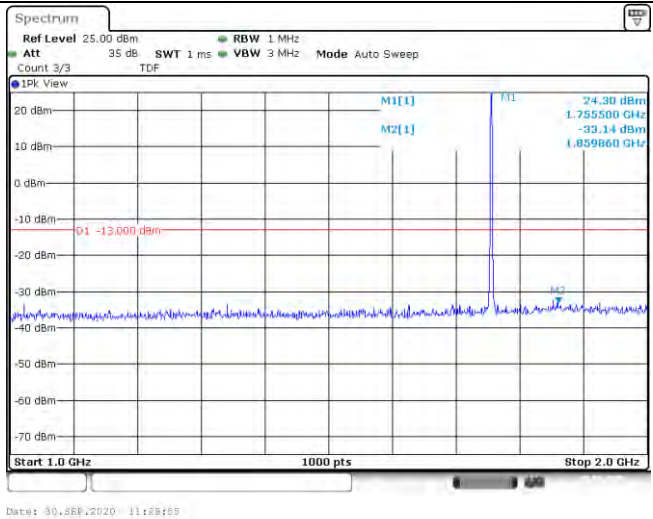
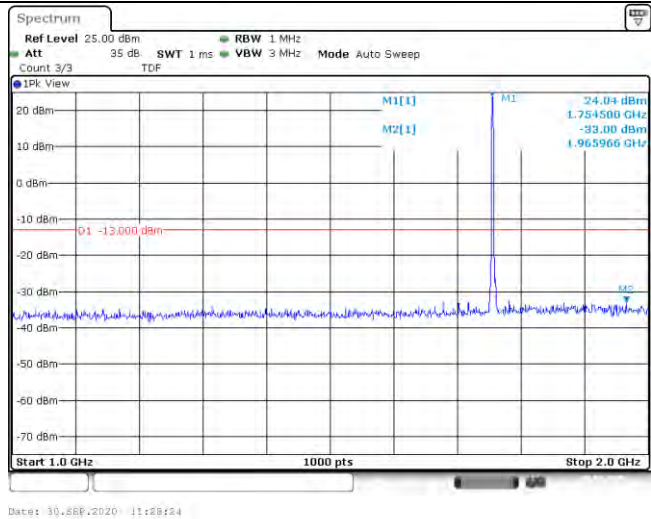

1GHz~2GHz

1GHz~2GHz

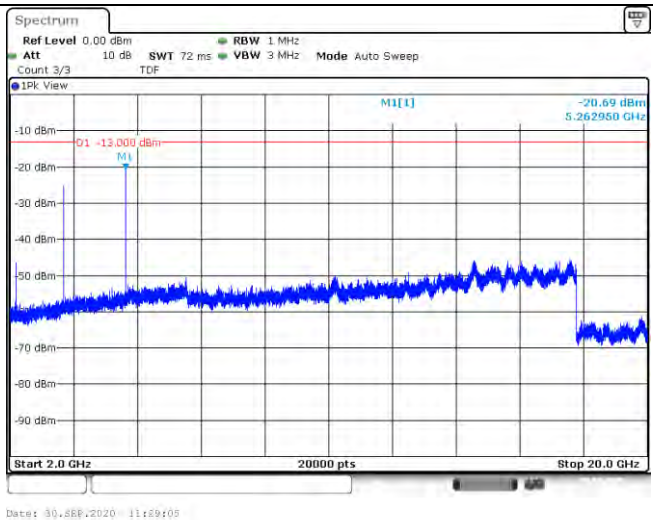
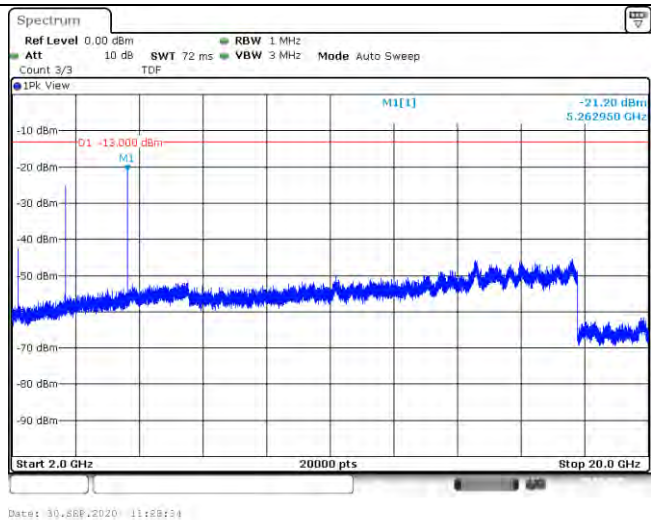

2GHz ~20GHz

2GHz ~20GHz

LTE FDD Band 4-3MHz Channel Bandwidth Low Channel 1RB#0

QPSK

16QAM

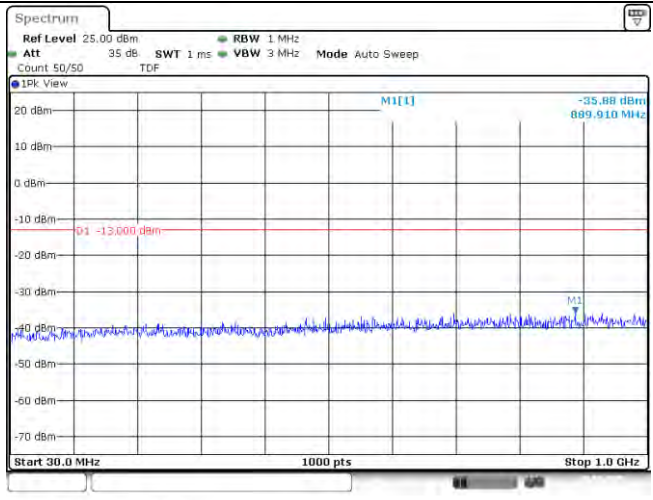
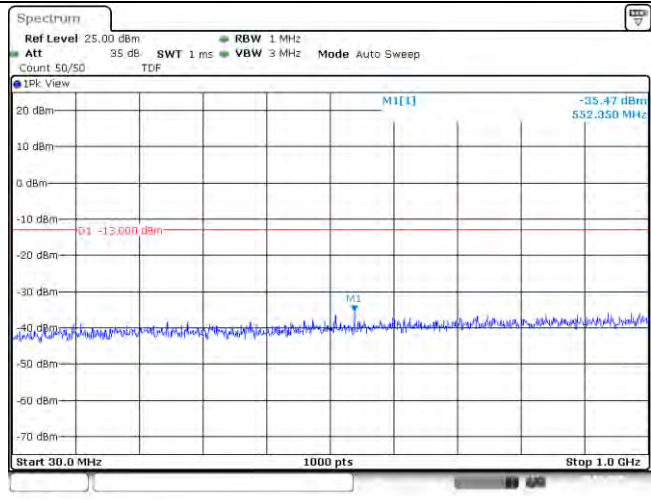

30MHz~1GHz

1GHz~2GHz

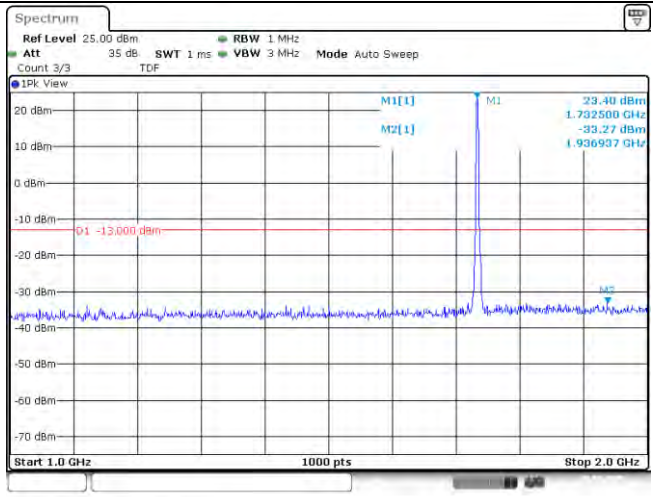
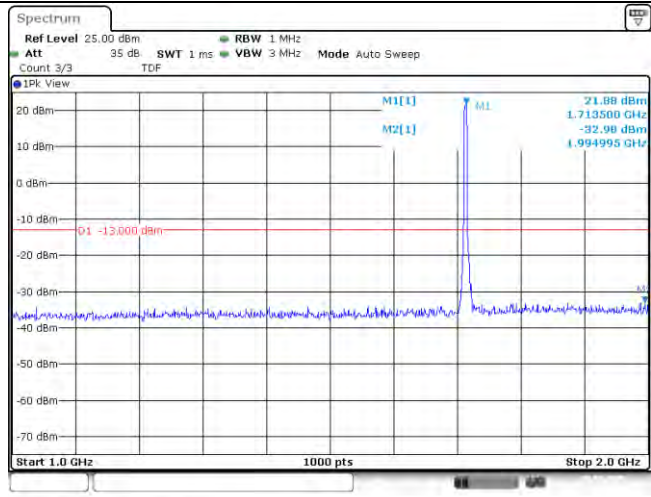

1GHz~2GHz

1GHz~2GHz

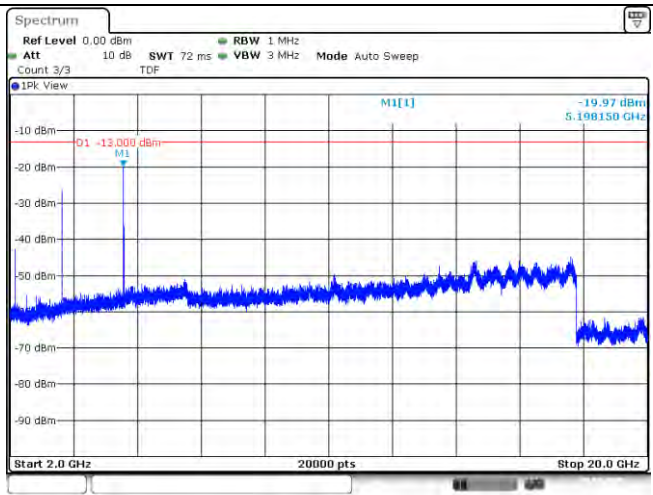
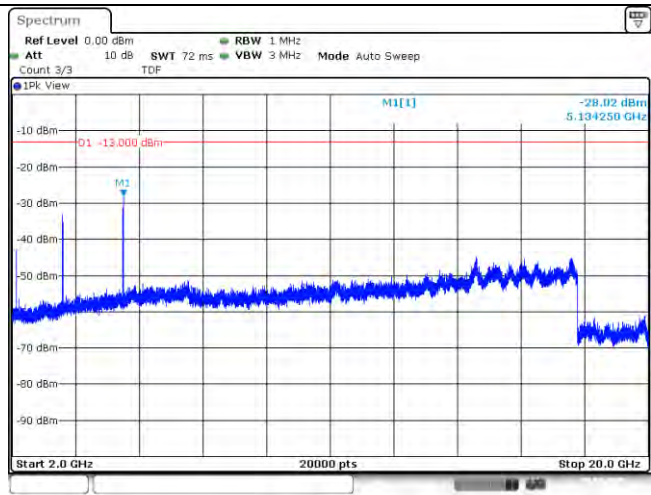

2GHz ~20GHz

2GHz ~20GHz

LTE FDD Band 4-3MHz Channel Bandwidth Middle Channel 1RB#0

QPSK

16QAM

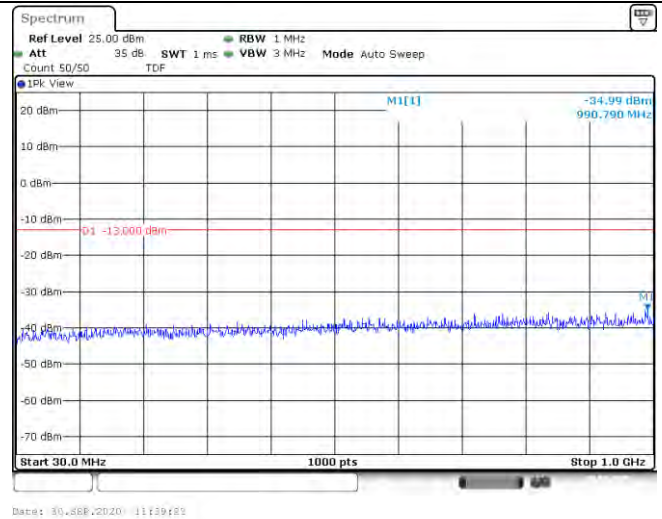
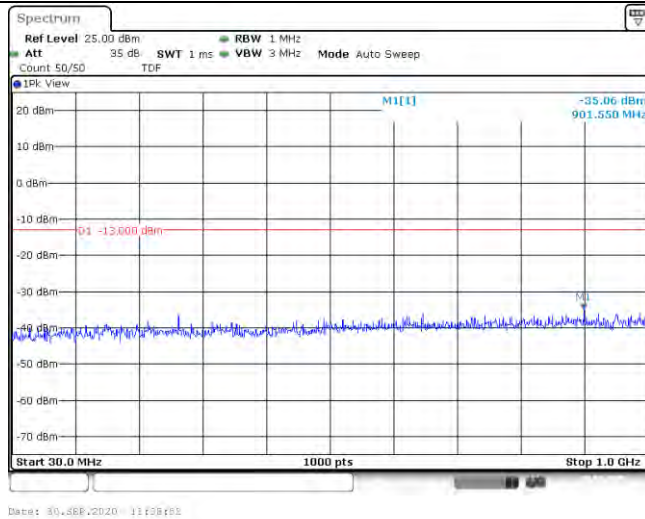

30MHz~1GHz

1GHz~2GHz

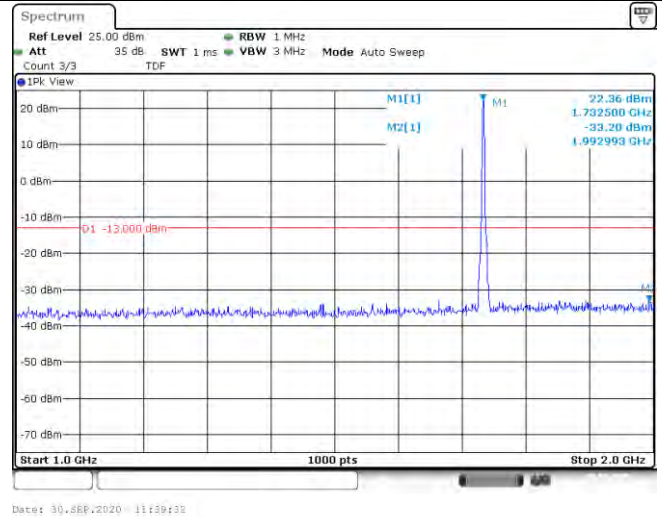
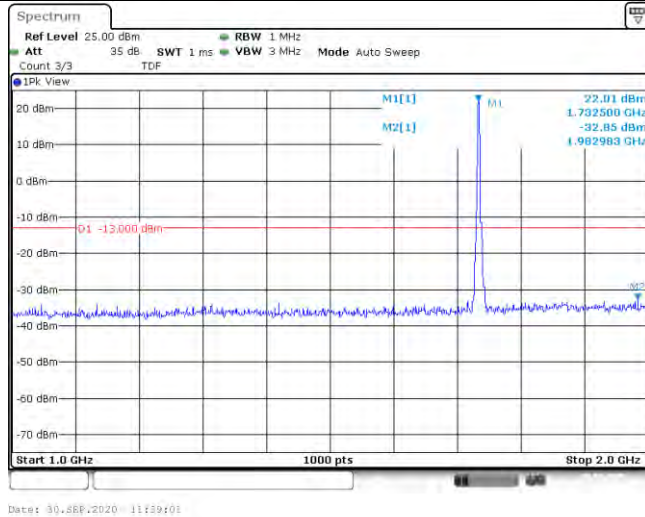

1GHz~2GHz

1GHz~2GHz

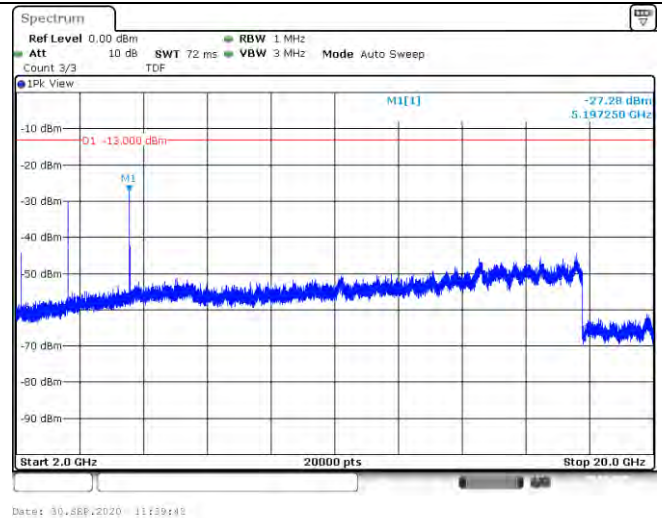
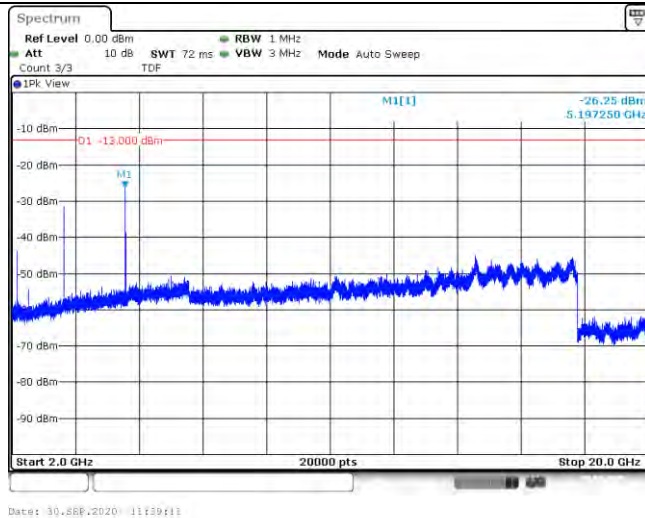

2GHz ~20GHz

2GHz ~20GHz

LTE FDD Band 4-3MHz Channel Bandwidth High Channel 1RB#0

QPSK

16QAM

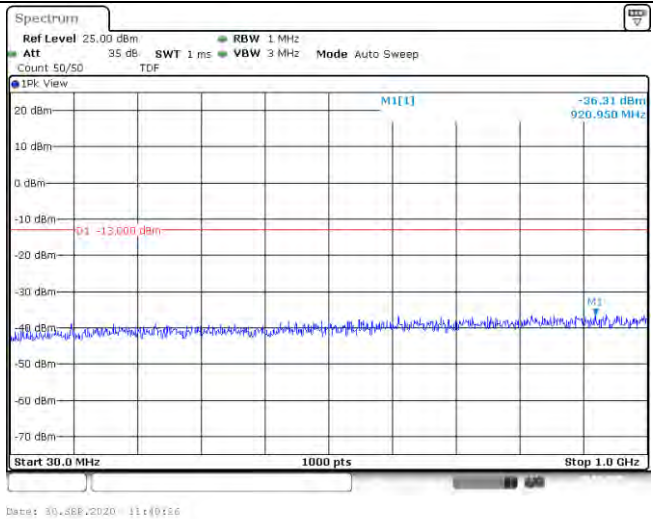
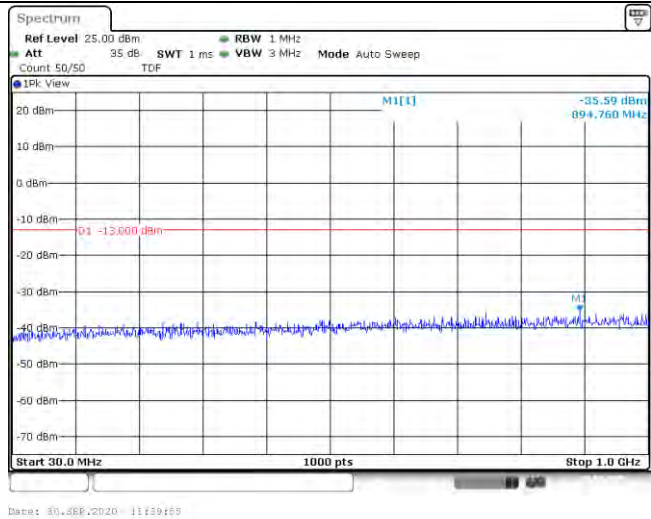

30MHz~1GHz

1GHz~2GHz

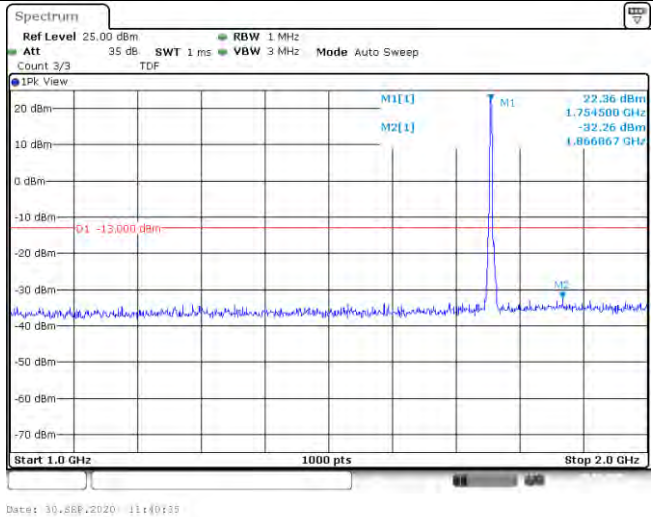
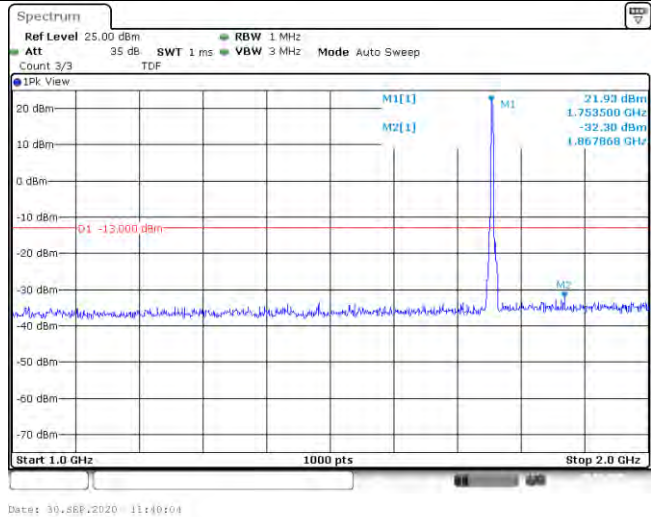

1GHz~2GHz

1GHz~2GHz

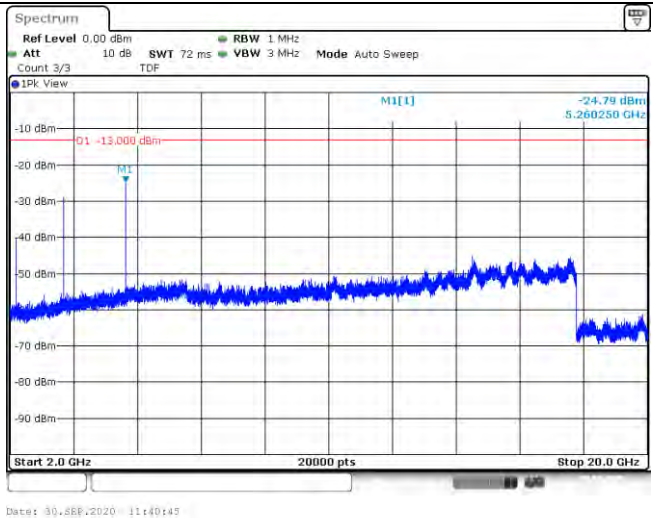
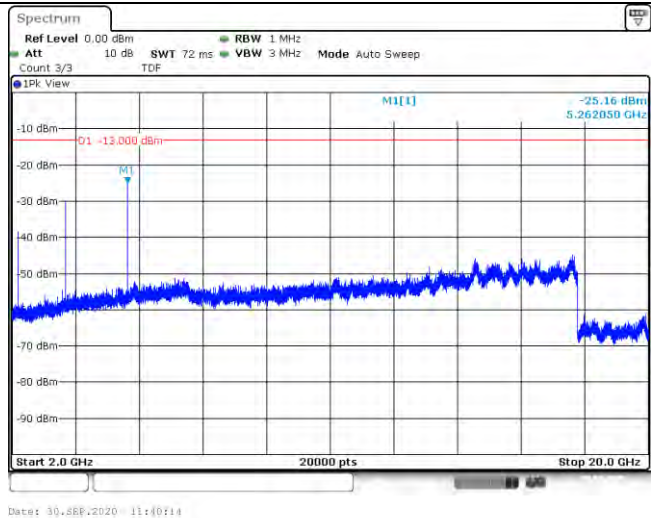

2GHz ~20GHz

2GHz ~20GHz

LTE FDD Band 4-5MHz Channel Bandwidth Low Channel 1RB#0

QPSK

16QAM

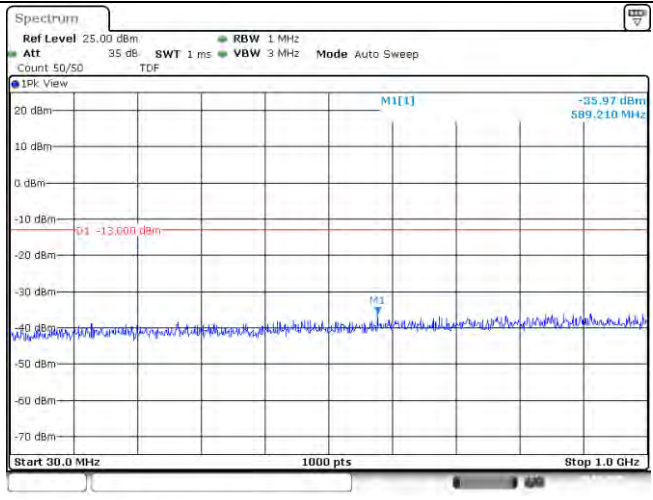
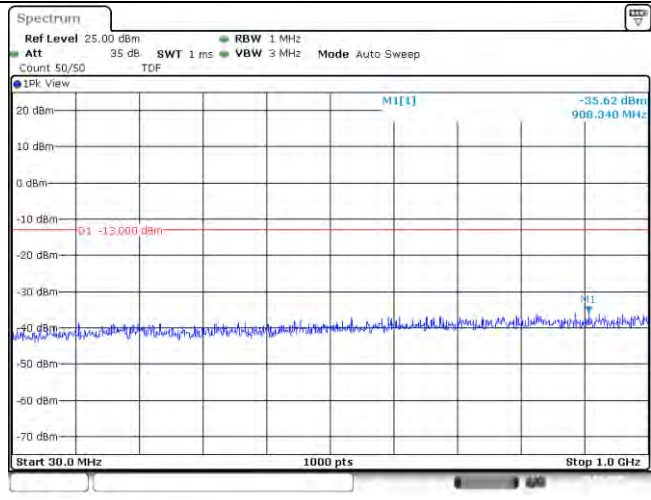

Date: 30.SEP.2020 11:28:19

Date: 30.SEP.2020 11:49:40

30MHz~1GHz

1GHz~2GHz

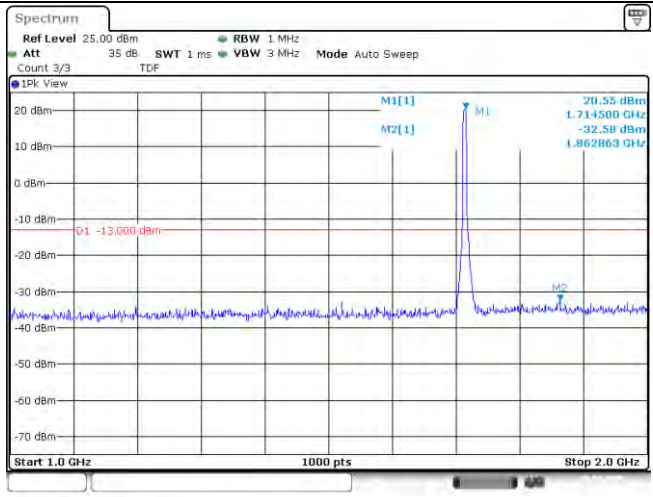
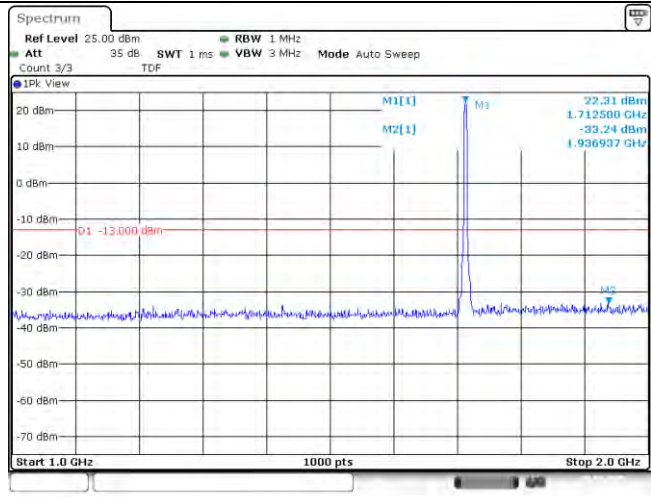

Date: 30.SEP.2020 11:28:29

Date: 30.SEP.2020 11:49:49

1GHz~2GHz

1GHz~2GHz

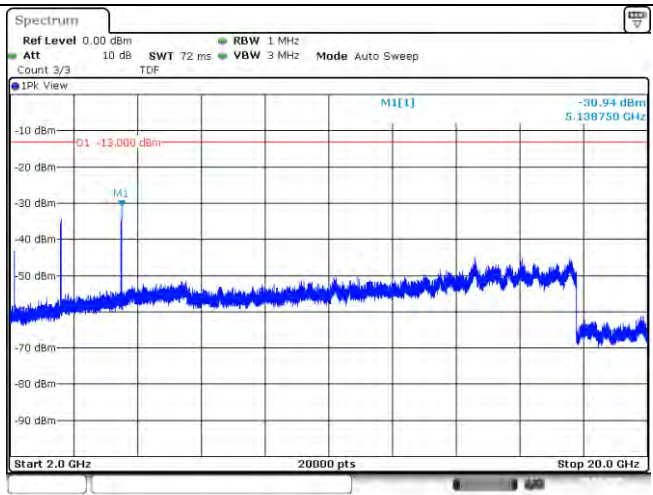
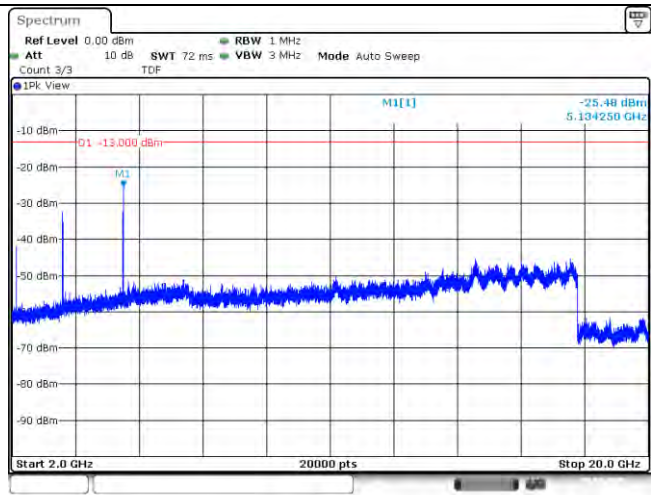

Date: 30.SEP.2020 11:28:39

Date: 30.SEP.2020 11:49:59

2GHz ~20GHz

2GHz ~20GHz

LTE FDD Band 4-5MHz Channel Bandwidth Middle Channel 1RB#0

QPSK

16QAM

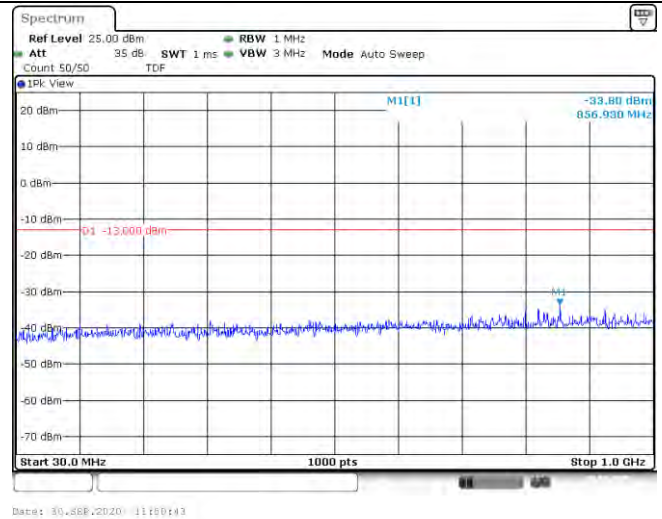
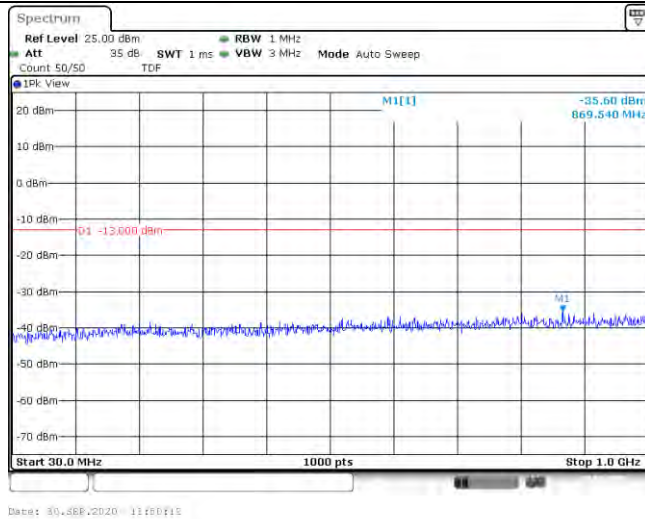

30MHz~1GHz

1GHz~2GHz

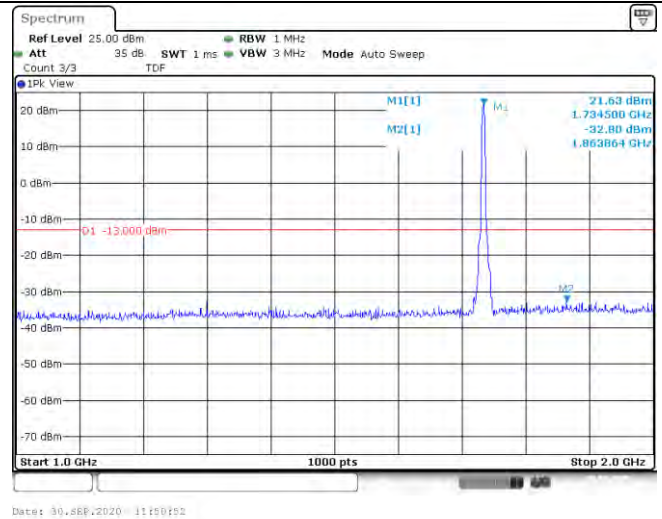
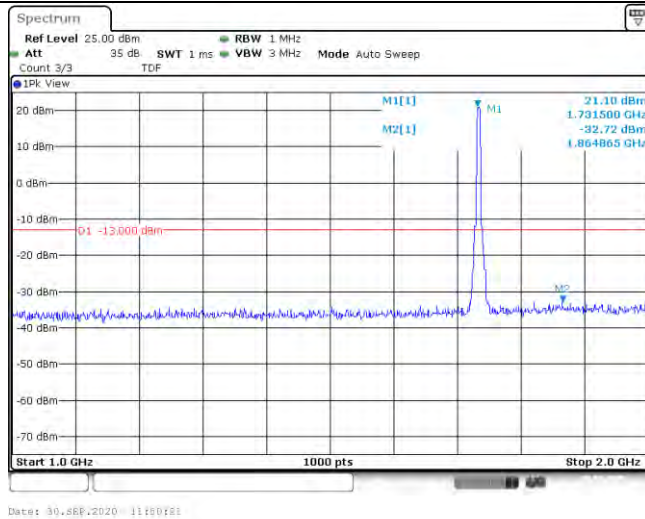

1GHz~2GHz

1GHz~2GHz

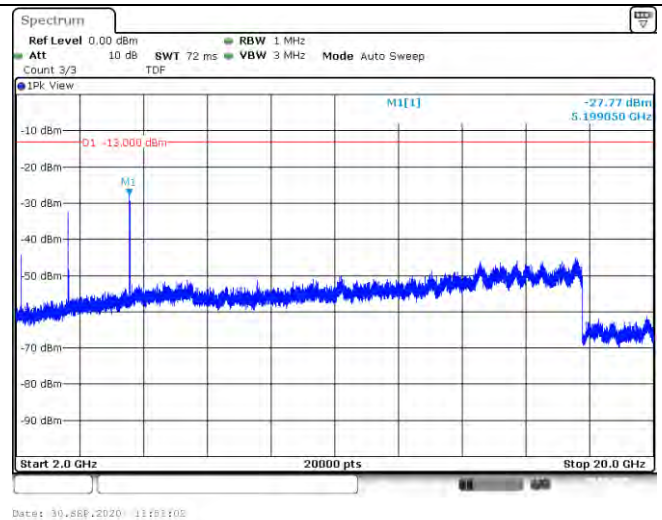
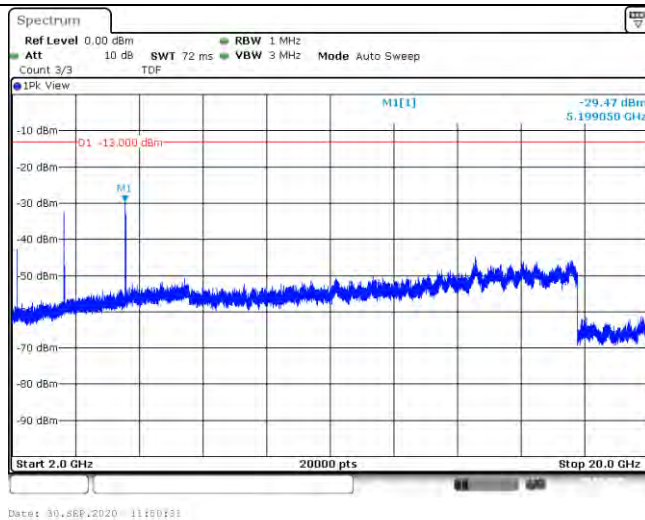

2GHz ~20GHz

2GHz ~20GHz

LTE FDD Band 4-5MHz Channel Bandwidth High Channel 1RB#0

QPSK

16QAM

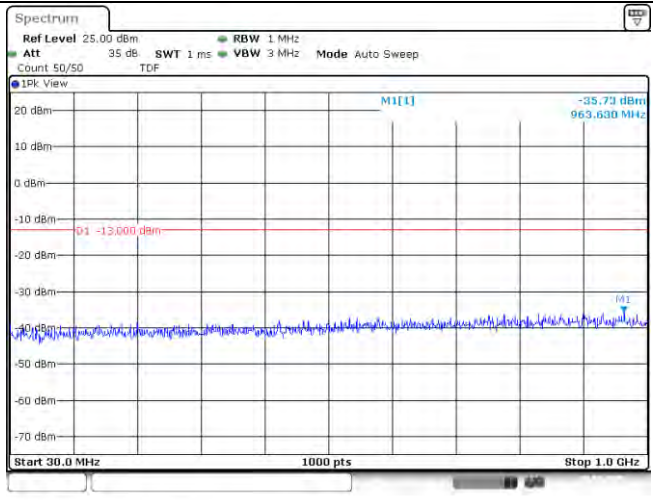
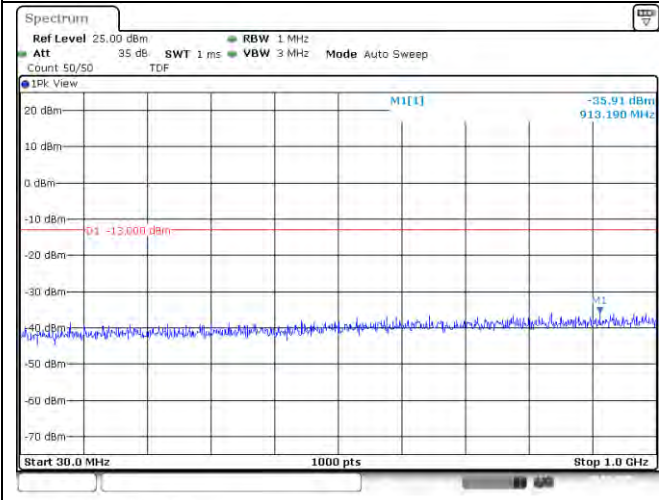

Date: 30.SEP.2020 11:53:16

Date: 30.SEP.2020 11:53:47

30MHz~1GHz

1GHz~2GHz

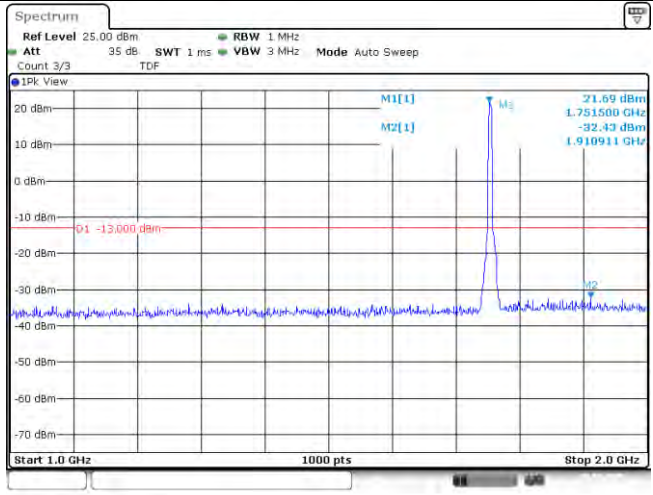
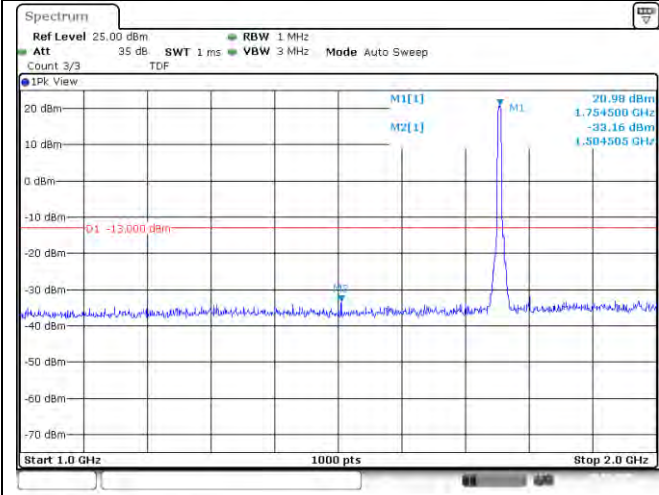

Date: 30.SEP.2020 11:53:59

Date: 30.SEP.2020 11:53:56

1GHz~2GHz

1GHz~2GHz

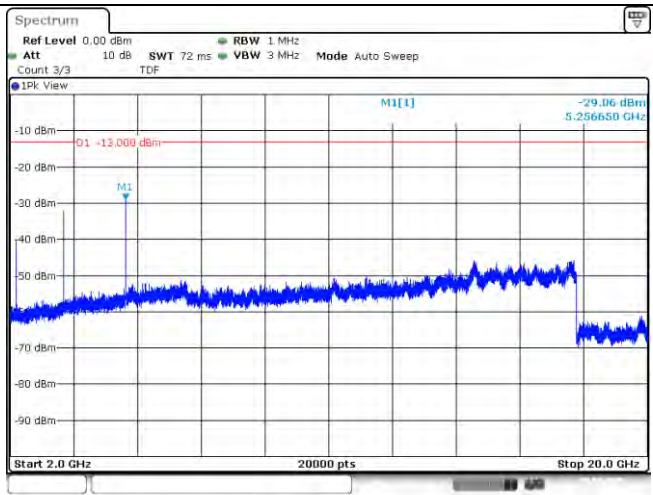
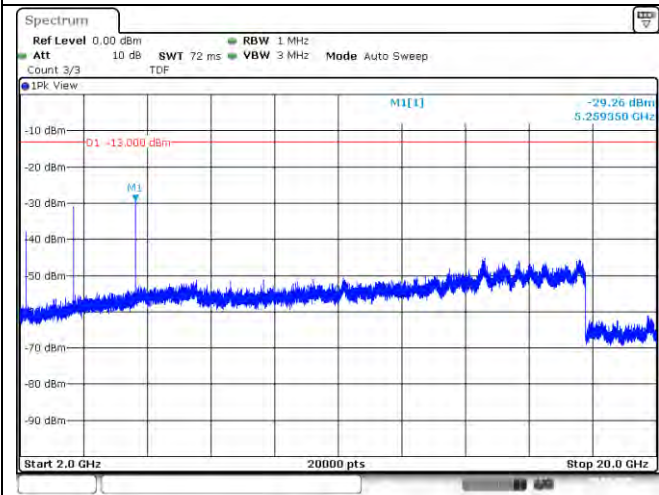

Date: 30.SEP.2020 11:53:05

Date: 30.SEP.2020 11:53:06

2GHz ~20GHz

2GHz ~20GHz

LTE FDD Band 4-10MHz Channel Bandwidth Low Channel 1RB#0

QPSK

16QAM

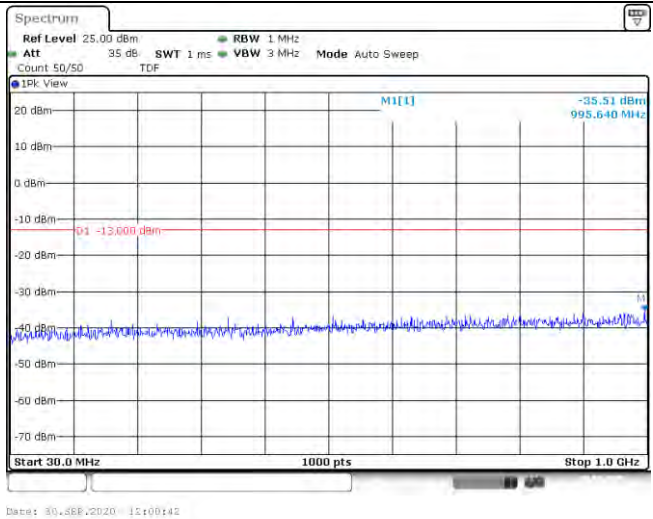
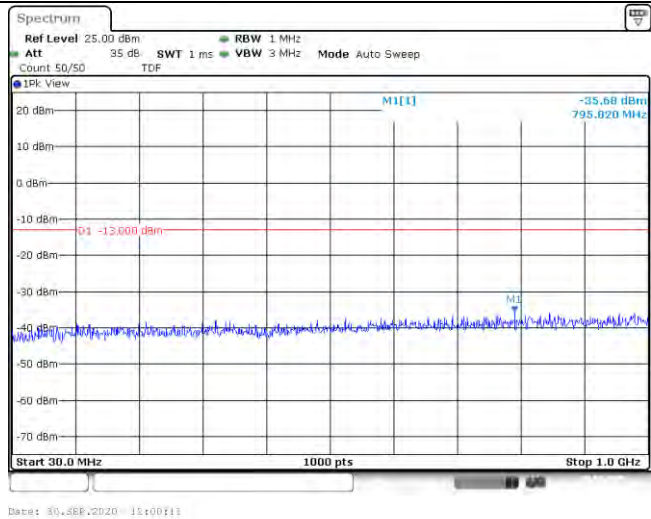

30MHz~1GHz

1GHz~2GHz

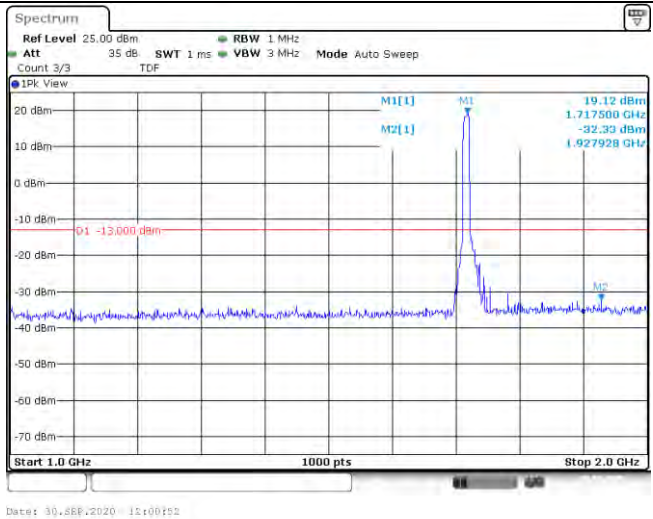
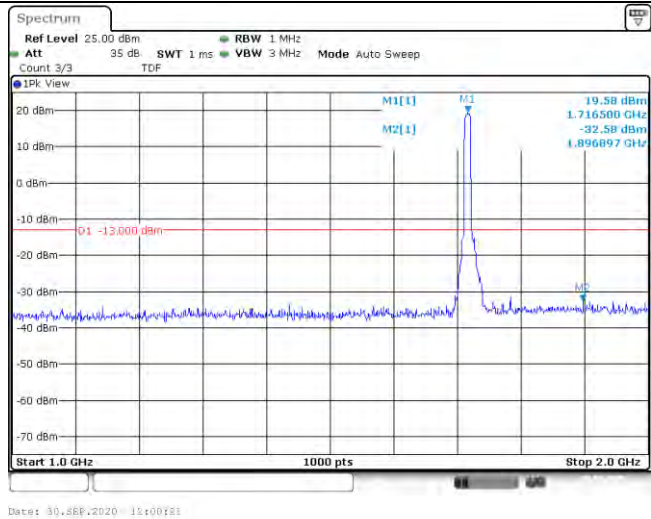

1GHz~2GHz

1GHz~2GHz

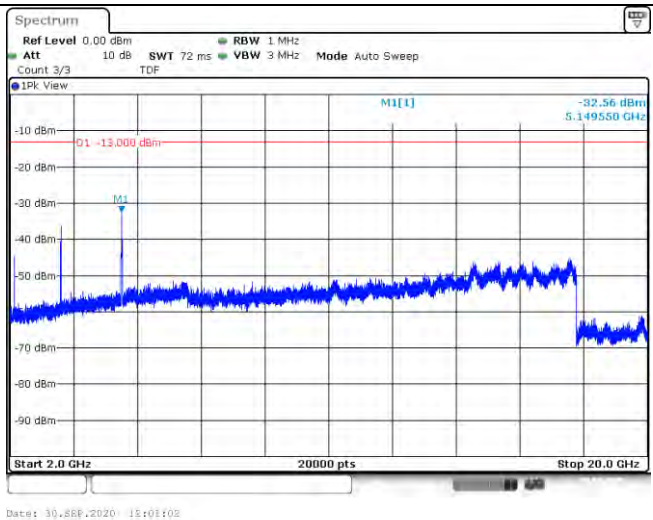
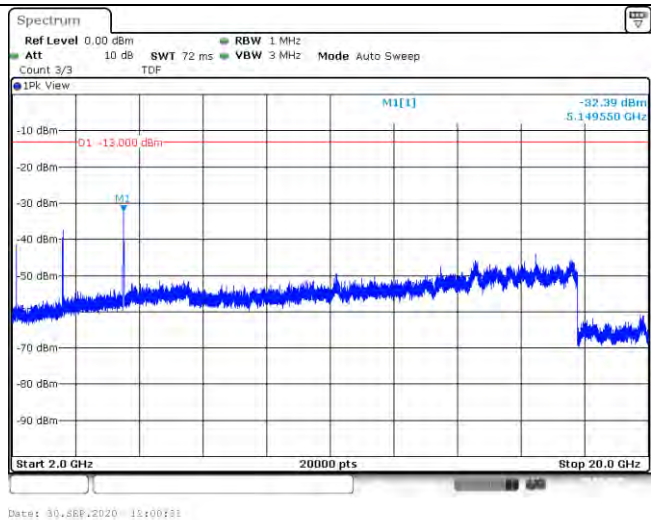

2GHz ~20GHz

2GHz ~20GHz

LTE FDD Band 4-10MHz Channel Bandwidth Middle Channel 1RB#0

QPSK

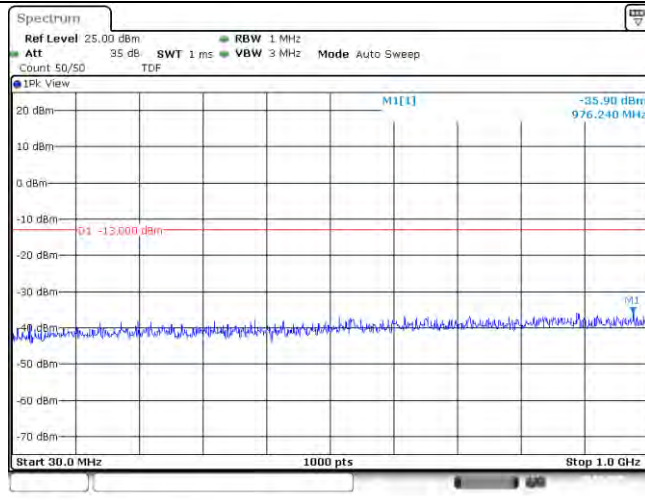

16QAM

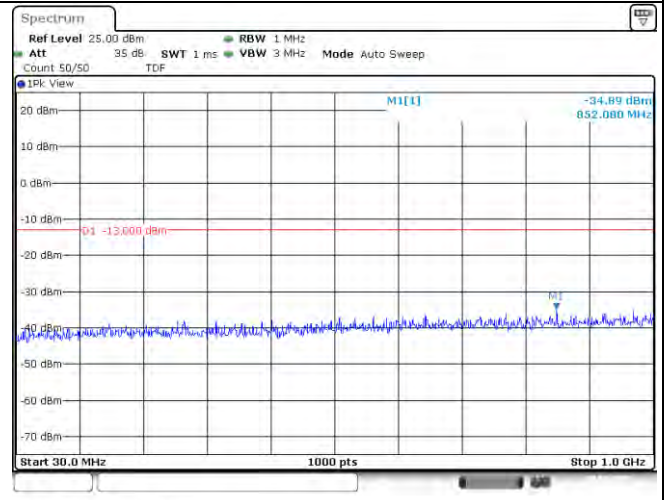

30MHz~1GHz

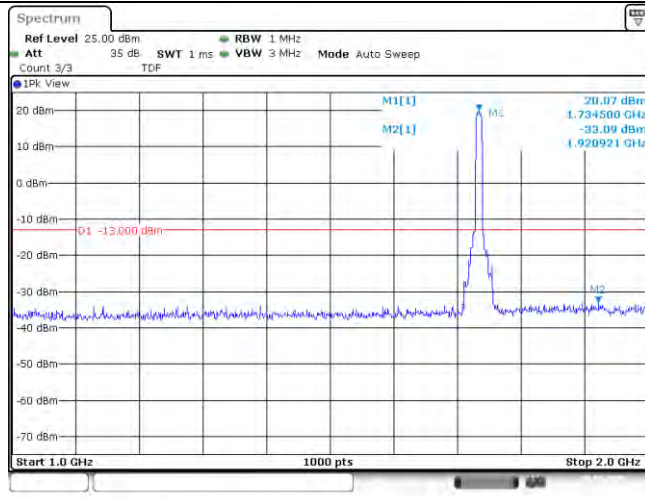

1GHz~2GHz

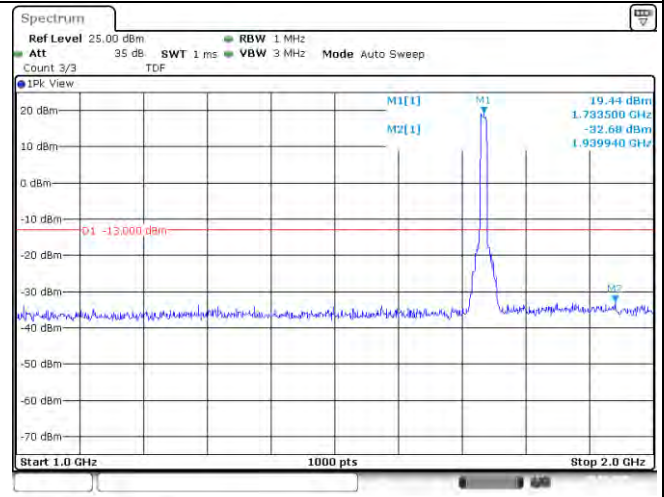

1GHz~2GHz

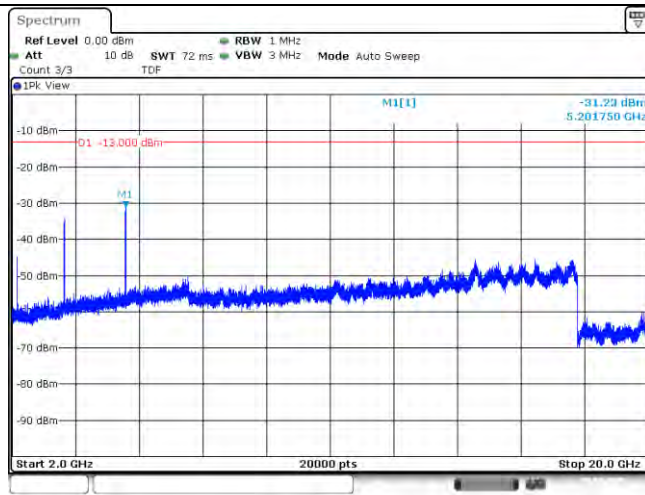

1GHz~2GHz

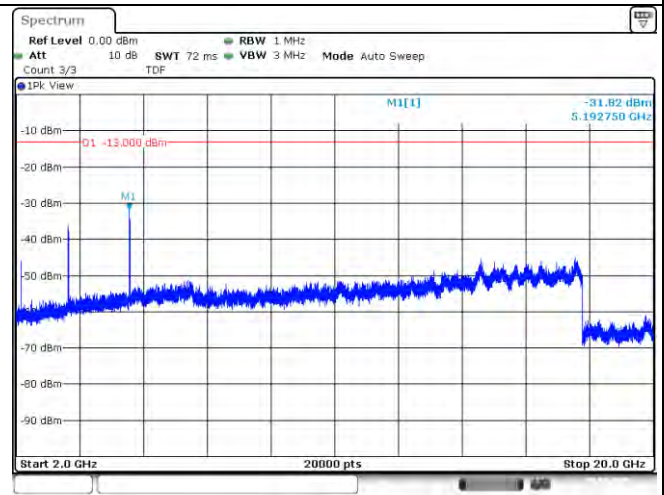

2GHz ~20GHz

2GHz ~20GHz

LTE FDD Band 4-10MHz Channel Bandwidth High Channel 1RB#0

QPSK

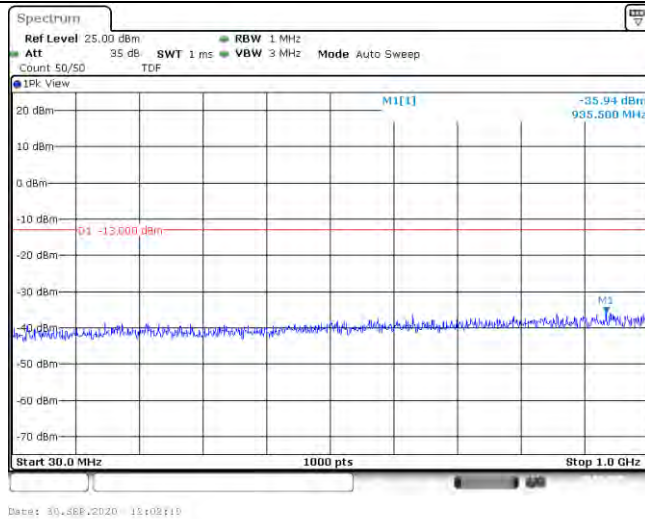

16QAM

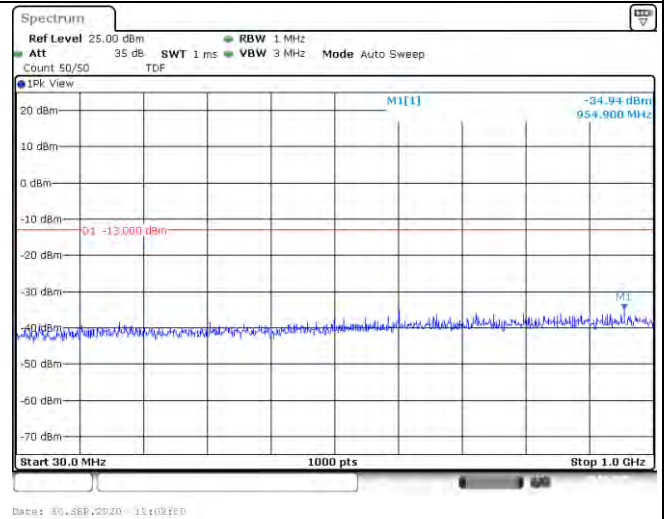

30MHz~1GHz

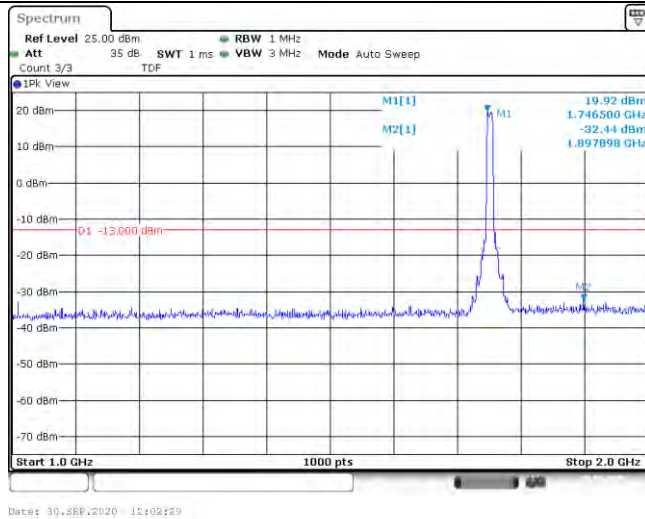

1GHz~2GHz

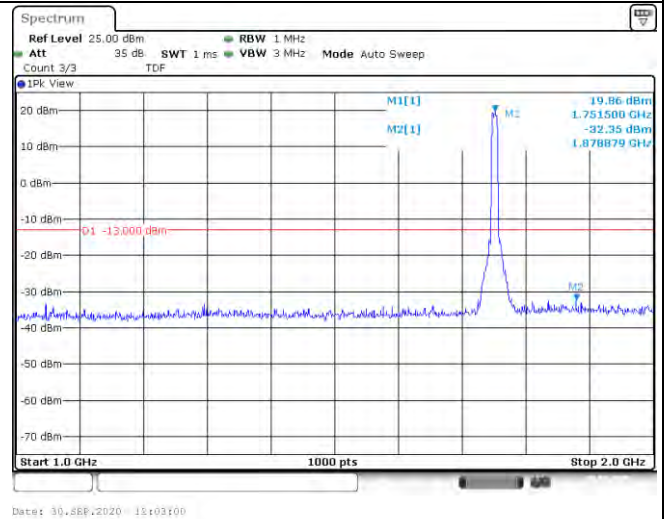

1GHz~2GHz

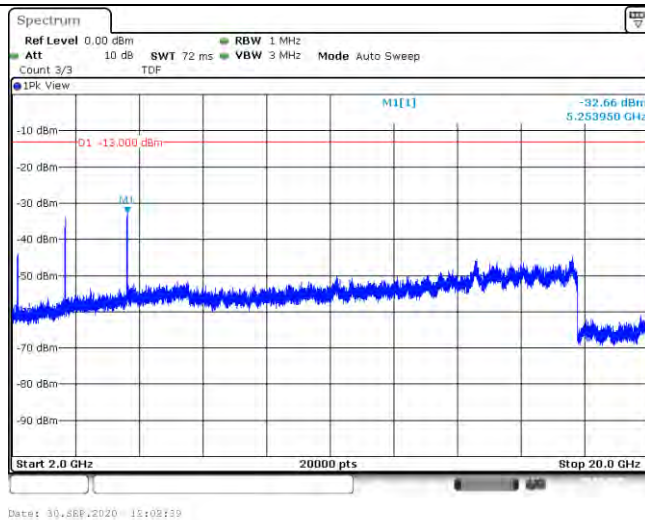

1GHz~2GHz

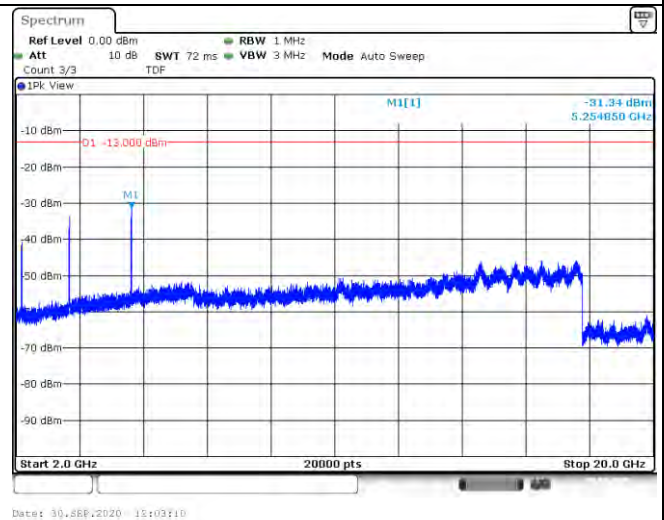

2GHz ~20GHz

2GHz ~20GHz

LTE FDD Band 4-15MHz Channel Bandwidth Low Channel 1RB#0

QPSK

16QAM

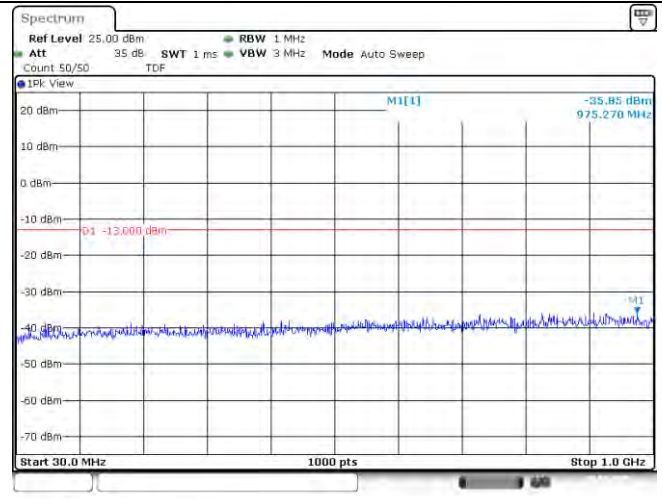
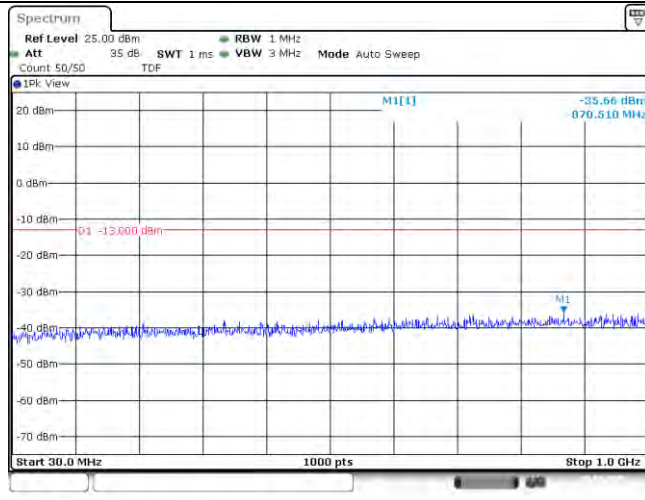

30MHz~1GHz

1GHz~2GHz

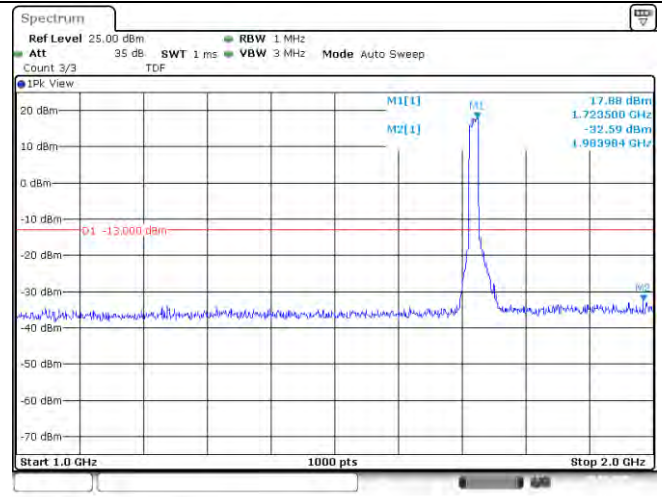
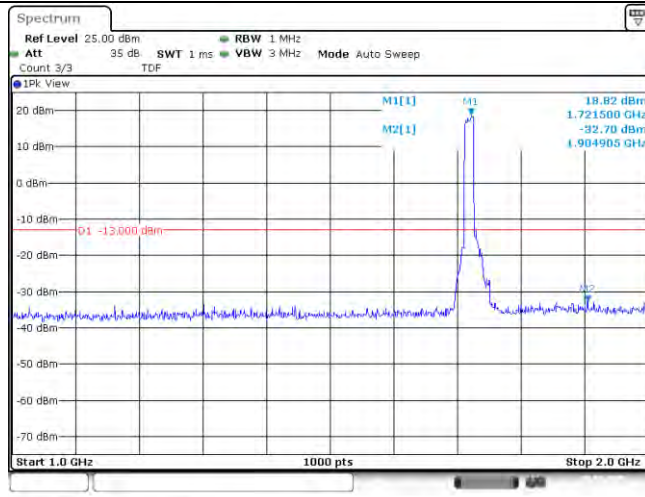

1GHz~2GHz

1GHz~2GHz

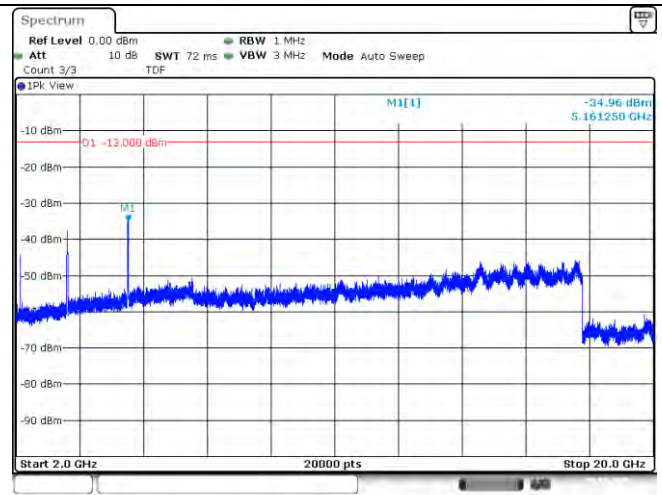
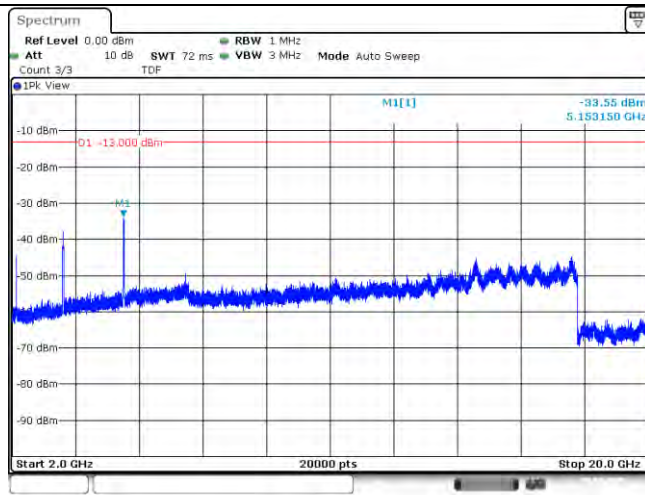

2GHz ~20GHz

2GHz ~20GHz

LTE FDD Band 4-15MHz Channel Bandwidth Middle Channel 1RB#0

QPSK

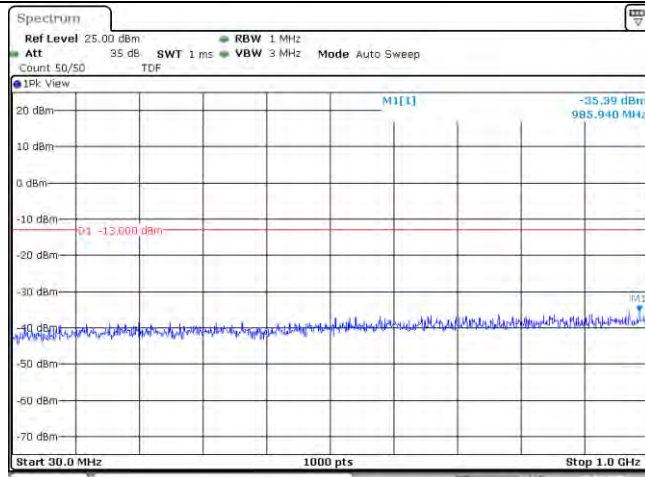

Date: 30.SEP.2020 13:13:10

16QAM

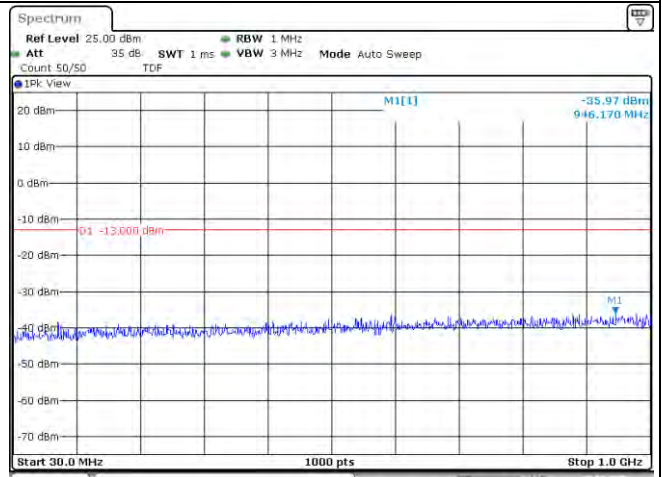

Date: 30.SEP.2020 13:13:10

30MHz~1GHz

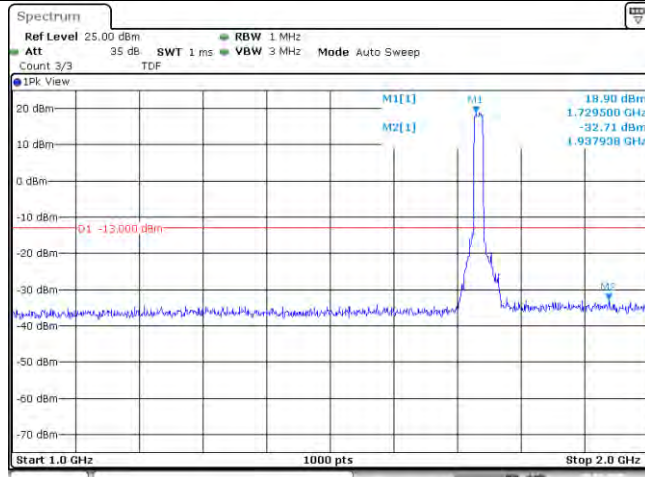

Date: 30.SEP.2020 13:13:19

1GHz~2GHz

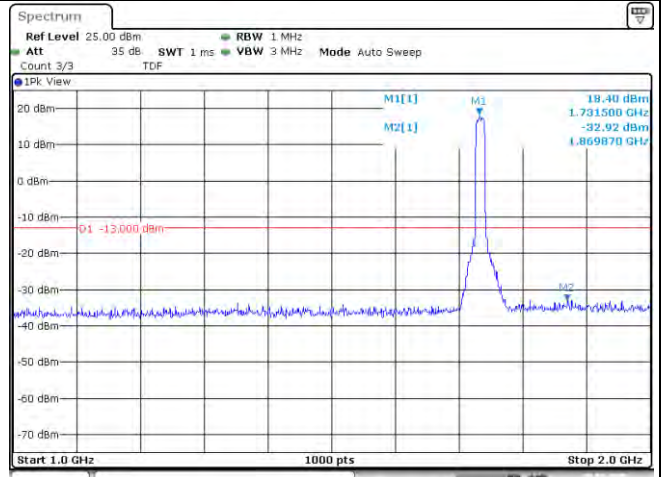

Date: 30.SEP.2020 13:13:00

1GHz~2GHz

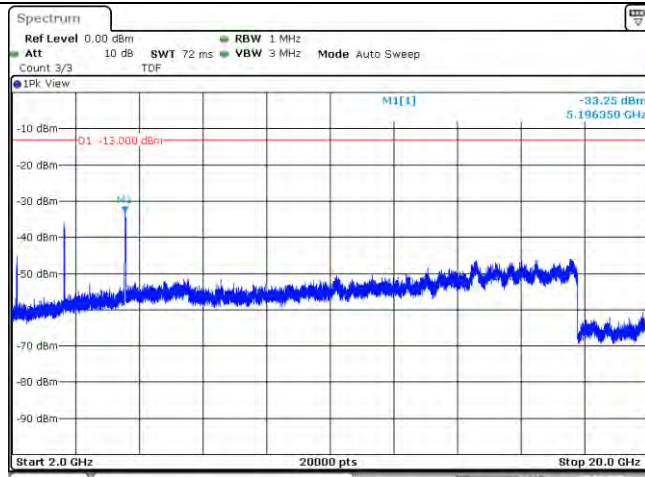

Date: 30.SEP.2020 13:13:19

1GHz~2GHz

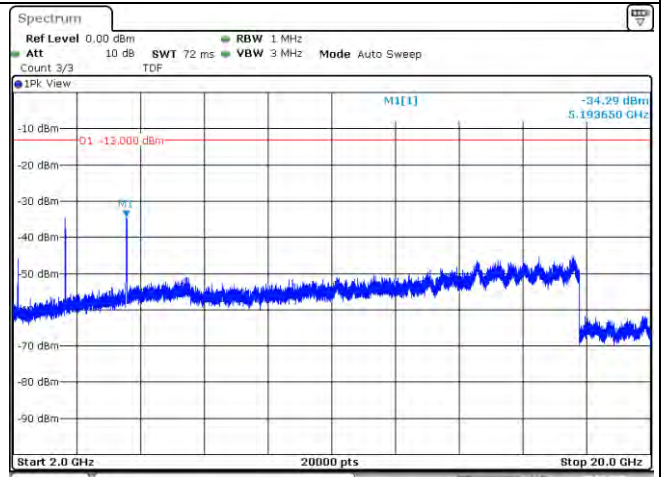

Date: 30.SEP.2020 13:13:10

2GHz ~20GHz

2GHz ~20GHz

LTE FDD Band 4-15MHz Channel Bandwidth High Channel 1RB#0

QPSK

16QAM

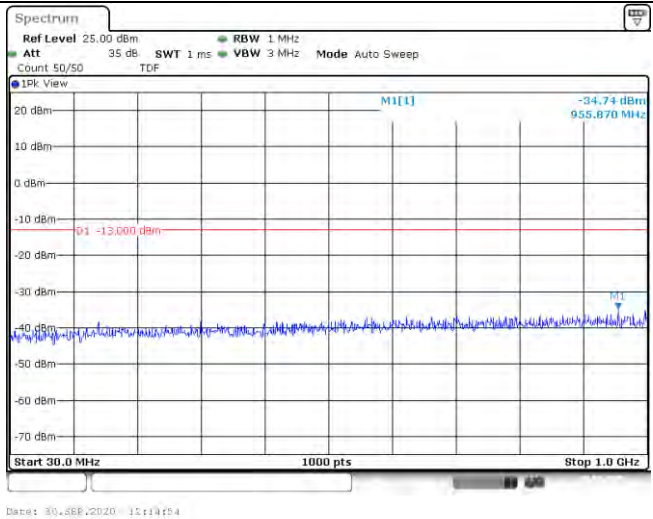
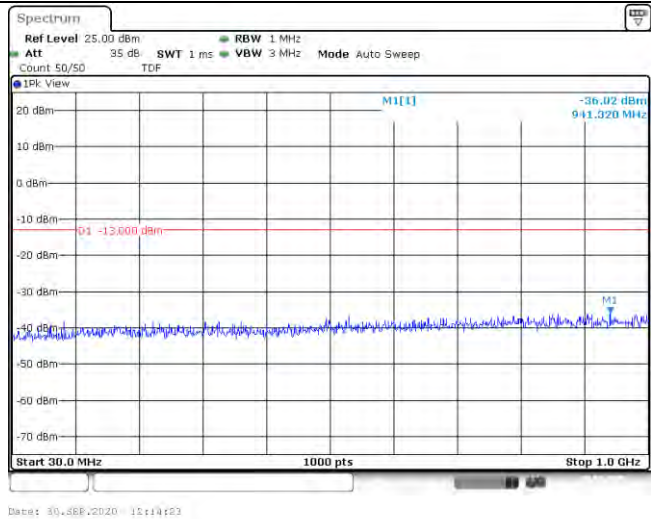

30MHz~1GHz

1GHz~2GHz

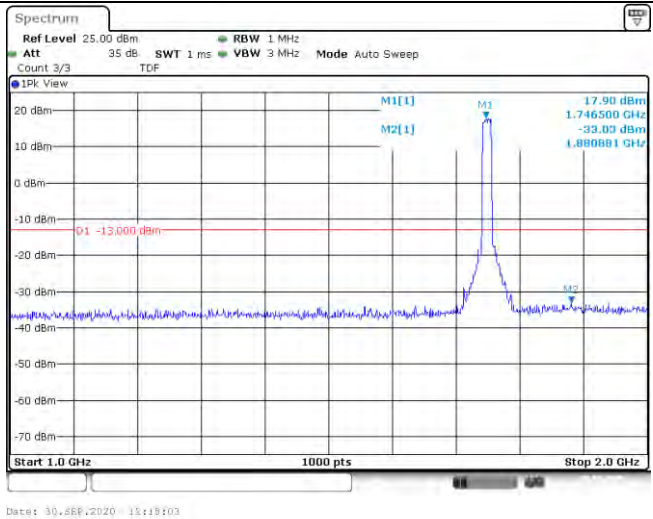
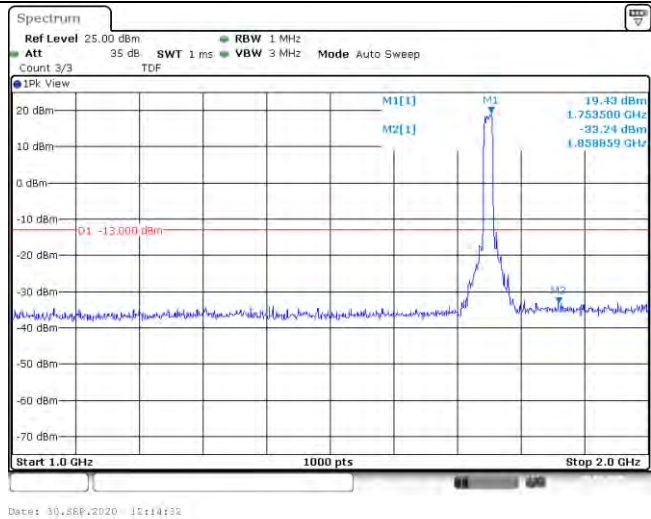

1GHz~2GHz

1GHz~2GHz

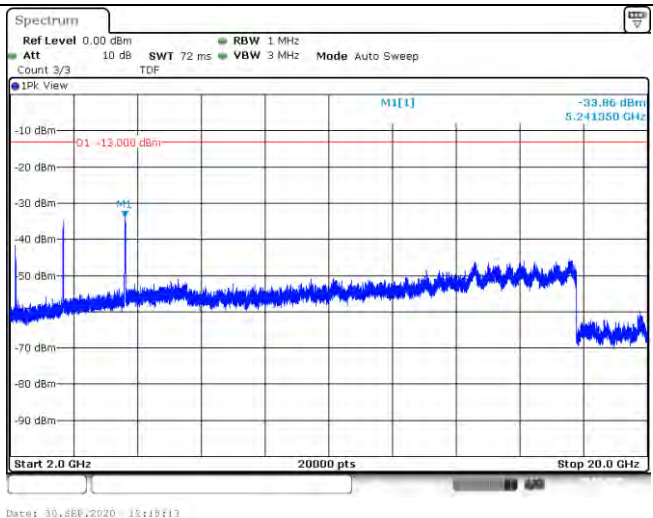
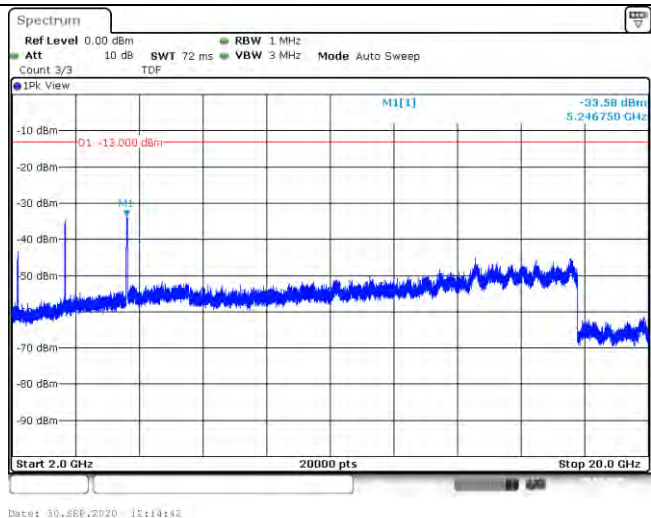

2GHz ~20GHz

2GHz ~20GHz

LTE FDD Band 4-20MHz Channel Bandwidth Low Channel 1RB#0

QPSK

16QAM

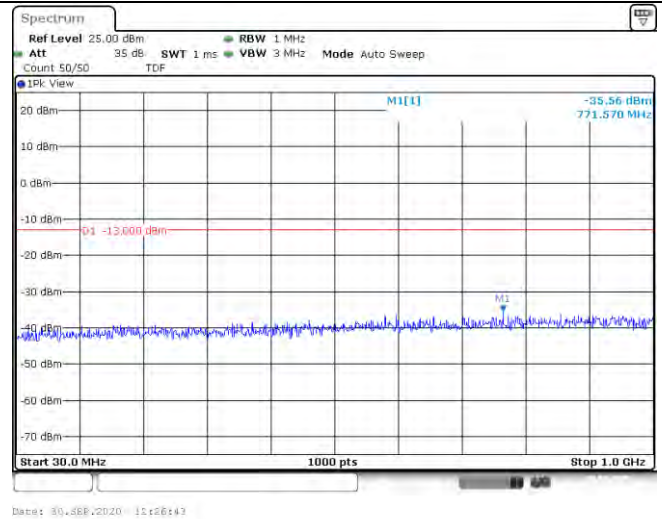
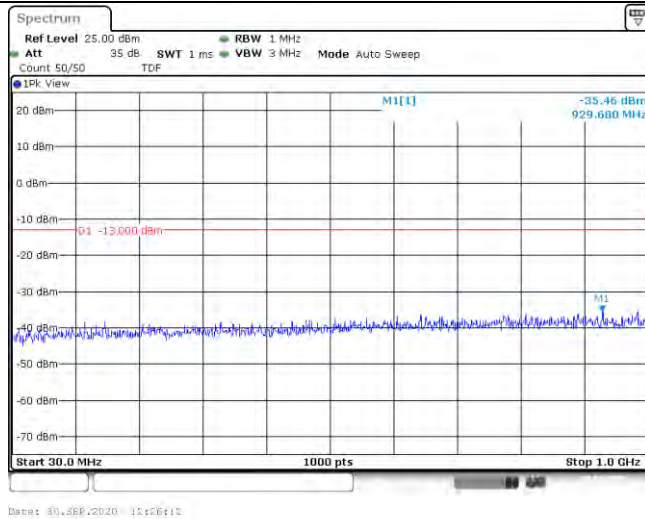

30MHz~1GHz

1GHz~2GHz

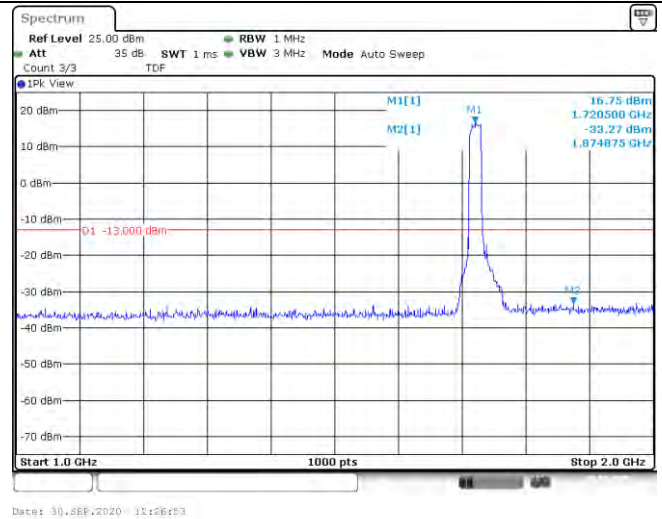
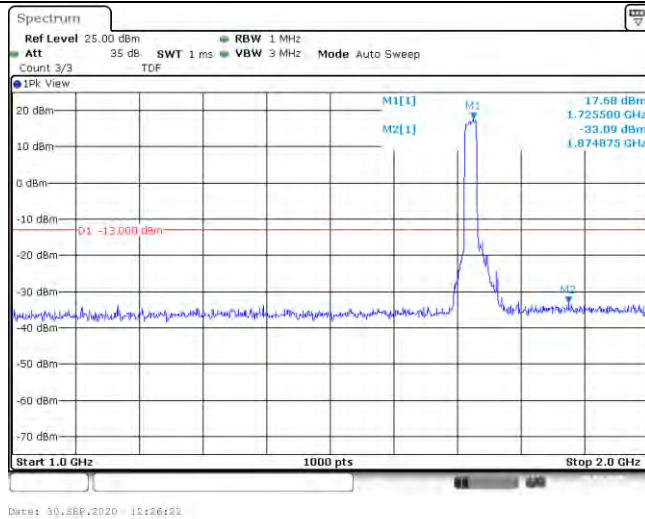

1GHz~2GHz

1GHz~2GHz

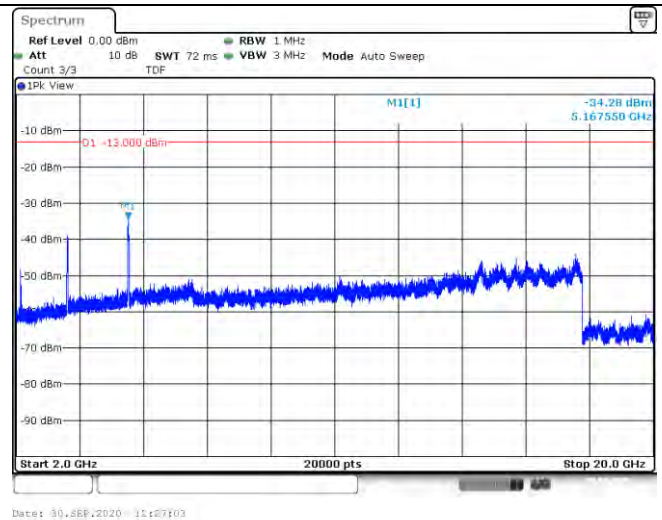
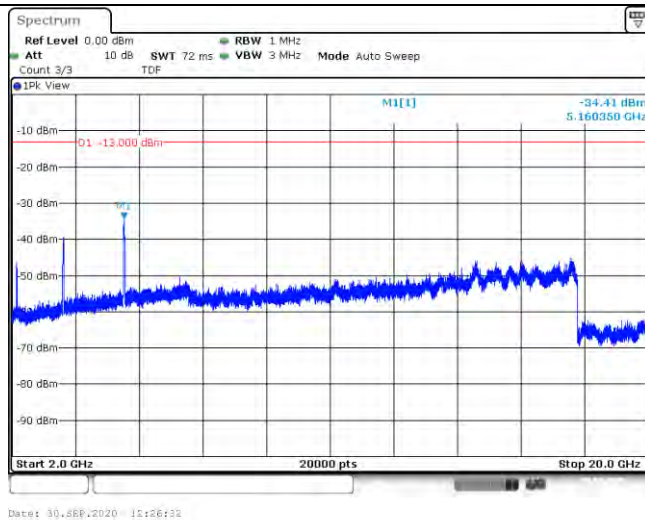

2GHz ~20GHz

2GHz ~20GHz

LTE FDD Band 4-20MHz Channel Bandwidth Middle Channel 1RB#0

QPSK

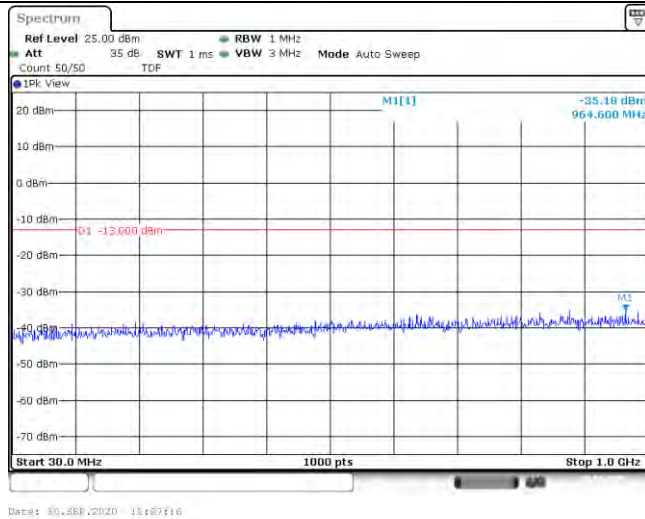

16QAM

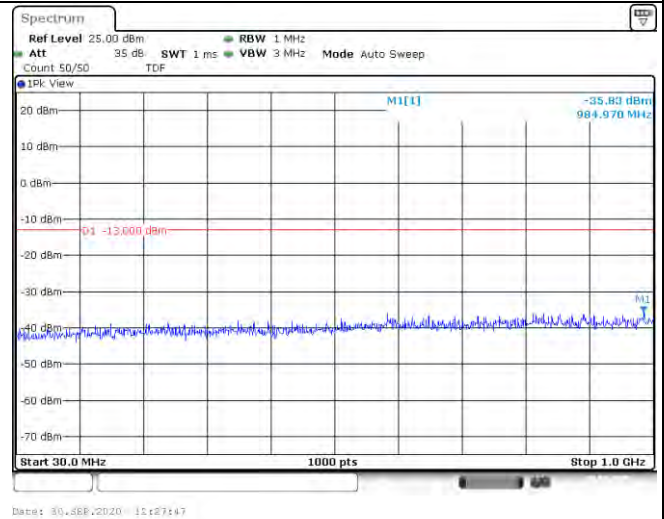

30MHz~1GHz

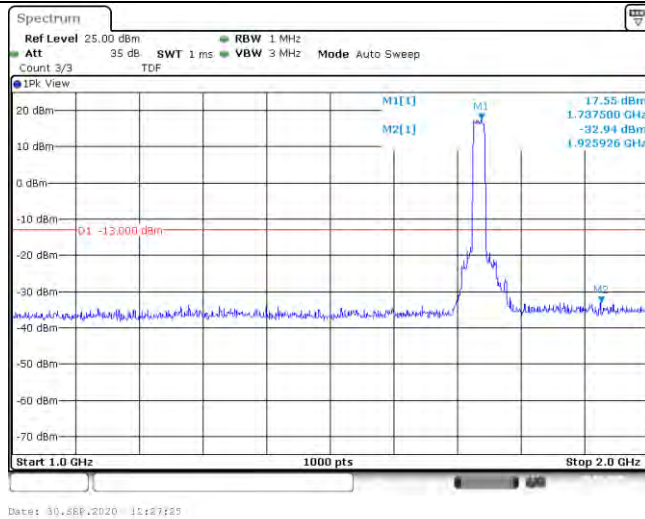

1GHz~2GHz

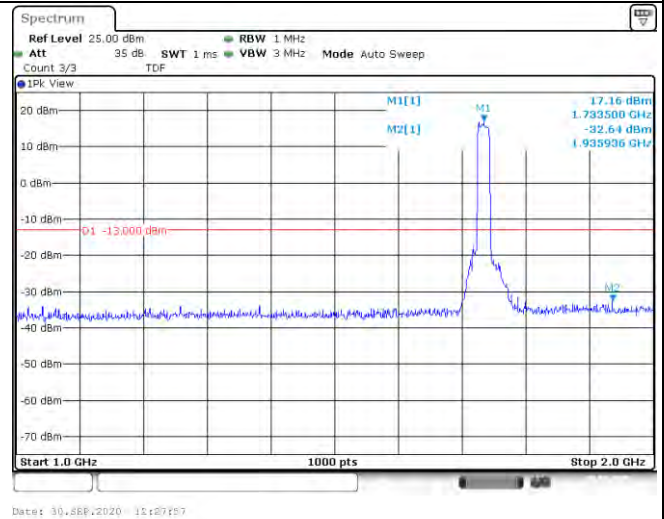

1GHz~2GHz

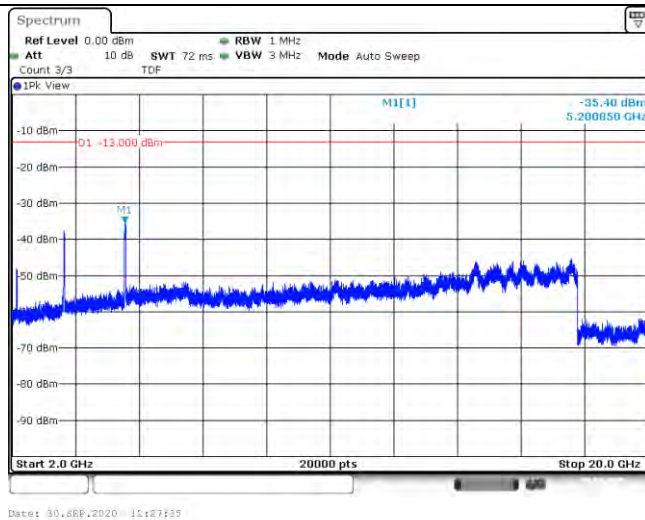

1GHz~2GHz

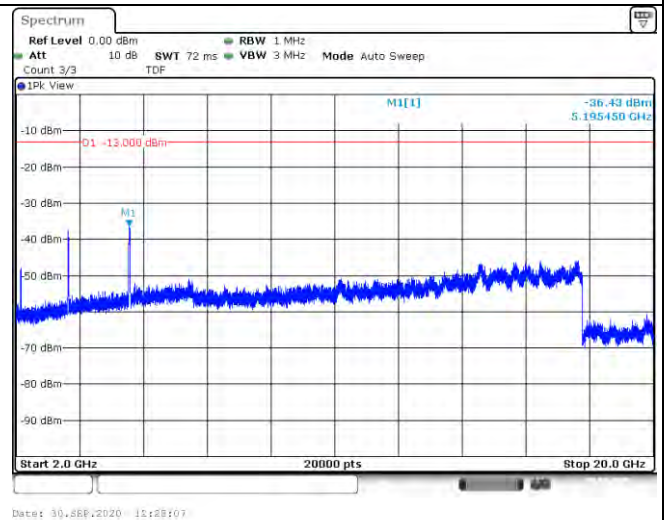

2GHz ~20GHz

2GHz ~20GHz

LTE FDD Band 4-20MHz Channel Bandwidth High Channel 1RB#0

QPSK

16QAM

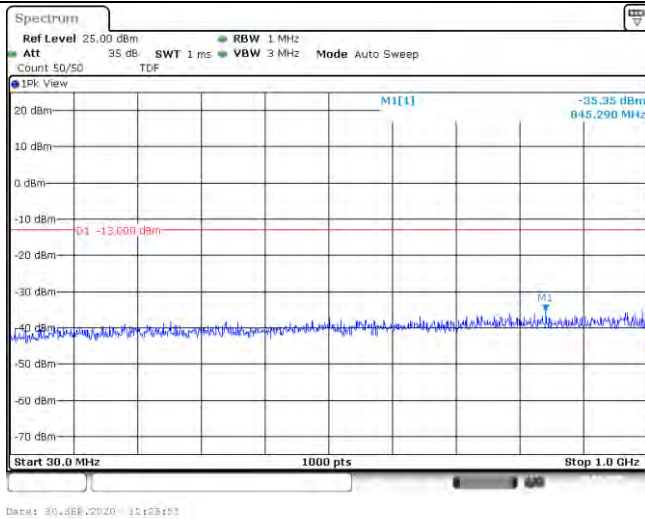
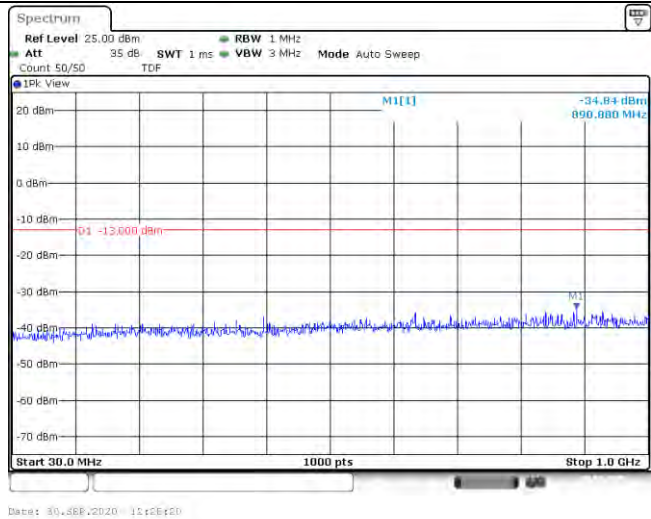

30MHz~1GHz

1GHz~2GHz

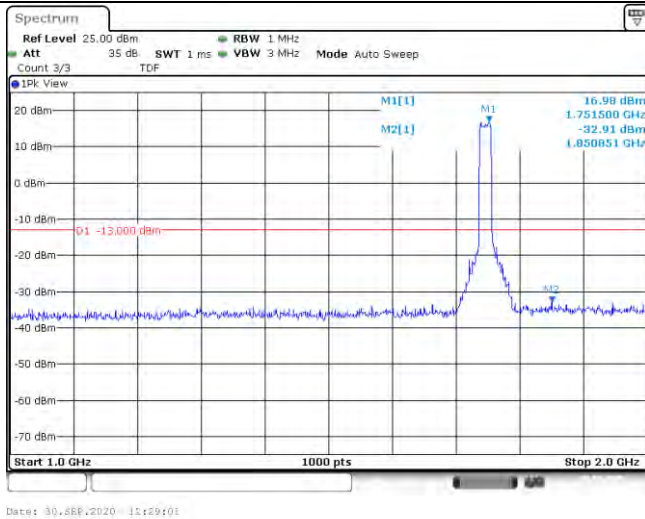
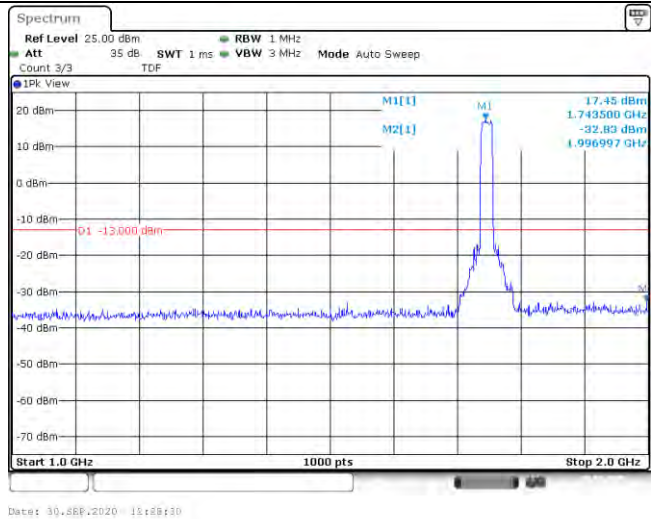

1GHz~2GHz

1GHz~2GHz

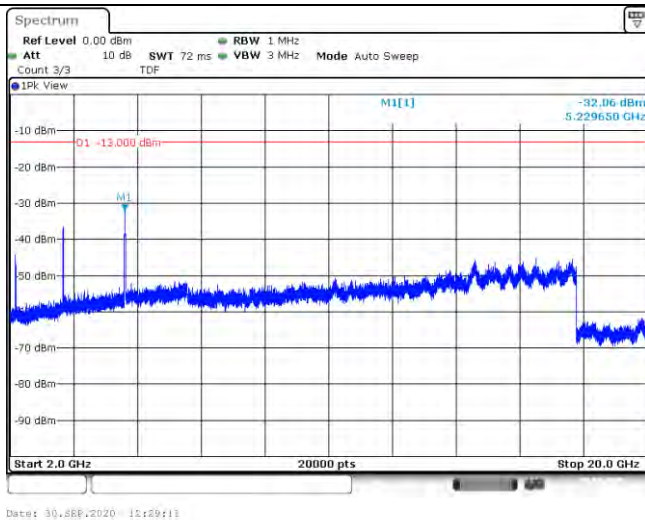
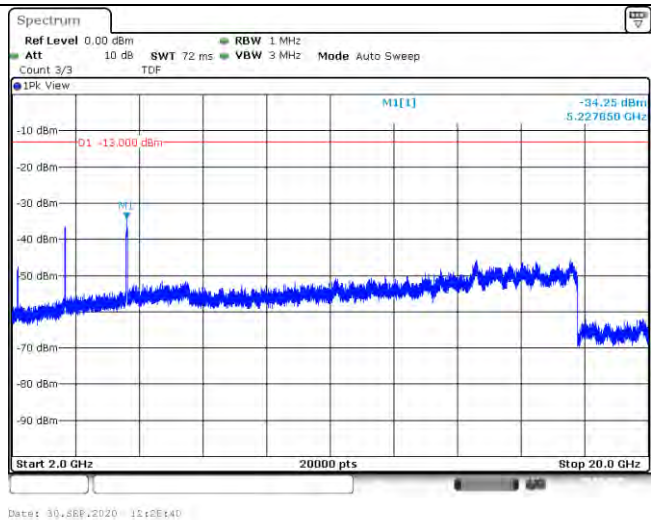

2GHz ~20GHz

2GHz ~20GHz

Radiated Measurement:

Remark:

1. We were tested all RB Configuration refer 3GPP TS136 521 for each Channel Bandwidth of LTE FDD Band 4; recorded worst case for each Channel Bandwidth of LTE FDD Band 4 @ QPSK
2. $EIRP = P_{Mea}(dBm) - P_{cl}(dB) + G_a(dBi)$
3. We were not recorded other points as values lower than limits.
4. $Margin = Limit - EIRP$

LTE FDD Band 4_Channel Bandwidth 1.4MHz_QPSK_Low Channel

Frequency (MHz)	P _{Mea} (dBm)	P _{cl} (dB)	Distance (m)	G _a Antenna Gain(dB)	Peak EIRP (dBm)	Limit (dBm)	Margin (dB)	Polarization
3421.4	-29.52	4.02	3.00	12.50	-21.04	-13.00	8.04	H
5132.1	-27.56	5.11	3.00	13.38	-19.29	-13.00	6.29	H
3421.4	-27.86	4.02	3.00	12.50	-19.38	-13.00	6.38	V
5132.1	-25.97	5.11	3.00	13.38	-17.70	-13.00	4.70	V

LTE FDD Band 4_Channel Bandwidth 1.4MHz_QPSK_Middle Channel

Frequency (MHz)	P _{Mea} (dBm)	P _{cl} (dB)	Distance (m)	G _a Antenna Gain(dB)	EIRP (dBm)	Limit (dBm)	Margin (dB)	Polarization
3465.0	-31.42	4.02	3.00	12.45	-22.99	-13.00	9.99	H
5197.5	-30.80	5.11	3.00	13.38	-22.53	-13.00	9.53	H
3465.0	-28.76	4.02	3.00	12.45	-20.33	-13.00	7.33	V
5197.5	-28.53	5.11	3.00	13.38	-20.26	-13.00	7.26	V

LTE FDD Band 4_Channel Bandwidth 1.4MHz_QPSK_High Channel

Frequency (MHz)	P _{Mea} (dBm)	P _{cl} (dB)	Distance (m)	G _a Antenna Gain(dB)	EIRP (dBm)	Limit (dBm)	Margin (dB)	Polarization
3508.6	-29.59	4.02	3.00	12.21	-21.40	-13.00	8.40	H
5262.9	-30.04	5.11	3.00	13.26	-21.89	-13.00	8.89	H
3508.6	-27.88	4.02	3.00	12.21	-19.69	-13.00	6.69	V
5262.9	-28.16	5.11	3.00	13.26	-20.01	-13.00	7.01	V

LTE FDD Band 4_Channel Bandwidth 3MHz_QPSK_Low Channel

Frequency (MHz)	P _{Mea} (dBm)	P _{cl} (dB)	Distance (m)	G _a Antenna Gain(dB)	Peak EIRP (dBm)	Limit (dBm)	Margin (dB)	Polarization
3423.0	-30.40	4.02	3.00	12.50	-21.92	-13.00	8.92	H
5134.5	-28.21	5.11	3.00	13.38	-19.94	-13.00	6.94	H
3423.0	-28.47	4.02	3.00	12.50	-19.99	-13.00	6.99	V
5134.5	-26.52	5.11	3.00	13.38	-18.25	-13.00	5.25	V

LTE FDD Band 4_Channel Bandwidth 3MHz_QPSK_Middle Channel

Frequency (MHz)	P _{Mea} (dBm)	P _{cl} (dB)	Distance (m)	G _a Antenna Gain(dB)	EIRP (dBm)	Limit (dBm)	Margin (dB)	Polarization
3465.0	-28.67	4.02	3.00	12.45	-20.24	-13.00	7.24	H
5197.5	-30.71	5.11	3.00	13.38	-22.44	-13.00	9.44	H
3465.0	-27.10	4.02	3.00	12.45	-18.67	-13.00	5.67	V
5197.5	-29.12	5.11	3.00	13.38	-20.85	-13.00	7.85	V

LTE FDD Band 4_Channel Bandwidth 3MHz_QPSK_High Channel

Frequency (MHz)	P _{Mea} (dBm)	P _{cl} (dB)	Distance (m)	G _a Antenna Gain(dB)	EIRP (dBm)	Limit (dBm)	Margin (dB)	Polarization
3507.0	-28.21	4.02	3.00	12.21	-20.02	-13.00	7.02	H
5260.5	-29.24	5.11	3.00	13.26	-21.09	-13.00	8.09	H
3507.0	-25.99	4.02	3.00	12.21	-17.80	-13.00	4.80	V
5260.5	-27.12	5.11	3.00	13.26	-18.97	-13.00	5.97	V

LTE FDD Band 4_Channel Bandwidth 5MHz_QPSK_Low Channel

Frequency (MHz)	P _{Mea} (dBm)	P _{cl} (dB)	Distance (m)	G _a Antenna Gain(dB)	Peak EIRP (dBm)	Limit (dBm)	Margin (dB)	Polarization
3425.0	-29.85	4.02	3.00	12.50	-21.37	-13.00	8.37	H
5137.5	-27.93	5.11	3.00	13.38	-19.66	-13.00	6.66	H
3425.0	-27.72	4.02	3.00	12.50	-19.24	-13.00	6.24	V
5137.5	-25.96	5.11	3.00	13.38	-17.69	-13.00	4.69	V

LTE FDD Band 4_Channel Bandwidth 5MHz_QPSK_Middle Channel

Frequency (MHz)	P _{Mea} (dBm)	P _{cl} (dB)	Distance (m)	G _a Antenna Gain(dB)	EIRP (dBm)	Limit (dBm)	Margin (dB)	Polarization
3465.0	-31.35	4.02	3.00	12.45	-22.92	-13.00	9.92	H
5197.5	-29.40	5.11	3.00	13.38	-21.13	-13.00	8.13	H
3465.0	-29.78	4.02	3.00	12.45	-21.35	-13.00	8.35	V
5197.5	-27.07	5.11	3.00	13.38	-18.80	-13.00	5.80	V

LTE FDD Band 4_Channel Bandwidth 5MHz_QPSK_High Channel

Frequency (MHz)	P _{Mea} (dBm)	P _{cl} (dB)	Distance (m)	G _a Antenna Gain(dB)	EIRP (dBm)	Limit (dBm)	Margin (dB)	Polarization
3505.0	-28.35	4.02	3.00	12.21	-20.16	-13.00	7.16	H
5257.5	-28.38	5.11	3.00	13.26	-20.23	-13.00	7.23	H
3505.0	-26.13	4.02	3.00	12.21	-17.94	-13.00	4.94	V
5257.5	-26.67	5.11	3.00	13.26	-18.52	-13.00	5.52	V

LTE FDD Band 4_Channel Bandwidth 10MHz_QPSK_Low Channel

Frequency (MHz)	P _{Mea} (dBm)	P _{cl} (dB)	Distance (m)	G _a Antenna Gain(dB)	Peak EIRP (dBm)	Limit (dBm)	Margin (dB)	Polarization
3430.0	-28.47	4.02	3.00	12.50	-19.99	-13.00	6.99	H
5145.0	-29.21	5.11	3.00	13.38	-20.94	-13.00	7.94	H
3430.0	-26.97	4.02	3.00	12.50	-18.49	-13.00	5.49	V
5145.0	-26.47	5.11	3.00	13.38	-18.20	-13.00	5.20	V

LTE FDD Band 4_Channel Bandwidth 10MHz_QPSK_Middle Channel

Frequency (MHz)	P _{Mea} (dBm)	P _{cl} (dB)	Distance (m)	G _a Antenna Gain(dB)	EIRP (dBm)	Limit (dBm)	Margin (dB)	Polarization
3465.0	-28.68	4.02	3.00	12.45	-20.25	-13.00	7.25	H
5197.5	-27.48	5.11	3.00	13.38	-19.21	-13.00	6.21	H
3465.0	-27.04	4.02	3.00	12.45	-18.61	-13.00	5.61	V
5197.5	-24.80	5.11	3.00	13.38	-16.53	-13.00	3.53	V

LTE FDD Band 4_Channel Bandwidth 10MHz_QPSK_High Channel

Frequency (MHz)	P _{Mea} (dBm)	P _{cl} (dB)	Distance (m)	G _a Antenna Gain(dB)	EIRP (dBm)	Limit (dBm)	Margin (dB)	Polarization
3500.0	-30.55	4.02	3.00	12.21	-22.36	-13.00	9.36	H
5250.0	-28.72	5.11	3.00	13.26	-20.57	-13.00	7.57	H
3500.0	-28.28	4.02	3.00	12.21	-20.09	-13.00	7.09	V
5250.0	-27.15	5.11	3.00	13.26	-19.00	-13.00	6.00	V

LTE FDD Band 4_Channel Bandwidth 15MHz_QPSK_Low Channel

Frequency (MHz)	P _{Mea} (dBm)	P _{cl} (dB)	Distance (m)	G _a Antenna Gain(dB)	Peak EIRP (dBm)	Limit (dBm)	Margin (dB)	Polarization
3435.0	-27.81	4.02	3.00	12.50	-19.33	-13.00	6.33	H
5152.5	-30.72	5.11	3.00	13.38	-22.45	-13.00	9.45	H
3435.0	-25.59	4.02	3.00	12.50	-17.11	-13.00	4.11	V
5152.5	-29.07	5.11	3.00	13.38	-20.80	-13.00	7.80	V

LTE FDD Band 4_Channel Bandwidth 15MHz_QPSK_Middle Channel

Frequency (MHz)	P _{Mea} (dBm)	P _{cl} (dB)	Distance (m)	G _a Antenna Gain(dB)	EIRP (dBm)	Limit (dBm)	Margin (dB)	Polarization
3465.0	-29.67	4.02	3.00	12.45	-21.24	-13.00	8.24	H
5197.5	-28.15	5.11	3.00	13.38	-19.88	-13.00	6.88	H
3465.0	-28.02	4.02	3.00	12.45	-19.59	-13.00	6.59	V
5197.5	-26.52	5.11	3.00	13.38	-18.25	-13.00	5.25	V

LTE FDD Band 4_Channel Bandwidth 15MHz_QPSK_High Channel

Frequency (MHz)	P _{Mea} (dBm)	P _{cl} (dB)	Distance (m)	G _a Antenna Gain(dB)	EIRP (dBm)	Limit (dBm)	Margin (dB)	Polarization
3495.0	-28.05	4.02	3.00	12.21	-19.86	-13.00	6.86	H
5242.5	-27.44	5.11	3.00	13.26	-19.29	-13.00	6.29	H
3495.0	-26.06	4.02	3.00	12.21	-17.87	-13.00	4.87	V
5242.5	-25.40	5.11	3.00	13.26	-17.25	-13.00	4.25	V

LTE FDD Band 4_Channel Bandwidth 20MHz_QPSK_Low Channel

Frequency (MHz)	P _{Mea} (dBm)	P _{cl} (dB)	Distance (m)	G _a Antenna Gain(dB)	Peak EIRP (dBm)	Limit (dBm)	Margin (dB)	Polarization
3440.0	-31.20	4.02	3.00	12.50	-22.72	-13.00	9.72	H
5160.0	-30.11	5.11	3.00	13.38	-21.84	-13.00	8.84	H
3440.0	-28.63	4.02	3.00	12.50	-20.15	-13.00	7.15	V
5160.0	-27.56	5.11	3.00	13.38	-19.29	-13.00	6.29	V

LTE FDD Band 4_Channel Bandwidth 20MHz_QPSK_Middle Channel

Frequency (MHz)	P _{Mea} (dBm)	P _{cl} (dB)	Distance (m)	G _a Antenna Gain(dB)	EIRP (dBm)	Limit (dBm)	Margin (dB)	Polarization
3465.0	-30.60	4.02	3.00	12.45	-22.17	-13.00	9.17	H
5197.5	-29.91	5.11	3.00	13.38	-21.64	-13.00	8.64	H
3465.0	-28.23	4.02	3.00	12.45	-19.80	-13.00	6.80	V
5197.5	-28.02	5.11	3.00	13.38	-19.75	-13.00	6.75	V

LTE FDD Band 4_Channel Bandwidth 20MHz_QPSK_High Channel

Frequency (MHz)	P _{Mea} (dBm)	P _{cl} (dB)	Distance (m)	G _a Antenna Gain(dB)	EIRP (dBm)	Limit (dBm)	Margin (dB)	Polarization
3490.0	-27.47	4.02	3.00	12.21	-19.28	-13.00	6.28	H
5235.0	-28.12	5.11	3.00	13.26	-19.97	-13.00	6.97	H
3490.0	-24.84	4.02	3.00	12.21	-16.65	-13.00	3.65	V
5235.0	-25.97	5.11	3.00	13.26	-17.82	-13.00	4.82	V

3.6 Frequency Stability under Temperature & Voltage Variations

LIMIT

According to §27.54, §2.1055 requirement, the frequency stability shall be sufficient to ensure that the fundamental emissions stay within the authorized bands of operation and should not exceed 2.5ppm.

TEST CONFIGURATION

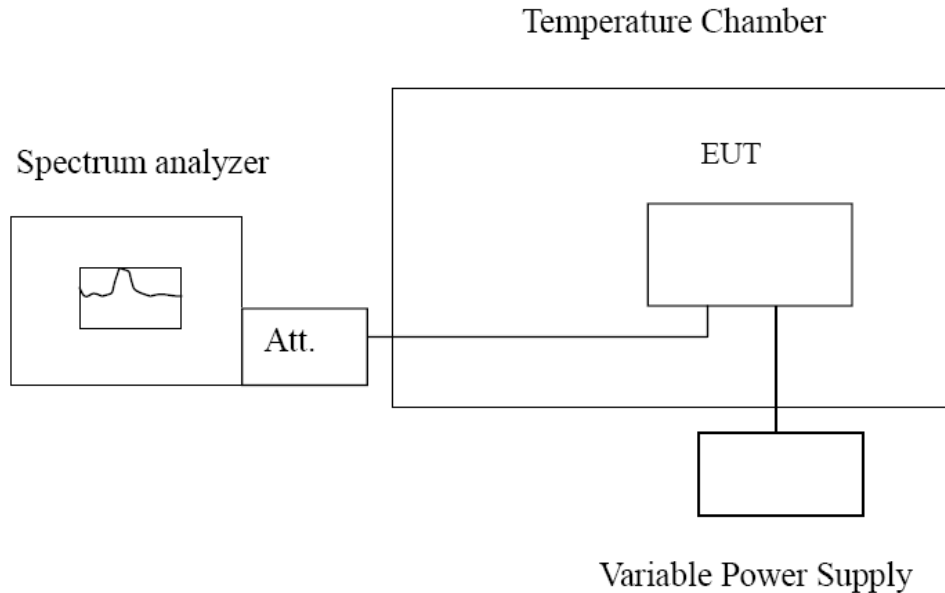

TEST PROCEDURE

The EUT was setup according to EIA/TIA 603D

Frequency Stability under Temperature Variations:

In order to measure the carrier frequency under the condition of AFC lock, it is necessary to make measurements with the EUT in a “call mode”. This is accomplished with the use of R&S CMW500 DIGITAL RADIO COMMUNICATION TESTER.

1. Measure the carrier frequency at room temperature.
2. Subject the EUT to overnight soak at -30°C.
3. With the EUT, powered via nominal voltage, connected to the CMW500 and in a simulated call on middle channel for LTE band 4, measure the carrier frequency. These measurements should be made within 2 minutes of Powering up the EUT, to prevent significant self-warming.
4. Repeat the above measurements at 10°C increments from -30°C to +50°C. Allow at least 1.5 hours at each temperature, unpowered, before making measurements.
5. Re-measure carrier frequency at room temperature with nominal voltage. Vary supply voltage from minimum voltage to maximum voltage, in 0.1Volt increments re-measuring carrier frequency at each voltage. Pause at nominal voltage for 1.5 hours unpowered, to allow any self-heating to stabilize, before continuing.
6. Subject the EUT to overnight soak at +50°C.
7. With the EUT, powered via nominal voltage, connected to the CMW500 and in a simulated call on the centre channel, measure the carrier frequency. These measurements should be made within 2 minutes of Powering up the EUT, to prevent significant self-warming.
8. Repeat the above measurements at 10 °C increments from +50°C to -30°C. Allow at least 1.5 hours at each temperature, unpowered, before making measurements
9. At all temperature levels hold the temperature to +/- 0.5°C during the measurement procedure.

Frequency Stability under Voltage Variations:

Set chamber temperature to 20°C. Use a variable AC power supply / DC power source to power the EUT and set the voltage to rated voltage. Set the spectrum analyzer RBW low enough to obtain the desired frequency resolution and recorded the frequency.

Reduce the input voltage to specify extreme voltage variation ($\pm 15\%$) and endpoint, record the maximum frequency change.

TEST RESULTS

Remark:

1. We tested all RB Configuration refer 3GPP TS136 521 for each Channel Bandwidth of LTE FDD Band 4; recorded worst case.

LTE Band 4, 1.4MHz bandwidth (worst case of all bandwidths)

Frequency Error vs Voltage

Voltage (V)	Frequency error (Hz)		Frequency error (ppm)		Limit (ppm)
	QPSK	16QAM	QPSK	16QAM	
3.85	-1.54	-5.08	-0.00089	-0.00293	2.50
4.43	2.03	9.68	0.00117	0.00559	2.50
3.27	-8.57	6.48	-0.00495	0.00374	2.50

Frequency Error vs Temperature

Temperature (°C)	Frequency error (Hz)		Frequency error (ppm)		Limit (ppm)
	QPSK	16QAM	QPSK	16QAM	
-30°	-1.85	-5.36	-0.00107	-0.00309	2.50
-20°	4.12	7.60	0.00238	0.00439	2.50
-10°	0.24	-2.08	0.00014	-0.00120	2.50
0°	1.23	-2.35	0.00071	-0.00136	2.50
10°	-3.20	2.15	-0.00185	0.00124	2.50
20°	9.74	1.23	0.00562	0.00071	2.50
30°	6.66	0.93	0.00384	0.00054	2.50
40°	-4.82	-3.28	-0.00278	-0.00189	2.50
50°	1.76	-1.38	0.00102	-0.00080	2.50

4 Test Setup Photos of the EUT



5 Photos of the EUT

Reference to the test report No. GTS20200923017-1-1

***** End of Report *****