



Shenzhen Global Test Service Co.,Ltd.

No.7-101 and 8A-104,Building 7 and 8,DCC Cultural and Creative Garden No.98,Pingxin North Road,Shangmugu,Pinghu Street, Longgang District,Shenzhen,Guangdong,China

TEST REPORT

FCC Part 22 Subpart H / Part 24 Subpart E

Report Reference No......: **GTS20200923017-1-1**
FCC ID.....: **RQQHLT-L622TA**
 Compiled by
 (position+printed name+signature) .: File administrators Jimmy Wang
 Supervised by
 (position+printed name+signature) .: Test Engineer Aaron Tan
 Approved by
 (position+printed name+signature) .: Manager Jason Hu
 Date of issue.....: Oct.23, 2020

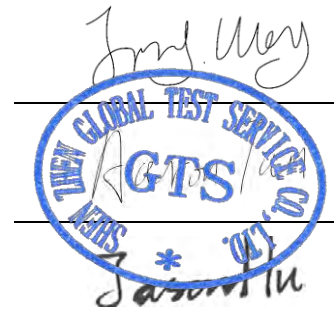

Testing Laboratory Name: **Shenzhen Global Test Service Co.,Ltd.**
 Address: No.7-101 and 8A-104,Building 7 and 8,DCC Cultural and Creative Garden No.98,Pingxin North Road,Shangmugu,Pinghu Street, Longgang District,Shenzhen,Guangdong,China

Applicant's name: **Hyundai Corporation**
 Address: 25,Yulgok-ro 2-Gil, Jongno-gu, Seoul, South Korea

Test specification:
 Standard: **FCC CFR Title 47 Part 2, Part 22H, Part 24E**
ANSI/TIA-603-E-2016
KDB 971168 D01

Shenzhen Global Test Service Co.,Ltd. All rights reserved.
 This publication may be reproduced in whole or in part for non-commercial purposes as long as the Shenzhen Global Test Service Co.,Ltd. is acknowledged as copyright owner and source of the material. Shenzhen Global Test Service Co.,Ltd.takes no responsibility for and will not assume liability for damages resulting from the reader's interpretation of the reproduced material due to its placement and context.

Test item description.....: Smart phone
 Trade Mark: HYUNDAI
Manufacturer.....: **Shenzhen Tinnno Mobile Technology Corp**
 Model/Type reference.....: L622
 Listed Models: N/A
 Ratings: DC 3.85V from battery
 Modulation: GMSK, 8PSK, QPSK
 Hardware version: V1.0
 Software version: HYUNDAI_L622_V1.1.3
 Frequency.....: GSM850, PCS1900, UMTS Band II, UMTS Band V
 Result.....: **PASS**

TEST REPORT

Test Report No. :	GTS20200923017-1-1	Oct.23, 2020
		Date of issue

Equipment under Test : Smart phone

Model /Type : L622

Listed Models : N/A

Applicant : **Hyundai Corporation**

Address : 25,Yulgok-ro 2-Gil, Jongno-gu, Seoul, South Korea

Manufacturer : **Shenzhen Tinno Mobile Technology Corp**

Address : 4/F.,H-3 Building,OCT Eastern Industrial Park. NO.1
XiangShan East Road.,Nan Shan District,Shenzhen,P.R.China

Test result	Pass *
--------------------	---------------

* In the configuration tested, the EUT complied with the standards specified page 4.

The test report merely corresponds to the test sample.

It is not permitted to copy extracts of these test result without the written permission of the test laboratory.

Contents

1	SUMMARY	4
1.1	TEST STANDARDS	4
1.2	ADDRESS OF THE TEST LABORATORY	5
1.3	TEST FACILITY	5
1.4	STATEMENT OF THE MEASUREMENT UNCERTAINTY	5
2	GENERAL INFORMATION	6
2.1	GENERAL REMARKS	6
2.2	GENERAL DESCRIPTION OF EUT	6
2.3	DESCRIPTION OF TEST MODES AND TEST FREQUENCY	7
2.4	EQUIPMENTS USED DURING THE TEST	8
2.5	RELATED SUBMITTAL(S) / GRANT (S)	9
2.6	MODIFICATIONS	9
2.7	ENVIRONMENTAL CONDITIONS	9
3	TEST CONDITIONS AND RESULTS	10
3.1	OUTPUT POWER	10
3.2	OCCUPIED BANDWIDTH	15
3.3	BAND EDGE COMPLIANCE	19
3.4	SPURIOUS EMISSION	23
3.5	PEAK-TO-AVERAGE RATIO (PAR)	33
3.6	FREQUENCY STABILITY UNDER TEMPERATURE & VOLTAGE VARIATIONS	34
4	TEST SETUP PHOTOS OF THE EUT	37
5	EXTERNAL AND INTERNAL PHOTOS OF THE EUT	38

1 SUMMARY

1.1 TEST STANDARDS

The tests were performed according to following standards:

[FCC Part 2](#): FREQUENCY ALLOCATIONS AND RADIO TREATY MATTERS; GENERAL RULES AND REGULATIONS

[FCC Part 22 Subpart H](#): PRIVATE LAND MOBILE RADIO SERVICES.

[FCC Part 24 Subpart E](#): PUBLIC MOBILE SERVICES

[ANSI/TIA-603-E-2016](#): Land Mobile FM or PM Communications Equipment Measurement and Performance Standards.

[ANSI C63.10-2013](#) Methods of Measurement of Radio-Noise Emissions from Low-Voltage Electrical and Electronic Equipment in the Range of 9 kHz to 40 GHz

[FCCKDB971168D01](#) Power Meas License Digital Systems

Test Description

Test Item	Section in CFR 47	Result
RF Output Power	Part 2.1046 Part 22.913 (a)(2) Part 24.232 (c)	Pass
Peak-to-Average Ratio	Part 24.232 (d)	Pass
99% & -26 dB Occupied Bandwidth	Part 2.1049 Part 22.917	Pass
Spurious Emissions at Antenna Terminal	Part 2.1051 Part 22.917 (a) Part 24.238 (a)	Pass
Field Strength of Spurious Radiation	Part 2.1053 Part 22.917 (a) Part 24.238 (a)	Pass
Out of band emission, Band Edge	Part 22.917 (a) Part 24.238 (a)	Pass
Frequency stability	Part 2.1055 Part 22.355 Part 24.235	Pass

1.2 Address of the test laboratory

Shenzhen Global Test Service Co.,Ltd.

No.7-101 and 8A-104, Building 7 and 8, DCC Cultural and Creative Garden, No.98, Pingxin North Road, Shangmugu Community, Pinghu Street, Longgang District, Shenzhen, Guangdong

The 3m-Semi anechoic test site fulfils CISPR 16-1-4 according to ANSI C63.4:2014 and CISPR 16-1-4:2010 SVSWR requirement for radiated emission above 1GHz.

1.3 Test Facility

The test facility is recognized, certified, or accredited by the following organizations:

FCC-Registration No.: 165725

Shenzhen Global Test Service Co.,Ltd EMC Laborns Commission. The acceptance letter from the FCC is maintained in our files.

atory has been registered and fully described in a report filed with the (FCC) Federal Communicatio

A2LA-Lab Cert. No.: 4758.01

Shenzhen Global Test Service Co.,Ltd. EMC Laboratory has been accredited by A2LA for technical competence in the field of electrical testing, and proved to be in compliance with ISO/IEC 17025: 2005 General Requirements for the Competence of Testing and Calibration Laboratories and any additional program requirements in the identified field of testing.

CNAS-Lab Code: L8169

Shenzhen Global Test Service Co.,Ltd. has been assessed and proved to be in compliance with CNAS-CL01 Accreditation Criteria for Testing and Calibration Laboratories (identical to ISO/IEC 17025: 2005 General Requirements) for the Competence of Testing and Calibration Laboratories. Date of Registration: Dec. 11, 2015. Valid time is until Dec. 10, 2024.

1.4 Statement of the measurement uncertainty

The data and results referenced in this document are true and accurate. The reader is cautioned that there may be errors within the calibration limits of the equipment and facilities. The measurement uncertainty was calculated for all measurements listed in this test report acc. to TR-100028-01"Electromagnetic compatibilityand Radio spectrum Matters (ERM);Uncertainties in the measurementof mobile radio equipment characteristics;Part 1"and TR-100028-02 "Electromagnetic compatibilityand Radio spectrum Matters (ERM);Uncertainties in the measurementof mobile radio equipment characteristics;Part 2 " and is documented in the Shenzhen Global Test Service Co.,Ltd.quality system acc. to DIN EN ISO/IEC 17025. Furthermore, component and process variability of devices similar to that tested may result in additional deviation. The manufacturer has the sole responsibility of continued compliance of the device.

Hereafter the best measurement capability for Shenzhen Global Test Service Co.,Ltd.is reported:

Test	Range	Measurement Uncertainty	Notes
Radiated Emission	30~1000MHz	4.10 dB	(1)
Radiated Emission	1~18GHz	4.32 dB	(1)
Radiated Emission	18-40GHz	5.54 dB	(1)
Conducted Disturbance	0.15~30MHz	3.12 dB	(1)
Conducted Power	9KHz~18GHz	0.61 dB	(1)
Spurious RF Conducted Emission	9KHz~40GHz	1.22 dB	(1)
Band Edge Compliance of RF Emission	9KHz~40GHz	1.22 dB	(1)
Occupied Bandwidth	9KHz~40GHz	-	(1)

(1) This uncertainty represents an expanded uncertainty expressed at approximately the 95% confidence level using a coverage factor of k=1.96.

2 GENERAL INFORMATION

2.1 General Remarks

Date of receipt of test sample	:	Sep. 20, 2020
Testing commenced on	:	Sep. 21, 2020
Testing concluded on	:	Oct. 23, 2020

2.2 General Description of EUT

Product Name:	Smart phone
Model/Type reference:	L622
Power supply:	DC 3.85V from battery
Adaper information:	Model: AS5015A Input: AC100-240V 50/60Hz Output: DC5.0V---1.55A
Testing sample ID :	GTS20200923017-1-1#(Engineer sample), GTS20200923017-1-2#(Normal sample)
GSM	
Operation Band:	GSM850, PCS1900
Supported Type:	GSM/GPRS/EGPRS
Power Class:	GSM850:Power Class 4 PCS1900:Power Class 1
Modulation Type:	GMSK for GPRS, 8-PSK for EGPRS
GSM Release Version	R99
GPRS Multislot Class	12
EGPRS Multislot Class	12
Antenna type:	FPC antenna
Antenna Gain:	GSM850:0.30dBi,GSM1900:1.20dBi
WCDMA	
Operation Band:	FDD Band II, FDD Band V
Power Class:	Power Class 3
Modilation Type:	QPSK for HSUPA/HSDPA
WCDMA Release Version:	Rel-5
HSDPA Category:	Category 14
HSUPA Category:	Category 6
Antenna type:	FPC antenna
Antenna Gain:	FDD Band V:0.30dBi, FDD Band II:1.20dBi

Note: For more details, refer to the user's manual of the EUT.

2.3 Description of Test Modes and Test Frequency

The EUT has been tested under typical operating condition. The CUM200 used to control the EUT staying in continuous transmitting and receiving mode for testing. Regards to the frequency band operation: the lowest, middle and highest frequency of channel were selected to perform the test, then shown on this report.

Test Frequency:

GSM 850		PCS1900	
Channel	Frequency (MHz)	Channel	Frequency (MHz)
128	824.20	512	1850.20
190	836.60	661	1880.00
251	848.80	810	1909.80

FDD Band II		FDD Band V	
Channel	Frequency (MHz)	Channel	Frequency (MHz)
9262	1852.4	4132	826.40
9400	1880.0	4182	836.60
9538	1907.6	4233	846.60

Test Modes:

The test mode(s) are selected according to relevant radio technology specifications.

Test Mode	Test Modes Description
Mode 1	GSM system, GSM, GMSK modulation
Mode 2	GSM system, GPRS, GMSK modulation
Mode 3	GSM system, EDGE, 8PSK modulation
Mode 4	WCDMA system, QPSK modulation
Mode 5	HSDPA system, QPSK modulation
Mode 6	HSUPA system, QPSK modulation

Note:

1. As GPRS and GSM with the same emission designator, test result recorded in this report at the worst case Mode 1 only after exploratory scan.
2. As HSDPA and HSUPA with the same emission designator, test result recorded in this report at the worst case Mode 4 with RCM 12.2Kbps only after exploratory scan.

2.4 Equipments Used during the Test

Test Equipment	Manufacturer	Model No.	Serial No.	Calibration Date	Calibration Due Date
LISN	R&S	ENV216	3560.6550.0 8	2020/09/19	2021/09/18
LISN	R&S	ESH2-Z5	893606/008	2020/09/19	2021/09/18
EMI Test Receiver	R&S	ESPI3	101841-cd	2020/09/19	2021/09/18
EMI Test Receiver	R&S	ESCI7	101102	2020/09/19	2021/09/18
Spectrum Analyzer	Agilent	N9020A	MY48010425	2020/09/19	2021/09/18
Spectrum Analyzer	R&S	FSV40	100019	2020/09/19	2021/09/18
Vector Signal generator	Agilent	N5181A	MY49060502	2020/09/19	2021/09/18
Signal generator	Agilent	E4421B	3610AO1069	2020/09/19	2021/09/18
Climate Chamber	ESPEC	EL-10KA	A20120523	2020/09/19	2021/09/18
Controller	EM Electronics	Controller EM 1000	N/A	N/A	N/A
Horn Antenna	Schwarzbeck	BBHA 9120D	01622	2020/09/19	2021/09/18
Active Loop Antenna	Beijing Da Ze Technology Co.,Ltd.	ZN30900C	15006	2020/10/11	2021/10/10
Bilog Antenna	Schwarzbeck	VULB9163	000976	2020/05/26	2021/05/25
Broadband Horn Antenna	SCHWARZBEC K	BBHA 9170	791	2020/09/19	2021/09/18
Amplifier	Schwarzbeck	BBV 9743	#202	2020/09/19	2021/09/18
Amplifier	Schwarzbeck	BBV9179	9719-025	2020/09/19	2021/09/18
Amplifier	EMCI	EMC051845B	980355	2020/09/19	2021/09/18
Temperature/Humidity Meter	Gangxing	CTH-608	02	2020/09/19	2021/09/18
High-Pass Filter	K&L	9SH10-2700/X12750-O/O	KL142031	2020/09/19	2021/09/18
High-Pass Filter	K&L	41H10-1375/U12750-O/O	KL142032	2020/09/19	2021/09/18
RF Cable(below 1GHz)	HUBER+SUHNER	RG214	RE01	2020/09/19	2021/09/18
RF Cable(above 1GHz)	HUBER+SUHNER	RG214	RE02	2020/09/19	2021/09/18
Data acquisition card	Agilent	U2531A	TW5332350 7	2020/09/19	2021/09/18
Power Sensor	Agilent	U2021XA	MY5365004	2020/09/19	2021/09/18
Test Control Unit	Tonscend	JS0806-1	178060067	2020/06/20	2021/06/19
Automated filter bank	Tonscend	JS0806-F	19F8060177	2020/06/20	2021/06/19
EMI Test Software	Tonscend	JS1120-1	Ver 2.6.8.0518	/	/

EMI Test Software	Tonscend	JS1120-3	Ver 2.5.77.0418	/	/
EMI Test Software	Tonscend	JS32-CE	Ver 2.5	/	/
EMI Test Software	Tonscend	JS32-RE	Ver 2.5.1.8	/	/

Note: The Cal.Interval was one year.

2.5 Related Submittal(s) / Grant (s)

This submittal(s) (test report) is intended for FCC ID: RQQHLT-L622TA filing to comply with of the FCC Part 22 and Part 24 Rules.

2.6 Modifications

No modifications were implemented to meet testing criteria.

2.7 Environmental conditions

During the measurement the environmental conditions were within the listed ranges:

Normal Temperature:	25°C
Relative Humidity:	55 %
Air Pressure:	101 kPa

3 TEST CONDITIONS AND RESULTS

3.1 Output Power

LIMIT

GSM850/WCDMA Band V: 7W

PCS1900/WCDMA Band II: 2W

WCDMA Band IV: 1W

The Peak-to-Average Ratio (PAR) of the transmission may not exceed 13 dB.

TEST CONFIGURATION

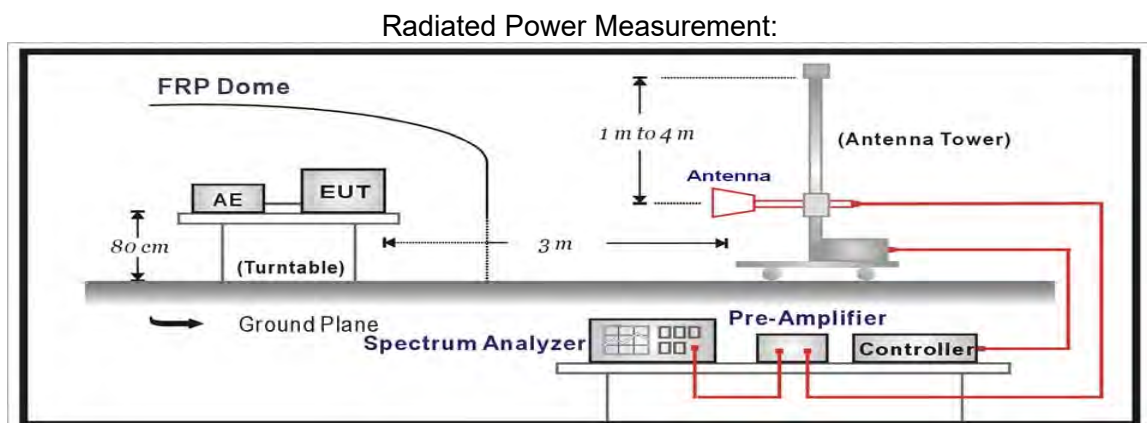
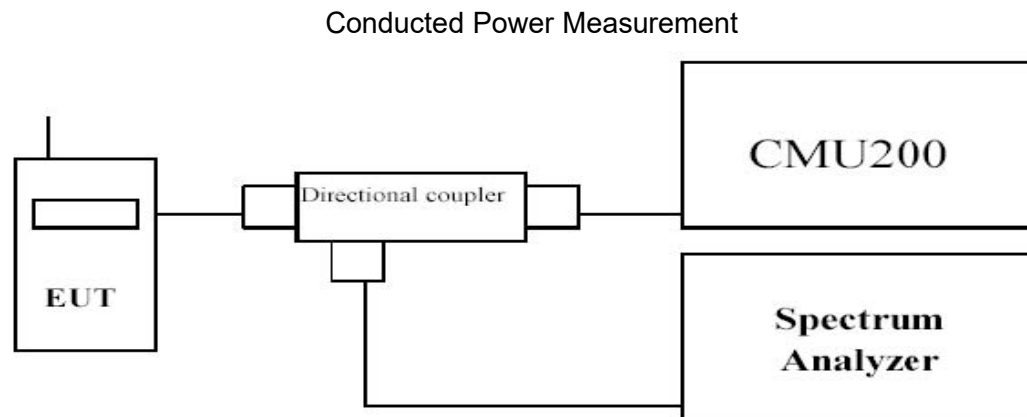

TEST PROCEDURE

The EUT was setup according to EIA/TIA 603C

Conducted Power Measurement:

- Place the EUT on a bench and set it in transmitting mode.
- Connect a low loss RF cable from the antenna port to a spectrum analyzer and CMU200 by a Directional Coupler.
- EUT Communicate with CMU200 then selects a channel for testing.
- Add a correction factor to the display of spectrum, and then test.

Radiated Power Measurement:

- The EUT shall be placed at the specified height on a support, and in the position closest to normal use as declared by provider.
- The test antenna shall be oriented initially for vertical polarization and shall be chosen to correspond to the frequency of the transmitter
- The output of the test antenna shall be connected to the measuring receiver.
- The transmitter shall be switched on and the measuring receiver shall be tuned to the frequency of the transmitter under test.

- e) The test antenna shall be raised and lowered through the specified range of height until a maximum signal level is detected by the measuring receiver.
- f) The transmitter shall then be rotated through 360° in the horizontal plane, until the maximum signal level is detected by the measuring receiver.
- g) The test antenna shall be raised and lowered again through the specified range of height until a maximum signal level is detected by the measuring receiver.
- h) The maximum signal level detected by the measuring receiver shall be noted.
- i) The transmitter shall be replaced by a substitution antenna.
- j) The substitution antenna shall be orientated for vertical polarization and the length of the substitution antenna shall be adjusted to correspond to the frequency of the transmitter.
- k) The substitution antenna shall be connected to a calibrated signal generator.
- l) If necessary, the input attenuator setting of the measuring receiver shall be adjusted in order to increase the sensitivity of the measuring receiver.
- m) The test antenna shall be raised and lowered through the specified range of height to ensure that the maximum signal is received.
- n) The input signal to the substitution antenna shall be adjusted to the level that produces a level detected by the measuring receiver, that is equal to the level noted while the transmitter radiated power was measured, corrected for the change of input attenuator setting of the measuring receiver.
- o) The measurement shall be repeated with the test antenna and the substitution antenna orientated for horizontal polarization.
- p) The measure of the effective radiated power is the larger of the two levels recorded at the input to the substitution antenna, corrected for gain of the substitution antenna if necessary.

TEST RESULTS**Conducted Measurement:**

Mode	Txslot	Burst Average Power (dBm)		
		128	190	251
GSM		32.56	32.40	32.73
GPRS 850 (GMSK)	1Txslot	32.80	32.08	31.94
	2Txslot	29.13	28.81	29.78
	3Txslot	27.52	27.25	27.76
	4Txslot	26.22	25.77	26.62
EGPRS 850 (8PSK)	1 Txslot	26.65	26.72	26.08
	2Txslot	24.73	24.82	25.78
	3Txslot	23.14	23.37	22.84
	4Txslot	21.34	20.83	21.18
Mode	Txslot	Burst Average Power (dBm)		
GSM		512	661	810
GSM		29.73	30.43	29.94
GPRS 1900 (GMSK)	1Txslot	29.99	30.58	30.16
	2Txslot	27.07	27.58	27.81
	3Txslot	24.94	25.81	25.40
	4Txslot	24.55	24.18	23.82
EGPRS 1900 (8PSK)	1 Txslot	24.96	25.75	25.06
	2Txslot	23.36	23.65	23.28
	3Txslot	21.72	22.22	22.73
	4Txslot	20.37	20.64	20.80

Item	Band	FDD Band II result (dBm)			FDD Band V result (dBm)		
		Test Channel			Test Channel		
		9262	9400	9538	4132	4183	4233
AMR	12.2kbps AMR	23.47	23.82	23.36	23.67	23.41	23.77
RMC	12.2kbps RMC	23.78	23.75	23.36	23.75	23.24	23.63
HSDPA	Sub - Test 1	22.19	22.84	21.91	22.40	22.01	21.96
	Sub - Test 2	21.11	21.57	21.83	20.72	21.83	20.78
	Sub - Test 3	21.32	20.94	20.78	21.51	20.73	20.88
	Sub - Test 4	20.74	20.46	19.81	20.72	20.62	20.09
HSUPA	Sub - Test 1	22.71	21.86	22.70	21.80	21.81	22.00
	Sub - Test 2	21.64	21.50	21.08	20.83	21.77	20.93
	Sub - Test 3	21.59	20.99	21.08	21.37	20.77	21.50
	Sub - Test 4	19.92	19.98	20.22	20.69	20.53	20.74
	Sub - Test 5	20.10	20.29	19.89	20.66	20.46	20.82

Radiated Measurement:

Note: 1. The field strength of radiation emission was measured in the following position: EUT stand-up position (Zaxis), lie-down position (X, Y axis). The data show in this report only with the worst case setup. After exploratory measurement the worst case of Z axis was reported.

Note: 2. We test the H direction and V direction and V direction is worse.

GSM850

Channel	P _{Mea} (dBm)	P _{cl} (dB)	G _a Antenna Gain(dB)	Correction (dB)	P _{Ag} (dB)	ERP (dBm)	Limit (dBm)	Margin (dB)	Polarization
128	-9.29	2.42	8.45	2.15	36.82	31.41	38.45	7.04	V
190	-8.82	2.46	8.45	2.15	36.82	31.84	38.45	6.61	V
251	-9.25	2.53	8.36	2.15	36.82	31.25	38.45	7.20	V

GPRS850

Channel	P _{Mea} (dBm)	P _{cl} (dB)	G _a Antenna Gain(dB)	Correction (dB)	P _{Ag} (dB)	ERP (dBm)	Limit (dBm)	Margin (dB)	Polarization
128	-9.99	2.42	8.45	2.15	36.82	30.71	38.45	7.74	V
190	-10.23	2.46	8.45	2.15	36.82	30.43	38.45	8.02	V
251	-10.33	2.53	8.36	2.15	36.82	30.17	38.45	8.28	V

EGPRS850

Channel	P _{Mea} (dBm)	P _{cl} (dB)	G _a Antenna Gain(dB)	Correction (dB)	P _{Ag} (dB)	ERP (dBm)	Limit (dBm)	Margin (dB)	Polarization
128	-16.38	2.42	8.45	2.15	36.82	24.32	38.45	14.13	V
190	-15.82	2.46	8.45	2.15	36.82	24.84	38.45	13.61	V
251	-15.97	2.53	8.36	2.15	36.82	24.53	38.45	13.92	V

PCS1900

Channel	P _{Mea} (dBm)	P _{cl} (dB)	G _a Antenna Gain(dB)	P _{Ag} (dB)	EIRP (dBm)	Limit (dBm)	Margin (dB)	Polarization
512	-10.52	3.41	10.24	33.60	29.91	33.01	3.10	V
661	-11.15	3.49	10.24	33.60	29.20	33.01	3.81	V
810	-10.61	3.55	10.23	33.60	29.67	33.01	3.34	V

GPRS1900

Channel	P _{Mea} (dBm)	P _{cl} (dB)	G _a Antenna Gain(dB)	P _{Ag} (dB)	EIRP (dBm)	Limit (dBm)	Margin (dB)	Polarization
512	-10.90	3.41	10.24	33.60	29.53	33.01	3.48	V
661	-10.83	3.49	10.24	33.60	29.52	33.01	3.49	V
810	-10.68	3.55	10.23	33.60	29.60	33.01	3.41	V

EGPRS1900

Channel	P _{Mea} (dBm)	P _{cl} (dB)	G _a Antenna Gain(dB)	P _{Ag} (dB)	EIRP (dBm)	Limit (dBm)	Margin (dB)	Polarization
512	-16.53	3.41	10.24	33.60	23.90	33.01	9.11	V
661	-16.75	3.49	10.24	33.60	23.60	33.01	9.41	V
810	-16.94	3.55	10.23	33.60	23.34	33.01	9.67	V

WCDMA BAND II

Channel	P _{Mea} (dBm)	P _{cl} (dB)	G _a Antenna Gain(dB)	P _{Ag} (dB)	EIRP (dBm)	Limit (dBm)	Margin (dB)	Polarization
9262	-18.28	3.41	10.24	33.60	22.15	33.01	10.86	V
9400	-18.15	3.49	10.24	33.60	22.20	33.01	10.81	V
9538	-18.19	3.55	10.23	33.60	22.09	33.01	10.92	V

WCDMA BAND V

Channel	P _{Mea} (dBm)	P _{cl} (dB)	G _a Antenna Gain(dB)	Correction (dB)	P _{Ag} (dB)	ERP (dBm)	Limit (dBm)	Margin (dB)	Polarization
4132	-18.94	2.42	8.45	2.15	36.82	21.76	38.45	16.69	V
4183	-18.74	2.46	8.45	2.15	36.82	21.92	38.45	16.53	V
4233	-18.30	2.53	8.36	2.15	36.82	22.20	38.45	16.25	V

Remark:

1. $EIRP = P_{Mea}(dBm) - P_{cl}(dB) + P_{Ag}(dB) + G_a(dBi)$

2. $ERP = EIRP - 2.15dBi$ as EIRP by subtracting the gain of the dipole.

3.2 Occupied Bandwidth

LIMIT

N/A

TEST CONFIGURATION

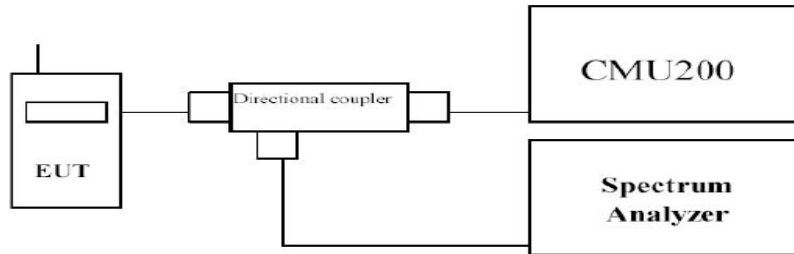

TEST PROCEDURE

1. The EUT's output RF connector was connected with a short cable to the spectrum analyzer
2. RBW was set to about 1% of emission BW, VBW ≥ 3 times RBW.
3. -26dBc display line was placed on the screen (or 99% bandwidth), the occupied bandwidth is the delta frequency between the two points where the display line intersects the signal trace.

TEST RESULTS

EUT Mode	Channel	Frequency (MHz)	99% Occupy bandwidth (KHz)	-26dB bandwidth (KHz)
GSM850 (GMSK, 1Slot)	128	824.20	245.71	308.60
	190	836.60	247.08	289.50
	251	848.80	242.02	300.50
EGPRS850 (8PSK, 1Slot)	128	824.20	244.30	290.70
	190	836.60	244.05	307.10
	251	848.80	242.84	311.80
GSM1900 (GMSK, 1Slot)	512	1850.20	249.26	303.30
	661	1880.00	244.45	301.60
	810	1909.80	246.06	314.70
EGPRS1900 (8PSK, 1Slot)	512	1850.20	246.27	314.40
	661	1880.00	243.10	309.20
	810	1909.80	246.41	304.90
WCDMA Band II (QPSK)	9262	1852.4	4181.30	4676.00
	9400	1880.0	4184.20	4675.00
	9538	1907.6	4173.10	4655.00
WCDMA Band V (QPSK)	4132	826.4	4173.90	4669.00
	4183	836.6	4170.80	4692.00
	4233	846.6	4175.50	4687.00

Test plots as follow:

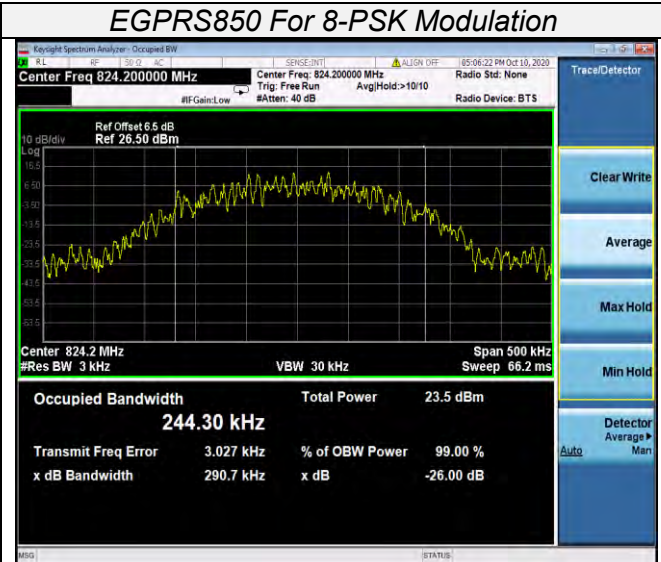
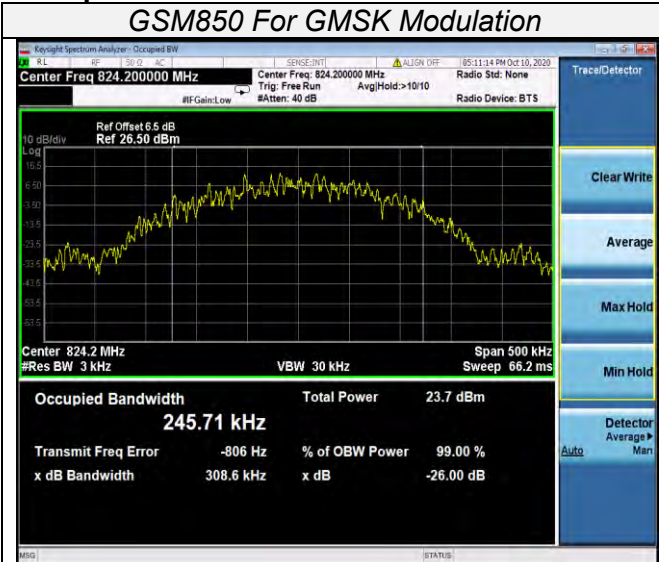

Channel 128

Channel 128

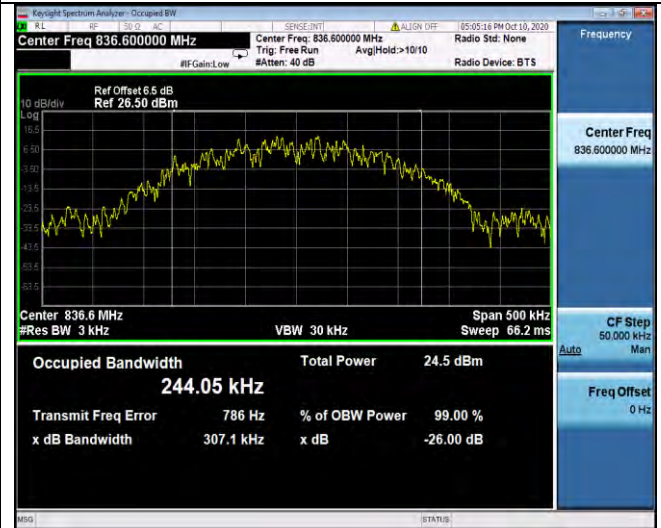
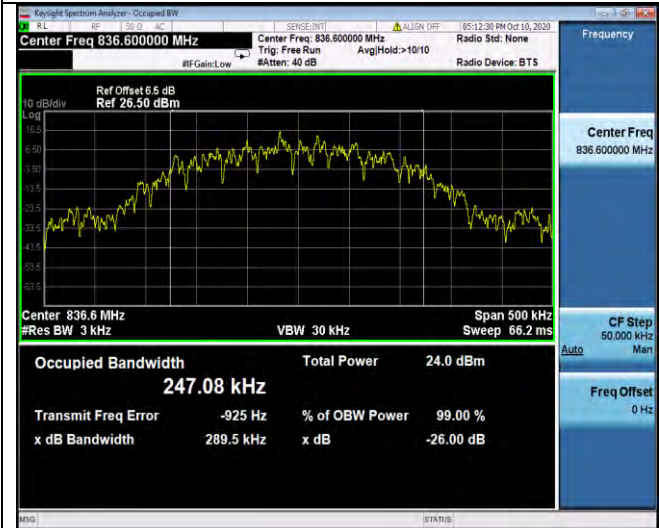

Channel 190

Channel 190

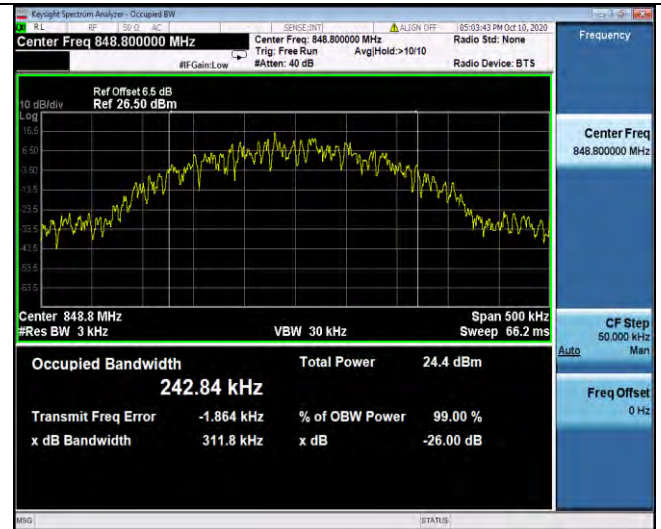
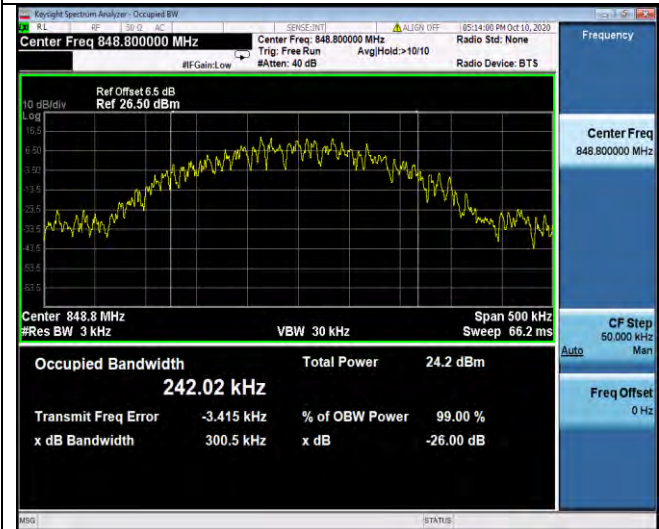

Channel 251

Channel 251

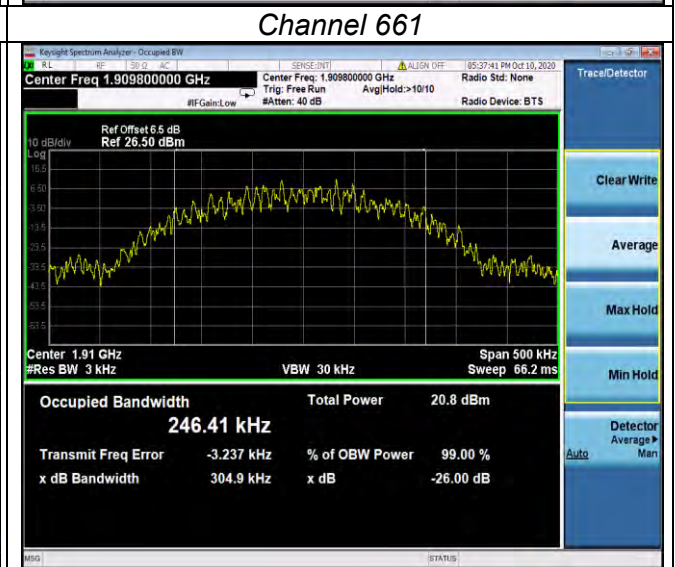
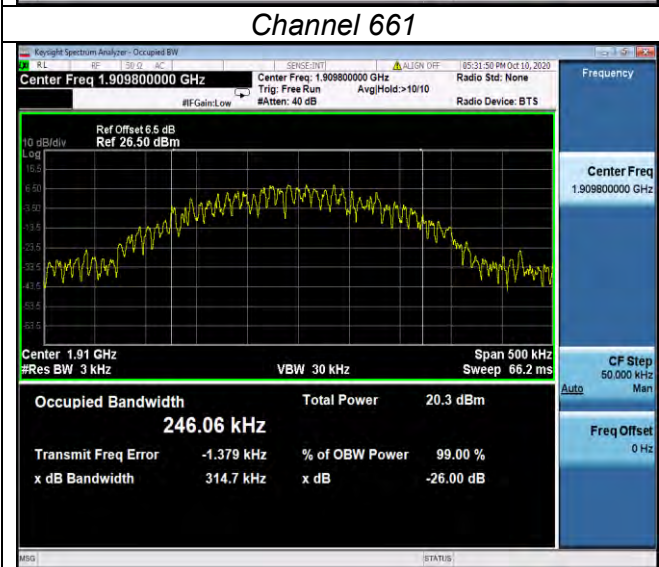
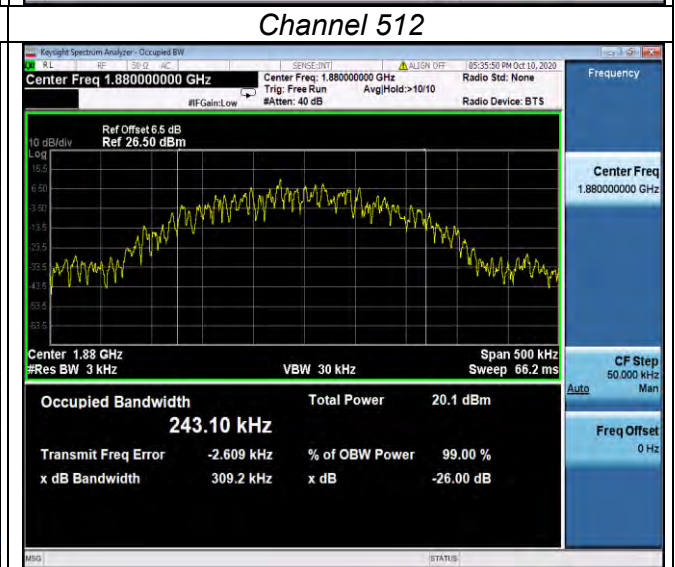
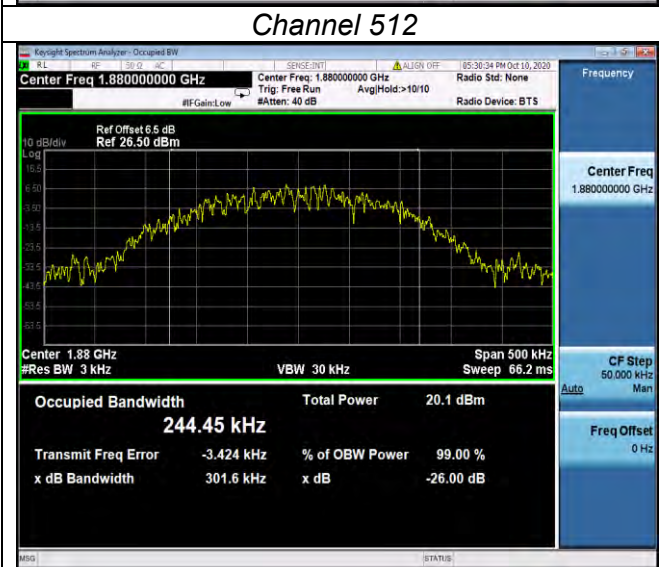
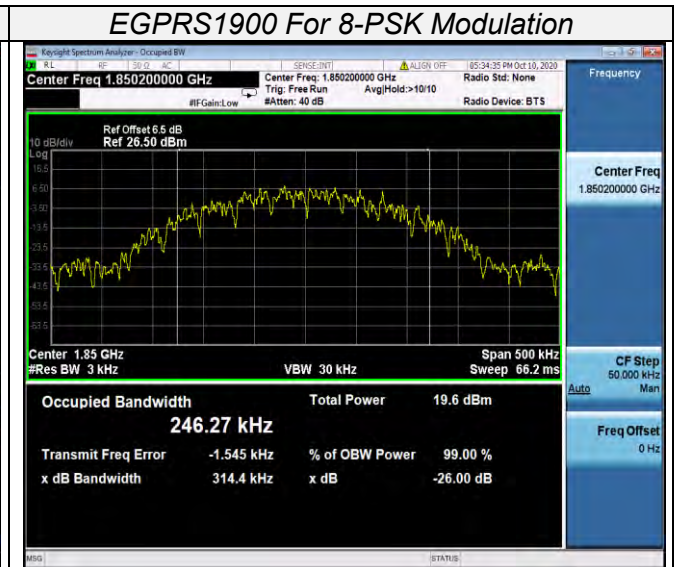
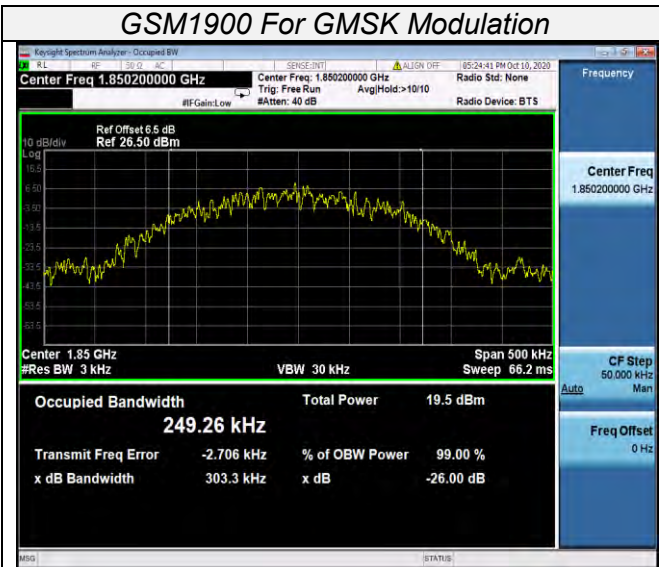

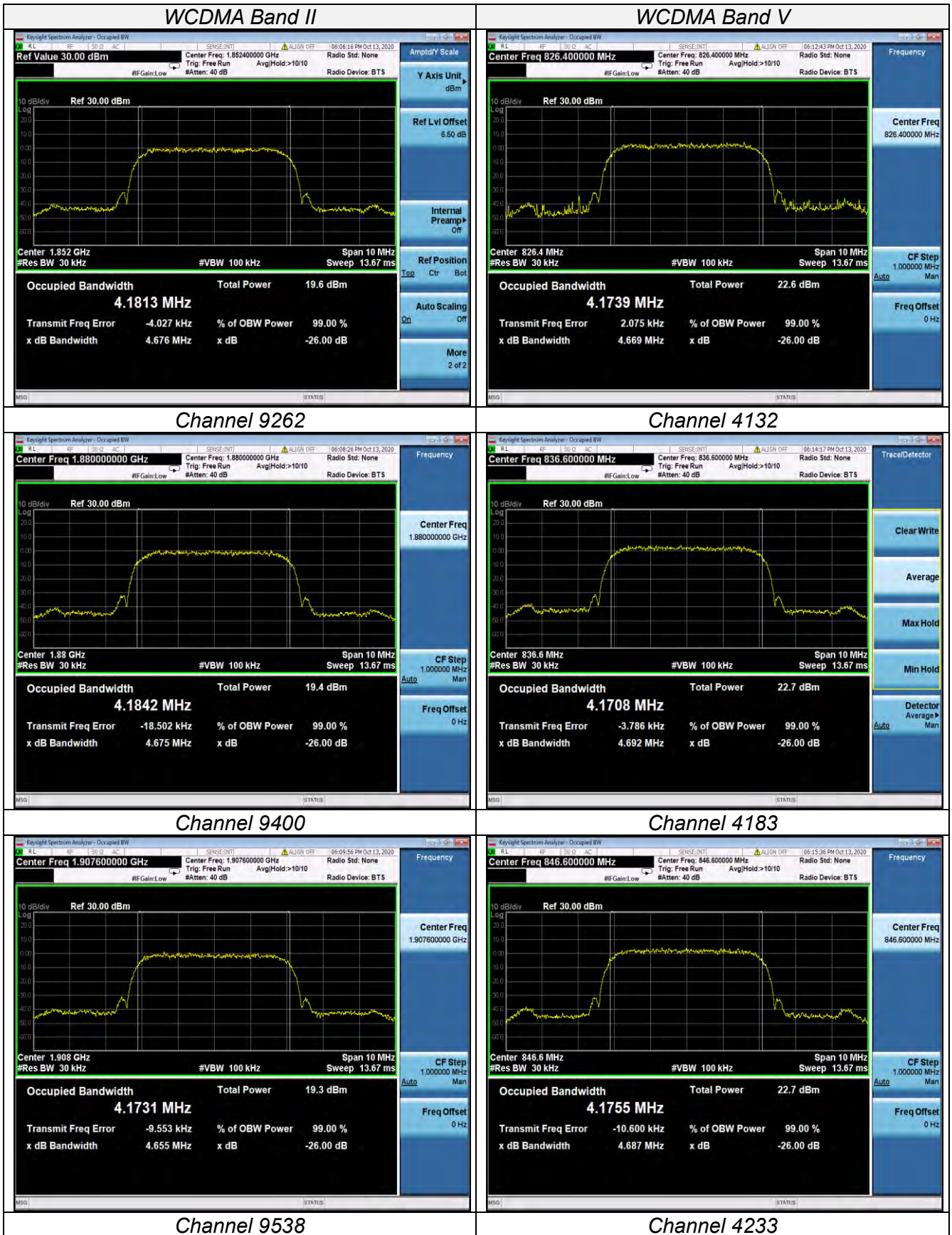

3.3 Band Edge compliance

LIMIT

The power of any emission outside of the authorized operating frequency ranges must be attenuated below the transmitting power (P) by a factor of at least $43 + 10\log(P)$ dB.

TEST CONFIGURATION

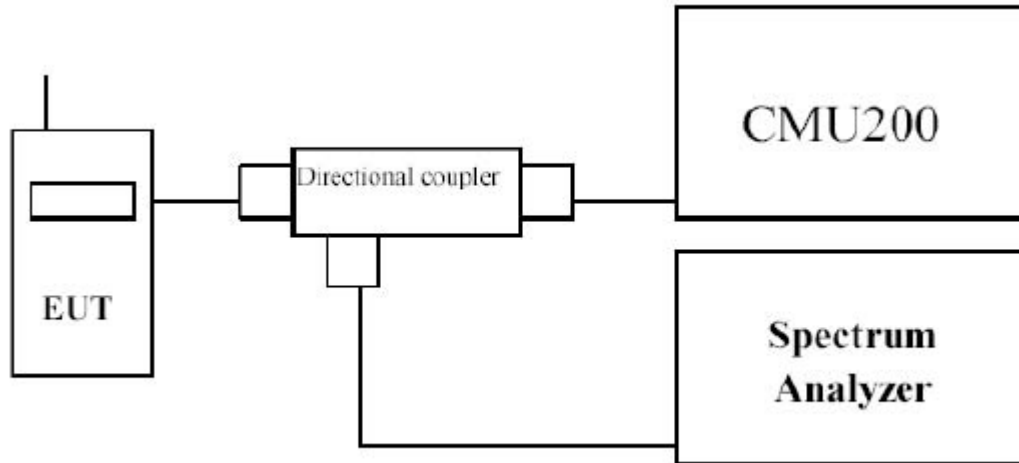

TEST PROCEDURE

In the 1MHz bands immediately outside and adjacent to the frequency block a resolution bandwidth of at least one percent of the emission bandwidth of the fundamental emission of the transmitter may be employed to measure the out of band Emissions.

TEST RESULTS

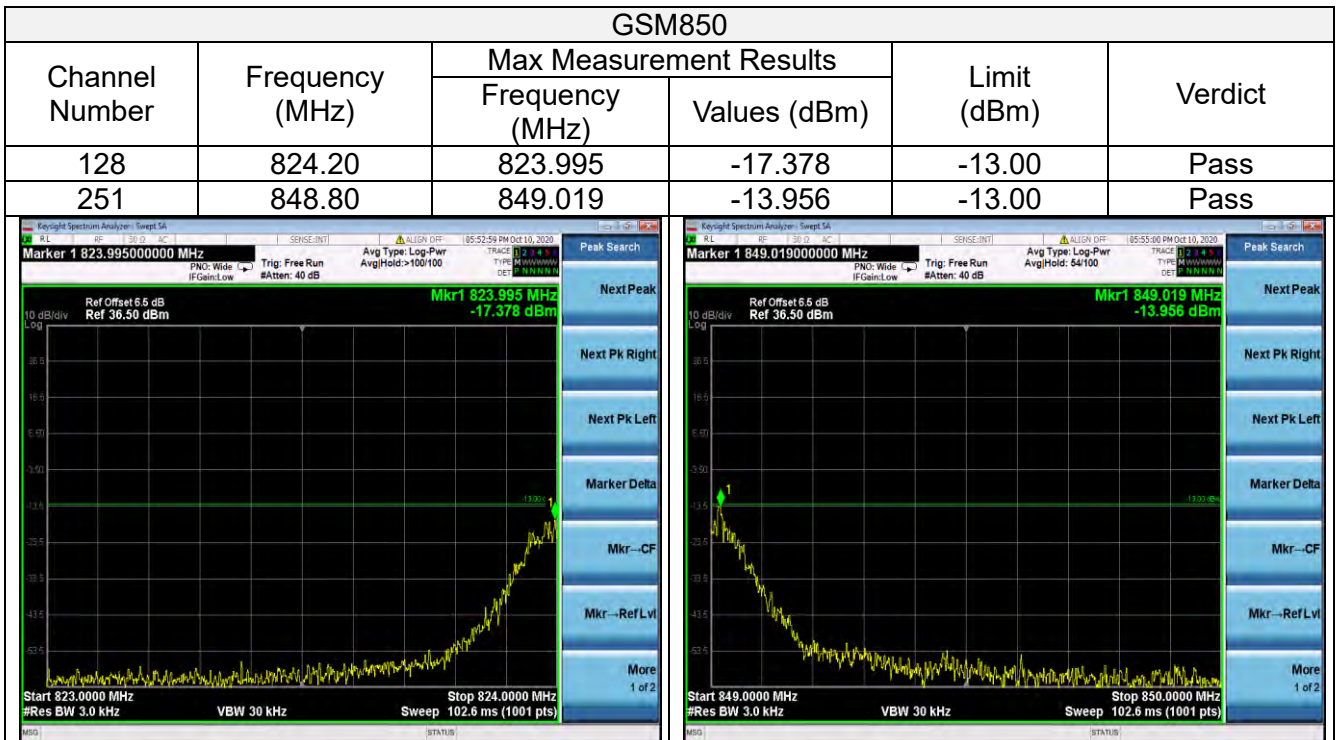

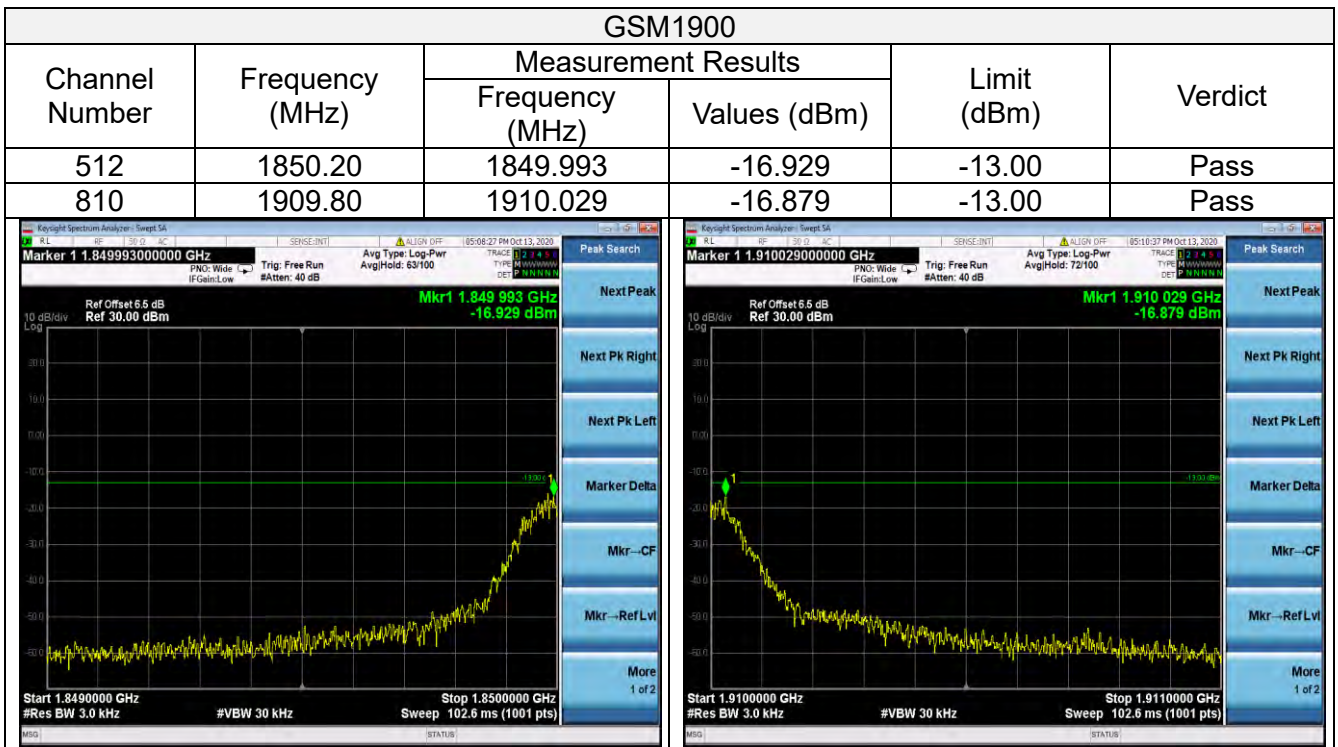
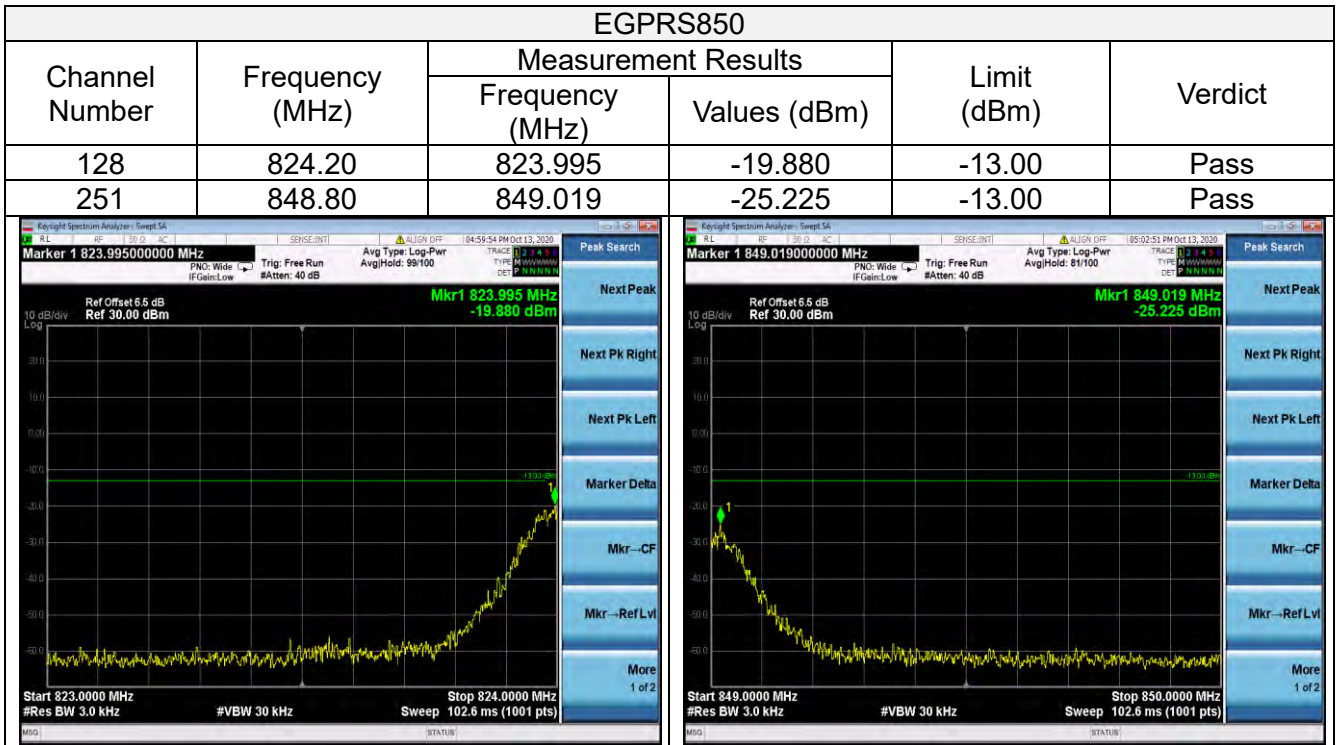

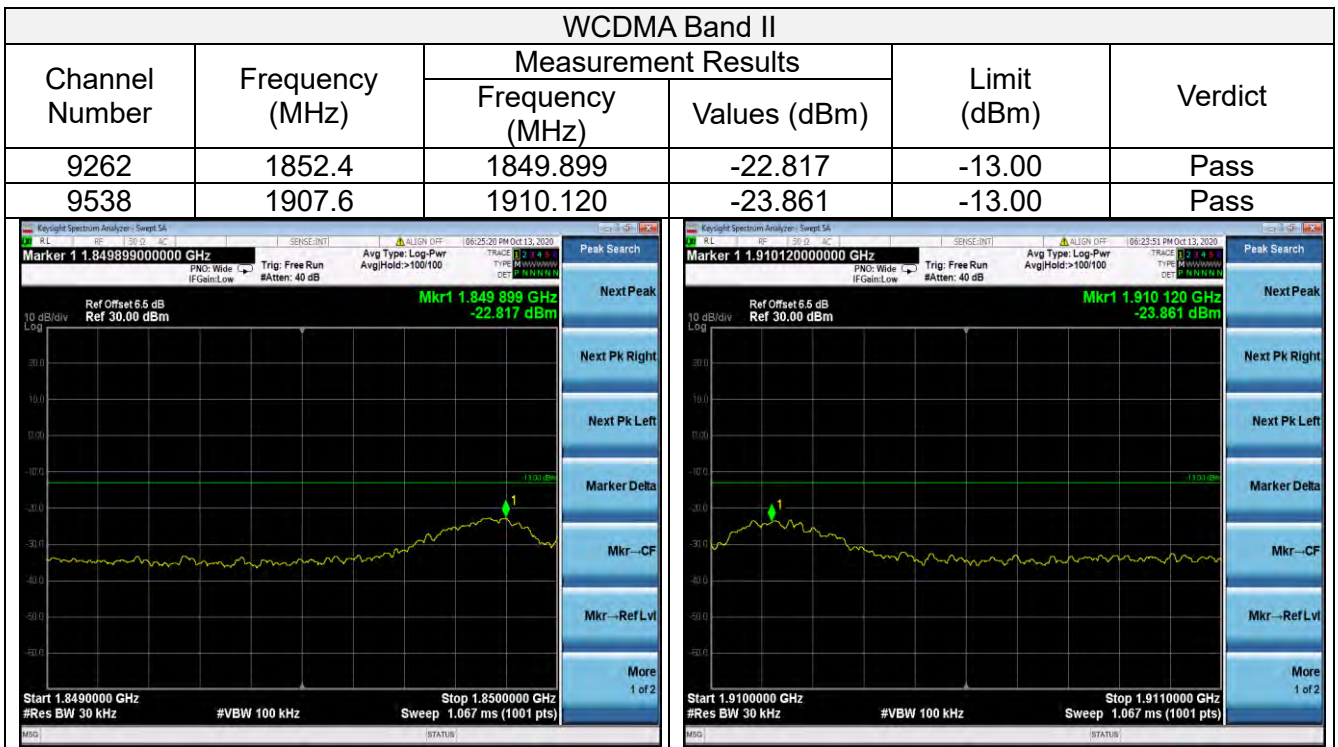
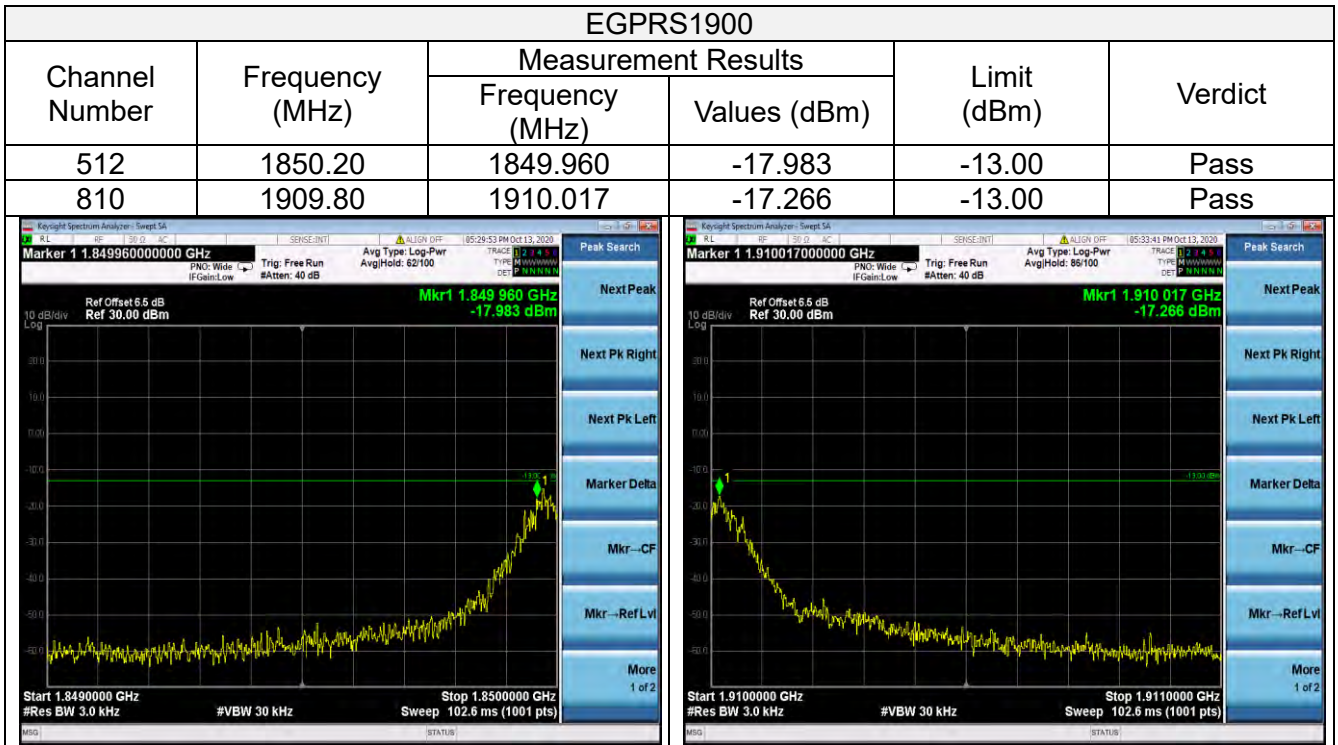

WCDMA Band V					
Channel Number	Frequency (MHz)	Measurement Results		Limit (dBm)	Verdict
		Frequency (MHz)	Values (dBm)		
4132	826.4	823.919	-16.246	-13.00	Pass
4233	846.6	849.155	-26.991	-13.00	Pass

Marker 1 823.91900000 MHz
 Ref Offset: 6.5 dB
 Ref: 30.00 dBm
 Mkr1 823.919 MHz
 -16.246 dBm

Start 823.0000 MHz Stop 824.0000 MHz
 #Res BW 30 kHz #VBW 100 kHz Sweep 1.067 ms (1001 pts)

Marker 1 849.15500000 MHz
 Ref Offset: 6.5 dB
 Ref: 30.00 dBm
 Mkr1 849.155 MHz
 -24.991 dBm

Start 849.0000 MHz Stop 850.0000 MHz
 #Res BW 30 kHz #VBW 100 kHz Sweep 1.067 ms (1001 pts)

3.4 Spurious Emission

LIMIT

The power of any emission outside of the authorized operating frequency ranges must be attenuated below the transmitting power (P) by a factor of at least $43 + 10\log(P)$ dB.

TEST CONFIGURATION

Conducted Spurious Measurement:

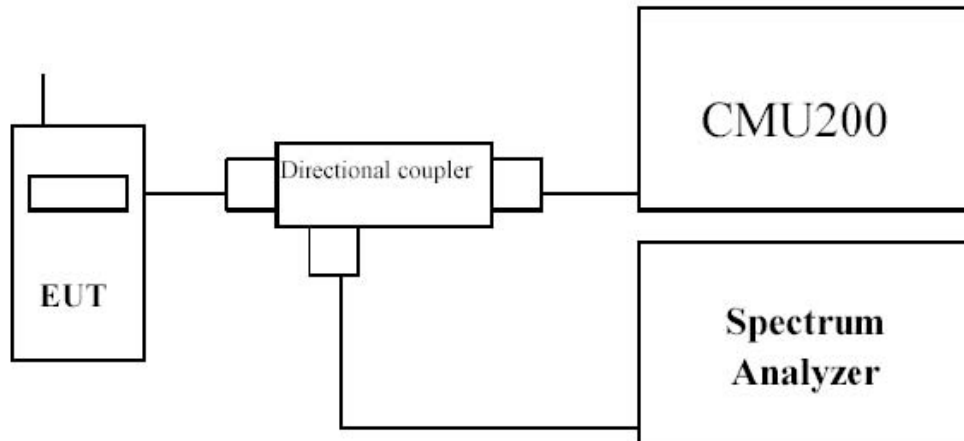

Radiated Spurious Measurement:

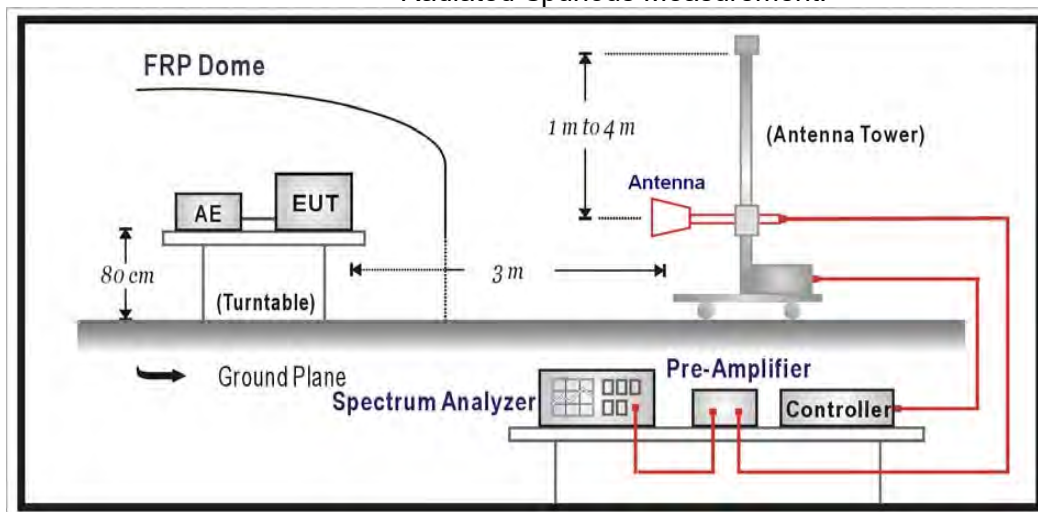

TEST PROCEDURE

The EUT was setup according to EIA/TIA 603C

Conducted Spurious Measurement:

- Place the EUT on a bench and set it in transmitting mode.
- Connect a low loss RF cable from the antenna port to a spectrum analyzer and CMU200 by a Directional Couple.
- EUT Communicate with CMU200 then selects a channel for testing.
- Add a correction factor to the display of spectrum, and then test.
- The resolution bandwidth of the spectrum analyzer was set at 1MHz for Part 22 and 1MHz for Part 24, sufficient scans were taken to show the out of band Emission if any up to 10th harmonic.

Radiated Spurious Measurement:

- a) The EUT shall be placed at the specified height on a support, and in the position closest to normal use as declared by provider.
- b) The test antenna shall be oriented initially for vertical polarization and shall be chosen to correspond to the frequency of the transmitter
- c) The output of the test antenna shall be connected to the measuring receiver.
- d) The transmitter shall be switched on and the measuring receiver shall be tuned to the frequency of the transmitter under test.
- e) The test antenna shall be raised and lowered through the specified range of height until a maximum signal level is detected by the measuring receiver.
- f) The transmitter shall then be rotated through 360° in the horizontal plane, until the maximum signal level is detected by the measuring receiver.
- g) The test antenna shall be raised and lowered again through the specified range of height until a maximum signal level is detected by the measuring receiver.
- h) The maximum signal level detected by the measuring receiver shall be noted.
- i) The transmitter shall be replaced by a substitution antenna.
- j) The substitution antenna shall be orientated for vertical polarization and the length of the substitution antenna shall be adjusted to correspond to the frequency of the transmitter.
- k) The substitution antenna shall be connected to a calibrated signal generator.
- l) If necessary, the input attenuator setting of the measuring receiver shall be adjusted in order to increase the sensitivity of the measuring receiver.
- m) The test antenna shall be raised and lowered through the specified range of height to ensure that the maximum signal is received.
- n) The input signal to the substitution antenna shall be adjusted to the level that produces a level detected by the measuring receiver, that is equal to the level noted while the transmitter radiated power was measured, corrected for the change of input attenuator setting of the measuring receiver.
- o) The measurement shall be repeated with the test antenna and the substitution antenna orientated for horizontal polarization.
- p) The measure of the effective radiated power is the larger of the two levels recorded at the input to the substitution antenna, corrected for gain of the substitution antenna if necessary.
- q) The resolution bandwidth of the spectrum analyzer was set at 100 kHz for Part 22 and 1MHz for Part 24. The frequency range was checked up to 10th harmonic.

TEST RESULTS

Conducted Measurement:

GSM850



GSM1900

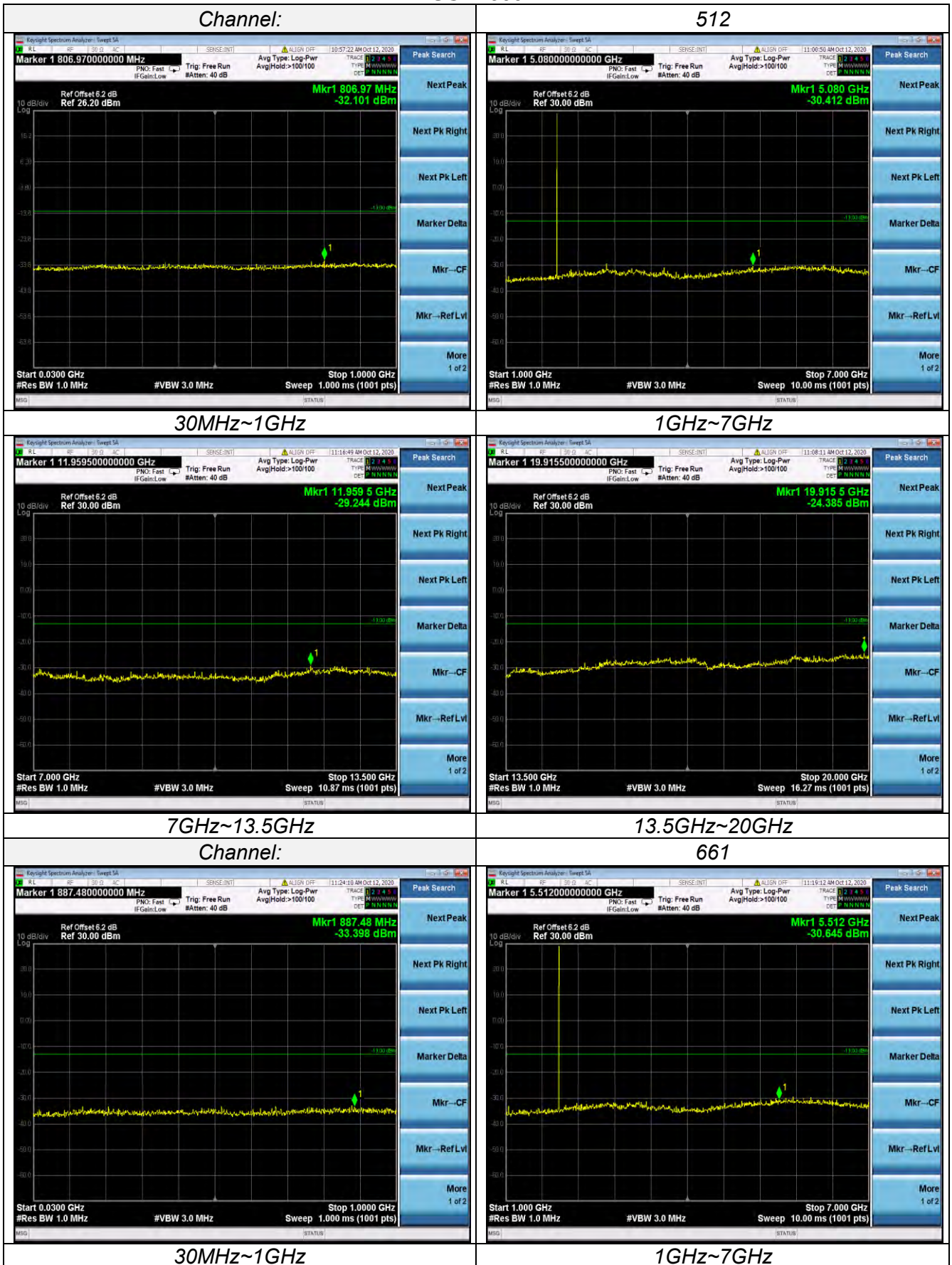

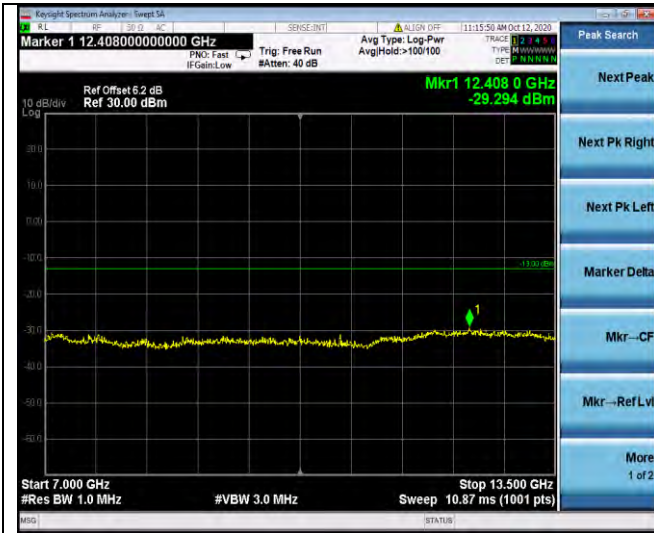

7GHz~13.5GHz

Channel:



13.5GHz~20GHz

810



30MHz~1GHz

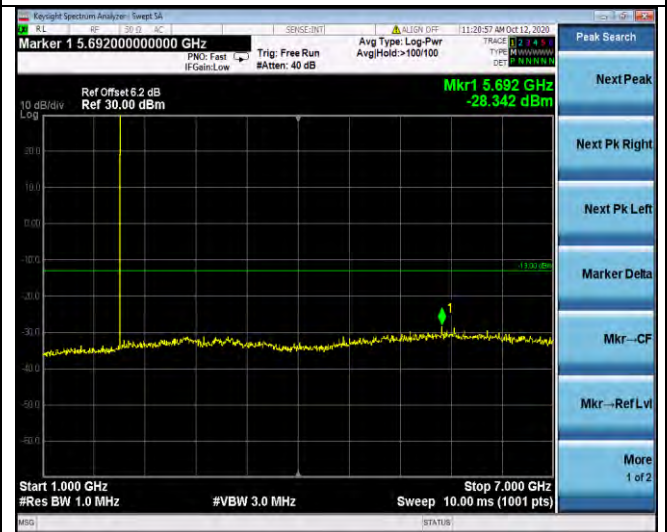

1GHz~7GHz



7GHz~13.5GHz



13.5GHz~20GHz

WCDMA Band II

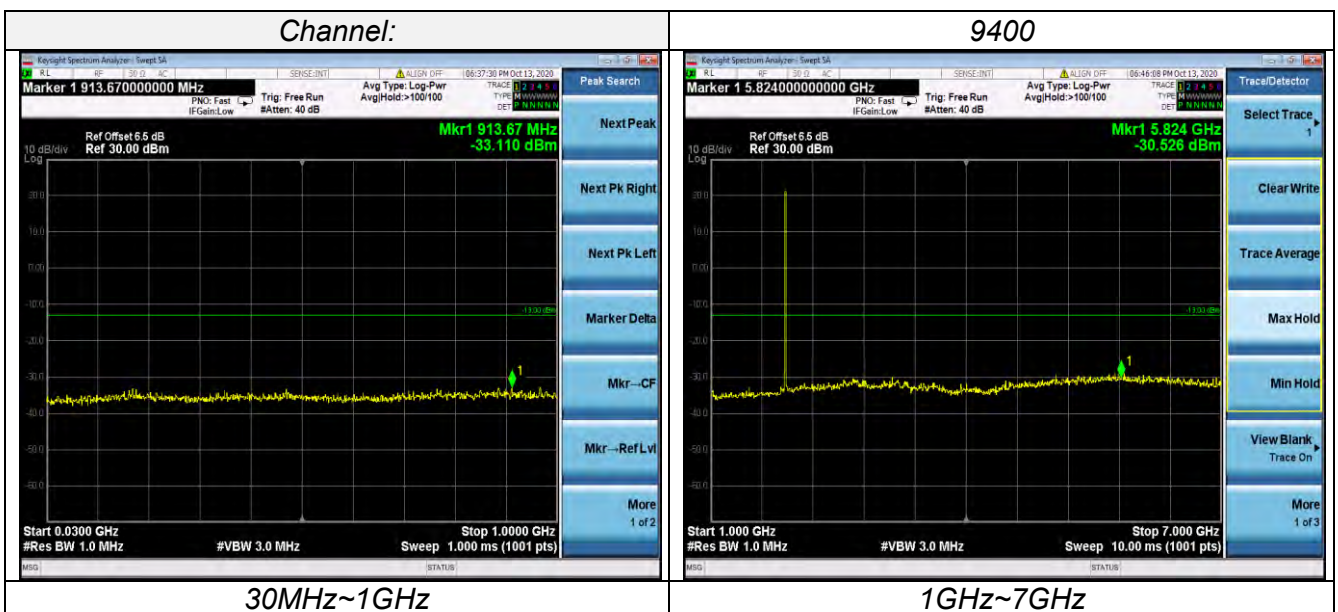
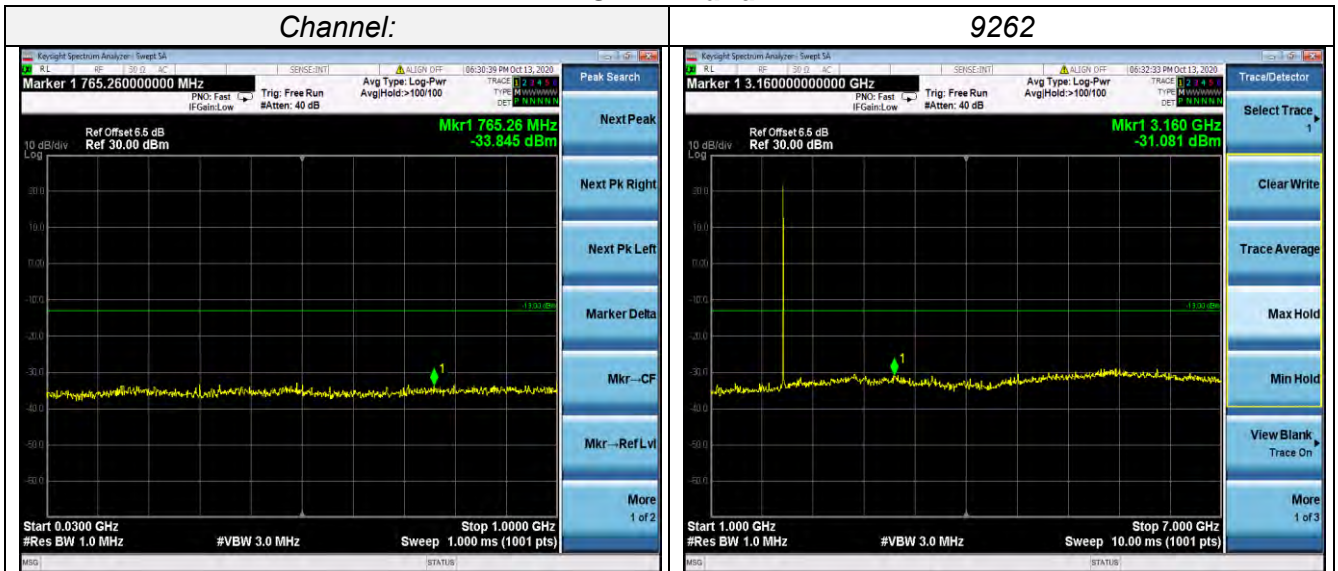



7GHz~13.5GHz

Channel:



13.5GHz~20GHz

9538



30MHz~1GHz



1GHz~7GHz



7GHz~13.5GHz



13.5GHz~20GHz

WCDMA Band V

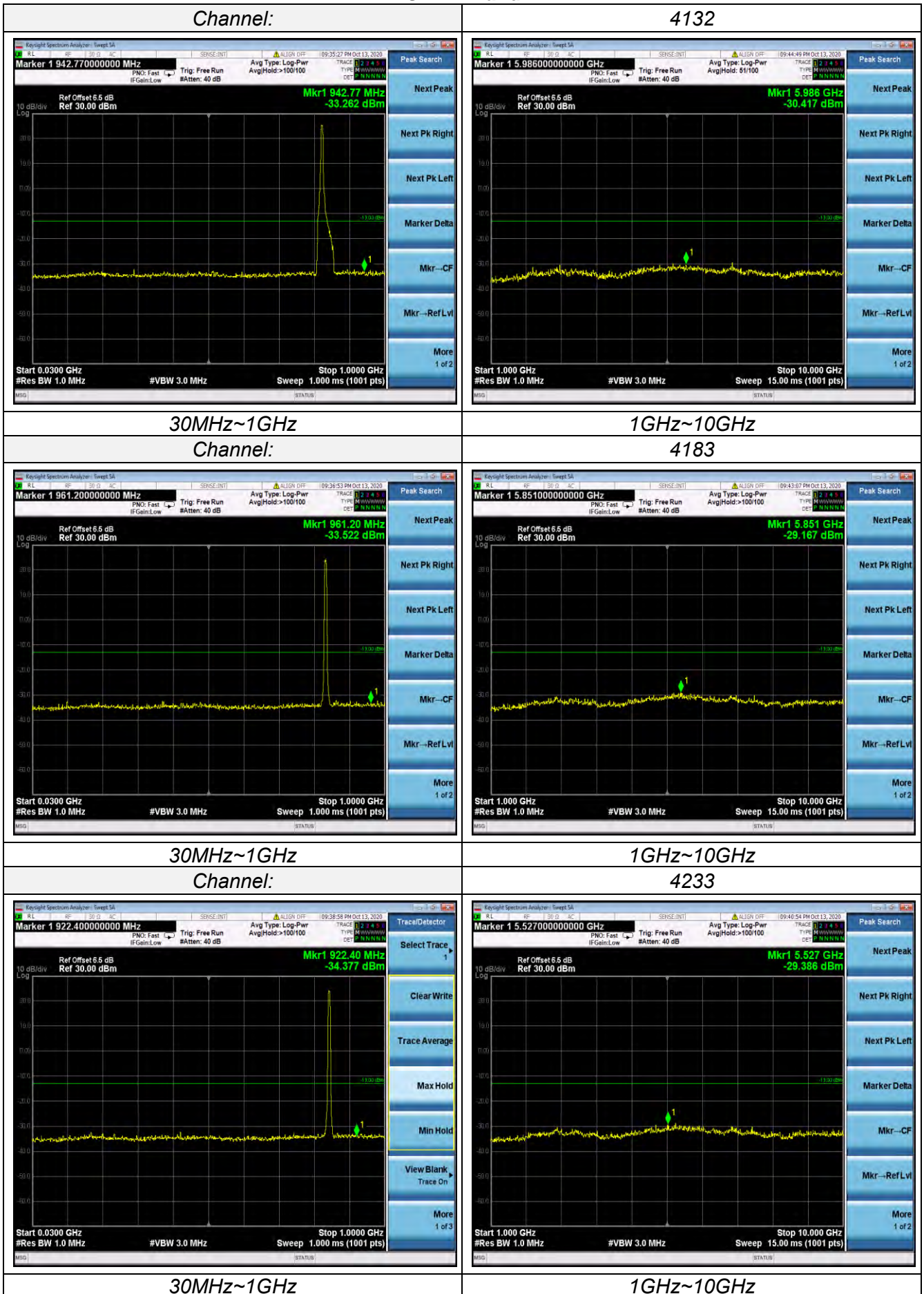

Radiated Measurement:

GSM850

Channel	Frequency (MHz)	P _{Mea} (dBm)	P _{cl} (dB)	Distance	G _a Antenna Gain(dB)	Peak EIRP (dBm)	Limit (dBm)	Margin (dB)	Polarization
128	1648.40	-35.78	3.00	3.00	9.58	-29.20	-13.00	16.20	H
	2472.60	-39.88	3.47	3.00	10.72	-32.63	-13.00	19.63	H
	1648.40	-33.90	3.00	3.00	9.68	-27.22	-13.00	14.22	V
	2472.60	-37.49	3.47	3.00	10.72	-30.24	-13.00	17.24	V
190	1673.20	-35.80	3.14	3.00	9.61	-29.33	-13.00	16.33	H
	2509.80	-40.96	3.59	3.00	10.77	-33.78	-13.00	20.78	H
	1673.20	-33.12	3.14	3.00	9.61	-26.65	-13.00	13.65	V
	2509.80	-38.48	3.59	3.00	10.77	-31.30	-13.00	18.30	V
251	1697.60	-34.88	3.26	3.00	9.77	-28.37	-13.00	15.37	H
	2546.40	-39.39	3.69	3.00	10.89	-32.19	-13.00	19.19	H
	1697.60	-32.31	3.26	3.00	9.77	-25.80	-13.00	12.80	V
	2546.40	-37.68	3.69	3.00	10.89	-30.48	-13.00	17.48	V

EGPRS850

Channel	Frequency (MHz)	P _{Mea} (dBm)	P _{cl} (dB)	Distance	G _a Antenna Gain(dB)	Peak EIRP (dBm)	Limit (dBm)	Margin (dB)	Polarization
128	1648.40	-36.04	3.00	3.00	9.58	-29.46	-13.00	16.46	H
	2472.60	-39.94	3.47	3.00	10.72	-32.69	-13.00	19.69	H
	1648.40	-33.51	3.00	3.00	9.68	-26.83	-13.00	13.83	V
	2472.60	-38.11	3.47	3.00	10.72	-30.86	-13.00	17.86	V
190	1673.20	-35.69	3.14	3.00	9.61	-29.22	-13.00	16.22	H
	2509.80	-40.53	3.59	3.00	10.77	-33.35	-13.00	20.35	H
	1673.20	-32.91	3.14	3.00	9.61	-26.44	-13.00	13.44	V
	2509.80	-38.41	3.59	3.00	10.77	-31.23	-13.00	18.23	V
251	1697.60	-34.68	3.26	3.00	9.77	-28.17	-13.00	15.17	H
	2546.40	-40.79	3.69	3.00	10.89	-33.59	-13.00	20.59	H
	1697.60	-33.11	3.26	3.00	9.77	-26.60	-13.00	13.60	V
	2546.40	-38.34	3.69	3.00	10.89	-31.14	-13.00	18.14	V

GSM1900

Channel	Frequency (MHz)	P _{Mea} (dBm)	P _{cl} (dB)	Distance	G _a Antenna Gain(dB)	Peak EIRP (dBm)	Limit (dBm)	Margin (dB)	Polarization
512	3700.40	-39.03	4.25	3.00	12.34	-30.94	-13.00	17.94	H
	5550.60	-44.23	4.97	3.00	13.52	-35.68	-13.00	22.68	H
	3700.40	-36.53	4.25	3.00	12.34	-28.44	-13.00	15.44	V
	5550.60	-41.81	4.97	3.00	13.52	-33.26	-13.00	20.26	V
661	3760.00	-39.32	4.38	3.00	12.34	-31.36	-13.00	18.36	H
	5640.00	-43.33	5.01	3.00	13.58	-34.76	-13.00	21.76	H
	3760.00	-37.48	4.38	3.00	12.34	-29.52	-13.00	16.52	V
	5640.00	-41.65	5.01	3.00	13.58	-33.08	-13.00	20.08	V
810	3819.60	-38.18	4.49	3.00	12.45	-30.22	-13.00	17.22	H
	5729.40	-42.97	5.26	3.00	13.66	-34.57	-13.00	21.57	H
	3819.60	-36.35	4.49	3.00	12.45	-28.39	-13.00	15.39	V
	5729.40	-40.49	5.26	3.00	13.66	-32.09	-13.00	19.09	V

EGPRS1900

Channel	Frequency (MHz)	P _{Mea} (dBm)	P _{cl} (dB)	Diatance	G _a Antenna Gain(dB)	Peak EIRP (dBm)	Limit (dBm)	Margin (dB)	Polarization
512	3700.40	-38.39	4.25	3.00	12.34	-30.30	-13.00	17.30	H
	5550.60	-43.95	4.97	3.00	13.52	-35.40	-13.00	22.40	H
	3700.40	-36.89	4.25	3.00	12.34	-28.80	-13.00	15.80	V
	5550.60	-41.86	4.97	3.00	13.52	-33.31	-13.00	20.31	V
661	3760.00	-39.69	4.38	3.00	12.34	-31.73	-13.00	18.73	H
	5640.00	-42.82	5.01	3.00	13.58	-34.25	-13.00	21.25	H
	3760.00	-37.77	4.38	3.00	12.34	-29.81	-13.00	16.81	V
	5640.00	-40.99	5.01	3.00	13.58	-32.42	-13.00	19.42	V
810	3819.60	-37.98	4.49	3.00	12.45	-30.02	-13.00	17.02	H
	5729.40	-42.75	5.26	3.00	13.66	-34.35	-13.00	21.35	H
	3819.60	-35.26	4.49	3.00	12.45	-27.30	-13.00	14.30	V
	5729.40	-40.55	5.26	3.00	13.66	-32.15	-13.00	19.15	V

WCDMA Band II

Channel	Frequency (MHz)	P _{Mea} (dBm)	P _{cl} (dB)	Diatance	G _a Antenna Gain(dB)	Peak EIRP (dBm)	Limit (dBm)	Margin (dB)	Polarization
9262	3704.80	-39.44	4.27	3.00	12.34	-31.37	-13.00	18.37	H
	5557.20	-44.30	4.99	3.00	13.52	-35.77	-13.00	22.77	H
	3704.80	-37.77	4.27	3.00	12.34	-29.70	-13.00	16.70	V
	5557.20	-41.63	4.99	3.00	13.52	-33.10	-13.00	20.10	V
9400	3760.00	-39.94	4.38	3.00	12.34	-31.98	-13.00	18.98	H
	5640.00	-43.93	5.01	3.00	13.58	-35.36	-13.00	22.36	H
	3760.00	-38.15	4.38	3.00	12.34	-30.19	-13.00	17.19	V
	5640.00	-42.04	5.01	3.00	13.58	-33.47	-13.00	20.47	V
9538	3815.20	-38.39	4.47	3.00	12.45	-30.41	-13.00	17.41	H
	5722.80	-42.85	5.23	3.00	13.66	-34.42	-13.00	21.42	H
	3815.20	-36.07	4.47	3.00	12.45	-28.09	-13.00	15.09	V
	5722.80	-40.47	5.23	3.00	13.66	-32.04	-13.00	19.04	V

WCDMA Band V

Channel	Frequency (MHz)	P _{Mea} (dBm)	P _{cl} (dB)	Diatance	G _a Antenna Gain(dB)	Peak EIRP (dBm)	Limit (dBm)	Margin (dB)	Polarization
9262	1652.80	-35.03	3.02	3.00	9.58	-28.47	-13.00	15.47	H
	2479.20	-40.97	3.51	3.00	10.72	-33.76	-13.00	20.76	H
	1652.80	-33.24	3.02	3.00	9.68	-26.58	-13.00	13.58	V
	2479.20	-38.65	3.51	3.00	10.72	-31.44	-13.00	18.44	V
9400	1673.20	-35.63	3.14	3.00	9.61	-29.16	-13.00	16.16	H
	2509.80	-40.18	3.59	3.00	10.77	-33.00	-13.00	20.00	H
	1673.20	-33.56	3.14	3.00	9.61	-27.09	-13.00	14.09	V
	2509.80	-38.14	3.59	3.00	10.77	-30.96	-13.00	17.96	V
9538	1693.20	-34.82	3.24	3.00	9.77	-28.29	-13.00	15.29	H
	2539.80	-39.31	3.65	3.00	10.89	-32.07	-13.00	19.07	H
	1693.20	-32.85	3.24	3.00	9.77	-26.32	-13.00	13.32	V
	2539.80	-37.34	3.65	3.00	10.89	-30.10	-13.00	17.10	V

Remark:

1. $EIRP = P_{Mea}(dBm) - P_{cl}(dB) + G_a(dBi)$
2. We were not recorded other points as values lower than limits.
3. $Margin = Limit - EIRP$

3.5 Peak-to-Average Ratio (PAR)

LIMIT

The Peak-to-Average Ratio (PAR) of the transmission may not exceed 13 dB.

TEST CONFIGURATION

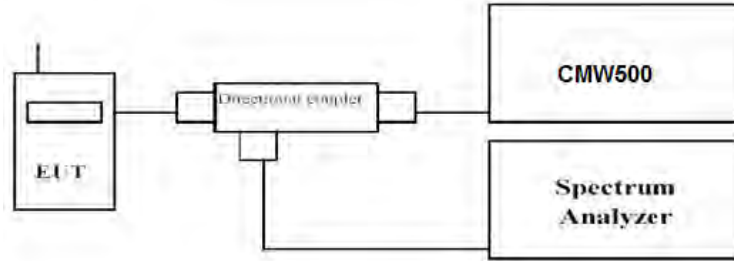

TEST PROCEDURE

1. Refer to instrument's analyzer instruction manual for details on how to use the power statistics/CCDF function;
2. Set resolution/measurement bandwidth \geq signal's occupied bandwidth;
3. Set the number of counts to a value that stabilizes the measured CCDF curve;
4. Set the measurement interval as follows: 1). for continuous transmissions, set to 1 ms, 2). for burst transmissions, employ an external trigger that is synchronized with the EUT burst timing sequence, or use the internal burst trigger with a trigger level that allows the burst to stabilize and set the measurement interval to a time that is less than or equal to the burst duration.
5. Record the maximum PAPR level associated with a probability of 0.1%.

TEST RESULTS

Test mode	Channel	Frequency (MHz)	PAPR Value (dB)	Limits (dB)	Verdict
GSM850	128	824.2	0.89	13.0	Pass
	190	836.6	0.94	13.0	Pass
	251	848.8	0.34	13.0	Pass
EGPRS850	128	824.2	3.80	13.0	Pass
	190	836.6	3.87	13.0	Pass
	251	848.8	3.79	13.0	Pass
PCS1900	512	1850.2	0.65	13.0	Pass
	661	1880.0	0.94	13.0	Pass
	810	1909.8	0.67	13.0	Pass
EGPRS1900	512	1850.2	3.61	13.0	Pass
	661	1880.0	3.45	13.0	Pass
	810	1909.8	3.75	13.0	Pass
WCDMA Band II	9262	1852.4	3.56	13.0	Pass
	9400	1880.0	3.66	13.0	Pass
	9538	1907.6	3.36	13.0	Pass
WCDMA Band V	4132	826.4	3.72	13.0	Pass
	4183	836.6	3.25	13.0	Pass
	4233	846.6	3.47	13.0	Pass

3.6 Frequency Stability under Temperature & Voltage Variations

LIMIT

Cellular Band: ± 2.5 ppm PCS Band: Within the authorized frequency block

TEST CONFIGURATION

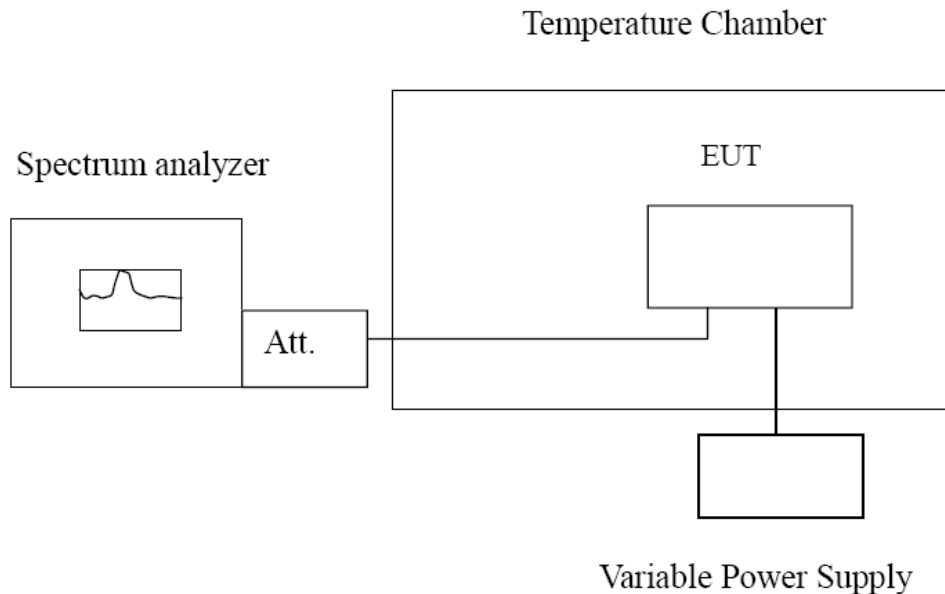

TEST PROCEDURE

The EUT was setup according to EIA/TIA 603C

Frequency Stability under Temperature Variations:

The equipment under test was connected to an external AC or DC power supply and input rated voltage. RF output was connected to a frequency counter or spectrum analyzer via feed through attenuators. The EUT was placed inside the temperature chamber. Set the spectrum analyzer RBW low enough to obtain the desired frequency resolution and measure EUT 20°C operating frequency as reference frequency. Turn EUT off and set the chamber temperature to -30°C. After the temperature stabilized for approximately 30 minutes recorded the frequency. Repeat step measure with 10°C increased per stage until the highest temperature of +50°C reached.

Frequency Stability under Voltage Variations:

Set chamber temperature to 20°C. Use a variable AC power supply / DC power source to power the EUT and set the voltage to rated voltage. Set the spectrum analyzer RBW low enough to obtain the desired frequency resolution and recorded the frequency.

Reduce the input voltage to specify extreme voltage variation ($\pm 15\%$) and endpoint, record the maximum frequency change.

TEST RESULTS

Reference Frequency: GSM850 Middle channel=190 channel=836.6MHz					
Voltage (V)	Temperature (°C)	Frequency error		Limit (ppm)	Result
		Hz	ppm		
3.85	-30	59.53	0.071	±2.5	Pass
	-20	46.85	0.056		
	-10	85.98	0.103		
	0	81.70	0.098		
	10	39.17	0.047		
	20	52.37	0.063		
	30	95.91	0.115		
	40	67.18	0.080		
4.43	25	59.55	0.071		
End point 3.27	25	70.01	0.084		

Reference Frequency: PCS1900 Middle channel=661 channel=1880MHz					
Voltage (V)	Temperature (°C)	Frequency error		Limit (ppm)	Result
		Hz	ppm		
3.85	-30	95.90	0.051	Within the authorized frequency block	Pass
	-20	79.43	0.042		
	-10	59.11	0.031		
	0	80.46	0.043		
	10	96.01	0.051		
	20	76.28	0.041		
	30	98.40	0.052		
	40	32.29	0.017		
4.43	25	61.40	0.033		
End point 3.27	25	82.95	0.044		

Reference Frequency: WCDMA Band II Middle channel=9400 channel=1880MHz					
Voltage (V)	Temperature (°C)	Frequency error		Limit (ppm)	Result
		Hz	ppm		
3.85	-30	86.42	0.046	Within the authorized frequency block	Pass
	-20	93.20	0.050		
	-10	60.27	0.032		
	0	37.43	0.020		
	10	86.47	0.046		
	20	85.90	0.046		
	30	93.98	0.050		
	40	97.02	0.052		
4.43	25	83.26	0.044		
End point 3.27	25	76.92	0.041		

Reference Frequency: WCDMA Band V Middle channel=4182 channel=836.6MHz					
Voltage (V)	Temperature (°C)	Frequency error		Limit (ppm)	Result
		Hz	ppm		
3.85	-30	98.45	0.118	± 2.5	Pass
	-20	54.10	0.065		
	-10	98.89	0.118		
	0	99.78	0.119		
	10	55.91	0.067		
	20	58.68	0.070		
	30	34.10	0.041		
	40	36.51	0.044		
	50	67.49	0.081		
4.43	25	45.28	0.054		
End point 3.27	25	85.25	0.102		

4 Test Setup Photos of the EUT

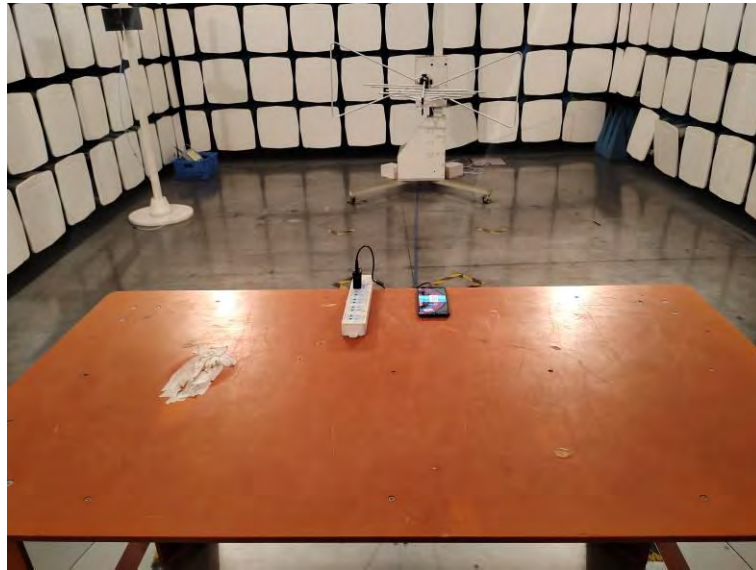

5 External and Internal Photos of the EUT

External Photos of EUT

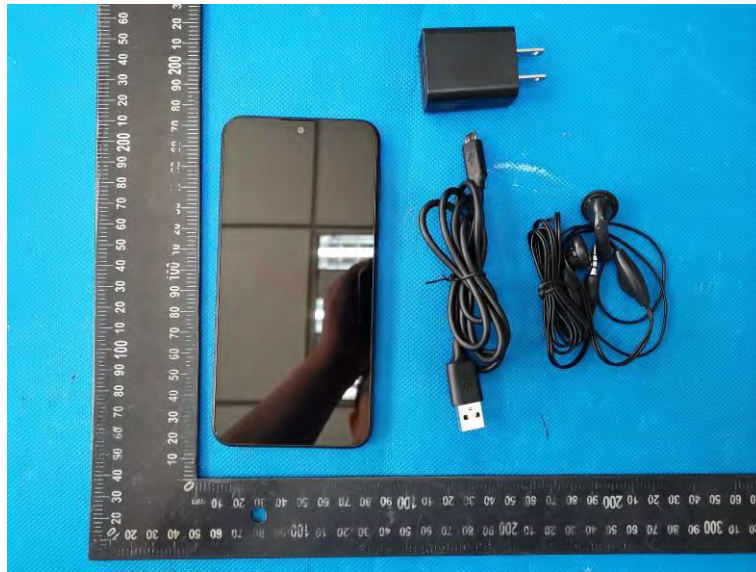





Internal Photos of EUT



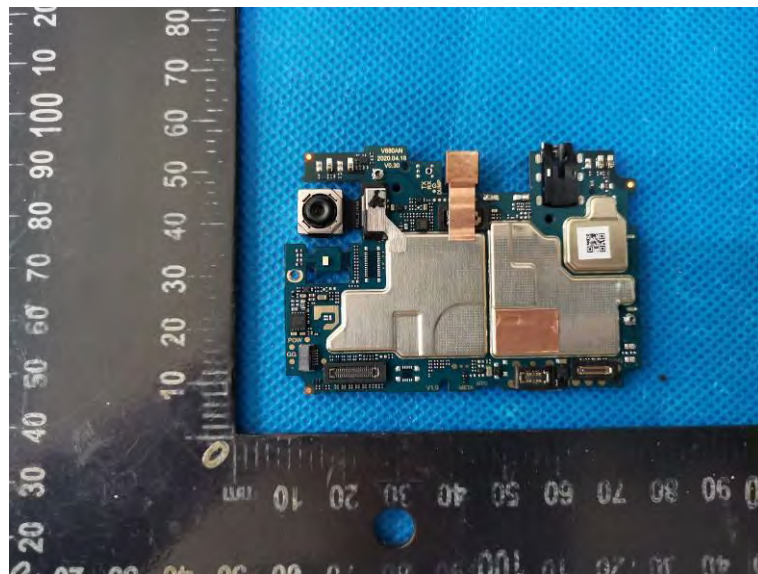
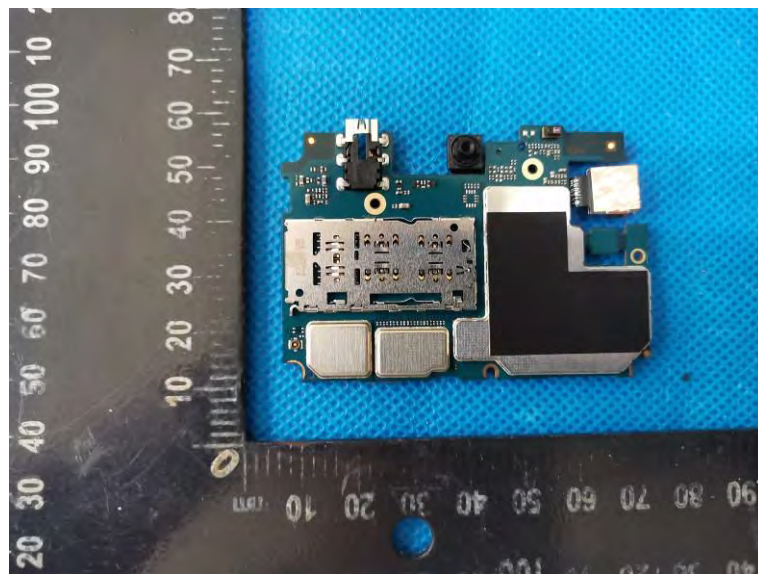
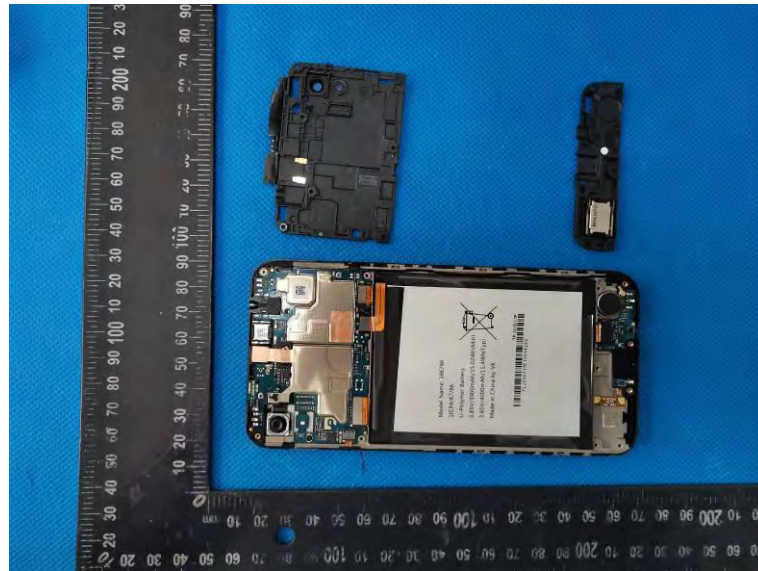

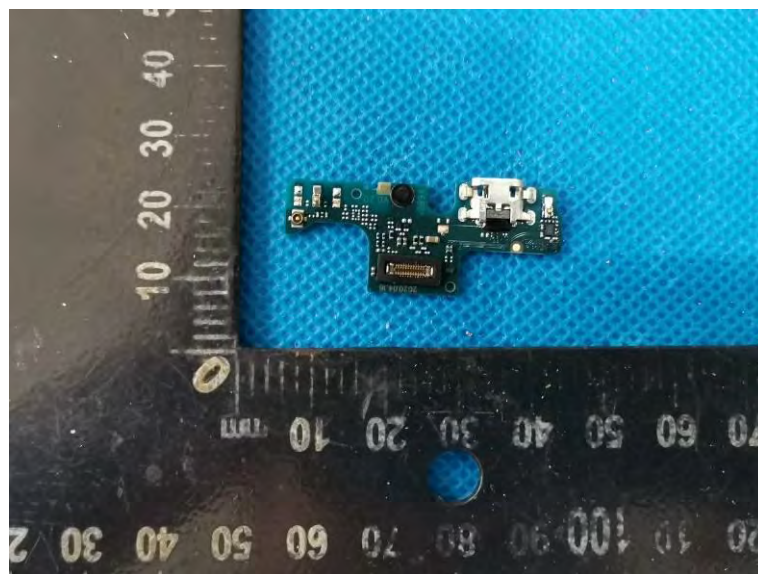
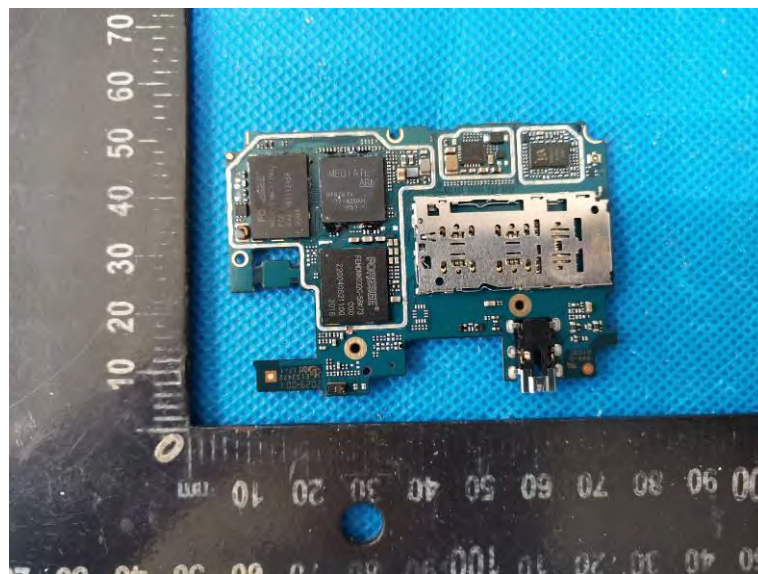
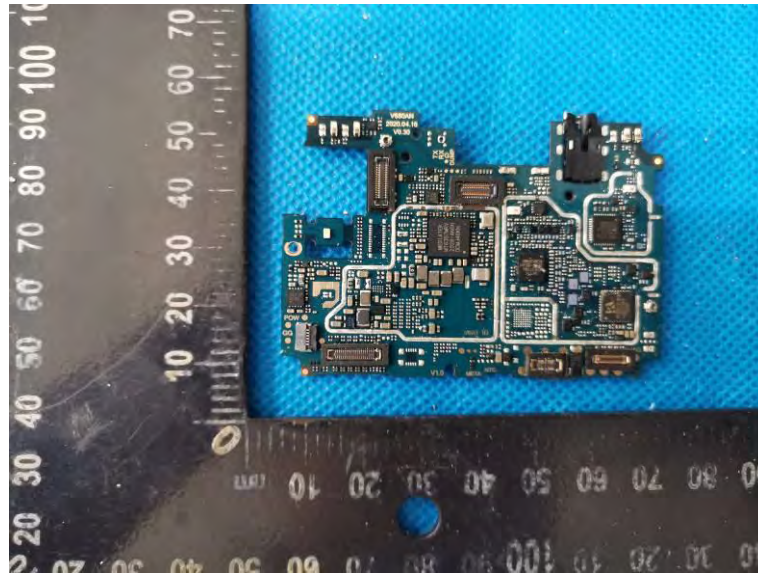

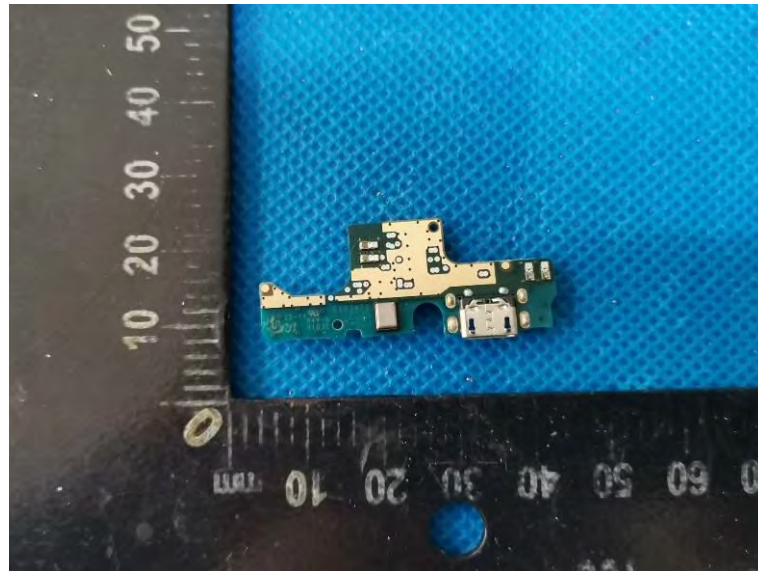

***** End of Report *****