

FCC PART 27 TEST REPORT

FCC Part 27

Report Reference No.....: MWR151101110
FCC ID.....: RQQHLT-L50SCM
 Compiled by
 (position+printed name+signature)..: File administrators Martin Ao
 Supervised by
 (position+printed name+signature)..: Test Engineer Yuchao Wang
 Approved by
 (position+printed name+signature)..: Manager Dixon Hao
 Date of issue.....: Nov. 01, 2015







Representative Laboratory Name ..: Maxwell International Co., Ltd.
 Address: Room 509, Hongfa center building, Baoan District, Shenzhen, Guangdong, China

Testing Laboratory Name Shenzhen CTL Testing Technology Co., Ltd.
 Address: Floor 1-A, Baisha Technology Park, No.3011, Shahehexi Road, Nanshan District, Shenzhen, China 518055

Applicant's name HYUNDAI CORPORATION
 Address: 140-2, Kye-dong, Chongro-ku, Seoul, South Korea

Test specification
FCC CFR Title 47 Part 2, Part 27
 Standard: EIA/TIA 603-D: 2010
 KDB 971168 D01
 TRF Originator.....: Maxwell International Co., Ltd.

Maxwell International Co., Ltd. All rights reserved.
 This publication may be reproduced in whole or in part for non-commercial purposes as long as the Maxwell International Co., Ltd. as copyright owner and source of the material. Maxwell International Co., Ltd. takes no responsibility for and will not assume liability for damages resulting from the reader's interpretation of the reproduced material due to its placement and context.

Test item description Mobile Phone
 Trade Mark: HYUNDAI
Manufacturer Skycom Telecommunications Co., Limited
 Model/Type reference.....: L505
 Listed Models: N/A
 Modulation Type: QPSK, 16QAM
 Rating: DC 3.70V
 Hardware version: WW818-MB-V0.5
 Software version: HYUNDAI_L505_V4.0.3
 Result.....: **PASS**

TEST REPORT

Test Report No. :	MWR150900710	Nov. 01, 2015
		Date of issue

Equipment under Test : Mobile Phone

Model /Type : L505

Listed Models : N/A

Applicant : **HYUNDAI CORPORATION**

Address : 140-2, Kye-dong, Chongro-ku, Seoul, South Korea

Manufacturer : **Skycom Telecommunications Co., Limited**

Address : Rm604, East Block, Shengtang Bldg., No.1, Tairan 9 Rd.,
Chegongmiao, Futian District, Shenzhen, China

Test Result:	PASS
---------------------	-------------

The test report merely corresponds to the test sample.

It is not permitted to copy extracts of these test result without the written permission of the test laboratory.

Contents

1.	<u>TEST STANDARDS</u>	4
2.	<u>SUMMARY</u>	5
2.1.	General Remarks	5
2.2.	Product Description	5
2.3.	Equipment under Test	6
2.4.	Short description of the Equipment under Test (EUT)	6
2.5.	Internal Identification of AE used during the test	6
2.6.	Normal Accessory setting	6
2.7.	EUT configuration	6
2.8.	Related Submittal(s) / Grant (s)	6
2.9.	Modifications	7
2.10.	General Test Conditions/Configurations	7
3.	<u>TEST ENVIRONMENT</u>	8
3.1.	Address of the test laboratory	8
3.2.	Test Facility	8
3.3.	Environmental conditions	8
3.4.	Test Description	8
3.5.	Equipments Used during the Test	9
4.	<u>TEST CONDITIONS AND RESULTS</u>	10
4.1.	Output Power	10
4.2.	Peak-to-Average Ratio (PAR)	14
4.3.	Occupied Bandwidth and Emission Bandwidth	17
4.4.	Band Edge compliance	20
4.5.	Spurious Emssion on Antenna Port	23
4.6.	Radiated Spurious Emssion	30
4.7.	Frequency Stability under Temperature & Voltage Variations	34
5.	<u>TEST SETUP PHOTOS OF THE EUT</u>	36
6.	<u>EXTERNAL PHOTOS OF THE EUT</u>	36
7.	<u>INTERNAL PHOTOS OF THE EUT</u>	36

1. TEST STANDARDS

The tests were performed according to following standards:

[FCC Part 27\(10-1-12 Edition\)](#): MISCELLANEOUS WIRELESS COMMUNICATIONS SERVICES

[TIA/EIA 603 D June 2010](#): Land Mobile FM or PM Communications Equipment Measurement and Performance Standards.

[47 CFR FCC Part 15 Subpart B](#): - Unintentional Radiators

[FCC Part 2](#): FREQUENCY ALLOCATIONS AND RADIO TREATY MATTERS; GENERAL RULES AND REGULATIONS

[ANSI C63.4:2009](#): Methods of Measurement of Radio-Noise Emissions from Low-Voltage Electrical and Electronic Equipment in the Range of 9 kHz to 40 GHz

[FCC KDB971168D01](#) Power Meas License Digital Systems

2. SUMMARY

2.1. General Remarks

Date of receipt of test sample	:	Oct. 10, 2015
Testing commenced on	:	Oct. 11, 2015
Testing concluded on	:	Nov. 01, 2015

2.2. Product Description

The **HYUNDAI CORPORATION's** Model: L505 or the "EUT" as referred to in this report; more general information as follows, for more details, refer to the user's manual of the EUT.

Name of EUT	Mobile Phone
Model Number	L505
Modulation Type	GMSK for GSM/GPRS, 8-PSK for EDGE, QPSK for UMTS, QPSK, 16QAM for LTE
Antenna Type	Internal
UMTS Operation Frequency Band	Device supported UMTS FDD Band II/IV/V
WLAN FCC Operation frequency	IEEE 802.11b:2412-2462MHz IEEE 802.11g:2412-2462MHz IEEE 802.11n HT20:2412-2462MHz IEEE 802.11n HT40:2422-2452MHz
BT FCC Operation frequency	2402MHz-2480MHz
HSDPA Release Version	Release 10
HSUPA Release Version	Release 6
DC-HSUPA Release Version	Not Supported
WCDMA Release Version	R99
LTE Release Version	R8
LTE Operation Frequency Band	Device supported FDD band 2, FDD band 4, FDD band 7, FDD band 17
WLAN FCC Modulation Type	IEEE 802.11b: DSSS(CCK,DQPSK,DBPSK) IEEE 802.11g: OFDM(64QAM, 16QAM, QPSK, BPSK) IEEE 802.11n HT20: OFDM (64QAM, 16QAM, QPSK,BPSK) IEEE 802.11n HT40: OFDM (64QAM, 16QAM, QPSK,BPSK)
BT Modulation Type	GFSK,8DPSK, π /4DQPSK(BT 3.0+EDR)
Hardware version	WW818-MB-V0.5
Software version	HYUNDAI_L505_V4.0.3
Android version	Android 4.4.2
GPS function	Supported
WLAN	Supported 802.11b/802.11g/802.11n
Bluetooth	Supported BT 4.0/BT 3.0+EDR
GSM/EDGE/GPRS	Supported GSM/GPRS/EDGE
GSM/EDGE/GPRS Power Class	GSM850:Power Class 4/ PCS1900:Power Class 1
GSM/EDGE/GPRS Operation Frequency	GSM850 :824.2MHz-848.8MHz/PCS1900:1850.2MHz-1909.8MHz
GSM/EDGE/GPRS Operation Frequency Band	GSM850/PCS1900/GPRS850/GPRS1900/EDGE850/EDGE1900
GSM Release Version	R99
GPRS/EDGE Multislot Class	GPRS/EDGE: Multi-slot Class 12
Extreme temp. Tolerance	-30°C to +50°C
Extreme vol. Limits	3.40VDC to 4.20VDC (nominal: 3.80VDC)
GPRS operation mode	Class B

2.3. Equipment under Test

Power supply system utilised

Power supply voltage	:	<input type="radio"/> 120V / 60 Hz	<input type="radio"/> 115V / 60Hz
		<input type="radio"/> 12 V DC	<input type="radio"/> 24 V DC
		<input checked="" type="radio"/> Other (specified in blank below)	

DC 3.80V

2.4. Short description of the Equipment under Test (EUT)

2.4.1 General Description

L505 is subscriber equipment in the WCDMA/GSM /LTE system. The HSPA/UMTS frequency band is Band II, Band IV and Band V, LTE frequency band is band 2, band 4, band 7, band 17; The GSM/GPRS/EDGE frequency band includes GSM850 and GSM900 and DCS1800 and PCS1900, but only Band II and Band V and GSM850 and PCS1900 bands test data included in this report. The Mobile Phone implements such functions as RF signal receiving/transmitting, HSPA/UMTS, LTE and GSM/GPRS/EDGE protocol processing, voice, video MMS service, GPS and WIFI etc. Externally it provides micro SD card interface, earphone port (to provide voice service) and SIM card interface. It also provides Bluetooth module to synchronize data between a PC and the phone, or to use the built-in modem of the phone to access the Internet with a PC, or to exchange data with other Bluetooth devices.

NOTE: Unless otherwise noted in the report, the functional boards installed in the units shall be selected from the below list, but not means all the functional boards listed below shall be installed in one unit.

2.5. Internal Identification of AE used during the test

AE ID*	Description
AE1	Battery
AE2	Charger

AE1

Model: TPA-5950100UU

INPUT: 100-240V~ 50/60Hz 0.2A

OUTPUT: DC 5.0V 1.0A

*AE ID: is used to identify the test sample in the lab internally.

2.6. Normal Accessory setting

Fully charged battery was used during the test.

2.7. EUT configuration

The following peripheral devices and interface cables were connected during the measurement:

- supplied by the manufacturer

- supplied by the lab

<input type="radio"/> Power Cable	Length (m) :	/
	Shield :	/
	Detachable :	/
<input type="radio"/> Multimeter	Manufacturer :	/
	Model No. :	/

2.8. Related Submittal(s) / Grant (s)

This submittal(s) (test report) is intended for **FCC ID: RQQHLT-L50SCM** filing to comply with FCC Part 27, Rules.

2.9. Modifications

No modifications were implemented to meet testing criteria.

2.10. General Test Conditions/Configurations

2.10.1 Test Environment

Environment Parameter	Selected Values During Tests	
Relative Humidity	Ambient	
Temperature	TN	Ambient
Voltage	VL	3.4V
	VN	3.8V
	VH	4.2V

NOTE: VL=lower extreme test voltage VN=nominal voltage
VH=upper extreme test voltage TN=normal temperature

3. TEST ENVIRONMENT

3.1. Address of the test laboratory

Shenzhen CTL Testing Technology Co., Ltd.

Floor 1-A, Baisha Technology Park, No. 3011, Shahexi Road, Nanshan, Shenzhen 518055 China

There is one 3m semi-anechoic chamber and two line conducted labs for final test. The Test Sites meet the requirements in documents ANSI C63.4 and CISPR 22/EN 55022 requirements.

3.2. Test Facility

The test facility is recognized, certified, or accredited by the following organizations:

The test facility is recognized, certified, or accredited by the following organizations:

IC Registration No.: 9618B

The 3m alternate test site of Shenzhen CTL Testing Technology Co., Ltd. EMC Laboratory has been registered by Certification and Engineer Bureau of Industry Canada for the performance of with Registration No.: 9618B on November 13, 2013.

FCC-Registration No.: 970318

Shenzhen CTL Testing Technology Co., Ltd. EMC Laboratory has been registered and fully described in a report filed with the (FCC) Federal Communications Commission. The acceptance letter from the FCC is maintained in our files. Registration 970318, December 19, 2013.

3.3. Environmental conditions

During the measurement the environmental conditions were within the listed ranges:

Temperature:	15-35 ° C
Humidity:	30-60 %
Atmospheric pressure:	950-1050mbar

3.4. Test Description

3.4.1 AWS Band (1710-1755MHz pairedwith 2110-2155MHz)

Test Item	FCC Rule No.	Requirements	Verdict
Effective (Isotropic) Radiated Output Power	§2.1046, §27.50(d)	EIRP ≤ 1W;	Pass
Peak-Average Ratio	§2.1046, §27.50(d)	Limit≤13dB	Pass
Modulation Characteristics	§2.1047	Digital modulation	N/A
Bandwidth	§2.1049	OBW: No limit. EBW: No limit.	Pass
Band Edges Compliance	§2.1051, §27.53(h)	≤ -13dBm/1%*EBW, in 1MHz bands immediately outside and adjacent to The frequency block.	Pass
Spurious Emission at Antenna Terminals	§2.1051, §27.53(h)	≤ -13dBm/1MHz, from 9kHz to 10 th harmonics but outside authorized operating frequency ranges.	Pass
Field Strength of Spurious Radiation	§2.1055, §27.54	Within authorized bands of operation/frequency block.	Pass
Frequency Stability	§2.1053, §27.53(h)	≤ -13dBm/1MHz.	Pass

NOTE 1: For the verdict, the "N/A" denotes "not applicable", the "N/T" de notes "not tested".

3.5. Equipments Used during the Test

Test Equipment	Manufacturer	Model No.	Serial No.	Calibration Date	Calibration Due Date
LISN	R&S	ENV216	3560.6550.12	2015/06/02	2016/06/01
LISN	R&S	ESH2-Z5	860014/010	2015/06/02	2016/06/01
Bilog Antenna	Sunol Sciences Corp.	JB1	A061713	2015/06/02	2016/06/01
EMI Test Receiver	R&S	ESCI	103710	2015/06/02	2016/06/01
Spectrum Analyzer	Agilent	N9030A	MY49430428	2015/05/21	2016/05/20
Controller	EM Electronics	Controller EM 1000	N/A	2015/05/21	2016/05/20
Horn Antenna	Sunol Sciences Corp.	DRH-118	A062013	2015/05/19	2016/05/18
Active Loop Antenna	SCHWARZBECK	FMZB1519	1519-037	2015/05/19	2016/05/18
Amplifier	Agilent	8349B	3008A02306	2015/05/19	2016/05/18
Amplifier	Agilent	8447D	2944A10176	2015/05/19	2016/05/18
Temperature/Humidity Meter	Gangxing	CTH-608	02	2015/05/20	2016/05/19
High-Pass Filter	K&L	9SH10-2700/X12750-O/O	N/A	2015/05/20	2016/05/19
High-Pass Filter	K&L	41H10-1375/U12750-O/O	N/A	2015/05/20	2016/05/19
Coaxial Cables	HUBER+SUHNER	SUCOFLEX 104PEA-10M	10m	2015/06/02	2016/06/01
Coaxial Cables	HUBER+SUHNER	SUCOFLEX 104PEA-3M	3m	2015/06/02	2016/06/01
Coaxial Cables	HUBER+SUHNER	SUCOFLEX 104PEA-3M	3m	2015/06/02	2016/06/01
RF Cable	Megalon	RF-A303	N/A	2015/06/02	2016/06/01
Power Sensor	R&S	NRP-Z4	823.3618.03	2015.06.02	2016.06.01
Power Meter	R&S	NRVS	1020.1809.02	2015.06.02	2016.06.01

4. TEST CONDITIONS AND RESULTS

4.1. Output Power

TEST APPLICABLE

During the process of testing, the EUT was controlled via R&S Digital Radio Communication tester (CMW500) to ensure max power transmission and proper modulation. This result contains output power and EIRP measurements for the EUT. In all cases, output power is within the specified limits

4.1.1. Conducted Output Power

TEST CONFIGURATION

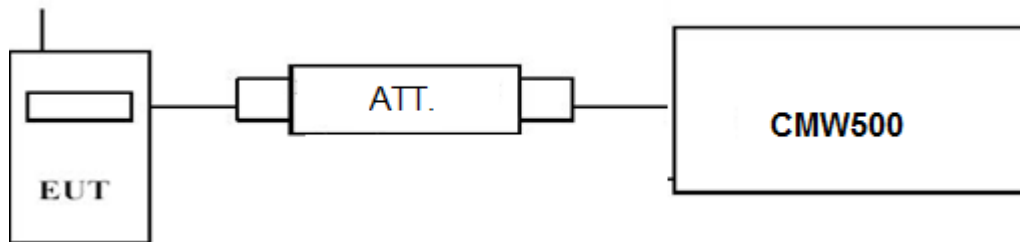

TEST PROCEDURE

Conducted Power Measurement:

- Place the EUT on a bench and set it in transmitting mode.
- Connect a low loss RF cable from the antenna port to a CMW500 by an Att.
- EUT Communicate with CMW500 then selects a channel for testing.
- Add a correction factor to the display CMW500, and then test.

TEST RESULTS

Remark:

- We were tested all RB Configuration refer 3GPP TS136 521 for each Channel Bandwidth of LTE FDD Band 17;

LIMIT

According to §27.50 (d) (4): Fixed, mobile, and portable (hand- held) stations operating in the 1710–1755 MHz band are limited to 1 watt EIRP.

LTE FDD Band 17				
TX Channel Bandwidth	Frequency (MHz)	RB Size/Offset	Average Power [dBm]	
			QPSK	16QAM
5 MHz	706.5	1 RB low	23.04	22.45
		1 RB high	23.22	22.25
		50% RB mid	23.11	22.30
		100% RB	22.85	21.85
	710.0	1 RB low	23.05	22.41
		1 RB high	22.14	21.22
		50% RB mid	22.26	21.32
		100% RB	22.47	21.45
	713.5	1 RB low	23.06	22.84
		1 RB high	23.15	22.63
		50% RB mid	22.86	21.56
		100% RB	22.84	21.89
10 MHz	709.0	1 RB low	23.13	22.66
		1 RB high	23.20	22.32
		50% RB mid	22.69	21.57
		100% RB	22.88	21.69

	710.0	1 RB low	23.14	22.25
		1 RB high	23.13	22.36
		50% RB mid	22.59	21.55
		100% RB	22.69	21.78
	711.0	1 RB low	23.11	22.68
		1 RB high	23.12	22.74
		50% RB mid	22.78	21.32
		100% RB	22.85	21.41

4.1.2. Radiated Output Power

LIMIT

According to §27.50 (d) (4): Fixed, mobile, and portable (hand-held) stations operating in the 1710–1755 MHz band are limited to 1 watt EIRP.

TEST CONFIGURATION

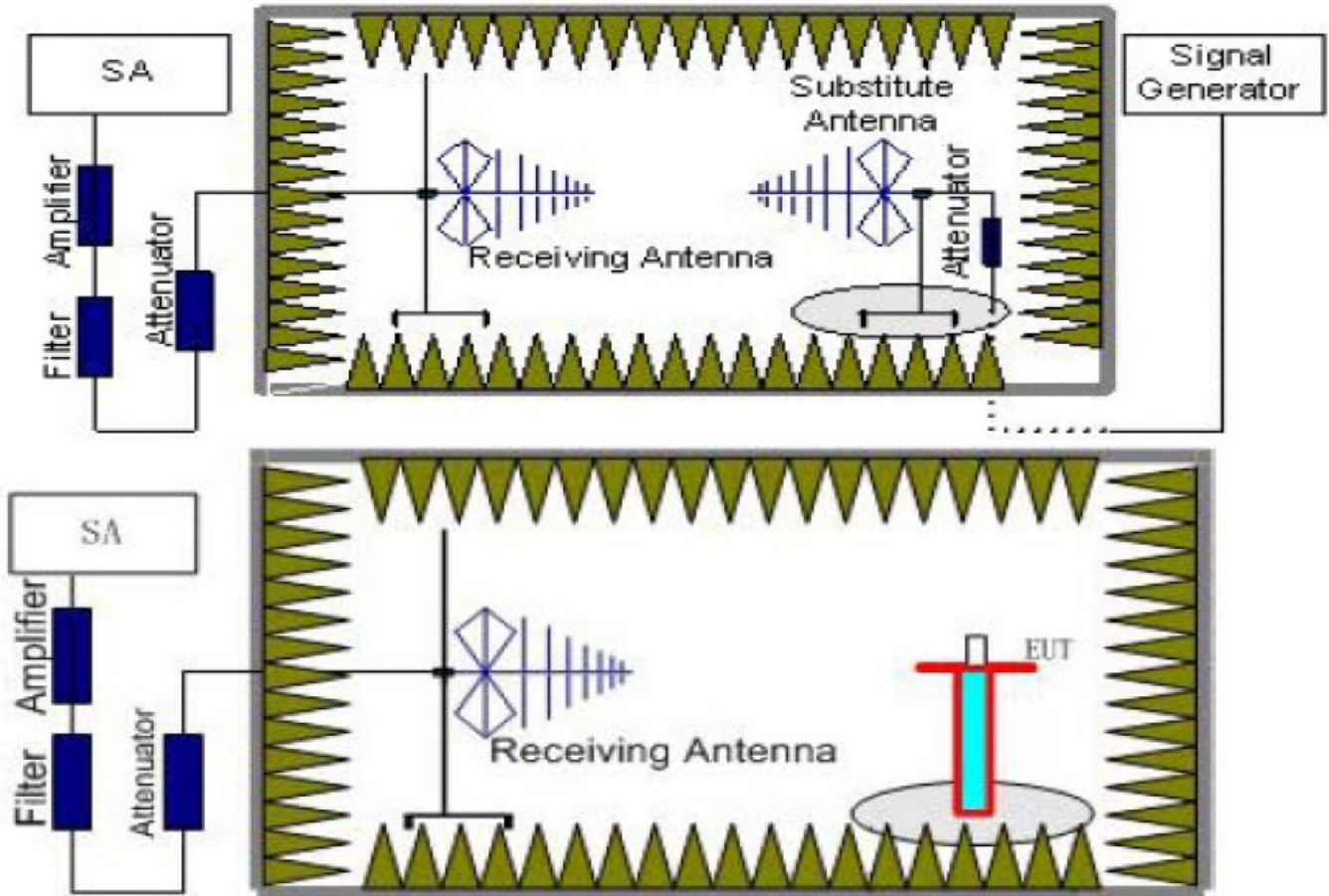

TEST PROCEDURE

1. EUT was placed on a 0.80 meter high non-conductive stand at a 3 meter test distance from the receive antenna. A receiving antenna was placed on the antenna mast 3 meters from the EUT for emission measurements. The height of receiving antenna is 0.80m. Detected emissions were maximized at each frequency by rotating the EUT through 360° and adjusting the receiving antenna polarization. The radiated emission measurements of all transmit frequencies in three channels (High, Middle, Low) were measured with peak detector.
2. A log-periodic antenna or double-ridged waveguide horn antenna shall be substituted in place of the EUT. The log-periodic antenna will be driven by a signal generator and the level will be adjusted till the same power value on the spectrum analyzer or receiver. The level of the spurious emissions can be calculated through the level of the signal generator, cable loss, the gain of the substitution antenna and the reading of the spectrum analyzer or receiver.
3. The EUT is then put into continuously transmitting mode at its maximum power level during the test. Set Test Receiver or Spectrum RBW=1MHz, VBW=3MHz, And the maximum value of the receiver should be recorded as (P_r).
4. The EUT shall be replaced by a substitution antenna. In the chamber, an substitution antenna for the frequency band of interest is placed at the reference point of the chamber. An RF Signal source for the frequency band of interest is connected to the substitution antenna with a cable that has been constructed to not interfere with the radiation pattern of the antenna. A power (P_{Mea}) is applied to the input of the substitution antenna, and adjust the level of the signal generator output until the value of the receiver reach the previously recorded (P_r). The power of signal source (P_{Mea}) is recorded. The test should be performed by rotating the test item and adjusting the receiving antenna polarization.

5. A amplifier should be connected to the Signal Source output port. And the cable should be connect between the Amplifier and the Substitution Antenna. The cable loss (P_{cl}), the Substitution Antenna Gain (G_a) and the Amplifier Gain (P_{Ag}) should be recorded after test. The measurement results are obtained as described below:
 $Power(EIRP)=P_{Mea}-P_{Ag}-P_{cl}+G_a$
 We used SMF100A microwave signal generator which signal level can up to 33dBm,so we not used power Amplifier for substitution test; The measurement results are amend as described below:
 $Power(EIRP)=P_{Mea}-P_{cl}+G_a$
6. This value is EIRP since the measurement is calibrated using an antenna of known gain (2.15 dBi) and known input power.
7. ERP can be calculated from EIRP by subtracting the gain of the dipole, $ERP = EIRP-2.15dBi$.

TEST RESULTS

Note: We test the H direction and V direction and V direction is worse.

Remark:

- We were tested all RB Configuration refer 3GPP TS136 521 for each Channel Bandwidth of LTE FDD Band 4; recorded worst case for each Channel Bandwidth of LTE FDD Band 4.
- $EIRP=P_{Mea}(dBm)-P_{cl}(dB)+P_{Ag}(dB)+G_a(dBi)$

LTE FDD Band 17_Channel Bandwidth 5MHz_QPSK

Frequency (MHz)	P_{Mea} (dBm)	P_{cl} (dB)	G_a Antenna Gain(dB)	P_{Ag} (dB)	EIRP (dBm)	Limit (dBm)	Margin (dB)	Polarization
706.5	-20.03	2.42	8.24	33.54	19.33	30	10.67	V
710.0	-20.11	2.42	8.24	33.54	19.25	30	10.75	V
713.5	-19.26	2.42	8.24	33.54	20.10	30	9.90	V

LTE FDD Band 17_Channel Bandwidth 10MHz_QPSK

Frequency (MHz)	P_{Mea} (dBm)	P_{cl} (dB)	G_a Antenna Gain(dB)	P_{Ag} (dB)	EIRP (dBm)	Limit (dBm)	Margin (dB)	Polarization
709.0	-19.14	2.42	8.24	33.54	20.22	30	9.78	V
710.0	-19.98	2.42	8.24	33.54	19.38	30	10.62	V
711.0	-20.22	2.42	8.24	33.54	19.14	30	10.86	V

LTE FDD Band 17_Channel Bandwidth 5MHz_16QAM

Frequency (MHz)	P_{Mea} (dBm)	P_{cl} (dB)	G_a Antenna Gain(dB)	P_{Ag} (dB)	EIRP (dBm)	Limit (dBm)	Margin (dB)	Polarization
706.5	-21.11	2.42	8.24	33.54	18.25	30	11.75	V
710.0	-20.03	2.42	8.24	33.54	19.33	30	10.67	V
713.5	-20.74	2.42	8.24	33.54	18.62	30	11.38	V

LTE FDD Band 17_Channel Bandwidth 10MHz_16QAM

Frequency (MHz)	P_{Mea} (dBm)	P_{cl} (dB)	G_a Antenna Gain(dB)	P_{Ag} (dB)	EIRP (dBm)	Limit (dBm)	Margin (dB)	Polarization
709.0	-20.67	2.42	8.24	33.54	18.69	30	11.31	V
710.0	-20.62	2.42	8.24	33.54	18.74	30	11.26	V
711.0	-20.16	2.42	8.24	33.54	19.20	30	10.80	V

4.2. Peak-to-Average Ratio (PAR)

LIMIT

The Peak-to-Average Ratio (PAR) of the transmission may not exceed 13 dB.

TEST CONFIGURATION

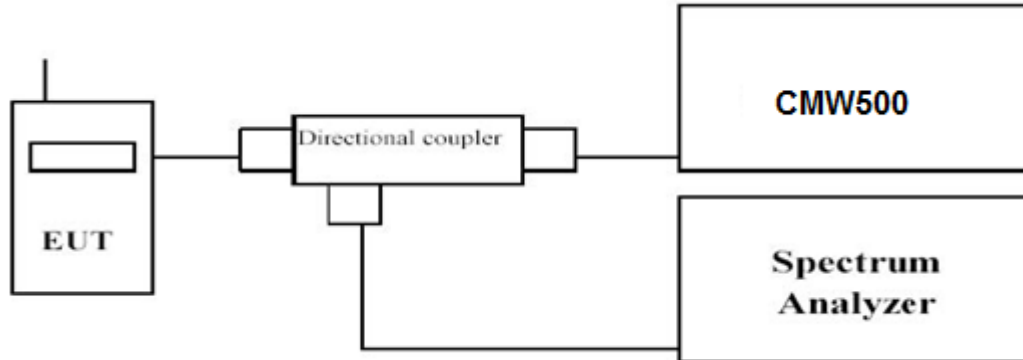

TEST PROCEDURE

1. Refer to instrument's analyzer instruction manual for details on how to use the power statistics/CCDF function;
2. Set resolution/measurement bandwidth \geq signal's occupied bandwidth;
3. Set the number of counts to a value that stabilizes the measured CCDF curve;
4. Set the measurement interval as follows:
 - 1). for continuous transmissions, set to 1 ms,
 - 2). for burst transmissions, employ an external trigger that is synchronized with the EUT burst timing sequence, or use the internal burst trigger with a trigger level that allows the burst to stabilize and set the measurement interval to a time that is less than or equal to the burst duration.
5. Record the maximum PAPR level associated with a probability of 0.1%.

TEST RESULTS

Remark:

1. We were tested all RB Configuration refer 3GPP TS136 521 for each Channel Bandwidth of LTE FDD Band 17; recorded worst case for each Channel Bandwidth of LTE FDD Band 17.

LTE FDD Band 17				
TX Channel Bandwidth	Frequency (MHz)	RB Size/Offset	PAPR (dB)	
			QPSK	16QAM
5 MHz	706.5	1RB#0	2.32	2.73
	710.0		2.38	2.78
	713.5		2.30	2.71
10 MHz	709.0	1RB#0	3.92	4.21
	710.0		3.83	4.15
	711.0		3.75	3.85

LTE FDD Band 17-5MHz Channel Bandwidth PAPR

QPSK

16QAM



1RB#0

1RB#0

Low Channel



1RB#0

1RB#0

Middle Channel

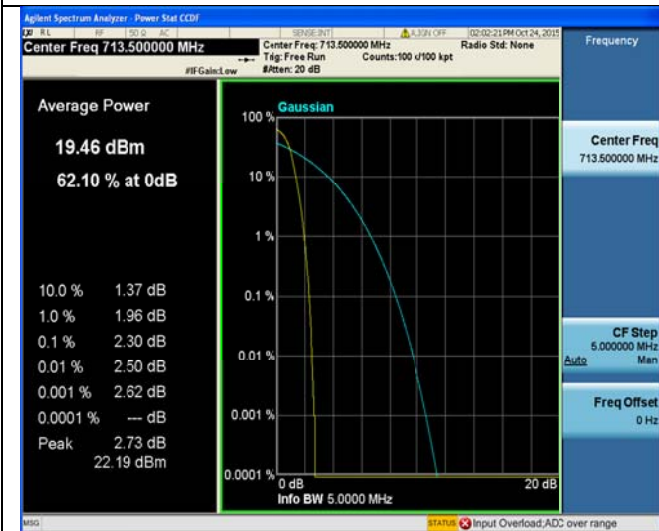

1RB#0

1RB#0

High Channel

LTE FDD Band 17-10MHz Channel Bandwidth PAPR

QPSK

16QAM



1RB#0

1RB#0

Low Channel

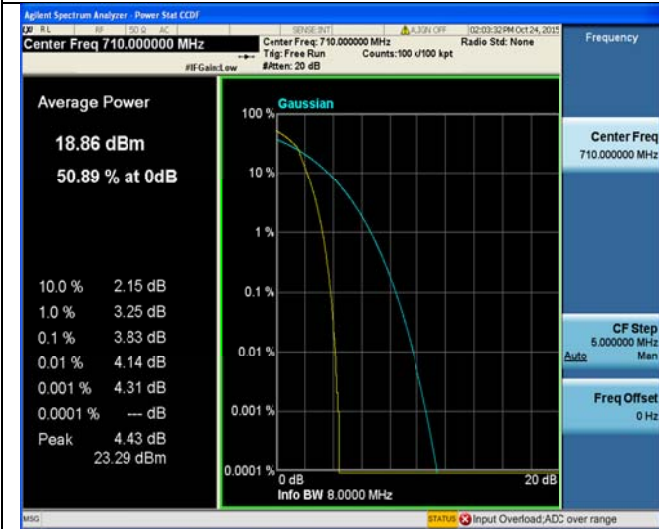

1RB#0

1RB#0

Middle Channel

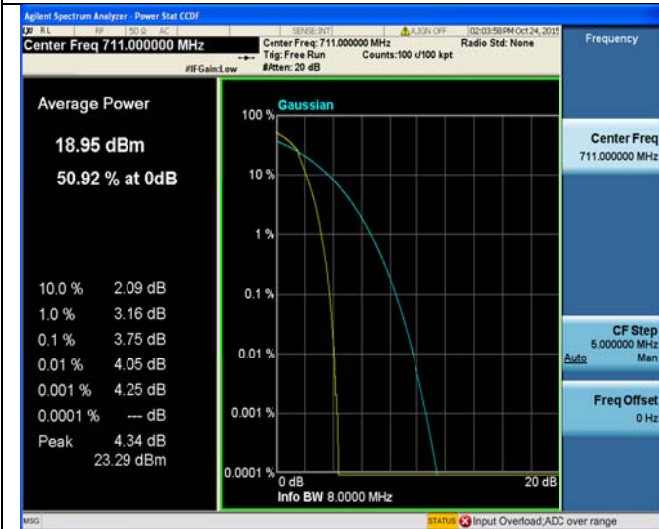

1RB#0

1RB#0

High Channel

4.3. Occupied Bandwidth and Emission Bandwidth

LIMIT

N/A

TEST CONFIGURATION

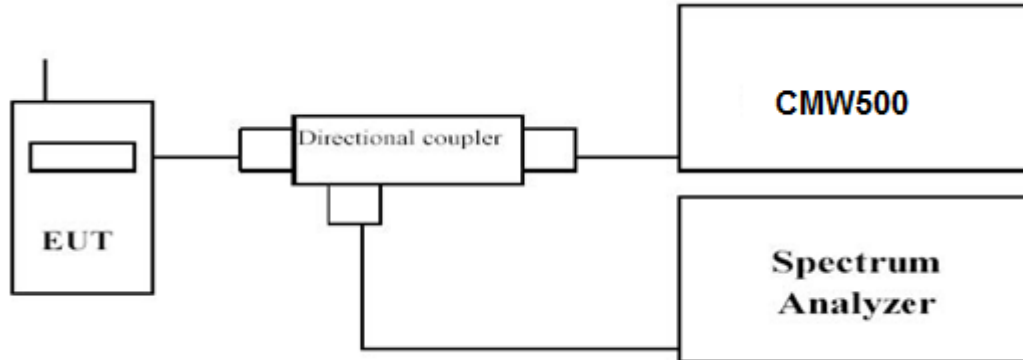

TEST PROCEDURE

The transmitter output was connected to a calibrated coaxial cable and coupler, the other end of which was connected to a spectrum analyzer. The occupied bandwidth was measured with the spectrum analyzer at low, middle and high channel in each band. The -26dBc Emission bandwidth was also measured and recorded. Set RBW was set to about 1% of emission BW, VBW \geq 3 times RBW.

-26dBc display line was placed on the screen (or 99% bandwidth), the occupied bandwidth is the delta frequency between the two points where the display line intersects the signal trace.

TEST RESULTS

Remark:

1. We were tested all RB Configuration refer 3GPP TS136 521 for each Channel Bandwidth of LTE FDD Band 17; recorded worst case for each Channel Bandwidth of LTE FDD Band 17.

LTE FDD Band 17						
TX Channel Bandwidth	RB Size/Offset	Frequency (MHz)	-26dBc Emission bandwidth (MHz)		99% Occupied bandwidth (MHz)	
			QPSK	16QAM	QPSK	16QAM
5 MHz	25RB#0	706.5	4.836	4.773	4.490	4.489
		710.0	4.800	4.793	4.478	4.475
		713.5	4.806	4.800	4.474	4.470
10 MHz	50RB#0	709.0	9.479	9.455	8.950	8.947
		710.0	9.390	9.408	8.923	8.923
		711.0	9.385	9.361	8.905	8.899

LTE FDD Band 7-5MHz Channel Bandwidth

QPSK

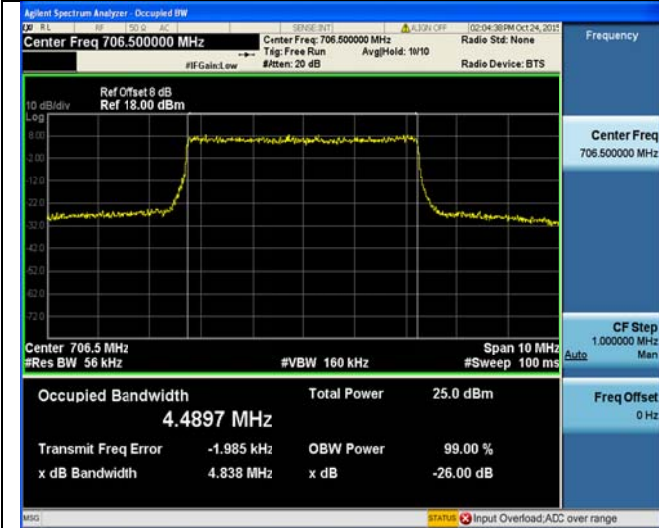

16QAM

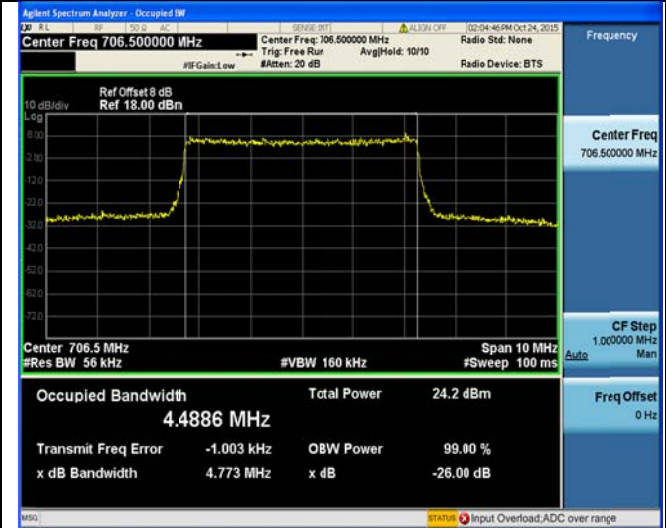

25RB#0

25RB#0

Low Channel

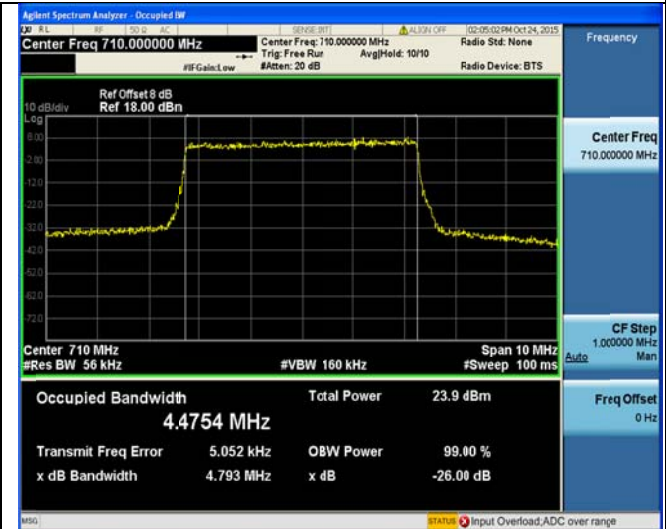

25RB#0

25RB#0

Middle Channel

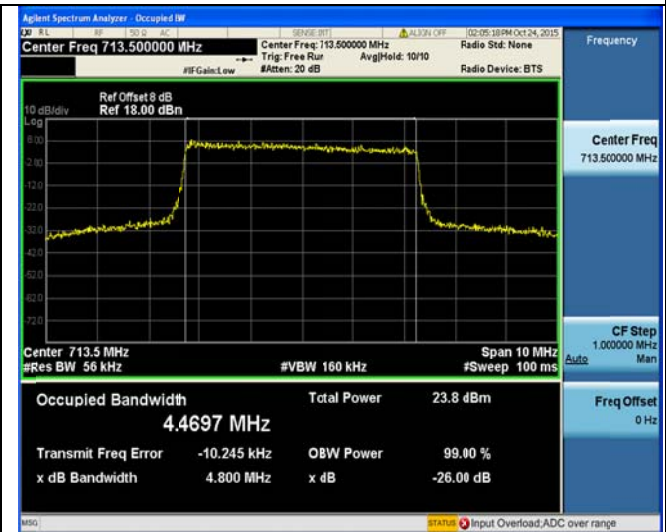
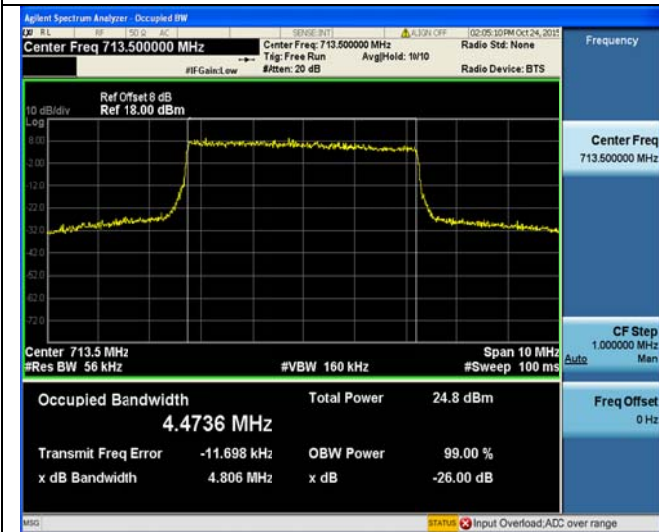

25RB#0

25RB#0

High Channel

LTE FDD Band 7-10MHz Channel Bandwidth

QPSK

16QAM



50RB#0

50RB#0

Low Channel

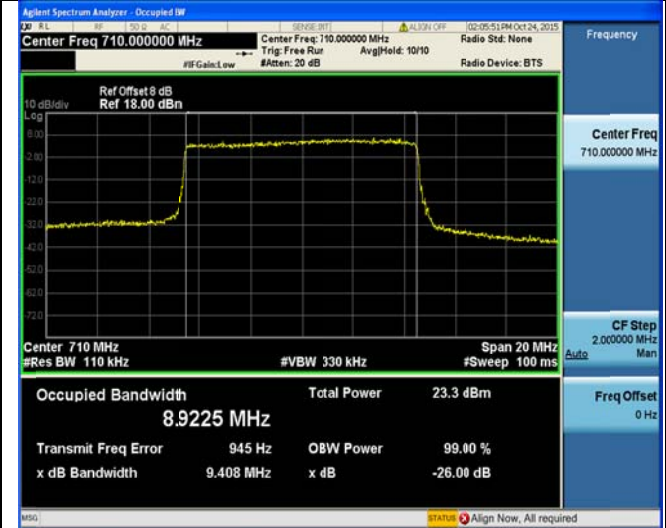
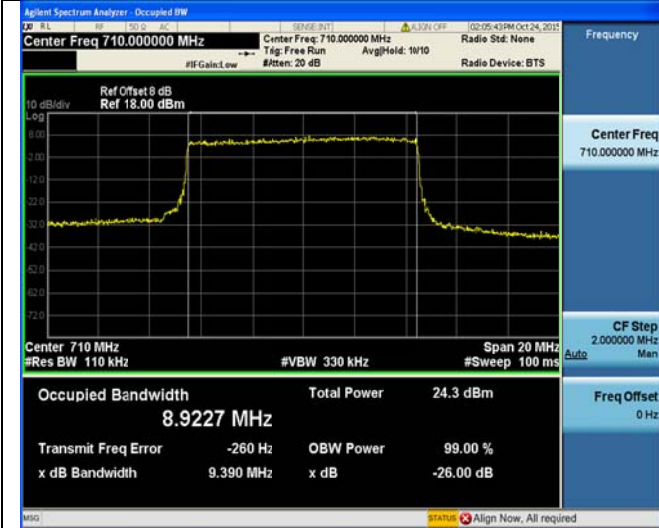

50RB#0

50RB#0

Middle Channel

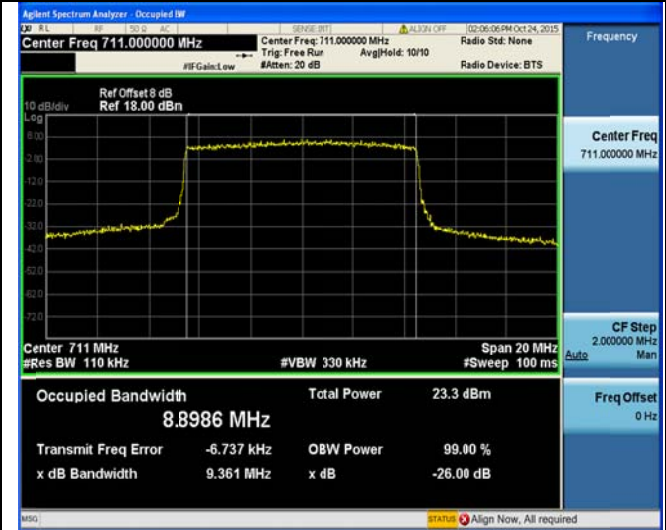

50RB#0

50RB#0

High Channel

4.4. Band Edge compliance

LIMIT

According to §27.53 (h): For operations in the 1710–1755 MHz and 2110–2155 MHz bands, the power of any emission outside a licensee’s frequency block shall be attenuated below the transmitter power (P) by at least $43 + 10 \log_{10}(P)$ dB.

TEST CONFIGURATION

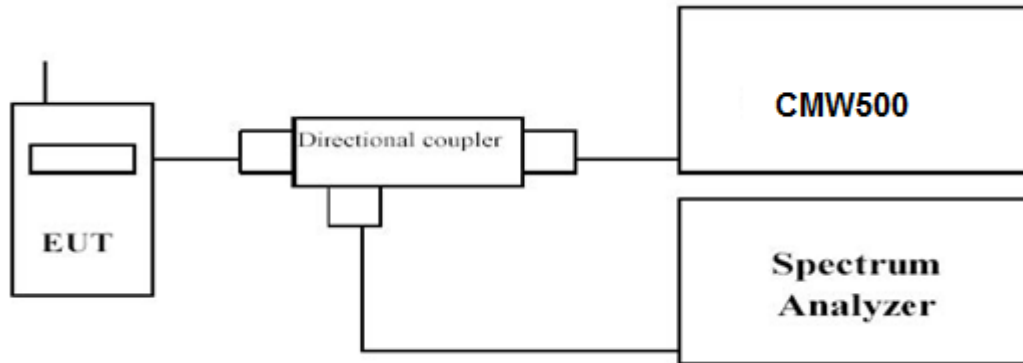

TEST PROCEDURE

1. The transmitter output port was connected to base station.
2. The RF output of EUT was connected to the power meter by RF cable and attenuator, the path loss was compensated to the results for each measurement.
3. Set EUT at maximum power through base station.
4. Select lowest and highest channels for each band and different modulation.
5. Measure Band edge using RMS (Average) detector by spectrum

TEST RESULTS

Remark:

1. We were tested all RB Configuration refer 3GPP TS136 521 for each Channel Bandwidth of LTE FDD Band 17; recorded worst case for each Channel Bandwidth of LTE FDD Band 17.

LTE FDD Band 17-5MHz Channel Bandwidth Band Edge Compliance

QPSK

16QAM



1RB#0

1RB#0

Low Channel



1RB#0

1RB#0

High Channel

LTE FDD Band 17-10MHz Channel Bandwidth Band Edge Compliance

QPSK

16QAM



1RB#0

1RB#0

Low Channel



1RB#0

1RB#0

High Channel

4.5. Spurious Emission on Antenna Port

LIMIT

According to §27.53 (h): For operations in the 1710–1755 MHz and 2110–2155 MHz bands, the power of any emission outside a licensee's frequency block shall be attenuated below the transmitter power (P) by at least $43 + 10 \log_{10}(P)$ dB.

TEST CONFIGURATION

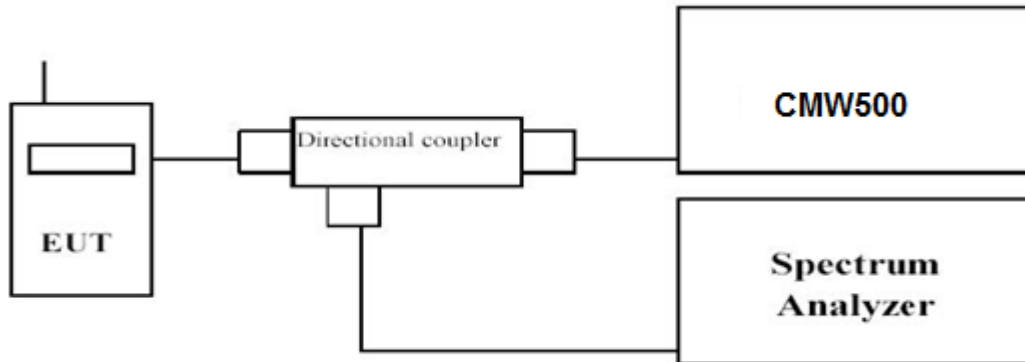

TEST PROCEDURE

The EUT was setup according to EIA/TIA 603D

- Place the EUT on a bench and set it in transmitting mode.
- Connect a low loss RF cable from the antenna port to a spectrum analyzer and CMW500 by a Directional Couple.
- EUT Communicate with CMW500, then select a channel for testing.
- Add a correction factor to the display of spectrum, and then test.
- The resolution bandwidth of the spectrum analyzer was set sufficient scans were taken to show the out of band Emission if any up to 10th harmonic.
- Please refer to following tables for test antenna conducted emissions

Working Frequency	Sub range (GHz)	RBW	VBW	Sweep time (s)
LTE FDD Band 17	0.000009~0.000015	1KHz	3KHz	Auto
	0.000015~0.03	10KHz	30KHz	Auto
	0.03~26.5	1 MHz	3 MHz	Auto

TEST RESULTS

Remark:

- We were tested all RB Configuration refer 3GPP TS136 521 for each Channel Bandwidth of LTE FDD Band 17; recorded worst case for each Channel Bandwidth of LTE FDD Band 17.

LTE FDD Band 17-5MHz Channel Bandwidth

Low Channel

QPSK

16QAM

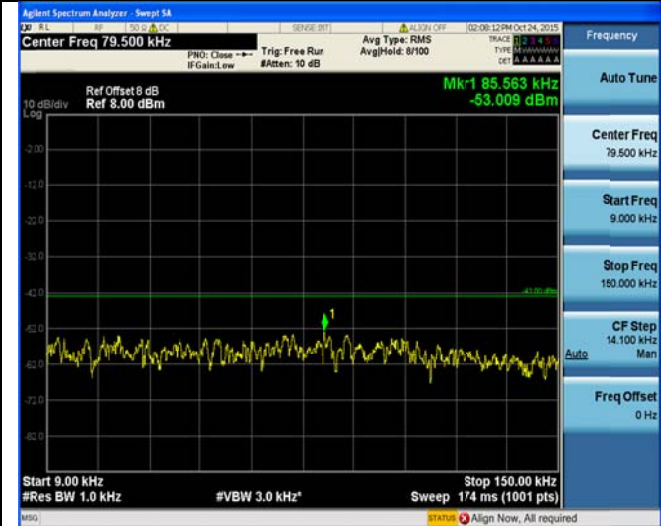
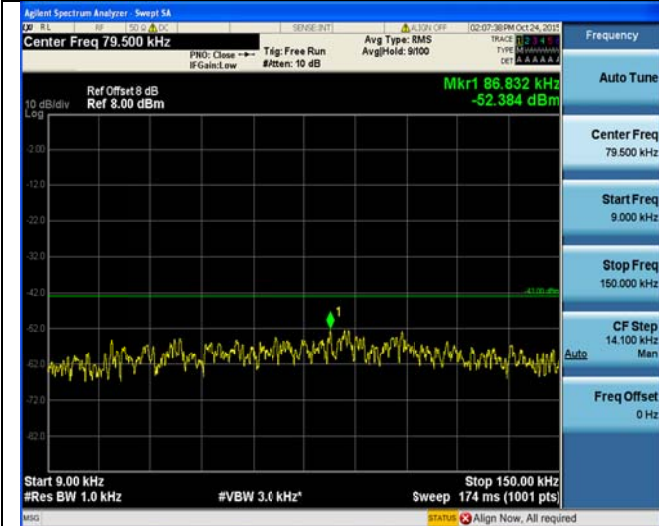

9KHz~150KHz

9KHz~150KHz

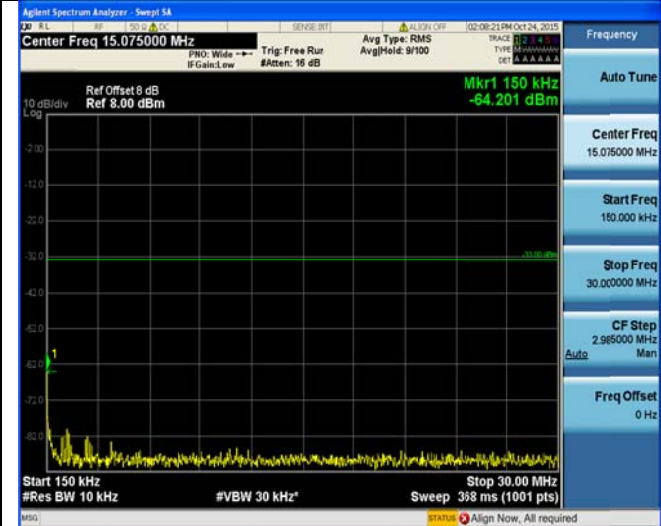
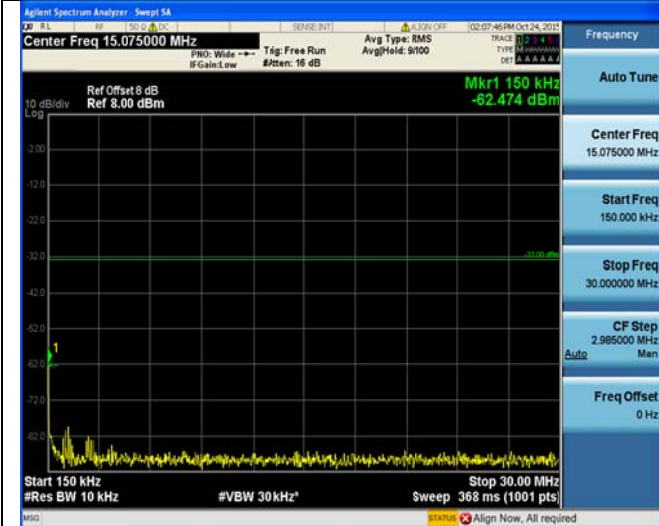

150KHz~30MHz

150KHz~30MHz



30MHz~26.5GHz
1RB#0

30MHz~26.5GHz
1RB#0

LTE FDD Band 17-5MHz Channel Bandwidth

Middle Channel

QPSK

16QAM

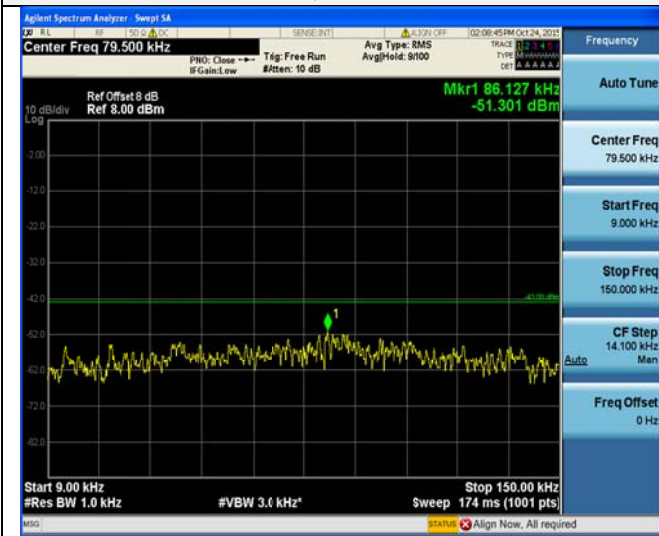

9KHz~150KHz

9KHz~150KHz

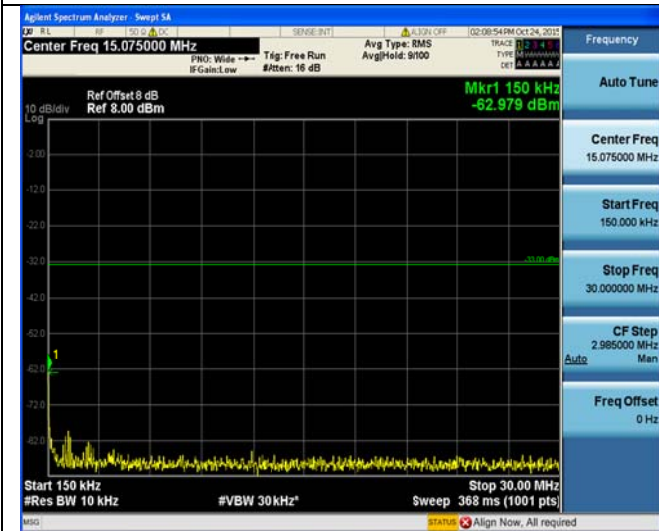

150KHz~30MHz

150KHz~30MHz



30MHz~26.5GHz

30MHz~26.5GHz

QPSK

1RB#0

LTE FDD Band 17-5MHz Channel Bandwidth

High Channel

QPSK

16QAM



9KHz~150KHz

9KHz~150KHz

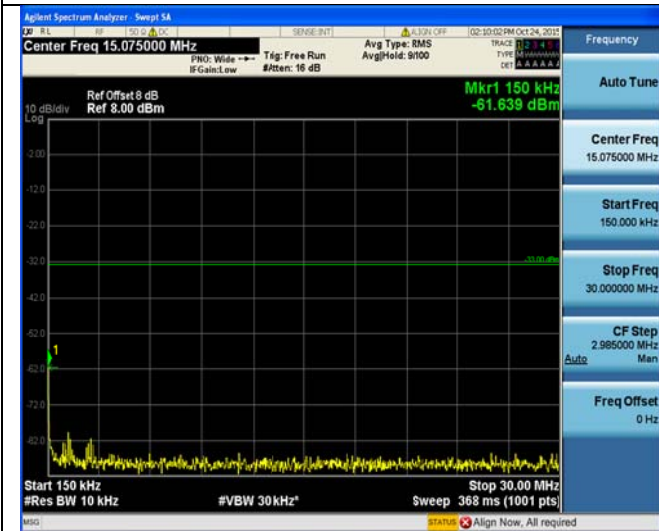

150KHz~30MHz

150KHz~30MHz



30MHz~26.5GHz

30MHz~26.5GHz

1RB#0

1RB#0

LTE FDD Band 17-10 MHz Channel Bandwidth

Low Channel

QPSK

16QAM

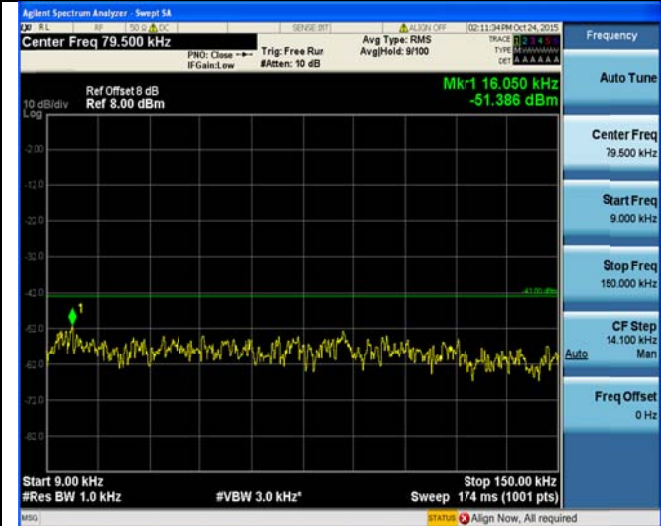
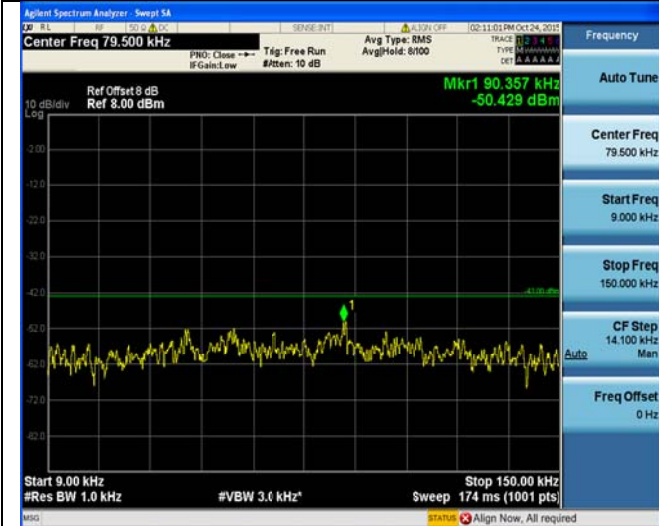

9KHz~150KHz

9KHz~150KHz

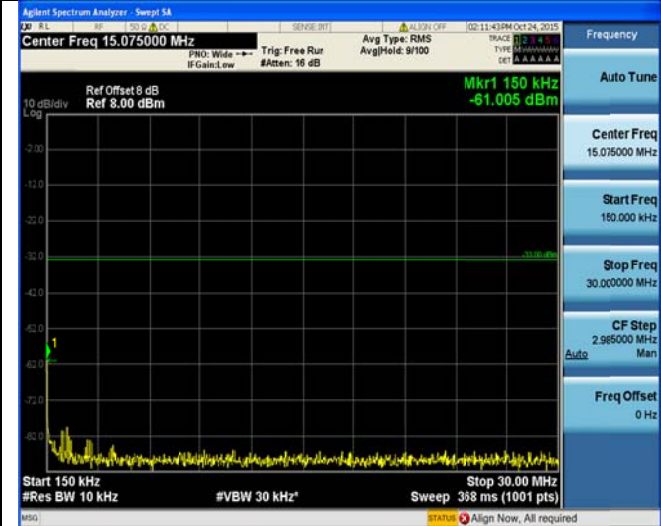
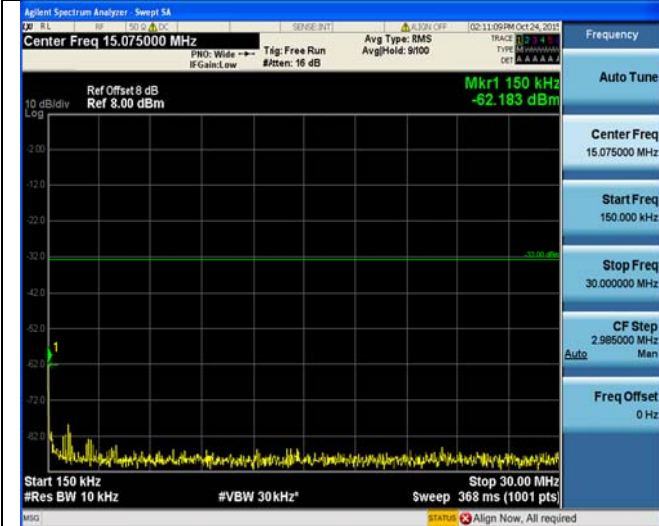

150KHz~30MHz

150KHz~30MHz



30MHz~26.5GHz
1RB#0

30MHz~26.5GHz
1RB#0

LTE FDD Band 17-10 MHz Channel Bandwidth

Middle Channel

QPSK

16QAM

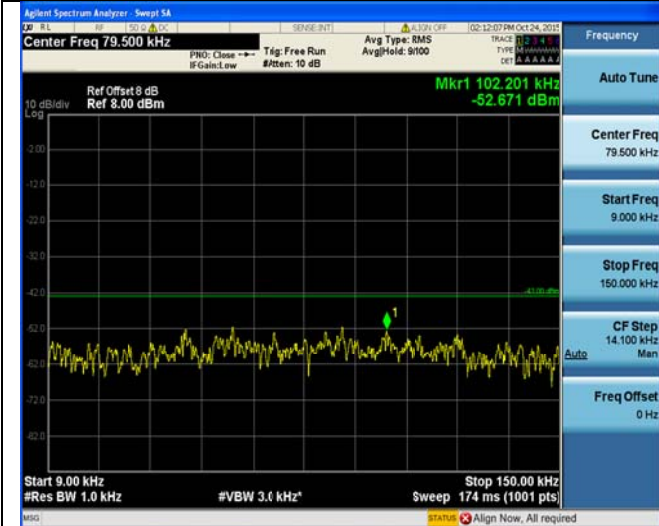

9KHz~150KHz

9KHz~150KHz

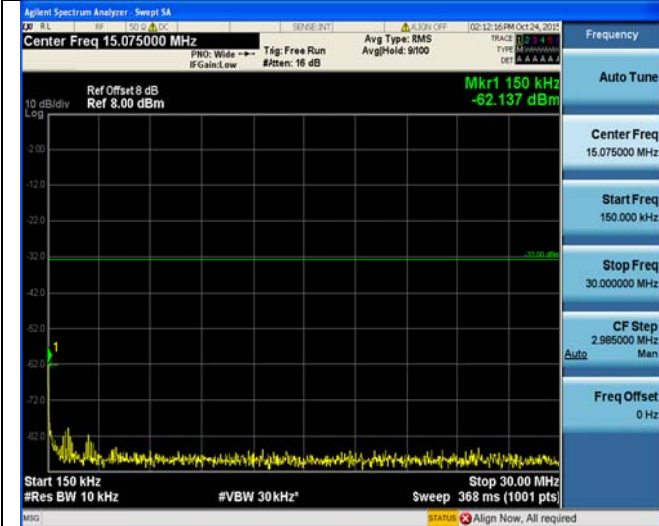

150KHz~30MHz

150KHz~30MHz



30MHz~26.5GHz
1RB#0

30MHz~26.5GHz
1RB#0

LTE FDD Band 17-10 MHz Channel Bandwidth

High Channel

QPSK

16QAM

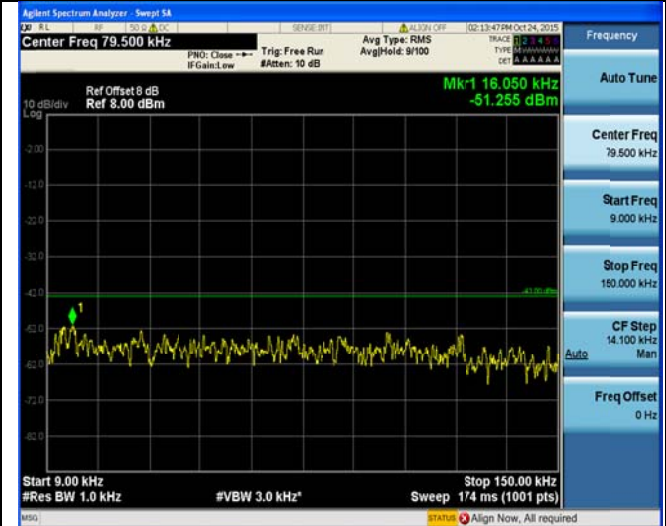
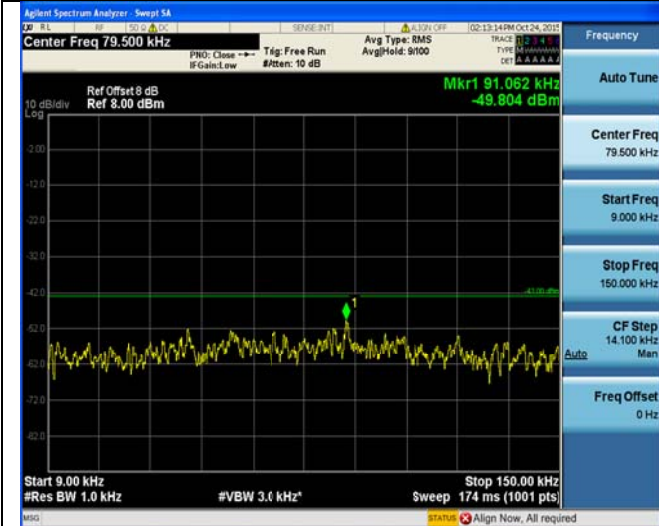

9KHz~150KHz

9KHz~150KHz

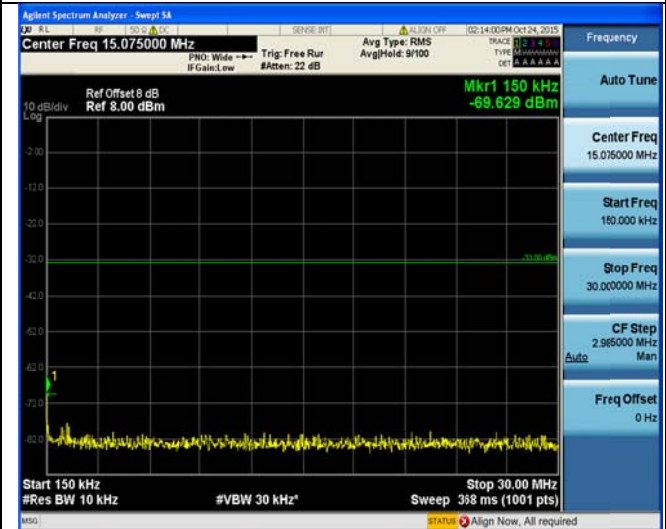

150KHz~30MHz

150KHz~30MHz



30MHz~26.5GHz
1RB#0

30MHz~26.5GHz
1RB#0

4.6. Radiated Spurious Emission

LIMIT

According to §27.53 (h): For operations in the 1710–1755 MHz and 2110–2155 MHz bands, the power of any emission outside a licensee's frequency block shall be attenuated below the transmitter power (P) by at least $43 + 10 \log_{10}(P)$ dB.

TEST CONFIGURATION

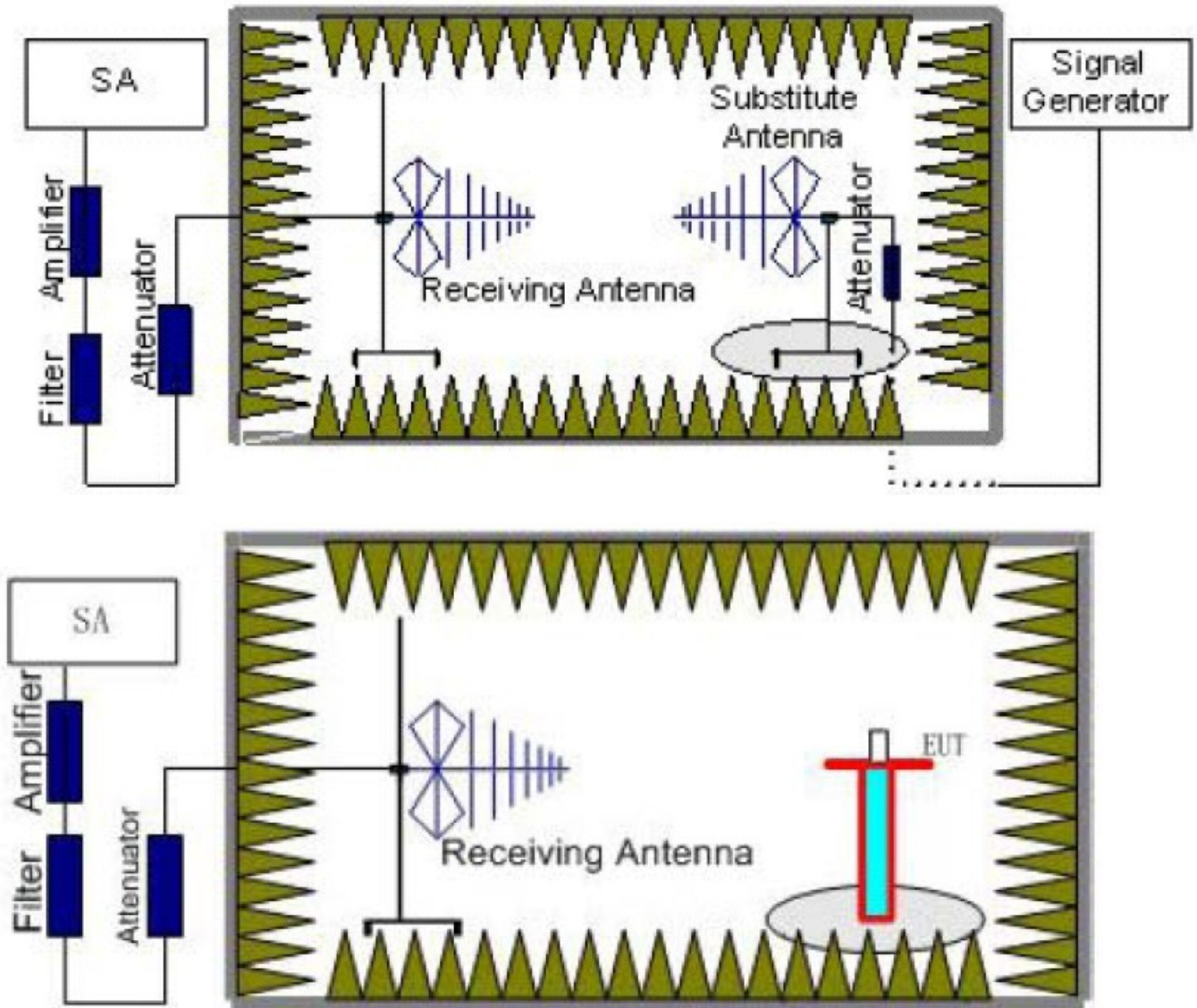

TEST PROCEDURE

1. EUT was placed on a 0.80 meter high non-conductive stand at a 3 meter test distance from the receive antenna. A receiving antenna was placed on the antenna mast 3 meters from the EUT for emission measurements. The height of receiving antenna is 0.80m. Detected emissions were maximized at each frequency by rotating the EUT through 360° and adjusting the receiving antenna polarization. The radiated emission measurements of all transmit frequencies in three channels (High, Middle, Low) were measured with peak detector.
2. A log-periodic antenna or double-ridged waveguide horn antenna shall be substituted in place of the EUT. The log-periodic antenna will be driven by a signal generator and the level will be adjusted till the same power value on the spectrum analyzer or receiver. The level of the spurious emissions can be calculated through the level of the signal generator, cable loss, the gain of the substitution antenna and the reading of the spectrum analyzer or receiver.
3. The EUT is then put into continuously transmitting mode at its maximum power level during the test. Set Test Receiver or Spectrum RBW=1MHz, VBW=3MHz, And the maximum value of the receiver should be recorded as (P_r).

4. The EUT shall be replaced by a substitution antenna. In the chamber, an substitution antenna for the frequency band of interest is placed at the reference point of the chamber. An RF Signal source for the frequency band of interest is connected to the substitution antenna with a cable that has been constructed to not interfere with the radiation pattern of the antenna. A power (P_{Mea}) is applied to the input of the substitution antenna, and adjust the level of the signal generator output until the value of the receiver reach the previously recorded (P_r). The power of signal source (P_{Mea}) is recorded. The test should be performed by rotating the test item and adjusting the receiving antenna polarization.
5. A amplifier should be connected to the Signal Source output port. And the cable should be connect between the Amplifier and the Substitution Antenna. The cable loss (P_{cl}), the Substitution Antenna Gain (G_a) and the Amplifier Gain (P_{Ag}) should be recorded after test.
The measurement results are obtained as described below:
 $Power(EIRP)=P_{Mea}-P_{Ag}-P_{cl}+G_a$
6. This value is EIRP since the measurement is calibrated using an antenna of known gain (2.15 dBi) and known input power.
7. ERP can be calculated from EIRP by subtracting the gain of the dipole, $ERP = EIRP - 2.15dBi$.
8. In order to make sure test results more clearly, we set frequency range and sweep time for difference frequency range as follows table:

Working Frequency	Subrange (GHz)	RBW	VBW	Sweep time (s)
LTE FDD Band 17	0.00009~0.15	1KHz	3KHz	30
	0.00015~0.03	10KHz	30KHz	10
	0.03~1	100KHz	300KHz	10
	1~2	1 MHz	3 MHz	2
	2~5	1 MHz	3 MHz	3
	5~8	1 MHz	3 MHz	3

Remark:

1. We were tested all RB Configuration refer 3GPP TS136 521 for each Channel Bandwidth of LTE FDD Band 17; recorded worst case for each Channel Bandwidth of LTE FDD Band 17.
2. $EIRP=P_{Mea}(dBm)-P_{cl}(dB)+G_a(dBi)$
3. We were not recorded other points as values lower than limits.
4. $Margin = Limit - EIRP$

LTE FDD Band 17_Channel Bandwidth 5MHz_QPSK_Low Channel

Frequency (MHz)	P_{Mea} (dBm)	P_{cl} (dB)	Diatance	G_a Antenna Gain(dB)	Peak EIRP (dBm)	Limit (dBm)	Margin (dB)	Polarization
1413.0	-40.96	2.98	3	8.68	-35.26	-13	22.26	H
2118.9	-47.12	3.65	3	10.52	-40.25	-13	27.25	H
1413.0	-39.32	2.98	3	8.68	-33.62	-13	20.62	V
2118.9	-45.38	3.65	3	10.52	-38.51	-13	25.51	V

LTE FDD Band 17_Channel Bandwidth 5MHz_QPSK_Middle Channel

Frequency (MHz)	P_{Mea} (dBm)	P_{cl} (dB)	Diatance	G_a Antenna Gain(dB)	EIRP (dBm)	Limit (dBm)	Margin (dB)	Polarization
1420.0	-41.95	2.98	3	8.68	-36.25	-13	23.25	H
2130.0	-48.31	3.65	3	10.52	-41.44	-13	28.44	H
1420.0	-38.24	2.98	3	8.68	-32.54	-13	19.54	V
2130.0	-46.50	3.65	3	10.52	-39.63	-13	26.63	V

LTE FDD Band 17_Channel Bandwidth 5MHz_QPSK_High Channel

Frequency (MHz)	P_{Mea} (dBm)	P_{cl} (dB)	Diatance	G_a Antenna Gain(dB)	EIRP (dBm)	Limit (dBm)	Margin (dB)	Polarization
1427.0	-40.92	2.98	3	8.68	-35.22	-13	22.22	H
2140.5	-47.22	3.65	3	10.52	-40.35	-13	27.35	H
1427.0	-40.28	2.98	3	8.68	-34.58	-13	21.58	V
2140.5	-46.31	3.65	3	10.52	-39.44	-13	26.44	V

LTE FDD Band 17_Channel Bandwidth 10MHz_QPSK_Low Channel

Frequency (MHz)	P _{Mea} (dBm)	P _{cl} (dB)	Diatance	G _a Antenna Gain(dB)	Peak EIRP (dBm)	Limit (dBm)	Margin (dB)	Polarization
1418.0	-39.92	2.98	3	8.68	-34.22	-13	21.22	H
2127.0	-47.52	3.65	3	10.52	-40.65	-13	27.65	H
1418.0	-39.57	2.98	3	8.68	-33.87	-13	20.87	V
2127.0	-45.53	3.65	3	10.52	-38.66	-13	25.66	V

LTE FDD Band 17_Channel Bandwidth 10MHz_QPSK_Middle Channel

Frequency (MHz)	P _{Mea} (dBm)	P _{cl} (dB)	Diatance	G _a Antenna Gain(dB)	EIRP (dBm)	Limit (dBm)	Margin (dB)	Polarization
1420.0	-41.59	2.98	3	8.68	-35.89	-13	22.89	H
2130.0	-48.34	3.65	3	10.52	-41.47	-13	28.47	H
1420.0	-38.96	2.98	3	8.68	-33.26	-13	20.26	V
2130.0	-44.85	3.65	3	10.52	-37.98	-13	24.98	V

LTE FDD Band 17_Channel Bandwidth 10MHz_QPSK_High Channel

Frequency (MHz)	P _{Mea} (dBm)	P _{cl} (dB)	Diatance	G _a Antenna Gain(dB)	EIRP (dBm)	Limit (dBm)	Margin (dB)	Polarization
1422.0	-41.33	2.98	3	8.68	-35.63	-13	22.63	H
2133.0	-47.65	3.65	3	10.52	-40.78	-13	27.78	H
1422.0	-38.36	2.98	3	8.68	-32.66	-13	19.66	V
2133.0	-45.85	3.65	3	10.52	-38.98	-13	25.98	V

LTE FDD Band 17_Channel Bandwidth 5MHz_16QAM_Low Channel

Frequency (MHz)	P _{Mea} (dBm)	P _{cl} (dB)	Diatance	G _a Antenna Gain(dB)	Peak EIRP (dBm)	Limit (dBm)	Margin (dB)	Polarization
1413.0	-42.25	2.98	3	8.68	-36.55	-13	23.55	H
2118.9	-50.41	3.65	3	10.52	-43.54	-13	30.54	H
1413.0	-40.32	2.98	3	8.68	-34.62	-13	21.62	V
2118.9	-47.11	3.65	3	10.52	-40.24	-13	27.24	V

LTE FDD Band 17_Channel Bandwidth 5MHz_16QAM_Middle Channel

Frequency (MHz)	P _{Mea} (dBm)	P _{cl} (dB)	Diatance	G _a Antenna Gain(dB)	EIRP (dBm)	Limit (dBm)	Margin (dB)	Polarization
1413.0	-42.44	2.98	3	8.68	-36.74	-13	23.74	H
2118.9	-50.52	3.65	3	10.52	-43.65	-13	30.65	H
1413.0	-40.84	2.98	3	8.68	-35.14	-13	22.14	V
2118.9	-48.07	3.65	3	10.52	-41.20	-13	28.20	V

LTE FDD Band 17_Channel Bandwidth 5MHz_16QAM_High Channel

Frequency (MHz)	P _{Mea} (dBm)	P _{cl} (dB)	Diatance	G _a Antenna Gain(dB)	EIRP (dBm)	Limit (dBm)	Margin (dB)	Polarization
1427.0	-42.56	2.98	3	8.68	-36.86	-13	23.86	H
2140.5	-48.62	3.65	3	10.52	-41.75	-13	28.75	H
1427.0	-40.96	2.98	3	8.68	-35.26	-13	22.26	V
2140.5	-47.42	3.65	3	10.52	-40.55	-13	27.55	V

LTE FDD Band 17_Channel Bandwidth 10MHz_16QAM_Low Channel

Frequency (MHz)	P _{Mea} (dBm)	P _{cl} (dB)	Diatance	G _a Antenna Gain(dB)	Peak EIRP (dBm)	Limit (dBm)	Margin (dB)	Polarization
1427.0	-41.48	2.98	3	8.68	-35.78	-13	22.78	H
2140.5	-48.09	3.65	3	10.52	-41.22	-13	28.22	H
1427.0	-41.35	2.98	3	8.68	-35.65	-13	22.65	V
2140.5	-47.62	3.65	3	10.52	-40.75	-13	27.75	V

LTE FDD Band 17_Channel Bandwidth 10MHz_16QAM_Middle Channel

Frequency (MHz)	P _{Mea} (dBm)	P _{cl} (dB)	Diatance	G _a Antenna Gain(dB)	EIRP (dBm)	Limit (dBm)	Margin (dB)	Polarization
1413.0	-42.44	2.98	3	8.68	-36.74	-13	23.74	H
2118.9	-49.52	3.65	3	10.52	-42.65	-13	29.65	H
1413.0	-41.00	2.98	3	8.68	-35.30	-13	22.30	V
2118.9	-47.61	3.65	3	10.52	-40.74	-13	27.74	V

LTE FDD Band 17_Channel Bandwidth 10MHz_16QAM_High Channel

Frequency (MHz)	P _{Mea} (dBm)	P _{cl} (dB)	Diatance	G _a Antenna Gain(dB)	EIRP (dBm)	Limit (dBm)	Margin (dB)	Polarization
1427.0	-41.39	2.98	3	8.68	-35.69	-13	22.69	H
2140.5	-50.07	3.65	3	10.52	-43.20	-13	30.20	H
1427.0	-39.81	2.98	3	8.68	-34.11	-13	21.11	V
2140.5	-48.69	3.65	3	10.52	-41.82	-13	28.82	V

4.7. Frequency Stability under Temperature & Voltage Variations

LIMIT

According to §27.54, §2.1055 requirement, the frequency stability shall be sufficient to ensure that the fundamental emissions stay within the authorized bands of operation and should not exceed 2.5ppm.

TEST CONFIGURATION

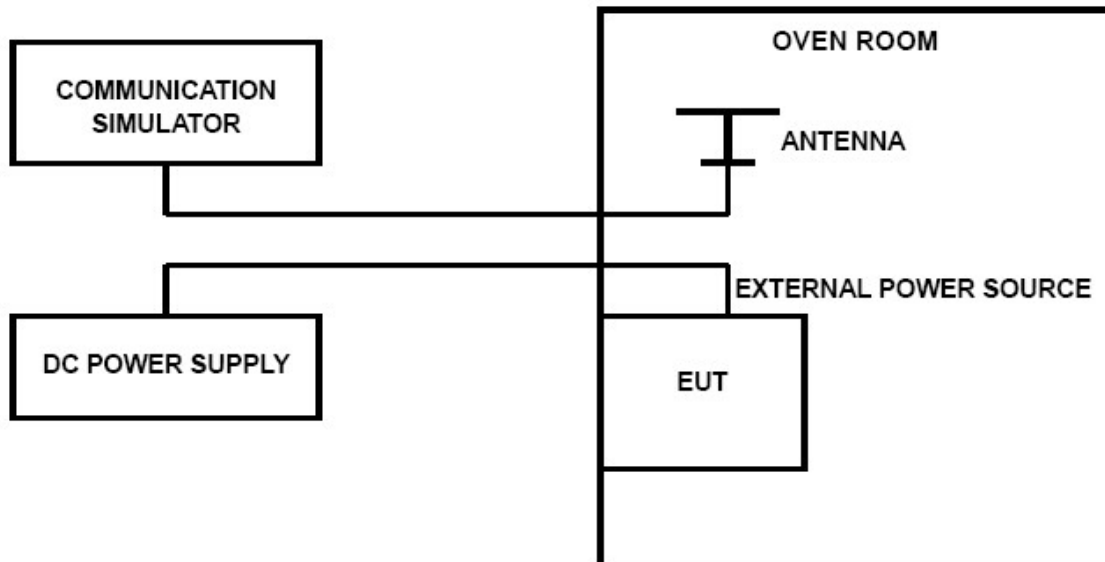

TEST PROCEDURE

The EUT was setup according to EIA/TIA 603D

Frequency Stability Under Temperature Variations:

In order to measure the carrier frequency under the condition of AFC lock, it is necessary to make measurements with the EUT in a "call mode". This is accomplished with the use of R&S CMW500 DIGITAL RADIO COMMUNICATION TESTER.

1. Measure the carrier frequency at room temperature.
2. Subject the EUT to overnight soak at -30°C.
3. With the EUT, powered via nominal voltage, connected to the CMW500 and in a simulated call on middle channel for LTE band 4, measure the carrier frequency. These measurements should be made within 2 minutes of Powering up the EUT, to prevent significant self-warming.
4. Repeat the above measurements at 10°C increments from -30°C to +50°C. Allow at least 1.5 hours at each temperature, unpowered, before making measurements.
5. Re-measure carrier frequency at room temperature with nominal voltage. Vary supply voltage from minimum voltage to maximum voltage, in 0.1Volt increments re-measuring carrier frequency at each voltage. Pause at nominal voltage for 1.5 hours unpowered, to allow any self-heating to stabilize, before continuing.
6. Subject the EUT to overnight soak at +50°C.
7. With the EUT, powered via nominal voltage, connected to the CMW500 and in a simulated call on the centre channel, measure the carrier frequency. These measurements should be made within 2 minutes of Powering up the EUT, to prevent significant self-warming.
8. Repeat the above measurements at 10 °C increments from +50°C to -30°C. Allow at least 1.5 hours at each temperature, unpowered, before making measurements
9. At all temperature levels hold the temperature to +/- 0.5°C during the measurement procedure.

Frequency Stability Under Voltage Variations:

Set chamber temperature to 20°C. Use a variable AC power supply / DC power source to power the EUT and set the voltage to rated voltage. Set the spectrum analyzer RBW low enough to obtain the desired frequency resolution and recorded the frequency.

Reduce the input voltage to specify extreme voltage variation ($\pm 15\%$) and endpoint, record the maximum frequency change.

TEST RESULTS

Remark:

1. We tested all RB Configuration refer 3GPP TS136 521 for each Channel Bandwidth of LTE FDD Band 17; recorded worst case.

LTE Band 17, 5 MHz bandwidth (worst case of all bandwidths)

Frequency Error vs Voltage

Voltage (V)	Frequency error (Hz)		Frequency error (ppm)		Limit (ppm)
	QPSK	16QAM	QPSK	16QAM	
3.50	5.26	-5.66	0.007408	-0.007972	2.50
3.80	5.78	-6.78	0.008141	-0.009549	2.50
4.20	7.59	-6.63	0.010690	-0.009338	2.50

Frequency Error vs Temperature

Temperature (°C)	Frequency error (Hz)		Frequency error (ppm)		Limit (ppm)
	QPSK	16QAM	QPSK	16QAM	
-30°	5.84	-4.58	0.008225	-0.006451	2.50
-20°	6.98	3.26	0.009831	0.004592	2.50
-10°	5.24	5.88	0.007380	0.008282	2.50
0°	-5.66	6.33	-0.007972	0.008915	2.50
10°	-5.75	-6.89	-0.008099	-0.009704	2.50
20°	-6.25	-7.22	-0.008803	-0.010169	2.50
30°	6.30	-7.69	0.008873	-0.010831	2.50
40°	5.59	-6.87	0.007873	-0.009676	2.50
50°	6.25	-6.95	0.008803	-0.009789	2.50

5. Test Setup Photos of the EUT

Please refer to separated files for Test Setup Photos of the EUT.

6. External Photos of the EUT

Please refer to separated files for External Photos of the EUT.

7. Internal Photos of the EUT

Please refer to separated files for Internal Photos of the EUT.

***** **End of Report** *****