

**FCC SAR**  
**Measurement and Test Report**  
**For**  
**Hyundai Corporation**  
**25, Yulgok-ro 2-Gil, Jongno-gu, Seoul, South Korea**

**FCC ID: RQQHLT-FS50403**

<b>Test Standards:</b>	FCC Part 2.1093 ANSI / IEEE C95.1 ::2005+A1:2010 ANSI / IEEE C95.3 : 2002(R2008) <u>IEEE 1528 :2013</u>
<b>Product Description:</b>	<u>4G Smart Phone</u>
<b>Tested Model:</b>	<u>L503F PLUS</u>
<b>Report No.:</b>	<u>STR18108046H</u>
<b>Sample Received Date:</b>	<u>2018-10-29</u>
<b>Tested Date:</b>	<u>2018-10-29 to 2018-11-01</u>
<b>Issued Date:</b>	<u>2018-11-23</u>
<b>Tested By:</b>	<u>Lucy Wei / Engineer</u> <i>Lucy Wei</i>
<b>Reviewed By:</b>	<u>Silin Chen / EMC Manager</u> <i>Silin Chen</i>
<b>Approved &amp; Authorized By:</b>	<u>Jandy So / PSQ Manager</u> <i>Jandy So</i>
<b>Prepared By:</b>	
<b>Shenzhen SEM Test Technology Co., Ltd.</b> 1/F, Building A, Hongwei Industrial Park, Liuxian 2nd Road, Bao'an District, Shenzhen, P.R.C. (518101) Tel.: +86-755-33663308 Fax.: +86-755-33663309 Website: www.semtest.com.cn	

Note: This test report is limited to the above client company and the product model only. It may not be duplicated without prior permitted by Shenzhen SEM Test Technology Co., Ltd.

## **TABLE OF CONTENTS**

<b>1. General Information</b>	<b>3</b>
1.1 Product Description for Equipment Under Test (EUT)	3
1.2 Test Standards	6
1.3 Test Methodology	6
1.4 Test Facility	6
<b>2. Summary of Test Results</b>	<b>7</b>
<b>3. Specific Absorption Rate (SAR)</b>	<b>8</b>
3.1 Introduction	8
3.2 SAR Definition	8
<b>4. SAR Measurement System</b>	<b>9</b>
4.1 The Measurement System	9
4.2 Probe	9
4.3 Probe Calibration Process	11
4.4 Phantom	12
4.5 Device Holder	12
4.6 Test Equipment List	13
<b>5. Tissue Simulating Liquids</b>	<b>14</b>
5.1 Composition of Tissue Simulating Liquid	14
5.2 Tissue Dielectric Parameters for Head and Body Phantoms	15
5.3 Tissue Calibration Result	16
<b>6. SAR Measurement Evaluation</b>	<b>17</b>
6.1 Purpose of System Performance Check	17
6.2 System Setup	17
6.3 Validation Results	18
<b>7. EUT Testing Position</b>	<b>20</b>
7.1 Define Two Imaginary Lines on The Handset	20
7.2 Cheek Position	20
7.3 Tilted Position	21
7.4 Body Worn Position	22
7.5 EUT Antenna Position	22
7.6 EUT Testing Position	24
<b>8. SAR Measurement Procedures</b>	<b>25</b>
8.1 Measurement Procedures	25
8.2 Spatial Peak SAR Evaluation	25
8.3 Area & Zoom Scan Procedures	26
8.4 Volume Scan Procedures	26
8.5 SAR Averaged Methods	26
8.6 Power Drift Monitoring	26
<b>9. SAR Test Result</b>	<b>27</b>
9.1 Conducted RF Output Power	27
9.2 Test Results for Standalone SAR Test	50
9.3 Simultaneous Multi-band Transmission SAR Analysis	58
<b>10. Measurement Uncertainty</b>	<b>64</b>
10.1 Uncertainty for EUT SAR Test	64
10.2 Uncertainty for System Performance Check	65
<b>Annex A. Plots of System Performance Check</b>	<b>67</b>
<b>Annex B. Plots of SAR Measurement</b>	<b>87</b>
<b>Annex C. EUT Photos</b>	<b>131</b>
<b>Annex D. Test Setup Photos</b>	<b>133</b>
<b>Annex E. Calibration Certificate</b>	<b>138</b>

## 1. General Information

### 1.1 Product Description for Equipment Under Test (EUT)

#### Client Information

Applicant: Hyundai Corporation  
Address of applicant: 25, Yulgok-ro 2-Gil, Jongno-gu, Seoul, South Korea

Manufacturer: Hyundai Corporation  
Address of manufacturer: 25, Yulgok-ro 2-Gil, Jongno-gu, Seoul, South Korea

General Description of EUT:	
Product Name:	4G Smart Phone
Brand Name:	HYUNDAI
Model No.:	L503F PLUS
Adding Model(s):	L503FS PLUS
Rated Voltage:	DC 3.7V by Battery
Battery:	2200mAh
Device Category:	Portable Device
<i>The EUT Main board support GSM850/PCS1900, WCDMA Band 2/5, FDD LTE Band 2/4/7 function. It is intended for speech, Multimedia Message Service (MMS) transmission. It is equipped with GPRS/EDGE class 12 for GSM850/PCS1900, GPS, FM, Bluetooth and Wi-Fi functions. For more information see the following datasheet.</i>	
<i>Note: The test data is gathered from a production sample provided by the manufacturer. The appearance of others models listed in the report is different from main-test model L503F PLUS, but the circuit and the electronic construction do not change, declared by the manufacturer.</i>	

<b>Technical Characteristics of EUT:</b>	
<b>2G</b>	
Support Networks:	GSM, GPRS, EDGE
Support Band:	GSM850/PCS1900
Uplink Frequency:	GSM/GPRS/EDGE 850: 824~849MHz GSM/GPRS/EDGE 1900: 1850~1910MHz
Downlink Frequency:	GSM/GPRS/EDGE 850: 869~894MHz GSM/GPRS/EDGE 1900: 1930~1990MHz
Max RF Output Power:	GSM850: 33.43dBm, GSM1900: 30.60dBm EDGE850: 26.13dBm, EDGE1900: 25.65dBm
Type of Modulation:	GMSK, 8PSK
Type of Antenna:	Integral Antenna
Antenna Gain:	GSM850: 0.49dBi; GSM1900: 0.54dBi
GPRS/EDGE Class:	Class 12
<b>3G</b>	
Support Networks:	WCDMA, HSDPA, HSUPA
Support Band:	WCDMA Band 2, WCDMA Band 5
Uplink Frequency:	WCDMA Band 2: 1850~1910MHz WCDMA Band 5: 824~849MHz
Downlink Frequency:	WCDMA Band 2: 1930~1990MHz WCDMA Band 5: 869~894MHz
RF Output Power:	WCDMA Band 2: 21.62dBm, WCDMA Band 5: 21.67dBm
Type of Modulation:	BPSK
Antenna Type:	Integral Antenna
Antenna Gain:	WCDMA Band 2: 0.54dBi, WCDMA Band 5: 0.49dBi
<b>4G</b>	
Support Networks:	FDD-LTE
Support Band:	FDD-LTE Band 2, 4, 7
Uplink Frequency:	FDD-LTE Band 2: Tx: 1850-1910MHz, FDD-LTE Band 4: Tx: 1710-1755MHz, FDD-LTE Band 7: Tx: 2500-2570MHz,
Downlink Frequency:	FDD-LTE Band 2: Rx: 1930-1990MHz, FDD-LTE Band 4: Rx: 2110-2155MHz, FDD-LTE Band 7: Rx: 2620-2690MHz,
RF Output Power:	FDD-LTE Band 2: 23.37dBm, FDD-LTE Band 4: 23.99dBm, FDD-LTE Band 7: 23.61dBm
Type of Modulation:	QPSK, 16QAM
Antenna Type:	Integral Antenna
Antenna Gain:	FDD-LTE Band 2: 0.54dBi, FDD-LTE Band 4: 0.56dBi,

	FDD-LTE Band 7: 0.53dBi,
<b>WIFI</b>	
Support Standards:	802.11b, 802.11g, 802.11n
Frequency Range:	2412-2462MHz for 11b/g/n(HT20)
RF Output Power:	12.87dBm (Conducted)
Type of Modulation:	CCK, OFDM, QPSK, BPSK, 16QAM, 64QAM
Data Rate:	1-11Mbps, 6-54Mbps, up to 72.7Mbps
Quantity of Channels:	11
Channel Separation:	5MHz
Antenna Type:	Integral Antenna
Antenna Gain:	0.45dBi
<b>Bluetooth</b>	
Bluetooth Version:	V4.0
Frequency Range:	2402-2480MHz
RF Output Power:	6.061dBm (Conducted)
Data Rate:	1Mbps, 2Mbps, 3Mbps
Modulation:	GFSK, Pi/4 QDPSK, 8DPSK
Quantity of Channels:	79/40
Channel Separation:	1MHz/2MHz
Antenna Type:	Integral Antenna
Antenna Gain:	0.45dBi

## 1.2 Test Standards

The following report is prepared on behalf of the Hyundai Corporation in accordance with FCC 47 CFR Part 2.1093, ANSI/IEEE C95.1-2005, ANSI / IEEE C95.3 :2002, IEEE 1528-2013, KDB 447498 D01 v06, KDB 648474 D04 v01r03, KDB 248227 D01 v02r02, KDB 941225 D01 v03r01, KDB 941225 D05 v02r05 ,KDB 941225 D06 v02r01, and KDB 865664 D01 v01r04 and KDB 865664 D02 v01r02.

The objective is to determine compliance with FCC Part 2.1093 of the Federal Communication Commissions rules.

*Maintenance of compliance* is the responsibility of the manufacturer. Any modification of the product, which result in lowering the emission, should be checked to ensure compliance has been maintained.

## 1.3 Test Methodology

All measurements contained in this report were conducted with KDB 865664 D01 v01r04 and KDB 865664 D02 v01r02. The public notice KDB 447498 D01 v06 for Mobile and Portable Devices RF Exposure Procedure also.

## 1.4 Test Facility

### **FCC – Registration No.: 125990**

Shenzhen SEM Test Technology Co., Ltd. Laboratory has been recognized to perform compliance testing on equipment subject to the Commissions Declaration Of Conformity (DOC). The Designation Number is CN5010, and Test Firm Registration Number is 125990.

### **Industry Canada (IC) Registration No.: 11464A**

The 3m Semi-anechoic chamber of Shenzhen SEM.Test Technology Co., Ltd. has been registered by Certification and Engineering Bureau of Industry Canada for radio equipment testing with Registration No.: 11464A.

## 2. Summary of Test Results

The maximum results of Specific Absorption Rate (SAR) have found during testing are as follows:

Frequency Band	Head SAR	Body-worn (10mm Gap)	Hotspot (10mm Gap)	SAR <sub>1g</sub> Limit (W/kg)
	Maximum SAR <sub>1g</sub> (W/kg)	Maximum SAR <sub>1g</sub> (W/kg)	Maximum SAR <sub>1g</sub> (W/kg)	Maximum SAR <sub>10g</sub> (W/kg)
GSM	<b>0.852</b>	<b>0.966</b>	<b>0.670</b>	1.6
WCDMA	0.326	0.384	0.384	1.6
FDD-LTE	0.561	0.381	0.381	1.6
WLAN 2.4G	0.557	0.297	0.297	1.6
Simultaneous Transmission	<b>1.409</b>	1.263	0.967	1.6

**Remark:**

*The highest reported SAR values for head, body-worn accessory, wireless router(hotspot), and simultaneous transmission conditions are **0.852W/kg, 0.966W/kg, 0.670W/kg, and 1.409W/kg** respectively.*

The device is in compliance with Specific Absorption Rate (SAR) for general population/uncontrolled exposure limits (1.6 W/kg) specified in FCC 47 CFR Part 2.1093 and ANSI/IEEE C95.1-2005, and had been tested in accordance with the measurement methods and procedure specified in IEEE 1528-2013 and KDB 865664 D01 v01r04 and KDB 865664 D02 v01r02

### 3. Specific Absorption Rate (SAR)

---

#### 3.1 Introduction

SAR is related to the rate at which energy is absorbed per unit mass in an object exposed to a radio field. The SAR distribution in a biological body is complicated and is usually carried out by experimental techniques or numerical modeling. The standard recommends limits for two tiers of groups, occupational/controlled and general population/uncontrolled, based on a person's awareness and ability to exercise control over his or her exposure. In general, occupational/controlled exposure limits are higher than the limits for general population/uncontrolled.

#### 3.2 SAR Definition

The SAR definition is the time derivative (rate) of the incremental energy (dW) absorbed by (dissipated in) an incremental mass (dm) contained in a volume element (dv) of a given density ( $\rho$ ). The equation description is as below:

$$\text{SAR} = \frac{d}{dt} \left( \frac{dW}{dm} \right) = \frac{d}{dt} \left( \frac{dW}{\rho dv} \right)$$

SAR is expressed in units of Watts per kilogram (W/kg)

SAR measurement can be either related to the temperature elevation in tissue by

$$\text{SAR} = C \left( \frac{\delta T}{\delta t} \right)$$

Where: C is the specific heat capacity,  $\delta T$  is the temperature rise and  $\delta t$  is the exposure duration, or related to the electrical field in the tissue by

$$\text{SAR} = \frac{\sigma |E|^2}{\rho}$$

Where:  $\sigma$  is the conductivity of the tissue,  $\rho$  is the mass density of the tissue and E is the RMS electrical field strength.

However for evaluating SAR of low power transmitter, electrical field measurement is typically applied.



## 4. SAR Measurement System

---

### 4.1 The Measurement System

Comosar is a system that is able to determine the SAR distribution inside a phantom of human being according to different standards. The Comosar system consists of the following items:

- Main computer to control all the system
- 6 axis robot
- Data acquisition system
- Miniature E-field probe
- Phone holder
- Head simulating tissue

The following figure shows the system.



The EUT under test operating at the maximum power level is placed in the phone holder, under the phantom, which is filled with head simulating liquid. The E-Field probe measures the electric field inside the phantom. The OpenSAR software computes the results to give a SAR value in a 1g or 10g mass.

### 4.2 Probe

For the measurements the Specific Dosimetric E-Field Probe SSE5 SN 09/13 EP168 with following specifications is used

- Dynamic range: 0.01-100 W/kg
- Probe Length: 330 mm
- Length of Individual Dipoles: 4.5 mm
- Maximum external diameter: 8 mm
- Probe Tip External Diameter : 5 mm
- Distance between dipoles / probe extremity: 2.7mm

- Probe linearity: <0.25 dB
  - Axial Isotropy: <0.25 dB
  - Spherical Isotropy: <0.50 dB
  - Calibration range: 700 to 3000MHz for head & body simulating liquid.
- Angle between probe axis (evaluation axis) and surface normal line: less than 30°

Probe calibration is realized, in compliance with EN 62209-1 and IEEE 1528 STD, with CALISAR, Antennessa proprietary calibration system. The calibration is performed with the EN 62209-1 annexe technique using reference guide at the five frequencies.

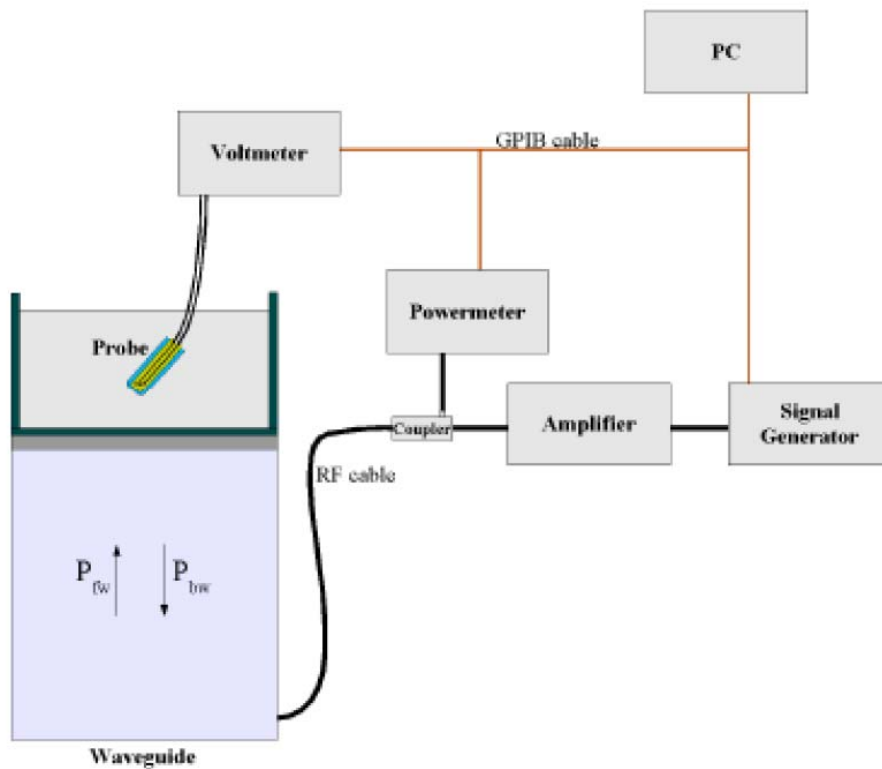

$$SAR = \frac{4(P_{fw} - P_{bw})}{ab\delta} \cos^2\left(\pi \frac{y}{a}\right) e^{-2z/\delta}$$

Where :

$P_{fw}$  = Forward Power

$P_{bw}$  = Backward Power

a and b = Waveguide dimensions

$\delta$  = Skin depth

Keithley configuration:

Rate = Medium; Filter = ON; RDGS = 10; Filter type = Moving Average; Range auto after each calibration, a SAR measurement is performed on a validation dipole and compared with a NPL calibrated probe, to verify it.

The calibration factors, CF(N), for the 3 sensors corresponding to dipole 1, dipole 2 and dipole 3 are:

$$CF(N)=SAR(N)/V_{lin}(N) \quad (N=1,2,3)$$

The linearised output voltage  $V_{lin}(N)$  is obtained from the displayed output voltage  $V(N)$  using

$$V_{lin}(N)=V(N)*(1+V(N)/DCP(N)) \quad (N=1,2,3)$$

where DCP is the diode compression point in mV.

### 4.3 Probe Calibration Process

#### Dosimetric Assessment Procedure

Each E-Probe/Probe Amplifier combination has unique calibration parameters. SATIMO Probe calibration procedure is conducted to determine the proper amplifier settings to enter in the probe parameters. The amplifier settings are determined for a given frequency by subjecting the probe to a known E-field density (1 mW/cm<sup>2</sup>) using an with CALISAR, Antenna proprietary calibration system.

#### Free Space Assessment Procedure

The free space E-field from amplified probe outputs is determined in a test chamber. This calibration can be performed in a TEM cell if the frequency is below 1 GHz and in a waveguide or other methodologies above 1 GHz for free space. For the free space calibration, the probe is placed in the volumetric center of the cavity and at the proper orientation with the field. The probe is rotated 360 degrees until the three channels show the maximum reading. The power density readings equates to 1mW/cm<sup>2</sup>.

#### Temperature Assessment Procedure

E-field temperature correlation calibration is performed in a flat phantom filled with the appropriate simulated head tissue. The E-field in the medium correlates with the temperature rise in the dielectric medium. For temperature correlation calibration a RF transparent thermistor-based temperature probe is used in conjunction with the E-field probe.

Where:

$$SAR = C \frac{\Delta T}{\Delta t}$$

$\Delta t$  = exposure time (30 seconds),

$C$  = heat capacity of tissue (brain or muscle),

$\Delta T$  = temperature increase due to RF exposure.

SAR is proportional to  $\Delta T/\Delta t$ , the initial rate of tissue heating, before thermal diffusion takes place. The electric field in the simulated tissue can be used to estimate SAR by equating the thermally derived SAR to that with the E- field component.

$$SAR = \frac{|E|^2 \cdot \sigma}{\rho}$$

Where:

$\sigma$  = simulated tissue conductivity,

$\rho$  = Tissue density (1.25 g/cm<sup>3</sup> for brain tissue)

#### 4.4 Phantom

For the measurements the Specific Anthropomorphic Mannequin (SAM) defined by the IEEE SCC-34/SC2 group is used. The phantom is a polyurethane shell integrated in a wooden table. The thickness of the phantom amounts to 2mm +/- 0.2mm. It enables the dosimetric evaluation of left and right phone usage and includes an additional flat phantom part for the simplified performance check. The phantom set-up includes a cover, which prevents the evaporation of the liquid.

#### 4.5 Device Holder

The positioning system allows obtaining cheek and tilting position with a very good accuracy. In compliance with CENELEC, the tilt angle uncertainty is lower than 1°.

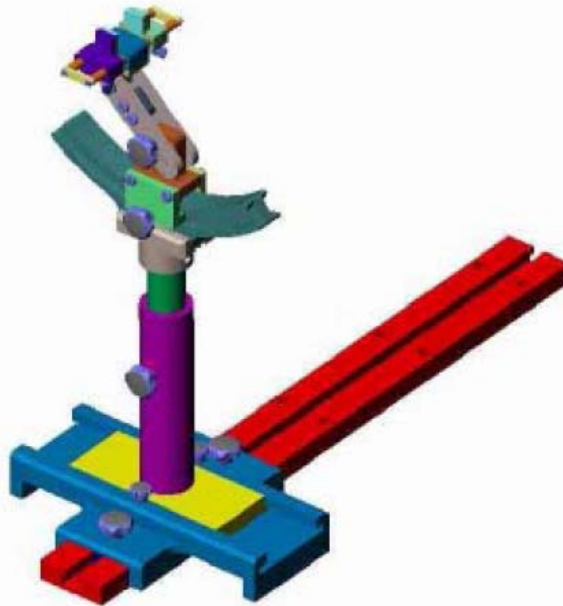

System Material	Permittivity	Loss Tangent
Delrin	3.7	0.005

#### 4.6 Test Equipment List

Description	Manufacturer	Model	Serial Number	Cal. Date	Due. Date
E-Field Probe	MVG	SSE5	SN 09/13 EP168	2018-06-01	2019-05-31
835MHz Dipole	MVG	SID835	SN 47/12 DIP 0G835-204	2018-03-20	2019-03-19
1800MHz Dipole	MVG	SID1800	SN 47/12 DIP 1G800-206	2018-03-20	2019-03-19
1900MHz Dipole	MVG	SID1900	SN 47/12 DIP 1G900-207	2018-03-20	2019-03-19
2450MHz Dipole	MVG	SID2450	SN 13/15 DIP 2G450-364	2018-03-20	2019-03-19
2600MHz Dipole	MVG	SID2600	SN 13/15 DIP 2G600-365	2018-03-20	2019-03-19
Dielectric Probe Kit	SATIMO	SCLMP	SN 47/12 OCPG49	2018-03-20	2019-03-19
SAM Phantom	SATIMO	SAM	SN/ 47/12 SAM95	N/A	N/A
MULTIMETER	KEITHLEY	Keithley 2000	4006367	2018-05-22	2019-05-21
Signal Generator	Rohde & Schwarz	SMR20	100047	2018-05-22	2019-05-21
Universal Tester	Rohde & Schwarz	CMU200	112012	2018-05-22	2019-05-21
Communications Tester	Rohde & Schwarz	CMW500	148650	2018-05-22	2019-05-21
Network Analyzer	HP	8753C	SEMT-1064	2018-05-22	2019-05-21
Directional Couplers	Agilent	778D	20160	2018-05-22	2019-05-21

## 5. Tissue Simulating Liquids

### 5.1 Composition of Tissue Simulating Liquid

For the measurement of the field distribution inside the SAM phantom with SMTIMO, the phantom must be filled with around 25 liters of homogeneous body tissue simulating liquid. For head SAR testing, the liquid height from the ear reference point (ERP) of the phantom to the liquid top surface is larger than 15 cm. For body SAR testing, the liquid height from the center of the flat phantom to the liquid top surface is larger than 15 cm. The depth of tissue-equivalent liquid in a phantom must be  $\geq 15.0$  cm with  $\leq \pm 0.5$  cm variation for SAR measurements  $\leq 3$  GHz. Please see the following photos for the liquid height.

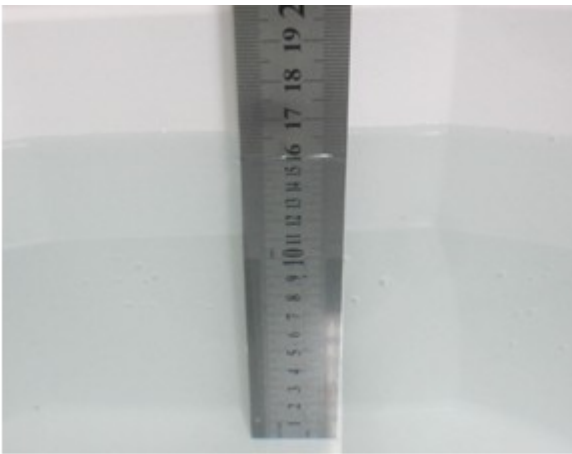

Liquid Height for Head SAR

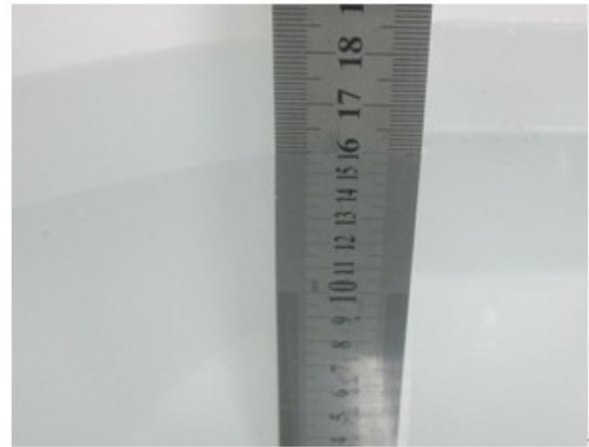

Liquid Height for Body SAR

#### The Composition of Tissue Simulating Liquid

Frequency (MHz)	Water (%)	Salt (%)	Sugar (%)	HEC (%)	Preventol (%)	DGBE (%)
<b>Head</b>						
835	40.3	1.4	57.9	0.2	0.2	0
1700-1900	55.2	0.3	0	0	0	44.5
2450	55.0	0.1	0	0	0	44.9
2600	54.9	0.1	0	0	0	45.0
<b>Body</b>						
835	50.8	0.9	48.1	0.1	0.1	0
1700-1900	70.2	0.4	0	0	0	29.4
2450	68.6	0.1	0	0	0	31.3
2600	68.2	0.1	0	0	0	31.7

## 5.2 Tissue Dielectric Parameters for Head and Body Phantoms

The head tissue dielectric parameters recommended by the IEEE SCC-34/SC-2 in P1528 have been incorporated in the following table. These head parameters are derived from planar layer models simulating the highest expected SAR for the dielectric properties and tissue thickness variations in a human head. Other head and body tissue parameters that have not been specified in P1528 are derived from the tissue dielectric parameters computed from the 4-Cole-Cole equations described in Reference [12] and extrapolated according to the head parameters specified in P1528.

Target Frequency (MHz)	Head		Body	
	Conductivity ( $\sigma$ )	Permittivity ( $\epsilon_r$ )	Conductivity ( $\sigma$ )	Permittivity ( $\epsilon_r$ )
150	0.76	52.3	0.80	61.9
300	0.87	45.3	0.92	58.2
450	0.87	43.5	0.94	56.7
<b>750</b>	<b>0.89</b>	<b>41.9</b>	<b>0.96</b>	<b>55.5</b>
<b>835</b>	<b>0.90</b>	<b>41.5</b>	<b>0.97</b>	<b>55.2</b>
900	0.97	41.5	1.05	55.0
915	0.98	41.5	1.06	55.0
1450	1.20	40.5	1.30	54.0
1610	1.29	40.3	1.40	53.8
<b>1750</b>	<b>1.37</b>	<b>40.1</b>	<b>1.49</b>	<b>53.4</b>
<b>1800-2000</b>	<b>1.40</b>	<b>40.0</b>	<b>1.52</b>	<b>53.3</b>
<b>2450</b>	<b>1.80</b>	<b>39.2</b>	<b>1.95</b>	<b>52.7</b>
3000	2.40	38.5	2.73	52.0
5800	5.27	35.3	6.00	48.2

### 5.3 Tissue Calibration Result

The dielectric parameters of the liquids were verified prior to the SAR evaluation using COMOSAR Dielectric Probe Kit and an Agilent Network Analyzer.

#### Calibration Result for Dielectric Parameters of Tissue Simulating Liquid

Head Tissue Simulating Liquid									
Freq. MHz.	Temp. (°C)	Conductivity			Permittivity			Limit (%)	Date
		Reading ( $\sigma$ )	Target ( $\sigma$ )	Delta (%)	Reading ( $\epsilon_r$ )	Target ( $\epsilon_r$ )	Delta (%)		
835	21.2	0.87	0.90	-3.33	41.11	41.50	-0.94	±5	2018-10-29
1750	21.3	1.37	1.37	0.00	39.02	40.1	-2.69	±5	2018-10-30
1800	21.3	1.37	1.40	-2.14	39.02	40.0	-2.45	±5	2018-10-30
1900	21.3	1.38	1.40	-1.43	38.56	40.00	-3.60	±5	2018-10-30
2450	21.3	1.74	1.80	-3.33	38.15	39.20	-2.68	±5	2018-10-31
2600	21.3	1.93	1.96	-1.53	38.63	39.0	-0.95	±5	2018-10-31

Body Tissue Simulating Liquid									
Freq. MHz.	Temp. (°C)	Conductivity			Permittivity			Limit (%)	Date
		Reading ( $\sigma$ )	Target ( $\sigma$ )	Delta (%)	Reading ( $\epsilon_r$ )	Target ( $\epsilon_r$ )	Delta (%)		
835	21.2	0.95	0.97	-2.06	54.85	55.20	-0.63	±5	2018-10-29
1750	21.3	1.46	1.49	-2.01	51.22	53.40	-4.08	±5	2018-10-30
1800	21.3	1.46	1.52	-3.95	51.22	53.30	-3.90	±5	2018-10-30
1900	21.3	1.50	1.52	-1.32	52.42	53.30	-1.65	±5	2018-10-30
2450	21.3	1.91	1.95	-2.05	52.01	52.70	-1.31	±5	2018-10-31
2600	21.3	2.12	2.16	-1.85	52.24	52.50	-0.50	±5	2018-10-31



## 6. SAR Measurement Evaluation

### 6.1 Purpose of System Performance Check

The system performance check verifies that the system operates within its specifications. System and operator errors can be detected and corrected. It is recommended that the system performance check be performed prior to any usage of the system in order to guarantee reproducible results. The system performance check uses normal SAR measurements in a simplified setup with a well characterized source. This setup was selected to give a high sensitivity to all parameters that might fail or vary over time. The system check does not intend to replace the calibration of the components, but indicates situations where the system uncertainty is exceeded due to drift or failure.

### 6.2 System Setup

In the simplified setup for system evaluation, the EUT is replaced by a calibrated dipole and the power source is replaced by a continuous wave which comes from a signal generator at frequency 835 MHz and 1900MHz. The calibrated dipole must be placed beneath the flat phantom section of the SAM twin phantom with the correct distance holder. The distance holder should touch the phantom surface with a light pressure at the reference marking and be oriented parallel to the long side of the phantom.

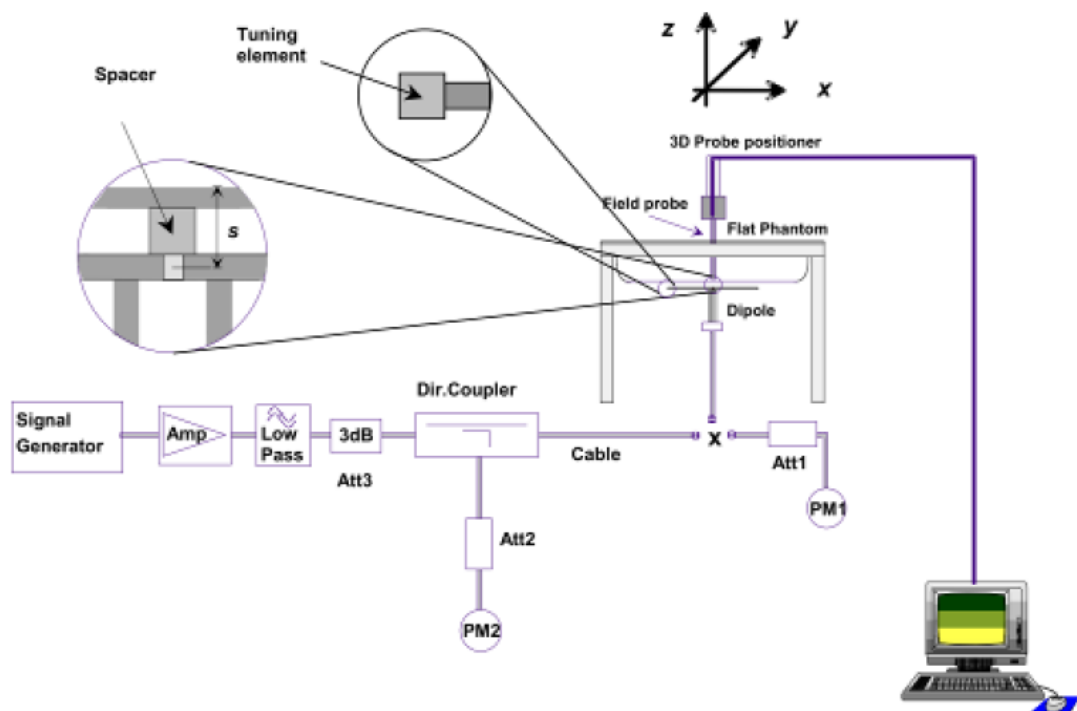

System Verification Setup Block Diagram



**Setup Photo of Dipole Antenna**

The output power on dipole port must be calibrated to 24 dBm(250 mW) before dipole is connected.

### 6.3 Validation Results

Comparing to the original SAR value provided by SATIMO, the validation data should be within its specification of 10 %. Table 6.1 shows the target SAR and measured SAR after normalized to 1W input power. The table below indicates the system performance check can meet the variation criterion.

Frequency	Targeted SAR <sub>1g</sub>	Measured SAR <sub>1g</sub>	Normalized SAR <sub>1g</sub>	Tolerance
MHz	(W/kg)	(W/kg)	(W/kg)	(%)
Head				
835	9.67	2.41	9.64	-0.31
1800	38.51	9.61	38.44	-0.18
1900	39.58	9.91	39.64	0.15
2450	53.69	13.45	53.8	0.20
2600	55.13	13.67	54.68	-0.82
Body				
835	9.38	2.35	9.4	0.21
1800	38.31	9.58	38.32	0.03
1900	39.10	9.78	39.12	0.05
2450	50.41	12.59	50.36	-0.10
2600	53.89	13.43	53.72	-0.32

**Remark:** Referring to IEEE 1528-2013, Section 8.2, The system check shall be performed at a test frequency that is within  $\pm 10\%$  or  $\pm 100$  MHz of the compliance test mid-band frequency, so the 1750 MHz system verification is made of 1800MHz Dipole.

## Targeted and Measurement SAR

*Please refer to Annex A for the plots of system performance check.*

## 7. EUT Testing Position

### 7.1 Define Two Imaginary Lines on The Handset

- (a) The vertical centerline passes through two points on the front side of the handset - the midpoint of the width  $w_t$  of the handset at the level of the acoustic output, and the midpoint of the width  $w_b$  of the bottom of the handset.
- (b) The horizontal line is perpendicular to the vertical centerline and passes through the center of the acoustic output. The horizontal line is also tangential to the face of the handset at point A.
- (c) The two lines intersect at point A. Note that for many handsets, point A coincides with the center of the acoustic output; however, the acoustic output may be located elsewhere on the horizontal line. Also note that the vertical centerline is not necessarily parallel to the front face of the handset, especially for clamshell handsets, handsets with flip covers, and other irregularly shaped handsets.

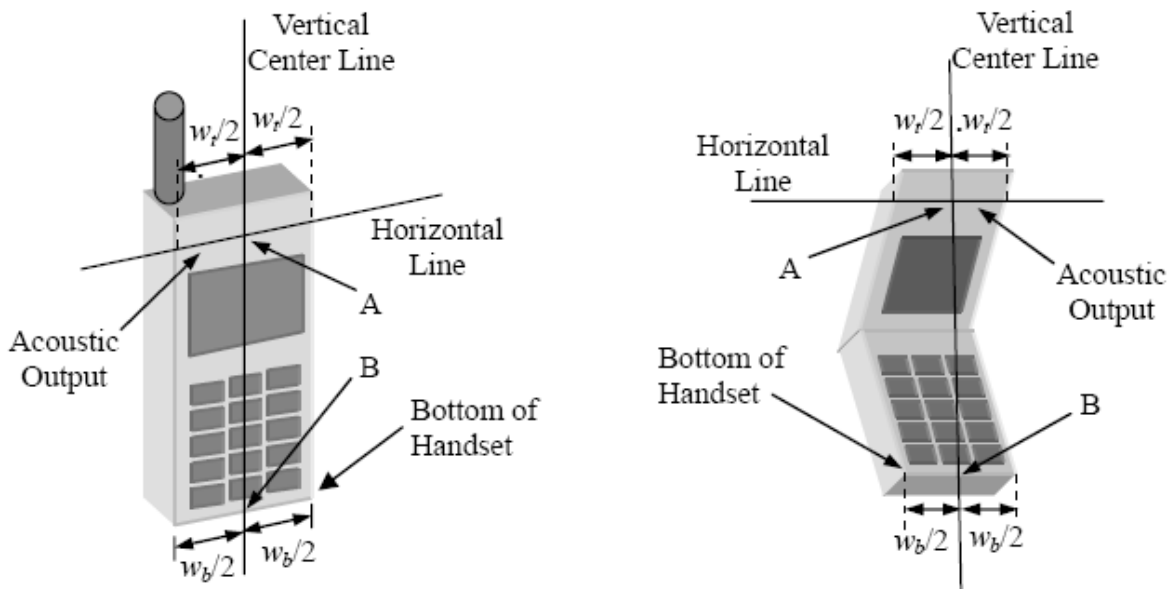

**Illustration for Handset Vertical and Horizontal Reference Lines**

### 7.2 Check Position

- (a) To position the device with the vertical center line of the body of the device and the horizontal line crossing the center piece in a plane parallel to the sagittal plane of the phantom. While maintaining the device in this plane, align the vertical center line with the reference plane containing the three ear and mouth reference point (M: Mouth, RE: Right Ear, and LE: Left Ear) and align the center of the ear piece with the line RE-LE.
- (b) To move the device towards the phantom with the ear piece aligned with the line LE-RE until the phone touched the ear. While maintaining the device in the reference plane and maintaining the phone contact with the ear, move the bottom of the phone until any point on the front side is in contact with the cheek of the phantom or until contact with the ear is lost (see Fig. 7.2).

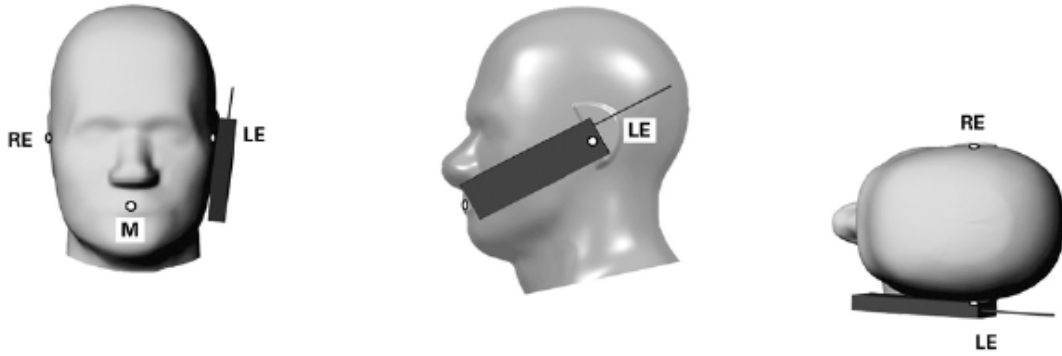

Illustration for Cheek Position

### 7.3 Tilted Position

- (a) To position the device in the “cheek” position described above.
- (b) While maintaining the device the reference plane described above and pivoting against the ear, moves it outward away from the mouth by an angle of 15 degrees or until contact with the ear is lost (see Fig. 7.3).

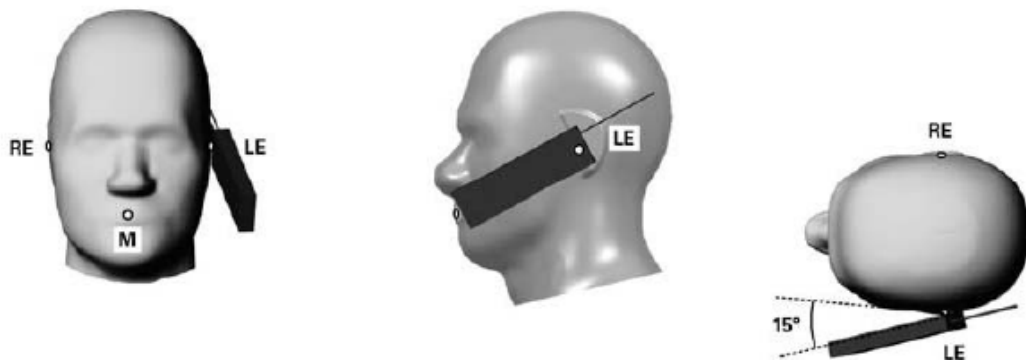

Illustration for Tilted Position

## 7.4 Body Worn Position

- To position the device parallel to the phantom surface with either keypad up or down.
- To adjust the device parallel to the flat phantom.
- To adjust the distance between the device surface and the flat phantom to 10mm.

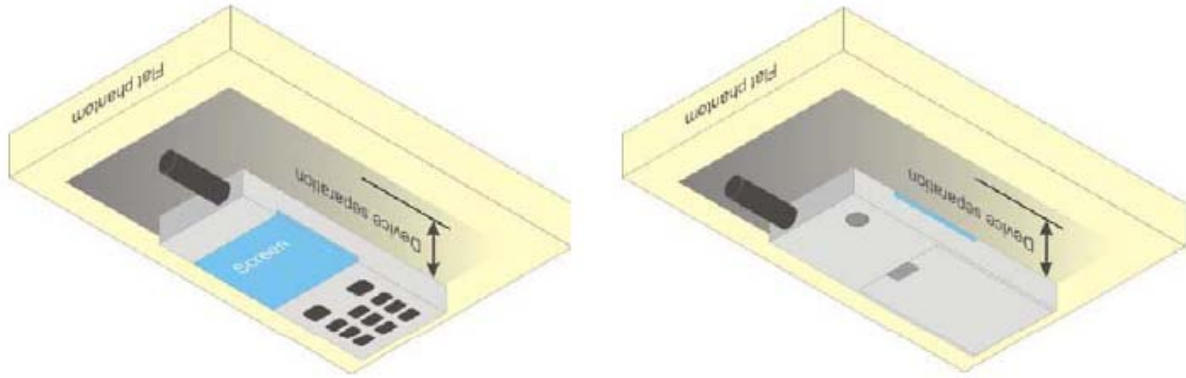
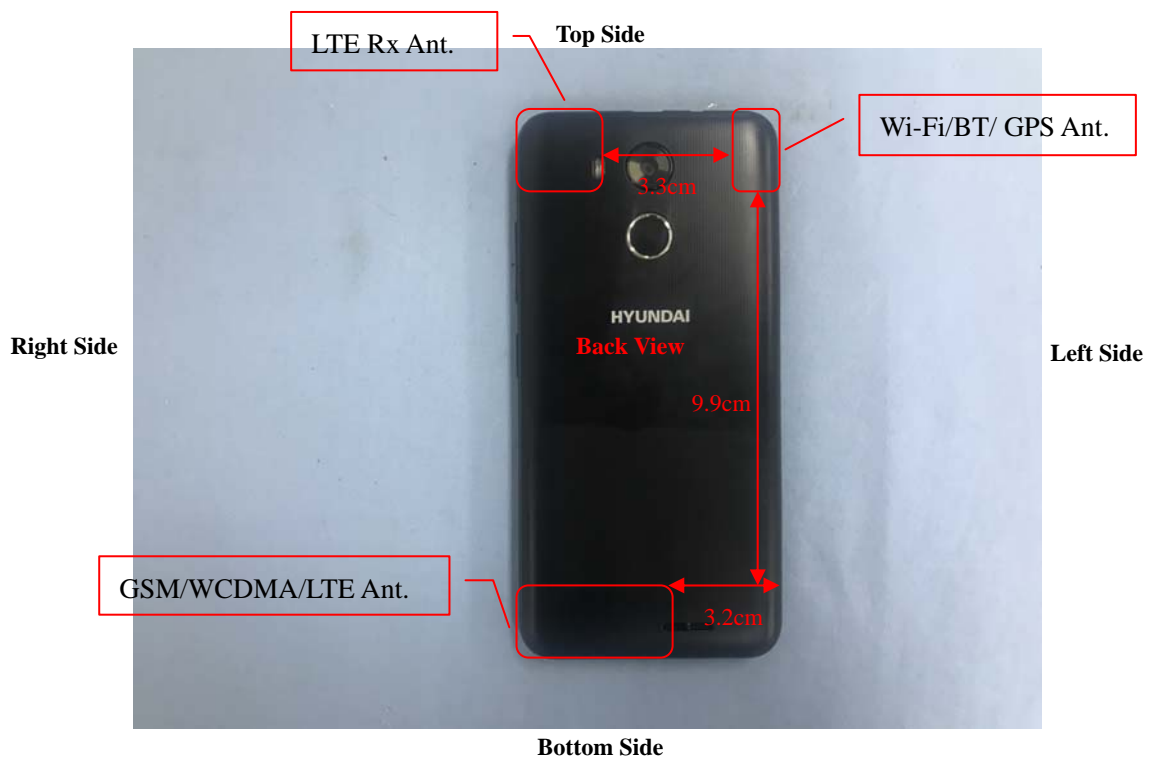

Illustration for Body Worn Position

## 7.5 EUT Antenna Position





**Block Diagram for EUT Antenna Position**

## 7.6 EUT Testing Position

Head/Body-worn/Hotspot mode SAR assessments are required for this device. This EUT was tested in different positions for different SAR test modes, more information as below:

Head SAR tests				
Antennas	Right Cheek	Left Cheek	Right Tilted	Left Tilted
WWAN	Yes	Yes	Yes	Yes
WLAN	Yes	Yes	Yes	Yes

Hotspot SAR tests, Test distance: 10mm						
Antennas	Front	Back	Right Side	Left Side	Top Side	Bottom Side
WWAN	Yes	Yes	Yes	Yes	No	Yes
WLAN	Yes	Yes	No	Yes	Yes	No

Body-worn SAR tests, Test distance: 10mm		
Antennas	Front	Back
WWAN	Yes	Yes
WLAN	Yes	Yes

### Remark:

- Referring to KDB 941225 D06, when the overall device length and width are  $\geq 9\text{cm} \times 5\text{cm}$ , the test separation distances is 10 mm. SAR must be measured for all sides and surfaces with a transmitting antenna located within 25mm from that surface or edge.
- Referring to KDB 648474 D04 Handset SAR v01r03, 10-g extremity SAR is required only for the surfaces and edges with hotspot mode 1-g reported SAR  $> 1.2 \text{ W/kg}$

**Please refer to Annex D for the EUT test setup photos.**



---

## 8. SAR Measurement Procedures

---

### 8.1 Measurement Procedures

The measurement procedures are as follows:

- (a) Use base station simulator (if applicable) or engineering software to transmit RF power continuously (continuous Tx) in the highest power channel.
- (b) Keep EUT to radiate maximum output power or 100% factor (if applicable)
- (c) Measure output power through RF cable and power meter.
- (d) Place the EUT in the positions as Annex D demonstrates.
- (e) Set scan area, grid size and other setting on the SATIMO software.
- (f) Measure SAR results for the highest power channel on each testing position.
- (g) Find out the largest SAR result on these testing positions of each band
- (h) Measure SAR results for other channels in worst SAR testing position if the SAR of highest power channel is larger than 0.8 W/kg

According to the test standard, the recommended procedure for assessing the peak spatial-average SAR value consists of the following steps:

- (a) Power reference measurement
- (b) Area scan
- (c) Zoom scan
- (d) Power drift measurement

### 8.2 Spatial Peak SAR Evaluation

The procedure for spatial peak SAR evaluation has been implemented according to the test standard. It can be conducted for 1g and 10g, as well as for user-specific masses. The SATIMO software includes all numerical procedures necessary to evaluate the spatial peak SAR value.

The base for the evaluation is a "cube" measurement. The measured volume must include the 1g and 10g cubes with the highest averaged SAR values. For that purpose, the center of the measured volume is aligned to the interpolated peak SAR value of a previously performed area scan.

The entire evaluation of the spatial peak values is performed within the post-processing engine. The system always gives the maximum values for the 1g and 10g cubes. The algorithm to find the cube with highest averaged SAR is divided into the following stages:

- (a) Extraction of the measured data (grid and values) from the Zoom Scan
- (b) Calculation of the SAR value at every measurement point based on all stored data
- (c) Generation of a high-resolution mesh within the measured volume
- (d) Interpolation of all measured values from the measurement grid to the high-resolution grid
- (e) Extrapolation of the entire 3D field distribution to the phantom surface over the distance from sensor to surface
- (f) Calculation of the averaged SAR within masses of 1g and 10g

### 8.3 Area & Zoom Scan Procedures

First Area Scan is used to locate the approximate location(s) of the local peak SAR value(s). The measurement grid within an Area Scan is defined by the grid extent, grid step size and grid offset. Next, in order to determine the EM field distribution in a three-dimensional spatial extension, Zoom Scan is required. The Zoom Scan measures 5x5x7 points with step size 8, 8 and 5 mm for 300 MHz to 3 GHz, and 8x8x8 points with step size 4, 4 and 2.5 mm for 3 GHz to 6 GHz. The Zoom Scan is performed around the highest E-field value to determine the averaged SAR-distribution over 10 g.

### 8.4 Volume Scan Procedures

The volume scan is used for assess overlapping SAR distributions for antennas transmitting in different frequency bands. It is equivalent to an oversized zoom scan used in standalone measurements. The measurement volume will be used to enclose all the simultaneous transmitting antennas. For antennas transmitting simultaneously in different frequency bands, the volume scan is measured separately in each frequency band. In order to sum correctly to compute the 1g aggregate SAR, the EUT remain in the same test position for all measurements and all volume scan use the same spatial resolution and grid spacing (step-size is 4, 4 and 2.5 mm). When all volume scan were completed, the software can combine and subsequently superpose these measurement data to calculating the multiband SAR.

### 8.5 SAR Averaged Methods

The local SAR inside the phantom is measured using small dipole sensing elements inside a probe body. The probe tip must not be in contact with the phantom surface in order to minimize measurements errors, but the highest local SAR will occur at the surface of the phantom.

An extrapolation is using to determinate this highest local SAR values. The extrapolation is based on a fourth-order least-square polynomial fit of measured data. The local SAR value is then extrapolated from the liquid surface with a 1mm step.

The measurements have to be performed over a limited time (due to the duration of the battery) so the step of measurement is high. It could vary between 5 and 8 mm. To obtain an accurate assessment of the maximum SAR averaged over 10g and 1 g requires a very fine resolution in the three dimensional scanned data array.

### 8.6 Power Drift Monitoring

All SAR testing is under the EUT install full charged battery and transmit maximum output power. In SATIMO measurement software, the power reference measurement and power drift measurement procedures are used for monitoring the power drift of EUT during SAR test. Both these procedures measure the field at a specified reference position before and after the SAR testing. The software will calculate the field difference in dB. If the power drift more than 5%, the SAR will be retested.

## 9. SAR Test Result

### 9.1 Conducted RF Output Power

GSM - Burst Average Power (dBm)								
Band	GSM850			Tune-up power (dBm)	PCS1900			Tune-up power (dBm)
Channel	128	190	251		512	661	810	
Frequency (MHz)	824.2	836.6	848.8		1850.2	1880	1909.8	
GSM	33.34	33.43	33.41	34.0	30.42	30.51	30.20	31.0
GPRS (1 slot)	33.29	33.38	33.36	33.5	30.52	30.60	30.23	31.0
GPRS (2 slots)	31.23	31.33	31.42	32.0	28.18	28.31	28.01	28.5
GPRS (3 slots)	29.36	29.47	29.59	30.0	26.64	26.74	26.50	27.0
GPRS (4 slots)	27.33	27.47	27.58	28.0	24.68	24.77	24.49	25.0
EDGE (1 slot)	25.84	26.13	25.80	26.5	25.38	25.51	25.65	26.0
EDGE (2 slots)	25.77	26.03	25.71	26.5	24.94	25.19	25.26	25.5
EDGE (3 slots)	24.56	24.81	24.45	25.0	24.91	25.11	25.16	25.5
EDGE (4 slots)	22.41	22.62	22.23	23.0	24.16	24.26	24.39	24.5

GSM - Source-Based Time-Average Power (dBm)								
Band	GSM850			Tune-up power (dBm)	PCS1900			Tune-up power (dBm)
Channel	128	190	251		512	661	810	
Frequency (MHz)	824.2	836.6	848.8		1850.2	1880	1909.8	
GSM	24.34	24.43	24.41	25.0	21.42	21.51	21.20	22.0
GPRS (1 slot)	24.29	24.38	24.36	24.5	21.52	21.60	21.23	22.0
GPRS (2 slots)	25.23	25.33	25.42	26.0	22.18	22.31	22.01	22.5
GPRS (3 slots)	25.11	25.22	25.34	25.5	22.39	22.49	22.25	23.0
GPRS (4 slots)	24.33	24.47	24.58	25.0	21.68	21.77	21.49	22.0
EDGE (1 slot)	16.84	17.13	16.80	17.5	16.38	16.51	16.65	17.0
EDGE (2 slots)	19.77	20.03	19.71	20.5	18.94	19.19	19.26	19.5
EDGE (3 slots)	20.31	20.56	20.20	21.0	20.66	20.86	20.91	21.0
EDGE (4 slots)	19.41	19.62	19.23	20.0	21.16	21.26	21.39	21.5

Note: The source-based time-averaged power is linearly scaled the maximum burst averaged power based on time slots. The calculated method are shown as below:

Source based time-average power = Burst averaged power - Duty cycle factor in dB

Duty cycle factor = 9 dB for 1 Tx slot, 6 dB for 2 Tx slots, 4.25 dB for 3 Tx slots, 3 dB for 4 Tx slots

#### Remark:

- For Head/Body-worn SAR testing, GSM and GPRS (2TX slots), GPRS (3TX slots) should be evaluated, therefore the EUT was set in GSM and GPRS (2TX slots) for GSM850 and GPRS (3TX slots) for GSM1900 due to its highest source-based time-average power.
- For Hotspot SAR testing, GPRS should be evaluated, therefore the EUT was set in GPRS (2TX slots) for GSM850

and GPRS (3TX slots) for GSM1900 due to its highest source-based time-average power.

3. Per KDB 447498 D01 v06, the maximum output power channel is used for SAR testing and for further SAR test reduction.
4. The DUT do not support DTM function.
5. This device supports VOIP capability through 3rd party apps software.
6. The DUT do not support power reduction function.

WCDMA - Average Power (dBm)								
Band	WCDMA Band II				WCDMA Band V			
Channel	9262	9400	9538	Tune-up power (dBm)	4132	4182	4233	Tune-up power (dBm)
Frequency (MHz)	1852.4	1880.0	1907.6		826.4	836.6	846.6	
RMC 12.2k	21.62	21.59	21.57	22.0	21.66	21.67	21.63	22.0
HSDPA Subtest-1	21.54	21.17	21.17	22.0	21.55	21.29	21.18	22.0
HSDPA Subtest-2	21.51	21.15	21.15	22.0	21.52	21.25	21.16	22.0
HSDPA Subtest-3	21.53	21.15	21.14	22.0	21.52	21.27	21.17	22.0
HSDPA Subtest-4	21.51	21.14	21.15	22.0	21.53	21.26	21.15	22.0
HSUPA Subtest-1	21.55	21.24	21.20	22.0	21.60	21.36	21.21	22.0
HSUPA Subtest-2	21.52	21.22	21.18	22.0	21.58	21.32	21.19	22.0
HSUPA Subtest-3	21.53	21.22	21.18	22.0	21.56	21.34	21.18	22.0
HSUPA Subtest-4	21.54	21.23	21.17	22.0	21.57	21.35	21.18	22.0
HSUPA Subtest-5	21.51	21.22	21.16	22.0	21.56	21.34	21.2	22.0

**Remark:**

1. per KDB 941225 D01 v03, The 12.2kbps RMC mode was selected for SAR testing(the primary mode).
2. When the maximum output power and tune-up tolerance specified for production units in a secondary mode is  $\leq 1/4$  dB higher than the primary mode or when the highest reported SAR of the primary mode is scaled by the ratio of specified maximum output power and tune-up tolerance of secondary to primary mode and the adjusted SAR is  $\leq 1.2$  W/kg, SAR measurement is not required for the secondary mode

**FDD-LTE Band 2:**

Channel Bandwidth: 1.4 MHz					
Modulation	Channel	RB Configuration		Average Power [dBm]	MPR (dB)
		Size	Offset		
QPSK	LCH	1	0	22.78	0
		1	3	22.87	0
		1	5	22.79	0
		3	0	22.38	0
		3	2	22.51	0
		3	3	22.67	0
		6	0	22.31	1
	MCH	1	0	22.77	0
		1	3	22.77	0
		1	5	22.79	0
		3	0	22.27	0
		3	2	22.31	0
		3	3	22.38	0
		6	0	22.32	1
	HCH	1	0	23.12	0
		1	3	23.18	0
		1	5	23.13	0
		3	0	22.28	0
		3	2	22.28	0
		3	3	22.2	0
		6	0	22.15	1
16QAM	LCH	1	0	22.01	1
		1	3	22.08	1
		1	5	22.03	1
		3	0	22.58	1
		3	2	22.62	1
		3	3	22.59	1
		6	0	21.2	2
	MCH	1	0	22.4	1
		1	3	22.53	1
		1	5	22.51	1
		3	0	22.34	1
		3	2	22.29	1
		3	3	22.33	1
		6	0	21.21	2
HCH	1	0	22.94	1	

		1	3	22.95	1
		1	5	22.94	1
		3	0	22.72	1
		3	2	22.72	1
		3	3	22.76	1
		6	0	21.96	2

Channel Bandwidth: 3 MHz					
Modulation	Channel	RB Configuration		Average Power [dBm]	MPR (dB)
		Size	Offset		
QPSK	LCH	1	0	22.62	0
		1	7	22.66	0
		1	14	22.72	0
		8	0	22.32	1
		8	4	22.35	1
		8	7	22.31	1
		15	0	22.45	1
	MCH	1	0	22.76	0
		1	7	22.8	0
		1	14	22.81	0
		8	0	22.28	1
		8	4	22.32	1
		8	7	22.28	1
		15	0	22.28	1
	HCH	1	0	23.14	0
		1	7	23.15	0
		1	14	23.19	0
		8	0	22.68	1
		8	4	22.66	1
		8	7	22.77	1
		15	0	22.81	1
16QAM	LCH	1	0	22.08	1
		1	7	22.21	1
		1	14	22.19	1
		8	0	21.47	2
		8	4	21.5	2
		8	7	21.48	2
		15	0	21.42	2
	MCH	1	0	22.67	1
		1	7	22.75	1
		1	14	22.72	1
		8	0	21.37	2
		8	4	21.42	2

		8	7	21.46	2
		15	0	21.39	2
	HCH	1	0	22.28	1
		1	7	22.25	1
		1	14	22.26	1
		8	0	21.06	2
		8	4	21.05	2
		8	7	21.04	2
		15	0	21.88	2

Channel Bandwidth: 5 MHz					
Modulation	Channel	RB Configuration		Average Power [dBm]	MPR (dB)
		Size	Offset		
QPSK	LCH	1	0	22.77	0
		1	12	22.87	0
		1	24	22.93	0
		12	0	22.53	1
		12	6	22.48	1
		12	13	22.5	1
		25	0	22.44	1
	MCH	1	0	22.77	0
		1	12	22.67	0
		1	24	22.74	0
		12	0	22.32	1
		12	6	22.27	1
		12	13	22.4	1
		25	0	22.34	1
	HCH	1	0	23.34	0
		1	12	23.33	0
		1	24	23.37	0
		12	0	22.31	1
		12	6	22.41	1
		12	13	22.43	1
		25	0	22.39	1
16QAM	LCH	1	0	22.07	1
		1	12	22.21	1
		1	24	22.24	1
		12	0	21.48	2
		12	6	21.57	2
		12	13	21.58	2
		25	0	21.68	2
	MCH	1	0	22.86	1
		1	12	22.79	1

		1	24	22.83	1
		12	0	21.5	2
		12	6	21.49	2
		12	13	21.55	2
		25	0	21.58	2
	HCH	1	0	22.47	1
		1	12	22.45	1
		1	24	22.55	1
		12	0	21.72	2
		12	6	21.72	2
		12	13	21.81	2
		25	0	21.96	2

Channel Bandwidth: 10 MHz					
Modulation	Channel	RB Configuration		Average Power [dBm]	MPR (dB)
		Size	Offset		
QPSK	LCH	1	0	22.7	0
		1	24	22.88	0
		1	49	22.96	0
		25	0	22.59	1
		25	12	22.47	1
		25	25	22.64	1
		50	0	22.63	1
	MCH	1	0	23.01	0
		1	24	22.89	0
		1	49	22.91	0
		25	0	22.46	1
		25	12	22.34	1
		25	25	22.42	1
		50	0	22.32	1
	HCH	1	0	23.26	0
		1	24	23.21	0
		1	49	23.22	0
		25	0	22.37	1
		25	12	22.37	1
		25	25	22.39	1
		50	0	22.43	1
16QAM	LCH	1	0	22.01	1
		1	24	22.35	1
		1	49	22.54	1
		25	0	21.59	2
		25	12	21.66	2
		25	25	21.66	2



	MCH	50	0	21.6	2
		1	0	23	1
		1	24	22.88	1
		1	49	22.89	1
		25	0	21.5	2
		25	12	21.48	2
		25	25	21.51	2
		50	0	21.56	2
	HCH	1	0	22.94	1
		1	24	22.93	1
		1	49	22.91	1
		25	0	21.86	2
		25	12	21.87	2
		25	25	21.9	2
		50	0	21.92	2

Channel Bandwidth: 15 MHz					
Modulation	Channel	RB Configuration		Average Power [dBm]	MPR (dB)
		Size	Offset		
QPSK	LCH	1	0	22.76	0
		1	37	22.92	0
		1	74	23.01	0
		37	0	22.54	1
		37	18	22.51	1
		37	38	22.67	1
		75	0	22.65	1
	MCH	1	0	23.01	0
		1	37	22.91	0
		1	74	22.93	0
		37	0	22.27	1
		37	18	22.29	1
		37	38	22.42	1
		75	0	22.32	1
	HCH	1	0	23.07	0
		1	37	23.28	0
		1	74	23.24	0
		37	0	22.33	1
		37	18	22.45	1
		37	38	22.26	1
		75	0	22.31	1
16QAM	LCH	1	0	22.1	1
		1	37	22.44	1
		1	74	22.54	1

		37	0	21.69	2
		37	18	21.67	2
		37	38	21.72	2
		75	0	21.58	2
	MCH	1	0	22.44	1
		1	37	22.31	1
		1	74	22.2	1
		37	0	21.45	2
		37	18	21.45	2
		37	38	21.51	2
		75	0	21.56	2
	HCH	1	0	22.74	1
		1	37	22.91	1
		1	74	22.94	1
		37	0	21.79	2
		37	18	21.88	2
		37	38	21.93	2
		75	0	21.88	2

Channel Bandwidth: 20 MHz					
Modulation	Channel	RB Configuration		Average Power [dBm]	MPR (dB)
		Size	Offset		
QPSK	LCH	1	0	23.03	0
		1	49	23.21	0
		1	99	23.37	0
		50	0	22.65	1
		50	25	22.78	1
		50	50	22.58	1
		100	0	22.64	1
	MCH	1	0	23.2	0
		1	49	23.06	0
		1	99	23.28	0
		50	0	22.33	1
		50	25	22.39	1
		50	50	22.36	1
		100	0	22.45	1
	HCH	1	0	22.79	0
		1	49	23.08	0
		1	99	23.12	0
		50	0	22.5	1
		50	25	22.76	1
		50	50	22.72	1
		100	0	22.61	1

16QAM	LCH	1	0	22.39	1
		1	49	22.43	1
		1	99	22.26	1
		50	0	21.64	2
		50	25	21.75	2
		50	50	21.72	2
		100	0	21.71	2
	MCH	1	0	22.24	1
		1	49	22.17	1
		1	99	22.38	1
		50	0	21.59	2
		50	25	21.45	2
		50	50	21.5	2
		100	0	21.43	2
	HCH	1	0	22.53	1
		1	49	22.56	1
		1	99	22.79	1
		50	0	21.6	2
		50	25	21.83	2
		50	50	21.82	2
		100	0	21.81	2

**FDD-LTE Band 4:**

Channel Bandwidth: 1.4 MHz					
Modulation	Channel	RB Configuration		Average Power [dBm]	MPR (dB)
		Size	Offset		
QPSK	LCH	1	0	22.75	0
		1	3	22.76	0
		1	5	22.76	0
		3	0	22.74	0
		3	2	22.7	0
		3	3	22.61	0
		6	0	22.08	1
	MCH	1	0	23.03	0
		1	3	22.93	0
		1	5	22.99	0
		3	0	23.02	0
		3	2	23.06	0
		3	3	22.99	0
		6	0	22.51	1
	HCH	1	0	23.04	0

		1	3	23.98	0
		1	5	23.95	0
		3	0	23.25	0
		3	2	23.23	0
		3	3	23.14	0
		6	0	21.77	1
16QAM	LCH	1	0	22.19	1
		1	3	22.21	1
		1	5	22.16	1
		3	0	22.3	1
		3	2	22.27	1
		3	3	22.27	1
	6	0	21.02	2	
	MCH	1	0	22.96	1
		1	3	22.02	1
		1	5	22.95	1
		3	0	22.29	1
		3	2	22.33	1
		3	3	22.28	1
	6	0	21.1	2	
	HCH	1	0	21.81	1
		1	3	21.8	1
		1	5	21.79	1
		3	0	22.18	1
		3	2	22.25	1
		3	3	22.21	1
	6	0	21.98	2	

Channel Bandwidth: 3 MHz					
Modulation	Channel	RB Configuration		Average Power [dBm]	MPR (dB)
		Size	Offset		
QPSK	LCH	1	0	22.53	0
		1	7	22.55	0
		1	14	22.5	0
		8	0	21.96	1
		8	4	21.96	1
		8	7	22.12	1
		15	0	22.12	1
	MCH	1	0	22.94	0
		1	7	22.95	0
		1	14	22.97	0
		8	0	22.35	1
		8	4	22.38	1

		8	7	22.41	1
		15	0	22.36	1
	HCH	1	0	23.11	0
		1	7	23	0
		1	14	22.97	0
		8	0	21.78	1
		8	4	21.66	1
		8	7	21.67	1
		15	0	21.59	1
16QAM	LCH	1	0	22.99	1
		1	7	22.99	1
		1	14	22.05	1
		8	0	21.18	2
		8	4	21.18	2
		8	7	21.13	2
		15	0	21.22	2
	MCH	1	0	22.05	1
		1	7	22.04	1
		1	14	22.97	1
		8	0	21.31	2
		8	4	21.34	2
		8	7	21.29	2
		15	0	21.28	2
	HCH	1	0	22.45	1
		1	7	22.42	1
		1	14	22.33	1
		8	0	20.9	2
		8	4	20.78	2
		8	7	20.86	2
		15	0	20.86	2

Channel Bandwidth: 5 MHz					
Modulation	Channel	RB Configuration		Average Power [dBm]	MPR (dB)
		Size	Offset		
QPSK	LCH	1	0	22.51	0
		1	12	22.55	0
		1	24	22.55	0
		12	0	21.55	1
		12	6	21.54	1
		12	13	21.55	1
		25	0	22.43	1
	MCH	1	0	23.21	0
		1	12	23.36	0

		1	24	23.32	0
		12	0	21.69	1
		12	6	21.73	1
		12	13	21.62	1
		25	0	21.64	1
	HCH	1	0	22.86	0
		1	12	22.83	0
		1	24	22.75	0
		12	0	22.34	1
		12	6	22.25	1
		12	13	22.18	1
		25	0	22.24	1
	16QAM	LCH	1	0	22.28
1			12	22.36	1
1			24	22.3	1
12			0	20.58	2
12			6	20.55	2
12			13	20.79	2
25			0	20.7	2
MCH		1	0	22.36	1
		1	12	22.43	1
		1	24	22.43	1
		12	0	20.64	2
		12	6	20.6	2
		12	13	20.57	2
		25	0	21.38	2
HCH		1	0	22	1
		1	12	21.95	1
		1	24	21.78	1
		12	0	21.12	2
		12	6	21	2
		12	13	20.99	2
		25	0	20.68	2

Channel Bandwidth: 10 MHz					
Modulation	Channel	RB Configuration		Average Power [dBm]	MPR (dB)
		Size	Offset		
QPSK	LCH	1	0	22.62	0
		1	24	22.62	0
		1	49	22.88	0
		25	0	22.2	1
		25	12	22.2	1
		25	25	22.32	1
		50	0	22.13	1
	MCH	1	0	23.13	0
		1	24	23.13	0
		1	49	23.02	0
		25	0	22.52	1
		25	12	22.58	1
		25	25	22.47	1
		50	0	22.51	1
	HCH	1	0	22.76	0
		1	24	22.53	0
		1	49	22.79	0
		25	0	22.13	1
		25	12	22.02	1
		25	25	22.02	1
		50	0	22.09	1
16QAM	LCH	1	0	22.14	1
		1	24	22.16	1
		1	49	22.3	1
		25	0	21.32	2
		25	12	21.24	2
		25	25	21.35	2
		50	0	21.26	2
	MCH	1	0	22.14	1
		1	24	22.2	1
		1	49	22.16	1
		25	0	21.5	2
		25	12	21.49	2
		25	25	21.67	2
		50	0	21.47	2
	HCH	1	0	22.24	1
		1	24	22	1
		1	49	21.88	1
		25	0	21.19	2

		25	12	21.08	2
		25	25	21.02	2
		50	0	21.18	2

Channel Bandwidth: 15 MHz					
Modulation	Channel	RB Configuration		Average Power [dBm]	MPR (dB)
		Size	Offset		
QPSK	LCH	1	0	22.64	0
		1	37	22.75	0
		1	74	22.98	0
		37	0	22.2	1
		37	18	22.42	1
		37	38	22.4	1
		75	0	22.29	1
	MCH	1	0	23.04	0
		1	37	23.08	0
		1	74	22.94	0
		37	0	22.53	1
		37	18	22.51	1
		37	38	22.56	1
		75	0	22.62	1
	HCH	1	0	22.96	0
		1	37	22.6	0
		1	74	22.97	0
		37	0	22.35	1
		37	18	22.05	1
		37	38	22.01	1
		75	0	22.19	1
16QAM	LCH	1	0	22.15	1
		1	37	22.24	1
		1	74	22.42	1
		37	0	21.29	2
		37	18	21.25	2
		37	38	21.34	2
		75	0	21.37	2
	MCH	1	0	22.41	1
		1	37	22.32	1
		1	74	22.41	1
		37	0	21.54	2
		37	18	21.53	2
		37	38	21.68	2
		75	0	21.53	2
HCH	1	0	22.52	1	



		1	37	22.2	1
		1	74	21.89	1
		37	0	21.38	2
		37	18	21.3	2
		37	38	21.15	2
		75	0	21.31	2

Channel Bandwidth: 20 MHz					
Modulation	Channel	RB Configuration		Average Power [dBm]	MPR (dB)
		Size	Offset		
QPSK	LCH	1	0	22.85	0
		1	49	23.05	0
		1	99	23.25	0
		50	0	22.61	1
		50	25	23.18	1
		50	50	22.96	1
		100	0	23.06	1
	MCH	1	0	23.27	0
		1	49	23.99	0
		1	99	23.22	0
		50	0	23.03	1
		50	25	23.26	1
		50	50	23.08	1
		100	0	23.12	1
	HCH	1	0	23.49	0
		1	49	22.76	0
		1	99	22.98	0
		50	0	22.99	1
		50	25	22.83	1
		50	50	22.55	1
		100	0	22.69	1
16QAM	LCH	1	0	22.01	1
		1	49	22.07	1
		1	99	22.35	1
		50	0	21.35	2
		50	25	21.36	2
		50	50	21.56	2
		100	0	21.38	2
	MCH	1	0	22.56	1
		1	49	22.67	1
		1	99	22.59	1
		50	0	21.46	2
		50	25	21.47	2

		50	50	21.46	2
		100	0	21.44	2
	HCH	1	0	22.02	1
		1	49	22.72	1
		1	99	22.35	1
		50	0	21.39	2
		50	25	21.22	2
		50	50	21.19	2
		100	0	21.29	2

**FDD-LTE Band 7:**

Channel Bandwidth: 5 MHz					
Modulation	Channel	RB Configuration		Average Power [dBm]	MPR (dB)
		Size	Offset		
QPSK	LCH	1	0	22.72	0
		1	12	22.7	0
		1	24	22.79	0
		12	0	22.5	0
		12	6	22.61	0
		12	13	22.52	0
		25	0	22.51	0
	MCH	1	0	23.08	0
		1	12	22.95	0
		1	24	22.9	0
		12	0	22.33	0
		12	6	22.33	0
		12	13	22.21	0
		25	0	22.22	0
	HCH	1	0	22.48	0
		1	12	22.55	0
		1	24	22.62	0
		12	0	21.95	0
		12	6	21.95	0
		12	13	22.12	0
		25	0	22.01	0
16QAM	LCH	1	0	22.05	0
		1	12	22.13	0
		1	24	22.15	0
		12	0	21.13	0
		12	6	21.25	0
		12	13	21.1	0
		25	0	21.42	0
	MCH	1	0	22.68	0
		1	12	22.58	0
		1	24	22.39	0
		12	0	20.84	0
		12	6	20.67	0
		12	13	20.76	0
		25	0	21.09	0
HCH	1	0	22.16	0	
	1	12	22.22	0	

		1	24	22.05	0
		12	0	20.53	0
		12	6	20.57	0
		12	13	20.56	0
		25	0	20.81	0

Channel Bandwidth: 10 MHz					
Modulation	Channel	RB Configuration		Average Power [dBm]	MPR (dB)
		Size	Offset		
QPSK	LCH	1	0	22.68	0
		1	24	23.26	0
		1	49	23.41	0
		25	0	22.61	1
		25	12	22.81	1
		25	25	22.74	1
		50	0	22.7	1
	MCH	1	0	22.98	0
		1	24	22.7	0
		1	49	22.51	0
		25	0	22.45	1
		25	12	22.24	1
		25	25	22.22	1
		50	0	22.3	1
	HCH	1	0	22.39	0
		1	24	22.35	0
		1	49	22.47	0
		25	0	22.01	1
		25	12	21.89	1
		25	25	22.12	1
		50	0	22	1
16QAM	LCH	1	0	22.38	1
		1	24	22.52	1
		1	49	22.55	1
		25	0	21.33	1
		25	12	21.45	1
		25	25	21.47	1
		50	0	21.51	1
	MCH	1	0	22.4	1
		1	24	22.07	1
		1	49	22.8	1
		25	0	21.12	1
		25	12	21.09	1
		25	25	20.86	1

		50	0	21.06	1
	HCH	1	0	22.07	1
		1	24	22.06	1
		1	49	22.13	1
		25	0	20.54	1
		25	12	20.49	1
		25	25	20.46	1
		50	0	20.68	1

Channel Bandwidth: 15 MHz					
Modulation	Channel	RB Configuration		Average Power [dBm]	MPR (dB)
		Size	Offset		
QPSK	LCH	1	0	23	0
		1	37	23.16	0
		1	74	23.25	0
		37	0	22.57	1
		37	18	22.71	1
		37	38	22.7	1
		75	0	22.8	1
	MCH	1	0	23.2	0
		1	37	22.77	0
		1	74	22.43	0
		37	0	22.56	1
		37	18	22.46	1
		37	38	22.22	1
		75	0	22.34	1
	HCH	1	0	22.37	0
		1	37	22.5	0
		1	74	22.52	0
		37	0	21.92	1
		37	18	22.04	1
		37	38	22.12	1
		75	0	22.04	1
16QAM	LCH	1	0	22.65	1
		1	37	22.74	1
		1	74	22.85	1
		37	0	21.35	1
		37	18	21.52	1
		37	38	21.66	1
		75	0	21.47	1
	MCH	1	0	22.03	1
		1	37	22.62	1
		1	74	22.2	1

		37	0	21.14	1
		37	18	21.09	1
		37	38	21.01	1
		75	0	21.16	1
	HCH	1	0	22.67	1
		1	37	22.71	1
		1	74	22.71	1
		37	0	20.58	1
		37	18	20.61	1
		37	38	20.59	1
		75	0	20.62	1

Channel Bandwidth: 20 MHz					
Modulation	Channel	RB Configuration		Average Power [dBm]	MPR (dB)
		Size	Offset		
QPSK	LCH	1	0	23.28	0
		1	49	23.42	0
		1	99	23.61	0
		50	0	22.66	0
		50	25	22.74	0
		50	50	22.82	0
		100	0	22.76	0
	MCH	1	0	23.49	0
		1	49	23	0
		1	99	22.82	0
		50	0	22.49	0
		50	25	22.46	0
		50	50	22.11	0
		100	0	22.41	0
	HCH	1	0	22.86	0
		1	49	22.92	0
		1	99	23.38	0
		50	0	22.39	0
		50	25	22.55	0
		50	50	22.49	0
		100	0	22.41	0
16QAM	LCH	1	0	22.86	0
		1	49	22.01	0
		1	99	22.13	0
		50	0	21.19	1
		50	25	21.54	1
		50	50	21.48	1
		100	0	21.5	1

	MCH	1	0	22.92	0
		1	49	22.51	0
		1	99	22.13	0
		50	0	21.35	1
		50	25	20.99	1
		50	50	20.81	1
		100	0	21.11	1
	HCH	1	0	22.51	0
		1	49	22.52	0
		1	99	22.69	0
		50	0	20.42	1
		50	25	20.53	1
		50	50	20.61	1
		100	0	20.59	1

**Remark:**

- Per KDB941225 D05 v02r05, Start with the largest channel bandwidth then measure SAR for QPSK with 1 RB allocation, using the RB offset and required test channel combination with the highest maximum output power among RB offsets at the upper edge, middle, and lower edge of each required test channel. When the reported SAR is  $\leq 0.8$  W/kg, testing of the remaining RB offset configurations and required test channels is not required for 1 RB allocation; otherwise, SAR is required for the remaining required test channels and only for the RB offset configuration with the highest output power for that channel. 6 When the reported SAR of a required test channel is  $> 1.45$  W/kg, SAR is required for all three RB offset configurations for that required test channel.
- Per KDB941225 D05 v02r05, The procedures required for 1 RB allocation in 5.2.1 are applied to measure the SAR for QPSK with 50% RB allocation.
- Per KDB941225 D05 v02r05, For QPSK with 100% RB allocation, SAR is not required when the highest maximum output power for 100 % RB allocation is less than the highest maximum output power in 50% and 1 RB allocations, and the highest reported SAR for 1 RB and 50% RB allocation in 5.2.1 and 5.2.2 are  $\leq 0.8$  W/kg. Otherwise, SAR is measured for the highest output power channel; and if the reported SAR is  $> 1.45$  W/kg, the remaining required test channels must also be tested.
- Per KDB941225 D05 v02r05, For each modulation besides QPSK; e.g., 16-QAM, 64-QAM, apply the QPSK procedures in 5.2.1, 5.2.2, and 5.2.3 to determine the QAM configurations that may need SAR measurement. For each configuration identified as required for testing, SAR is required only when the highest maximum output power for the configuration in the higher order modulation is  $> \frac{1}{2}$  dB higher than the same configuration in QPSK or when the reported SAR for the QPSK configuration is  $> 1.45$  W/kg.

WLAN - Maximum Average Power					
Test Mode	Data Rate	Channel	Frequency (MHz)	Average Power (dBm)	Tune-up power (dBm)
802.11b	1Mbps	CH 01	2412	11.11	13.0
		CH 06	2437	11.76	13.0
		CH 11	2462	12.87	13.0
802.11g	6Mbps	CH 01	2412	8.62	10.5
		CH 06	2437	10.11	10.5
		CH 11	2462	9.94	10.5
802.11n (20MHz)	MCS0	CH 01	2412	8.07	10.0
		CH 06	2437	8.52	10.0
		CH 11	2462	9.4	10.0

**Remark:**

1. Per KDB 248227 D01 v02r02, For 802.11b DSSS SAR measurements, DSSS SAR procedure applies to fixed exposure test position and initial test position procedure applies to multiple exposure test positions.
2. Per KDB 248227 D01 v02r02, For 802.11b DSSS SAR measurements, when the reported SAR of the highest measured maximum output power channel (see 3.1) for the exposure configuration is  $\leq 0.8$  W/kg, no further SAR testing is required for 802.11b DSSS in that exposure configuration. When the reported SAR is  $> 0.8$  W/kg, SAR is required for that exposure configuration using the next highest measured output power channel. When any reported SAR is  $> 1.2$  W/kg, SAR is required for the third channel; i.e., all channels require testing.
3. For OFDM modes (802.11g/n), SAR is not required when the highest reported SAR for DSSS is adjusted by the ratio of OFDM to DSSS specified maximum output power and it is  $\leq 1.2$  W/kg.



Bluetooth - Maximum Average Power			
Test Mode	Data Rate	Average Power(dBm)	Tune-up power (dBm)
GFSK	1Mbps	5.532	6.5
Pi/4 QDPSK	2Mbps	5.797	6.5
8DPSK	3Mbps	6.061	6.5

Bluetooth - Maximum Average Power					
Test Mode	Data Rate	Channel	Frequency (MHz)	Average Power (dBm)	Tune-up power (dBm)
BLE	1Mbps	CH 00	2402	-1.593	0
		CH 19	2440	-0.735	0
		CH 39	2480	-1.42	0

**Remark:**

Bluetooth maximum output power is 6.061dBm ,and Maximum Tune-Up output power is 6.5dBm. Per KDB 447498 D01 V06, the 1-g and 10-g SAR test exclusion thresholds for 100 MHz to 6 GHz at test separation distances  $\leq 50$  mm are determined by:

$[(\text{max. power of channel, including tune-up tolerance, } 4.87\text{mW})/(\text{min. test separation distance, mm})] \cdot [\sqrt{f(\text{GHz})}] \leq 3.0$  for 1-g SAR and  $\leq 7.5$  for 10-g extremity SAR,16 where

- f(GHz) is the RF channel transmit frequency in GHz
- Power and distance are rounded to the nearest mW and mm before calculation<sup>17</sup>
- The result is rounded to one decimal place for comparison

Tune-Up Power (dBm)	Max. Power (mW)	Distance (mm)	Frequency (GHz)	Result	Limit
6.5	4.47	5	2.402	1.39	3

The exclusion thresholds is  $1.39 < 3$ , therefore, the RF exposure evaluation is not required.

## 9.2 Test Results for Standalone SAR Test

### Head SAR

GSM850 – Head SAR Test									
Plot No.	Mode	Test Position Head	Frequency		Output Power (dBm)	Rated Limit (dBm)	Scaling Factor	SAR1g (W/kg)	Scaled SAR1g (W/kg)
			CH.	MHz					
1.	GSM	Right Cheek	190	836.6	33.43	34.0	1.140	0.747	0.852
2.	GSM	Right Cheek	128	824.2	33.34	34.0	1.164	0.637	0.742
3.	GSM	Right Cheek	251	848.8	33.41	34.0	1.146	0.712	0.816
4.	GSM	Right Tilted	190	836.6	33.43	34.0	1.140	0.363	0.414
5.	GSM	Left Cheek	190	836.6	33.43	34.0	1.140	0.685	0.781
6.	GSM	Left Tilted	190	836.6	33.43	34.0	1.140	0.271	0.309

GSM1900 – Head SAR Test									
Plot No.	Mode	Test Position Head	Frequency		Output Power (dBm)	Rated Limit (dBm)	Scaling Factor	SAR1g (W/kg)	Scaled SAR1g (W/kg)
			CH.	M Hz					
7.	GSM	Right Cheek	661	1880	30.51	31.0	1.119	0.030	0.034
8.	GSM	Right Tilted	661	1880	30.51	31.0	1.119	0.013	0.015
9.	GSM	Left Cheek	661	1880	30.51	31.0	1.119	0.028	0.031
10.	GSM	Left Tilted	661	1880	30.51	31.0	1.119	0.011	0.012

GPRS850 – Head SAR Test									
Plot No.	Mode	Test Position Head	Frequency		Output Power (dBm)	Rated Limit (dBm)	Scaling Factor	SAR1g (W/kg)	Scaled SAR1g (W/kg)
			CH.	MHz					
11.	GPRS_2TX	Right Cheek	251	848.8	31.42	32.0	1.143	0.628	0.718
12.	GPRS_2TX	Right Tilted	251	848.8	31.42	32.0	1.143	0.267	0.305
13.	GPRS_2TX	Left Cheek	251	848.8	31.42	32.0	1.143	0.613	0.701
14.	GPRS_2TX	Left Tilted	251	848.8	31.42	32.0	1.143	0.248	0.283

GPRS1900 – Head SAR Test									
Plot No.	Mode	Test Position Head	Frequency		Output Power (dBm)	Rated Limit (dBm)	Scaling Factor	SAR1g (W/kg)	Scaled SAR1g (W/kg)
			CH.	M Hz					
15.	GPRS_3TX	Right Cheek	661	1880	26.74	27.0	1.062	0.037	0.039
16.	GPRS_3TX	Right Tilted	661	1880	26.74	27.0	1.062	0.017	0.018
17.	GPRS_3TX	Left Cheek	661	1880	26.74	27.0	1.062	0.045	0.048
18.	GPRS_3TX	Left Tilted	661	1880	26.74	27.0	1.062	0.021	0.022

WCDMA Band 2 – Head SAR Test									
Plot No.	Mode	Test Position Head	Frequency		Output Power (dBm)	Rated Limit (dBm)	Scaling Factor	SAR1g (W/kg)	Scaled SAR1g (W/kg)
			CH.	MHz					
19.	RMC	Right Cheek	9262	1852.4	21.62	22.0	1.091	0.048	0.052
20.	RMC	Right Tilted	9262	1852.4	21.62	22.0	1.091	0.022	0.024
21.	RMC	Left Cheek	9262	1852.4	21.62	22.0	1.091	0.051	0.056
22.	RMC	Left Tilted	9262	1852.4	21.62	22.0	1.091	0.027	0.029

WCDMA Band 5 – Head SAR Test									
Plot No.	Mode	Test Position Head	Frequency		Output Power (dBm)	Rated Limit (dBm)	Scaling Factor	SAR1g (W/kg)	Scaled SAR1g (W/kg)
			CH.	MHz					
23.	RMC	Right Cheek	4182	836.6	21.67	22.0	1.079	0.302	0.326
24.	RMC	Right Tilted	4182	836.6	21.67	22.0	1.079	0.151	0.163
25.	RMC	Left Cheek	4182	836.6	21.67	22.0	1.079	0.282	0.304
26.	RMC	Left Tilted	4182	836.6	21.67	22.0	1.079	0.137	0.148

LTE Band 2– Head SAR Test									
Plot No.	Mode	Test Position Head	Freque ncy	Output Power (dBm)	Rated Limit (dBm)	Scaling Factor	SAR1g (W/kg)	Scaled SAR1g (W/kg)	
	Modulation, Bandwidth, RB		MHz						
27.	QPSK 20MHz 1RB	Right Cheek	1860.0	23.37	24.0	1.156	0.045	0.052	
28.	QPSK 20MHz 1RB	Right Tilted	1860.0	23.37	24.0	1.156	0.022	0.025	
29.	QPSK 20MHz 1RB	Left Cheek	1860.0	23.37	24.0	1.156	0.053	0.061	
30.	QPSK 20MHz 1RB	Left Tilted	1860.0	23.37	24.0	1.156	0.029	0.034	
31.	QPSK 20MHz 50%RB	Right Cheek	1860.0	22.78	23.0	1.052	0.02	0.021	
32.	QPSK 20MHz 50%RB	Right Tilted	1860.0	22.78	23.0	1.052	0.011	0.012	
33.	QPSK 20MHz 50%RB	Left Cheek	1860.0	22.78	23.0	1.052	0.026	0.027	
34.	QPSK 20MHz 50%RB	Left Tilted	1860.0	22.78	23.0	1.052	0.01	0.011	

LTE Band 4– Head SAR Test								
Plot No.	Mode	Test Position Head	Freque ncy	Output Power (dBm)	Rated Limit (dBm)	Scaling Factor	SAR1g (W/kg)	Scaled SAR1g (W/kg)
	Modulation, Bandwidth, RB		MHz					
35.	QPSK 20MHz 1RB	Right Cheek	1732.5	23.99	24.5	1.125	0.096	0.108
36.	QPSK 20MHz 1RB	Right Tilted	1732.5	23.99	24.5	1.125	0.047	0.053
37.	QPSK 20MHz 1RB	Left Cheek	1732.5	23.99	24.5	1.125	0.105	0.118
38.	QPSK 20MHz 1RB	Left Tilted	1732.5	23.99	24.5	1.125	0.05	0.056
39.	QPSK 20MHz 50%RB	Right Cheek	1732.5	23.26	23.5	1.057	0.041	0.043
40.	QPSK 20MHz 50%RB	Right Tilted	1732.5	23.26	23.5	1.057	0.023	0.024
41.	QPSK 20MHz 50%RB	Left Cheek	1732.5	23.26	23.5	1.057	0.048	0.051
42.	QPSK 20MHz 50%RB	Left Tilted	1732.5	23.26	23.5	1.057	0.026	0.027

LTE Band 7– Head SAR Test								
Plot No.	Mode	Test Position Head	Freque ncy	Output Power (dBm)	Rated Limit (dBm)	Scaling Factor	SAR1g (W/kg)	Scaled SAR1g (W/kg)
	Modulation, Bandwidth		MHz					
43.	QPSK 20MHz 1RB	Right Cheek	2510.0	23.61	24.0	1.094	0.513	0.561
44.	QPSK 20MHz 1RB	Right Tilted	2510.0	23.61	24.0	1.094	0.236	0.258
45.	QPSK 20MHz 1RB	Left Cheek	2510.0	23.61	24.0	1.094	0.226	0.247
46.	QPSK 20MHz 1RB	Left Tilted	2510.0	23.61	24.0	1.094	0.113	0.124
47.	QPSK 20MHz 50%RB	Right Cheek	2510.0	22.82	23.0	1.042	0.218	0.227
48.	QPSK 20MHz 50%RB	Right Tilted	2510.0	22.82	23.0	1.042	0.101	0.105
49.	QPSK 20MHz 50%RB	Left Cheek	2510.0	22.82	23.0	1.042	0.103	0.107
50.	QPSK 20MHz 50%RB	Left Tilted	2510.0	22.82	23.0	1.042	0.101	0.105

WLAN 2.4GHz – Head SAR Test									
Plot No.	Mode	Test Position Head	Frequency		Output Power (dBm)	Rated Limit (dBm)	Scaling Factor	SAR1g (W/kg)	Scaled SAR1g (W/kg)
			CH.	MHz					
51.	802.11b	Right Cheek	11	2462	12.87	13.0	1.030	0.541	0.557
52.	802.11b	Right Tilted	11	2462	12.87	13.0	1.030	0.307	0.316
53.	802.11b	Left Cheek	11	2462	12.87	13.0	1.030	0.337	0.347
54.	802.11b	Left Tilted	11	2462	12.87	13.0	1.030	0.153	0.158

**Remark:** Per KDB 447498 D01 v06, if the highest output channel SAR for each exposure position  $\leq 0.8$  W/kg other channels SAR tests are not necessary.

**Body-worn SAR**

GSM850 – Body SAR Test (Gap: 10mm)									
Plot No.	Mode	Test Position Body	Frequency		Output Power (dBm)	Rated Limit (dBm)	Scaling Factor	SAR1g (W/kg)	Scaled SAR1g (W/kg)
			CH.	MHz					
55.	GSM	Back	190	836.6	33.43	34.0	1.140	0.847	0.966
56.	GSM	Back	128	824.2	33.34	34.0	1.164	0.681	0.793
57.	GSM	Back	251	848.8	33.41	34.0	1.146	0.471	0.540
58.	GSM	Front	190	836.6	33.43	34.0	1.140	0.761	0.868
59.	GSM	Front	128	824.2	33.34	34.0	1.164	0.641	0.746
60.	GSM	Front	251	848.8	33.41	34.0	1.146	0.421	0.482

GSM1900 – Body SAR Test (Gap: 10mm)									
Plot No.	Mode	Test Position Body	Frequency		Output Power (dBm)	Rated Limit (dBm)	Scaling Factor	SAR1g (W/kg)	Scaled SAR1g (W/kg)
			CH.	MHz					
61.	GSM	Back	661	1880	30.51	31.0	1.119	0.172	0.193
62.	GSM	Front	661	1880	30.51	31.0	1.119	0.093	0.104

GSM850 – Body SAR Test (Gap: 10mm)									
Plot No.	Mode	Test Position Body	Frequency		Output Power (dBm)	Rated Limit (dBm)	Scaling Factor	SAR1g (W/kg)	Scaled SAR1g (W/kg)
			CH.	MHz					
63	GPRS_2TX	Back Side	251	848.8	31.42	32.0	1.143	0.586	0.670
64	GPRS_2TX	Front Side	251	848.8	31.42	32.0	1.143	0.574	0.656

GSM1900 – Body SAR Test (Gap: 10mm)									
Plot No.	Mode	Test Position Body	Frequency		Output Power (dBm)	Rated Limit (dBm)	Scaling Factor	SAR1g (W/kg)	Scaled SAR1g (W/kg)
			CH.	MHz					
67	GPRS_3TX	Back Side	661	1880	26.74	27.0	1.062	0.240	0.255
68	GPRS_3TX	Front Side	661	1880	26.74	27.0	1.062	0.123	0.131

WCDMA Band 2 – Body SAR Test (Gap: 10mm)									
Plot No.	Mode	Test Position Body	Frequency		Output Power (dBm)	Rated Limit (dBm)	Scaling Factor	SAR1g (W/kg)	Scaled SAR1g (W/kg)
			CH.	MHz					
71	RMC 12.2k	Back Side	9262	1852.4	21.62	22.0	1.091	0.265	0.289
72	RMC 12.2k	Front Side	9262	1852.4	21.62	22.0	1.091	0.124	0.135

WCDMA Band 5 – Body SAR Test (Gap: 10mm)									
Plot No.	Mode	Test Position Body	Frequency		Output Power (dBm)	Rated Limit (dBm)	Scaling Factor	SAR1g (W/kg)	Scaled SAR1g (W/kg)
			CH.	MHz					
75	RMC 12.2k	Back Side	4182	836.6	21.67	22.0	1.079	0.316	0.341
76	RMC 12.2k	Front Side	4182	836.6	21.67	22.0	1.079	0.356	0.384

LTE Band 2–Body SAR Test (Gap: 10mm)									
Plot No.	Mode	Test Position Body	Frequency	Output Power (dBm)	Rated Limit (dBm)	Scaling Factor	SAR1g (W/kg)	Scaled SAR1g (W/kg)	
	Modulation, Bandwidth, RB		MHz						
79	QPSK 20MHz 1RB	Back Side	1860.0	23.37	24.0	1.156	0.282	0.326	
80	QPSK 20MHz 1RB	Front Side	1860.0	23.37	24.0	1.156	0.13	0.150	
83	QPSK 20MHz 50%RB	Back Side	1860.0	22.78	23.0	1.052	0.127	0.134	
84	QPSK 20MHz 50%RB	Front Side	1860.0	22.78	23.0	1.052	0.067	0.070	

LTE Band 4–Body SAR Test (Gap: 10mm)									
Plot No.	Mode	Test Position Body	Frequency	Output Power (dBm)	Rated Limit (dBm)	Scaling Factor	SAR1g (W/kg)	Scaled SAR1g (W/kg)	
	Modulation, Bandwidth, RB		MHz						
87	QPSK 20MHz 1RB	Back Side	1732.5	23.99	24.5	1.125	0.339	0.381	
88	QPSK 20MHz 1RB	Front Side	1732.5	23.99	24.5	1.125	0.239	0.269	
91	QPSK 20MHz 50%RB	Back Side	1732.5	23.26	23.5	1.057	0.164	0.173	
92	QPSK 20MHz 50%RB	Front Side	1732.5	23.26	23.5	1.057	0.113	0.119	

LTE Band 7–Body SAR Test (Gap: 10mm)									
Plot No.	Mode	Test Position Body	Frequency	Output Power (dBm)	Rated Limit (dBm)	Scaling Factor	SAR1g (W/kg)	Scaled SAR1g (W/kg)	
	Modulation, Bandwidth, RB		MHz						
95	QPSK 20MHz 1RB	Back Side	2510.0	23.61	24.0	1.094	0.199	0.218	
96	QPSK 20MHz 1RB	Front Side	2510.0	23.61	24.0	1.094	0.121	0.132	
99	QPSK 20MHz 50%RB	Back Side	2510.0	22.82	23.0	1.042	0.097	0.101	
100	QPSK 20MHz 50%RB	Front Side	2510.0	22.82	23.0	1.042	0.063	0.066	

WLAN 2.4GHz –Body SAR Test									
Plot No.	Mode	Test Position Body	Frequency		Output Power (dBm)	Rated Limit (dBm)	Scaling Factor	SAR1g (W/kg)	Scaled SAR1g (W/kg)
			CH.	MHz					
103	802.11b	Back Side	11	2462	12.87	13.0	1.030	0.288	0.297
104	802.11b	Front Side	11	2462	12.87	13.0	1.030	0.216	0.223

**Remark:** Per KDB 447498 D01 v06, if the highest output channel SAR for each exposure position  $\leq 0.8$  W/kg other channels SAR tests are not necessary.

**Hotspot SAR**

GSM850 – Body SAR Test (Gap: 10mm)									
Plot No.	Mode	Test Position Body	Frequency		Output Power (dBm)	Rated Limit (dBm)	Scaling Factor	SAR1g (W/kg)	Scaled SAR1g (W/kg)
			CH.	MHz					
63.	GPRS_2TX	Back Side	251	848.8	31.42	32.0	1.143	0.586	0.670
64.	GPRS_2TX	Front Side	251	848.8	31.42	32.0	1.143	0.574	0.656
65.	GPRS_2TX	Bottom side	251	848.8	31.42	32.0	1.143	0.290	0.331
66.	GPRS_2TX	Right side	251	848.8	31.42	32.0	1.143	0.552	0.631

GSM1900 – Body SAR Test (Gap: 10mm)									
Plot No.	Mode	Test Position Body	Frequency		Output Power (dBm)	Rated Limit (dBm)	Scaling Factor	SAR1g (W/kg)	Scaled SAR1g (W/kg)
			CH.	MHz					
67.	GPRS_3TX	Back Side	661	1880	26.74	27.0	1.062	0.240	0.255
68.	GPRS_3TX	Front Side	661	1880	26.74	27.0	1.062	0.123	0.131
69.	GPRS_3TX	Bottom side	661	1880	26.74	27.0	1.062	0.162	0.172
70.	GPRS_3TX	Right side	661	1880	26.74	27.0	1.062	0.040	0.042

WCDMA Band 2 – Body SAR Test (Gap: 10mm)									
Plot No.	Mode	Test Position Body	Frequency		Output Power (dBm)	Rated Limit (dBm)	Scaling Factor	SAR1g (W/kg)	Scaled SAR1g (W/kg)
			CH.	MHz					
71.	RMC 12.2k	Back Side	9262	1852.4	21.62	22.0	1.091	0.265	0.289
72.	RMC 12.2k	Front Side	9262	1852.4	21.62	22.0	1.091	0.124	0.135
73.	RMC 12.2k	Bottom side	9262	1852.4	21.62	22.0	1.091	0.164	0.179
74.	RMC 12.2k	Right side	9262	1852.4	21.62	22.0	1.091	0.043	0.047

WCDMA Band 5 – Body SAR Test (Gap: 10mm)									
Plot No.	Mode	Test Position Body	Frequency		Output Power (dBm)	Rated Limit (dBm)	Scaling Factor	SAR1g (W/kg)	Scaled SAR1g (W/kg)
			CH.	MHz					
75.	RMC 12.2k	Back Side	4182	836.6	21.67	22.0	1.079	0.316	0.341
76.	RMC 12.2k	Front Side	4182	836.6	21.67	22.0	1.079	0.356	0.384
77.	RMC 12.2k	Bottom side	4182	836.6	21.67	22.0	1.079	0.15	0.162
78.	RMC 12.2k	Right side	4182	836.6	21.67	22.0	1.079	0.317	0.342

LTE Band 2–Body SAR Test (Gap: 10mm)								
Plot No.	Mode	Test Position Body	Frequency	Output Power (dBm)	Rate d Limit (dBm )	Scaling Factor	SAR1g (W/kg)	Scaled SAR1g (W/kg)
	Modulation, Bandwidth, RB		MHz					
79.	QPSK 20MHz 1RB	Back Side	1860.0	23.37	24.0	1.156	0.282	0.326
80.	QPSK 20MHz 1RB	Front Side	1860.0	23.37	24.0	1.156	0.13	0.150
81.	QPSK 20MHz 1RB	Bottom Side	1860.0	23.37	24.0	1.156	0.202	0.234
82.	QPSK 20MHz 1RB	Right side	1860.0	23.37	24.0	1.156	0.113	0.131
83.	QPSK 20MHz 50%RB	Back Side	1860.0	22.78	23.0	1.052	0.127	0.134
84.	QPSK 20MHz 50%RB	Front Side	1860.0	22.78	23.0	1.052	0.067	0.070
85.	QPSK 20MHz 50%RB	Bottom side	1860.0	22.78	23.0	1.052	0.111	0.117
86.	QPSK 20MHz 50%RB	Right side	1860.0	22.78	23.0	1.052	0.039	0.041

LTE Band 4–Body SAR Test (Gap: 10mm)								
Plot No.	Mode	Test Position Body	Frequency	Output Power (dBm)	Rate d Limit (dBm )	Scaling Factor	SAR1g (W/kg)	Scaled SAR1g (W/kg)
	Modulation, Bandwidth, RB		MHz					
87.	QPSK 20MHz 1RB	Back Side	1732.5	23.99	24.5	1.125	0.339	0.381
88.	QPSK 20MHz 1RB	Front Side	1732.5	23.99	24.5	1.125	0.239	0.269
89.	QPSK 20MHz 1RB	Bottom side	1732.5	23.99	24.5	1.125	0.187	0.210
90.	QPSK 20MHz 1RB	Right side	1732.5	23.99	24.5	1.125	0.121	0.136
91.	QPSK 20MHz 50%RB	Back Side	1732.5	23.26	23.5	1.057	0.164	0.173
92.	QPSK 20MHz 50%RB	Front Side	1732.5	23.26	23.5	1.057	0.113	0.119
93.	QPSK 20MHz 50%RB	Bottom side	1732.5	23.26	23.5	1.057	0.087	0.092
94.	QPSK 20MHz 50%RB	Right side	1732.5	23.26	23.5	1.057	0.067	0.071



LTE Band 7–Body SAR Test (Gap: 10mm)								
Plot No.	Mode	Test Position Body	Frequency	Output Power (dBm)	Rated Limit (dBm)	Scaling Factor	SAR1g (W/kg)	Scaled SAR1g (W/kg)
	Modulation, Bandwidth, RB		MHz					
95.	QPSK 20MHz 1RB	Back Side	2510.0	23.61	24.0	1.094	0.199	0.218
96.	QPSK 20MHz 1RB	Front Side	2510.0	23.61	24.0	1.094	0.121	0.132
97.	QPSK 20MHz 1RB	Bottom Side	2510.0	23.61	24.0	1.094	0.272	0.298
98.	QPSK 20MHz 1RB	Right side	2510.0	23.61	24.0	1.094	0.123	0.135
99.	QPSK 20MHz 50%RB	Back Side	2510.0	22.82	23.0	1.042	0.097	0.101
100.	QPSK 20MHz 50%RB	Front Side	2510.0	22.82	23.0	1.042	0.063	0.066
101.	QPSK 20MHz 50%RB	Bottom side	2510.0	22.82	23.0	1.042	0.131	0.137
102.	QPSK 20MHz 50%RB	Right side	2510.0	22.82	23.0	1.042	0.057	0.059

WLAN 2.4GHz –Body SAR Test									
Plot No.	Mode	Test Position Body	Frequency		Output Power (dBm)	Rated Limit (dBm)	Scaling Factor	SAR1g (W/kg)	Scaled SAR1g (W/kg)
			CH.	MHz					
103.	802.11b	Back Side	11	2462	12.87	13.0	1.030	0.288	0.297
104.	802.11b	Front Side	11	2462	12.87	13.0	1.030	0.216	0.223
105.	802.11b	Left side	11	2462	12.87	13.0	1.030	0.287	0.296
106.	802.11b	Top Side	11	2462	12.87	13.0	1.030	0.068	0.070

### 9.3 Simultaneous Multi-band Transmission SAR Analysis

#### List of Mode for Simultaneous Multi-band Transmission

No.	Configurations	Head SAR	Body-worn SAR	Hotspot SAR
1	GSM(Voice/Data) + WLAN(Data)	Yes	Yes	Yes
2	WCDMA (Voice/Data)+ WLAN(Data)	Yes	Yes	Yes
3	LTE(Data) + WLAN(Data)	Yes	Yes	Yes
4	GSM(Voice/Data) + Bluetooth(Data)	Yes	Yes	-
5	WCDMA(Voice) + Bluetooth(Data)	Yes	Yes	-
6	LTE(Data) + Bluetooth(Data)	Yes	Yes	-

#### Remark:

1. GSM ,WCDMA, and LTE share the same antenna, and cannot transmit simultaneously.
2. WLAN and Bluetooth share the same antenna, and cannot transmit simultaneously.
3. According to the KDB 447498 D01 v06, when standalone SAR test exclusion applies to an antenna that transmits simultaneously with other antennas, the standalone SAR must be estimated according to following to determine simultaneous transmission SAR test exclusion:

(max. power of channel, including tune-up tolerance, mW)/(min. test separation distance, mm) $^2$ ·[ $\sqrt{f}$ (GHz)/x] W/kg for test separation distances  $\leq$  50 mm;

where x = 7.5 for 1-g SAR, and x = 18.75 for 10-g SAR.

For simultaneous transmission analysis, Bluetooth SAR is estimated per KDB 447498 D01 v06 as below:

#### Bluetooth:

Tune-Up Power (dBm)	Max. Power (mW)	Distance (mm)	Frequency (GHz)	X	SAR(1g) 5mm	SAR(1g) 10mm
6.5	4.47	5/10	2.402	7.5	0.185	0.092

4. The maximum SAR summation is calculated based on the same configuration and test position.

**Head SAR**
**WWAN and WLAN**

Position	WWAN		WLAN	Summed SAR (W/kg)
	Band	Scaled SAR (W/kg)	Scaled SAR (W/kg)	
Right Cheek	GSM850	0.852	0.557	<b>1.409</b>
Right Tilted	GSM850	0.414	0.316	0.73
Left Cheek	GSM850	0.781	0.347	1.128
Left Tilted	GSM850	0.309	0.158	0.467
Right Cheek	GSM1900	0.034	0.557	0.591
Right Tilted	GSM1900	0.015	0.316	0.331
Left Cheek	GSM1900	0.031	0.347	0.378
Left Tilted	GSM1900	0.012	0.158	0.17
Right Cheek	GPRS850	0.718	0.557	1.275
Right Tilted	GPRS850	0.305	0.316	0.621
Left Cheek	GPRS850	0.701	0.347	1.048
Left Tilted	GPRS850	0.283	0.158	0.441
Right Cheek	GPRS1900	0.039	0.557	0.596
Right Tilted	GPRS1900	0.018	0.316	0.334
Left Cheek	GPRS1900	0.048	0.347	0.395
Left Tilted	GPRS1900	0.022	0.158	0.18
Right Cheek	WCDMA Band 2	0.052	0.557	0.609
Right Tilted	WCDMA Band 2	0.024	0.316	0.34
Left Cheek	WCDMA Band 2	0.056	0.347	0.403
Left Tilted	WCDMA Band 2	0.029	0.158	0.187
Right Cheek	WCDMA Band 5	0.326	0.557	0.883
Right Tilted	WCDMA Band 5	0.163	0.316	0.479
Left Cheek	WCDMA Band 5	0.304	0.347	0.651
Left Tilted	WCDMA Band 5	0.148	0.158	0.306
Right Cheek	LTE Band 2	0.052	0.557	0.609
Right Tilted	LTE Band 2	0.025	0.316	0.341
Left Cheek	LTE Band 2	0.061	0.347	0.408
Left Tilted	LTE Band 2	0.034	0.158	0.192
Right Cheek	LTE Band 4	0.108	0.557	0.665
Right Tilted	LTE Band 4	0.053	0.316	0.369
Left Cheek	LTE Band 4	0.118	0.347	0.465
Left Tilted	LTE Band 4	0.056	0.158	0.214
Right Cheek	LTE Band 7	0.561	0.557	1.118
Right Tilted	LTE Band 7	0.258	0.316	0.574
Left Cheek	LTE Band 7	0.247	0.347	0.594
Left Tilted	LTE Band 7	0.124	0.158	0.282

**WWAN and Bluetooth**

Position	WWAN		Bluetooth	Summed SAR (W/kg)
	Band	Scaled SAR (W/kg)	Scaled SAR (W/kg)	
Right Cheek	GSM850	0.852	0.185	<b>1.037</b>
Right Tilted	GSM850	0.414	0.185	0.599
Left Cheek	GSM850	0.781	0.185	0.966
Left Tilted	GSM850	0.309	0.185	0.494
Right Cheek	GSM1900	0.034	0.185	0.219
Right Tilted	GSM1900	0.015	0.185	0.2
Left Cheek	GSM1900	0.031	0.185	0.216
Left Tilted	GSM1900	0.012	0.185	0.197
Right Cheek	GPRS850	0.718	0.185	0.903
Right Tilted	GPRS850	0.305	0.185	0.49
Left Cheek	GPRS850	0.701	0.185	0.886
Left Tilted	GPRS850	0.283	0.185	0.468
Right Cheek	GPRS1900	0.039	0.185	0.224
Right Tilted	GPRS1900	0.018	0.185	0.203
Left Cheek	GPRS1900	0.048	0.185	0.233
Left Tilted	GPRS1900	0.022	0.185	0.207
Right Cheek	WCDMA Band 2	0.052	0.185	0.237
Right Tilted	WCDMA Band 2	0.024	0.185	0.209
Left Cheek	WCDMA Band 2	0.056	0.185	0.241
Left Tilted	WCDMA Band 2	0.029	0.185	0.214
Right Cheek	WCDMA Band 5	0.326	0.185	0.511
Right Tilted	WCDMA Band 5	0.163	0.185	0.348
Left Cheek	WCDMA Band 5	0.304	0.185	0.489
Left Tilted	WCDMA Band 5	0.148	0.185	0.333
Right Cheek	LTE Band 2	0.052	0.185	0.237
Right Tilted	LTE Band 2	0.025	0.185	0.21
Left Cheek	LTE Band 2	0.061	0.185	0.246
Left Tilted	LTE Band 2	0.034	0.185	0.219
Right Cheek	LTE Band 4	0.108	0.185	0.293
Right Tilted	LTE Band 4	0.053	0.185	0.238
Left Cheek	LTE Band 4	0.118	0.185	0.303
Left Tilted	LTE Band 4	0.056	0.185	0.241
Right Cheek	LTE Band 7	0.561	0.185	0.746
Right Tilted	LTE Band 7	0.258	0.185	0.443
Left Cheek	LTE Band 7	0.247	0.185	0.432
Left Tilted	LTE Band 7	0.124	0.185	0.309

**Body-worn SAR**
**WWAN and WLAN**

Position	WWAN		WLAN	Summed SAR (W/kg)
	Band	Scaled SAR (W/kg)	Scaled SAR (W/kg)	
Back	GSM850	0.966	0.297	<b>1.263</b>
Front	GSM850	0.868	0.223	1.091
Back	GSM1900	0.255	0.297	0.552
Front	GSM1900	0.131	0.223	0.354
Back	WCDMA Band 2	0.289	0.297	0.586
Front	WCDMA Band 2	0.135	0.223	0.358
Back	WCDMA Band 5	0.341	0.297	0.638
Front	WCDMA Band 5	0.384	0.223	0.607
Back	LTE Band 2	0.326	0.297	0.623
Front	LTE Band 2	0.150	0.223	0.373
Back	LTE Band 4	0.381	0.297	0.678
Front	LTE Band 4	0.269	0.223	0.492
Back	LTE Band 7	0.218	0.297	0.515
Front	LTE Band 7	0.132	0.223	0.355

**WWAN and Bluetooth**

Position	WWAN		Bluetooth	Summed SAR (W/kg)
	Band	Scaled SAR (W/kg)	Scaled SAR (W/kg)	
Back	GSM850	0.966	0.092	<b>1.058</b>
Front	GSM850	0.868	0.092	0.96
Back	GSM1900	0.255	0.092	0.347
Front	GSM1900	0.131	0.092	0.223
Back	WCDMA Band 2	0.289	0.092	0.381
Front	WCDMA Band 2	0.135	0.092	0.227
Back	WCDMA Band 5	0.341	0.092	0.433
Front	WCDMA Band 5	0.384	0.092	0.476
Back	LTE Band 2	0.326	0.092	0.418
Front	LTE Band 2	0.150	0.092	0.242
Back	LTE Band 4	0.381	0.092	0.473
Front	LTE Band 4	0.269	0.092	0.361
Back	LTE Band 7	0.218	0.092	0.31
Front	LTE Band 7	0.132	0.092	0.224

**Hotspot SAR**
**WWAN and WLAN**

Position	WWAN		WLAN	Summed SAR (W/kg)
	Band	Scaled SAR (W/kg)	Scaled SAR (W/kg)	
Back	GSM850	0.670	0.297	<b>0.967</b>
Front	GSM850	0.656	0.223	0.879
Top side	GSM850	--	0.070	0.070
Bottom side	GSM850	0.331	--	0.331
Right side	GSM850	0.631	--	0.631
Left side	GSM850	--	0.296	0.296
Back	GSM1900	0.255	0.297	0.552
Front	GSM1900	0.131	0.223	0.354
Top side	GSM1900	--	0.070	0.070
Bottom side	GSM1900	0.172	--	0.172
Right side	GSM1900	0.042	--	0.042
Left side	GSM1900	--	0.296	0.296
Back	WCDMA Band 2	0.289	0.297	0.586
Front	WCDMA Band 2	0.135	0.223	0.358
Top side	WCDMA Band 2	--	0.070	0.070
Bottom side	WCDMA Band 2	0.179	--	0.179
Right side	WCDMA Band 2	0.047	--	0.047
Left side	WCDMA Band 2	--	0.296	0.296
Back	WCDMA Band 5	0.341	0.297	0.638
Front	WCDMA Band 5	0.384	0.223	0.607
Top side	WCDMA Band 5	--	0.070	0.070
Bottom side	WCDMA Band 5	0.162	--	0.162
Right side	WCDMA Band 5	0.342	--	0.342
Left side	WCDMA Band 5	--	0.296	0.296
Back	LTE Band 2	0.326	0.297	0.623
Front	LTE Band 2	0.150	0.223	0.373
Top side	LTE Band 2	--	0.070	0.070
Bottom side	LTE Band 2	0.234	--	0.234
Right side	LTE Band 2	0.131	--	0.131
Left side	LTE Band 2	--	0.296	0.296
Back	LTE Band 4	0.381	0.297	0.678
Front	LTE Band 4	0.269	0.223	0.492
Top side	LTE Band 4	--	0.070	0.070
Bottom side	LTE Band 4	0.210	--	0.210
Right side	LTE Band 4	0.136	--	0.136
Left side	LTE Band 4	--	0.296	0.296
Back	LTE Band 7	0.218	0.297	0.515

---

---

Front	LTE Band 7	0.132	0.223	0.355
Top side	LTE Band 7	--	0.070	0.070
Bottom side	LTE Band 7	0.298	--	0.298
Right side	LTE Band 7	0.135	--	0.135
Left side	LTE Band 7	--	0.296	0.296

## 10. Measurement Uncertainty

### 10.1 Uncertainty for EUT SAR Test

a	b	c	d	e= f(d,k)	f	g	h= c*f/e	i= c*g/e	k
Uncertainty Component	Sec.	Tol (+- %)	Prob. Dist.	Div.	Ci (1g)	Ci (10g)	1g Ui (+-%)	10g Ui (+-%)	Vi
<b>Measurement System</b>									
Probe calibration	E.2.1	7.0	N	1	1	1	7.00	7.00	$\infty$
Axial Isotropy	E.2.2	2.5	R	$\sqrt{3}$	$(1_{Cp})^{1/2}$	$(1_{Cp})^{1/2}$	1.02	1.02	$\infty$
Hemispherical Isotropy	E.2.2	4.0	R	$\sqrt{3}$	$(Cp)^{1/2}$	$(Cp)^{1/2}$	1.63	1.63	$\infty$
Boundary effect	E.2.3	1.0	R	$\sqrt{3}$	1	1	0.58	0.58	$\infty$
Linearity	E.2.4	5.0	R	$\sqrt{3}$	1	1	2.89	2.89	$\infty$
System detection limits	E.2.5	1.0	R	$\sqrt{3}$	1	1	0.58	0.58	$\infty$
Readout Electronics	E.2.6	0.02	N	1	1	1	0.02	0.02	$\infty$
Reponse Time	E.2.7	3.0	R	$\sqrt{3}$	1	1	1.73	1.73	$\infty$
Integration Time	E.2.8	2.0	R	$\sqrt{3}$	1	1	1.15	1.15	$\infty$
RF ambient Conditions – Noise	E.6.1	3.0	R	$\sqrt{3}$	1	1	1.73	1.73	$\infty$
RF ambient Conditions - Reflections	E.6.1	3.0	R	$\sqrt{3}$	1	1	1.73	1.73	$\infty$
Probe positioner Mechanical Tolerance	E.6.2	2.0	R	$\sqrt{3}$	1	1	1.15	1.15	$\infty$
Probe positioning with respect to Phantom Shell	E.6.3	0.05	R	$\sqrt{3}$	1	1	0.03	0.03	$\infty$
Extrapolation, interpolation and integration Algorithms for Max. SAR Evaluation	E.5	5.0	R	$\sqrt{3}$	1	1	2.89	2.89	$\infty$
<b>Test Sample Related</b>									
Test sample positioning	E.4.2	0.03	N	1	1	1	0.03	0.03	N-1
Device Holder Uncertainty	E.4.1	5.00	N	1	1	1	5.00	5.00	
Output power Variation - SAR drift measurement	E.2.9	12.02	R	$\sqrt{3}$	1	1	6.94	6.94	$\infty$
SAR scaling	E6.5	0.0	R	$\sqrt{3}$	1	1	0.0	0.0	$\infty$
<b>Phantom and Tissue Parameters</b>									
Phantom Uncertainty (Shape and thickness tolerances)	E.3.1	0.05	R	$\sqrt{3}$	1	1	0.03	0.03	$\infty$
Uncertainty in SAR correction for deviations in permittivity and conductivity	E3.2	1.9	R	$\sqrt{3}$	1	0.84	1.10	0.90	$\infty$
Liquid conductivity - deviation	E.3.2	5.00	R	$\sqrt{3}$	0.64	0.43	1.85	1.24	$\infty$



from target value										
Liquid conductivity measurement uncertainty	E.3.3	5.00	N	1	0.64	0.43	3.20	2.15	$\infty$	
Liquid permittivity - deviation from target value	E.3.2	0.37	R	$\sqrt{3}$	0.6	0.49	0.13	0.10	$\infty$	
Liquid permittivity measurement uncertainty	E.3.3	10.00	N	1	0.6	0.49	6.00	4.90	$\infty$	
Combined Standard Uncertainty			RSS				12.98	12.53		
Expanded Uncertainty (95% Confidence interval)			K=2				25.32	24.43		

## 10.2 Uncertainty for System Performance Check

a	b	c	d	e= f(d,k)	f	g	h= c*f/e	i= c*g/e	k
Uncertainty Component	Sec.	Tol (+- %)	Prob. Dist.	Div.	Ci (1g)	Ci (10g)	1g Ui (+- %)	10g Ui (+- %)	Vi
<b>Measurement System</b>									
Probe calibration	E.2.1	7.0	N	1	1	1	7.00	7.00	$\infty$
Axial Isotropy	E.2.2	2.5	R	$\sqrt{3}$	$(1_{Cp})^{1/2}$	$(1_{Cp})^{1/2}$	1.02	1.02	$\infty$
Hemispherical Isotropy	E.2.2	4.0	R	$\sqrt{3}$	$(Cp)^{1/2}$	$(Cp)^{1/2}$	1.63	1.63	$\infty$
Boundary effect	E.2.3	1.0	R	$\sqrt{3}$	1	1	0.58	0.58	$\infty$
Linearity	E.2.4	5.0	R	$\sqrt{3}$	1	1	2.89	2.89	$\infty$
System detection limits	E.2.5	1.0	R	$\sqrt{3}$	1	1	0.58	0.58	$\infty$
Modulation response	E.2.5	0	R	$\sqrt{3}$	0	0	0.0	0.0	$\infty$
Readout Electronics	E.2.6	0.02	N	1	1	1	0.02	0.02	$\infty$
Reponse Time	E.2.7	3.0	R	$\sqrt{3}$	1	1	1.73	1.73	$\infty$
Integration Time	E.2.8	2.0	R	$\sqrt{3}$	1	1	1.15	1.15	$\infty$
RF ambient Conditions – Noise	E.6.1	3.0	R	$\sqrt{3}$	1	1	1.73	1.73	$\infty$
RF ambient Conditions - Reflections	E.6.1	3.0	R	$\sqrt{3}$	1	1	1.73	1.73	$\infty$
Probe positioner Mechanical Tolerance	E.6.2	2.0	R	$\sqrt{3}$	1	1	1.15	1.15	$\infty$
Probe positioning with respect to Phantom Shell	E.6.3	0.05	R	$\sqrt{3}$	1	1	0.03	0.03	$\infty$
Extrapolation, interpolation and integration Algorithms for Max.	E.5.2	5.0	R	$\sqrt{3}$	1	1	2.89	2.89	$\infty$

SAR Evaluation									
<b>Dipole</b>									
Dipole axis to liquid Distance	8,E.4.2	1.00	N	$\sqrt{3}$	1	1	0.58	0.58	N-1
Input power and SAR drift measurement	8,6.6.2	12.02	R	$\sqrt{3}$	1	1	6.94	6.94	$\infty$
Deviation of experimental dipole from numerical dipole	E.6.4	5.5	R	$\sqrt{3}$	1	1	3.20	3.20	$\infty$
<b>Phantom and Tissue Parameters</b>									
Phantom Uncertainty (Shape and thickness tolerances)	E.3.1	0.05	R	$\sqrt{3}$	1	1	0.03	0.03	$\infty$
Uncertainty in SAR correction for deviations in permittivity and conductivity	E3.2	2.0	R	$\sqrt{3}$	1	0.84	1.10	1.10	$\infty$
Liquid conductivity - deviation from target value	E.3.2	5.00	R	$\sqrt{3}$	0.64	0.43	1.85	1.24	
Liquid conductivity - measurement uncertainty	E.3.3	5.00	N	1	0.64	0.43	3.20	2.15	
Liquid permittivity - deviation from target value	E.3.2	0.37	R	$\sqrt{3}$	0.6	0.49	0.13	0.10	
Liquid permittivity - measurement uncertainty	E.3.3	10.00	N	1	0.6	0.49	6.00	4.90	M
Combined Standard Uncertainty			RSS				12.00	11.50	
Expanded Uncertainty (95% Confidence interval)			K=2				23.39	22.43	

## Annex A. Plots of System Performance Check

# MEASUREMENT 1

### For Head Liquid

Type: Validation measurement (Fast, 75.00 %)

Date of measurement: 10/29/2018

Measurement duration: 7 minutes 21 seconds

E-field Probe: SSE5 - SN 09/13 EP168; ConvF: 6.93; Calibrated: 06/01/2018

### A. Experimental conditions

<b>Area Scan</b>	dx=8mm dy=8mm
<b>Phantom</b>	Validation plane
<b>Device Position</b>	Dipole
<b>Band</b>	CW835
<b>Signal</b>	Duty Cycle 1:1

### B. SAR Measurement Results

<b>Frequency (MHz)</b>	835.000000
<b>Relative Permittivity (real part)</b>	41.110245
<b>Conductivity (S/m)</b>	0.871245
<b>Power Variation (%)</b>	0.038437
<b>Ambient Temperature</b>	21.1
<b>Liquid Temperature</b>	21.3

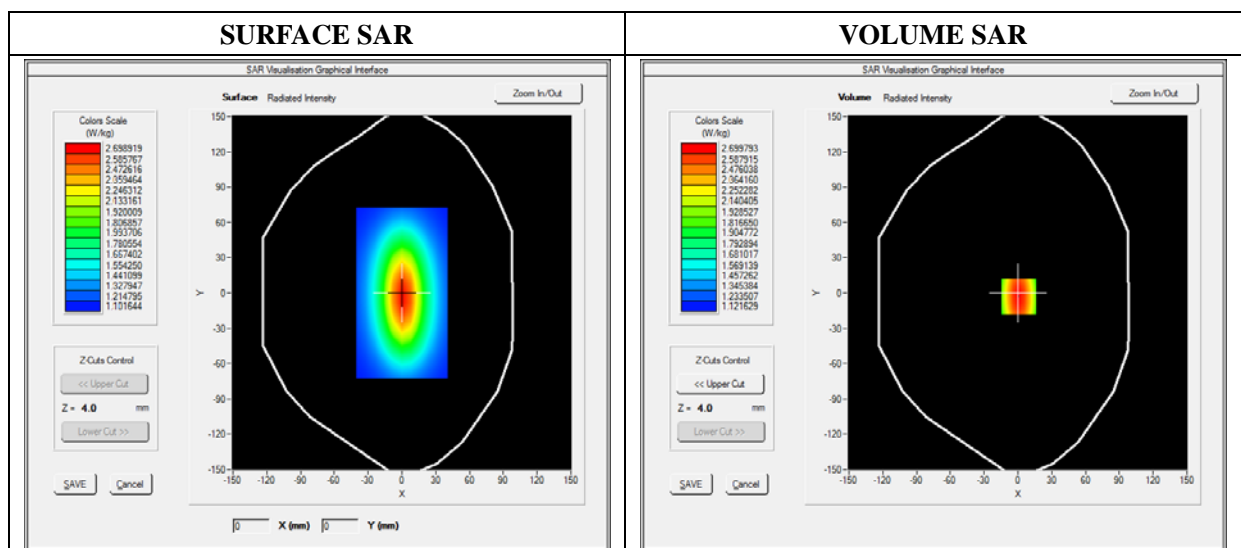

Maximum location: X=0.00, Y=0.00

SAR 10g (W/Kg)	1.129489
SAR 1g (W/Kg)	2.411253

Z Axis Scan

Z (mm)	0.00	4.00	9.00	14.00	19.00	24.00	29.00
SAR (W/Kg)	0.0000	2.4900	1.8942	1.4811	1.3541	1.1123	1.0539

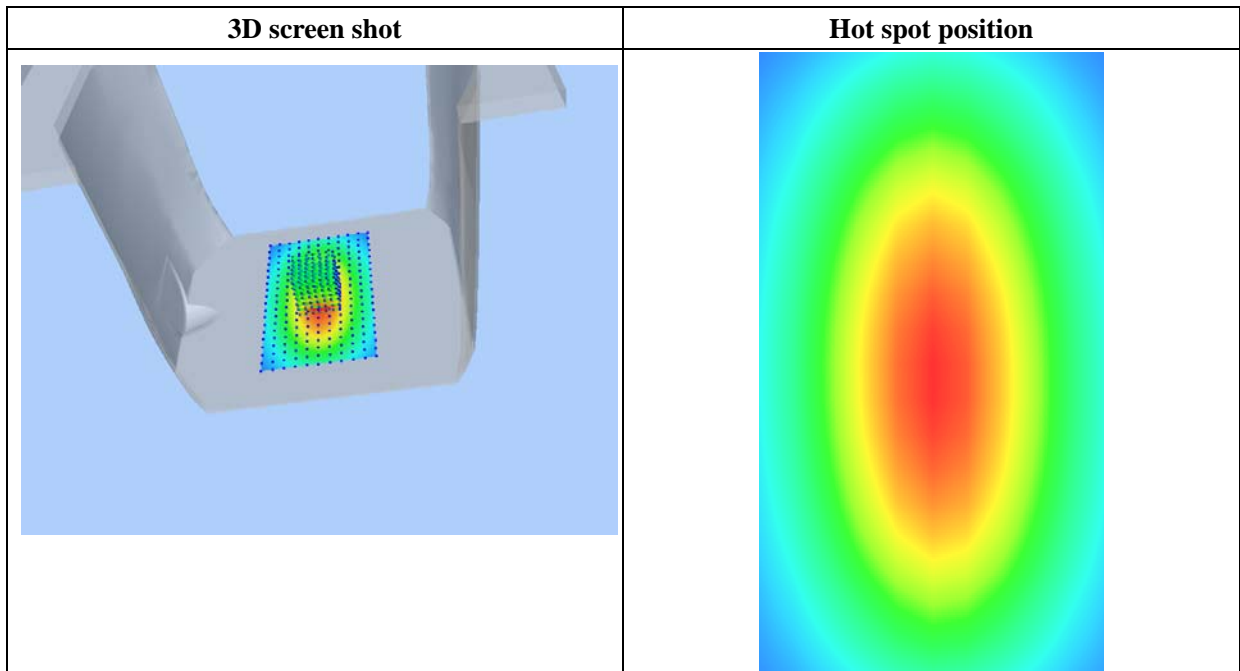
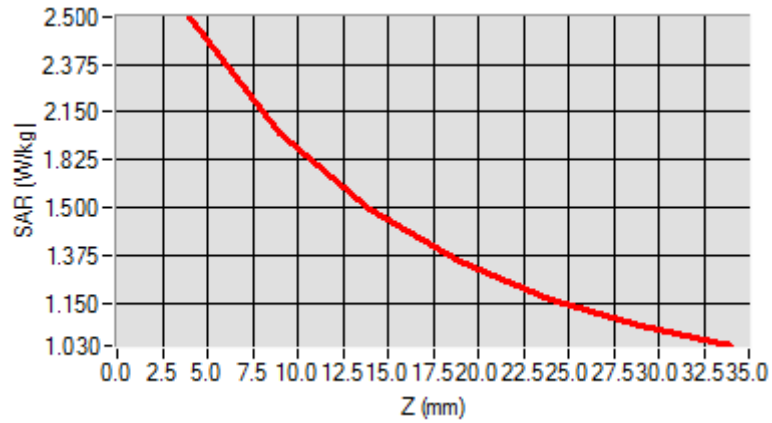

## MEASUREMENT 2

### For Head Liquid

Type: Validation measurement (Fast, 75.00 %)

Date of measurement: 10/30/2018

Measurement duration: 12 minutes 21 seconds

E-field Probe: SSE5 - SN 09/13 EP168; ConvF: 5.84; Calibrated: 06/01/2018

### A. Experimental conditions

<b>Area Scan</b>	dx=8mm dy=8mm
<b>Phantom</b>	Validation plane
<b>Device Position</b>	Dipole
<b>Band</b>	CW1800
<b>Signal</b>	CW (Crest factor: 1.0)

### B. SAR Measurement Results

<b>Frequency (MHz)</b>	1800.000000
<b>Relative Permittivity (real part)</b>	39.024890
<b>Conductivity (S/m)</b>	1.371250
<b>Power Variation (%)</b>	1.401232
<b>Ambient Temperature</b>	21.1
<b>Liquid Temperature</b>	21.2

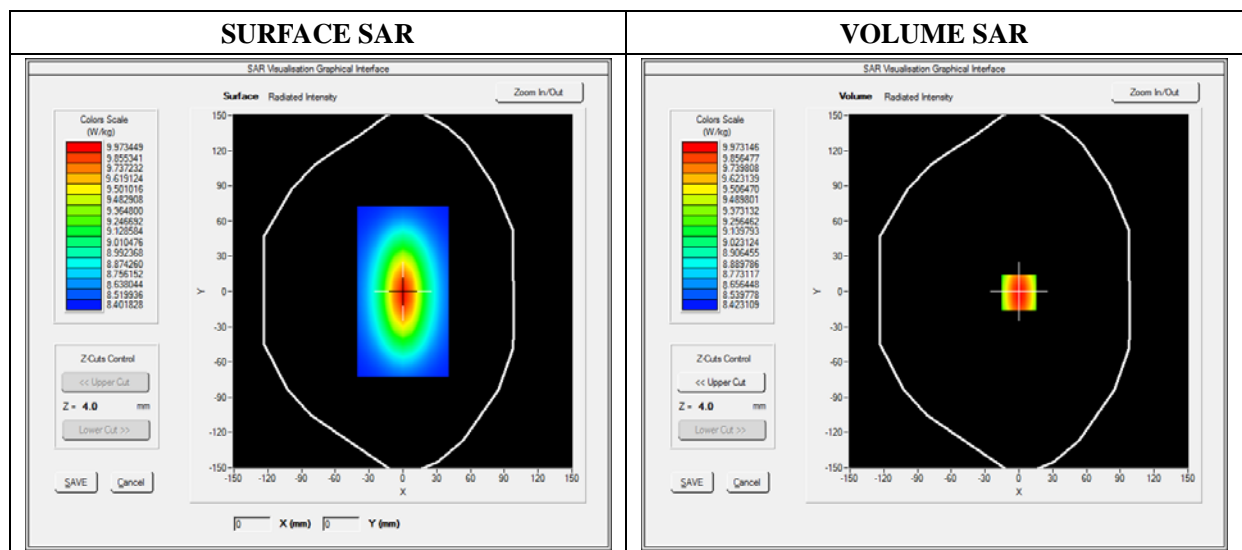

Maximum location: X=0.00, Y=0.00

SAR 10g (W/Kg)	5.171252
SAR 1g (W/Kg)	9.611250

Z Axis Scan

Z (mm)	0.00	4.00	9.00	14.00	19.00	24.00	29.00
SAR (W/Kg)	0.0000	10.3455	7.1125	5.1026	3.425	3.0242	2.1125

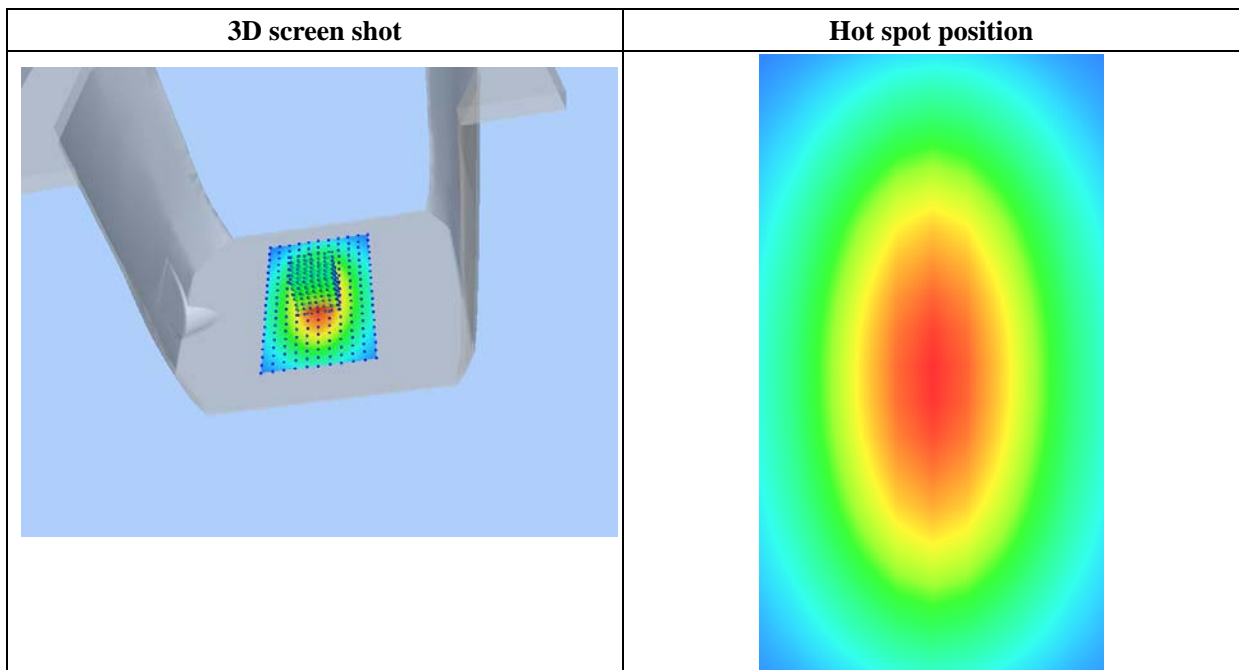
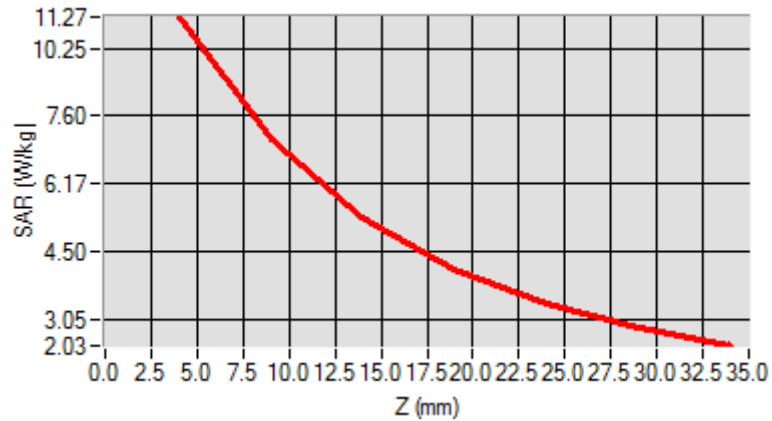

# MEASUREMENT 3

**For Head Liquid**

Type: Validation measurement (Fast, 75.00 %)

Date of measurement: 10/30/2018

Measurement duration: 12 minutes 21 seconds

E-field Probe: SSE5 - SN 09/13 EP168; ConvF: 6.35; Calibrated: 06/01/2018

**A. Experimental conditions**

<b>Area Scan</b>	dx=8mm dy=8mm
<b>Phantom</b>	Validation plane
<b>Device Position</b>	Dipole
<b>Band</b>	CW1900
<b>Signal</b>	Duty Cycle 1:1

**B. SAR Measurement Results**

<b>Frequency (MHz)</b>	1900.000000
<b>Relative Permittivity (real part)</b>	38.560124
<b>Conductivity (S/m)</b>	1.380369
<b>Power Variation (%)</b>	1.022540
<b>Ambient Temperature</b>	21.1
<b>Liquid Temperature</b>	21.3

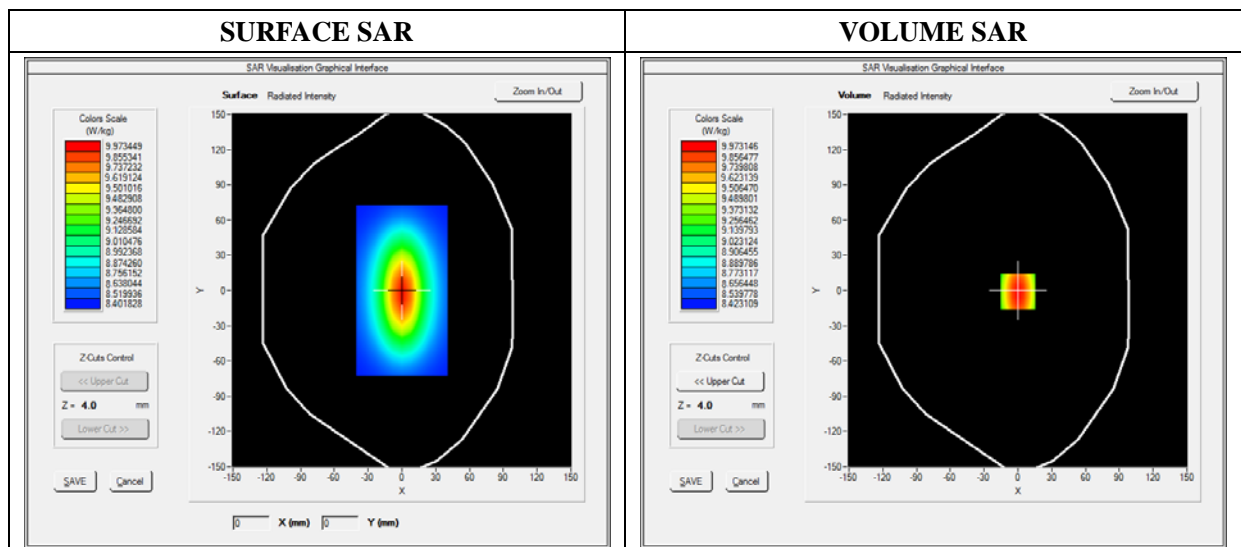

Maximum location: X=0.00, Y=0.00

SAR 10g (W/Kg)	7.174526
SAR 1g (W/Kg)	9.913214

Z Axis Scan

Z (mm)	0.00	4.00	9.00	14.00	19.00	24.00	29.00
SAR (W/Kg)	0.0000	10.2354	6.8400	5.0121	4.1189	3.0522	2.8424

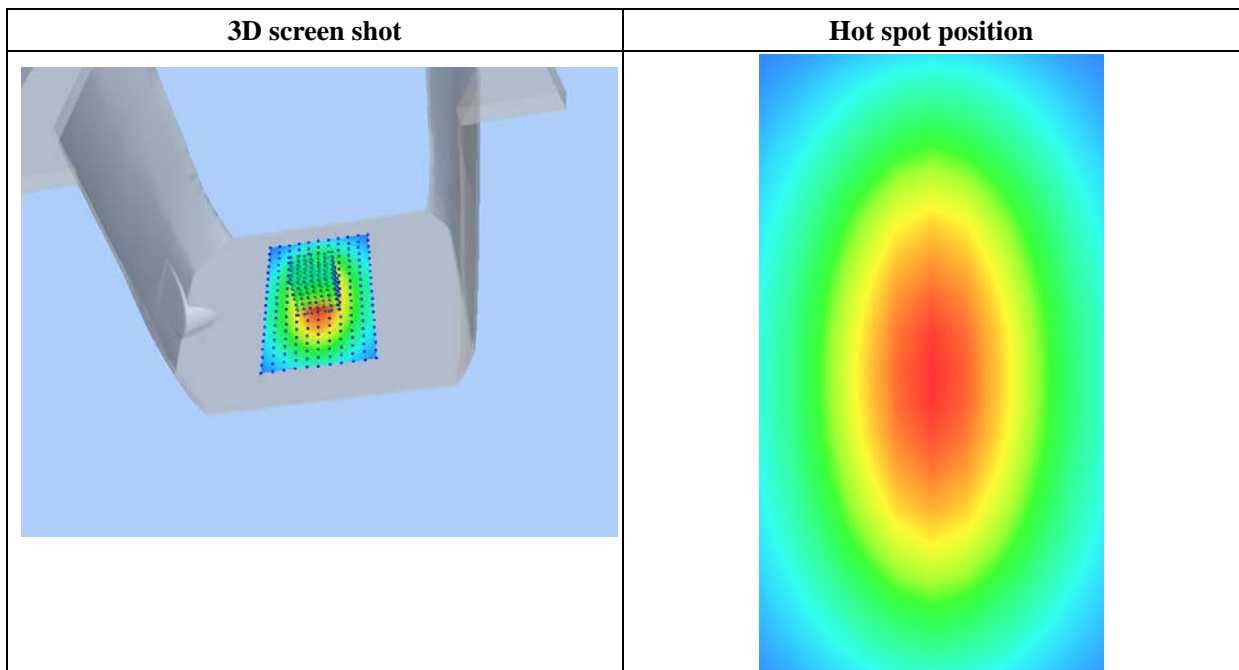
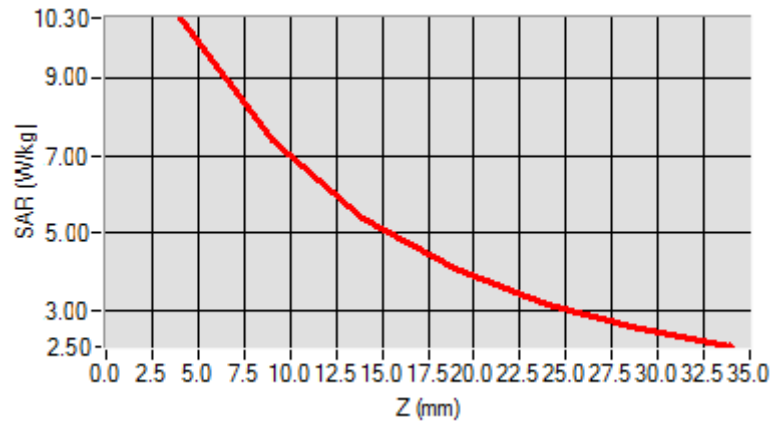



# MEASUREMENT 4

## For Head Liquid

Type: Validation measurement (Fast, 75.00 %)

Date of measurement: 10/31/2018

Measurement duration: 12 minutes 21 seconds

E-field Probe: SSE5 - SN 09/13 EP168; ConvF: 5.64; Calibrated: 06/01/2018

### A. Experimental conditions

<b>Area Scan</b>	dx=8mm dy=8mm
<b>Phantom</b>	Validation plane
<b>Device Position</b>	Dipole
<b>Band</b>	CW2450
<b>Signal</b>	Duty Cycle 1:1

### B. SAR Measurement Results

<b>Frequency (MHz)</b>	2450.000000
<b>Relative Permittivity (real part)</b>	38.153660
<b>Conductivity (S/m)</b>	1.740236
<b>Power Variation (%)</b>	1.141452
<b>Ambient Temperature</b>	21.1
<b>Liquid Temperature</b>	21.2

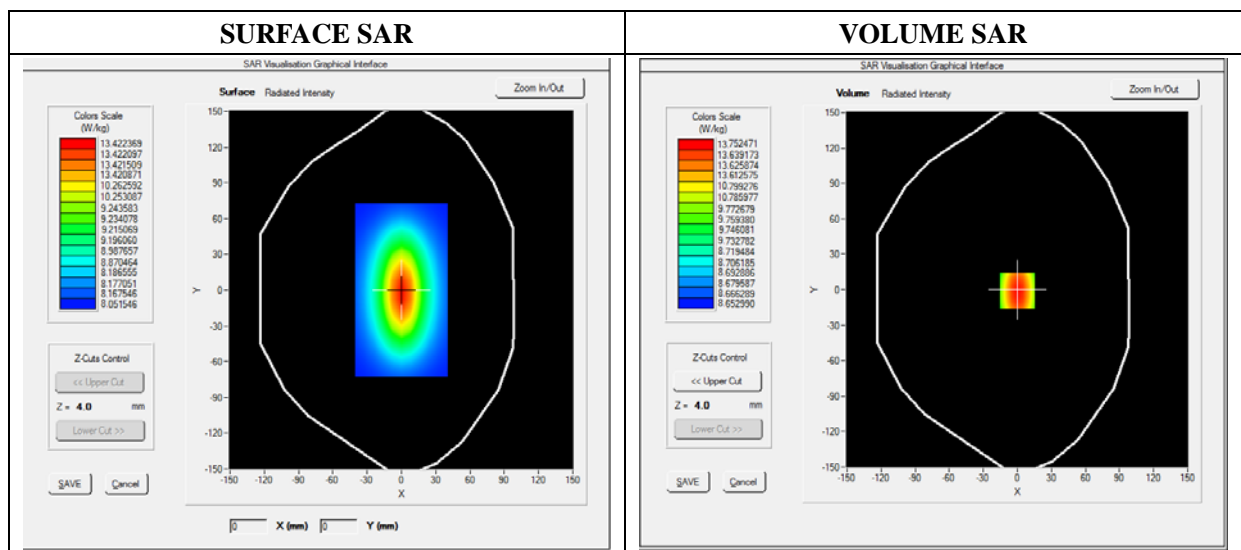

Maximum location: X=0.00, Y=0.00

SAR 10g (W/Kg)	8.020427
SAR 1g (W/Kg)	13.452457

Z Axis Scan

Z (mm)	0.00	4.00	9.00	14.00	19.00	24.00	29.00
SAR (W/Kg)	0.0000	14.1034	12.0012	10.2624	7.4715	5.9022	4.5114

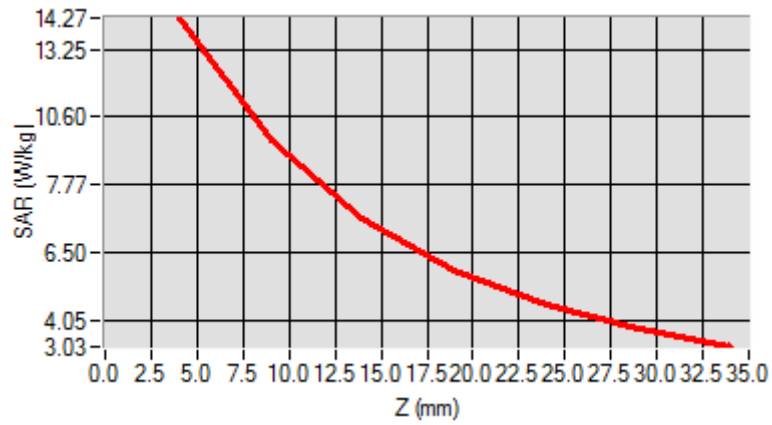

3D screen shot

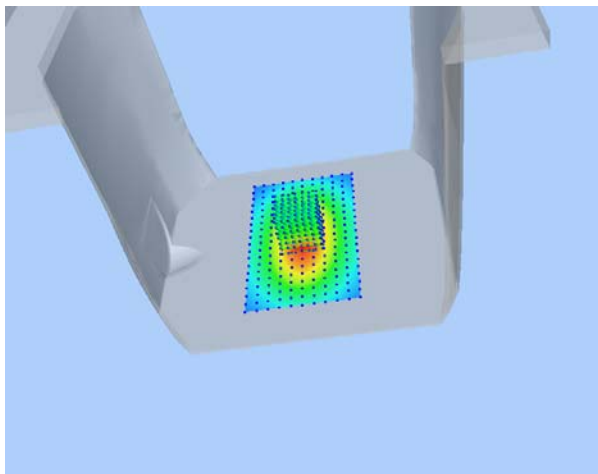

Hot spot position

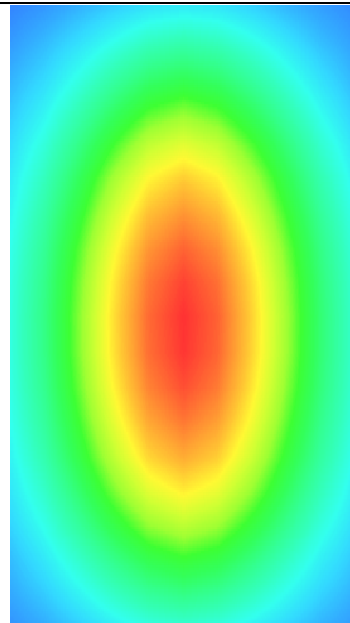

# MEASUREMENT 5

## For Head Liquid

Type: Validation measurement (Fast, 75.00 %)

Date of measurement: 10/31/2018

Measurement duration: 12 minutes 21 seconds

E-field Probe: SSE5 - SN 09/13 EP168; ConvF: 5.37; Calibrated: 06/01/2018

### A. Experimental conditions

<b>Area Scan</b>	dx=8mm dy=8mm
<b>Phantom</b>	Validation plane
<b>Device Position</b>	Dipole
<b>Band</b>	CW2600
<b>Signal</b>	Duty Cycle 1:1

### B. SAR Measurement Results

<b>Frequency (MHz)</b>	2600.000000
<b>Relative Permittivity (real part)</b>	38.631092
<b>Conductivity (S/m)</b>	1.930182
<b>Power Variation (%)</b>	1.028221
<b>Ambient Temperature</b>	21.1
<b>Liquid Temperature</b>	21.2

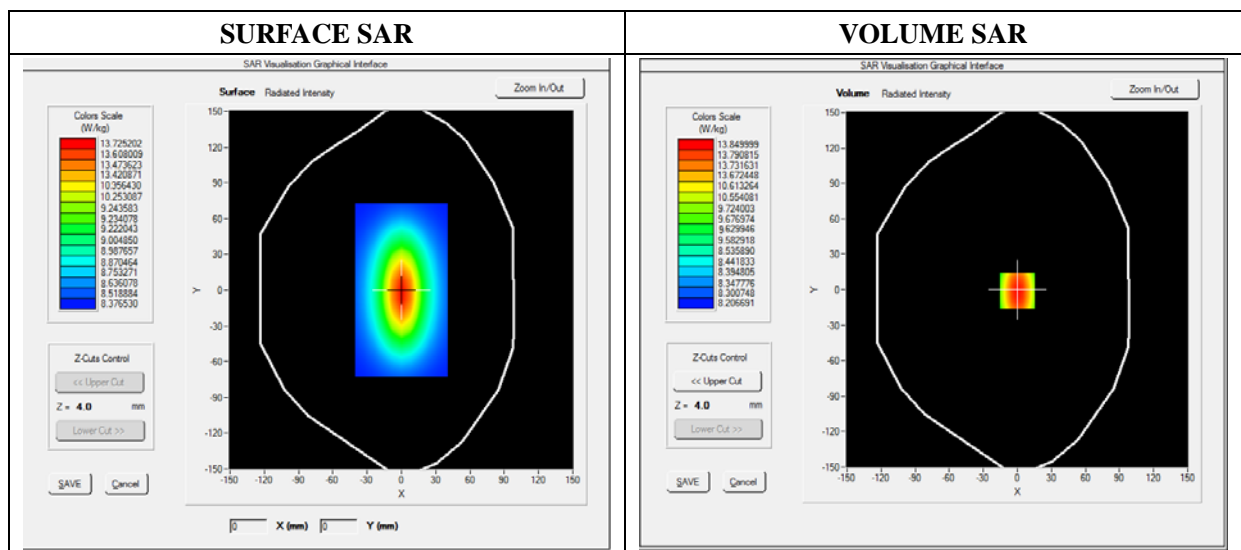

Maximum location: X=0.00, Y=0.00

SAR 10g (W/Kg)	8.270822
SAR 1g (W/Kg)	13.670282

Z Axis Scan

Z (mm)	0.00	4.00	9.00	14.00	19.00	24.00	29.00
SAR (W/Kg)	0.0000	14.0426	12.1354	10.2965	7.4854	5.9354	4.5186

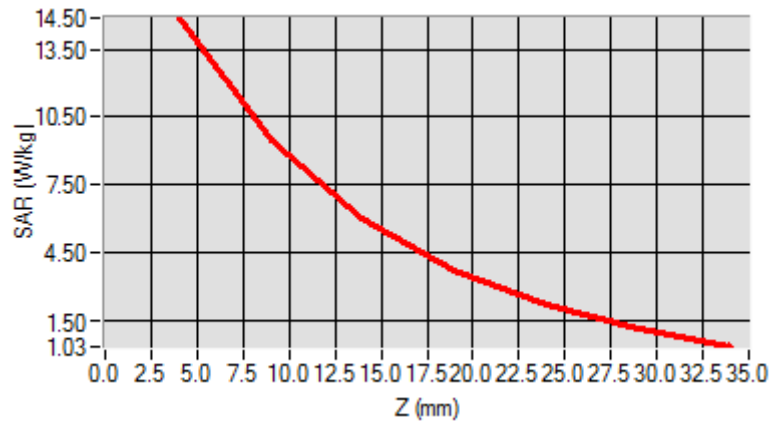

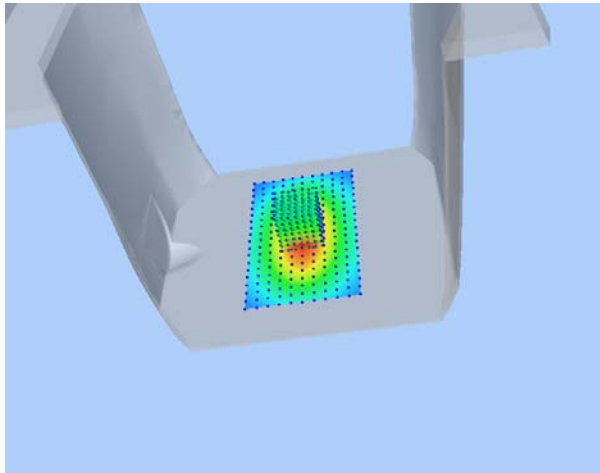
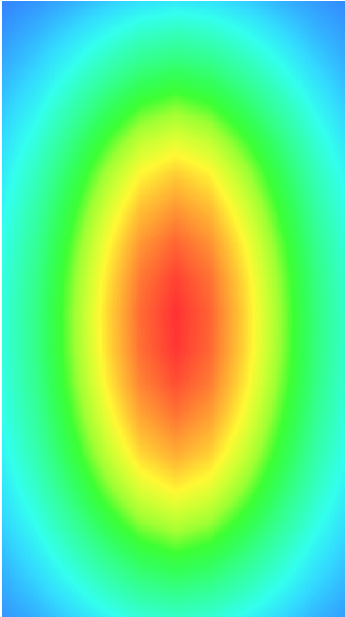
3D screen shot	Hot spot position
	

# MEASUREMENT 6

**For Body Liquid**

Type: Validation measurement (Fast, 75.00 %)

Date of measurement: 10/29/2018

Measurement duration: 12 minutes 21 seconds

E-field Probe: SSE5 - SN 09/13 EP168; ConvF: 7.13; Calibrated: 06/01/2018

**A. Experimental conditions**

<b>Area Scan</b>	dx=8mm dy=8mm
<b>Phantom</b>	Validation plane
<b>Device Position</b>	Dipole
<b>Band</b>	CW835
<b>Signal</b>	Duty Cycle 1:1

**B. SAR Measurement Results**

<b>Frequency (MHz)</b>	835.000000
<b>Relative Permittivity (real part)</b>	54.851214
<b>Conductivity (S/m)</b>	0.951454
<b>Power Variation (%)</b>	0.901472
<b>Ambient Temperature</b>	21.1
<b>Liquid Temperature</b>	21.3

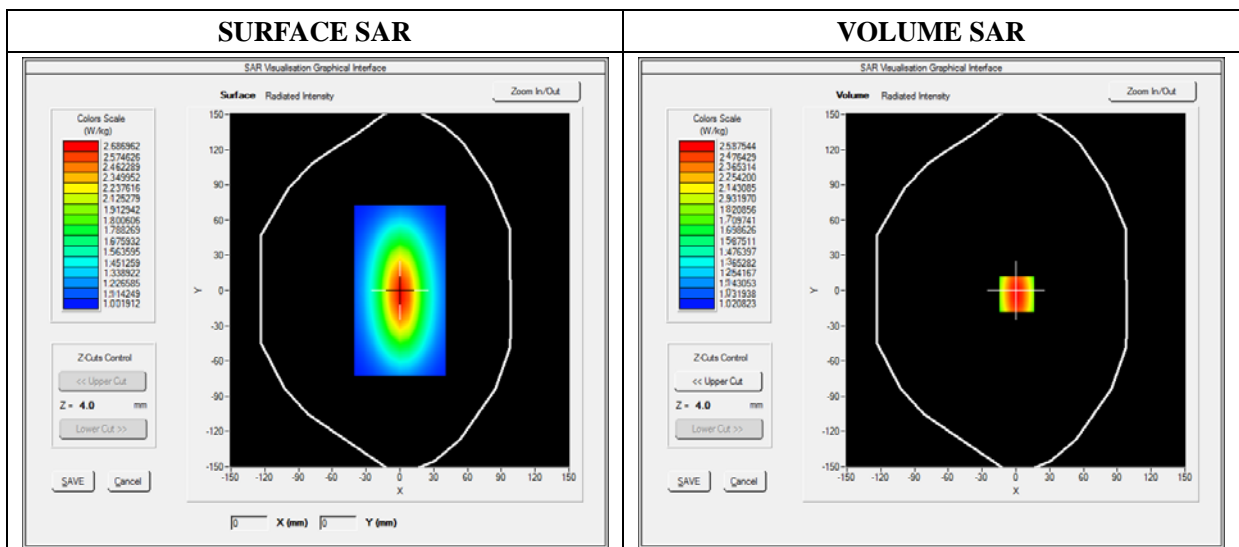

Maximum location: X=0.00, Y=0.00

SAR 10g (W/Kg)	1.028956
SAR 1g (W/Kg)	2.354211

Z Axis Scan

Z (mm)	0.00	4.00	9.00	14.00	19.00	24.00	29.00
SAR (W/Kg)	0.0000	2.5789	1.1300	0.8795	0.5940	0.5011	0.5100

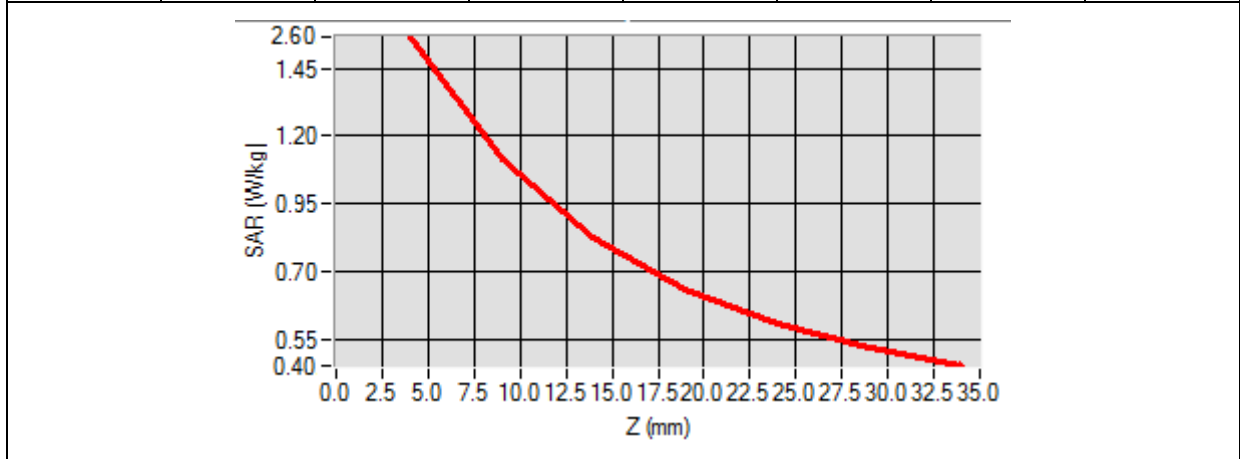

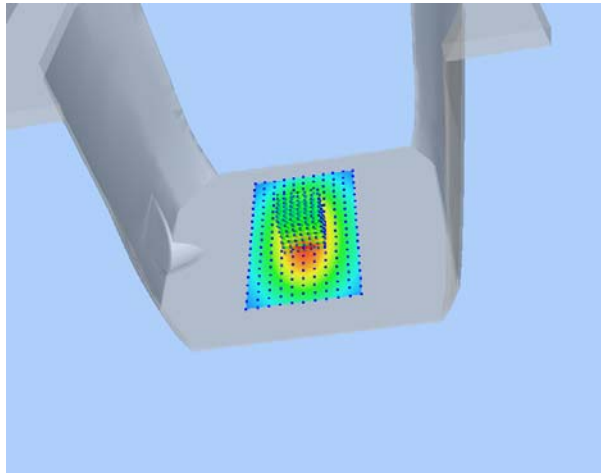
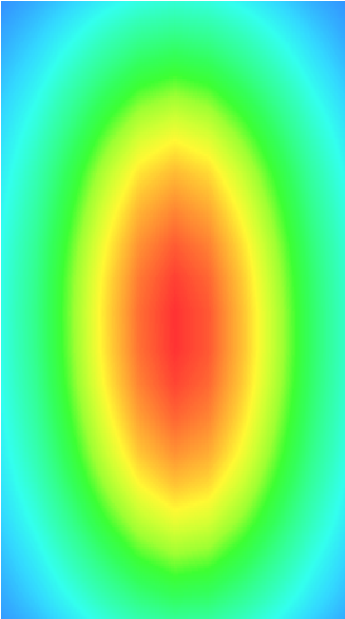
3D screen shot	Hot spot position
	

# MEASUREMENT 7

## For Body Liquid

Type: Validation measurement (Fast, 75.00 %)

Date of measurement: 10/30/2018

Measurement duration: 12 minutes 21 seconds

E-field Probe: SSE5 - SN 09/13 EP168; ConvF: 6.06; Calibrated: 06/01/2018

### A. Experimental conditions

<b>Area Scan</b>	dx=8mm dy=8mm
<b>Phantom</b>	Validation plane
<b>Device Position</b>	Dipole
<b>Band</b>	CW1800
<b>Signal</b>	CW (Crest factor: 1.0)

### B. SAR Measurement Results

<b>Frequency (MHz)</b>	1800.000000
<b>Relative Permittivity (real part)</b>	51.224510
<b>Conductivity (S/m)</b>	1.461261
<b>Power Variation (%)</b>	0.845690
<b>Ambient Temperature</b>	21.1
<b>Liquid Temperature</b>	21.2

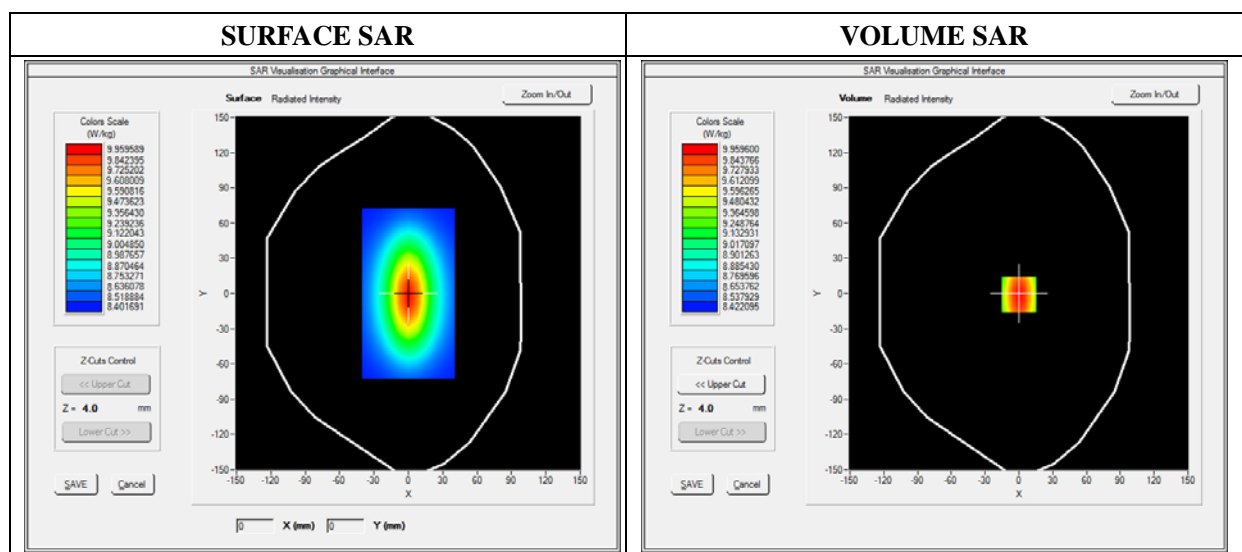

Maximum location: X=0.00, Y=0.00

SAR 10g (W/Kg)	5.221202
SAR 1g (W/Kg)	9.582560

Z Axis Scan

Z (mm)	0.00	4.00	9.00	14.00	19.00	24.00	29.00
SAR (W/Kg)	0.0000	11.2425	9.4123	8.0345	6.9125	6.3092	3.9460

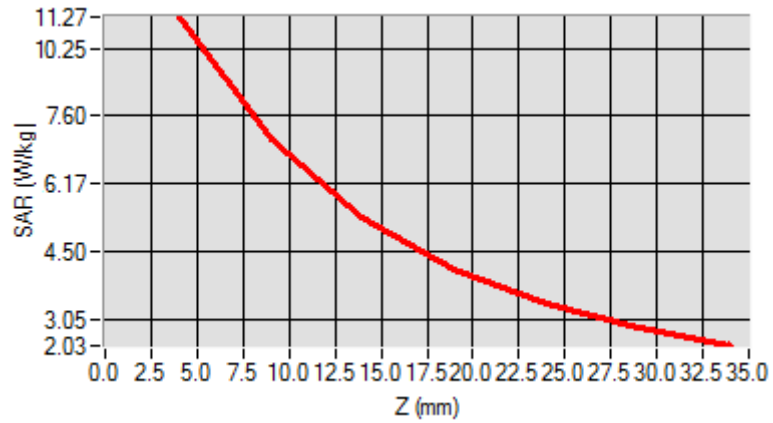

3D screen shot

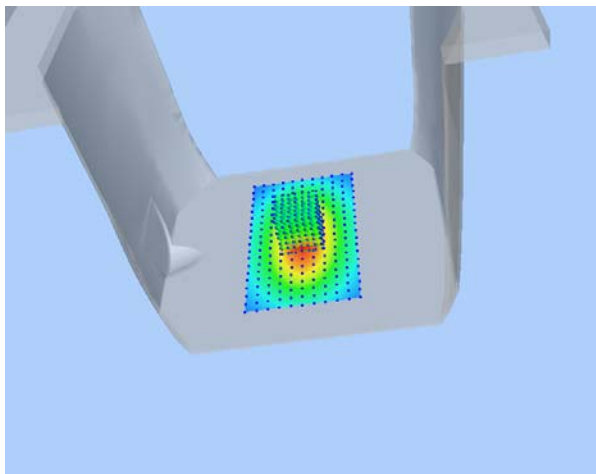

Hot spot position

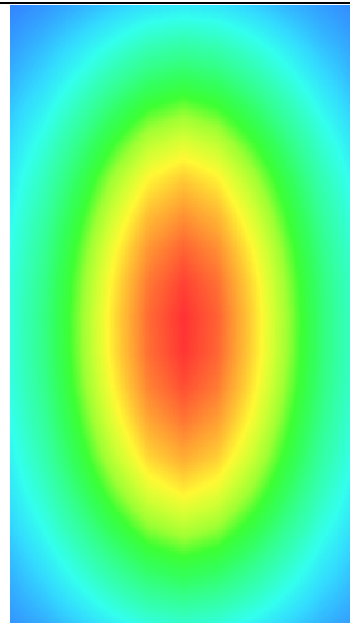



# MEASUREMENT 8

## For Body Liquid

Type: Validation measurement (Fast, 75.00 %)

Date of measurement: 10/30/2018

Measurement duration: 12 minutes 21 seconds

E-field Probe: SSE5 - SN 09/13 EP168; ConvF: 6.55; Calibrated: 06/01/2018

### A. Experimental conditions

<b>Area Scan</b>	dx=8mm dy=8mm
<b>Phantom</b>	Validation plane
<b>Device Position</b>	Dipole
<b>Band</b>	CW1900
<b>Signal</b>	Duty Cycle 1:1

### B. SAR Measurement Results

<b>Frequency (MHz)</b>	1900.000000
<b>Relative Permittivity (real part)</b>	52.420415
<b>Conductivity (S/m)</b>	1.501966
<b>Power Variation (%)</b>	0.541872
<b>Ambient Temperature</b>	21.1
<b>Liquid Temperature</b>	21.3

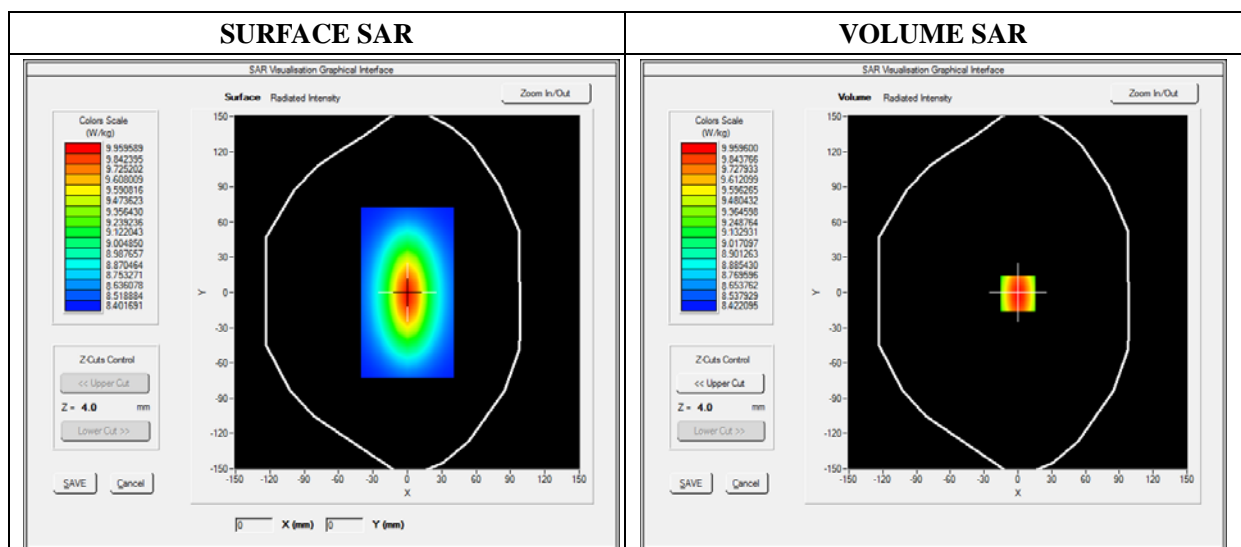

Maximum location: X=0.00, Y=0.00

SAR 10g (W/Kg)	5.134651
SAR 1g (W/Kg)	9.781550

Z Axis Scan

Z (mm)	0.00	4.00	9.00	14.00	19.00	24.00	29.00
SAR (W/Kg)	0.0000	10.2031	6.43001	4.9011	4.5325	3.1201	2.5024

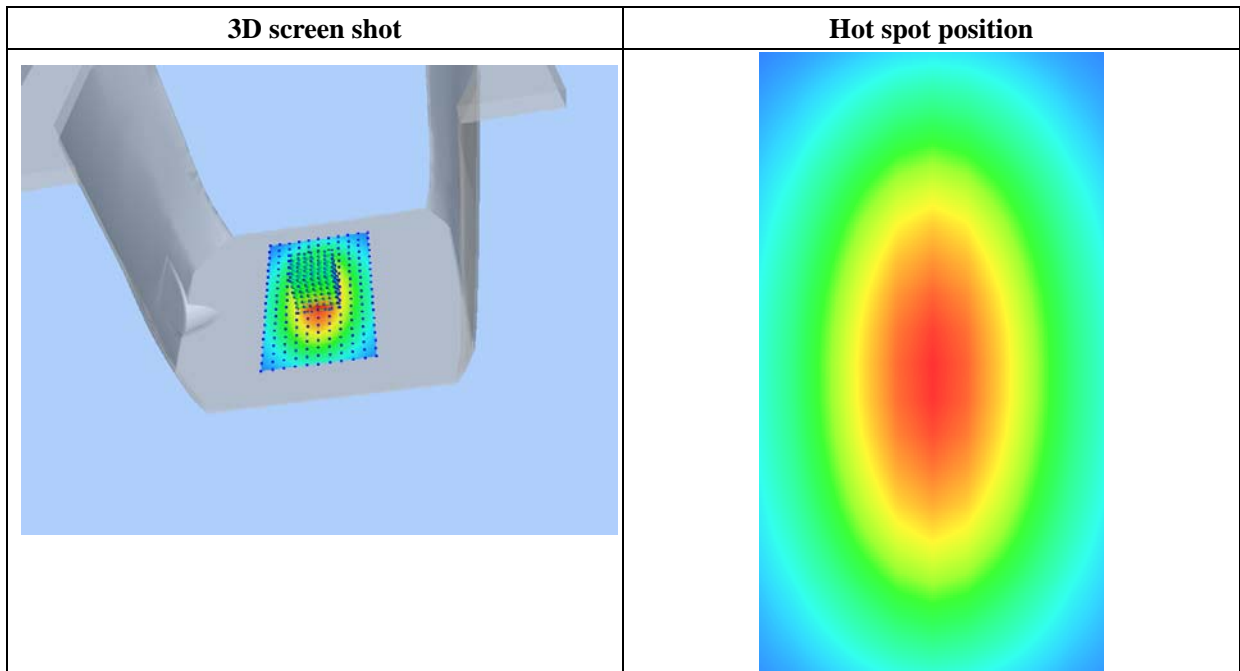
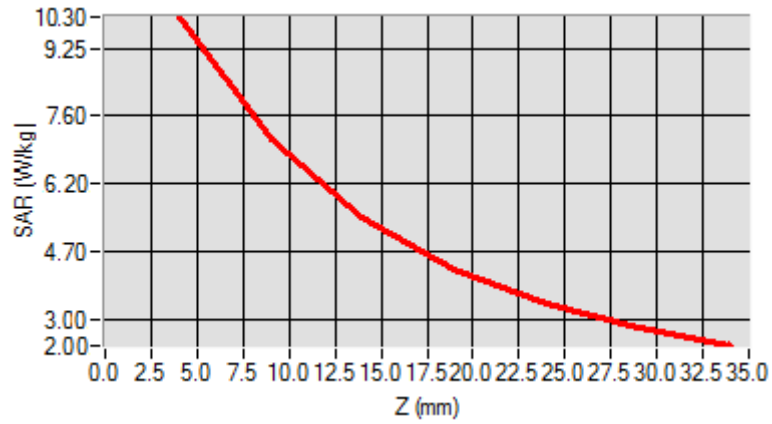

# MEASUREMENT 9

## For Body Liquid

Type: Validation measurement (Fast, 75.00 %)

Date of measurement: 10/31/2018

Measurement duration: 12 minutes 21 seconds

E-field Probe: SSE5 - SN 09/13 EP168; ConvF: 5.80; Calibrated: 06/01/2018

### A. Experimental conditions

Area Scan	dx=8mm dy=8mm
Phantom	Validation plane
Device Position	Dipole
Band	CW2450
Signal	Duty Cycle 1:1

### B. SAR Measurement Results

Frequency (MHz)	2450.000000
Relative Permittivity (real part)	52.010212
Conductivity (S/m)	1.910255
Power Variation (%)	1.369745
Ambient Temperature	21.1
Liquid Temperature	21.2

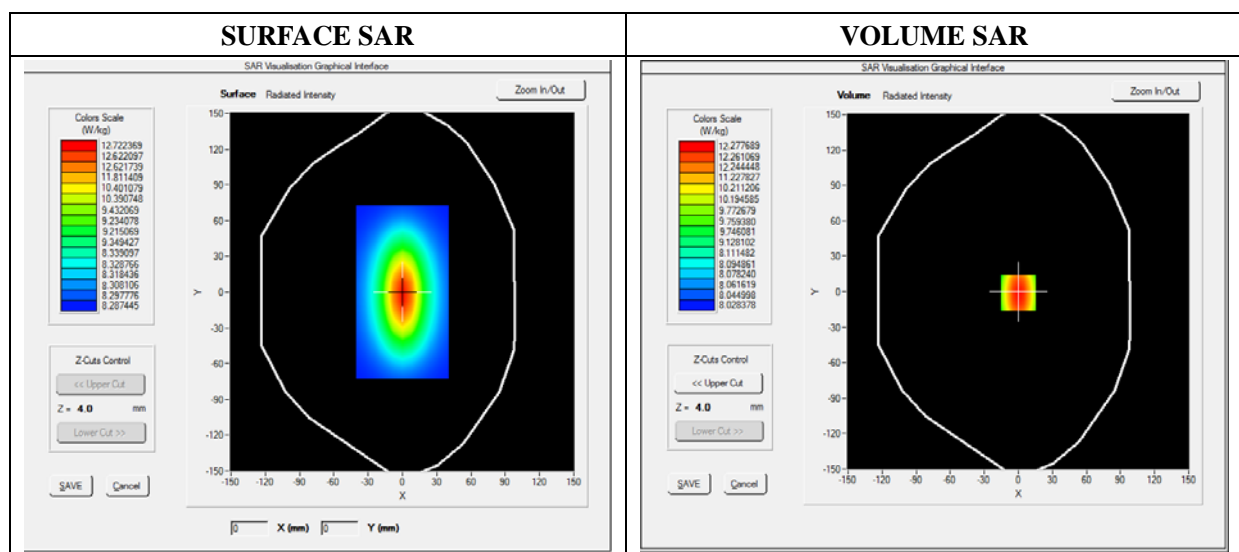

Maximum location: X=0.00, Y=0.00

SAR 10g (W/Kg)	7.119522
SAR 1g (W/Kg)	12.592360

Z Axis Scan

Z (mm)	0.00	4.00	9.00	14.00	19.00	24.00	29.00
SAR (W/Kg)	0.0000	13.1911	11.7951	9.2945	8.5400	6.3712	4.6225

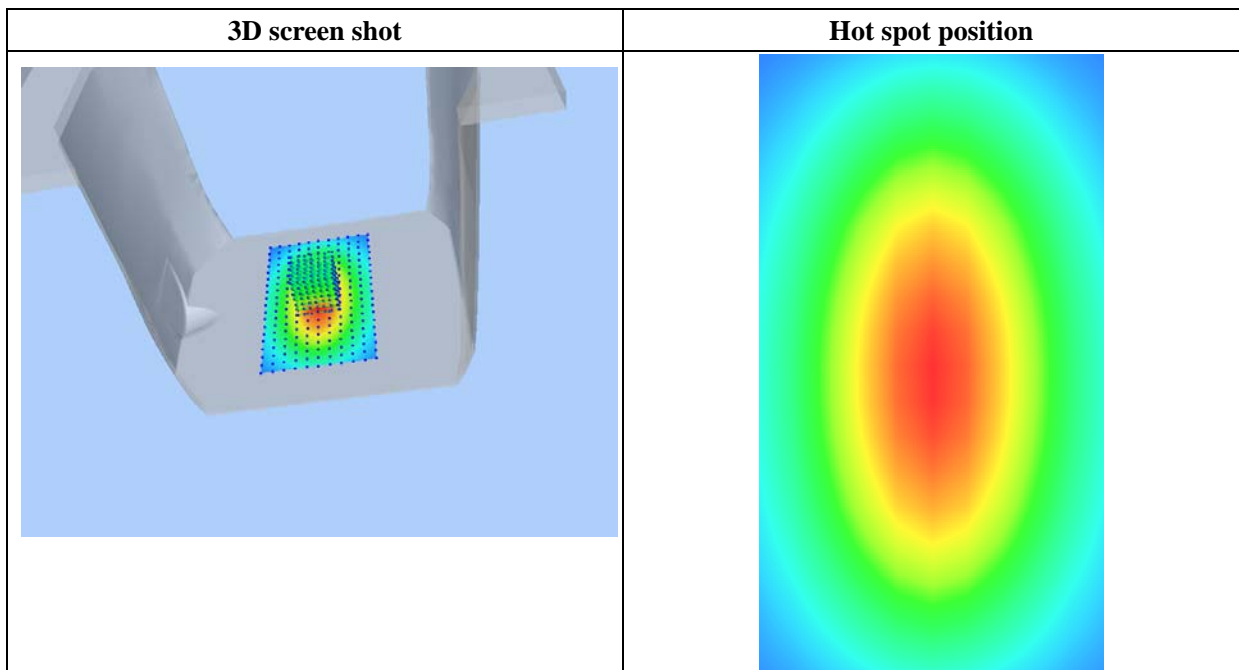
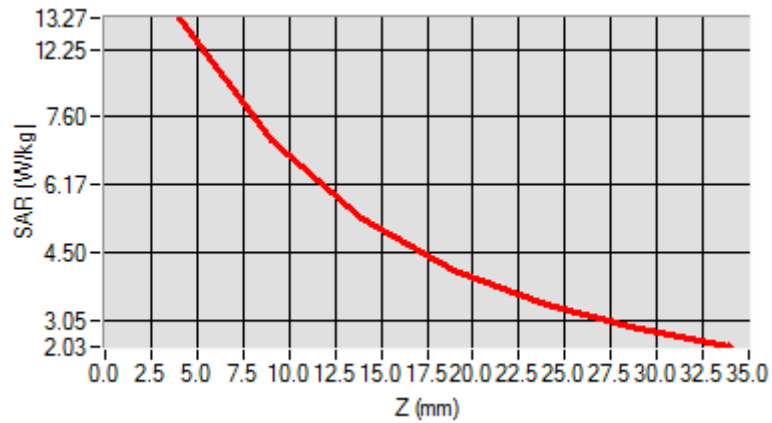

# MEASUREMENT 10

## For Body Liquid

Type: Validation measurement (Fast, 75.00 %)

Date of measurement: 10/31/2018

Measurement duration: 12 minutes 21 seconds

E-field Probe: SSE5 - SN 09/13 EP168; ConvF: 5.58; Calibrated: 06/01/2018

### A. Experimental conditions

<b>Area Scan</b>	dx=8mm dy=8mm
<b>Phantom</b>	Validation plane
<b>Device Position</b>	Dipole
<b>Band</b>	CW2600
<b>Signal</b>	Duty Cycle 1:1

### B. SAR Measurement Results

<b>Frequency (MHz)</b>	2600.000000
<b>Relative Permittivity (real part)</b>	52.241202
<b>Conductivity (S/m)</b>	2.120943
<b>Power Variation (%)</b>	1.038832
<b>Ambient Temperature</b>	21.1
<b>Liquid Temperature</b>	21.2

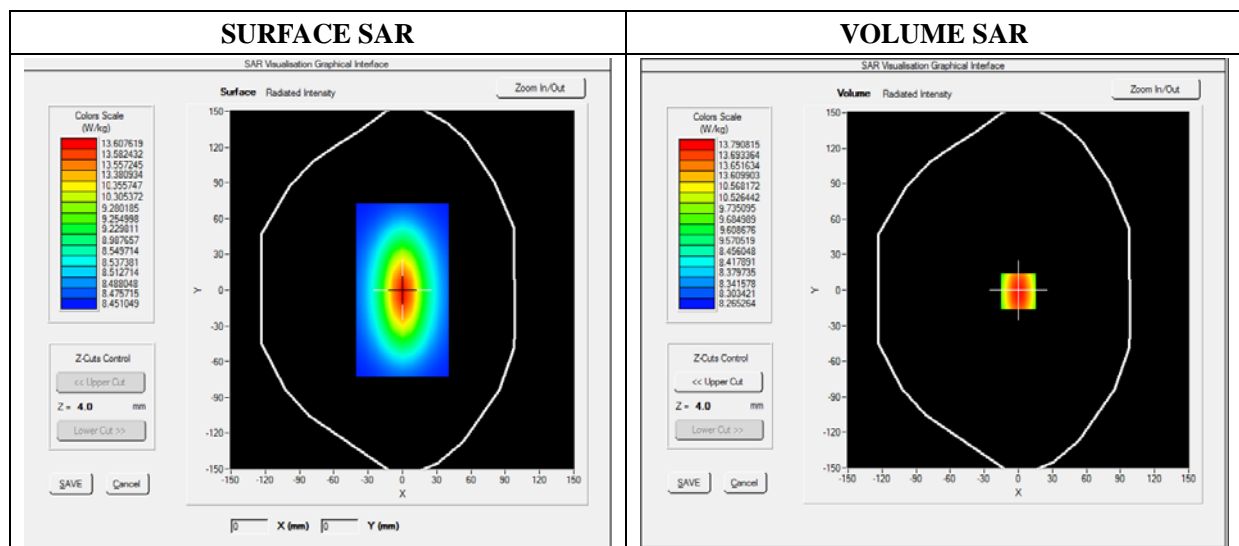

Maximum location: X=0.00, Y=0.00

SAR 10g (W/Kg)	6.083781
SAR 1g (W/Kg)	13.430481

Z Axis Scan

Z (mm)	0.00	4.00	9.00	14.00	19.00	24.00	29.00
SAR (W/Kg)	0.0000	13.6473	11.8441	9.3627	8.5782	6.4357	4.6342

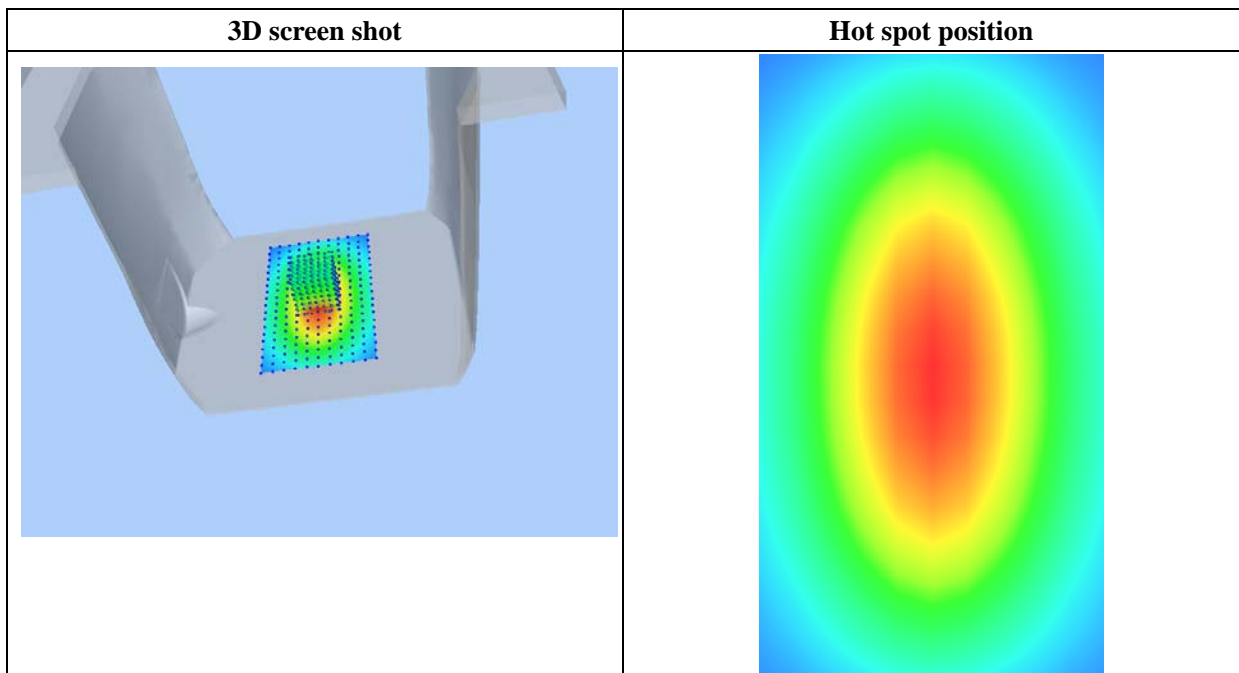
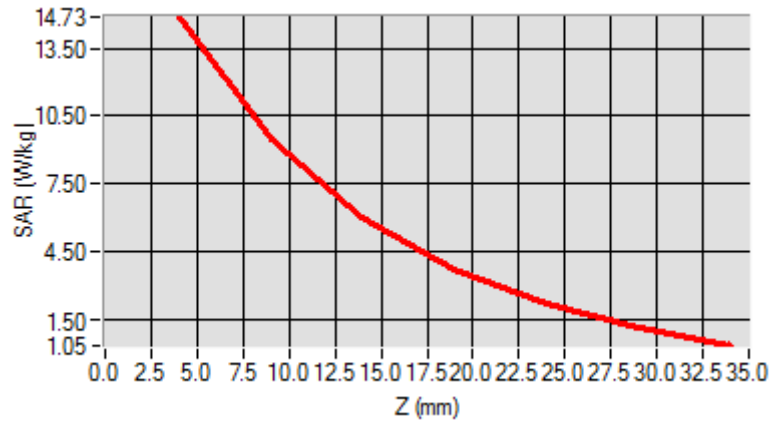

## Annex B. Plots of SAR Measurement

<b><u>TYPE</u></b>	<b><u>BAND</u></b>	<b><u>PARAMETERS</u></b>
Phone	GSM850	<u>Measurement 1:</u> Right Head with Cheek device position on Middle Channel in GSM mode
Phone	GSM1900	<u>Measurement 7:</u> Right Head with Cheek device position on Middle Channel in GSM mode
Phone	GPRS850_2TX	<u>Measurement 11:</u> Right Head with Cheek device position on High Channel in GPRS mode
Phone	GPRS1900_3TX	<u>Measurement 17:</u> Left Head with Cheek device position on Middle Channel in GPRS mode
Phone	WCDMA1900_RMC	<u>Measurement 21:</u> Left Head with Cheek device position on Low Channel in WCDMA mode
Phone	WCDMA850_RMC	<u>Measurement 23:</u> Right Head with Cheek device position on Middle Channel in WCDMA mode
Phone	LTE Band 2	<u>Measurement 29:</u> Left Head with Cheek device position on Low Channel in LTE mode
Phone	LTE Band 4	<u>Measurement 37:</u> Left Head with Cheek device position on Middle Channel in LTE mode
Phone	LTE Band 7	<u>Measurement 43:</u> Right Head with Cheek device position on Low Channel in LTE mode
Phone	WiFi_802.11b	<u>Measurement 51:</u> Right Head with Cheek device position on High Channel in 802.11b mode
Phone	GSM850	<u>Measurement 55:</u> Flat Plane with Back(Body-worn) device position on Middle Channel in GSM mode
Phone	GSM1900	<u>Measurement 61:</u> Flat Plane with Back(Body-worn) device position on Middle Channel in GSM mode
Phone	GPRS850_2TX	<u>Measurement 63:</u> Flat Plane with Back device position on High Channel in GPRS mode
Phone	GPRS1900_3TX	<u>Measurement 67:</u> Flat Plane with Back device position on Middle Channel in GPRS mode
Phone	WCDMA1900_RMC	<u>Measurement 71:</u> Flat Plane with Back side device position on Low Channel in WCDMA mode
Phone	WCDMA850_RMC	<u>Measurement 76:</u> Flat Plane with Front device position on Middle Channel in WCDMA mode
Phone	LTE Band 2	<u>Measurement 79:</u> Flat Plane with Back device position on Low Channel in LTE mode
Phone	LTE Band 4	<u>Measurement 87:</u> Flat Plane with Back device position on Middle Channel in LTE mode
Phone	LTE Band 7	<u>Measurement 95:</u> Flat Plane with Back device position on Low Channel in LTE mode
Phone	LTE Band 7	<u>Measurement 97:</u> Flat Plane with Bottom device position

		on Low Channel in LTE mode
<b>Phone</b>	<b>WiFi_802.11b</b>	<u>Measurement 103:</u> Flat Plane with Back side device position on High Channel in 802.11b mode
<i>Remark: SAR plot is showed the highest measured SAR in each exposure configuration, wireless mode and frequency band combination.</i>		



# MEASUREMENT 1

Type: Phone measurement (Complete)

Date of measurement: 10/29/2018

Measurement duration: 11 minutes 48 seconds

E-field Probe: SSE5 - SN 09/13 EP168; ConvF: 6.93; Calibrated: 06/01/2018

## A. Experimental conditions

Area Scan	sam_direct_droit2_surf8mm.txt
Phantom	Right head
Device Position	Cheek
Band	GSM850
Channels	Middle
Signal	TDMA (Crest factor: 8.0)

## B. SAR Measurement Results

Frequency (MHz)	836.600000
Relative Permittivity (real part)	41.110245
Conductivity (S/m)	0.871245
Power Variation (%)	1.144536
Ambient Temperature	21.1
Liquid Temperature	21.3

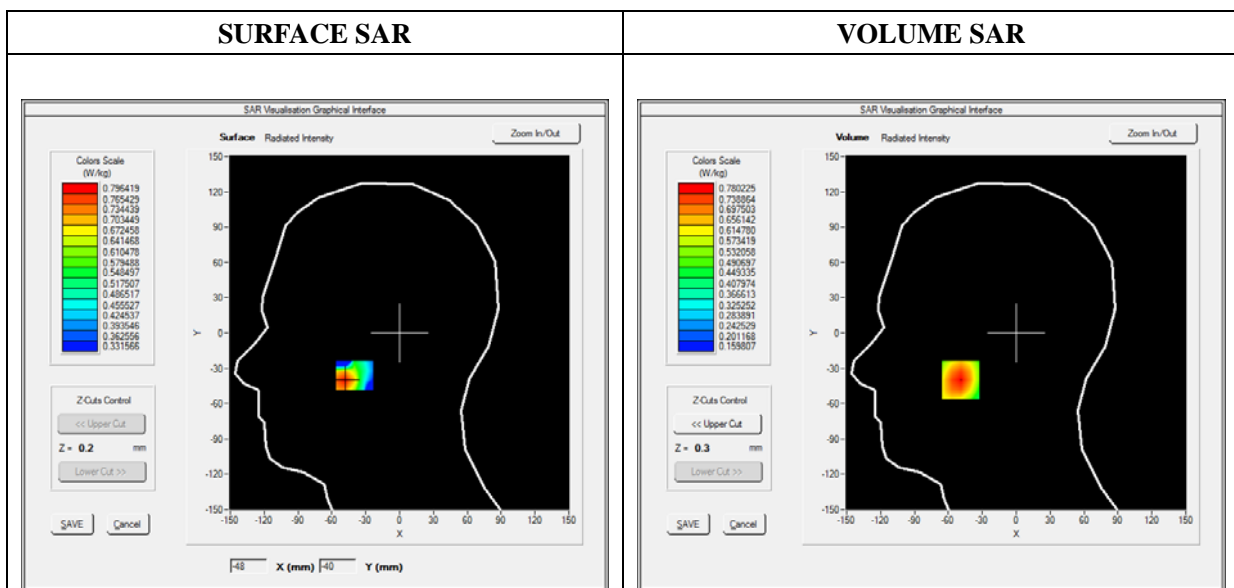

**Maximum location: X=-49.00, Y=-40.00**

**SAR Peak: 1.01 W/kg**

SAR 10g (W/Kg)	0.530566
SAR 1g (W/Kg)	0.747405

Z (mm)	0.00	4.00	9.00	14.00	19.00
SAR (W/Kg)	1.0121	0.7802	0.5711	0.4327	0.3427

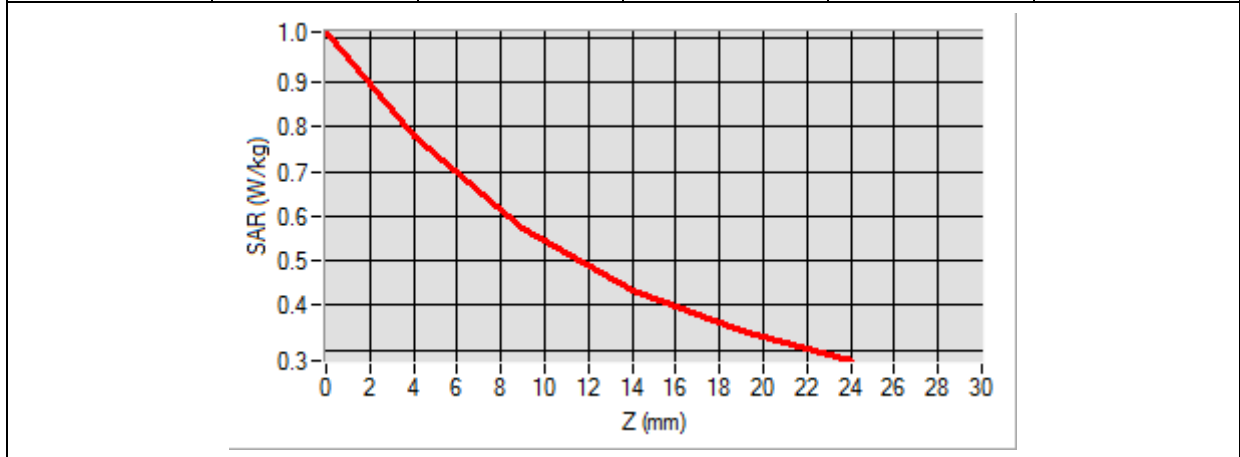

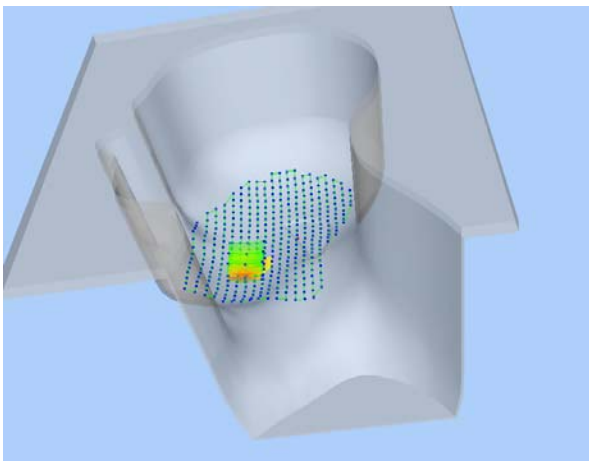
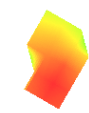
3D screen shot	Hot spot position
	

# MEASUREMENT 7

Type: Phone measurement (Complete)

Date of measurement: 10/30/2018

Measurement duration: 11 minutes 48 seconds

E-field Probe: SSE5 - SN 09/13 EP168; ConvF: 6.35; Calibrated: 06/01/2018

### A. Experimental conditions

<b>Area Scan</b>	sam_direct_droit2_surf8mm.txt
<b>Phantom</b>	Right head
<b>Device Position</b>	Cheek
<b>Band</b>	GSM1900
<b>Channels</b>	Middle
<b>Signal</b>	TDMA (Crest factor: 8.0)

### B. SAR Measurement Results

<b>Frequency (MHz)</b>	1880.000000
<b>Relative Permittivity (real part)</b>	38.560124
<b>Conductivity (S/m)</b>	1.380369
<b>Power Variation (%)</b>	1.442440
<b>Ambient Temperature</b>	21.1
<b>Liquid Temperature</b>	21.3

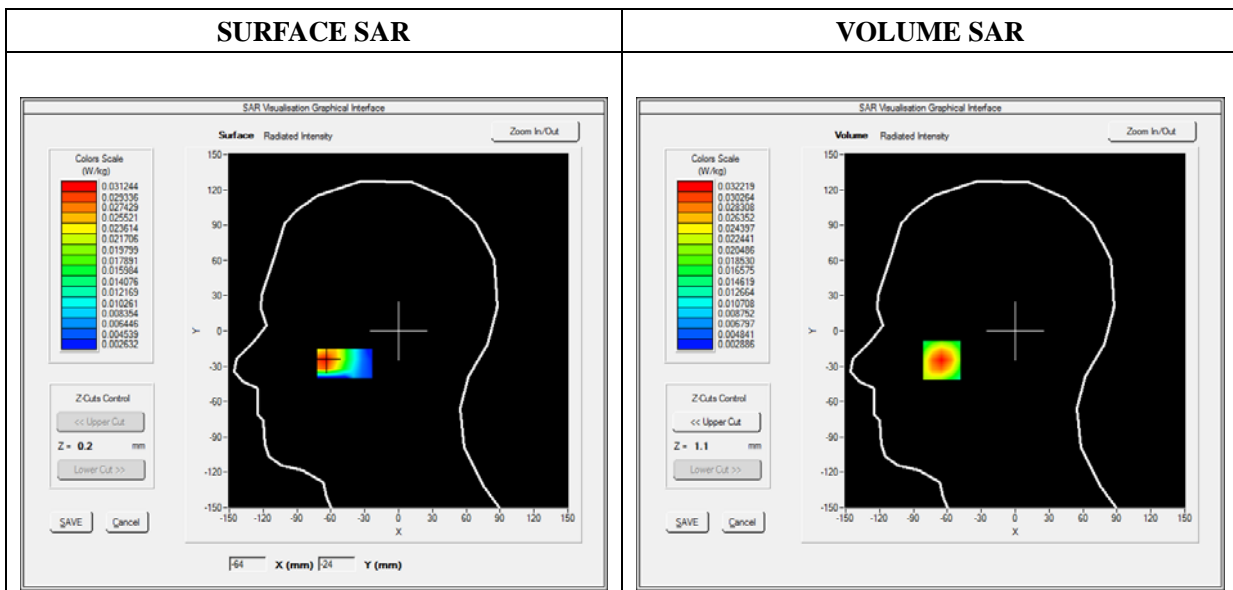

Maximum location: X=-65.00, Y=-25.00

SAR Peak: 0.05 W/kg

SAR 10g (W/Kg)	0.017292
SAR 1g (W/Kg)	0.030420

Z (mm)	0.00	4.00	9.00	14.00	19.00
SAR (W/Kg)	0.0516	0.0322	0.0177	0.0103	0.0068

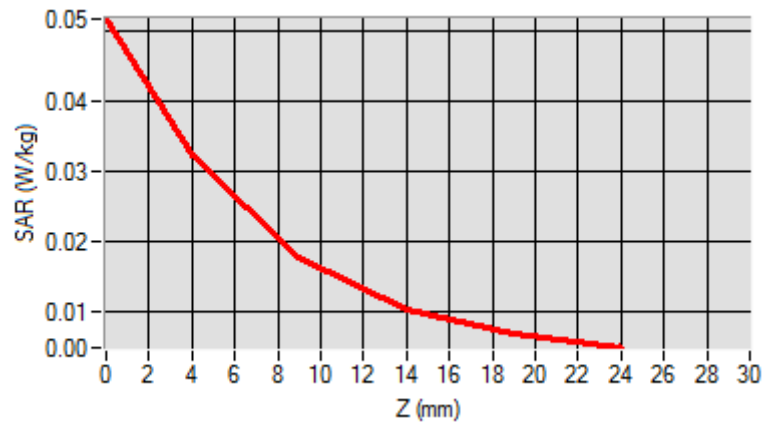

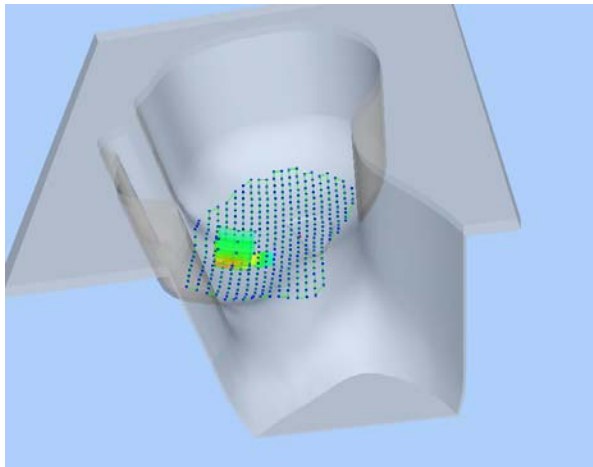
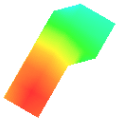
3D screen shot	Hot spot position
	

# MEASUREMENT 11

Type: Phone measurement (Complete)

Date of measurement: 10/29/2018

Measurement duration: 12 minutes 3 seconds

E-field Probe: SSE5 - SN 09/13 EP168; ConvF: 6.93; Calibrated: 06/01/2018

## A. Experimental conditions

<b>Area Scan</b>	sam_direct_droit2_surf8mm.txt
<b>Phantom</b>	Right head
<b>Device Position</b>	Cheek
<b>Band</b>	GPRS850_2TX
<b>Channels</b>	High
<b>Signal</b>	Duty Cycle: 1:4

## B. SAR Measurement Results

<b>Frequency (MHz)</b>	848.800000
<b>Relative Permittivity (real part)</b>	41.110245
<b>Conductivity (S/m)</b>	0.871245
<b>Power Variation (%)</b>	1.536272
<b>Ambient Temperature</b>	21.1
<b>Liquid Temperature</b>	21.3

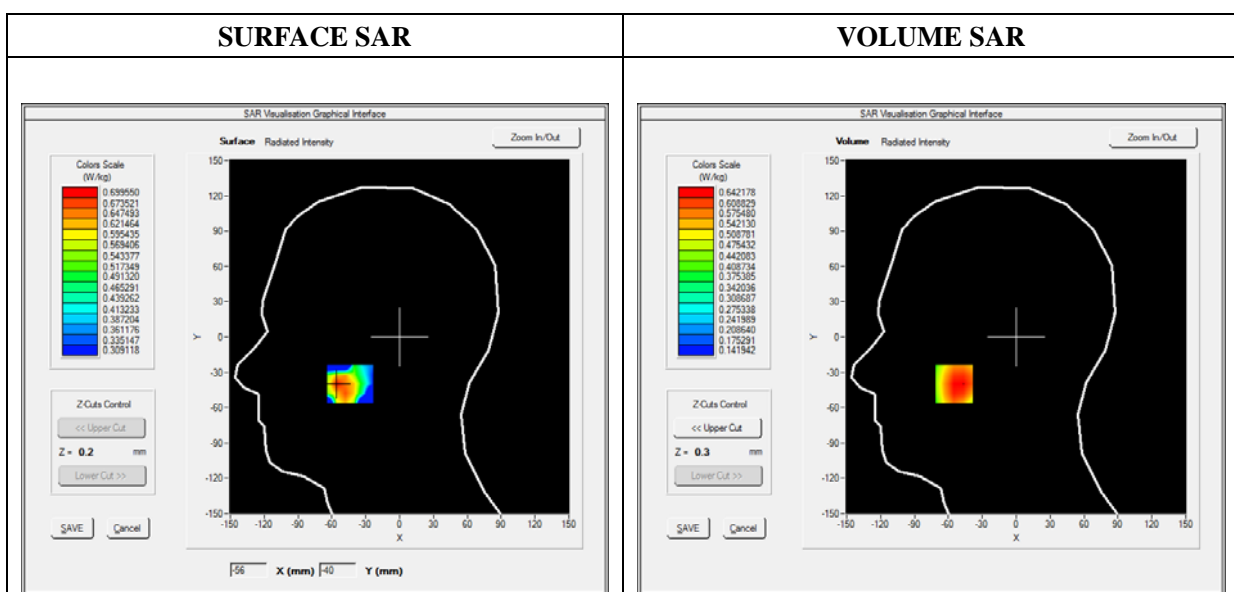

**Maximum location: X=-55.00, Y=-40.00**

**SAR Peak: 0.78 W/kg**

<b>SAR 10g (W/Kg)</b>	<b>0.464171</b>
<b>SAR 1g (W/Kg)</b>	<b>0.627851</b>

<b>Z (mm)</b>	<b>0.00</b>	<b>4.00</b>	<b>9.00</b>	<b>14.00</b>	<b>19.00</b>
<b>SAR (W/Kg)</b>	<b>1.0711</b>	<b>0.6422</b>	<b>0.4607</b>	<b>0.3842</b>	<b>0.2827</b>

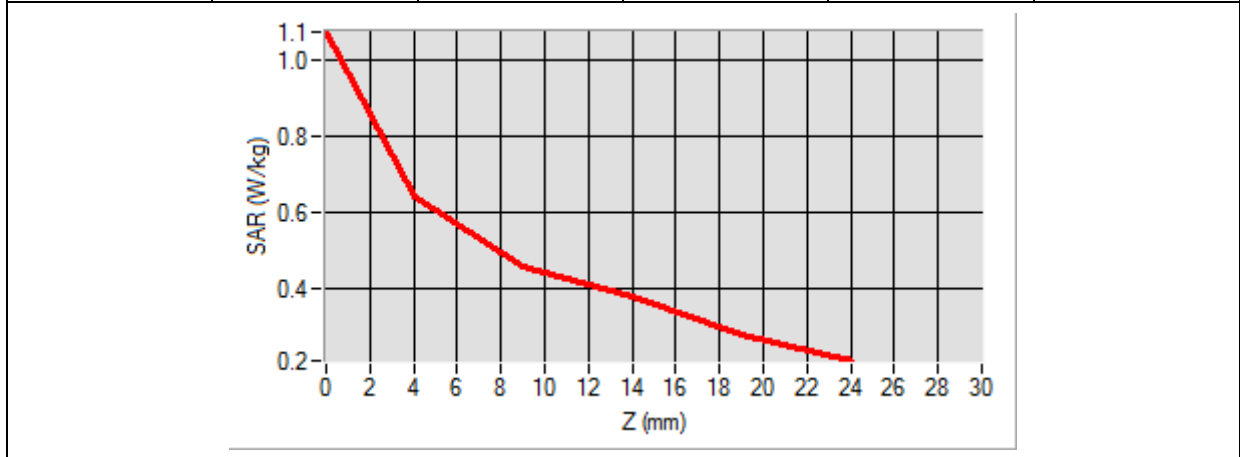

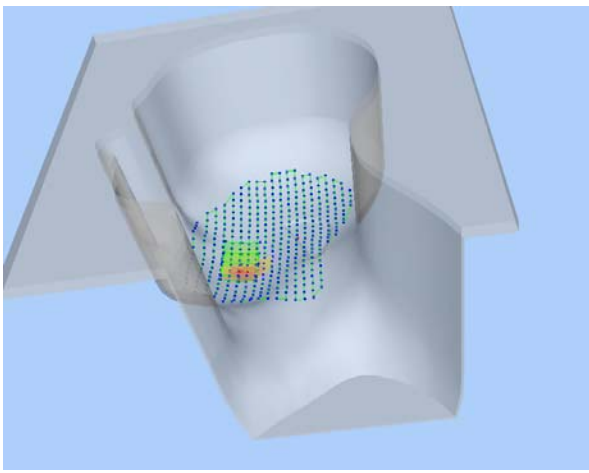
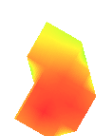
3D screen shot	Hot spot position
	

# MEASUREMENT 17

Type: Phone measurement (Complete)

Date of measurement: 10/30/2018

Measurement duration: 12 minutes 3 seconds

E-field Probe: SSE5 - SN 09/13 EP168; ConvF: 6.35; Calibrated: 06/01/2018

### A. Experimental conditions

<b>Area Scan</b>	sam_direct_droit2_surf8mm.txt
<b>Phantom</b>	Left head
<b>Device Position</b>	Cheek
<b>Band</b>	GPRS1900_3TX
<b>Channels</b>	Middle
<b>Signal</b>	Duty Cycle: 1:2.66

### B. SAR Measurement Results

<b>Frequency (MHz)</b>	1880.000000
<b>Relative Permittivity (real part)</b>	38.560124
<b>Conductivity (S/m)</b>	1.380369
<b>Power Variation (%)</b>	1.536272
<b>Ambient Temperature</b>	21.1
<b>Liquid Temperature</b>	21.3

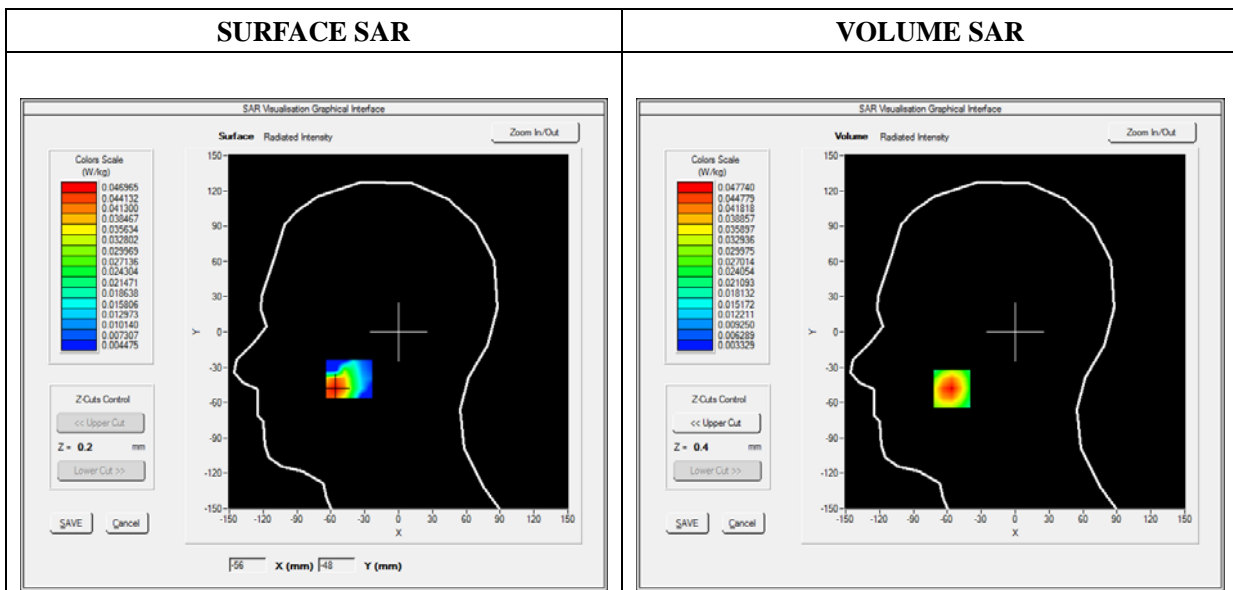



Maximum location: X=-56.00, Y=-48.00

SAR Peak: 0.07 W/kg

SAR 10g (W/Kg)	0.025960
SAR 1g (W/Kg)	0.045018

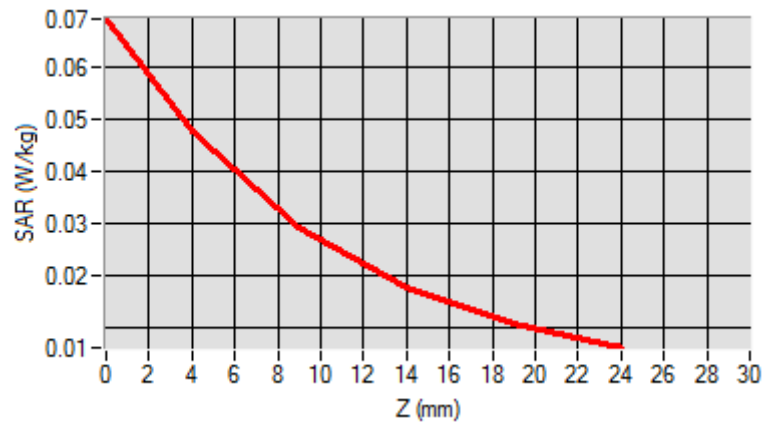
Z (mm)	0.00	4.00	9.00	14.00	19.00
SAR (W/Kg)	0.0694	0.0477	0.0293	0.0178	0.0108

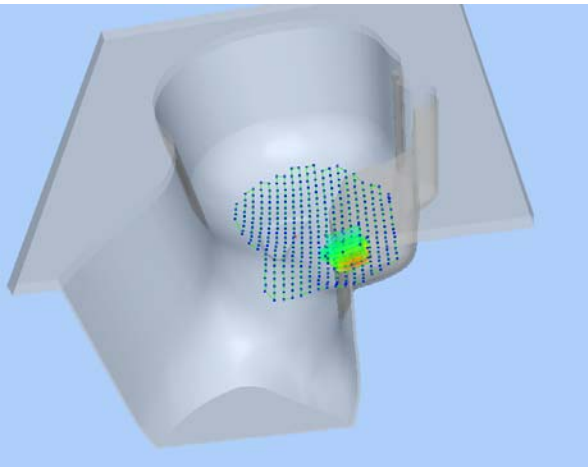

3D screen shot	Hot spot position
	



# MEASUREMENT 21

Type: Phone measurement (Complete)

Date of measurement: 10/30/2018

Measurement duration: 12 minutes 3 seconds

E-field Probe: SSE5 - SN 09/13 EP168; ConvF: 6.35; Calibrated: 06/01/2018

### A. Experimental conditions

<b>Area Scan</b>	sam_direct_droit2_surf8mm.txt
<b>Phantom</b>	Left head
<b>Device Position</b>	Cheek
<b>Band</b>	WCDMA1900_RMC
<b>Channels</b>	Low
<b>Signal</b>	Duty Cycle 1:1

### B. SAR Measurement Results

<b>Frequency (MHz)</b>	1852.400000
<b>Relative Permittivity (real part)</b>	38.560124
<b>Conductivity (S/m)</b>	1.380369
<b>Power Variation (%)</b>	1.524540
<b>Ambient Temperature</b>	21.1
<b>Liquid Temperature</b>	21.3

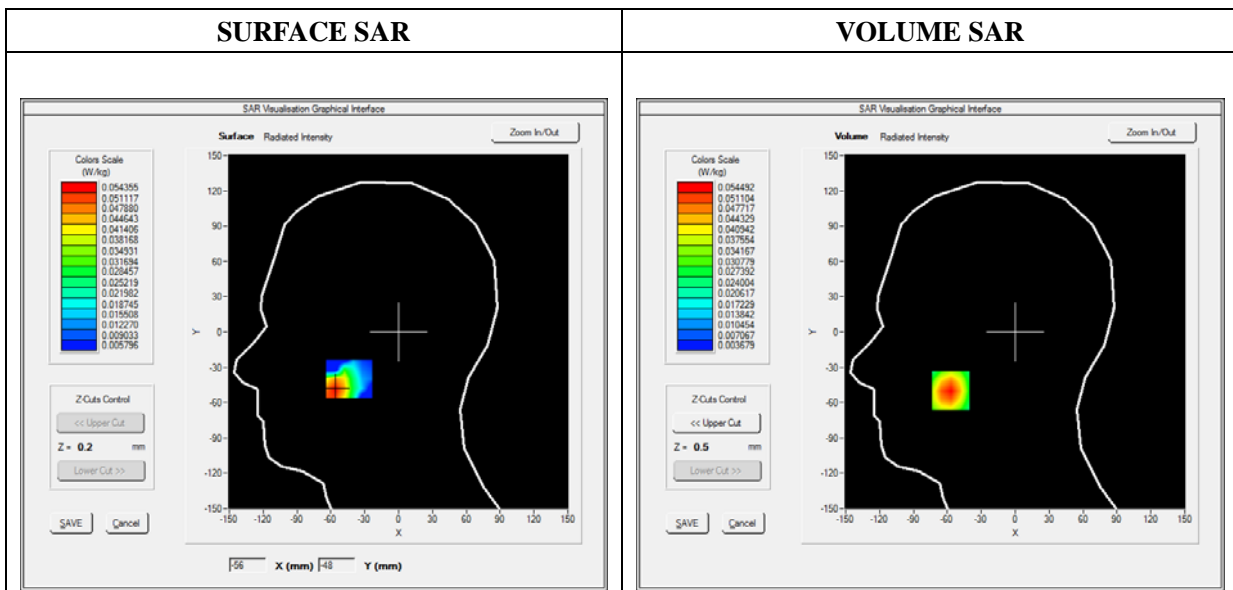



Maximum location: X=-57.00, Y=-50.00

SAR Peak: 0.08 W/kg

SAR 10g (W/Kg)	0.029558
SAR 1g (W/Kg)	0.051411

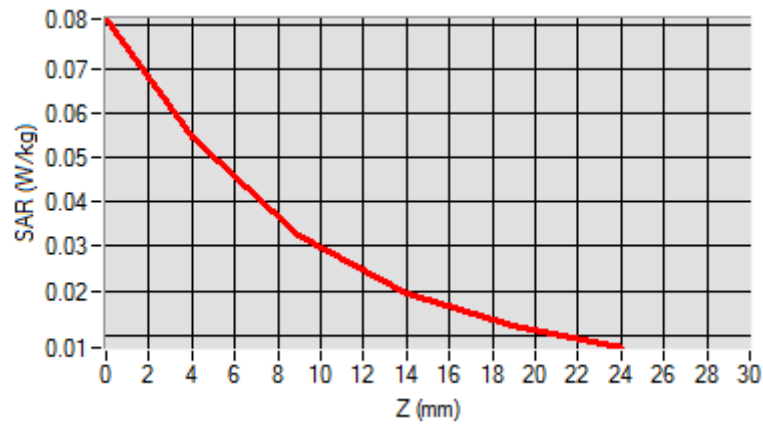
Z (mm)	0.00	4.00	9.00	14.00	19.00
SAR (W/Kg)	0.0814	0.0545	0.0324	0.0194	0.0119

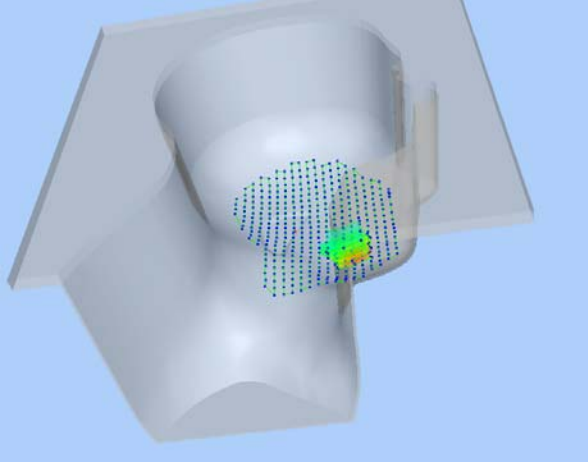

3D screen shot	Hot spot position
	

## MEASUREMENT 23

Type: Phone measurement (Complete)

Date of measurement: 10/29/2018

Measurement duration: 12 minutes 3 seconds

E-field Probe: SSE5 - SN 09/13 EP168; ConvF: 6.93; Calibrated: 06/01/2018

### A. Experimental conditions

<b>Area Scan</b>	sam_direct_droit2_surf8mm.txt
<b>Phantom</b>	Right head
<b>Device Position</b>	Cheek
<b>Band</b>	WCDMA850_RMC
<b>Channels</b>	Middle
<b>Signal</b>	Duty Cycle 1:1

### B. SAR Measurement Results

<b>Frequency (MHz)</b>	836.600000
<b>Relative Permittivity (real part)</b>	41.110245
<b>Conductivity (S/m)</b>	0.871245
<b>Power Variation (%)</b>	1.342427
<b>Ambient Temperature</b>	21.1
<b>Liquid Temperature</b>	21.3

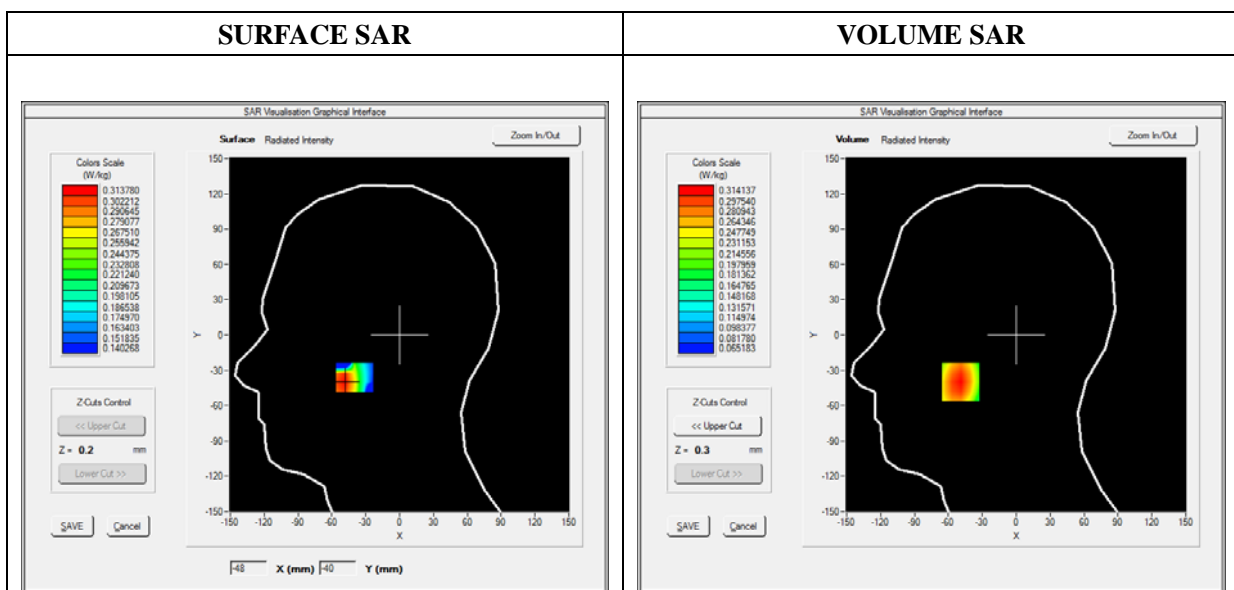

**Maximum location: X=-49.00, Y=-40.00**

**SAR Peak: 0.40 W/kg**

<b>SAR 10g (W/Kg)</b>	<b>0.214000</b>
<b>SAR 1g (W/Kg)</b>	<b>0.301905</b>

<b>Z (mm)</b>	<b>0.00</b>	<b>4.00</b>	<b>9.00</b>	<b>14.00</b>	<b>19.00</b>
<b>SAR (W/Kg)</b>	<b>0.4023</b>	<b>0.3141</b>	<b>0.2321</b>	<b>0.1751</b>	<b>0.1357</b>

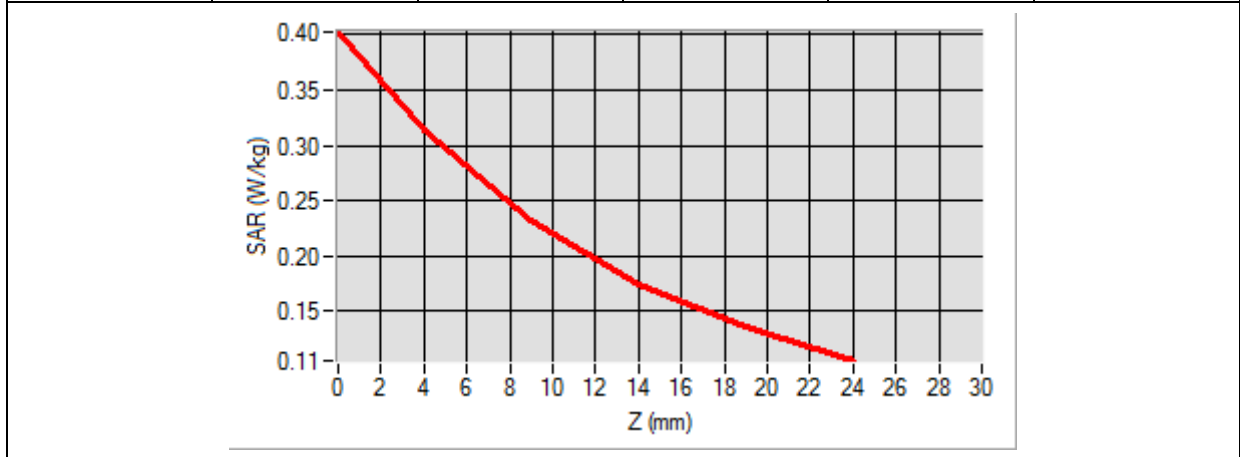

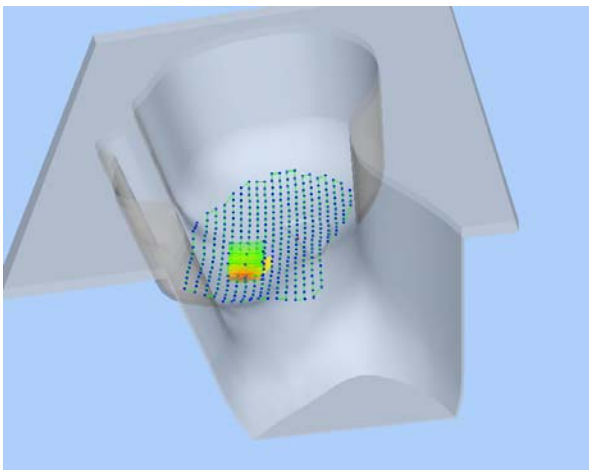
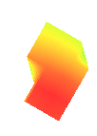
<b>3D screen shot</b>	<b>Hot spot position</b>
	

# MEASUREMENT 29

Type: Phone measurement (Complete)

Date of measurement: 10/30/2018

Measurement duration: 12 minutes 3 seconds

E-field Probe: SSE5 - SN 09/13 EP168; ConvF: 6.35; Calibrated: 06/01/2018

## A. Experimental conditions

<b>Area Scan</b>	sam_direct_droit2_surf8mm.txt
<b>Phantom</b>	Left head
<b>Device Position</b>	Cheek
<b>Band</b>	LTE Band 2
<b>Channels</b>	QPSK, 20MHz, 1RB, Low
<b>Signal</b>	Duty Cycle 1:1

## B. SAR Measurement Results

<b>Frequency (MHz)</b>	1860.000000
<b>Relative Permittivity (real part)</b>	38.560124
<b>Conductivity (S/m)</b>	1.380369
<b>Power Variation (%)</b>	1.743564
<b>Ambient Temperature</b>	21.1
<b>Liquid Temperature</b>	21.3

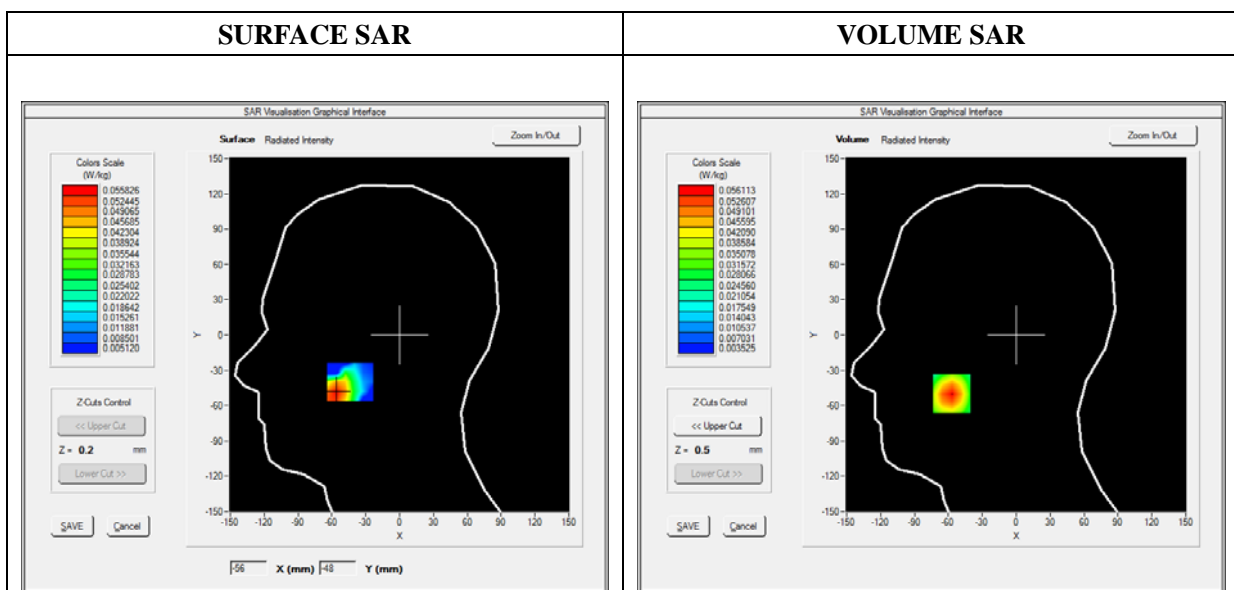



Maximum location: X=-57.00, Y=-50.00

SAR Peak: 0.09 W/kg

SAR 10g (W/Kg)	0.029985
SAR 1g (W/Kg)	0.052848

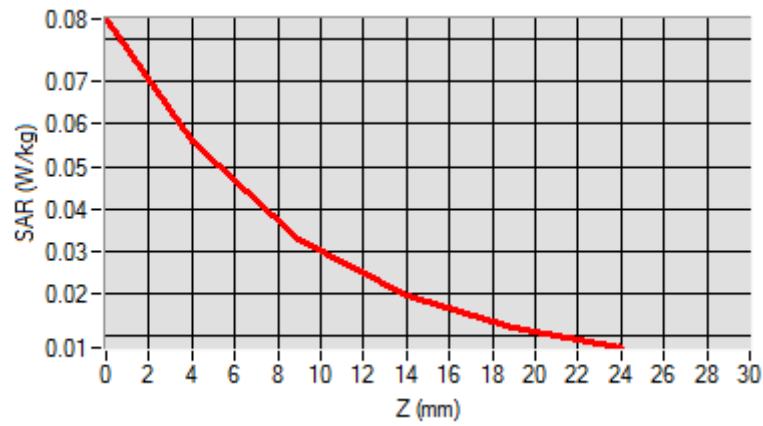
Z (mm)	0.00	4.00	9.00	14.00	19.00
SAR (W/Kg)	0.0849	0.0561	0.0328	0.0193	0.0118

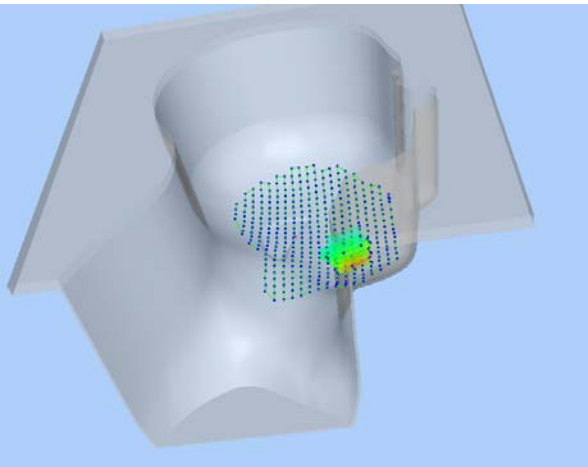

3D screen shot	Hot spot position
	

# MEASUREMENT 37

Type: Phone measurement (Complete)

Date of measurement: 10/30/2018

Measurement duration: 12 minutes 3 seconds

E-field Probe: SSE5 - SN 09/13 EP168; ConvF: 5.84; Calibrated: 06/01/2018

### A. Experimental conditions

<b>Area Scan</b>	sam_direct_droit2_surf8mm.txt
<b>Phantom</b>	Left head
<b>Device Position</b>	Cheek
<b>Band</b>	LTE Band 4
<b>Channels</b>	QPSK, 20MHz, 1RB, Middle
<b>Signal</b>	Duty Cycle 1:1

### B. SAR Measurement Results

<b>Frequency (MHz)</b>	1732.500000
<b>Relative Permittivity (real part)</b>	39.024890
<b>Conductivity (S/m)</b>	1.371250
<b>Power Variation (%)</b>	1.374628
<b>Ambient Temperature</b>	21.1
<b>Liquid Temperature</b>	21.2

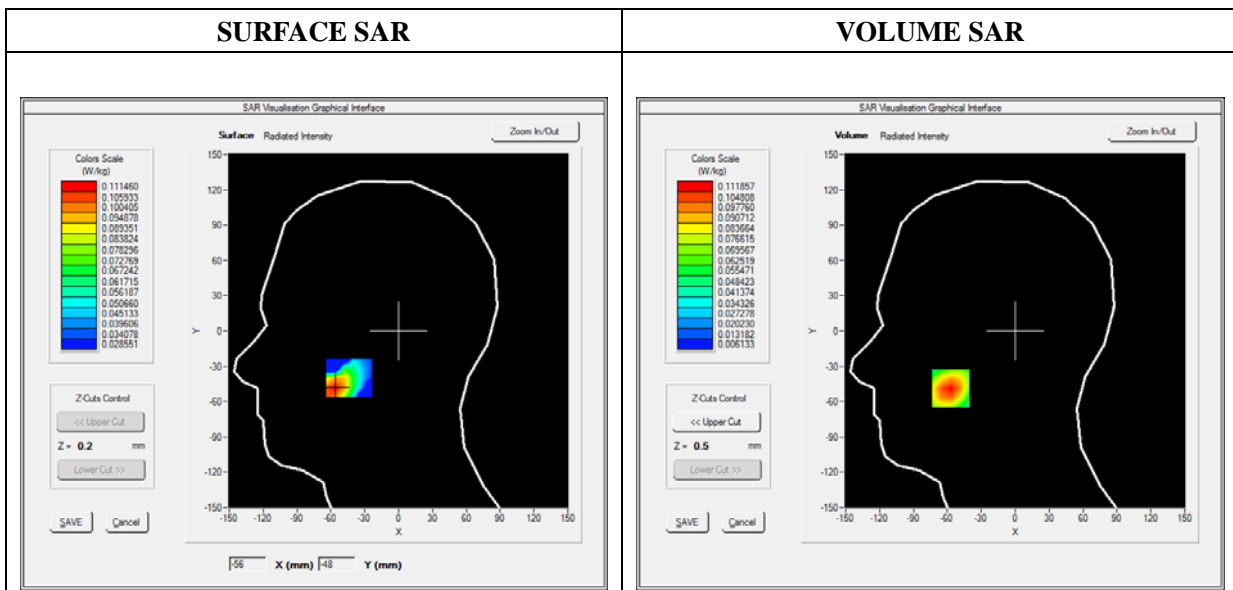

Maximum location: X=-57.00, Y=-49.00

SAR Peak: 0.17 W/kg

SAR 10g (W/Kg)	0.060633
SAR 1g (W/Kg)	0.105447

Z (mm)	0.00	4.00	9.00	14.00	19.00
SAR (W/Kg)	0.1675	0.1119	0.0663	0.0396	0.0244

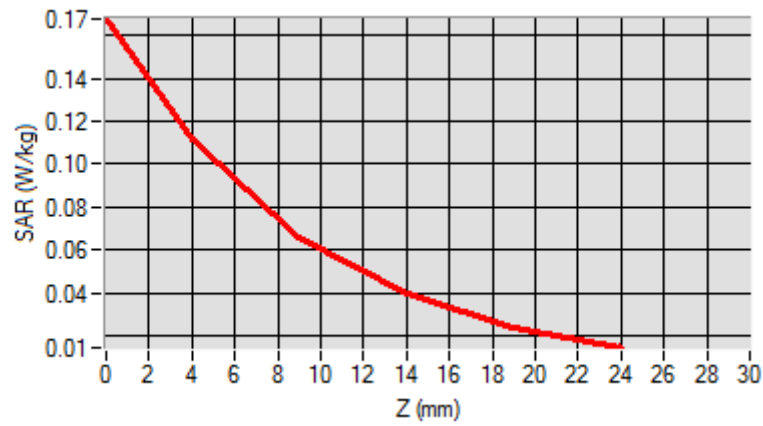

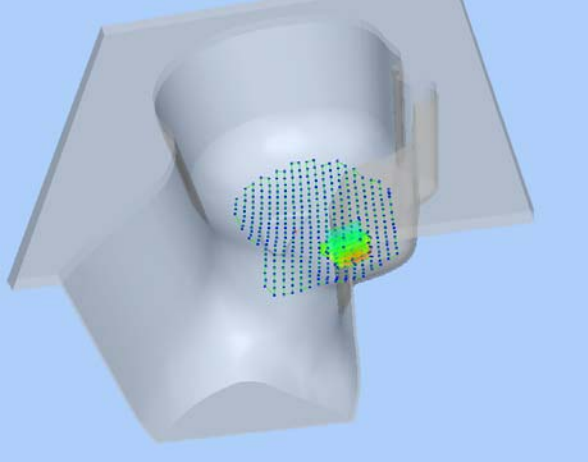
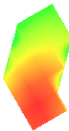
3D screen shot	Hot spot position
	



# MEASUREMENT 43

Type: Phone measurement (Complete)

Date of measurement: 10/31/2018

Measurement duration: 12 minutes 3 seconds

E-field Probe: SSE5 - SN 09/13 EP168; ConvF: 5.37; Calibrated: 06/01/2018

### A. Experimental conditions

<b>Area Scan</b>	sam_direct_droit2_surf8mm.txt
<b>Phantom</b>	Right head
<b>Device Position</b>	Cheek
<b>Band</b>	LTE Band 7
<b>Channels</b>	QPSK, 20MHz, 1RB, Low
<b>Signal</b>	Duty Cycle 1:1

### B. SAR Measurement Results

<b>Frequency (MHz)</b>	2510.000000
<b>Relative Permittivity (real part)</b>	38.631092
<b>Conductivity (S/m)</b>	1.930182
<b>Power Variation (%)</b>	0.924535
<b>Ambient Temperature</b>	21.1
<b>Liquid Temperature</b>	21.2

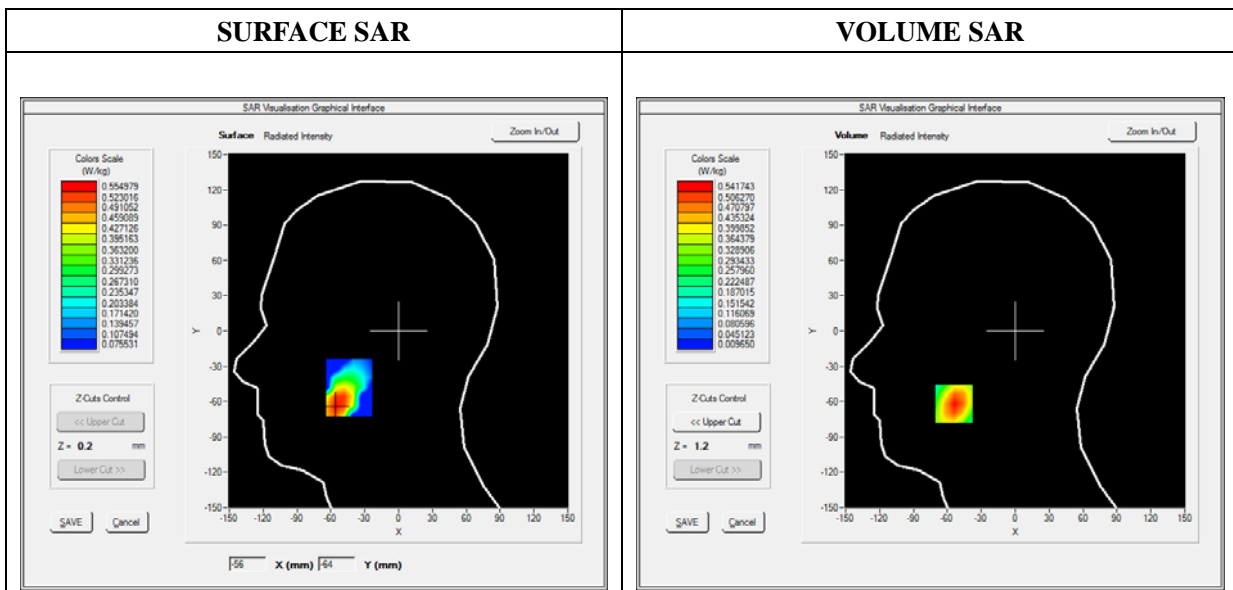

**Maximum location: X=-54.00, Y=-62.00**

**SAR Peak: 0.96 W/kg**

<b>SAR 10g (W/Kg)</b>	<b>0.259118</b>
<b>SAR 1g (W/Kg)</b>	<b>0.512995</b>

<b>Z (mm)</b>	<b>0.00</b>	<b>4.00</b>	<b>9.00</b>	<b>14.00</b>	<b>19.00</b>
<b>SAR (W/Kg)</b>	<b>0.9569</b>	<b>0.5417</b>	<b>0.2491</b>	<b>0.1122</b>	<b>0.0544</b>

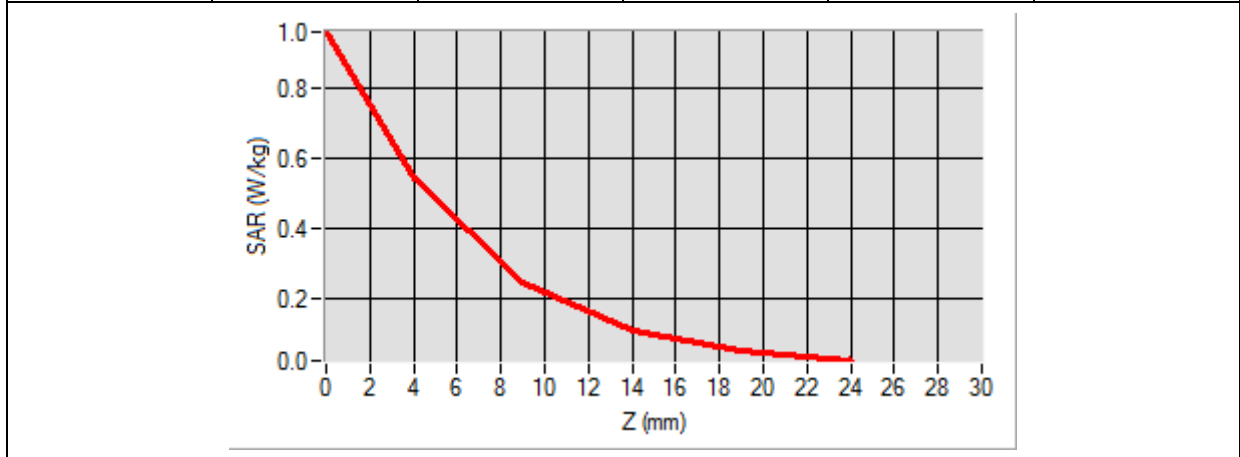

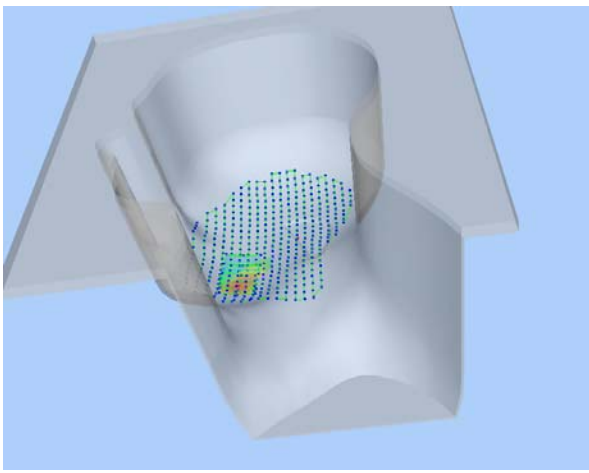
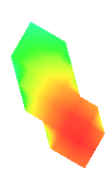
3D screen shot	Hot spot position
	

# MEASUREMENT 51

Type: Phone measurement (Complete)

Date of measurement: 10/31/2018

Measurement duration: 12 minutes 3 seconds

E-field Probe: SSE5 - SN 09/13 EP168; ConvF: 5.64; Calibrated: 06/01/2018

## A. Experimental conditions

<b>Area Scan</b>	sam_direct_droit2_surf8mm.txt
<b>Phantom</b>	Right head
<b>Device Position</b>	Cheek
<b>Band</b>	WiFi_802.11b
<b>Channels</b>	High
<b>Signal</b>	Duty Cycle 1:1

## B. SAR Measurement Results

<b>Frequency (MHz)</b>	2462.000000
<b>Relative Permittivity (real part)</b>	38.153660
<b>Conductivity (S/m)</b>	1.740236
<b>Power Variation (%)</b>	3.234772
<b>Ambient Temperature</b>	21.1
<b>Liquid Temperature</b>	21.2

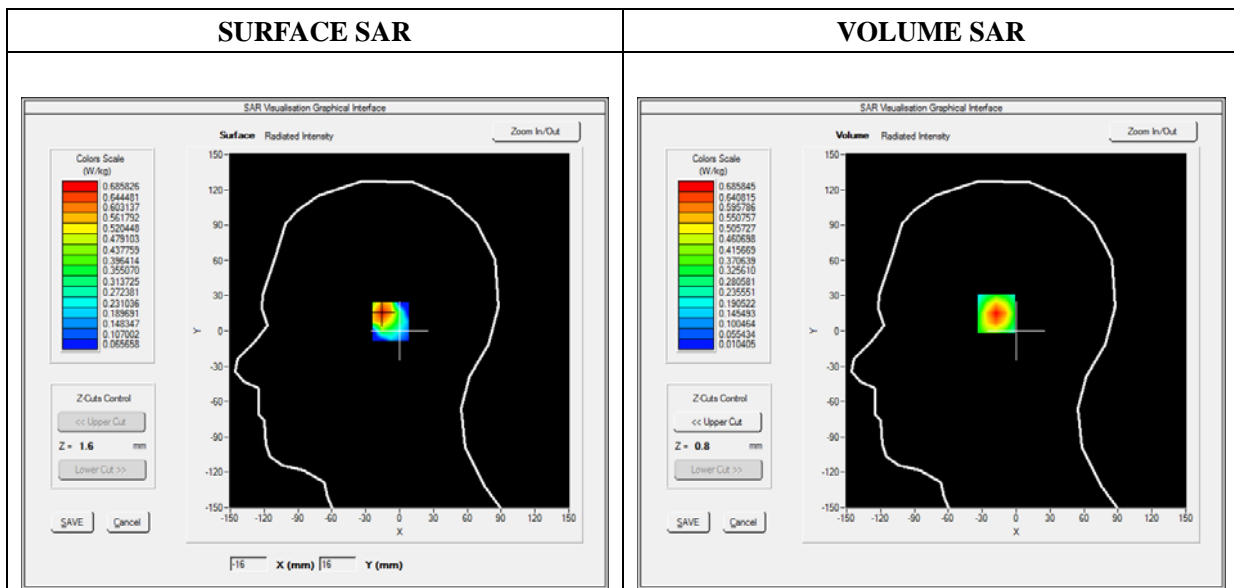

Maximum location: X=-16.00, Y=16.00

SAR Peak: 1.23 W/kg

SAR 10g (W/Kg)	0.305550
SAR 1g (W/Kg)	0.541394

Z (mm)	0.00	4.00	9.00	14.00	19.00
SAR (W/Kg)	1.2338	0.6858	0.3048	0.1303	0.0590

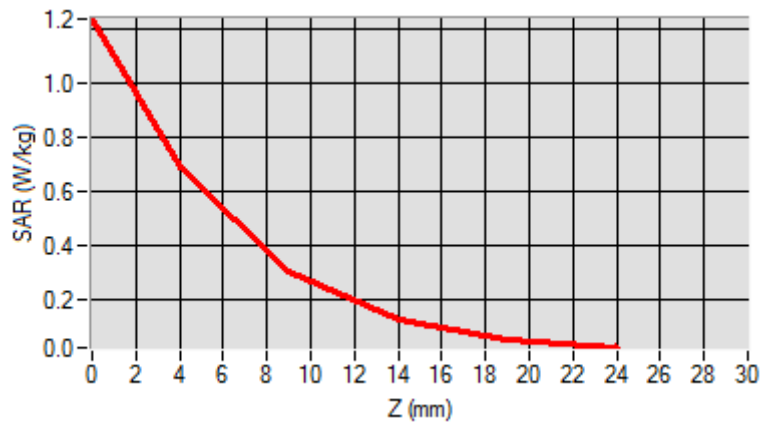

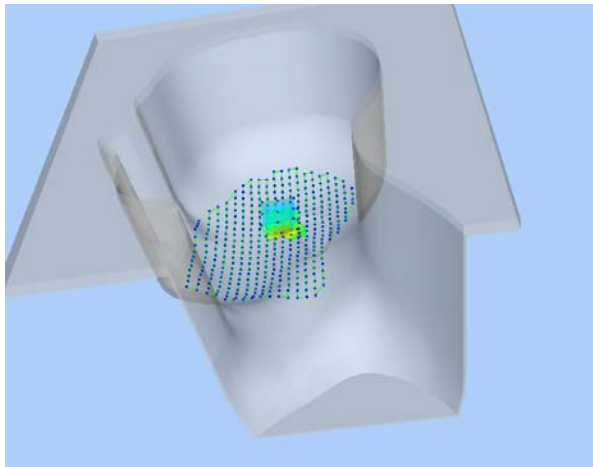
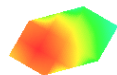
3D screen shot	Hot spot position
	

## MEASUREMENT 55

Type: Phone measurement (Complete)

Date of measurement: 10/29/2018

Measurement duration: 12 minutes 3 seconds

E-field Probe: SSE5 - SN 09/13 EP168; ConvF: 7.13; Calibrated: 06/01/2018

### A. Experimental conditions

<b>Area Scan</b>	sam_direct_droit2_surf8mm.txt
<b>Phantom</b>	Flat Plane
<b>Device Position</b>	Back(Body-worn)
<b>Band</b>	GSM850
<b>Channels</b>	Middle
<b>Signal</b>	TDMA (Crest factor: 8.0)

### B. SAR Measurement Results

<b>Frequency (MHz)</b>	836.600000
<b>Relative Permittivity (real part)</b>	54.851214
<b>Conductivity (S/m)</b>	0.951454
<b>Power Variation (%)</b>	0.901472
<b>Ambient Temperature</b>	21.1
<b>Liquid Temperature</b>	21.3

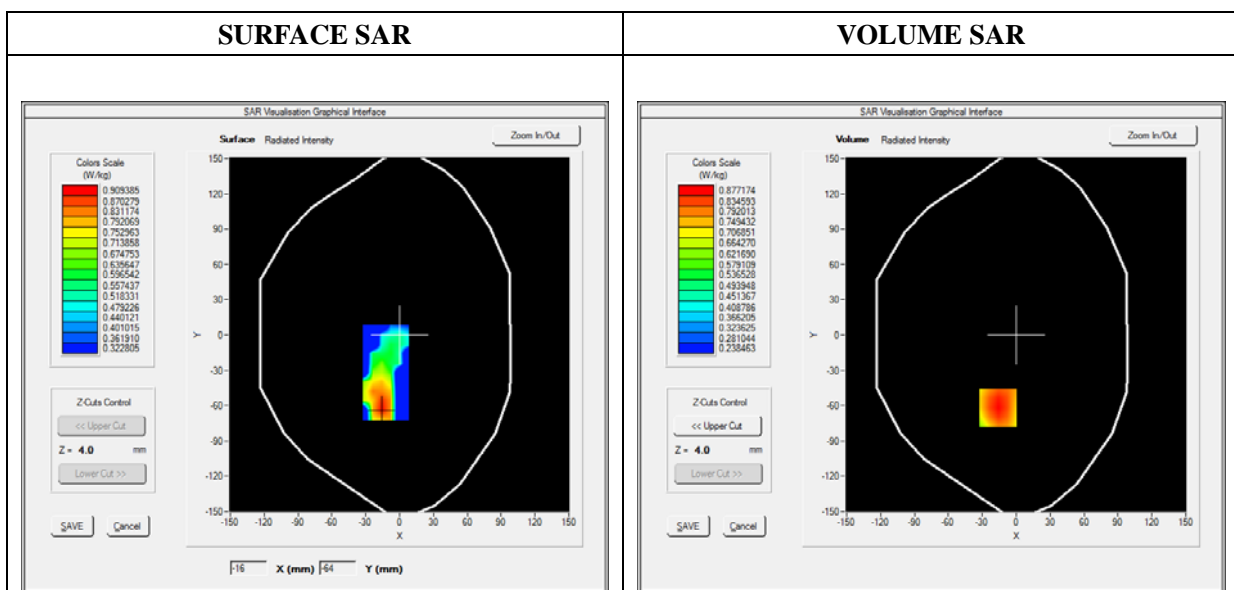



**Maximum location: X=-16.00, Y=-62.00**

**SAR Peak: 1.06 W/kg**

<b>SAR 10g (W/Kg)</b>	<b>0.632192</b>
<b>SAR 1g (W/Kg)</b>	<b>0.847461</b>

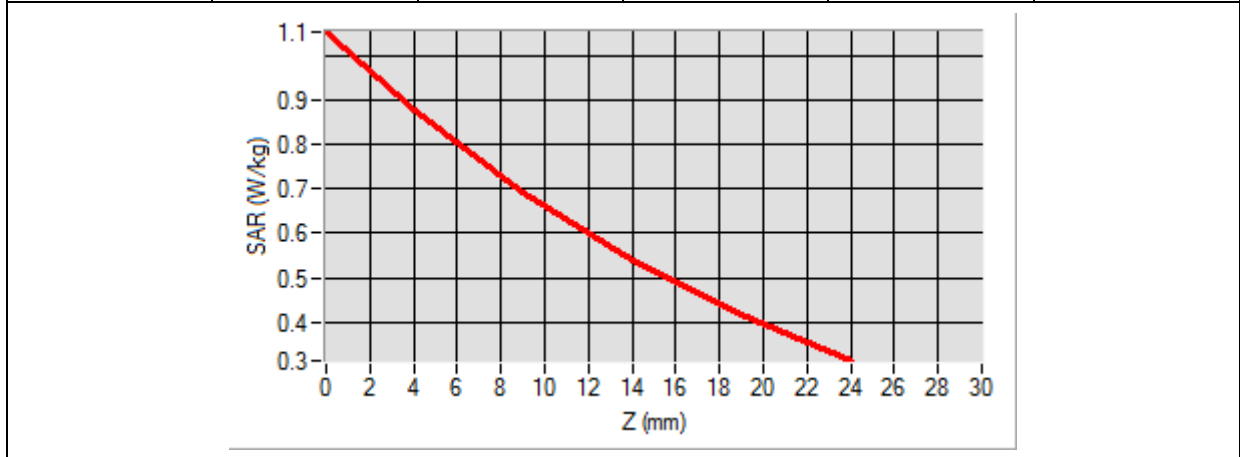
<b>Z (mm)</b>	<b>0.00</b>	<b>4.00</b>	<b>9.00</b>	<b>14.00</b>	<b>19.00</b>
<b>SAR (W/Kg)</b>	<b>1.0538</b>	<b>0.8772</b>	<b>0.6915</b>	<b>0.5401</b>	<b>0.4166</b>

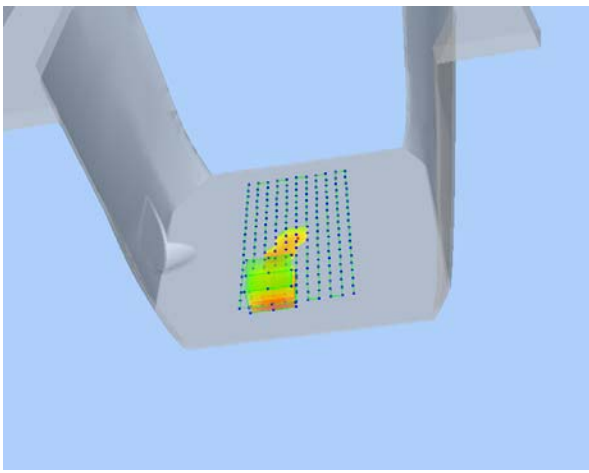

3D screen shot	Hot spot position
	

# MEASUREMENT 61

Type: Phone measurement (Complete)

Date of measurement: 10/30/2018

Measurement duration: 12 minutes 3 seconds

E-field Probe: SSE5 - SN 09/13 EP168; ConvF: 6.55; Calibrated: 06/01/2018

## A. Experimental conditions

<b>Area Scan</b>	sam_direct_droit2_surf8mm.txt
<b>Phantom</b>	Flat Plane
<b>Device Position</b>	Back(Body-worn)
<b>Band</b>	GSM1900
<b>Channels</b>	Middle
<b>Signal</b>	TDMA (Crest factor: 8.0)

## B. SAR Measurement Results

<b>Frequency (MHz)</b>	1880.000000
<b>Relative Permittivity (real part)</b>	52.420415
<b>Conductivity (S/m)</b>	1.501966
<b>Power Variation (%)</b>	1.474622
<b>Ambient Temperature</b>	21.1
<b>Liquid Temperature</b>	21.3

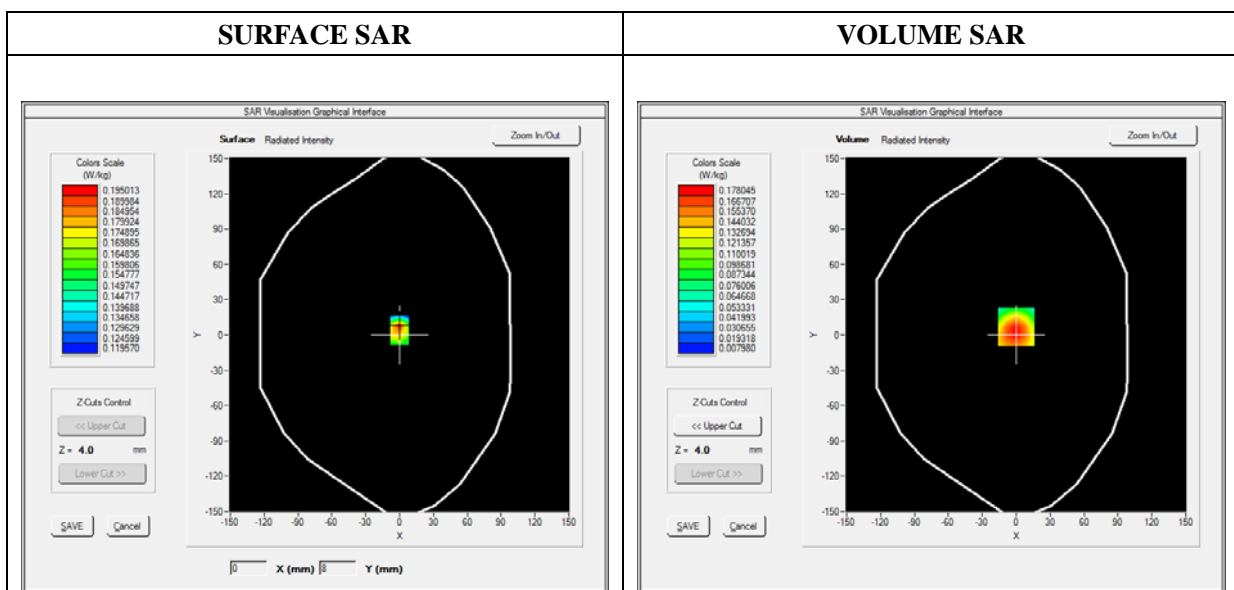



Maximum location: X=0.00, Y=7.00

SAR Peak: 0.28 W/kg

SAR 10g (W/Kg)	0.095424
SAR 1g (W/Kg)	0.172100

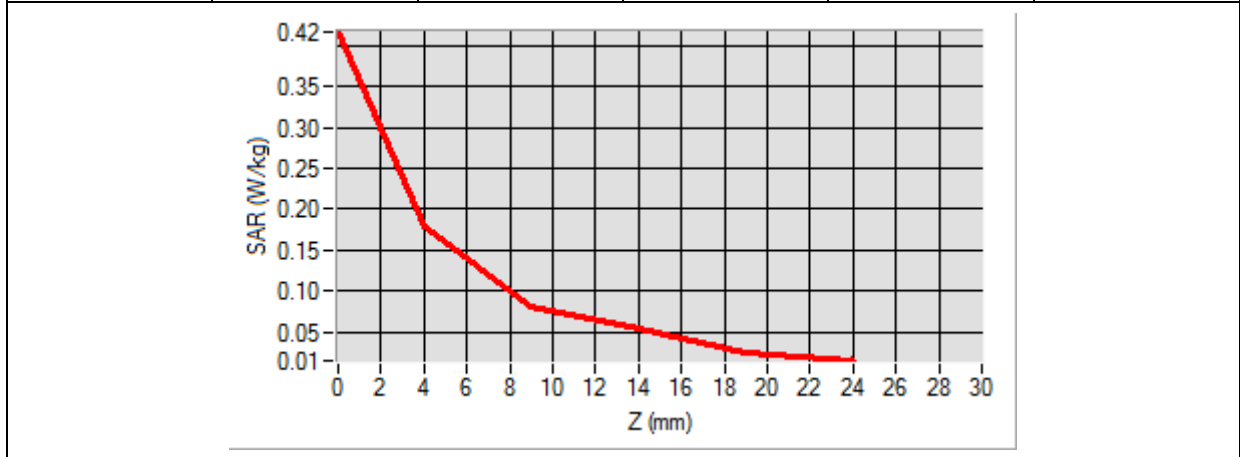
Z (mm)	0.00	4.00	9.00	14.00	19.00
SAR (W/Kg)	0.4164	0.1780	0.0803	0.0536	0.0249

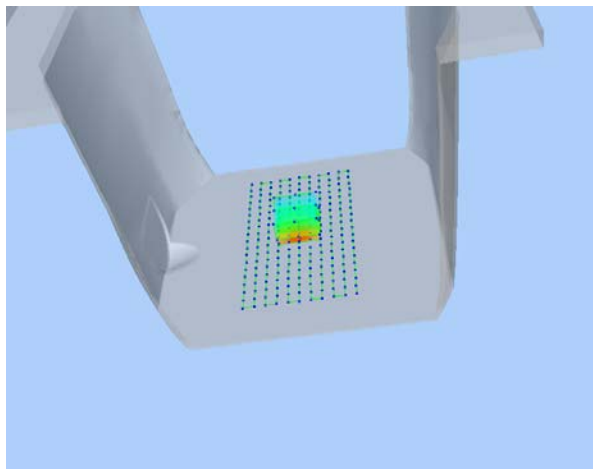

3D screen shot	Hot spot position
	



## MEASUREMENT 63

Type: Phone measurement (Complete)

Date of measurement: 10/29/2018

Measurement duration: 12 minutes 3 seconds

E-field Probe: SSE5 - SN 09/13 EP168; ConvF: 7.13; Calibrated: 06/01/2018

### A. Experimental conditions

<b>Area Scan</b>	sam_direct_droit2_surf8mm.txt
<b>Phantom</b>	Flat plane
<b>Device Position</b>	Back
<b>Band</b>	GPRS850_2TX
<b>Channels</b>	High
<b>Signal</b>	Duty Cycle: 1:4

### B. SAR Measurement Results

<b>Frequency (MHz)</b>	848.800000
<b>Relative Permittivity (real part)</b>	54.851214
<b>Conductivity (S/m)</b>	0.951454
<b>Power Variation (%)</b>	0.901472
<b>Ambient Temperature</b>	21.1
<b>Liquid Temperature</b>	21.3

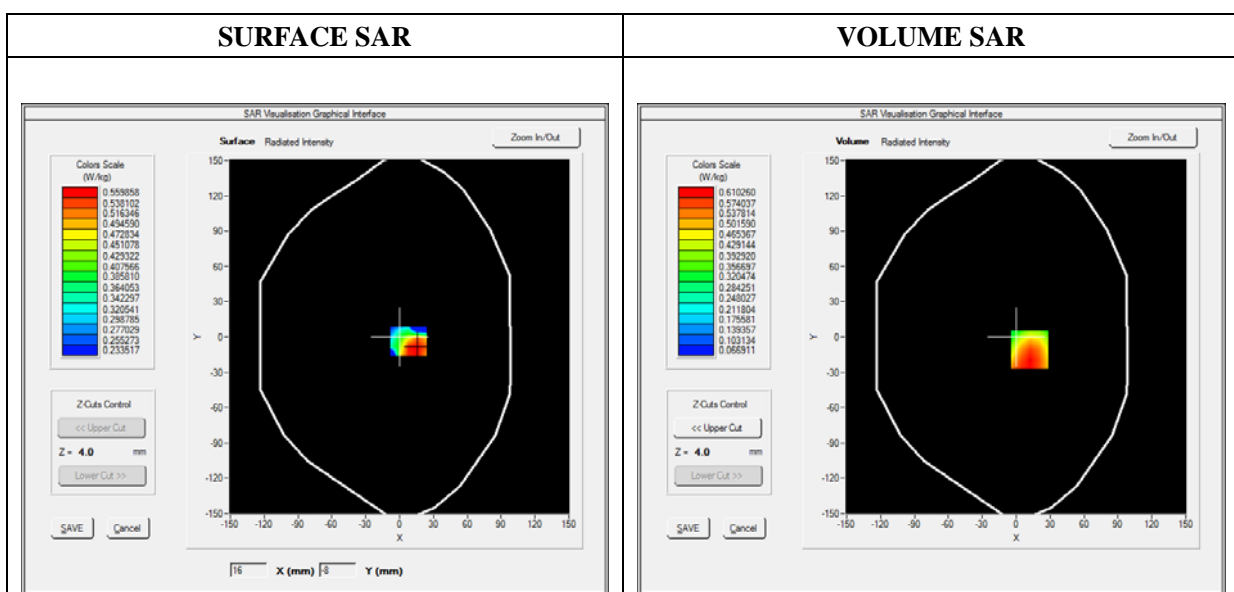

Maximum location: X=12.00, Y=-11.00

SAR Peak: 0.82 W/kg

SAR 10g (W/Kg)	0.390268
SAR 1g (W/Kg)	0.586466

Z (mm)	0.00	4.00	9.00	14.00	19.00
SAR (W/Kg)	1.6526	0.6103	0.3295	0.2969	0.1513

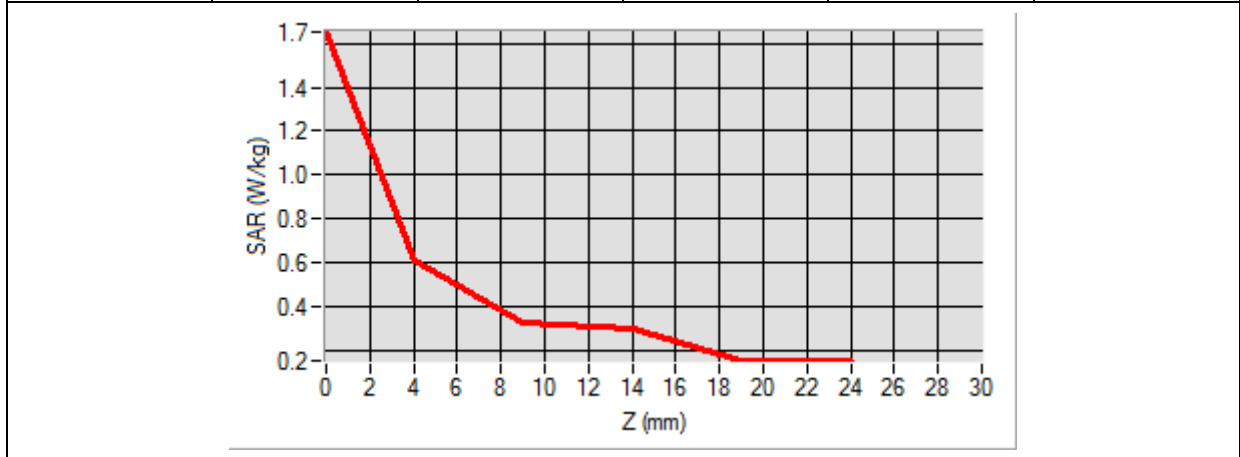

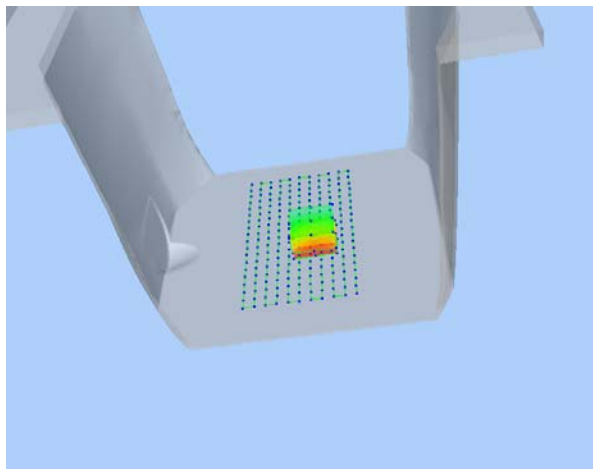
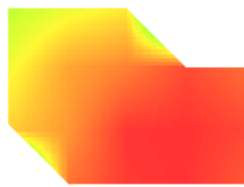
3D screen shot	Hot spot position
	

# MEASUREMENT 67

Type: Phone measurement (Complete)

Date of measurement: 10/30/2018

Measurement duration: 12 minutes 3 seconds

E-field Probe: SSE5 - SN 09/13 EP168; ConvF: 6.55; Calibrated: 06/01/2018

### A. Experimental conditions

<b>Area Scan</b>	sam_direct_droit2_surf8mm.txt
<b>Phantom</b>	Flat plane
<b>Device Position</b>	Back
<b>Band</b>	GPRS1900_3TX
<b>Channels</b>	Middle
<b>Signal</b>	Duty Cycle: 1:2.66

### B. SAR Measurement Results

<b>Frequency (MHz)</b>	1880.000000
<b>Relative Permittivity (real part)</b>	52.420415
<b>Conductivity (S/m)</b>	1.501966
<b>Power Variation (%)</b>	2.483762
<b>Ambient Temperature</b>	21.1
<b>Liquid Temperature</b>	21.3

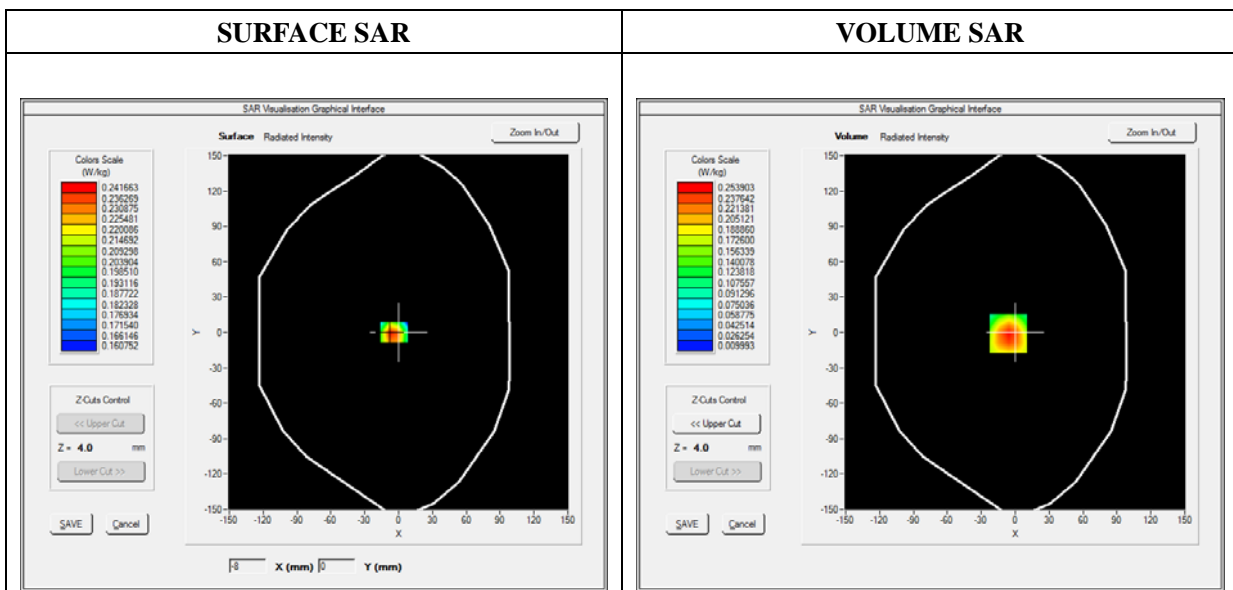



**Maximum location: X=-6.00, Y=-1.00**

**SAR Peak: 0.42 W/kg**

<b>SAR 10g (W/Kg)</b>	<b>0.128797</b>
<b>SAR 1g (W/Kg)</b>	<b>0.240434</b>

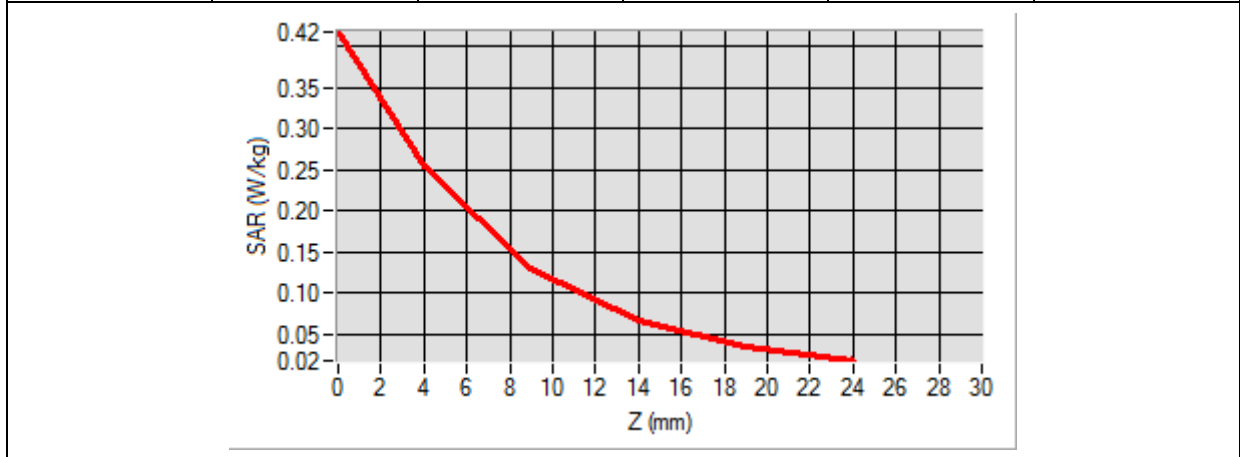
<b>Z (mm)</b>	<b>0.00</b>	<b>4.00</b>	<b>9.00</b>	<b>14.00</b>	<b>19.00</b>
<b>SAR (W/Kg)</b>	<b>0.4170</b>	<b>0.2539</b>	<b>0.1309</b>	<b>0.0669</b>	<b>0.0356</b>

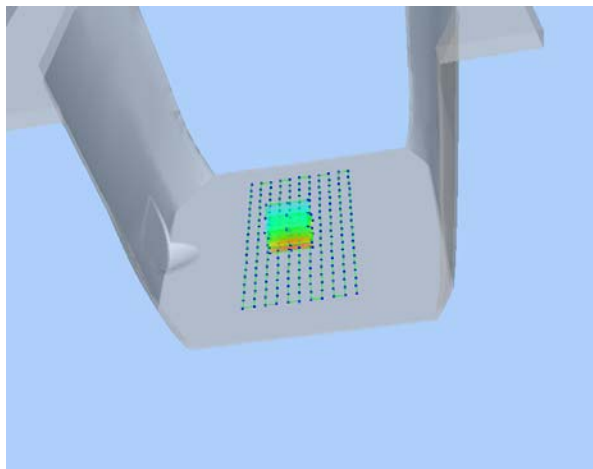

3D screen shot	Hot spot position
	

# MEASUREMENT 71

Type: Phone measurement (Complete)

Date of measurement: 10/30/2018

Measurement duration: 12 minutes 3 seconds

E-field Probe: SSE5 - SN 09/13 EP168; ConvF: 6.55; Calibrated: 06/01/2018

## A. Experimental conditions

<b>Area Scan</b>	sam_direct_droit2_surf8mm.txt
<b>Phantom</b>	Flat Plane
<b>Device Position</b>	Back
<b>Band</b>	WCDMA1900_RMC
<b>Channels</b>	Low
<b>Signal</b>	Duty Cycle 1:1

## B. SAR Measurement Results

<b>Frequency (MHz)</b>	1852.400000
<b>Relative Permittivity (real part)</b>	52.420415
<b>Conductivity (S/m)</b>	1.501966
<b>Power Variation (%)</b>	1.808271
<b>Ambient Temperature</b>	21.1
<b>Liquid Temperature</b>	21.3

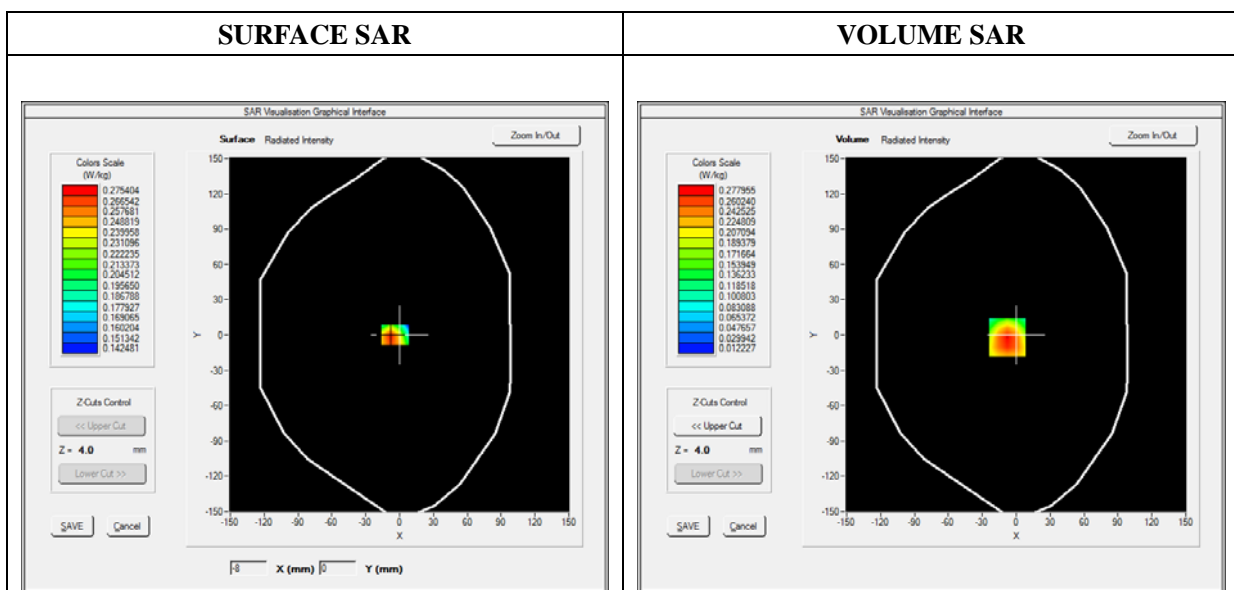



**Maximum location: X=-8.00, Y=-2.00**

**SAR Peak: 0.46 W/kg**

<b>SAR 10g (W/Kg)</b>	<b>0.145060</b>
<b>SAR 1g (W/Kg)</b>	<b>0.265304</b>

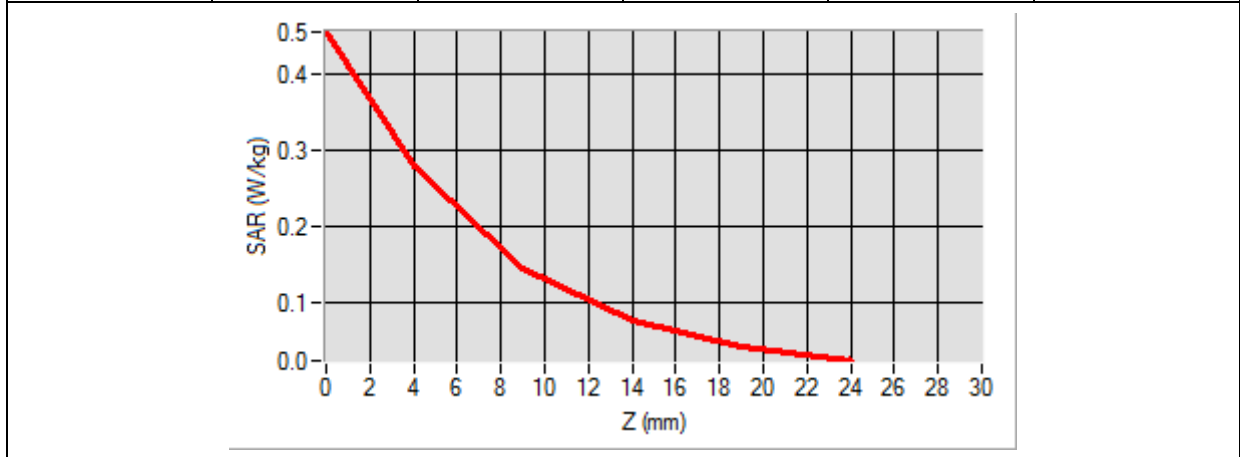
<b>Z (mm)</b>	<b>0.00</b>	<b>4.00</b>	<b>9.00</b>	<b>14.00</b>	<b>19.00</b>
<b>SAR (W/Kg)</b>	<b>0.4549</b>	<b>0.2780</b>	<b>0.1446</b>	<b>0.0751</b>	<b>0.0412</b>

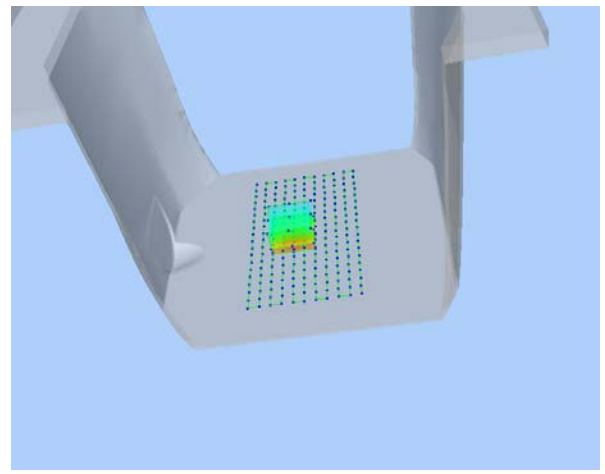

<b>3D screen shot</b>	<b>Hot spot position</b>
	

# MEASUREMENT 76

Type: Phone measurement (Complete)

Date of measurement: 10/29/2018

Measurement duration: 12 minutes 3 seconds

E-field Probe: SSE5 - SN 09/13 EP168; ConvF: 7.13; Calibrated: 06/01/2018

## A. Experimental conditions

<b>Area Scan</b>	sam_direct_droit2_surf8mm.txt
<b>Phantom</b>	Flat Plane
<b>Device Position</b>	Front
<b>Band</b>	WCDMA850_RMC
<b>Channels</b>	Middle
<b>Signal</b>	Duty Cycle 1:1

## B. SAR Measurement Results

<b>Frequency (MHz)</b>	836.600000
<b>Relative Permittivity (real part)</b>	54.851214
<b>Conductivity (S/m)</b>	0.951454
<b>Power Variation (%)</b>	2.341234
<b>Ambient Temperature</b>	21.1
<b>Liquid Temperature</b>	21.3

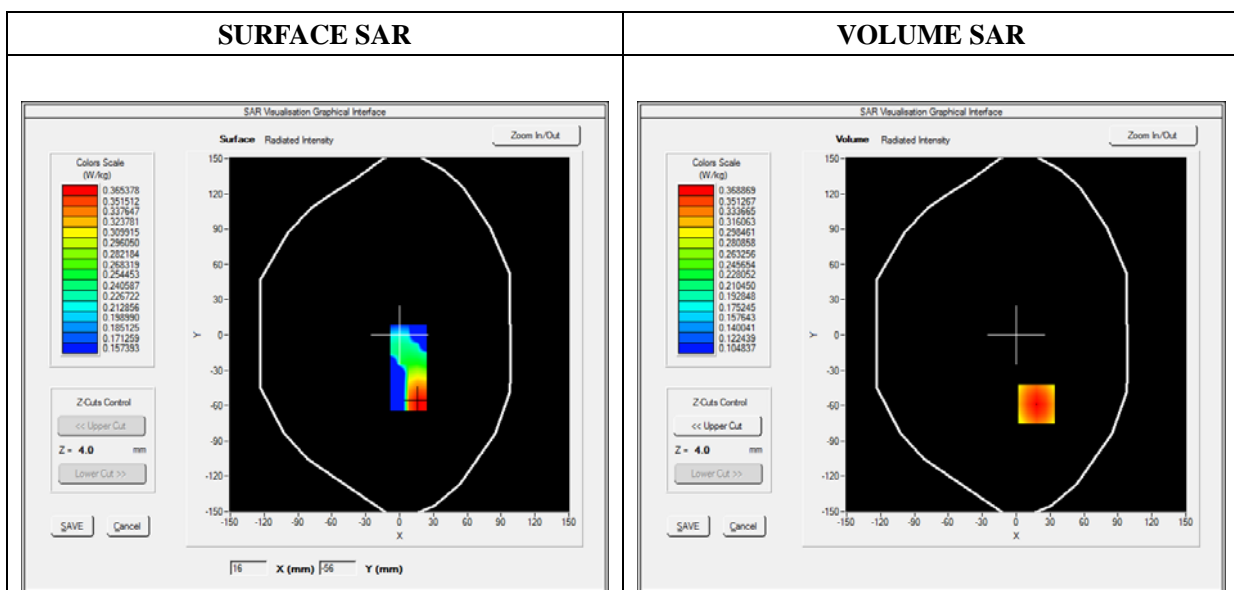



Maximum location: X=18.00, Y=-59.00

SAR Peak: 0.45 W/kg

SAR 10g (W/Kg)	0.266880
SAR 1g (W/Kg)	0.356061

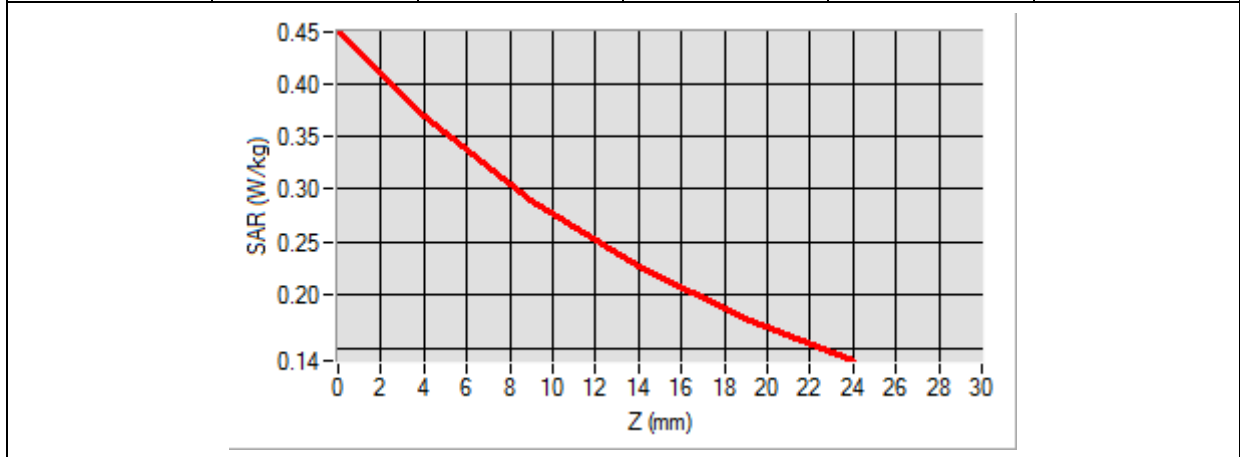
Z (mm)	0.00	4.00	9.00	14.00	19.00
SAR (W/Kg)	0.4483	0.3689	0.2886	0.2263	0.1779

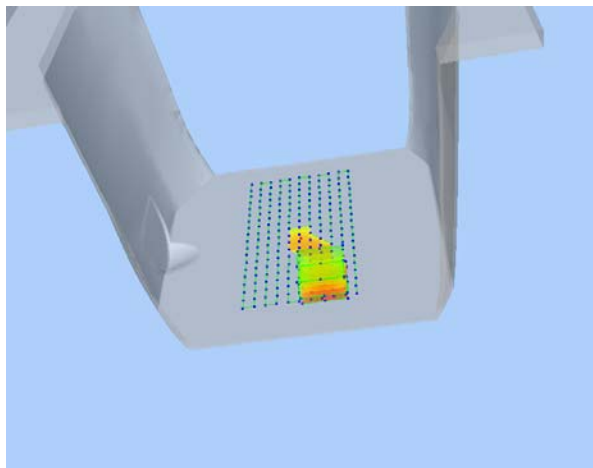

<p><b>3D screen shot</b></p>	<p><b>Hot spot position</b></p>
	



# MEASUREMENT 79

Type: Phone measurement (Complete)

Date of measurement: 10/30/2018

Measurement duration: 12 minutes 3 seconds

E-field Probe: SSE5 - SN 09/13 EP168; ConvF: 6.55; Calibrated: 06/01/2018

## A. Experimental conditions

<b>Area Scan</b>	sam_direct_droit2_surf8mm.txt
<b>Phantom</b>	Flat Plane
<b>Device Position</b>	Back
<b>Band</b>	LTE Band 2
<b>Channels</b>	QPSK, 20MHz, 1RB,Low
<b>Signal</b>	Duty Cycle 1:1

## B. SAR Measurement Results

<b>Frequency (MHz)</b>	1860.000000
<b>Relative Permittivity (real part)</b>	52.420415
<b>Conductivity (S/m)</b>	1.501966
<b>Power Variation (%)</b>	1.507282
<b>Ambient Temperature</b>	21.1
<b>Liquid Temperature</b>	21.3

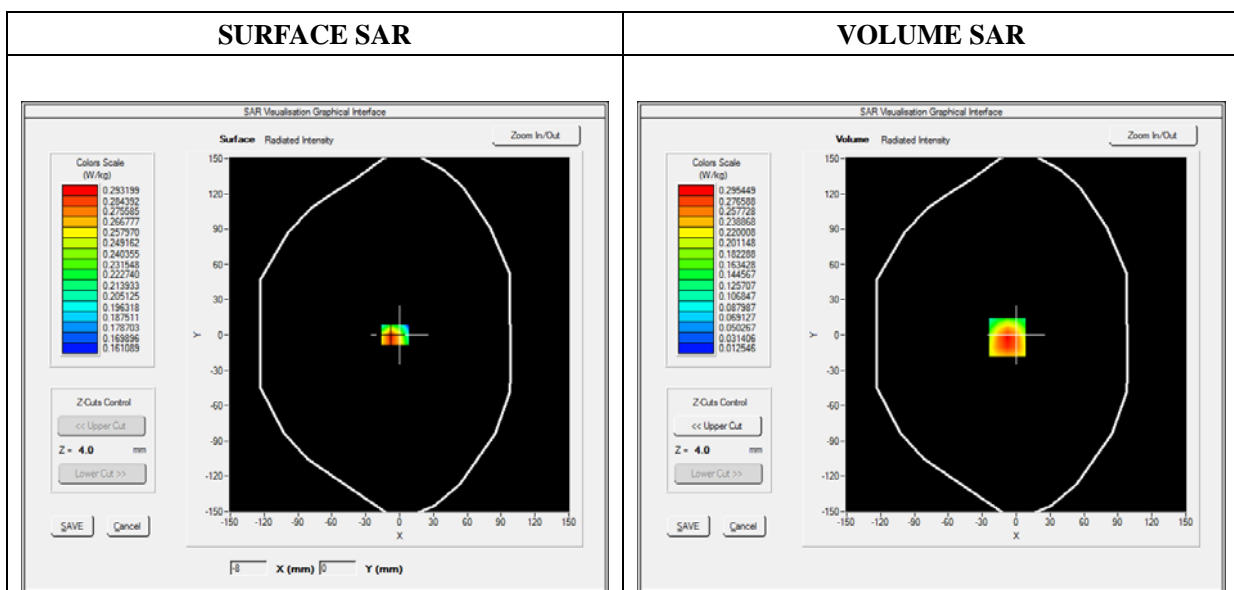



**Maximum location: X=-8.00, Y=-2.00**

**SAR Peak: 0.49 W/kg**

<b>SAR 10g (W/Kg)</b>	<b>0.153884</b>
<b>SAR 1g (W/Kg)</b>	<b>0.281994</b>

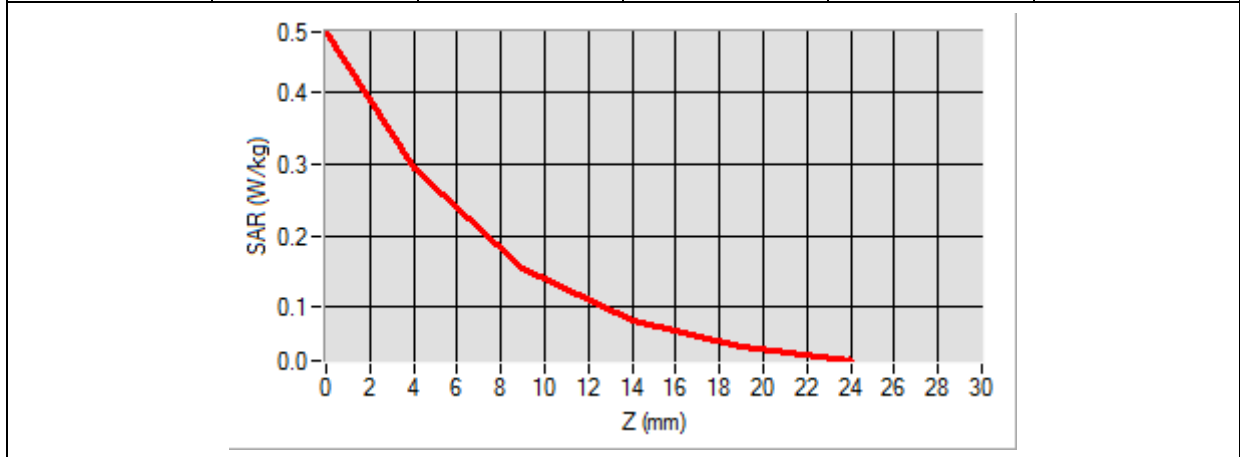
<b>Z (mm)</b>	<b>0.00</b>	<b>4.00</b>	<b>9.00</b>	<b>14.00</b>	<b>19.00</b>
<b>SAR (W/Kg)</b>	<b>0.4855</b>	<b>0.2954</b>	<b>0.1530</b>	<b>0.0794</b>	<b>0.0439</b>

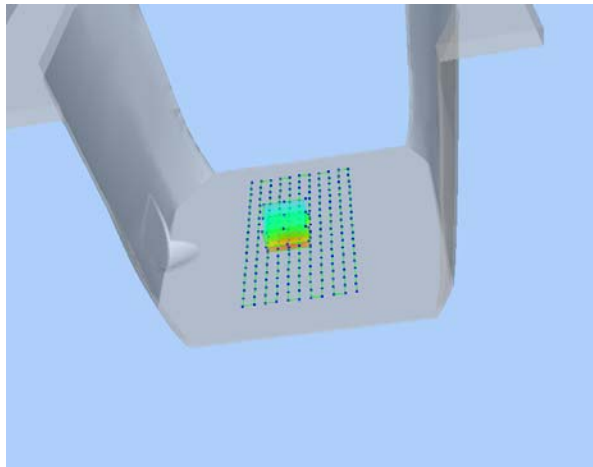

3D screen shot	Hot spot position
	

# MEASUREMENT 87

Type: Phone measurement (Complete)

Date of measurement: 10/30/2018

Measurement duration: 12 minutes 3 seconds

E-field Probe: SSE5 - SN 09/13 EP168; ConvF: 6.06; Calibrated: 06/01/2018

## A. Experimental conditions

<b>Area Scan</b>	sam_direct_droit2_surf8mm.txt
<b>Phantom</b>	Flat Plane
<b>Device Position</b>	Back
<b>Band</b>	LTE Band 4
<b>Channels</b>	QPSK, 20MHz, 1RB, Middle
<b>Signal</b>	Duty Cycle 1:1

## B. SAR Measurement Results

<b>Frequency (MHz)</b>	1732.500000
<b>Relative Permittivity (real part)</b>	51.224510
<b>Conductivity (S/m)</b>	1.461261
<b>Power Variation (%)</b>	0.858383
<b>Ambient Temperature</b>	21.1
<b>Liquid Temperature</b>	21.2

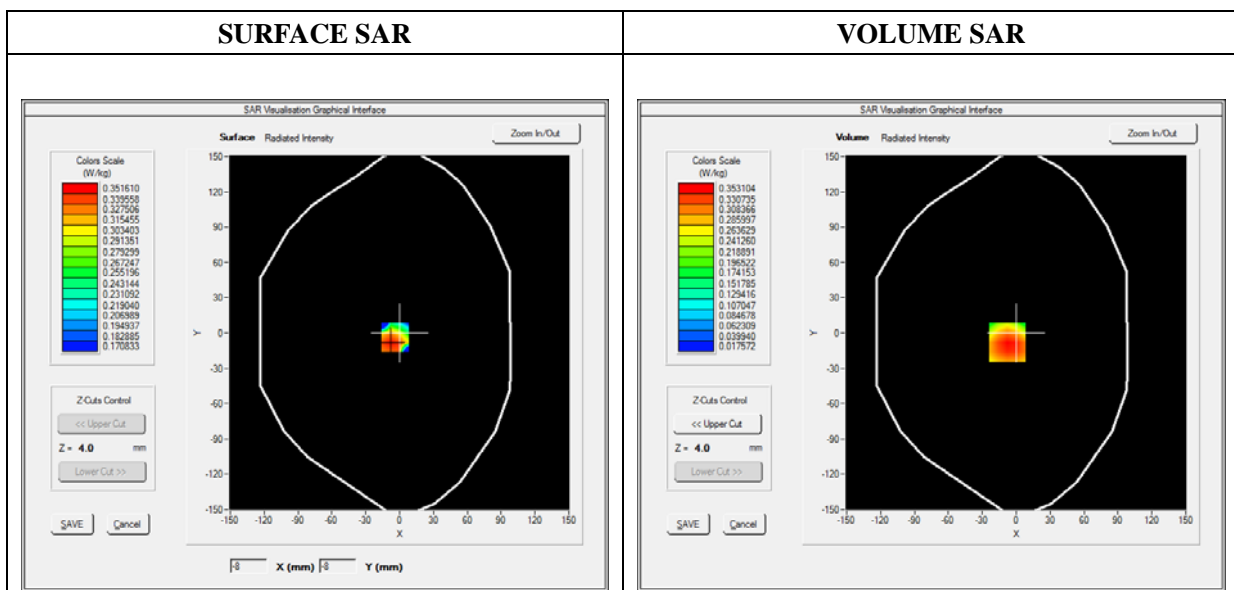



**Maximum location: X=-8.00, Y=-8.00**

**SAR Peak: 0.56 W/kg**

<b>SAR 10g (W/Kg)</b>	<b>0.195371</b>
<b>SAR 1g (W/Kg)</b>	<b>0.338546</b>

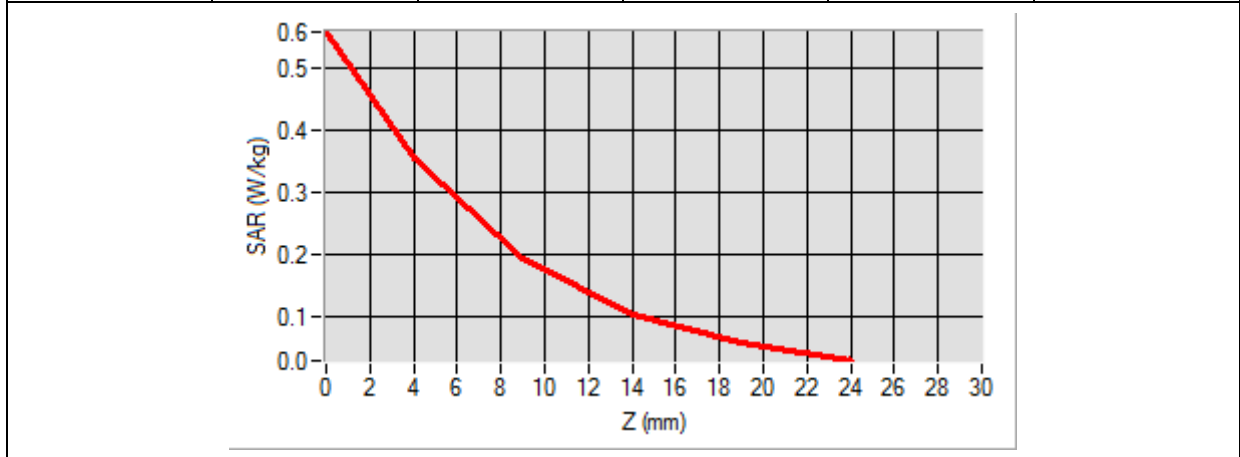
<b>Z (mm)</b>	<b>0.00</b>	<b>4.00</b>	<b>9.00</b>	<b>14.00</b>	<b>19.00</b>
<b>SAR (W/Kg)</b>	<b>0.5562</b>	<b>0.3531</b>	<b>0.1935</b>	<b>0.1050</b>	<b>0.0582</b>

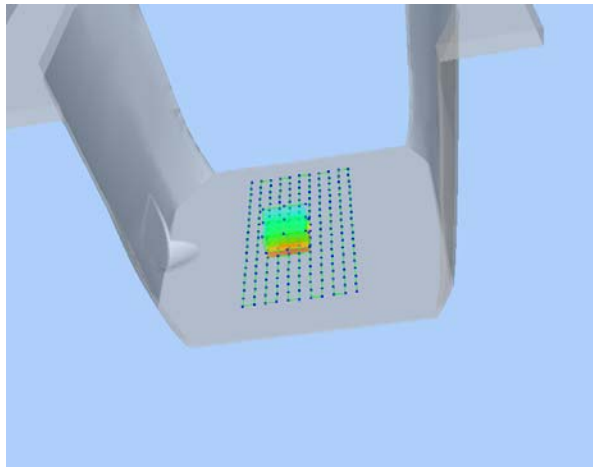

3D screen shot	Hot spot position
	

# MEASUREMENT 95

Type: Phone measurement (Complete)

Date of measurement: 10/31/2018

Measurement duration: 12 minutes 3 seconds

E-field Probe: SSE5 - SN 09/13 EP168; ConvF: 5.58; Calibrated: 06/01/2018

### A. Experimental conditions

<b>Area Scan</b>	sam_direct_droit2_surf8mm.txt
<b>Phantom</b>	Flat Plane
<b>Device Position</b>	Back
<b>Band</b>	LTE Band 7
<b>Channels</b>	QPSK, 20MHz, 1RB, Low
<b>Signal</b>	Duty Cycle 1:1

### B. SAR Measurement Results

<b>Frequency (MHz)</b>	2510.000000
<b>Relative Permittivity (real part)</b>	52.241202
<b>Conductivity (S/m)</b>	2.120943
<b>Power Variation (%)</b>	3.210986
<b>Ambient Temperature</b>	21.1
<b>Liquid Temperature</b>	21.2

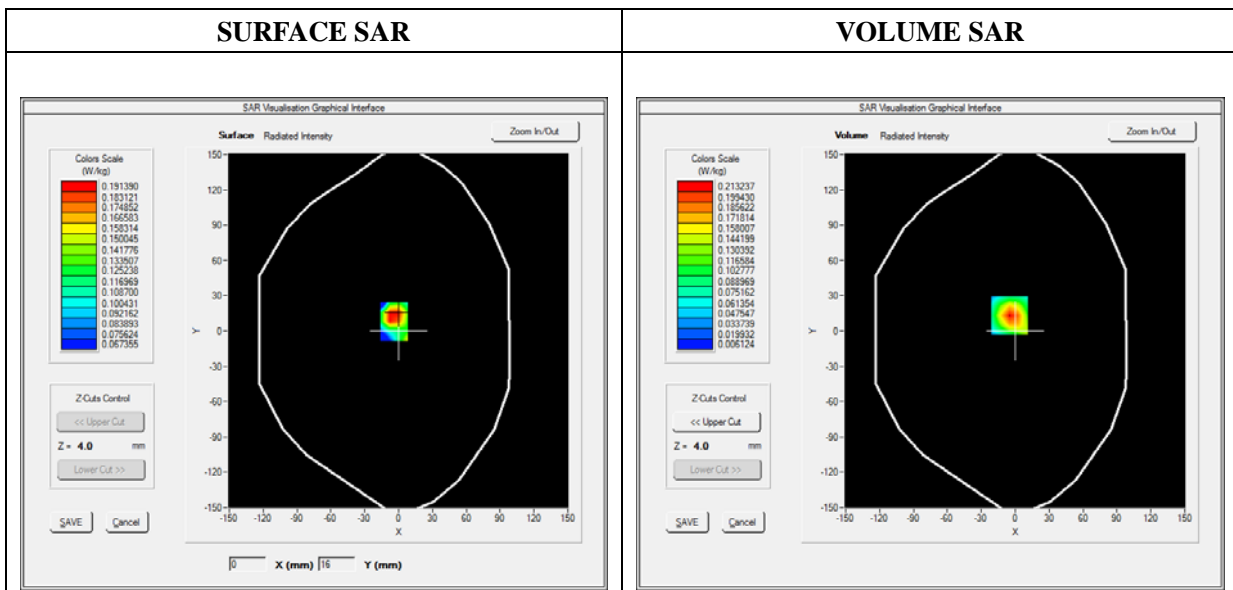

Maximum location: X=-5.00, Y=13.00

SAR Peak: 0.39 W/kg

SAR 10g (W/Kg)	0.093452
SAR 1g (W/Kg)	0.199308

Z (mm)	0.00	4.00	9.00	14.00	19.00
SAR (W/Kg)	0.3888	0.2132	0.0939	0.0415	0.0214

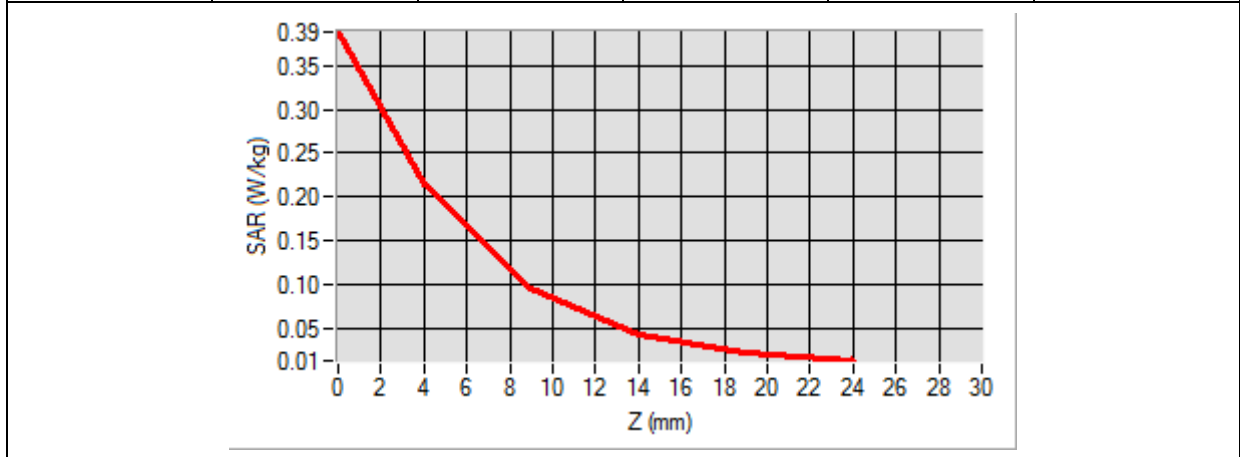

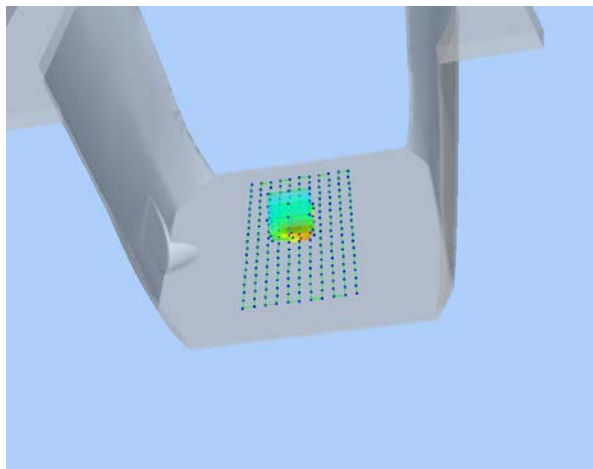
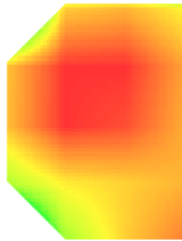
3D screen shot	Hot spot position
	

# MEASUREMENT 97

Type: Phone measurement (Complete)

Date of measurement: 10/31/2018

Measurement duration: 12 minutes 3 seconds

E-field Probe: SSE5 - SN 09/13 EP168; ConvF: 5.58; Calibrated: 06/01/2018

## A. Experimental conditions

<b>Area Scan</b>	sam_direct_droit2_surf8mm.txt
<b>Phantom</b>	Flat Plane
<b>Device Position</b>	Bottom
<b>Band</b>	LTE Band 7
<b>Channels</b>	QPSK, 20MHz, 1RB, Low
<b>Signal</b>	Duty Cycle 1:1

## B. SAR Measurement Results

<b>Frequency (MHz)</b>	2510.000000
<b>Relative Permittivity (real part)</b>	52.241202
<b>Conductivity (S/m)</b>	2.120943
<b>Power Variation (%)</b>	3.261771
<b>Ambient Temperature</b>	21.1
<b>Liquid Temperature</b>	21.2

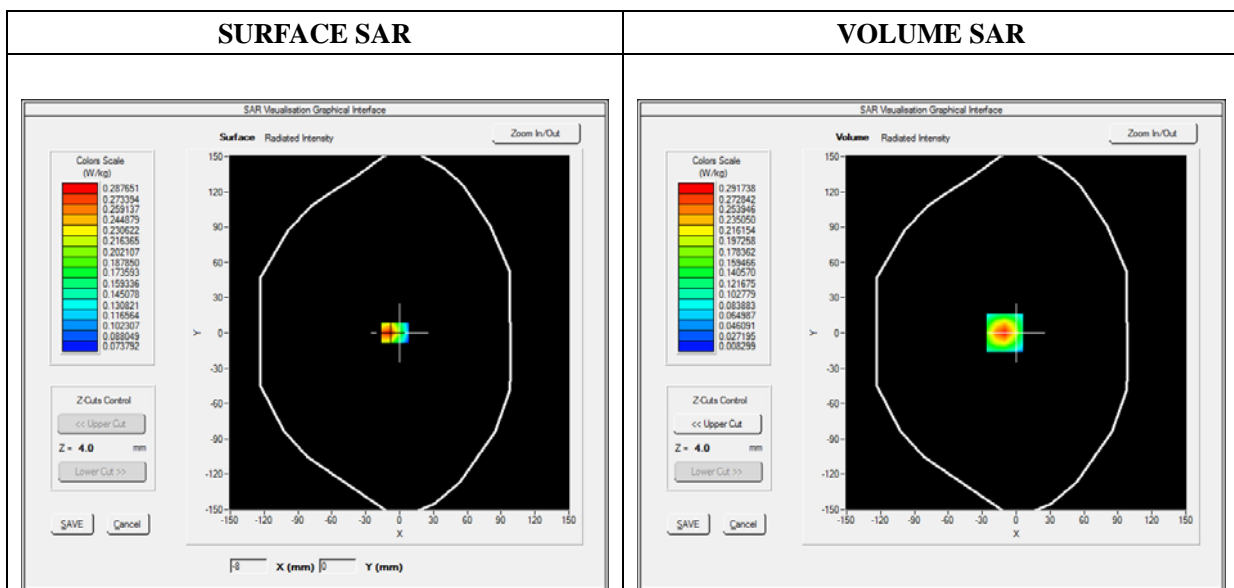

Maximum location: X=-10.00, Y=0.00

SAR Peak: 0.52 W/kg

SAR 10g (W/Kg)	0.128313
SAR 1g (W/Kg)	0.271589

Z (mm)	0.00	4.00	9.00	14.00	19.00
SAR (W/Kg)	0.5190	0.2917	0.1337	0.0615	0.0321

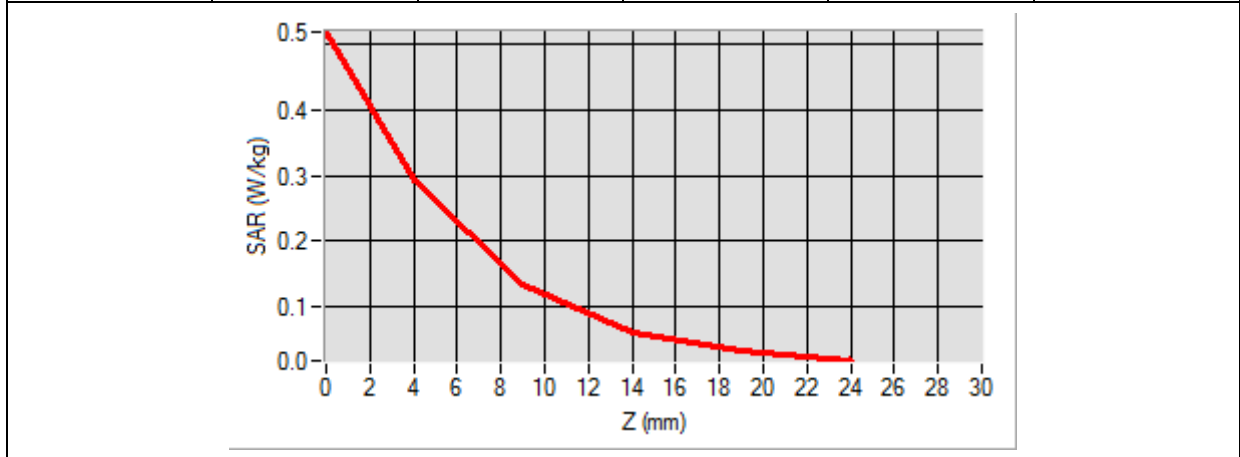

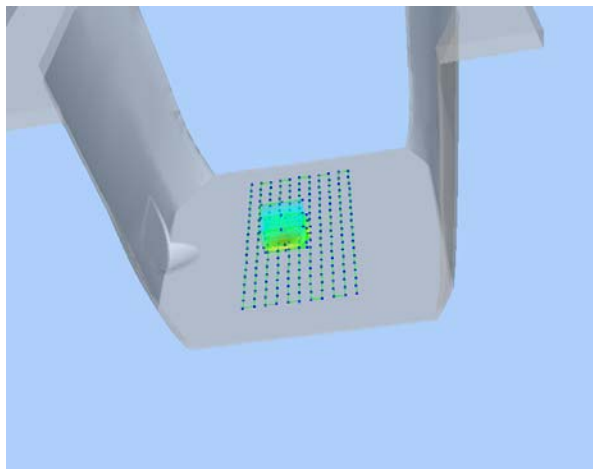
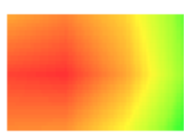
3D screen shot	Hot spot position
	



# MEASUREMENT 103

Type: Phone measurement (Complete)

Date of measurement: 10/31/2018

Measurement duration: 12 minutes 3 seconds

E-field Probe: SSE5 - SN 09/13 EP168; ConvF: 5.80; Calibrated: 06/01/2018

### A. Experimental conditions

<b>Area Scan</b>	sam_direct_droit2_surf8mm.txt
<b>Phantom</b>	Flat Plane
<b>Device Position</b>	Back
<b>Band</b>	WiFi_802.11b
<b>Channels</b>	High
<b>Signal</b>	Duty Cycle 1:1

### B. SAR Measurement Results

<b>Frequency (MHz)</b>	2462.000000
<b>Relative Permittivity (real part)</b>	52.010212
<b>Conductivity (S/m)</b>	1.910255
<b>Power Variation (%)</b>	2.410391
<b>Ambient Temperature</b>	21.1
<b>Liquid Temperature</b>	21.2

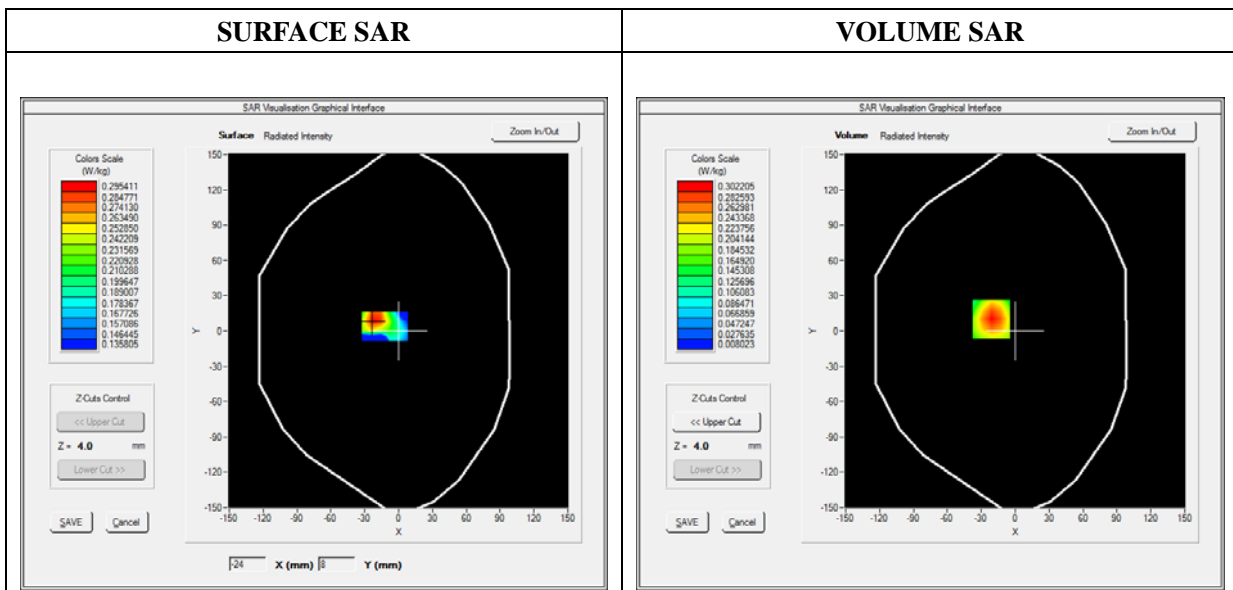

Maximum location: X=-21.00, Y=10.00

SAR Peak: 0.55 W/kg

SAR 10g (W/Kg)	0.143922
SAR 1g (W/Kg)	0.287743

Z (mm)	0.00	4.00	9.00	14.00	19.00
SAR (W/Kg)	0.5529	0.3022	0.1309	0.0548	0.0250

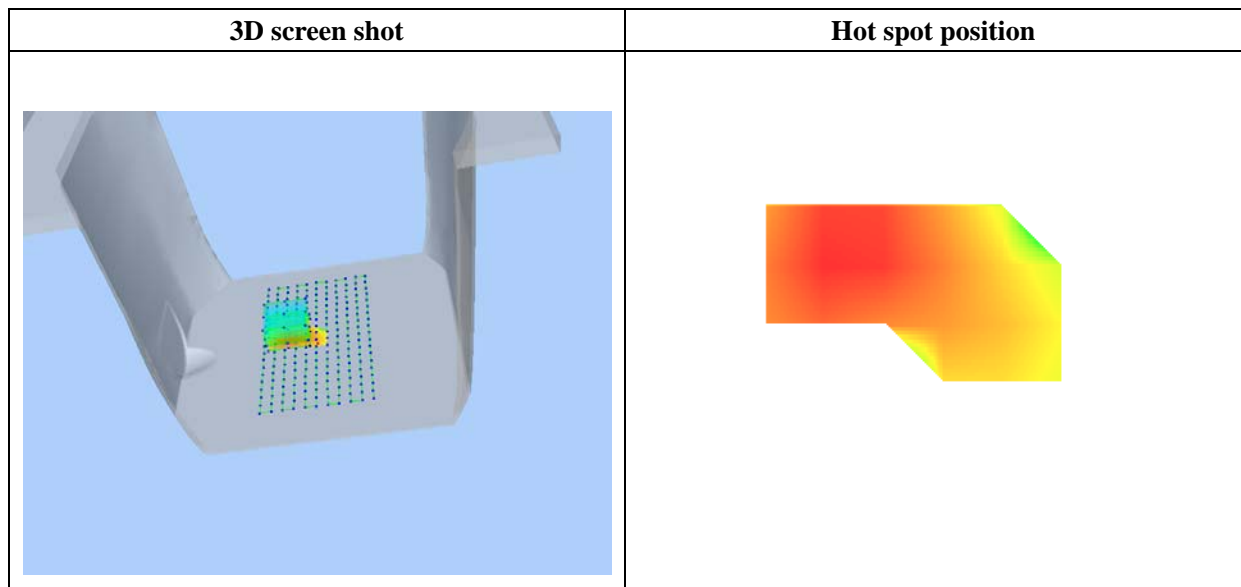
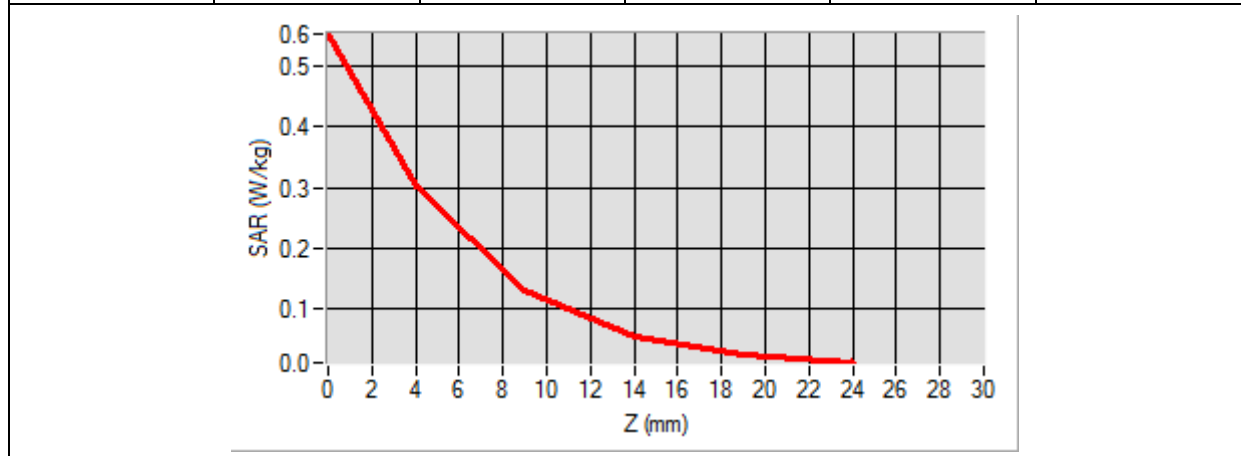

## Annex C. EUT Photos

---

### EUT View Front



### EUT View Back



## Antenna View

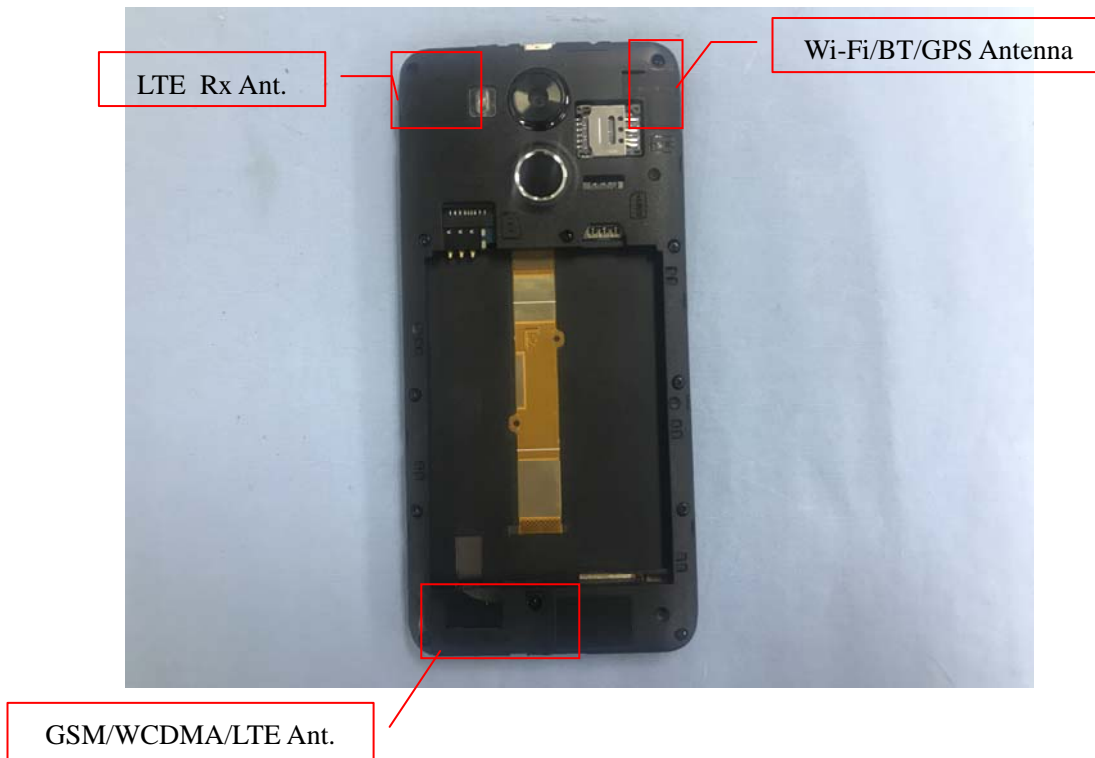

## Annex D. Test Setup Photos

---

### Head Exposure Conditions

**Cheek**

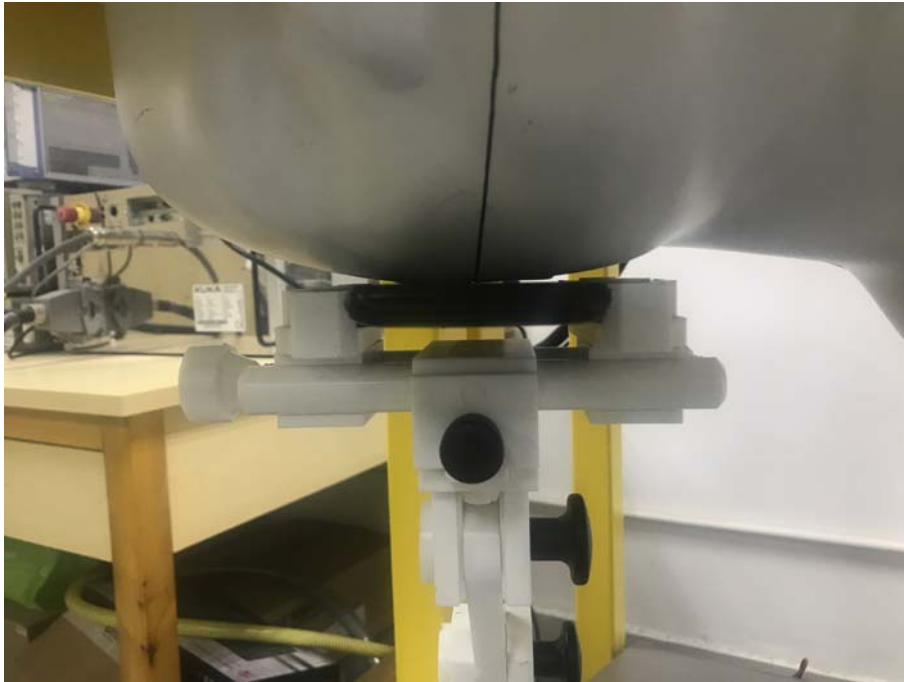

**Tilt**

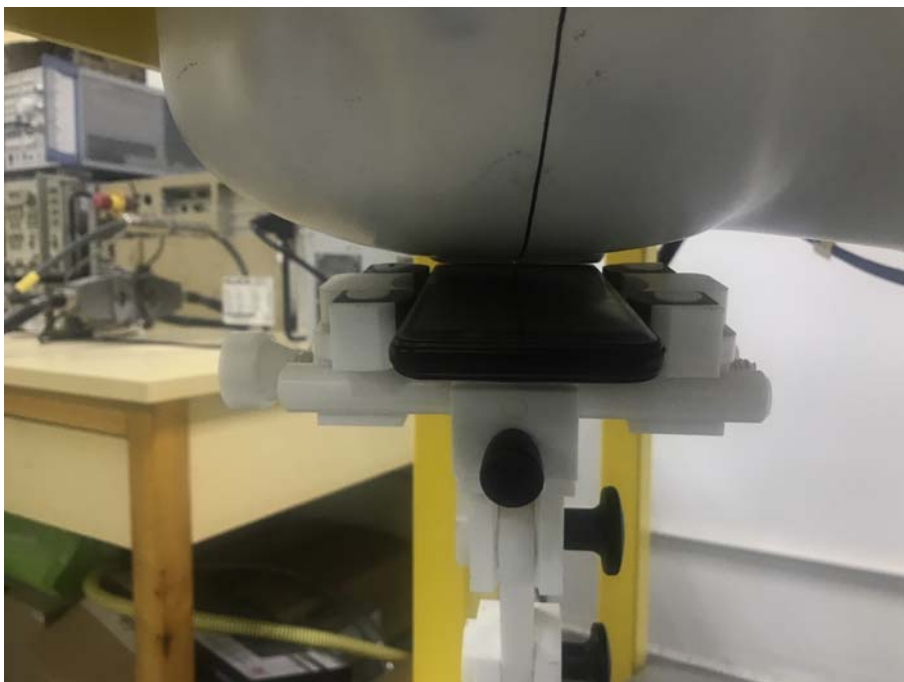

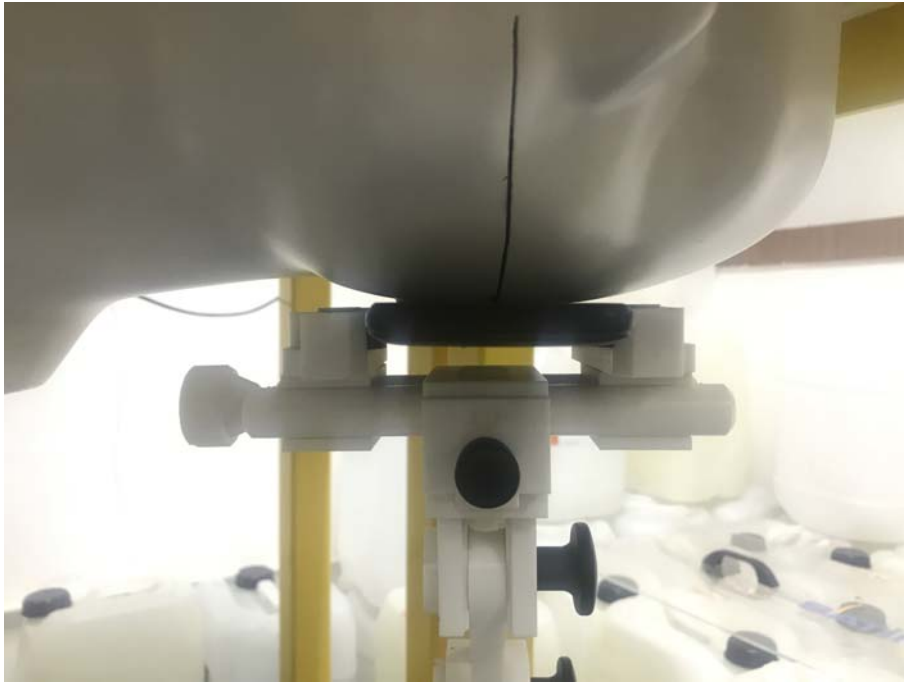
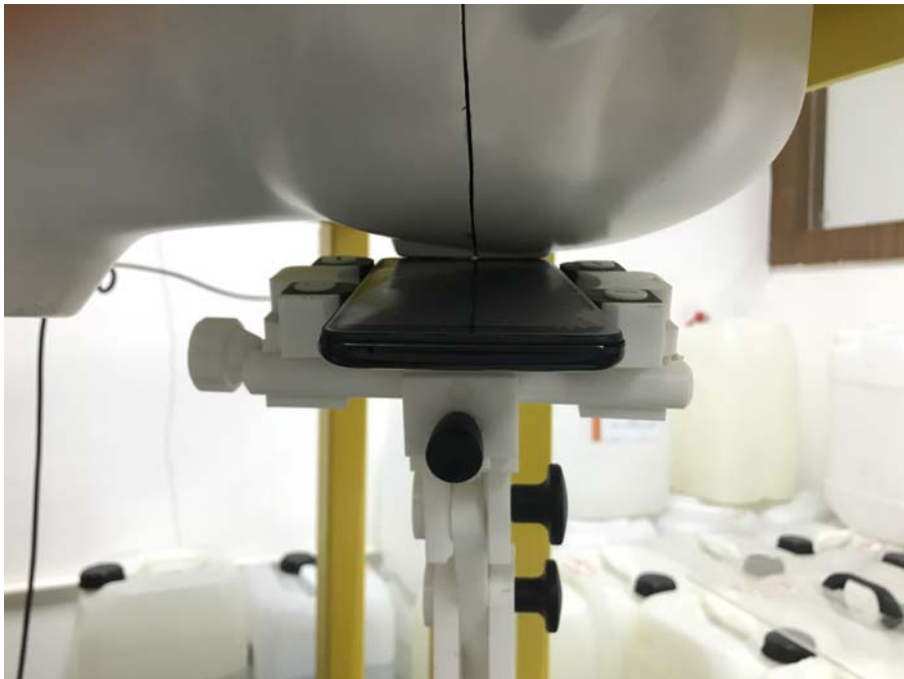
**Cheek****Tilt**

## Body-worn & Hotspot mode Exposure Conditions

### Body Front



### Body Back



## Hotspot Exposure Conditions

### Body Left

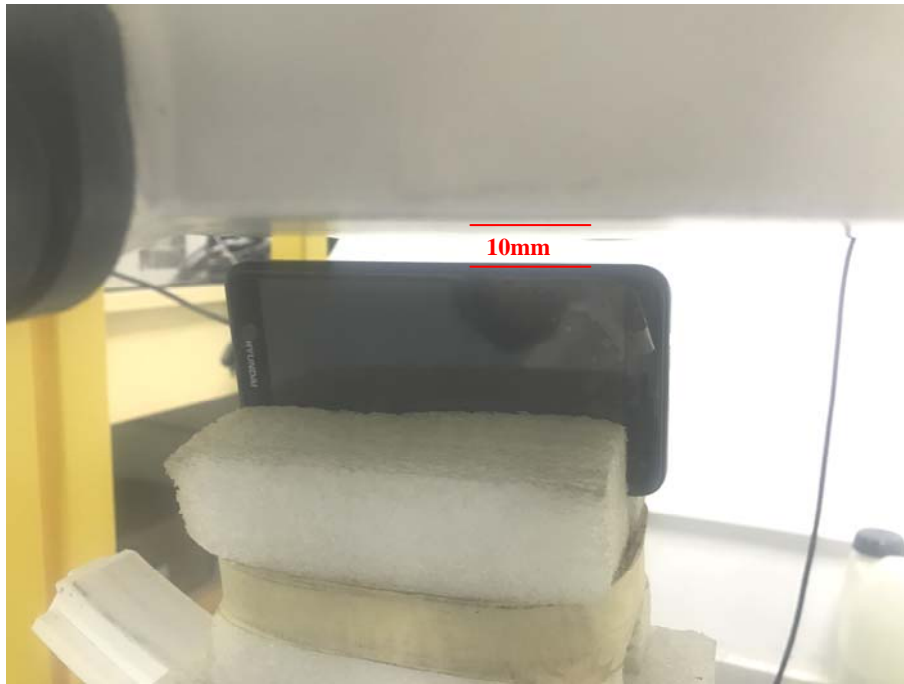

### Body Right

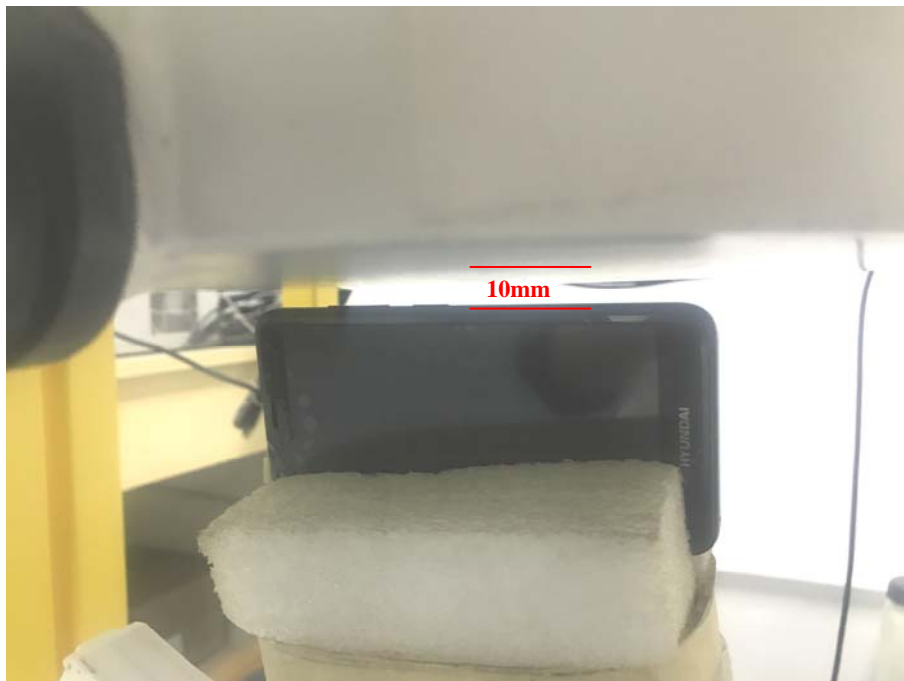



### Body Top

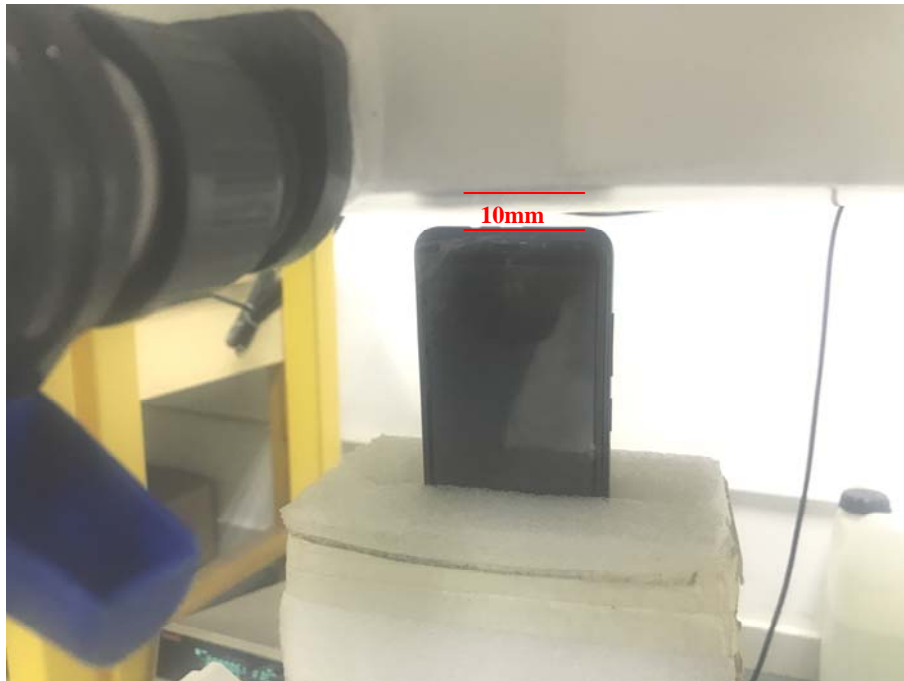

### Body Bottom

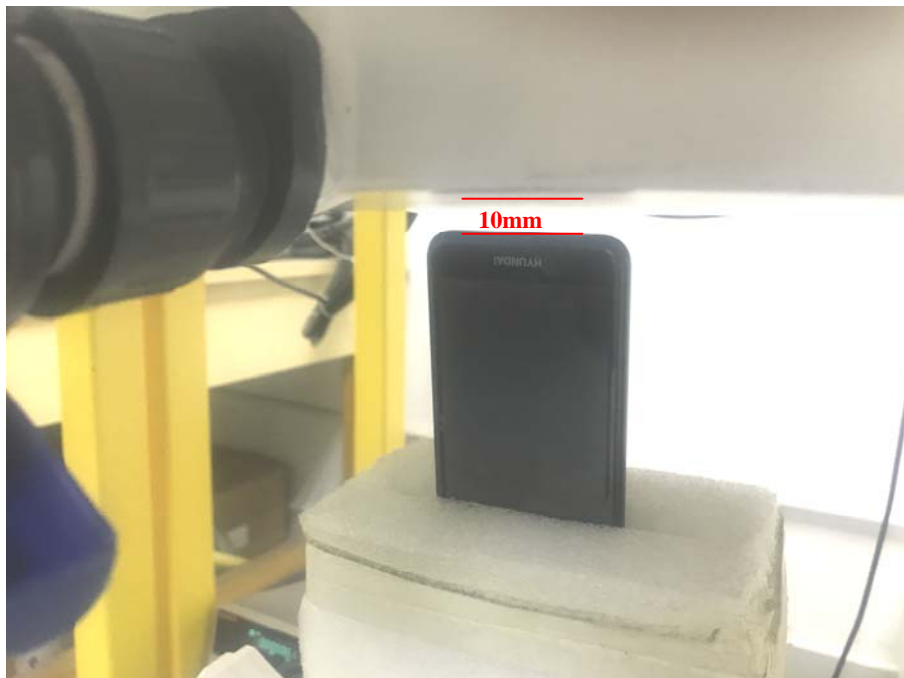

## Annex E. Calibration Certificate

---

*Please refer to the exhibit for the calibration certificate*

**\*\*\*\*\* END OF REPORT \*\*\*\*\***