



Shenzhen Global Test Service Co.,Ltd.

No.7-101 and 8A-104, Building 7 and 8, DCC Cultural and Creative Garden, No.98, Pingxin North Road, Shangmugu Community, Pinghu Street, Longgang District, Shenzhen, Guangdong

FCC PART 22/24 TEST REPORT

FCC Part 22 /Part 24

Report Reference No..... : GTS20190515004-1-1-5

FCC ID..... : RQQHLT-E602TA

Compiled by

(position+printed name+signature)..: File administrators Jimmy Wang

Supervised by

(position+printed name+signature)..: Test Engineer Aaron Tan



Approved by

(position+printed name+signature)..: Manager Jason Hu

Date of issue.....: May. 21, 2019

Representative Laboratory Name : Shenzhen Global Test Service Co.,Ltd.

Address.....: No.7-101 and 8A-104, Building 7 and 8, DCC Cultural and Creative Garden, No.98, Pingxin North Road, Shangmugu Community, Pinghu Street, Longgang District, Shenzhen, Guangdong

Applicant's name.....: HYUNDAI CORPORATION

Address.....: 25,Yulgok-ro 2-Gil, Jongno-gu, Seoul, South Korea

Test specification :

Standard

FCC Part 22: PUBLIC MOBILE SERVICES

FCC Part 24: PERSONAL COMMUNICATIONS SERVICES

Shenzhen Global Test Service Co.,Ltd.All rights reserved.

This publication may be reproduced in whole or in part for non-commercial purposes as long as the Shenzhen Global Test Service Co.,Ltd.as copyright owner and source of the material. Shenzhen Global Test Service Co.,Ltd.takes no responsibility for and will not assume liability for damages resulting from the reader's interpretation of the reproduced material due to its placement and context.

Test item description: Smart Phone

Trade Mark

Manufacturer.....: Shenzhen Tinno Mobile Technology Corp.

Model/Type reference.....: E602

Listed Models

Ratings.....: DC 3.85V from battery and DC 5V From Adapter

Modulation

Hardware version

Software version

Frequency..... UMTS Band II, UMTS Band V

Result.....: **PASS**

TEST REPORT

| | |
|--|---------------|
| Test Report No. : GTS20190515004-1-1-5 | May.21, 2019 |
| | Date of issue |

Equipment under Test : Smart Phone

Model /Type : E602

Listed Models : /

Applicant : **HYUNDAI CORPORATION**

Address : 25,Yulgok-ro 2-Gil, Jongno-gu, Seoul, South Korea

Manufacturer : **Shenzhen Rainbow Time Technology Co.,Ltd**

Address : 4/F.,H-3 Building,OCT Eastern Industrial Park. NO.1 XiangShan East Road.,Nan Shan District,Shenzhen,P.R.China.

| | |
|---------------------|-------------|
| Test Result: | PASS |
|---------------------|-------------|

The test report merely corresponds to the test sample.
It is not permitted to copy extracts of these test result without the written permission of the test laboratory.

Contents

| | | |
|-----------------|---|------------------|
| <u>1</u> | <u>TEST STANDARDS.....</u> | <u>4</u> |
| <u>2</u> | <u>SUMMARY</u> | <u>5</u> |
| 2.1 | General Remarks | 5 |
| 2.2 | Product Description | 5 |
| 2.3 | Equipment under Test | 6 |
| 2.4 | Short description of the Equipment under Test (EUT) | 6 |
| 2.5 | EUT configuration | 6 |
| 2.6 | Related Submittal(s) / Grant (s) | 6 |
| 2.7 | General Test Conditions/Configurations | 7 |
| 2.8 | Modifications | 7 |
| <u>3</u> | <u>TEST ENVIRONMENT.....</u> | <u>8</u> |
| 3.1 | Address of the test laboratory | 8 |
| 3.2 | Test Facility | 8 |
| 3.3 | Environmental conditions | 8 |
| 3.4 | Test Description | 9 |
| 3.5 | Equipments Used during the Test | 10 |
| <u>4</u> | <u>TEST CONDITIONS AND RESULTS.....</u> | <u>11</u> |
| 4.1 | Output Power | 11 |
| 4.2 | Radiated Spurious Emssion | 15 |
| 4.3 | Occupied Bandwidth and Emission Bandwith | 18 |
| 4.4 | Band Edge Compliance | 20 |
| 4.5 | Spurious Emssion on Antenna Port | 22 |
| 4.6 | Frequency Stability Test | 27 |
| 4.7 | Peak-to-Average Ratio (PAR) | 29 |
| <u>5</u> | <u>TEST SETUP PHOTOS OF THE EUT</u> | <u>30</u> |
| <u>6</u> | <u>EXTERNAL AND INTERNAL PHOTOS OF THE EUT</u> | <u>30</u> |

1 TEST STANDARDS

The tests were performed according to following standards:

[FCC Part 2:](#) FREQUENCY ALLOCATIONS AND RADIO TREATY MATTERS; GENERAL RULES AND REGULATIONS

[FCC Part 22 Subpart H:](#) PRIVATE LAND MOBILE RADIO SERVICES.

[FCC Part 24 Subpart E:](#) PUBLIC MOBILE SERVICES

[ANSI/TIA-603-E-2016:](#) Land Mobile FM or PM Communications Equipment Measurement and Performance Standards.

[ANSI C63.26-2015:](#) IEEE/ANSI Standard for Compliance Testing of Transmitters Used in Licensed Radio Services

[FCC KDB971168D01](#) Power Meas License Digital Systems

2 SUMMARY

2.1 General Remarks

| | | |
|--------------------------------|---|--------------|
| Date of receipt of test sample | : | May.01, 2019 |
| | | |
| Testing commenced on | : | May.01, 2019 |
| | | |
| Testing concluded on | : | May.21, 2019 |

2.2 Product Description

The **HYUNDAI CORPORATION**'s Model: E602 or the "EUT" as referred to in this report; more general information as follows, for more details, refer to the user's manual of the EUT.

| | |
|-------------------------------|---|
| Name of EUT | Smart Phone |
| Model Number | E602 |
| Modulation Type | QPSK for UMTS, |
| Antenna Type | Internal |
| UMTS Operation Frequency Band | Device supported UMTS FDD Band II, FDD Band V |
| HSDPA Release Version | Release 10 |
| HSUPA Release Version | Release 6 |
| DC-HSUPA Release Version | Not Supported |
| WCDMA Release Version | R99 |
| Extreme temp. Tolerance | -30°C to +50°C |
| Extreme vol. Limits | 3.40VDC to 4.20VDC (nominal: 3.85VDC) |
| Antenna gain: | FDD Band V: -0.71dbi, FDD Band II: -0.86dbi |

2.3 Equipment under Test

Power supply system utilised

| | | | |
|----------------------|---|---|-----------------------------------|
| Power supply voltage | : | <input type="radio"/> 120V / 60 Hz | <input type="radio"/> 115V / 60Hz |
| | | <input type="radio"/> 12 V DC | <input type="radio"/> 24 V DC |
| | | <input checked="" type="radio"/> Other (specified in blank below) | |

DC 3.85V from battery and DC 5V From Adapter

Test frequency list

| Test Mode | TX/RX | RF Channel | | |
|-----------|-------|--------------|--------------|--------------|
| | | Low(L) | Middle (M) | High (H) |
| WCDMA850 | TX | Channel 4132 | Channel 4182 | Channel 4233 |
| | | 826.4 MHz | 836.4 MHz | 846.6 MHz |
| | RX | Channel 4357 | Channel 4407 | Channel 4458 |
| | | 871.4 MHz | 881.4 MHz | 891.6 MHz |
| Test Mode | TX/RX | RF Channel | | |
| | | Low(L) | Middle (M) | High (H) |
| WCDMA1900 | TX | Channel 9262 | Channel 9400 | Channel 9538 |
| | | 1852.4 MHz | 1880.0 MHz | 1907.6 MHz |
| | RX | Channel 9662 | Channel 9800 | Channel 9938 |
| | | 1932.4 MHz | 1960.0 MHz | 1987.6 MHz |

2.4 Short description of the Equipment under Test (EUT)

2.4.1 General Description

This is a Smart Phone.

For more details, refer to the user's manual of the EUT

2.5 EUT configuration

The following peripheral devices and interface cables were connected during the measurement:

● - supplied by the manufacturer

○ - supplied by the lab

| | |
|-------------------------|-----------------|
| <input type="radio"/> / | M/N : / |
| | Manufacturer: / |

2.6 Related Submittal(s) / Grant (s)

This submittal(s) (test report) is intended for **FCC ID: RQQLT-E602TA** filing to comply with FCC Part 22 and Part 24 Rules.

2.7 General Test Conditions/Configurations

2.7.1 Test Modes

NOTE: The test mode(s) are selected according to relevant radio technology specifications.

| Test Mode | Test Modes Description |
|-----------|-------------------------------|
| UMTS/TM1 | WCDMA system, QPSK modulation |
| UMTS/TM2 | HSDPA system, QPSK modulation |
| UMTS/TM3 | HSUPA system, QPSK modulation |

Note:

1. This EUT owns two SIM cards, after we perform the pretest for these two SIM cards; we found the SIM 1 is the worst case, so its result is recorded in this report.
2. As WCDMA, HSDPA and HSUPA with the same emission designator, test result recorded in this report at the worst case UMTS/TM1 only after exploratory scan.

2.7.2 Test Environment

| Environment Parameter | Selected Values During Tests | |
|-----------------------|------------------------------|---------|
| Relative Humidity | Ambient | |
| Temperature | TN | Ambient |
| Voltage | VL | 3.40V |
| | VN | 3.85V |
| | VH | 4.20V |

NOTE: VL=lower extreme test voltage VN=nominal voltage
VH=upper extreme test voltage TN=normal temperature

2.8 Modifications

No modifications were implemented to meet testing criteria.

3 TEST ENVIRONMENT

3.1 Address of the test laboratory

Shenzhen Global Test Service Co.,Ltd.

No.7-101 and 8A-104, Building 7 and 8, DCC Cultural and Creative Garden, No.98, Pingxin North Road, Shangmugu Community, Pinghu Street, Longgang District, Shenzhen, Guangdong

The 3m-Semi anechoic test site fulfils CISPR 16-1-4 according to ANSI C63.4:2014 and CISPR 16-1-4:2010 SVSWR requirement for radiated emission above 1GHz.

3.2 Test Facility

The test facility is recognized, certified, or accredited by the following organizations:

FCC-Registration No.: 165725

Shenzhen Global Test Service Co.,Ltd EMC Laboratory has been registered and fully described in a report filed with the (FCC) Federal Communications Commission. The acceptance letter from the FCC is maintained in our files.

A2LA-Lab Cert. No.: 4758.01

Shenzhen Global Test Service Co.,Ltd. EMC Laboratory has been accredited by A2LA for technical competence in the field of electrical testing, and proved to be in compliance with ISO/IEC 17025: 2005 General Requirements for the Competence of Testing and Calibration Laboratories and any additional program requirements in the identified field of testing.

CNAS-Lab Code: L8169

Shenzhen Global Test Service Co.,Ltd. has been assessed and proved to be in compliance with CNAS-CL01 Accreditation Criteria for Testing and Calibration Laboratories (identical to ISO/IEC 17025: 2005 General Requirements) for the Competence of Testing and Calibration Laboratories. Date of Registration: Dec. 11, 2015. Valid time is until Dec. 10, 2024.

3.3 Environmental conditions

During the measurement the environmental conditions were within the listed ranges:

| | |
|-----------------------|--------------|
| Temperature: | 15-35 ° C |
| Humidity: | 30-60 % |
| Atmospheric pressure: | 950-1050mbar |

(1) expressed at approximately the 95% confidence level using a coverage factor of k=1.96.

3.4 Test Description

3.4.1 Cellular Band (824-849MHz paired with 869-894MHz)

| Test Item | FCC Rule No. | Requirements | Verdict |
|--|---------------------|---|---------|
| Effective(Isotropic) Radiated Output Power | §2.1046, §22.913 | FCC: ERP ≤ 7W. | Pass |
| Modulation Characteristics | §2.1047 | Digital modulation | N/A |
| Bandwidth | §2.1049 | OBW: No limit. EBW: No limit. | Pass |
| Band Edges Compliance | §2.1051, §22.917 | ≤-13dBm/1%*EBW, in 1MHz bands immediately outside and adjacent to The frequency block. | Pass |
| Spurious Emission at Antenna Terminals | §2.1051, §22.917 | FCC: ≤ -13dBm/100kHz, from 9kHz to 10th harmonics but outside authorized operating frequency ranges. | Pass |
| Field Strength of Spurious Radiation | §2.1053, §22.917 | FCC: ≤ -13dBm/100kHz. | Pass |
| Frequency Stability | §2.1055, §22.355 | ≤ ±2.5ppm. | Pass |

NOTE 1: For the verdict, the "N/A" denotes "not applicable", the "N/T" de notes "not tested".

3.4.2 PCS Band (1850-1915MHz paired with 1930-1995MHz)

| Test Item | FCC Rule No. | Requirements | Verdict |
|--|---------------------|---|---------|
| Effective(Isotropic) Radiated Output Power | §2.1046, §24.232 | EIRP ≤ 2W | Pass |
| Peak-Average Ratio | §2.1046, §24.232 | FCC: Limits ≤ 13dB | Pass |
| Modulation Characteristics | §2.1047 | Digital modulation | N/A |
| Bandwidth | §2.1049 | OBW: No limit. EBW: No limit. | Pass |
| Band Edges Compliance | §2.1051, §24.238 | ≤ -13dBm/1%*EBW, In 1MHz bands immediately outside and adjacent to The frequency block. | Pass |
| Spurious Emission at Antenna Terminals | §2.1051, §24.238 | ≤-13dBm/1MHz, from 9kHz to 10th harmonics but outside authorized Operating frequency ranges. | Pass |
| Field Strength of Spurious Radiation | §2.1053, §24.238 | ≤ -13dBm/1MHz. | Pass |
| Frequency Stability | §2.1055, §24.235 | FCC: within authorized frequency block. | Pass |

NOTE 1: For the verdict, the "N/A" denotes "not applicable", the "N/T" de notes "not tested".

Remark: 1. The measurement uncertainty is not included in the test result.

3.5 Equipments Used during the Test

| Test Equipment | Manufacturer | Model No. | Serial No. | Calibration Date | Calibration Due Date |
|----------------------------|----------------|-----------------------|--------------|------------------|----------------------|
| LISN | R&S | ENV216 | 3560.6550.08 | 2018/09/20 | 2019/09/19 |
| LISN | R&S | ESH2-Z5 | 893606/008 | 2018/09/20 | 2019/09/19 |
| Bilog Antenna | Schwarzbeck | VULB9163 | 976 | 2016/09/20 | 2019/09/19 |
| Bilog Antenna | Schwarzbeck | VULB9163 | 979 | 2016/09/20 | 2019/09/19 |
| EMI Test Receiver | R&S | ESCI7 | 101102 | 2018/09/20 | 2019/09/19 |
| Spectrum Analyzer | Agilent | N9020A | MY48010425 | 2018/09/20 | 2019/09/19 |
| Spectrum Analyzer | R&S | FSP40 | 100019 | 2018/06/05 | 2019/06/04 |
| Controller | EM Electronics | Controller EM 1000 | N/A | N/A | N/A |
| Horn Antenna | Schwarzbeck | BBHA 9120D | 01622 | 2016/09/20 | 2019/09/19 |
| Horn Antenna | Schwarzbeck | BBHA 9120D | 01652 | 2016/09/20 | 2019/09/19 |
| Active Loop Antenna | SCHWARZBEC K | FMZB1519 | 1519-037 | 2016/09/20 | 2019/09/19 |
| Broadband Horn Antenna | SCHWARZBEC K | BBHA 9170 | 971 | 2016/09/20 | 2019/09/19 |
| Amplifier | Schwarzbeck | BBV 9743 | #202 | 2018/09/20 | 2019/09/19 |
| Amplifier | EMCI | EMC051845B | 980355 | 2018/09/20 | 2019/09/19 |
| Temperature/Humidity Meter | Gangxing | CTH-608 | 02 | 2018/09/20 | 2019/09/19 |
| High-Pass Filter | K&L | 9SH10-2700/X12750-O/O | KL142031 | 2018/09/20 | 2019/09/19 |
| High-Pass Filter | K&L | 41H10-1375/U12750-O/O | KL142032 | 2018/09/20 | 2019/09/19 |
| RF Cable(below 1GHz) | HUBER+SUHNER | RG214 | RE01 | 2018/09/20 | 2019/09/19 |
| RF Cable(above 1GHz) | HUBER+SUHNER | RG214 | RE02 | 2018/09/20 | 2019/09/19 |
| Data acquisition card | Agilent | U2531A | TW53323507 | 2018/09/20 | 2019/09/19 |
| Power Sensor | Agilent | U2021XA | MY5365004 | 2018/09/20 | 2019/09/19 |
| EMI Test Software | R&S | ES-K1 | V1.7.1 | 2018/09/20 | 2019/09/19 |
| EMI Test Software | JS Tonscend | JS32-RE | 2.0.1.5 | 2018/09/20 | 2019/09/19 |
| EMI Test Software | Audix | E3 | 2..1.1 | 2018/09/20 | 2019/09/19 |

Note: The Cal.Interval was one year.

4 TEST CONDITIONS AND RESULTS

4.1 Output Power

TEST APPLICABLE

During the process of testing, the EUT was controlled via R&S Digital Radio Communication tester (CMU200) to ensure max power transmission and proper modulation. This result contains output power and EIRP measurements for the EUT. In all cases, output power is within the specified limits.

4.1.1 Conducted Output Power

TEST CONFIGURATION

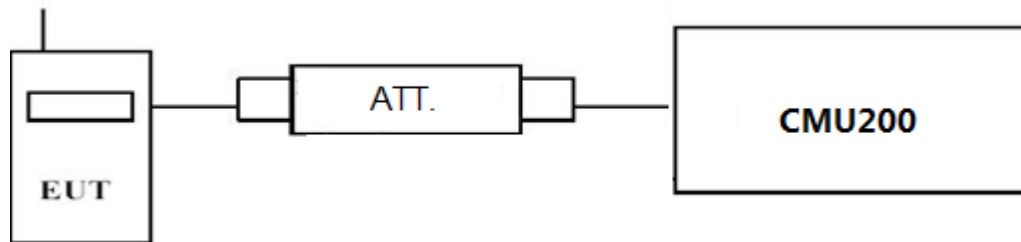

TEST PROCEDURE

Conducted Power Measurement:

- a) Place the EUT on a bench and set it in transmitting mode.
- b) Connect a low loss RF cable from the antenna port to a CMU200 by an Att.
- c) EUT Communicate with CMU200 then selects a channel for testing.
- d) Add a correction factor to the display CMU200, and then test.

TEST RESULTS

| Test Mode | Test Channel | Burst Average Conducted power (dBm) | |
|-----------|---------------|-------------------------------------|--------------|
| | | UMTS Band V | UMTS Band II |
| UMTS/TM1 | LCH | 22.61 | 22.73 |
| | MCH | 22.93 | 23.16 |
| | HCH | 22.94 | 22.80 |
| UMTS/TM2 | LCH_SubTest-1 | 22.18 | 22.35 |
| | LCH_SubTest-2 | 22.16 | 22.46 |
| | LCH_SubTest-3 | 22.27 | 22.39 |
| | LCH_SubTest-4 | 21.22 | 21.47 |
| | MCH_SubTest-1 | 22.53 | 22.51 |
| | MCH_SubTest-2 | 21.61 | 21.86 |
| | MCH_SubTest-3 | 21.55 | 21.75 |
| | MCH_SubTest-4 | 21.70 | 22.03 |
| | HCH_SubTest-1 | 22.53 | 22.09 |
| | HCH_SubTest-2 | 22.45 | 22.30 |
| | HCH_SubTest-3 | 22.63 | 22.53 |
| | HCH_SubTest-4 | 21.51 | 21.31 |
| UMTS/TM3 | LCH_SubTest-1 | 20.75 | 20.29 |
| | LCH_SubTest-2 | 20.41 | 20.38 |
| | LCH_SubTest-3 | 21.33 | 21.17 |
| | LCH_SubTest-4 | 20.48 | 20.19 |
| | LCH_SubTest-5 | 19.98 | 20.32 |
| | MCH_SubTest-1 | 21.25 | 21.63 |
| | MCH_SubTest-2 | 20.28 | 20.61 |
| | MCH_SubTest-3 | 21.33 | 21.68 |
| | MCH_SubTest-4 | 20.17 | 20.53 |
| | MCH_SubTest-5 | 21.33 | 21.71 |
| | HCH_SubTest-1 | 20.21 | 20.35 |
| | HCH_SubTest-2 | 20.42 | 20.23 |
| | HCH_SubTest-3 | 21.71 | 21.22 |
| | HCH_SubTest-4 | 20.32 | 20.35 |
| | HCH_SubTest-5 | 20.26 | 20.27 |

4.1.2 Radiated Output Power

TEST DESCRIPTION

This is the test for the maximum radiated power from the EUT.

Rule Part 24.232(c) specifies, "Mobile/portable stations are limited to 2 watts e.i.r.p. Peak power" and 24.232(e) specifies that "Peak transmit power must be measured over any interval of continuous transmission using instrumentation calibrated in terms of an rms-equivalent voltage." Rule Part 22.913(a) specifies "The ERP of mobile transmitters and auxiliary test transmitters must not exceed 7 Watts."

TEST CONFIGURATION

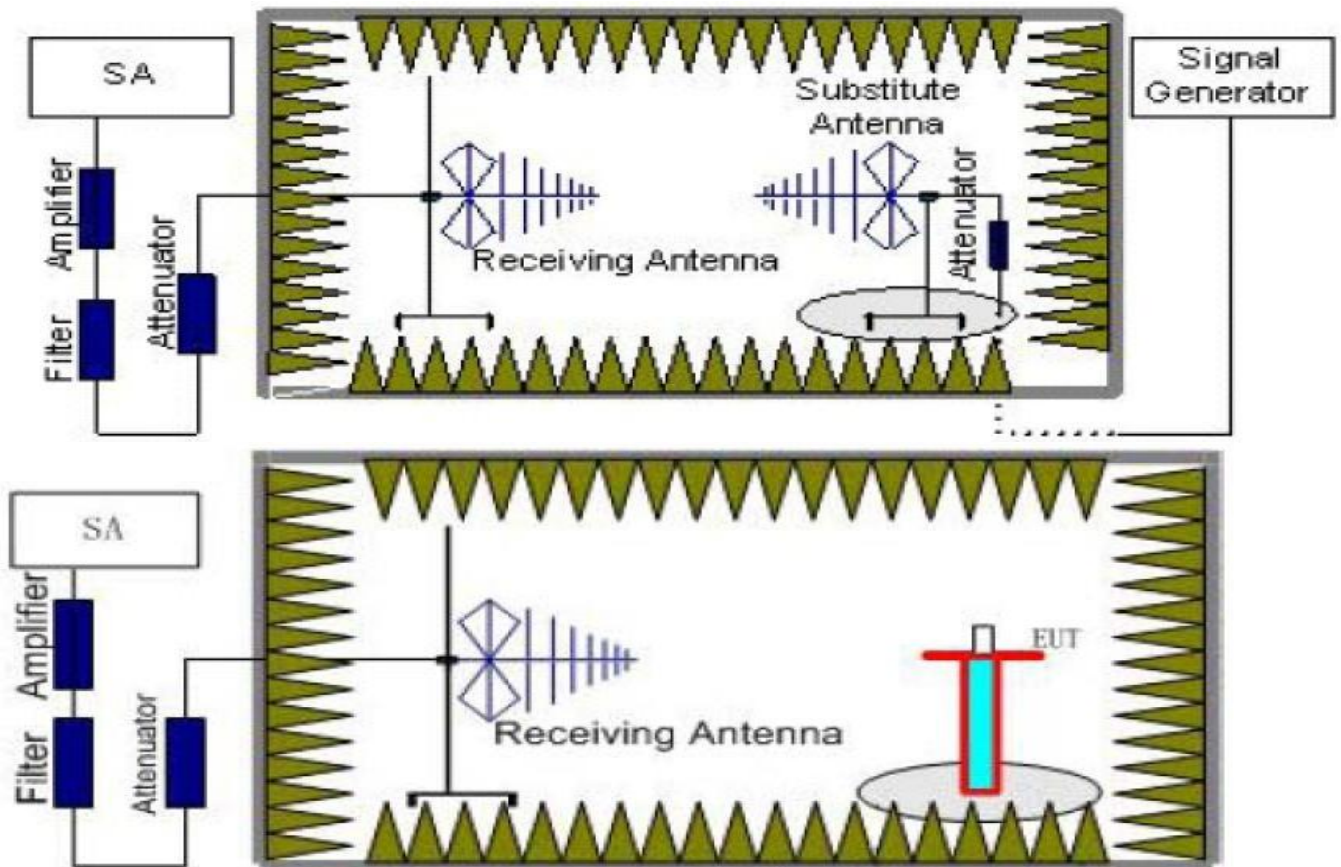

TEST PROCEDURE

1. EUT was placed on a 1.50 meter high non-conductive stand at a 3 meter test distance from the receive antenna. A receiving antenna was placed on the antenna mast 3 meters from the EUT for emission measurements. The height of receiving antenna is 1.50m. Detected emissions were maximized at each frequency by rotating the EUT through 360° and adjusting the receiving antenna polarization. The radiated emission measurements of all transmit frequencies in three channels (High, Middle, Low) were measured with peak detector.
2. A log-periodic antenna or double-ridged waveguide horn antenna shall be substituted in place of the EUT. The log-periodic antenna will be driven by a signal generator and the level will be adjusted till the same power value on the spectrum analyzer or receiver. The level of the spurious emissions can be calculated through the level of the signal generator, cable loss, the gain of the substitution antenna and the reading of the spectrum analyzer or receiver.
3. The EUT is then put into continuously transmitting mode at its maximum power level during the test. Set Test Receiver or Spectrum RBW=10MHz, VBW=10MHz, And the maximum value of the receiver should be recorded as (P_r).
4. The EUT shall be replaced by a substitution antenna. In the chamber, an substitution antenna for the frequency band of interest is placed at the reference point of the chamber. An RF Signal source for the frequency band of interest is connected to the substitution antenna with a cable that has been constructed to not interfere with the radiation pattern of the antenna. A power (P_{Mea}) is applied to the input of the substitution antenna, and adjust the level of the signal generator output until the value of the receiver

reach the previously recorded (P_r). The power of signal source (P_{Mea}) is recorded. The test should be performed by rotating the test item and adjusting the receiving antenna polarization.

5. A amplifier should be connected to the Signal Source output port. And the cable should be connect between the Amplifier and the Substitution Antenna. The cable loss (P_{cl}), the Substitution Antenna Gain (G_a) and the Amplifier Gain (P_{Ag}) should be recorded after test.

The measurement results are obtained as described below:

$$\text{Power(EIRP)} = P_{Mea} - P_{cl} + G_a$$

We used SMF100A microwave signal generator which signal level can up to 33dBm,so we not used power Amplifier for substitution test; The measurement results are amend as described below:

$$\text{Power(EIRP)} = P_{Mea} - P_{cl} + G_a$$

6. This value is EIRP since the measurement is calibrated using an antenna of known gain (2.15 dBi) and known input power.
7. ERP can be calculated from EIRP by subtracting the gain of the dipole, $ERP = EIRP - 2.15\text{dBi}$.

TEST LIMIT

According to 22.913(a), 24.232(c) the ERP(EIRP) should be not exceeding following table limits:

| | |
|-------------|--------------------------|
| | Burst Average ERP |
| UMTS Band V | 38.45dBm (7W) |

TEST RESULTS

Remark:

1. We were tested all Configuration refer 3GPP TS134 121.
2. $EIRP = P_{Mea}(\text{dBm}) - P_{cl}(\text{dB}) + P_{Ag}(\text{dB}) + G_a(\text{dBi})$
3. $ERP = EIRP - 2.15\text{dBi}$ as EIRP by subtracting the gain of the dipole.
4. Note: We test the H direction and V direction, V direction is worse.

UMTS/TM1/UMTS Band II

| Frequency (MHz) | P_{Mea} (dBm) | P_{cl} (dB) | G_a Antenna Gain (dB) | P_{Ag} (dB) | Burst Average EIRP (dBm) | Limit (dBm) | Margin (dB) | Polarization |
|-----------------|-----------------|---------------|-------------------------|---------------|--------------------------|-------------|-------------|--------------|
| 1852.4 | -19.31 | 3.41 | 10.24 | 33.60 | 21.12 | 33.01 | 11.89 | V |
| 1880.0 | -18.24 | 3.49 | 10.24 | 33.60 | 22.11 | 33.01 | 10.90 | V |
| 1907.6 | -19.00 | 3.55 | 10.23 | 33.60 | 21.28 | 33.01 | 11.73 | V |

UMTS/TM1/UMTS Band V

| Frequency (MHz) | P_{Mea} (dBm) | P_{cl} (dB) | G_a Antenna Gain (dB) | Correction (dB) | P_{Ag} (dB) | Burst Average ERP (dBm) | Limit (dBm) | Margin (dB) | Polarization |
|-----------------|-----------------|---------------|-------------------------|-----------------|---------------|-------------------------|-------------|-------------|--------------|
| 826.40 | -18.84 | 2.42 | 8.45 | 2.15 | 36.82 | 21.86 | 38.45 | 16.59 | V |
| 836.60 | -18.25 | 2.46 | 8.45 | 2.15 | 36.82 | 22.41 | 38.45 | 16.04 | V |
| 846.60 | -18.83 | 2.53 | 8.36 | 2.15 | 36.82 | 21.67 | 38.45 | 16.78 | V |

4.2 Radiated Spurious Emission

TEST APPLICABLE

According to the TIA/EIA 603D:2010 test method, The Receiver or Spectrum was scanned from 9 KHz to the 10th harmonic of the highest frequency generated within the equipment, which is the transmitted carrier that can be as high as 1910 MHz The resolution bandwidth is set as outlined in Part 24.238, Part 22.917. The spectrum is scanned with the mobile station transmitting at carrier frequencies that pertain to low, mid and high channels of WCDMA Band II and WCDMA Band V.

TEST CONFIGURATION

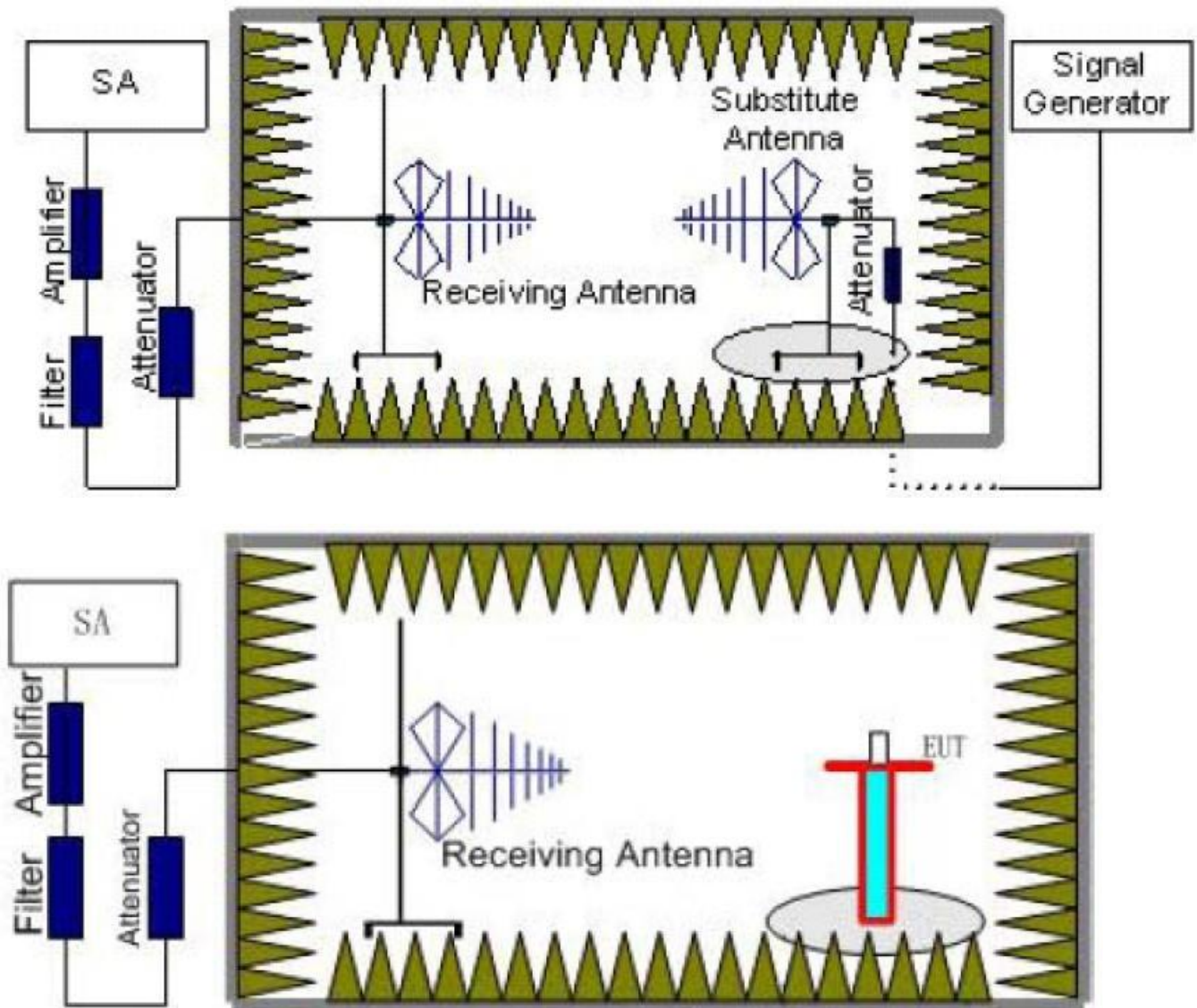

TEST PROCEDURE

1. EUT was placed on a 1.50 meter high non-conductive stand at a 3 meter test distance from the receive antenna. A receiving antenna was placed on the antenna mast 3 meters from the EUT for emission measurements. The height of receiving antenna is 1.50m. Detected emissions were maximized at each frequency by rotating the EUT through 360° and adjusting the receiving antenna polarization. The radiated emission measurements of all transmit frequencies in three channels (High, Middle, Low) were measured with peak detector.
2. A log-periodic antenna or double-ridged waveguide horn antenna shall be substituted in place of the EUT. The log-periodic antenna will be driven by a signal generator and the level will be adjusted till the same power value on the spectrum analyzer or receiver. The level of the spurious emissions can be calculated through the level of the signal generator, cable loss, the gain of the substitution antenna and the reading of the spectrum analyzer or receiver.

3. The EUT is then put into continuously transmitting mode at its maximum power level during the test. Set Test Receiver or Spectrum RBW=1MHz, VBW=3MHz, And the maximum value of the receiver should be recorded as (P_r).
4. The EUT shall be replaced by a substitution antenna. In the chamber, an substitution antenna for the frequency band of interest is placed at the reference point of the chamber. An RF Signal source for the frequency band of interest is connected to the substitution antenna with a cable that has been constructed to not interfere with the radiation pattern of the antenna. A power (P_{Mea}) is applied to the input of the substitution antenna, and adjust the level of the signal generator output until the value of the receiver reach the previously recorded (P_r). The power of signal source (P_{Mea}) is recorded. The test should be performed by rotating the test item and adjusting the receiving antenna polarization.
5. A amplifier should be connected to the Signal Source output port. And the cable should be connect between the Amplifier and the Substitution Antenna. The cable loss (P_{cl}), the Substitution Antenna Gain (G_a) and the Amplifier Gain (P_{Ag}) should be recorded after test.
The measurement results are obtained as described below:
Power(EIRP)=P_{Mea}- P_{Ag} - P_{cl} + G_a
6. This value is EIRP since the measurement is calibrated using an antenna of known gain (2.15 dBi) and known input power.
7. ERP can be calculated from EIRP by subtracting the gain of the dipole, ERP = EIRP -2.15dBi.
8. In order to make sure test results more clearly, we set frequency range and sweep time for difference frequency range as follows table:

| Working Frequency | Subrange (GHz) | RBW | VBW | Sweep time (s) |
|----------------------------|----------------|--------|--------|----------------|
| UMTS/TM1/ WCDMA Band V | 0.00009~0.15 | 1KHz | 3KHz | 30 |
| | 0.00015~0.03 | 10KHz | 30KHz | 10 |
| | 0.03~1 | 100KHz | 300KHz | 10 |
| | 1~2 | 1 MHz | 3 MHz | 2 |
| | 2~5 | 1 MHz | 3 MHz | 3 |
| | 5~8 | 1 MHz | 3 MHz | 3 |
| | 8~10 | 1 MHz | 3 MHz | 3 |
| UMTS/TM1/ WCDMA Band II | 0.00009~0.15 | 1KHz | 3KHz | 30 |
| | 0.00015~0.03 | 10KHz | 30KHz | 10 |
| | 0.03~1 | 100KHz | 300KHz | 10 |
| | 1~2 | 1 MHz | 3 MHz | 2 |
| | 2~5 | 1 MHz | 3 MHz | 3 |
| | 5~8 | 1 MHz | 3 MHz | 3 |
| | 8~11 | 1 MHz | 3 MHz | 3 |
| | 11~14 | 1 MHz | 3 MHz | 3 |
| | 14~18 | 1 MHz | 3 MHz | 3 |
| | 18~20 | 1 MHz | 3 MHz | 2 |

TEST LIMITS

According to 24.238, 22.917 specify that the power of any emission outside of the authorized operating frequency ranges must be attenuated below the transmitting power (P) by a factor of at least 43 + 10 log(P) dB.

The specification that emissions shall be attenuated below the transmitter power (P) by at least 43 + 10 log (P) dB, translates in the relevant power range (1 to 0.001 W) to -13 dBm. At 1 W the specified minimum attenuation becomes 43 dB and relative to a 30 dBm (1 W) carrier becomes a limit of -13 dBm. At 0.001 W (0 dBm) the minimum attenuation is 13 dB, which again yields a limit of -13 dBm. In this way a translation of the specification from relative to absolute terms is carried out.

| Frequency | Channel | Frequency Range | Verdict |
|-------------------------------|---------|-----------------|---------|
| UMTS/TM1/ WCDMA Band V | Low | 9KHz-10GHz | PASS |
| | Middle | 9KHz -10GHz | PASS |
| | High | 9KHz -10GHz | PASS |
| UMTS/TM1/ WCDMA Band II | Low | 9KHz -20GHz | PASS |
| | Middle | 9KHz -20GHz | PASS |
| | High | 9KHz -20GHz | PASS |

TEST RESULTS

Remark:

1. We were tested all Configuration refer 3GPP TS134 121.
2. $EIRP = P_{Mea}(dBm) - P_{cl}(dB) + P_{Ag}(dB) + G_a(dBi)$
3. $ERP = EIRP - 2.15dBi$ as EIRP by subtracting the gain of the dipole.
5. Margin = Limit – Emission Level
6. We test both H direction and V direction, recorded worst case direction.

UMTS/TM1/ WCDMA Band II _ Low Channel

| Frequency (MHz) | P _{Mea} (dBm) | P _{cl} (dB) | Diatance | G _a Antenna Gain(dB) | Peak EIRP (dBm) | Limit (dBm) | Margin (dB) | Polarization |
|-----------------|------------------------|----------------------|----------|---------------------------------|-----------------|-------------|-------------|--------------|
| 3704.8 | -42.30 | 4.39 | 3.00 | 12.34 | -34.35 | -13.00 | 21.35 | H |
| 5557.2 | -44.90 | 5.31 | 3.00 | 13.52 | -36.69 | -13.00 | 23.69 | H |
| 3704.8 | -40.16 | 4.39 | 3.00 | 12.34 | -32.21 | -13.00 | 19.21 | V |
| 5557.2 | -45.46 | 5.31 | 3.00 | 13.52 | -37.25 | -13.00 | 24.25 | V |

UMTS/TM1/ WCDMA Band II _ Middle Channel

| Frequency (MHz) | P _{Mea} (dBm) | P _{cl} (dB) | Diatance | G _a Antenna Gain(dB) | Peak EIRP (dBm) | Limit (dBm) | Margin (dB) | Polarization |
|-----------------|------------------------|----------------------|----------|---------------------------------|-----------------|-------------|-------------|--------------|
| 3760.0 | -41.29 | 4.41 | 3.00 | 12.34 | -33.36 | -13.00 | 20.36 | H |
| 5640.0 | -46.57 | 5.38 | 3.00 | 13.58 | -38.37 | -13.00 | 25.37 | H |
| 3760.0 | -39.75 | 4.41 | 3.00 | 12.34 | -31.82 | -13.00 | 18.82 | V |
| 5640.0 | -46.49 | 5.38 | 3.00 | 13.58 | -38.29 | -13.00 | 25.29 | V |

UMTS/TM1/ WCDMA Band II _ High Channel

| Frequency (MHz) | P _{Mea} (dBm) | P _{cl} (dB) | Diatance | G _a Antenna Gain(dB) | Peak EIRP (dBm) | Limit (dBm) | Margin (dB) | Polarization |
|-----------------|------------------------|----------------------|----------|---------------------------------|-----------------|-------------|-------------|--------------|
| 3815.2 | -40.33 | 4.45 | 3.00 | 12.45 | -32.33 | -13.00 | 19.33 | H |
| 5722.8 | -47.30 | 5.47 | 3.00 | 13.66 | -39.11 | -13.00 | 26.11 | H |
| 3815.2 | -39.23 | 4.45 | 3.00 | 12.45 | -31.23 | -13.00 | 18.23 | V |
| 5722.8 | -46.16 | 5.48 | 3.00 | 13.66 | -37.98 | -13.00 | 24.98 | V |

UMTS/TM1/ WCDMA Band V _ Low Channel

| Frequency (MHz) | P _{Mea} (dBm) | P _{cl} (dB) | Diatance | G _a Antenna Gain(dB) | Peak EIRP (dBm) | Limit (dBm) | Margin (dB) | Polarization |
|-----------------|------------------------|----------------------|----------|---------------------------------|-----------------|-------------|-------------|--------------|
| 1652.8 | -38.62 | 3.00 | 3.00 | 9.58 | -32.04 | -13.00 | 19.04 | H |
| 2479.2 | -43.74 | 3.03 | 3.00 | 10.72 | -36.05 | -13.00 | 23.05 | H |
| 1652.8 | -36.22 | 3.00 | 3.00 | 9.68 | -29.54 | -13.00 | 16.54 | V |
| 2479.2 | -39.8 | 3.03 | 3.00 | 10.72 | -32.11 | -13.00 | 19.11 | V |

UMTS/TM1/ WCDMA Band V _ Middle Channel

| Frequency (MHz) | P _{Mea} (dBm) | P _{cl} (dB) | Diatance | G _a Antenna Gain(dB) | Peak EIRP (dBm) | Limit (dBm) | Margin (dB) | Polarization |
|-----------------|------------------------|----------------------|----------|---------------------------------|-----------------|-------------|-------------|--------------|
| 1672.8 | -37.78 | 3.00 | 3.00 | 9.58 | -31.20 | -13.00 | 18.20 | H |
| 2509.2 | -42.67 | 3.03 | 3.00 | 10.72 | -34.98 | -13.00 | 21.98 | H |
| 1672.8 | -35.75 | 3.00 | 3.00 | 9.68 | -29.07 | -13.00 | 16.07 | V |
| 2509.2 | -40.34 | 3.03 | 3.00 | 10.72 | -32.65 | -13.00 | 19.65 | V |

UMTS/TM1/ WCDMA Band V _ High Channel

| Frequency (MHz) | P _{Mea} (dBm) | P _{cl} (dB) | Diatance | G _a Antenna Gain(dB) | Peak EIRP (dBm) | Limit (dBm) | Margin (dB) | Polarization |
|-----------------|------------------------|----------------------|----------|---------------------------------|-----------------|-------------|-------------|--------------|
| 1693.2 | -37.43 | 3.00 | 3.00 | 9.58 | -30.85 | -13.00 | 17.85 | H |
| 2539.8 | -41.46 | 3.03 | 3.00 | 10.72 | -33.77 | -13.00 | 20.77 | H |
| 1693.2 | -36.84 | 3.00 | 3.00 | 9.68 | -30.16 | -13.00 | 17.16 | V |
| 2539.8 | -39.30 | 3.03 | 3.00 | 10.72 | -31.61 | -13.00 | 18.61 | V |

4.3 Occupied Bandwidth and Emission Bandwidth

TEST APPLICABLE

Similar to conducted emissions; occupied bandwidth measurements are only provided for selected frequencies in order to reduce the amount of submitted data. Data were taken at the extreme and mid frequencies of WCDMA Band II and WCDMA band V. The table below lists the measured 99% Bandwidth and -26dBc Bandwidth.

TEST CONFIGURATION

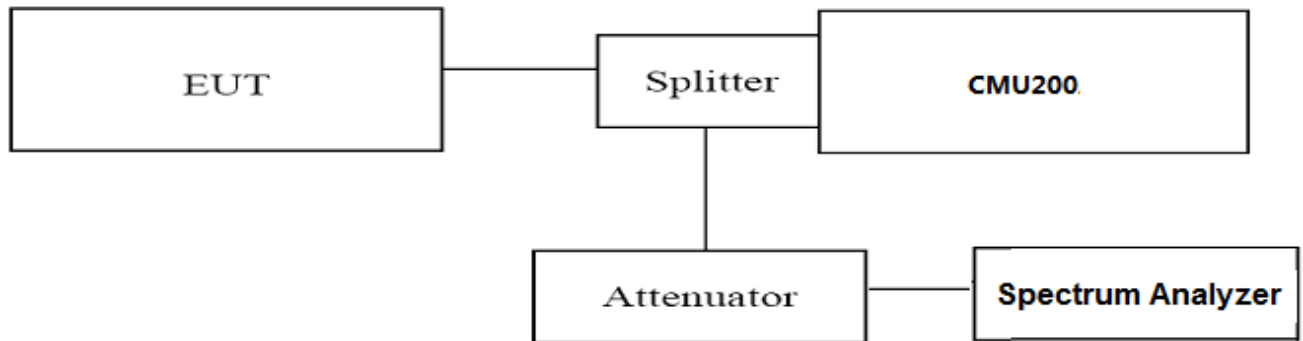

TEST PROCEDURE

1. The EUT was set up for the max output power with pseudo random data modulation;
2. Set RBW=100KHz,VBW=300KHz,Span=10MHz, SWT=Auto;
3. Set SPA Max hold and View, Set 99% Occupied Bandwidth/ Set -26dBc Occupied Bandwidth
4. These measurements were done at 3 frequencies for WCDMA band II /V. (low, middle and high of operational frequency range).

TEST RESULTS

| Test Mode | Channel | Frequency (MHz) | Occupied Bandwidth (99% BW) (MHz) | Emission Bandwidth (-26 dBc BW) (MHz) | Verdict |
|----------------------------|---------|-----------------|------------------------------------|--|---------|
| UMTS/TM1/ WCDMA Band V | 4132 | 826.40 | 4.1569 | 4.639 | PASS |
| | 4183 | 836.40 | 4.1664 | 4.631 | PASS |
| | 4233 | 846.60 | 4.1564 | 4.649 | PASS |
| UMTS/TM1/ WCDMA Band II | 9262 | 1852.4 | 4.1434 | 4.651 | PASS |
| | 9400 | 1880.0 | 4.1718 | 4.639 | PASS |
| | 9538 | 1907.6 | 4.1536 | 4.626 | PASS |

Remark:

1. Test results including cable loss;
2. please refer to following plots;

Occupied Bandwidth and Emission Bandwidth

UMTS/TM1/ WCDMA Band V

UMTS/TM1/ WCDMA Band II

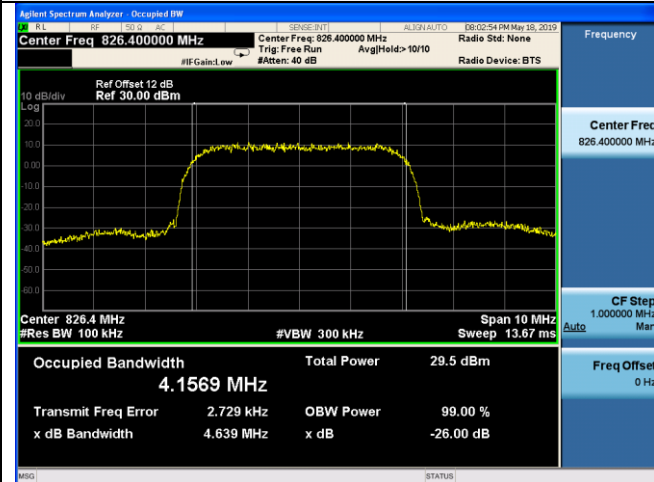

Channel 4132 / 826.4 MHz

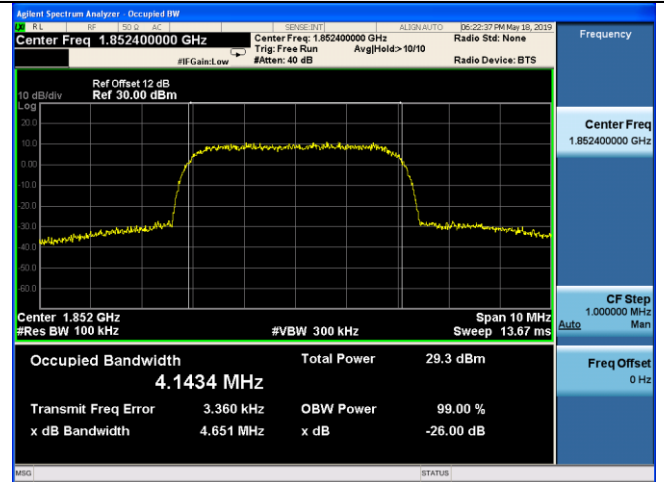

Channel 9262 / 1852.4 MHz

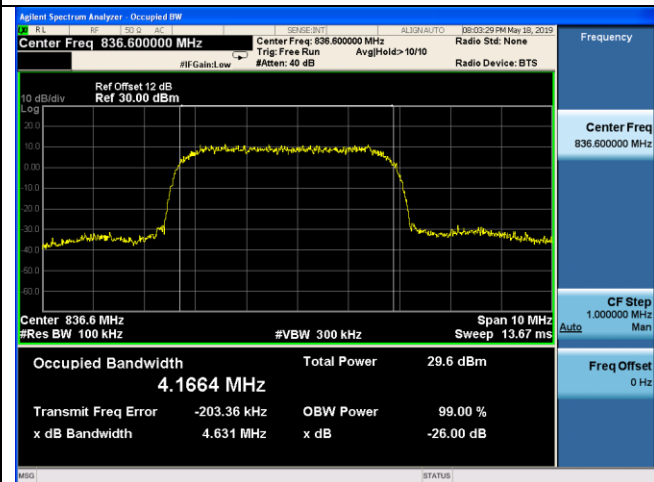

Channel 4183 / 836.4 MHz

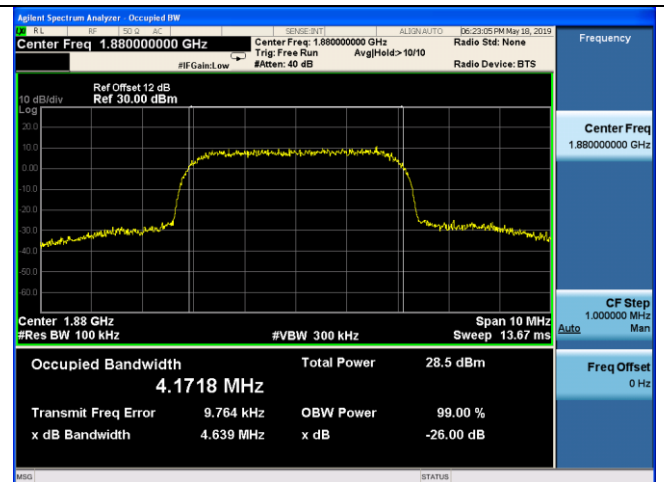

Channel 9400 / 1880.0 MHz

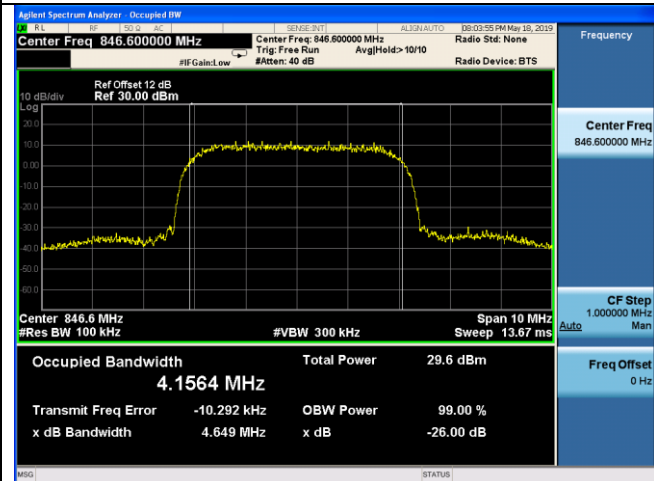

Channel 4233 / 846.6 MHz

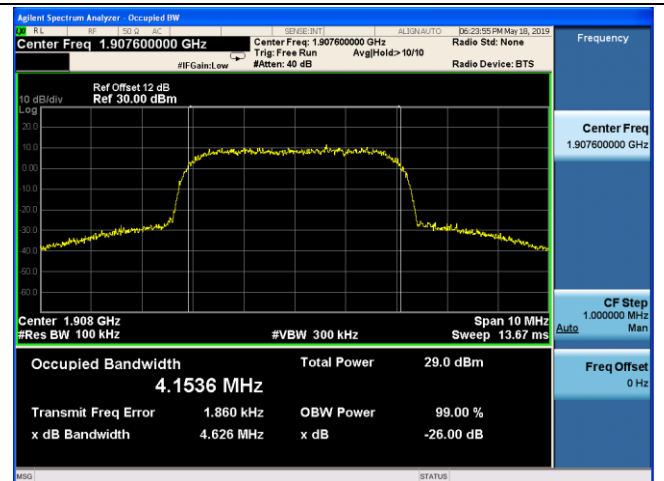

Channel 9538 / 1907.6 MHz

4.4 Band Edge Compliance

TEST APPLICABLE

During the process of testing, the EUT was controlled via Aglient Digital Radio Communication tester (CMU200) to ensure max power transmission and proper modulation.

TEST CONFIGURATION

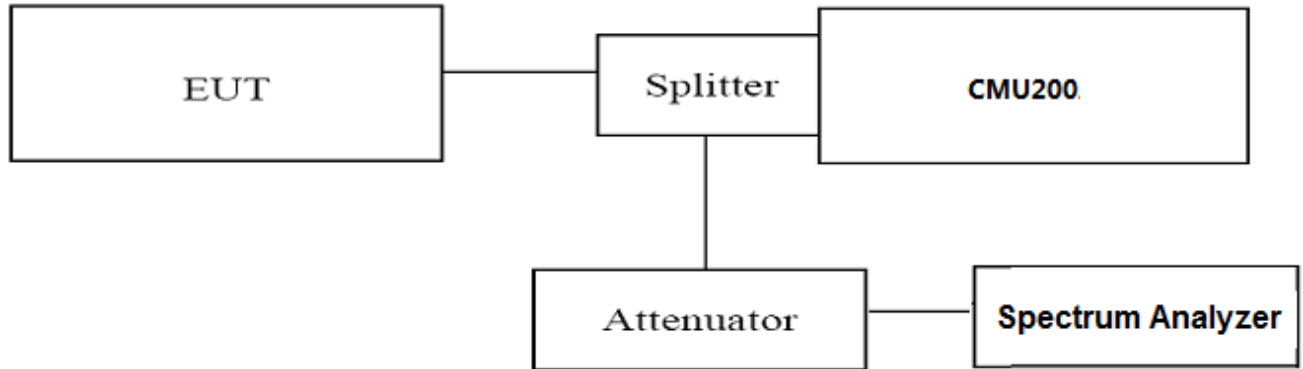

TEST PROCEDURE

1. The EUT was set up for the max output power with pseudo random data modulation;
2. Set RBW=30KHz,VBW=100KHz,Span=2MHz ,Dector: RMS;
3. These measurements were done at 2 frequencies (low and high of operational frequency range).

TEST RESULTS

| UMTS/TM1/WCDMA Band V | | | | | |
|------------------------|---------|-----------------|---------------------------|--------------|---------|
| Test Mode | Channel | Frequency (MHz) | Band Edg Compliance (dBm) | Limits (dBm) | Verdict |
| UMTS/TM1/WCDMA Band V | 4132 | 826.4 | <-13dBm | -13dBm | PASS |
| | 4233 | 846.6 | <-13dBm | -13dBm | |
| UMTS/TM1/WCDMA Band II | | | | | |
| Test Mode | Channel | Frequency (MHz) | Band Edg Compliance (dBm) | Limits (dBm) | Verdict |
| UMTS/TM1/WCDMA Band II | 9262 | 1852.4 | <-13dBm | -13dBm | PASS |
| | 9538 | 1907.6 | <-13dBm | -13dBm | |

Remark:

1. Test results including cable loss;
2. please refer to following plots;

Band-edge Compliance

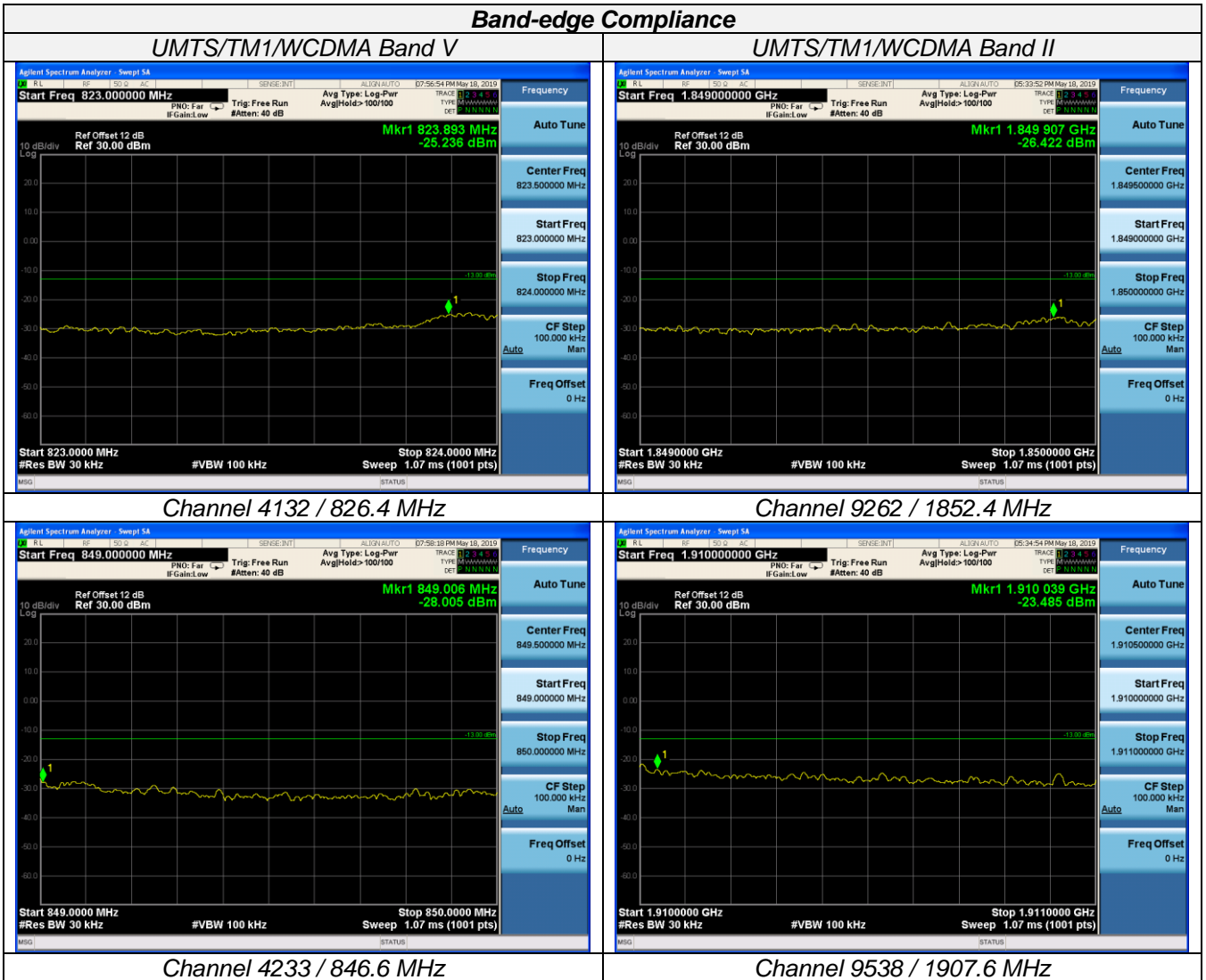

4.5 Spurious Emssion on Antenna Port

TEST APPLICABLE

The following steps outline the procedure used to measure the conducted emissions from the EUT.

1. Determine frequency range for measurements: From CFR 2.1057 the spectrum should be investigated from the lowest radio frequency generated in the equipment up to at least the 10th harmonic of the carrier frequency. For the equipment of WCDMA band II data taken from 9 KHz to 20 GHz. For WCDMA Band V, data taken from 9 KHz to 9 GHz.
2. The sweep time is set automatically by instrument itself. That should be the optimal sweep time for the span and the RBW. If the sweep time is too short, that is sweep is too fast, the sweep result is not accurate; if the sweep time is too long, that is sweep is too low, some frequency components may be lost. The instrument will give an optimal sweep time according the selected span and RBW.
3. The procedure to get the conducted spurious emission is as follows:
The trace mode is set to MaxHold to get the highest signal at each frequency;
Wait 25 seconds; Get the result.
4. Determine EUT transmit frequencies: below outlines the band edge frequencies pertinent to conducted emissions testing.

TEST CONFIGURATION

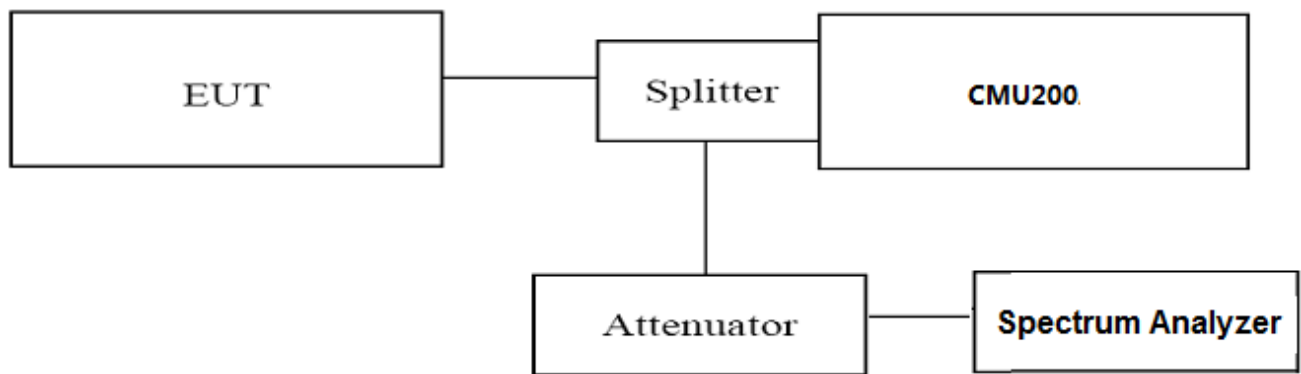

TEST PROCEDURE

1. The EUT was set up for the max output power with pseudo random data modulation;
2. These measurements were done at 3 frequencies (low, middle and high of operational frequency range) of each band.

TEST LIMIT

Part 24.238, Part 22.917 and Part 22.54 specify that the power of any emission outside of the authorized operating frequency ranges must be attenuated below the transmitting power (P) by a factor of at least 43 + 10 log(P) dB.

The specification that emissions shall be attenuated below the transmitter power (P) by at least 43 + 10 log (P) dB, translates in the relevant power range (1 to 0.001 W) to -13 dBm. At 1 W the specified minimum attenuation becomes 43 dB and relative to a 30 dBm (1 W) carrier becomes a limit of -13 dBm. At 0.001 W (0 dBm) the minimum attenuation is 13 dB, which again yields a limit of -13 dBm. In this way a translation of the specification from relative to absolute terms is carried out.

TEST RESULTS

| Test Mode | Channel | Frequency (MHz) | Spurious RF Conducted Emission (dBm) | Limits (dBm) | Verdict |
|------------------------|---------|-----------------|--------------------------------------|--------------|---------|
| UMTS/TM1/WCDMA Band V | 4132 | 826.40 | <-13dBm | -13dBm | PASS |
| | 4183 | 836.40 | <-13dBm | -13dBm | |
| | 4233 | 846.60 | <-13dBm | -13dBm | |
| UMTS/TM1/WCDMA Band II | 9262 | 1852.40 | <-13dBm | -13dBm | PASS |
| | 9400 | 1880.00 | <-13dBm | -13dBm | |
| | 9538 | 1907.60 | <-13dBm | -13dBm | |

Spurious Emission on Antenna Port UMTS/TM1/WCDMA Band V

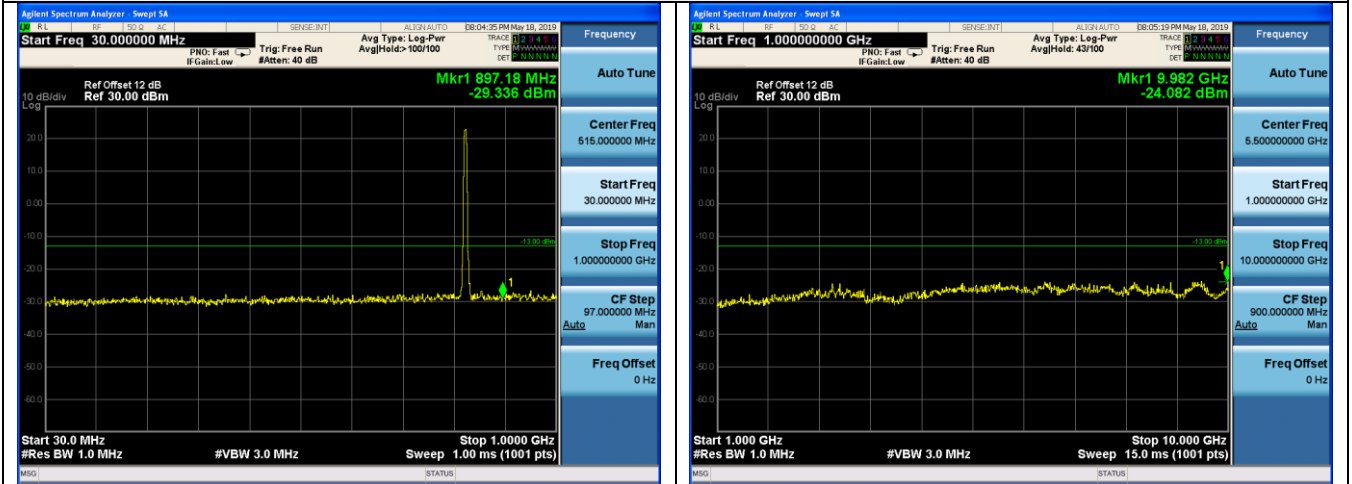

30MHz-1GHz

1GHz-10GHz

Channel 4132 / 826.4 MHz

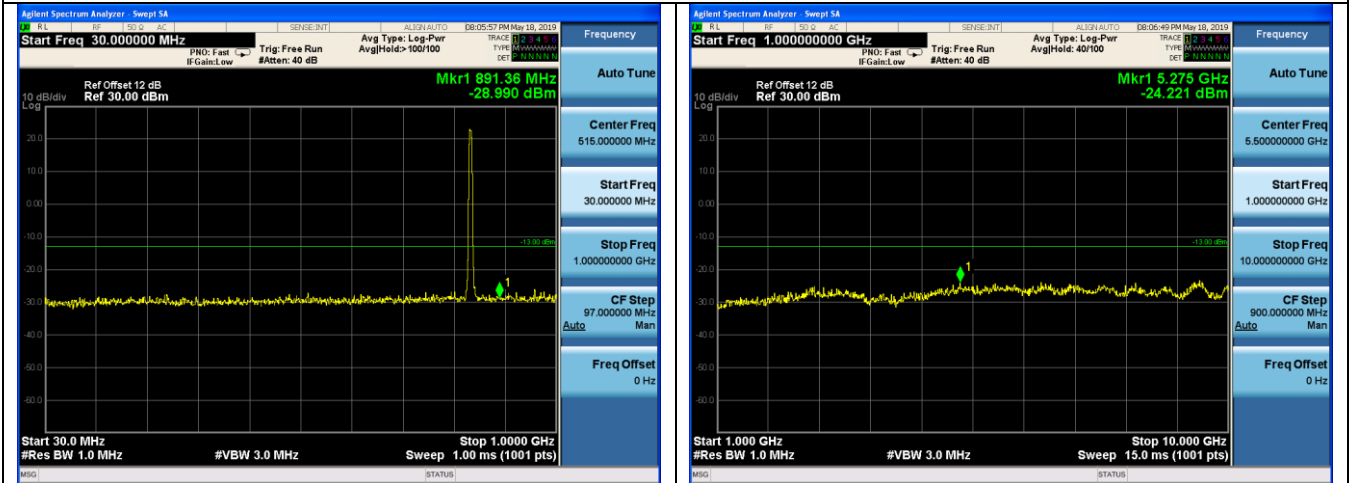

30MHz-1GHz

1GHz-10GHz

Channel 4183 / 836.6 MHz



30MHz-1GHz

1GHz-10GHz

Channel 4233 / 846.6 MHz

Spurious Emission on Antenna Port
UMTS/TM1/WCDMA Band II
Channel 9262 /1852.4 MHz

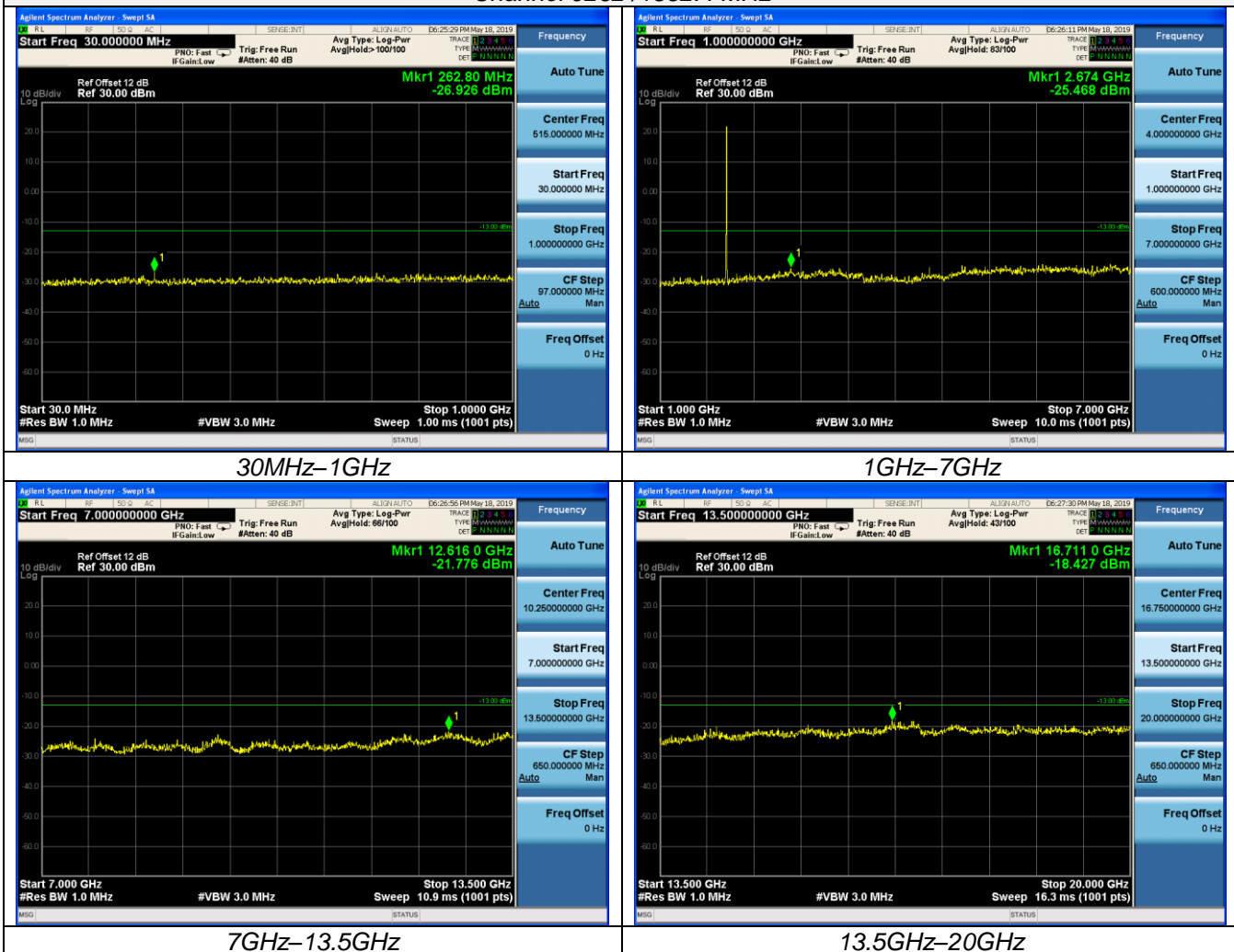

Spurious Emission on Antenna Port
UMTS/TM1/WCDMA Band II
Channel 9400 / 1880.0 MHz

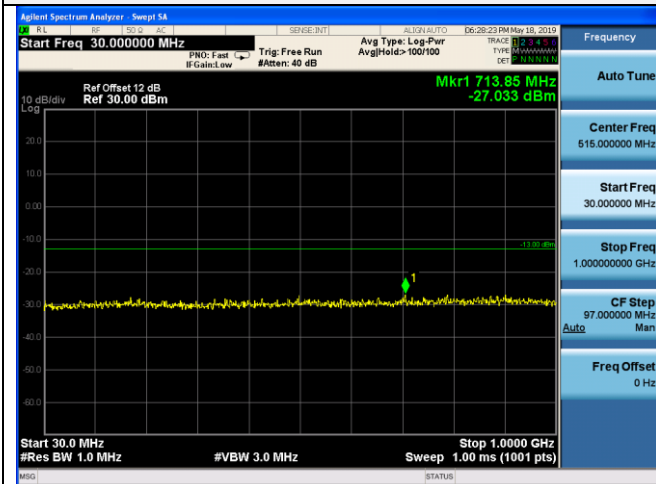

30MHz-1GHz

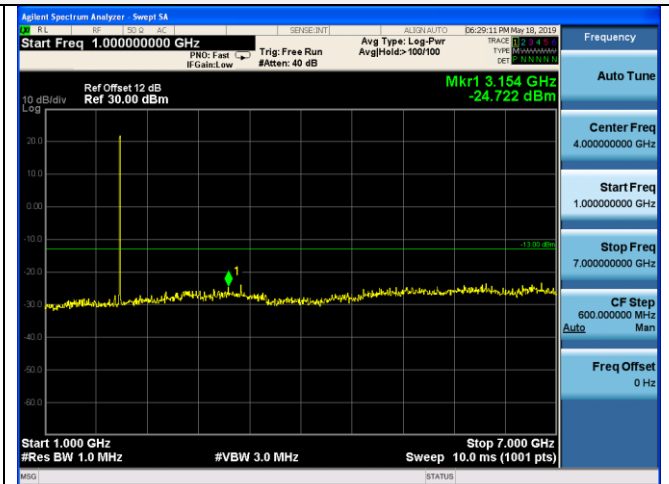

1GHz-7GHz

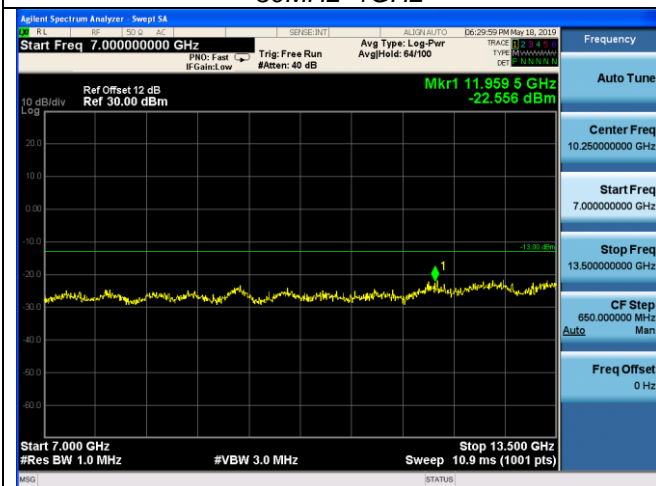

7GHz-13.5GHz

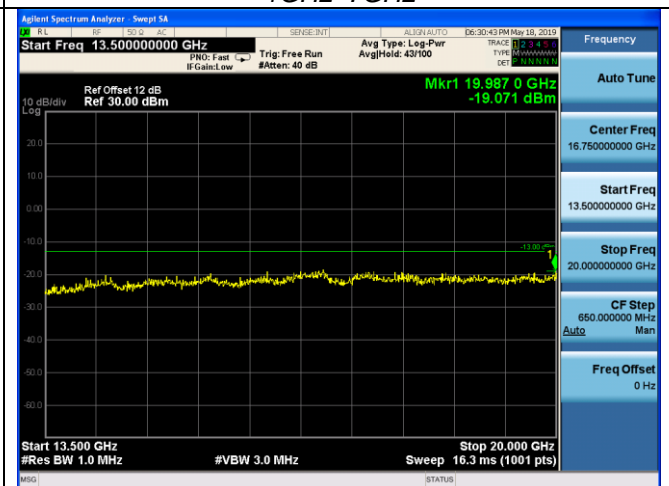

13.5GHz-20GHz

Spurious Emission on Antenna Port
UMTS/TM1/WCDMA Band II
Channel 9538 / 1907.6 MHz

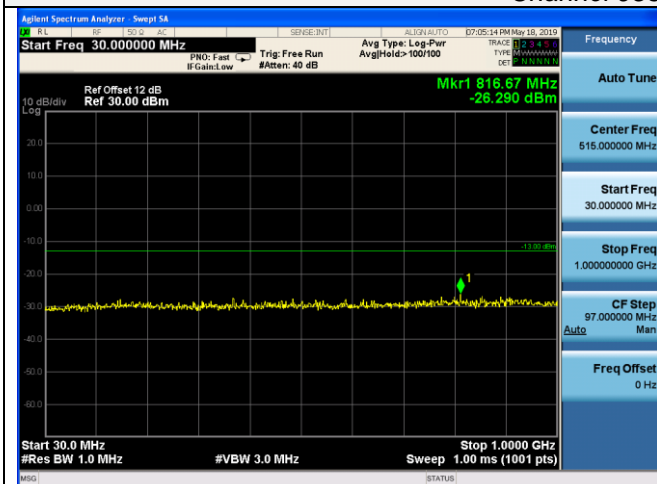

30MHz-1GHz

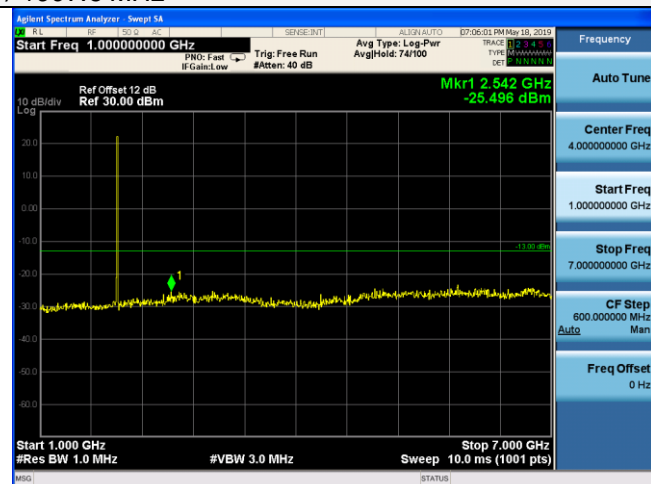

1GHz-7GHz

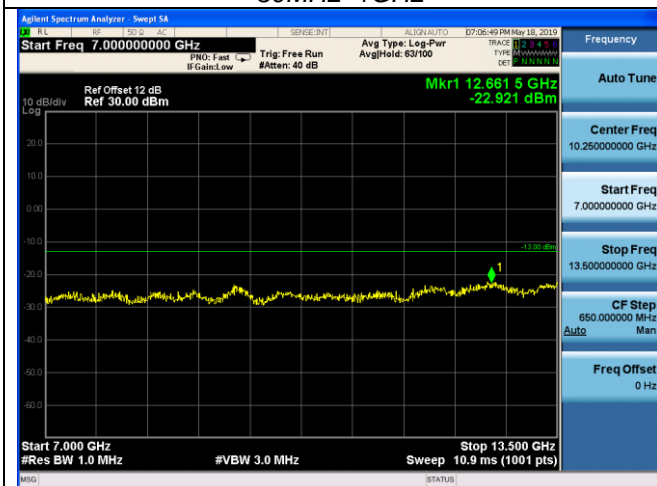

7GHz-13.5GHz

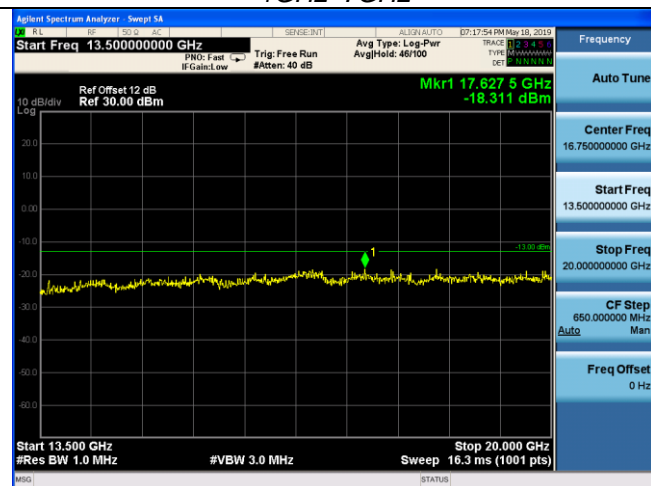

13.5GHz-20GHz

4.6 Frequency Stability Test

TEST APPLICABLE

1. According to FCC Part 2 Section 2.1055 (a)(1), the frequency stability shall be measured with variation of ambient temperature from -30°C to $+50^{\circ}\text{C}$ centigrade.
2. According to FCC Part 2 Section 2.1055 (E) (2), for battery powered equipment, the frequency stability shall be measured with reducing primary supply voltage to the battery operating end point, which is specified by the manufacture.
3. Vary primary supply voltage from 85 to 115 percent of the nominal value for other than hand carried voltage equipment and the end voltage point was 3.40V.

TEST PROCEDURE

In order to measure the carrier frequency under the condition of AFC lock, it is necessary to make measurements with the EUT in a "call mode". This is accomplished with the use of R&S CMU200 DIGITAL RADIO COMMUNICATION TESTER.

1. Measure the carrier frequency at room temperature;
2. Subject the EUT to overnight soak at -30°C ;
3. With the EUT, powered via nominal voltage, connected to the CMU200 and in a simulated call on middle channel of WCDMA Band V, measure the carrier frequency. These measurements should be made within 2 minutes of Powering up the EUT, to prevent significant self-warming;
4. Repeat the above measurements at 10°C increments from -30°C to $+50^{\circ}\text{C}$. Allow at least 0.5 hours at each temperature, unpowered, before making measurements;
5. Remeasure carrier frequency at room temperature with nominal voltage. Vary supply voltage from minimum voltage to maximum voltage, in 0.1Volt increments remeasuring carrier frequency at each voltage. Pause at nominal voltage for 0.5 hours unpowered, to allow any self-heating to stabilize, before continuing;
6. Subject the EUT to overnight soak at $+50^{\circ}\text{C}$;
7. With the EUT, powered via nominal voltage, connected to the CMU200 and in a simulated call on the centre channel, measure the carrier frequency. These measurements should be made within 2 minutes of Powering up the EUT, to prevent significant self-warming;
8. Repeat the above measurements at 10°C increments from $+50^{\circ}\text{C}$ to -30°C . Allow at least 0.5 hours at each temperature, unpowered, before making measurements;
9. At all temperature levels hold the temperature to $\pm 0.5^{\circ}\text{C}$ during the measurement procedure;

TEST CONFIGURATION

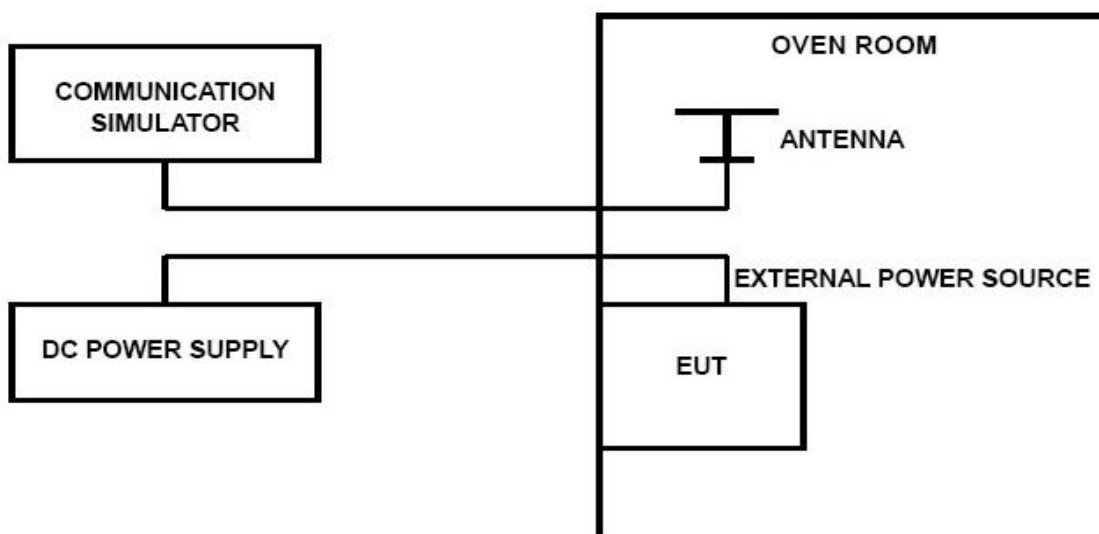

TEST LIMITS

For Hand carried battery powered equipment

According to the JTC standard the frequency stability of the carrier shall be accurate to within 0.1 ppm of the received frequency from the base station. This accuracy is sufficient to meet Sec. 24.235, Frequency Stability. The frequency stability shall be sufficient to ensure that the fundamental emission stays within the authorized

frequency block. As this transceiver is considered "Hand carried, battery powered equipment" Section 2.1055(d)(2) applies. This requires that the lower voltage for frequency stability testing be specified by the manufacturer. This transceiver is specified to operate with an input voltage of between 3.40VDC and 4.20VDC, with a nominal voltage of 3.80DC. Operation above or below these voltage limits is prohibited by transceiver software in order to prevent improper operation as well as to protect components from overstress. These voltages represent a tolerance of -10 % and +12.5 %. For the purposes of measuring frequency stability these voltage limits are to be used.

For equipment powered by primary supply voltage

According to the JTC standard the frequency stability of the carrier shall be accurate to within 0.1 ppm of the received frequency from the base station. This accuracy is sufficient to meet Sec. 24.235, Frequency Stability. The frequency stability shall be sufficient to ensure that the fundamental emission stays within the authorized frequency block. For this EUT section 2.1055(d)(1) applies. This requires varying primary supply voltage from 85 to 115 percent of the nominal value for other than hand carried battery equipment.

TEST RESULTS

| UMTS/TM1/WCDMA Band II | | | | | |
|---------------------------|------------------|---------------------|----------------------|-------------|---------|
| Channel 9400 / 1880.0 MHz | | | | | |
| DC Power | Temperature (°C) | Frequency error(Hz) | Frequency error(ppm) | Limit (ppm) | Verdict |
| 3.40 | 20 | 38 | 0.020 | 2.50 | PASS |
| 3.85 | 20 | 28 | 0.015 | 2.50 | PASS |
| 4.20 | 20 | 42 | 0.022 | 2.50 | PASS |
| 3.85 | -30 | 39 | 0.021 | 2.50 | PASS |
| 3.85 | -20 | 47 | 0.025 | 2.50 | PASS |
| 3.85 | -10 | 32 | 0.017 | 2.50 | PASS |
| 3.85 | 0 | 28 | 0.015 | 2.50 | PASS |
| 3.85 | 10 | 31 | 0.016 | 2.50 | PASS |
| 3.85 | 20 | 39 | 0.021 | 2.50 | PASS |
| 3.85 | 30 | 28 | 0.015 | 2.50 | PASS |
| 3.85 | 40 | 27 | 0.014 | 2.50 | PASS |
| 3.85 | 50 | 25 | 0.013 | 2.50 | PASS |

| UMTS/TM1/WCDMA Band V | | | | | |
|--------------------------|------------------|---------------------|----------------------|-------------|---------|
| Channel 4183 / 836.6 MHz | | | | | |
| DC Power | Temperature (°C) | Frequency error(Hz) | Frequency error(ppm) | Limit (ppm) | Verdict |
| 3.40 | 20 | 29 | 0.035 | 2.50 | PASS |
| 3.85 | 20 | 31 | 0.037 | 2.50 | PASS |
| 4.20 | 20 | 28 | 0.033 | 2.50 | PASS |
| 3.85 | -30 | 32 | 0.038 | 2.50 | PASS |
| 3.85 | -20 | 42 | 0.050 | 2.50 | PASS |
| 3.85 | -10 | 37 | 0.044 | 2.50 | PASS |
| 3.85 | 0 | 29 | 0.035 | 2.50 | PASS |
| 3.85 | 10 | 31 | 0.037 | 2.50 | PASS |
| 3.85 | 20 | 35 | 0.042 | 2.50 | PASS |
| 3.85 | 30 | 31 | 0.037 | 2.50 | PASS |
| 3.85 | 40 | 36 | 0.043 | 2.50 | PASS |
| 3.85 | 50 | 35 | 0.042 | 2.50 | PASS |

4.7 Peak-to-Average Ratio (PAR)

LIMIT

The Peak-to-Average Ratio (PAR) of the transmission may not exceed 13 dB.

TEST CONFIGURATION

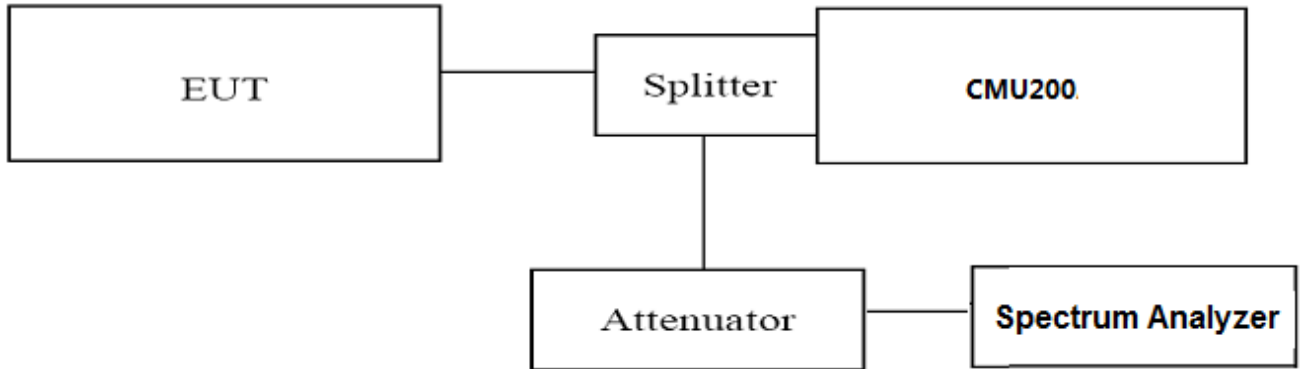

TEST PROCEDURE

1. Refer to instrument’s analyzer instruction manual for details on how to use the power statistics/CCDF function;
2. Set resolution/measurement bandwidth ≥ signal’s occupied bandwidth;
3. Set the number of counts to a value that stabilizes the measured CCDF curve;
4. Set the measurement interval as follows:
 - 1). for continuous transmissions, set to 1 ms,
 - 2). for burst transmissions, employ an external trigger that is synchronized with the EUT burst timing sequence, or use the internal burst trigger with a trigger level that allows the burst to stabilize and set the measurement interval to a time that is less than or equal to the burst duration.
5. Record the maximum PAPR level associated with a probability of 0.1%.

TEST RESULTS

| Test Mode | Channel | Frequency (MHz) | PAPR Value (dB) | Limits (dB) | Verdict |
|------------------------|---------|-----------------|-----------------|-------------|---------|
| UMTS/TM1/WCDMA Band II | 9262 | 1852.40 | 2.58 | 13.0 | PASS |
| | 9400 | 1880.00 | 2.62 | 13.0 | PASS |
| | 9538 | 1907.60 | 2.59 | 13.0 | PASS |
| UMTS/TM1/WCDMA Band V | 4132 | 826.4 | 2.65 | 13.0 | PASS |
| | 4183 | 836.6 | 2.71 | 13.0 | PASS |
| | 4233 | 846.6 | 2.68 | 13.0 | PASS |

Remark:

1. Test results including cable loss;
2. please refer to following plots;

5 Test Setup Photos of the EUT

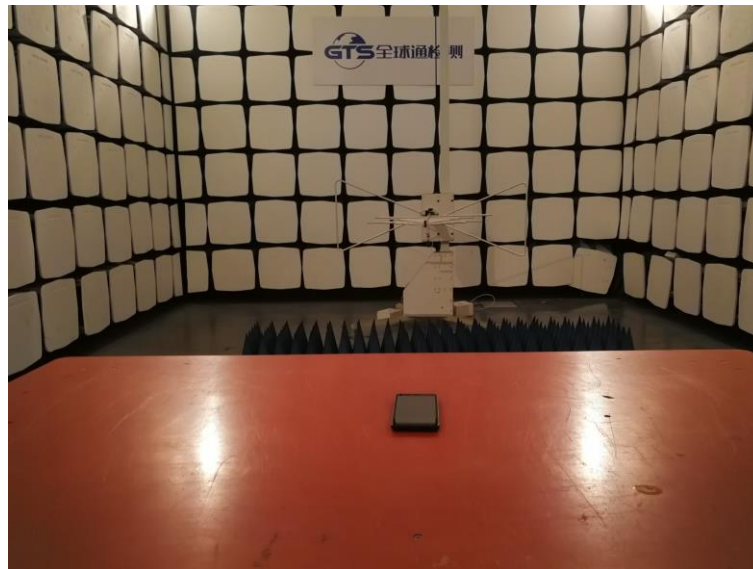

6 External and Internal Photos of the EUT

Reference to the test report No. GTS20190515004-1-1-1

.....**End of Report**.....