



FCC RADIO TEST REPORT

FCC ID:RQQHLT-E5DAZA

Product : smartphone

Trade Name : HYUNDAI

Model Name : E535

Serial Model : E555

Report No. : NTEK-2015NT05271838F4

Prepared for

Hyundai Corporation

140-2,Kye-dong,Chongro-ku,Seoul,South Korea 110-793

Prepared by

Shenzhen NTEK Testing Technology Co., Ltd.

1/F, Building E, Fenda Science Park, Sanwei Community, Xixiang Street
Bao'an District, Shenzhen P.R. China

Tel.: +86-0755-61156588 Fax.: +86-0755-61156599

Website:www.ntek.org.cn

TEST RESULT CERTIFICATION

Applicant's name Hyundai Corporation

Address..... 140-2,Kye-dong,Chongro-ku,Seoul,South Korea 110-793

Manufacturer's Name ... DAZA ELECTRONICS COMPANY

Address..... Bldg G,XinMuSheng Low Carbon Industrial Park,No.6 of XinMu Road,PingHu Town, LongGang, ShenZhen, China

Product description

Product name..... smartphone

Model and/or type reference E535

Serial Model E555

Standards FCC Part15.247 01 Oct. 2014

Test procedure ANSI C63.10-2013 and KDB 558074: June 5, 2014

This device described above has been tested by NTEK, and the test results show that the equipment under test (EUT) is in compliance with the FCC requirements. And it is applicable only to the tested sample identified in the report.

This report shall not be reproduced except in full, without the written approval of NTEK, this document may be altered or revised by NTEK, personnel only, and shall be noted in the revision of the document.

Date of Test

Date (s) of performance of tests..... 27 May 2015 ~11 Jun. 2015

Date of Issue 11 Jun. 2015

Test Result..... **Pass**

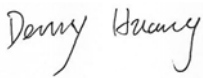
Testing Engineer : 

Denny Huang

Technical Manager : 

(Brown Lu)

Authorized Signatory : 

(Bill Yao)

Table of Contents

	Page
1 . SUMMARY OF TEST RESULTS	5
1.1 TEST FACILITY	6
1.2 MEASUREMENT UNCERTAINTY	6
2 . GENERAL INFORMATION	7
2.1 GENERAL DESCRIPTION OF EUT	7
2.2 DESCRIPTION OF TEST MODES	9
2.3 BLOCK DIGRAM SHOWING THE CONFIGURATION OF SYSTEM TESTED	10
2.4 DESCRIPTION OF SUPPORT UNITS(CONDUCTED MODE)	11
2.5 EQUIPMENTS LIST FOR ALL TEST ITEMS	12
3 . EMC EMISSION TEST	14
3.1 CONDUCTED EMISSION MEASUREMENT	14
3.1.1 POWER LINE CONDUCTED EMISSION LIMITS	14
3.1.2 TEST PROCEDURE	15
3.1.3 DEVIATION FROM TEST STANDARD	15
3.1.4 TEST SETUP	15
3.1.5 EUT OPERATING CONDITIONS	15
3.1.6 TEST RESULTS	16
3.2 RADIATED EMISSION MEASUREMENT	20
3.2.1 RADIATED EMISSION LIMITS	20
3.2.2 TEST PROCEDURE	21
3.2.3 DEVIATION FROM TEST STANDARD	21
3.2.4 TEST SETUP	22
3.2.5 EUT OPERATING CONDITIONS	23
3.2.6 TEST RESULTS (BETWEEN 9KHZ – 30 MHZ)	24
3.2.7 TEST RESULTS (BETWEEN 30MHZ – 1GHZ)	25
3.2.8 TEST RESULTS (ABOVE 1000 MHZ)	27
4 . POWER SPECTRAL DENSITY TEST	28
4.1 APPLIED PROCEDURES / LIMIT	28
4.1.1 TEST PROCEDURE	28
4.1.2 DEVIATION FROM STANDARD	28
4.1.3 TEST SETUP	28
4.1.4 EUT OPERATION CONDITIONS	28
4.1.5 TEST RESULTS	29
5 . BANDWIDTH TEST	37
5.1 APPLIED PROCEDURES / LIMIT	37
5.1.1 TEST PROCEDURE	37

Table of Contents

	Page
TEST SETUP	37
5.1.2 EUT OPERATION CONDITIONS	37
5.1.3 TEST RESULTS	38
6 . PEAK OUTPUT POWER TEST	46
6.1 APPLIED PROCEDURES / LIMIT	46
6.1.1 TEST PROCEDURE	46
6.1.2 DEVIATION FROM STANDARD	46
6.1.3 TEST SETUP	46
6.1.4 EUT OPERATION CONDITIONS	46
6.1.5 TEST RESULTS	47
7 . 100 KHZ BANDWIDTH OF FREQUENCY BAND EDGE	48
7.1 DEVIATION FROM STANDARD	48
7.2 TEST SETUP	48
7.3 EUT OPERATION CONDITIONS	48
7.4 TEST RESULTS	49
8 . ANTENNA REQUIREMENT	55
8.1 STANDARD REQUIREMENT	55
8.2 EUT ANTENNA	55
9 . EUT TEST PHOTO	56
APPENDIX-PHOTOGRAPHS OF EUT CONSTRUCTIONAL DETAILS	

1. SUMMARY OF TEST RESULTS

Test procedures according to the technical standards:

FCC Part15 (15.247) , Subpart C			
Standard Section	Test Item	Judgment	Remark
15.207	Conducted Emission	PASS	
15.247 (a)(2)	6dB Bandwidth	PASS	
15.247 (b)	Peak Output Power	PASS	
15.247 (c)	Radiated Spurious Emission	PASS	
15.247 (d)	Power Spectral Density	PASS	
15.205	Band Edge Emission	PASS	
15.203	Antenna Requirement	PASS	

NOTE:

(1) "N/A" denotes test is not applicable in this Test Report

1.1 TEST FACILITY

NTEK Testing Technology Co., Ltd
 Add.:1/F, Building E, Fenda Science Park, Sanwei Community, Xixiang Street, Bao'an District, Shenzhen P.R. China.
 FCC Registration No.:238937; IC Registration No.:9270A-1
 CNAS Registration No.:L5516

1.2 MEASUREMENT UNCERTAINTY

The reported uncertainty of measurement $y \pm U$, where expanded uncertainty U is based on a standard uncertainty multiplied by a coverage factor of $k=2$, providing a level of confidence of approximately **95 %**.

No.	Item	Uncertainty
1	Conducted Emission Test	$\pm 1.38\text{dB}$
2	RF power,conducted	$\pm 0.16\text{dB}$
3	Spurious emissions,conducted	$\pm 0.21\text{dB}$
4	All emissions,radiated(<1G)	$\pm 4.68\text{dB}$
5	All emissions,radiated(>1G)	$\pm 4.89\text{dB}$
6	Temperature	$\pm 0.5^\circ\text{C}$
7	Humidity	$\pm 2\%$

2. GENERAL INFORMATION

2.1 GENERAL DESCRIPTION OF EUT

Equipment	smartphone	
Trade Name	HYUNDAI	
Model Name	E535	
Serial Model	E555	
Model Difference	All the model are the same circuit and RF module, except the model name and colour.	
Product Description	Operation Frequency:	802.11b/g/n(20MHz): 2412~2462MHz 802.11n(40MHz):2422~2452MHz
	Modulation Type:	IEEE 802.11b : DSSS (CCK, QPSK, DBPSK) IEEE 802.11g/n (HT20/HT40) : OFDM (64QAM, 16QAM, QPSK, BPSK)
	Bit Rate of Transmitter	802.11b:11/5.5/2/1 Mbps 802.11g:54/48/36/24/18/12/9/6Mbps 802.11n(20MHz/40MHz):150/144.44/130/117/115.56/104/86.67/78/52/6.5Mbps
	Number Of Channel	802.11b/g/n20MHz:11CH 802.11n40MHz:7CH
	Antenna Designation:	Please see Note 3.
	Antenna Gain (dBi)	1.0 dbi
	Channel List	Please refer to the Note 2.
Ratings	DC 3.8V	
Adapter	Mode: PS10E050K2000UU Input: 100-240V~, 50/60Hz, 0.35A Output: 5.0V---, 2000mA	
Battery	DC 3.8V,2100mAh	
Connecting I/O Port(s)	Please refer to the User's Manual	

Note:

1. For a more detailed features description, please refer to the manufacturer's specifications or the User's Manual.

2.

Channel List for 802.11b/g/n(20 MHz)							
Channel	Frequency (MHz)	Channel	Frequency (MHz)	Channel	Frequency (MHz)	Channel	Frequency (MHz)
01	2412	04	2427	07	2442	10	2457
02	2417	05	2432	08	2447	11	2462
03	2422	06	2437	09	2452		

Channel List for 802.11n(40MHz)							
Channel	Frequency (MHz)	Channel	Frequency (MHz)	Channel	Frequency (MHz)	Channel	Frequency (MHz)
03	2422	06	2437	09	2452		
04	2427	07	2442				
05	2432	08	2447				

3.

Table for Filed Antenna

Ant	Brand	Model Name	Antenna Type	Connector	Gain (dBi)	NOTE
A	N/A	N/A	FPCB Antenna	N/A	1.0	Wifi Antenna

2.2 DESCRIPTION OF TEST MODES

To investigate the maximum EMI emission characteristics generates from EUT, the test system was pre-scanning tested base on the consideration of following EUT operation mode or test configuration mode which possible have effect on EMI emission level. Each of these EUT operation mode(s) or test configuration mode(s) mentioned above was evaluated respectively.

Pretest Mode	Description
Mode 1	802.11b CH1/ CH6/ CH11
Mode 2	802.11g CH1/ CH6/ CH11
Mode 3	802.11n20 CH1/ CH6/ CH11
Mode 4	802.11n40 CH3/ CH6/ CH9
Mode 5	Link Mode

For Conducted Emission	
Final Test Mode	Description
Mode 5	Link Mode

For Radiated Emission	
Final Test Mode	Description
Mode 1	802.11b CH1/ CH6/ CH11
Mode 2	802.11g CH1/ CH6/ CH11
Mode 3	802.11n20 CH1/ CH6/ CH11
Mode 4	802.11n40 CH3/ CH6/ CH 9
Mode 5	Link Mode

Note:

- (1) The measurements are performed at the highest, middle, lowest available channels.
- (2) The measurements are performed at all Bit Rate of Transmitter, the worst data was reported
- (3) EUT configured to transmit continuously:

Operated Mode for Worst Duty Cycle	
Test Signal Duty Cycle (x)	Average correction factor (dB)
100% - IEEE 802.11b	0
100% - IEEE 802.11g	0
100% - IEEE 802.11n (HT20)	0
100% - IEEE 802.11n (HT40)	0

2.3 BLOCK DIGRAM SHOWING THE CONFIGURATION OF SYSTEM TESTED

Conducted Emission Test

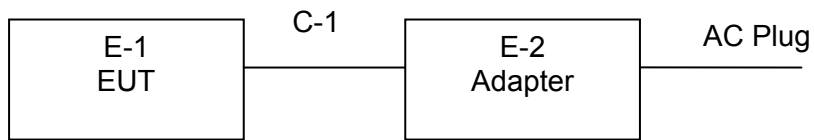

Radiated Spurious Emission Test

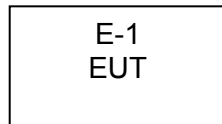

2.4 DESCRIPTION OF SUPPORT UNITS(CONDUCTED MODE)

The EUT has been tested as an independent unit together with other necessary accessories or support units. The following support units or accessories were used to form a representative test configuration during the tests.

Item	Equipment	Brand	Model/Type No.	Series No.	Note
E-1	smartphone	HYUNDAI	E535	N/A	EUT
E-2	Adapter	N/A	PS10E050K2000UU	N/A	

Item	Shielded Type	Ferrite Core	Length	Note
C-1	NO	NO	1.2m	

Note:

- (1) The support equipment was authorized by Declaration of Confirmation.
- (2) For detachable type I/O cable should be specified the length in cm in 『Length』 column.

2.5 EQUIPMENTS LIST FOR ALL TEST ITEMS

Radiation Test equipment

Item	Kind of Equipment	Manufacturer	Type No.	Serial No.	Last calibration	Calibrated until	Calibration period
1	Spectrum Analyzer	Agilent	E4407B	MY45108040	2014.07.06	2015.07.05	1 year
2	Test Receiver	R&S	ESPI	101318	2015.06.07	2016.06.06	1 year
2*	Test Receiver	R&S	ESPI	101318	2014.06.07	2015.06.06	1 year
3	Bilog Antenna	TESEQ	CBL6111D	31216	2014.07.06	2015.07.05	1 year
4	50Ω Coaxial Switch	Anritsu	MP59B	6200264416	2015.06.07	2016.06.06	1 year
4*	50Ω Coaxial Switch	Anritsu	MP59B	6200264416	2014.06.07	2015.06.06	1 year
5	Spectrum Analyzer	ADVANTEST	R3132	150900201	2015.06.07	2016.06.06	1 year
5*	Spectrum Analyzer	ADVANTEST	R3132	150900201	2014.06.07	2015.06.06	1 year
6	Horn Antenna	EM	EM-AH-10180	2011071402	2014.07.06	2015.07.05	1 year
7	Horn Ant	Schwarzbeck	BBHA 9170	9170-181	2014.07.06	2015.07.05	1 year
8	Amplifier	EM	EM-30180	060538	2014.12.22	2015.12.21	1 year
9	Loop Antenna	ARA	PLA-1030/B	1029	2015.06.08	2016.06.07	1 year
9*	Loop Antenna	ARA	PLA-1030/B	1029	2014.06.08	2015.06.07	1 year
10	Power Meter	R&S	NRVS	100696	2014.07.06	2015.07.05	1 year
11	Power Sensor	R&S	URV5-Z4	0395.1619.05	2014.07.06	2015.07.05	1 year
12	Test Cable	N/A	R-01	N/A	2014.07.06	2015.07.05	1 year
13	Test Cable	N/A	R-02	N/A	2014.07.06	2015.07.05	1 year

Conduction Test equipment

Item	Kind of Equipment	Manufacturer	Type No.	Serial No.	Last calibration	Calibrated until	Calibration period
1	Test Receiver	R&S	ESCI	101160	2015.06.06	2016.06.05	1 year
1*	Test Receiver	R&S	ESCI	101160	2014.06.06	2015.06.05	1 year
2	LISN	R&S	ENV216	101313	2014.08.24	2015.08.23	1 year
3	LISN	EMCO	3816/2	00042990	2014.08.24	2015.08.23	1 year
4	50Ω Coaxial Switch	Anritsu	MP59B	6200264417	2015.06.07	2016.06.06	1 year
4*	50Ω Coaxial Switch	Anritsu	MP59B	6200264417	2014.06.07	2015.06.06	1 year
5	Passive Voltage Probe	R&S	ESH2-Z3	100196	2015.06.07	2016.06.06	1 year
5*	Passive Voltage Probe	R&S	ESH2-Z3	100196	2014.06.07	2015.06.06	1 year
6	Absorbing clamp	R&S	MOS-21	100423	2015.06.08	2016.06.07	1 year
6*	Absorbing clamp	R&S	MOS-21	100423	2014.06.08	2015.06.07	1 year

7	Test Cable	N/A	C01	N/A	2015.06.08	2016.06.07	1 year
7*	Test Cable	N/A	C01	N/A	2014.06.08	2015.06.07	1 year
8	Test Cable	N/A	C02	N/A	2015.06.08	2016.06.07	1 year
8*	Test Cable	N/A	C02	N/A	2014.06.08	2015.06.07	1 year
9	Test Cable	N/A	C03	N/A	2015.06.08	2016.06.07	1 year
9*	Test Cable	N/A	C03	N/A	2014.06.08	2015.06.07	1 year

1	Attenuation	MCE	24-10-34	BN9258	2015.06.08	2016.06.07	1 year
1	Attenuation	MCE	24-10-34	BN9258	2014.06.08	2015.06.07	1 year

3. EMC EMISSION TEST

3.1 CONDUCTED EMISSION MEASUREMENT

3.1.1 POWER LINE CONDUCTED EMISSION Limits (Frequency Range 150KHz-30MHz)

FREQUENCY (MHz)	Class A (dBuV)		Class B (dBuV)		Standard
	Quasi-peak	Average	Quasi-peak	Average	
0.15 -0.5	79.00	66.00	66 - 56 *	56 - 46 *	CISPR
0.50 -5.0	73.00	60.00	56.00	46.00	CISPR
5.0 -30.0	73.00	60.00	60.00	50.00	CISPR

0.15 -0.5	79.00	66.00	66 - 56 *	56 - 46 *	FCC
0.50 -5.0	73.00	60.00	56.00	46.00	FCC
5.0 -30.0	73.00	60.00	60.00	50.00	FCC

Note:

- (1) The tighter limit applies at the band edges.
- (2) The limit of " * " marked band means the limitation decreases linearly with the logarithm of the frequency in the range.

The following table is the setting of the receiver

Receiver Parameters	Setting
Attenuation	10 dB
Start Frequency	0.15 MHz
Stop Frequency	30 MHz
IF Bandwidth	9 kHz

3.1.2 TEST PROCEDURE

- a. The EUT was placed 0.8 meters from the horizontal ground plane with EUT being connected to the power mains through a line impedance stabilization network (LISN). All other support equipments powered from additional LISN(s). The LISN provide 50 Ohm/ 50uH of coupling impedance for the measuring instrument.
- b. Interconnecting cables that hang closer than 40 cm to the ground plane shall be folded back and forth in the center forming a bundle 30 to 40 cm long.
- c. I/O cables that are not connected to a peripheral shall be bundled in the center. The end of the cable may be terminated, if required, using the correct terminating impedance. The overall length shall not exceed 1 m.
- d. LISN at least 80 cm from nearest part of EUT chassis.
- e. For the actual test configuration, please refer to the related Item –EUT Test Photos.

3.1.3 DEVIATION FROM TEST STANDARD

No deviation

3.1.4 TEST SETUP

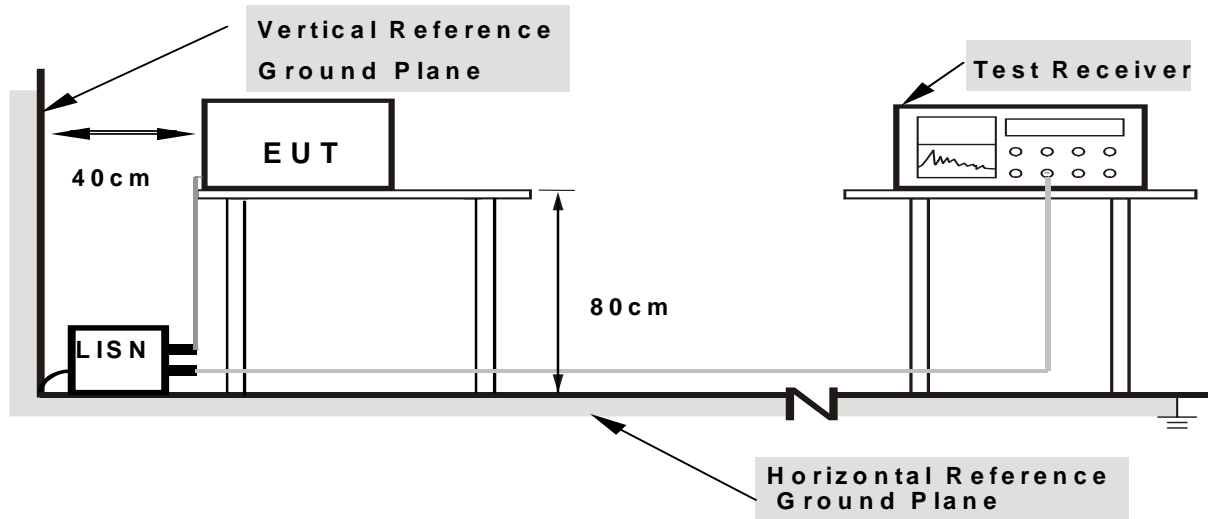

- Note:**
- 1. Support units were connected to second LISN.
 - 2. Both of LISNs (AMN) are 80 cm from EUT and at least 80 from other units and other metal planes

3.1.5 EUT OPERATING CONDITIONS

The EUT was configured for testing in a typical fashion (as a customer would normally use it). The EUT has been programmed to continuously transmit during test. This operating condition was tested and used to collect the included data.

3.1.6 TEST RESULTS

EUT :	smartphone	Model Name. :	E535
Temperature :	26 °C	Relative Humidity :	56%
Pressure :	1010hPa	Phase :	L
Test Voltage :	DC 5V From adapter AC120V/60Hz	Test Mode :	Mode 5

Frequency	Meter Reading	Factor	Emission Level	Limits	Margin	Remark
(MHz)	(dBμV)	(dB)	(dBμV)	(dBμV)	(dB)	
0.1539	45.23	9.63	54.86	65.78	-10.92	QP
0.1539	29.32	9.63	38.95	55.78	-16.83	AVG
0.3339	33.19	9.61	42.80	59.35	-16.55	QP
0.3339	24.23	9.61	33.84	49.35	-15.51	AVG
0.4863	35.06	9.72	44.78	56.23	-11.45	QP
0.4863	22.58	9.72	32.30	46.23	-13.93	AVG
0.9577	33.13	9.74	42.87	56.00	-13.13	QP
0.9577	20.69	9.74	30.43	46.00	-15.57	AVG
1.6737	29.76	9.67	39.43	56.00	-16.57	QP
1.6737	18.75	9.67	28.42	46.00	-17.58	AVG
8.1019	28.54	9.70	38.24	60.00	-21.76	QP
8.1019	16.73	9.70	26.43	50.00	-23.57	AVG

Remark:

1. All readings are Quasi-Peak and Average values.
2. Factor = Insertion Loss + Cable Loss.

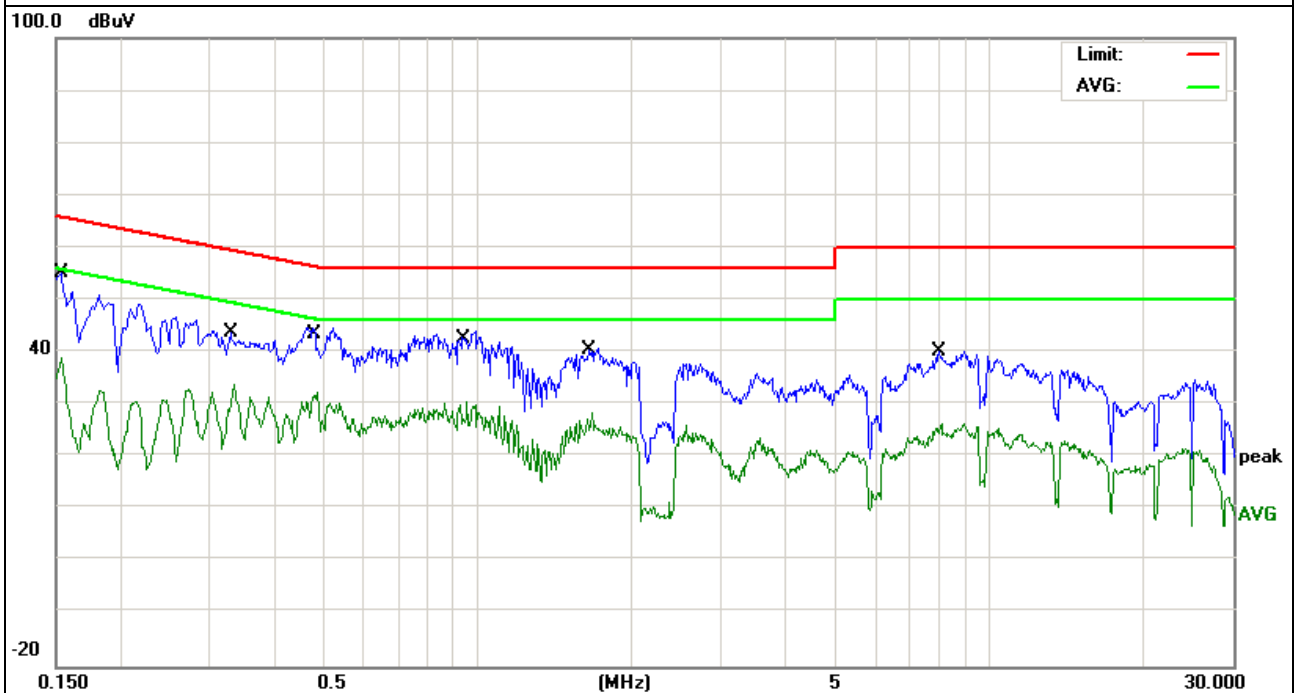

EUT :	smartphone	Model Name. :	E535
Temperature :	26 °C	Relative Humidity :	56%
Pressure :	1010hPa	Phase :	N
Test Voltage :	DC 5V From adapter AC120V/60Hz	Test Mode :	Mode 5

Frequency (MHz)	Meter Reading (dBμV)	Factor (dB)	Emission Level (dBμV)	Limits (dBμV)	Margin (dB)	Remark
0.1500	43.50	9.60	53.10	65.99	-12.89	QP
0.1500	27.00	9.60	36.60	55.99	-19.39	AVG
0.2740	31.87	9.61	41.48	60.99	-19.51	QP
0.2740	24.57	9.61	34.18	50.99	-16.81	AVG
0.4818	31.68	9.68	41.36	56.31	-14.95	QP
0.4818	23.49	9.68	33.17	46.31	-13.14	AVG
0.8458	32.25	9.62	41.87	56.00	-14.13	QP
0.8458	19.79	9.62	29.41	46.00	-16.59	AVG
0.9899	31.54	9.61	41.15	56.00	-14.85	QP
0.9899	18.91	9.61	28.52	46.00	-17.48	AVG
21.0338	19.96	9.86	29.82	60.00	-30.18	QP
21.0338	10.14	9.86	20.00	50.00	-30.00	AVG

Remark:

1. All readings are Quasi-Peak and Average values.
2. Factor = Insertion Loss + Cable Loss.

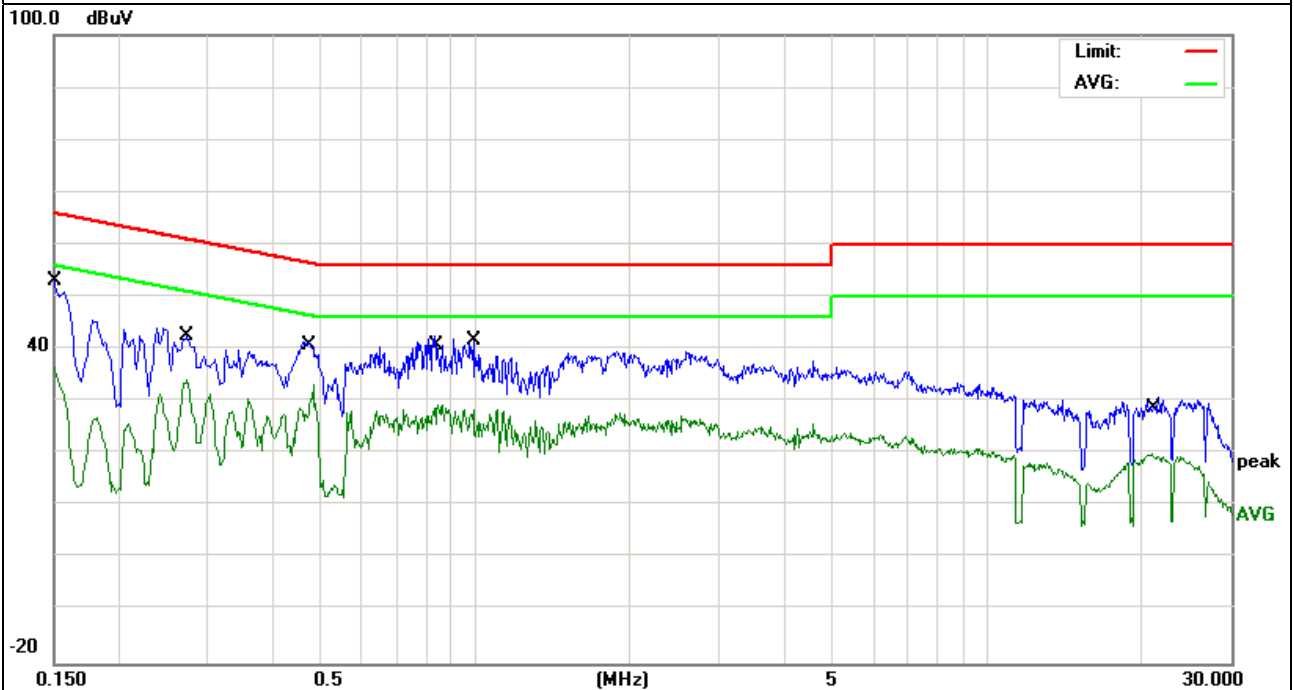

EUT :	smartphone	Model Name. :	E535
Temperature :	26 °C	Relative Humidity :	56%
Pressure :	1010hPa	Phase :	L
Test Voltage :	DC 5V form Adapter AC 240V/60Hz	Test Mode :	Mode 5

Frequency (MHz)	Meter Reading (dBμV)	Factor (dB)	Emission Level (dBμV)	Limits (dBμV)	Margin (dB)	Remark
0.2260	38.71	9.49	48.20	62.59	-14.39	QP
0.2260	30.35	9.49	39.84	52.59	-12.75	AVG
0.4519	41.53	9.51	51.04	56.84	-5.80	QP
0.4819	30.42	9.51	39.93	46.31	-6.38	AVG
0.6820	40.22	9.53	49.75	56.00	-6.25	QP
0.6820	29.77	9.53	39.30	46.00	-6.70	AVG
1.1939	40.52	9.53	50.05	56.00	-5.95	QP
1.1939	28.52	9.53	38.05	46.00	-7.95	AVG
1.6060	39.84	9.54	49.38	56.00	-6.62	QP
1.6060	28.45	9.54	37.99	46.00	-8.01	AVG
2.0459	39.01	9.55	48.56	56.00	-7.44	QP
2.0459	30.05	9.55	39.60	46.00	-6.40	AVG

Remark:
 1. All readings are Quasi-Peak and Average values.
 2. Factor = Insertion Loss + Cable Loss.

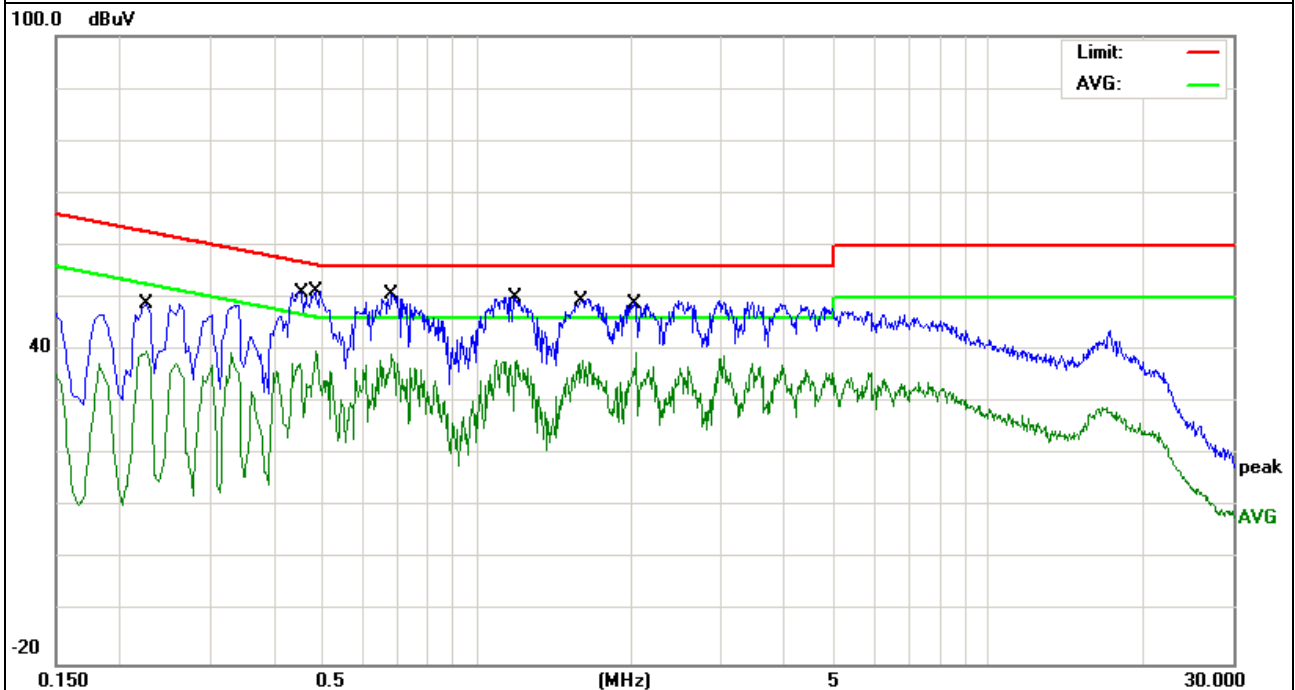

EUT :	smartphone	Model Name. :	E535
Temperature :	26 °C	Relative Humidity :	56%
Pressure :	1010hPa	Phase :	N
Test Voltage :	DC 5V form Adapter AC 240V/60Hz	Test Mode :	Mode 5

Frequency (MHz)	Meter Reading (dBμV)	Factor (dB)	Emission Level (dBμV)	Limits (dBμV)	Margin (dB)	Remark
0.1860	34.59	9.55	44.14	64.21	-20.07	QP
0.1860	29.49	9.55	39.04	54.21	-15.17	AVG
0.2540	37.25	9.51	46.76	61.62	-14.86	QP
0.2540	30.34	9.51	39.85	51.62	-11.77	AVG
0.4780	39.49	9.53	49.02	56.37	-7.35	QP
0.4780	31.01	9.53	40.54	46.37	-5.83	AVG
0.6460	38.07	9.53	47.60	56.00	-8.40	QP
0.6460	31.36	9.53	40.89	46.00	-5.11	AVG
1.2380	38.67	9.55	48.22	56.00	-7.78	QP
1.2380	29.82	9.55	39.37	46.00	-6.63	AVG
2.0540	36.34	9.57	45.91	56.00	-10.09	QP
2.0540	28.86	9.57	38.43	46.00	-7.57	AVG

Remark:

1. All readings are Quasi-Peak and Average values.
2. Factor = Insertion Loss + Cable Loss.

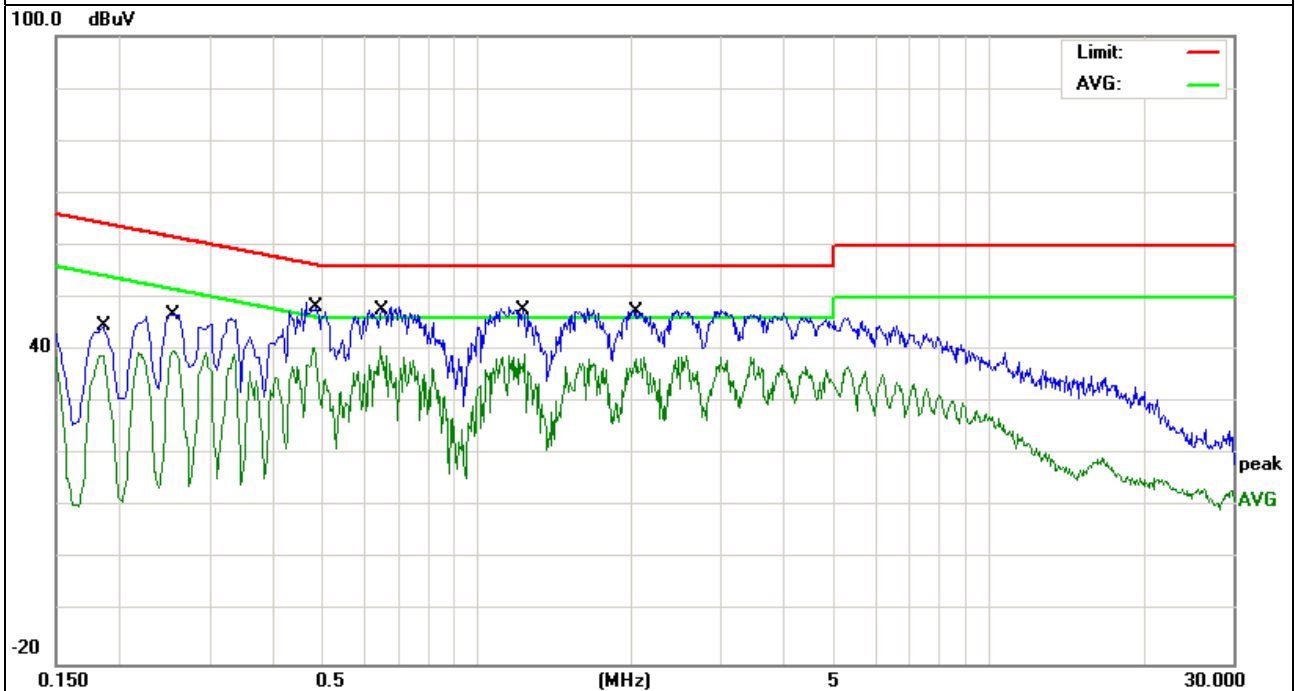

3.2 RADIATED EMISSION MEASUREMENT

3.2.1 RADIATED EMISSION LIMITS (Frequency Range 9kHz-1000MHz)

20dBc in any 100 kHz bandwidth outside the operating frequency band. In case the emission fall within the restricted band specified on 15.205(a), then the 15.209(a) limit in the table below has to be followed.

Frequencies (MHz)	Field Strength (micorvolts/meter)	Measurement Distance (meters)
0.009~0.490	2400/F(KHz)	300
0.490~1.705	24000/F(KHz)	30
1.705~30.0	30	30
30~88	100	3
88~216	150	3
216~960	200	3
Above 960	500	3

LIMITS OF RADIATED EMISSION MEASUREMENT (Above 1000MHz)

FREQUENCY (MHz)	dBuV/m@at 3M	
	PEAK	AVERAGE
Above 1000	74	54

Notes:

- (1) The limit for radiated test was performed according to FCC PART 15C.
- (2) The tighter limit applies at the band edges.
- (3) Emission level (dBuV/m)=20log Emission level (uV/m).

Spectrum Parameter	Setting
Attenuation	Auto
Start Frequency	1000 MHz
Stop Frequency	10th carrier harmonic
RB / VB (emission in restricted band)	1 MHz / 1 MHz for Peak, 1 MHz / 10Hz for Average

Receiver Parameter	Setting
Attenuation	Auto
Start ~ Stop Frequency	9kHz~150kHz / RB 200Hz for QP
Start ~ Stop Frequency	150kHz~30MHz / RB 9kHz for QP
Start ~ Stop Frequency	30MHz~1000MHz / RB 120kHz for QP

3.2.2 TEST PROCEDURE

- a. The measuring distance of at 3 m shall be used for measurements at frequency up to 1GHz. For frequencies above 1GHz, any suitable measuring distance may be used.
- b. The EUT was placed on the top of a rotating table 0.8 m for below 1GHz and 1.5m for above 1GHz the ground at a 3 meter open area test site. The table was rotated 360 degrees to determine the position of the highest radiation.
- c. The height of the equipment or of the substitution antenna shall be 0.8 m for below 1GHz and 1.5m for above 1GHz; the height of the test antenna shall vary between 1 m to 4 m. Both horizontal and vertical polarizations of the antenna are set to make the measurement.
- d. The initial step in collecting conducted emission data is a spectrum analyzer peak detector mode pre-scanning the measurement frequency range. Significant peaks are then marked and then Quasi Peak detector mode re-measured.
- e. If the Peak Mode measured value compliance with and lower than Quasi Peak Mode Limit, the EUT shall be deemed to meet QP Limits and then no additional QP Mode measurement performed.
- f. For the actual test configuration, please refer to the related Item –EUT Test Photos.

Note:

Both horizontal and vertical antenna polarities were tested and performed pretest to three orthogonal axis. The worst case emissions were reported

During the radiated emission test, the Spectrum Analyzer was set with the following configurations:

Frequency Band (MHz)	Function	Resolution bandwidth	Video Bandwidth
30 to 1000	Peak	100 kHz	100 kHz
Above 1000	Peak	1 MHz	1 MHz
	Average	1 MHz	10 Hz

3.2.3 DEVIATION FROM TEST STANDARD

No deviation

3.2.4 TEST SETUP

(A) Radiated Emission Test-Up Frequency Below 30MHz

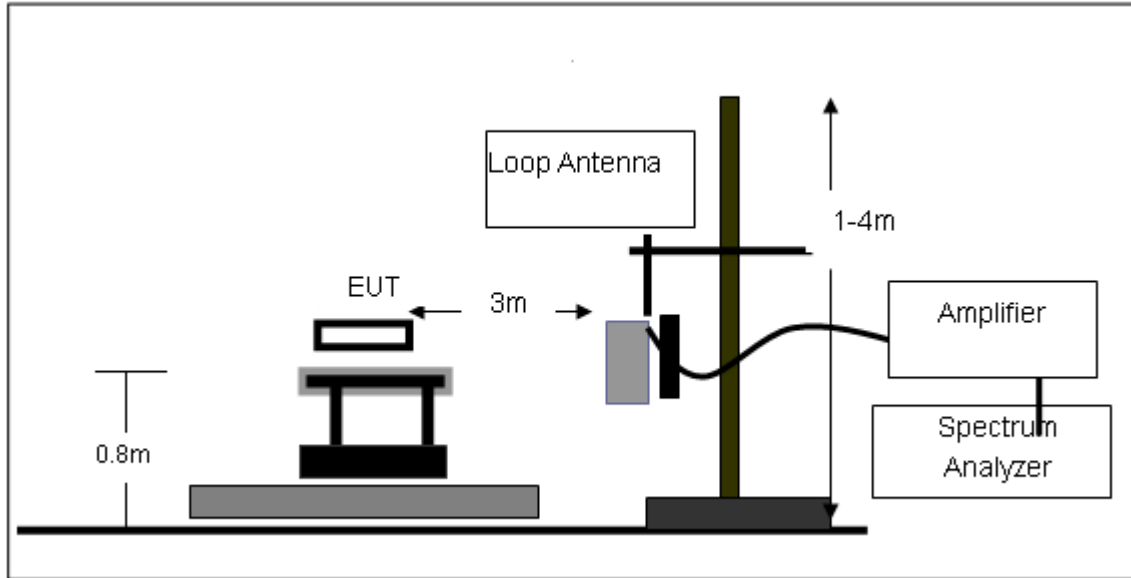

(B) Radiated Emission Test-Up Frequency 30MHz~1GHz

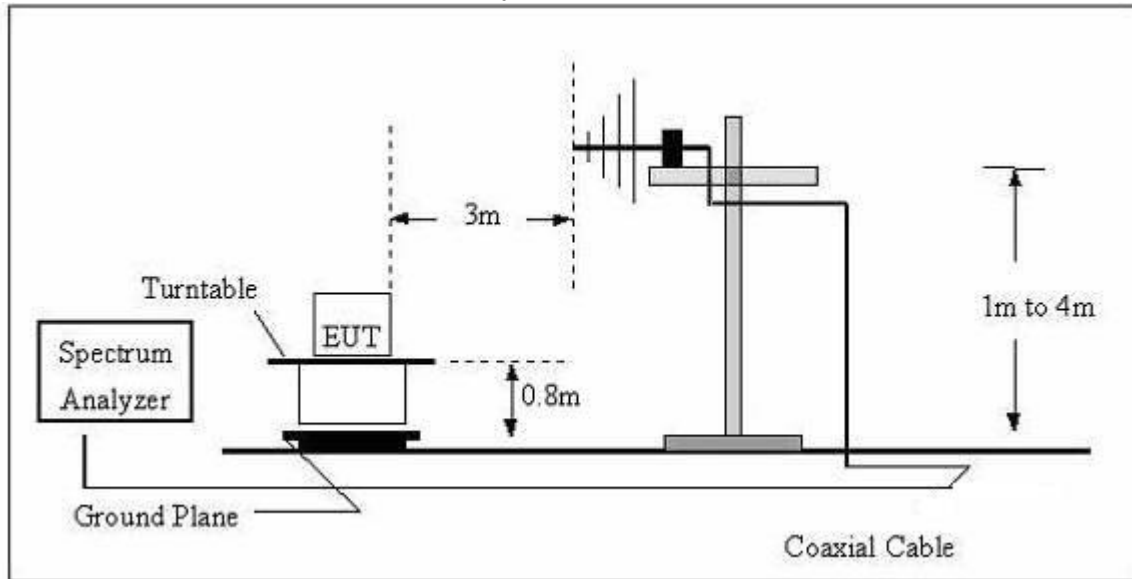

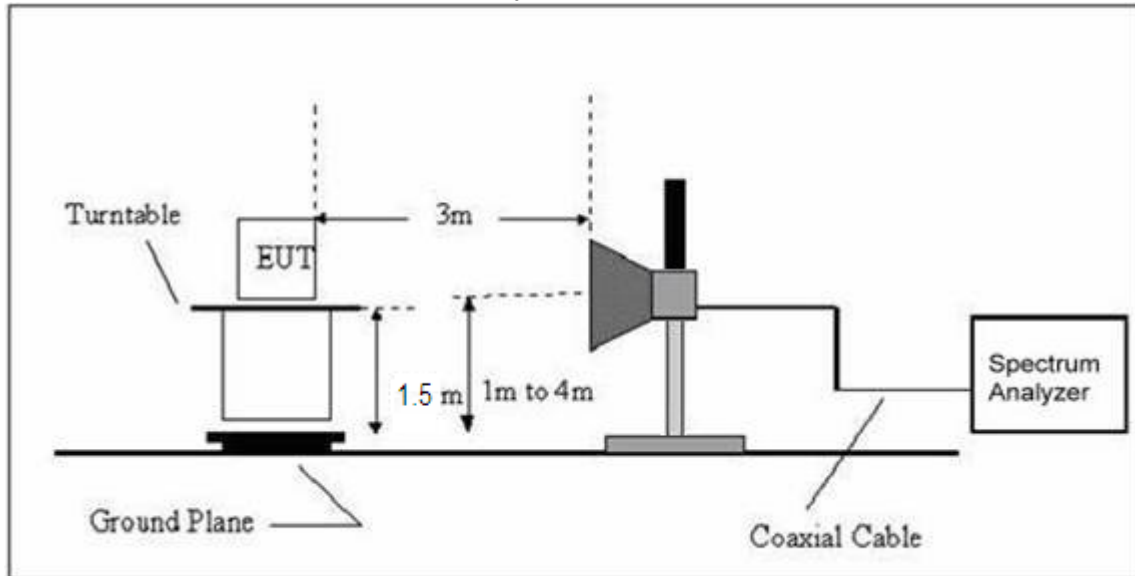
(C) Radiated Emission Test-Up Frequency Above 1GHz**3.2.5 EUT OPERATING CONDITIONS**

The EUT tested system was configured as the statements of 2.4 Unless otherwise a special operating condition is specified in the follows during the testing.

3.2.6 TEST RESULTS (BETWEEN 9KHZ – 30 MHZ)

EUT:	smartphone	Model Name. :	E535
Temperature:	20 °C	Relative Humidity:	48%
Pressure:	1010 hPa	Test Voltage :	DC 3.8V
Test Mode :	TX	Polarization :	--

Freq.	Reading	Limit	Margin	State
(MHz)	(dBuV/m)	(dBuV/m)	(dB)	P/F
--	--	--	--	N/A
--	--	--	--	N/A

NOTE:

The amplitude of spurious emissions which are attenuated by more than 20dB below the permissible value has no need to be reported.

Distance extrapolation factor = $40 \log(\text{specific distance}/\text{test distance})$ (dB);

Limit line = specific limits(dBuv) + distance extrapolation factor.

3.2.7 TEST RESULTS (BETWEEN 30MHZ – 1GHZ)

EUT :	smartphone	Model Name :	E535
Temperature :	20 °C	Relative Humidity :	48%
Pressure :	1010 hPa	Test Voltage :	DC 3.8V
Test Mode :	TX		

Polar (H/V)	Frequency	Meter Reading	Factor	Emission Level	Limits	Margin	Remark
	(MHz)	(dBuV)	(dB)	(dBuV/m)	(dBuV/m)	(dB)	
V	30.4238	15.55	19.19	34.74	40.00	-5.26	QP
V	57.3923	23.03	8.58	31.61	40.00	-8.39	QP
V	77.8654	22.34	5.79	28.13	40.00	-11.87	QP
V	167.8243	15.31	10.54	25.85	43.50	-17.65	QP
V	233.3487	16.34	13.04	29.38	46.00	-16.62	QP
V	903.3094	6.46	27.03	33.49	46.00	-12.51	QP

Remark:

Absolute Level= ReadingLevel+ Factor, Margin= Absolute Level - Limit

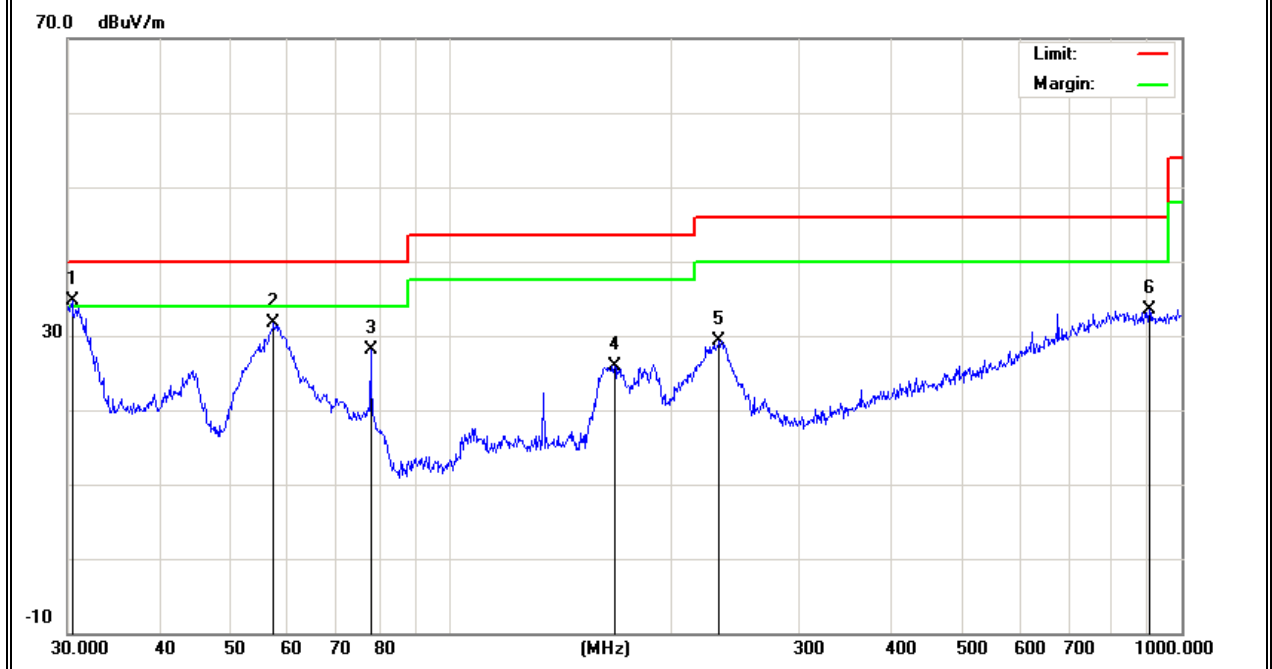

Polar (H/V)	Frequency	Meter Reading	Factor	Emission Level	Limits	Margin	Remark
	(MHz)	(dBuV)	(dB)	(dBuV/m)	(dBuV/m)	(dB)	
H	43.0505	15.04	12.55	27.59	40.00	-12.41	QP
H	57.1914	21.48	8.64	30.12	40.00	-9.88	QP
H	64.2074	23.27	6.89	30.16	40.00	-9.84	QP
H	83.8156	17.91	6.63	24.54	40.00	-15.46	QP
H	228.4904	15.24	12.71	27.95	46.00	-18.05	QP
H	906.4824	9.05	27.05	36.10	46.00	-9.90	QP

Remark:

Absolute Level= ReadingLevel+ Factor, Margin= Absolute Level - Limit

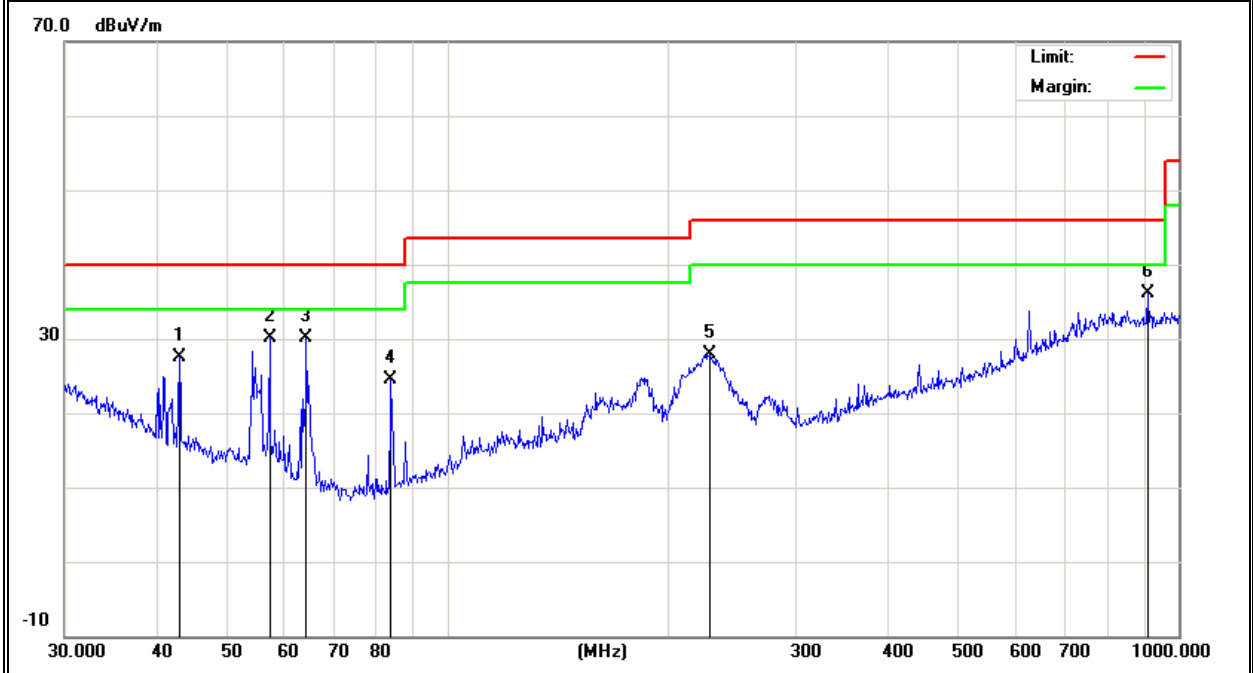

3.2.8 TEST RESULTS (ABOVE 1000 MHZ)

EUT :	smartphone	Model Name :	E535
Temperature :	20 °C	Relative Humidity :	48%
Pressure :	1010 hPa	Test Voltage :	DC 3.8V
Test Mode :	TX		

Polar (H/V)	Frequency	Meter Reading	Factor	Emission Level	Limits	Margin	Detector Type
	(MHz)	(dBuV)	(dB)	(dBuV/m)	(dBuV/m)	(dB)	
Low Channel (2412 MHz)-Above 1G							
Vertical	4824.042	51.6	10.44	62.04	74.00	-11.96	Pk
Vertical	4824.042	33.16	10.44	43.60	54.00	-10.40	Av
Vertical	7236.126	44.81	12.39	57.20	74.00	-16.80	Pk
Vertical	7236.126	29.09	12.39	41.48	54.00	-12.52	Av
Horizontal	4824.304	53.35	10.44	63.79	74.00	-10.21	Pk
Horizontal	4824.304	32.07	10.44	42.51	54.00	-11.49	Av
Horizontal	7236.252	45.51	12.39	57.90	74.00	-16.10	Pk
Horizontal	7236.252	30.65	12.39	43.04	54.00	-10.96	Av
Mid Channel (2437 MHz)-Above 1G							
Vertical	4874.247	51.01	10.40	61.41	74.00	-12.59	Pk
Vertical	4874.247	31.93	10.40	42.33	54.00	-11.67	Av
Vertical	7311.306	44.67	12.75	57.42	74.00	-16.58	Pk
Vertical	7311.306	27.66	12.75	40.41	54.00	-13.59	Av
Horizontal	4874.089	51.78	10.40	62.18	74.00	-11.82	Pk
Horizontal	4874.089	33.01	10.40	43.41	54.00	-10.59	Av
Horizontal	7311.174	47.89	12.75	60.64	74.00	-13.36	Pk
Horizontal	7311.174	28.58	12.75	41.33	54.00	-12.67	Av
High Channel (2462 MHz)- Above 1G							
Vertical	4924.326	50.95	10.39	61.34	74.00	-12.66	Pk
Vertical	4924.326	32.58	10.39	42.97	54.00	-11.03	Av
Vertical	7386.247	44.35	12.68	57.03	74.00	-16.97	Pk
Vertical	7386.247	27.99	12.68	40.67	54.00	-13.33	Av
Horizontal	4924.089	50.98	10.39	61.37	74.00	-12.63	Pk
Horizontal	4924.089	33.08	10.39	43.47	54.00	-10.53	Av
Horizontal	7386.147	47.37	12.68	60.05	74.00	-13.95	Pk
Horizontal	7386.147	28.67	12.68	41.35	54.00	-12.65	Av

Note: "802.11b" mode is the worst mode. When PK value is lower than the Average value limit, average didn't record.

4. POWER SPECTRAL DENSITY TEST

4.1 APPLIED PROCEDURES / LIMIT

FCC Part15 (15.247) , Subpart C				
Section	Test Item	Limit	Frequency Range (MHz)	Result
15.247	Power Spectral Density	8 dBm (in any 3KHz)	2400-2483.5	PASS

4.1.1 TEST PROCEDURE

1. Set analyzer center frequency to DTS channel center frequency.
2. Set the span to 1.5 times the DTS channel bandwidth.
3. 3 kHz ≤ Set the RBW ≤ 100 kHz.
4. Set the VBW ≥ 3 x RBW.
5. Detector = peak.
6. Sweep time = auto couple.
7. Trace mode = max hold.
8. Allow trace to fully stabilize.
9. Use the peak marker function to determine the maximum amplitude level within the RBW.
10. If measured value exceeds limit, reduce RBW (no less than 3 kHz) and repeat.

4.1.2 DEVIATION FROM STANDARD

No deviation.

4.1.3 TEST SETUP



4.1.4 EUT OPERATION CONDITIONS

The EUT tested system was configured as the statements of 2.1 Unless otherwise a special operating condition is specified in the follows during the testing.

4.1.5 TEST RESULTS

EUT :	smartphone	Model Name :	E535
Temperature :	25 °C	Relative Humidity :	56%
Pressure :	1015 hPa	Test Voltage :	DC 3.8V
Test Mode :	TX b Mode /CH01, CH06, CH11		

Frequency	Power Density (dBm)	Limit (dBm)	Result
2412 MHz	-10.88	8	PASS
2437 MHz	-10.22	8	PASS
2462 MHz	-9.54	8	PASS

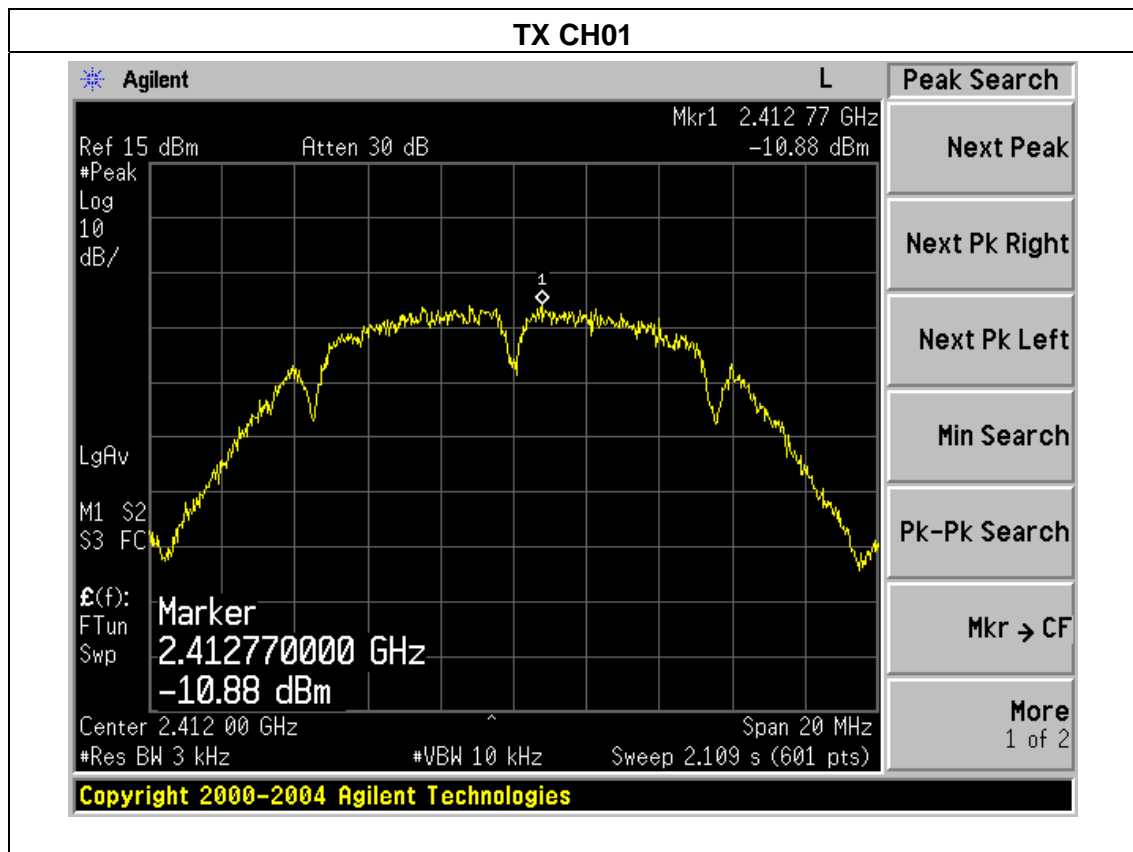

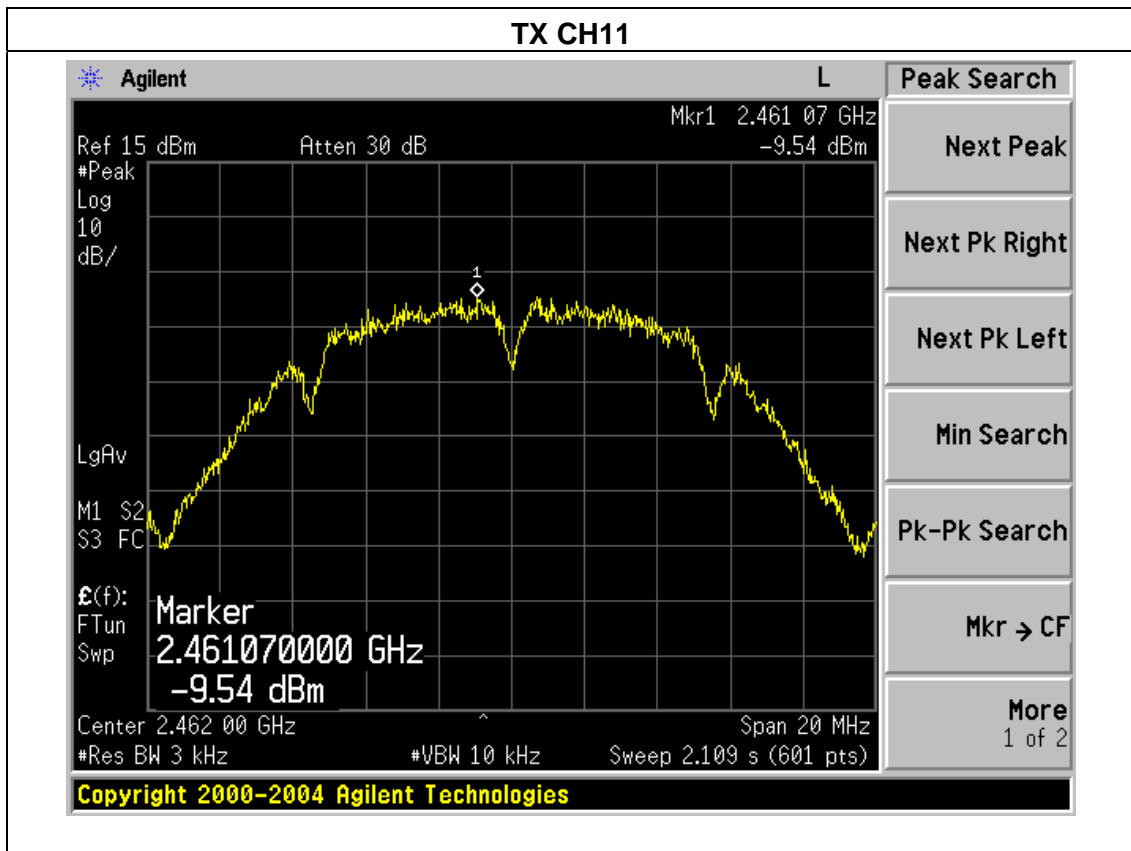
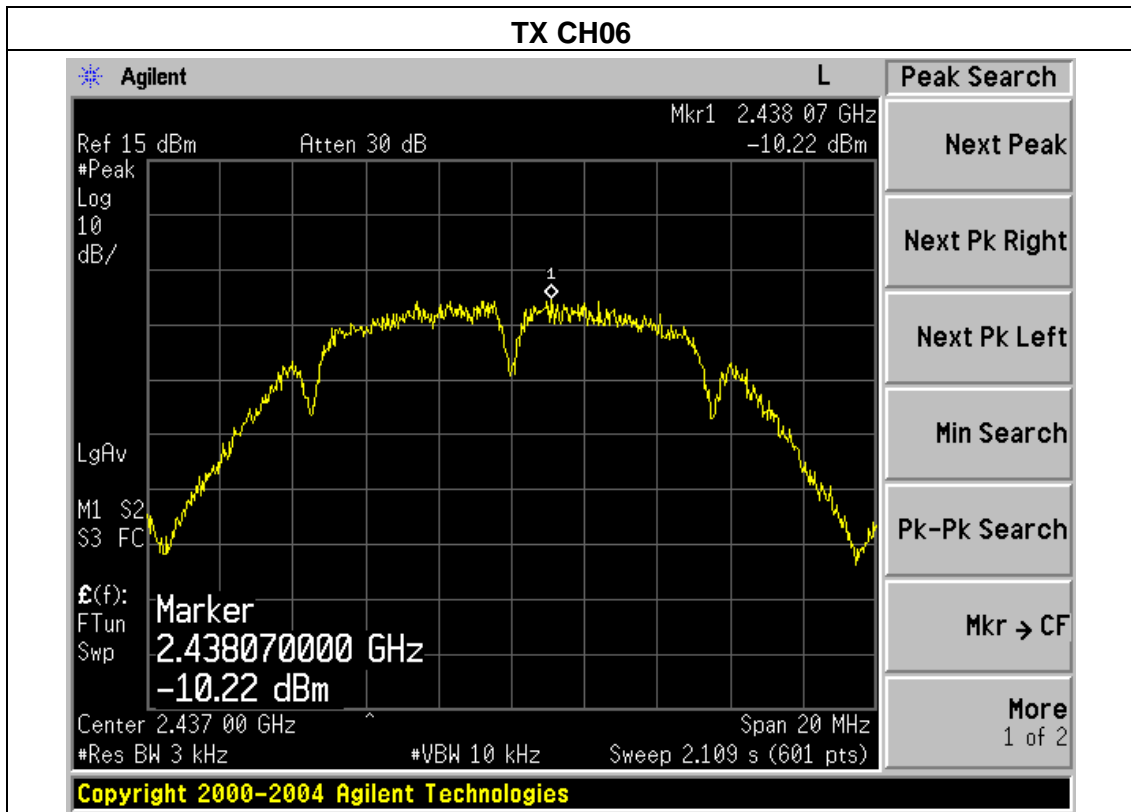

EUT :	smartphone	Model Name :	E535
Temperature :	25 °C	Relative Humidity :	56%
Pressure :	1015 hPa	Test Voltage :	DC 3.8V
Test Mode :	TX g Mode /CH01, CH06, CH11		

Frequency	Power Density (dBm)	Limit (dBm)	Result
2412 MHz	-13.74	8	PASS
2437 MHz	-11.93	8	PASS
2462 MHz	-12.47	8	PASS

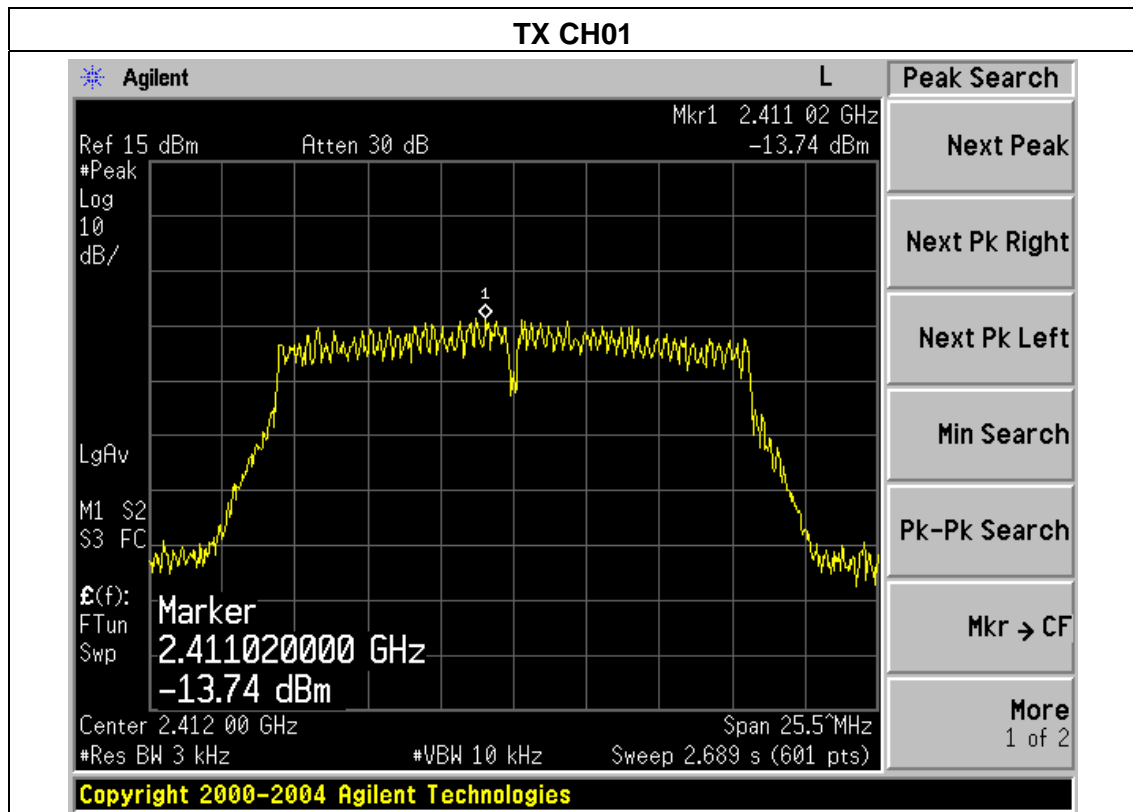

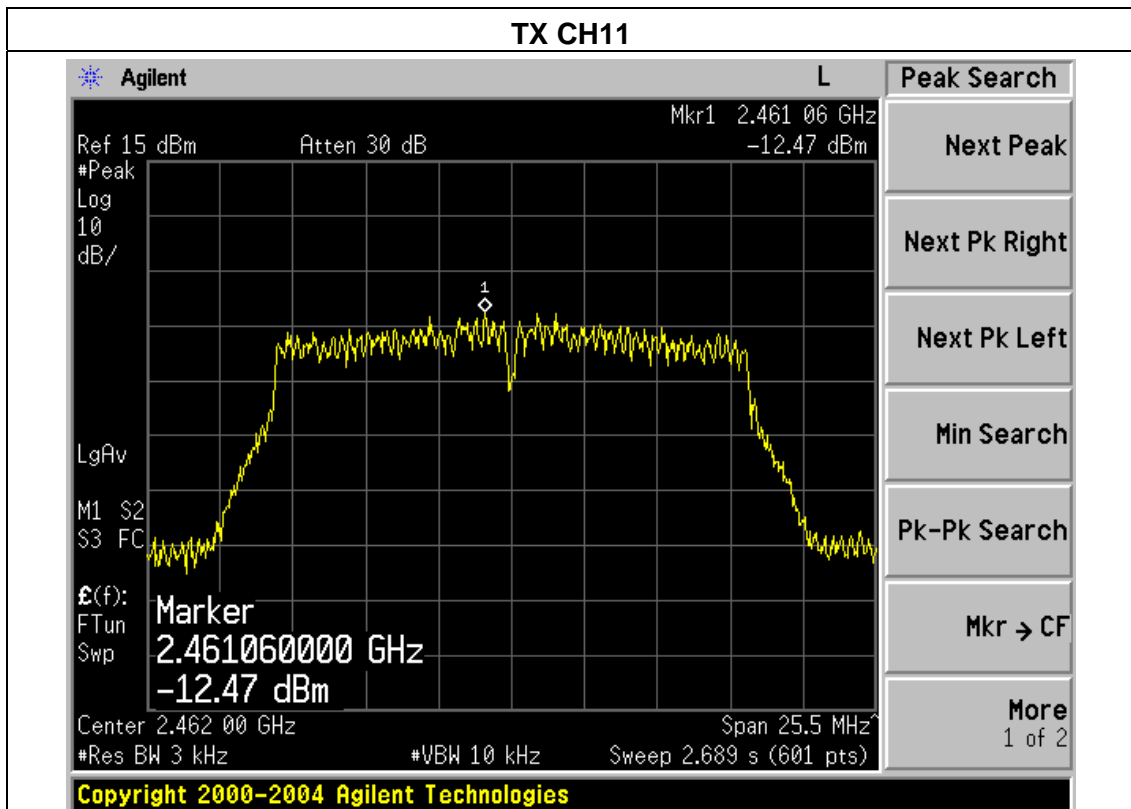
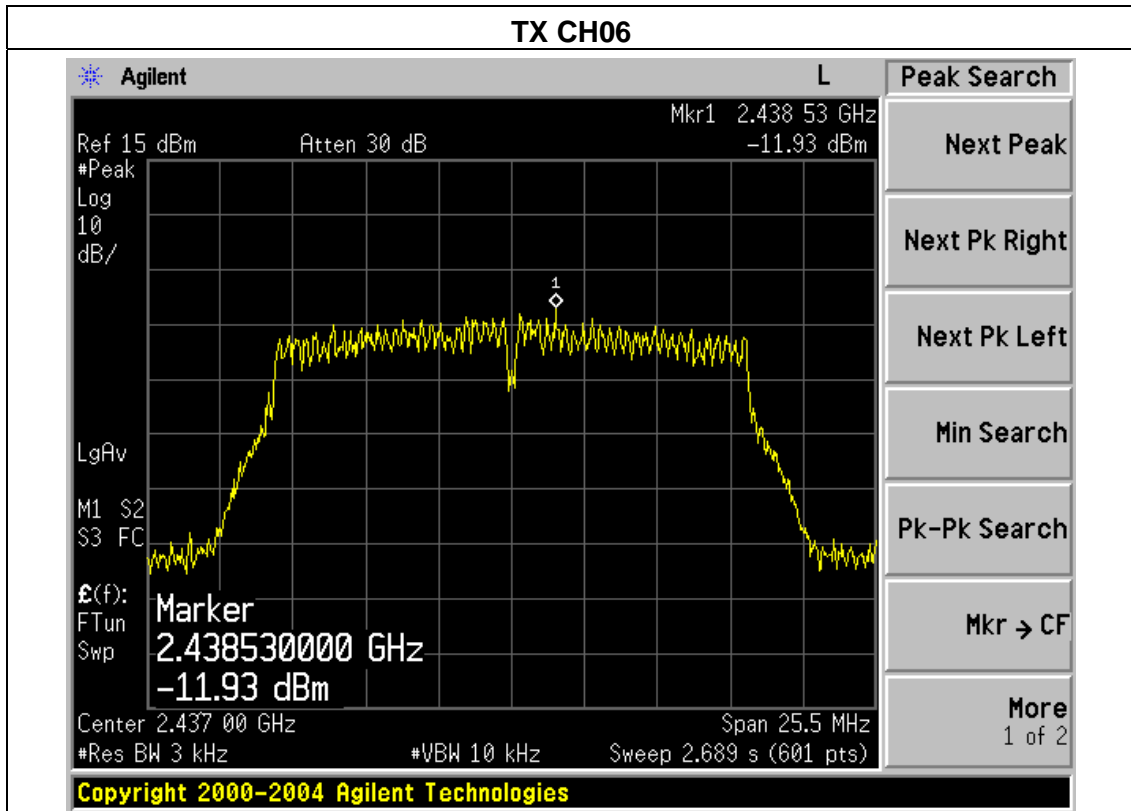

EUT :	smartphone	Model Name :	E535
Temperature :	25 °C	Relative Humidity :	56%
Pressure :	1015 hPa	Test Voltage :	DC 3.8V
Test Mode :	TX n Mode (20MHz)/CH01, CH06, CH11		

Frequency	Power Density (dBm)	Limit (dBm)	Result
2412 MHz	-12.67	8	PASS
2437 MHz	-13.27	8	PASS
2462 MHz	-11.86	8	PASS

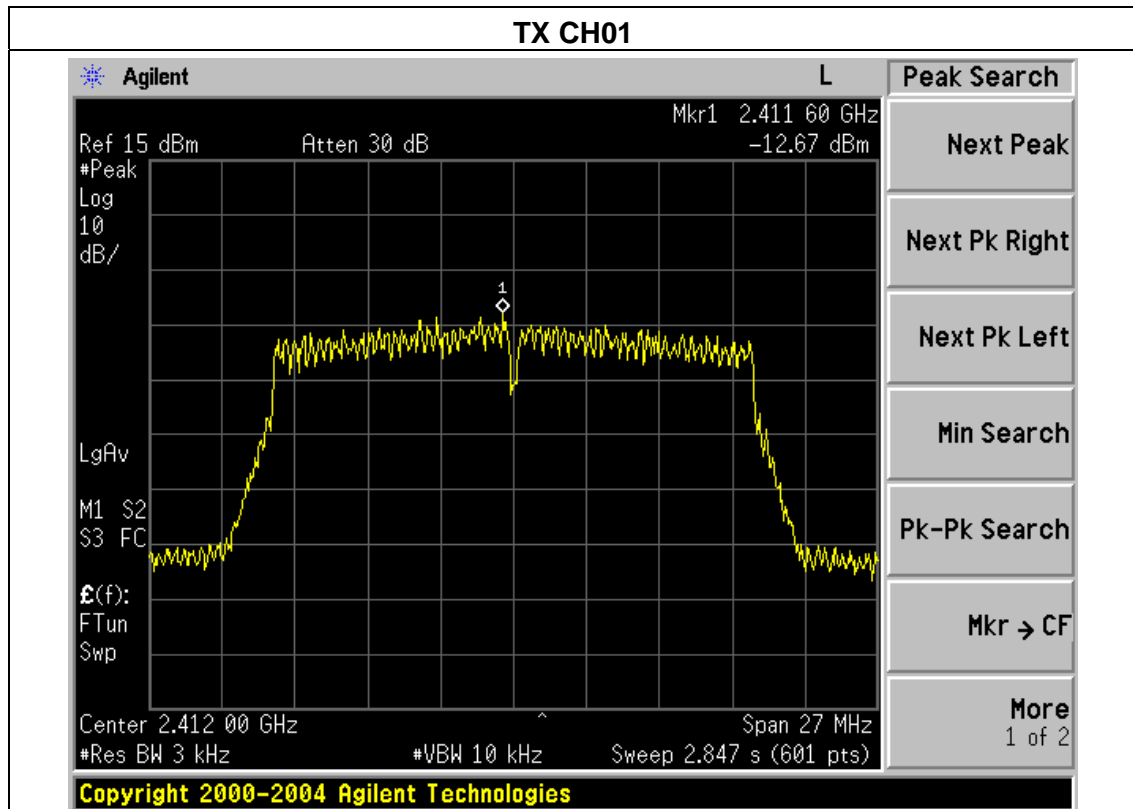

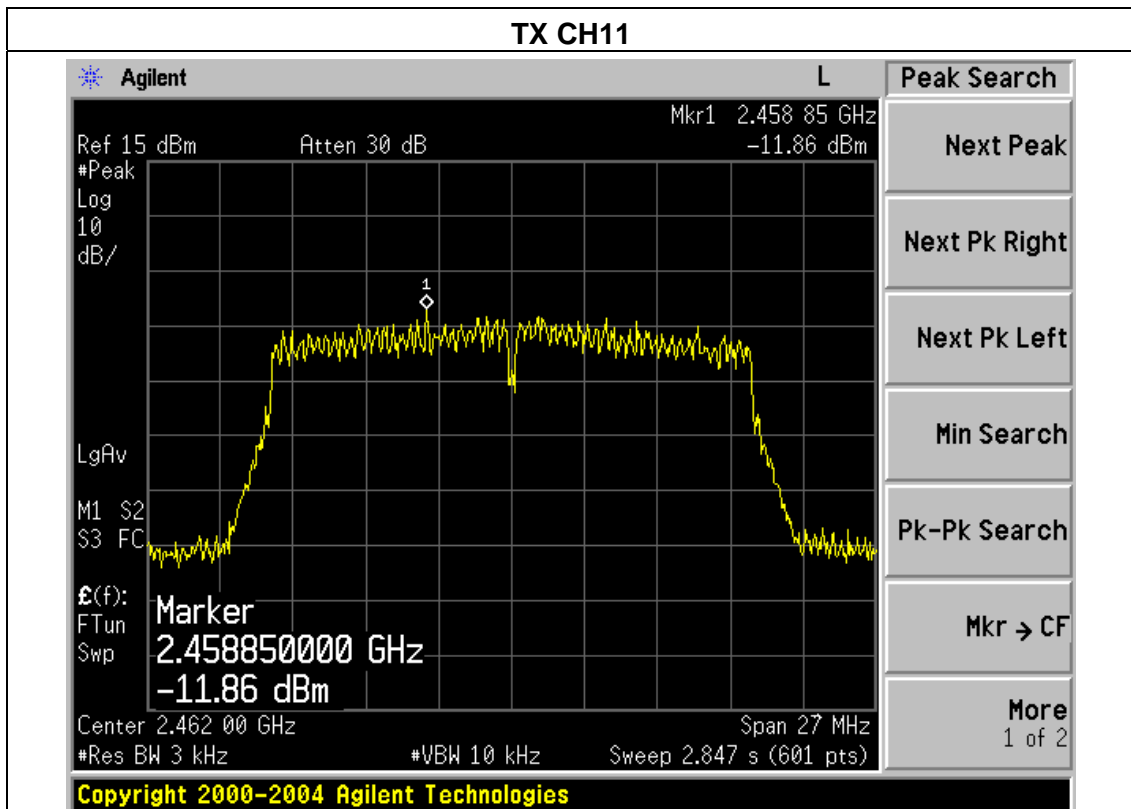
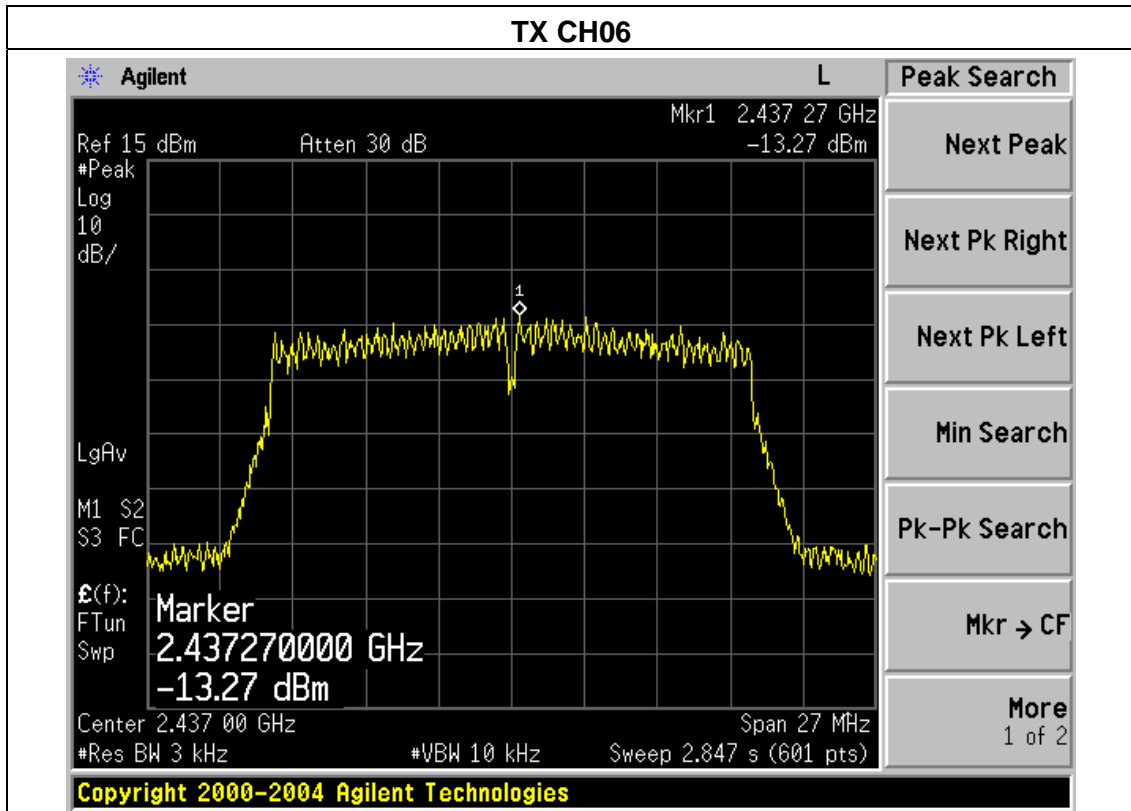

EUT :	smartphone	Model Name :	E535
Temperature :	25 °C	Relative Humidity :	56%
Pressure :	1015 hPa	Test Voltage :	DC 3.8V
Test Mode :	TX n Mode (40MHz)/CH03, CH06, CH09		

Frequency	Power Density (dBm)	Limit (dBm)	Result
2422 MHz	-17.76	8	PASS
2437 MHz	-17.14	8	PASS
2452 MHz	-17.34	8	PASS

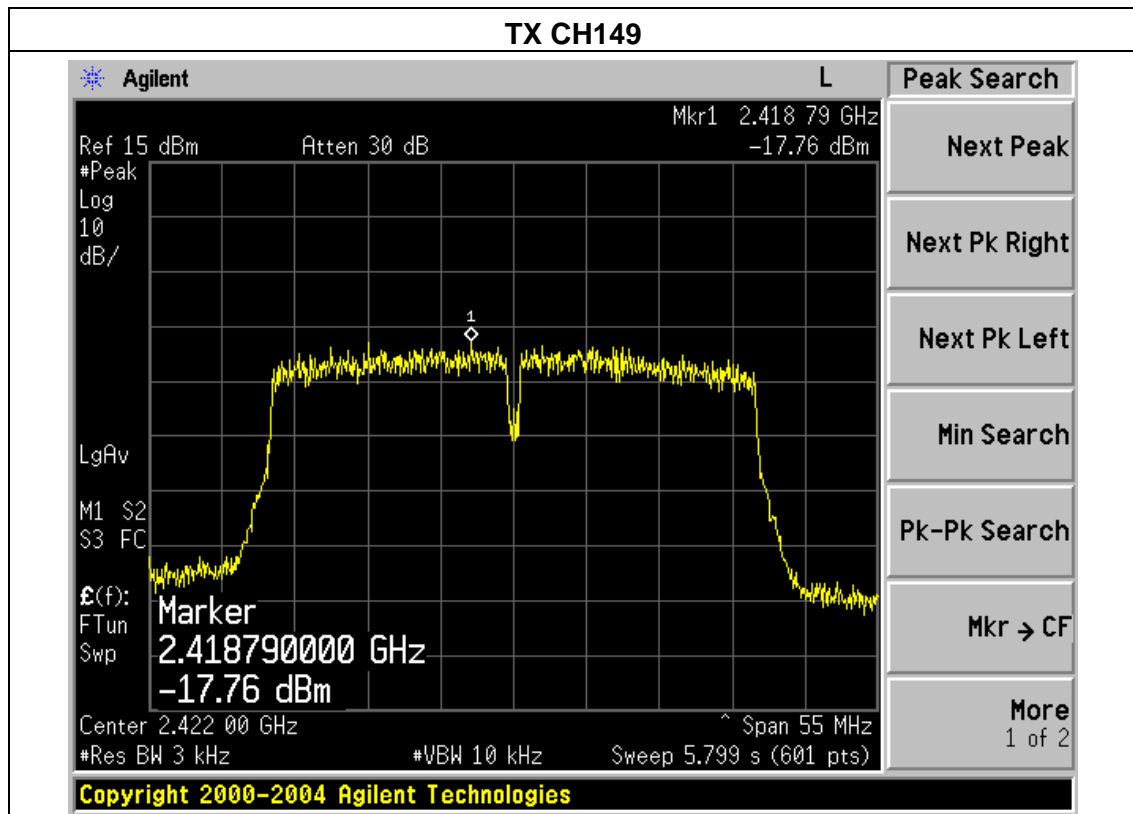

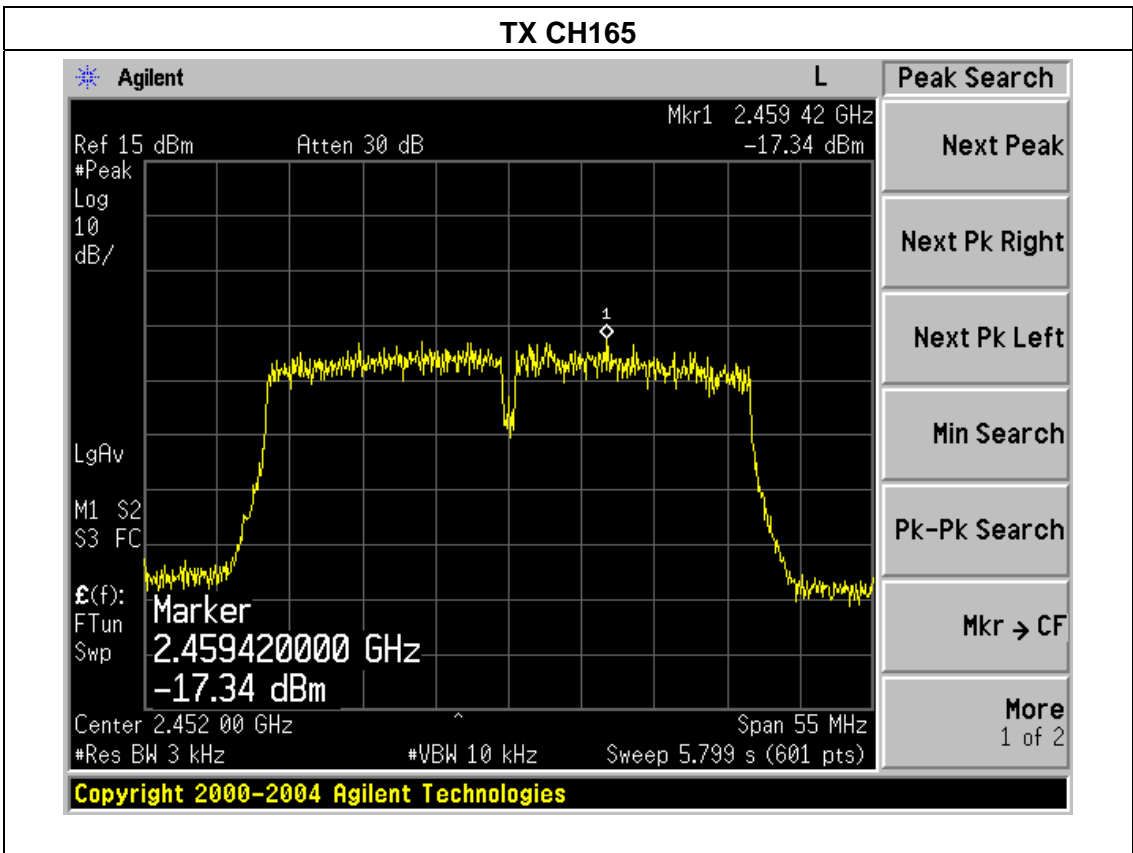
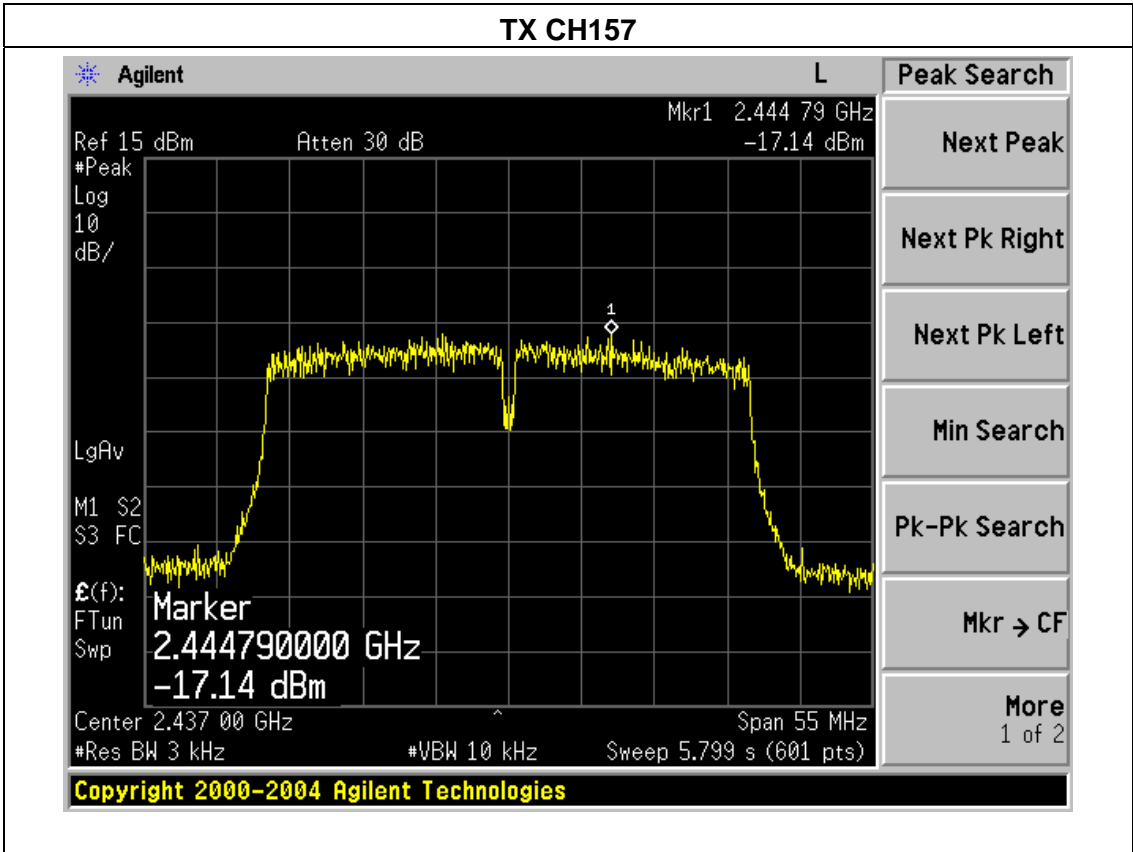

5. BANDWIDTH TEST

5.1 APPLIED PROCEDURES / LIMIT

FCC Part15 (15.247) , Subpart C				
Section	Test Item	Limit	Frequency Range (MHz)	Result
15.247(a)(2)	Bandwidth	$\geq 500\text{KHz}$ (6dB bandwidth)	2400-2483.5	PASS

5.1.1 TEST PROCEDURE

1. Set RBW = 100 kHz.
2. Set the video bandwidth (VBW) $\geq 3 \times$ RBW.
3. Detector = Peak.
4. Trace mode = max hold.
5. Sweep = auto couple.
6. Allow the trace to stabilize.
7. Measure the maximum width of the emission that is constrained by the frequencies associated with the two outermost amplitude points (upper and lower) that are attenuated by 6 dB relative to the maximum level measured in the fundamental emission.

TEST SETUP

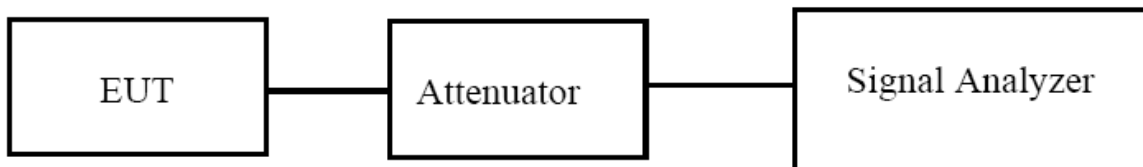

5.1.2 EUT OPERATION CONDITIONS

The EUT tested system was configured as the statements of 2.4 Unless otherwise a special operating condition is specified in the follows during the testing.

5.1.3 TEST RESULTS

EUT :	smartphone	Model Name :	E535
Temperature :	25 °C	Relative Humidity :	56%
Pressure :	1012 hPa	Test Voltage :	DC 3.8V
Test Mode :	TX b Mode /CH01, CH06, CH11		

Channel	Frequency (MHz)	6dB bandwidth (MHz)	Limit (kHz)	Result
Low	2412	9.619	500	Pass
Middle	2437	9.606	500	Pass
High	2462	10.024	500	Pass

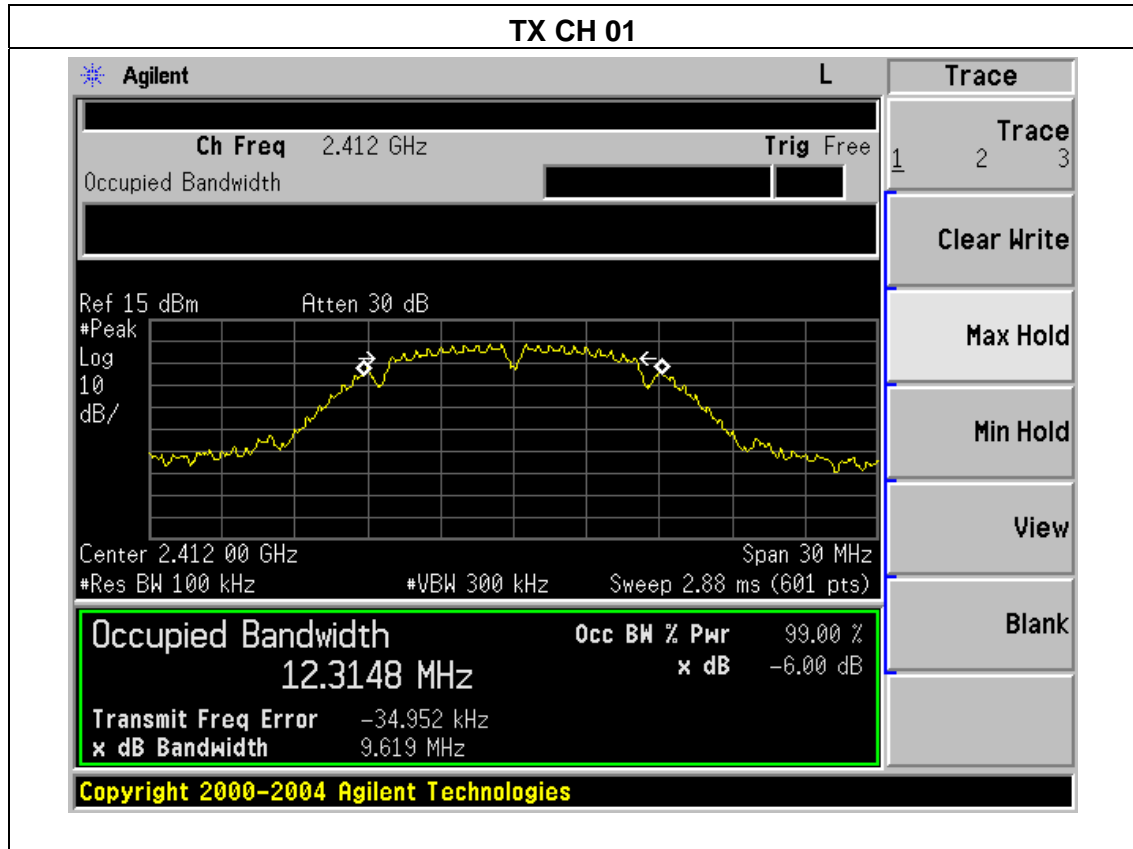

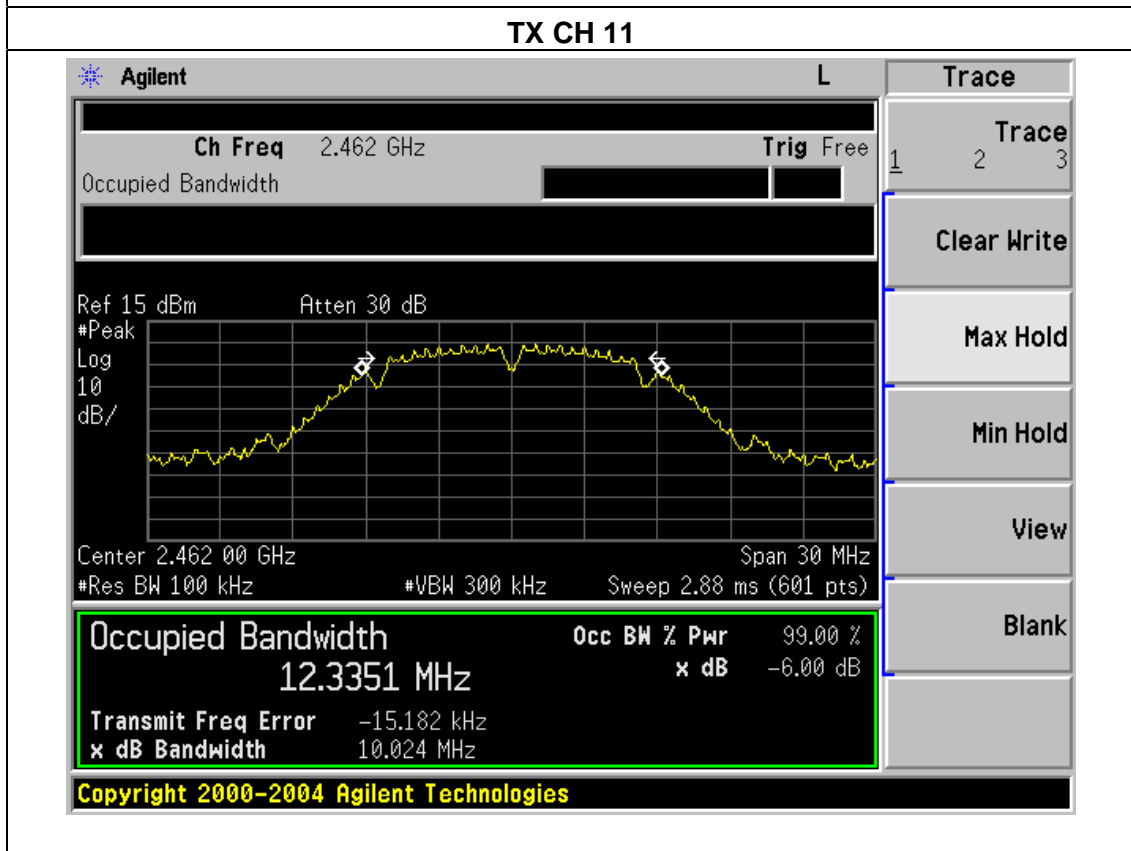
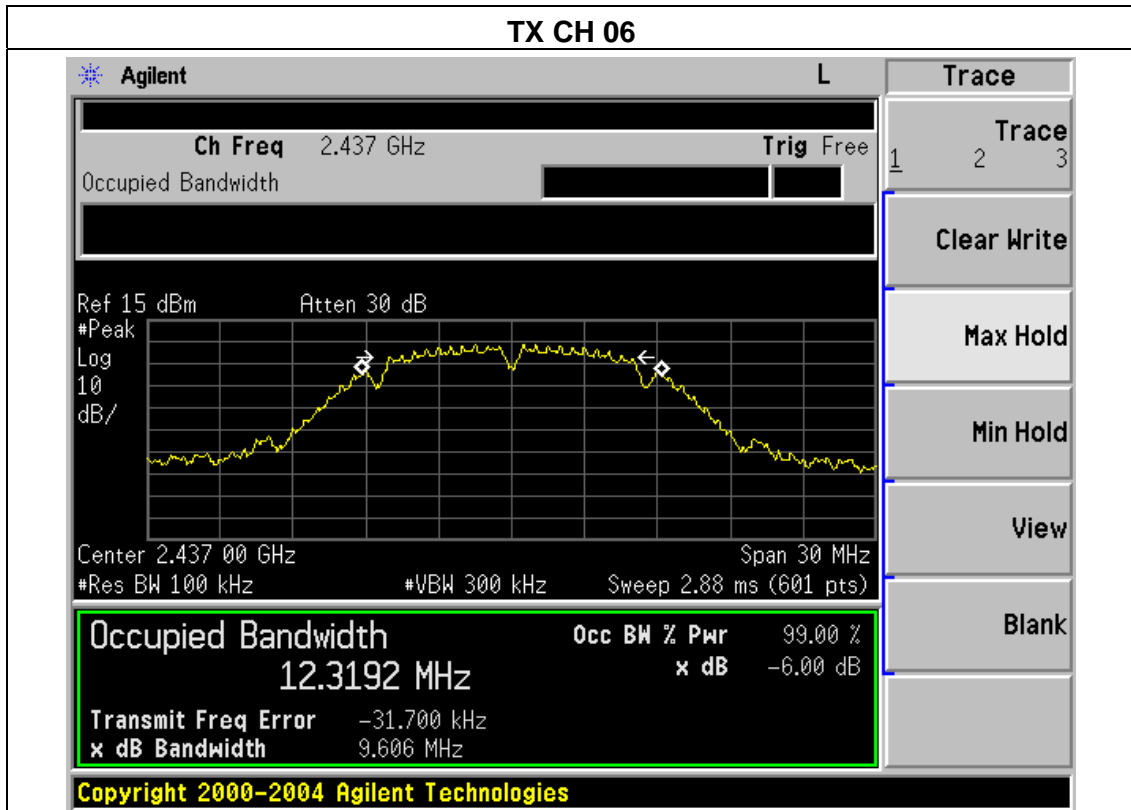

EUT :	smartphone	Model Name :	E535
Temperature :	25 °C	Relative Humidity :	60%
Pressure :	1012 hPa	Test Voltage :	DC 3.8V
Test Mode :	TX g Mode /CH01, CH06, CH11		

Channel	Frequency (MHz)	6dB bandwidth (MHz)	Limit (kHz)	Result
Low	2412	15.121	500	Pass
Middle	2437	15.493	500	Pass
High	2462	15.386	500	Pass

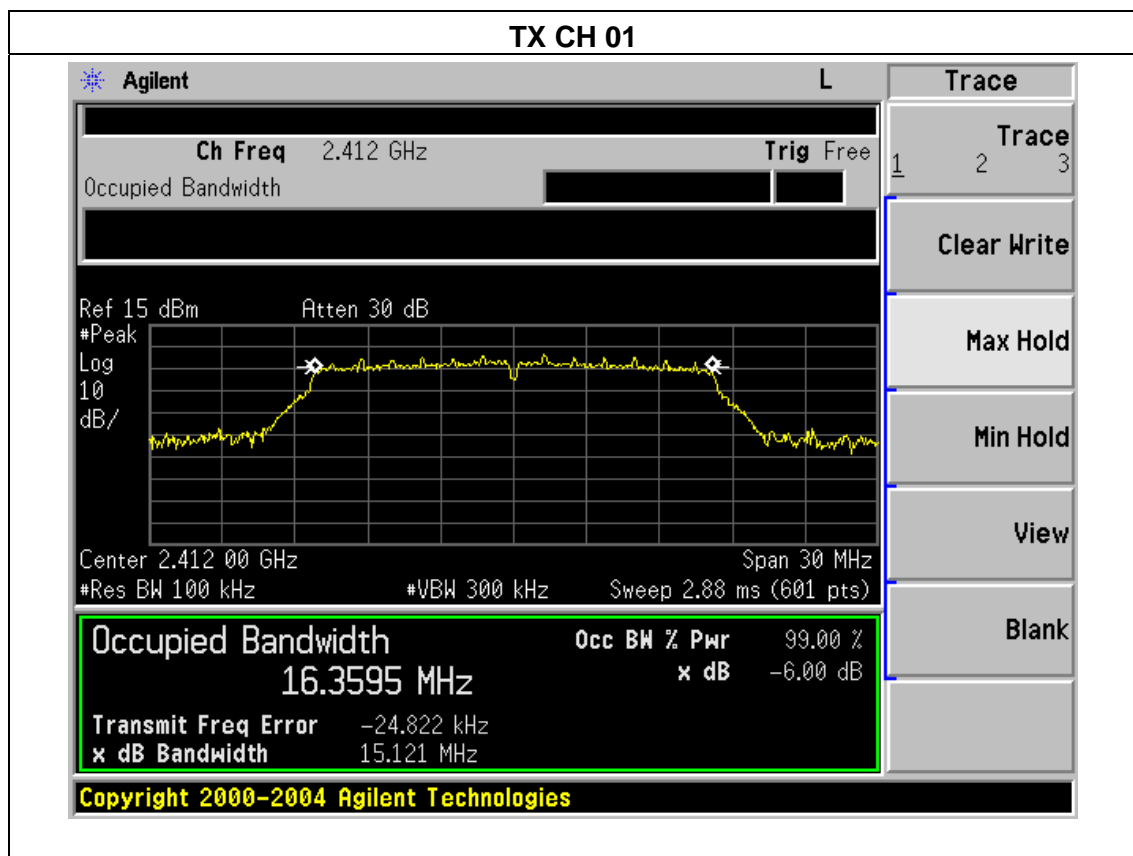

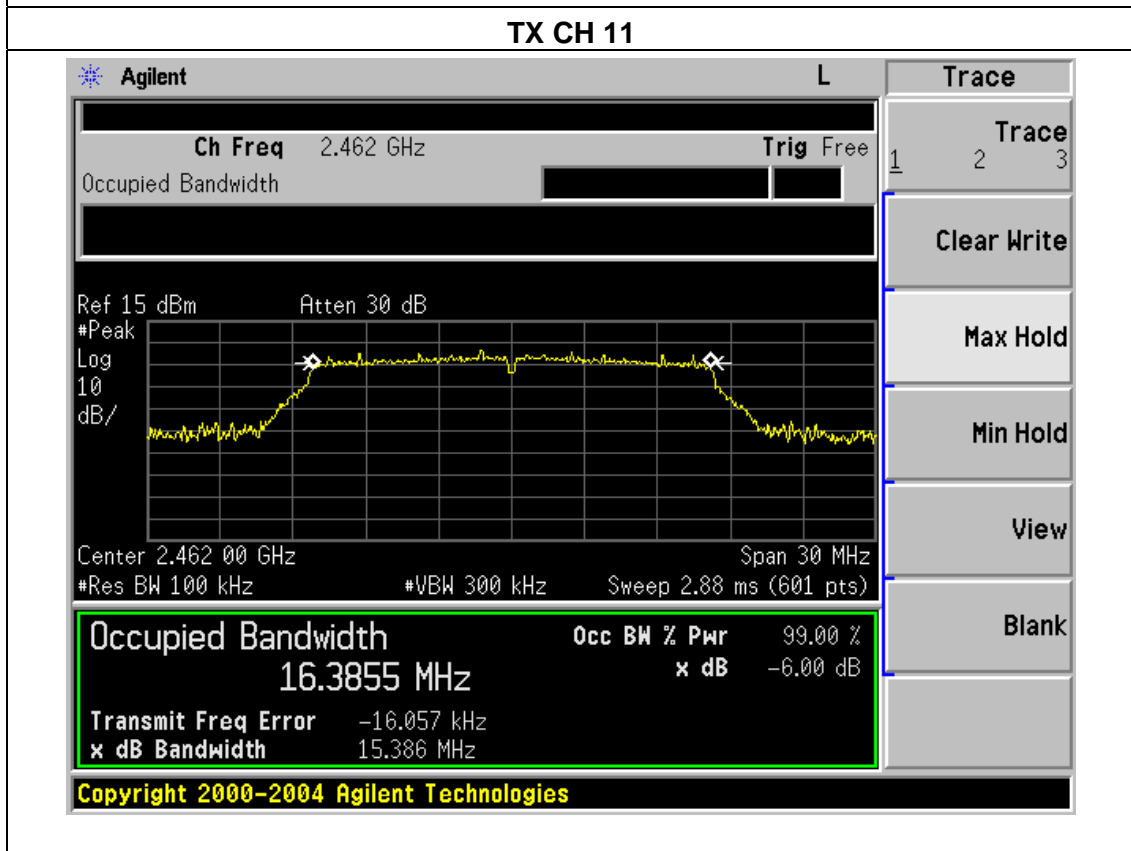
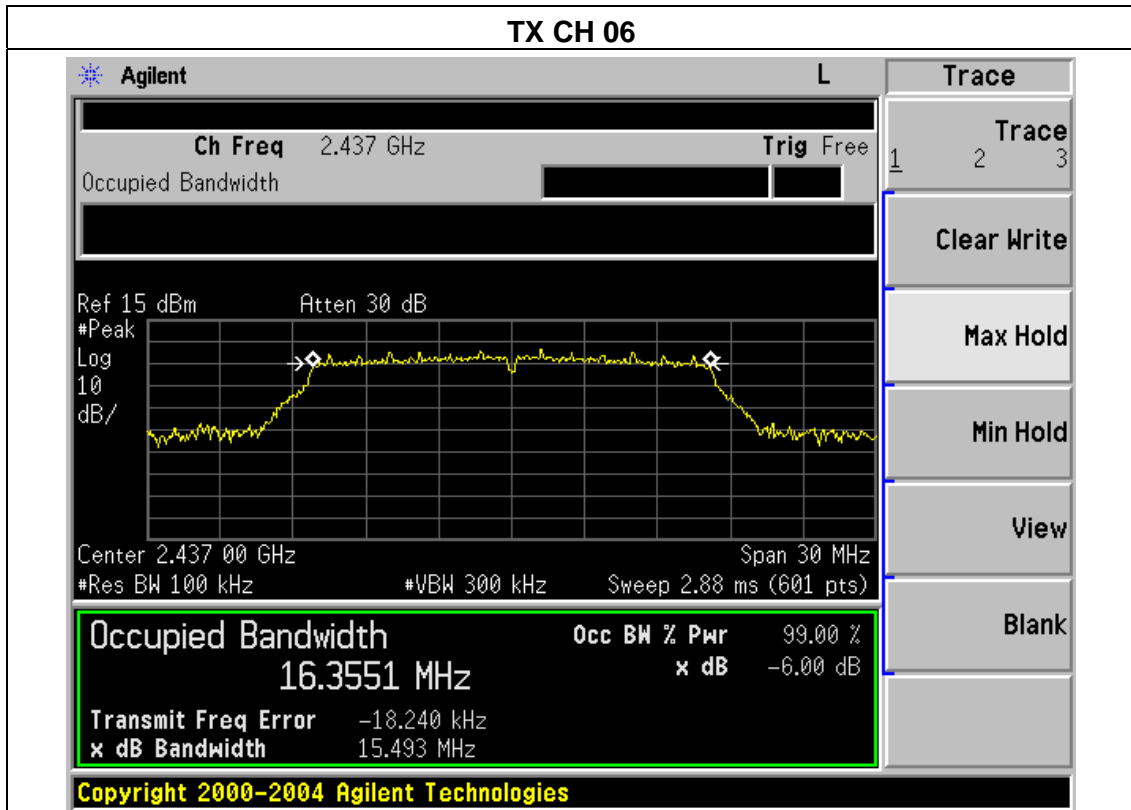

EUT :	smartphone	Model Name :	E535
Temperature :	25 °C	Relative Humidity :	56%
Pressure :	1012 hPa	Test Voltage :	DC 3.8V
Test Mode :	TX n Mode(20M) /CH01, CH06, CH11		

Channel	Frequency (MHz)	6dB bandwidth (MHz)	Limit (kHz)	Result
Low	2412	15.166	500	Pass
Middle	2437	15.177	500	Pass
High	2462	15.164	500	Pass

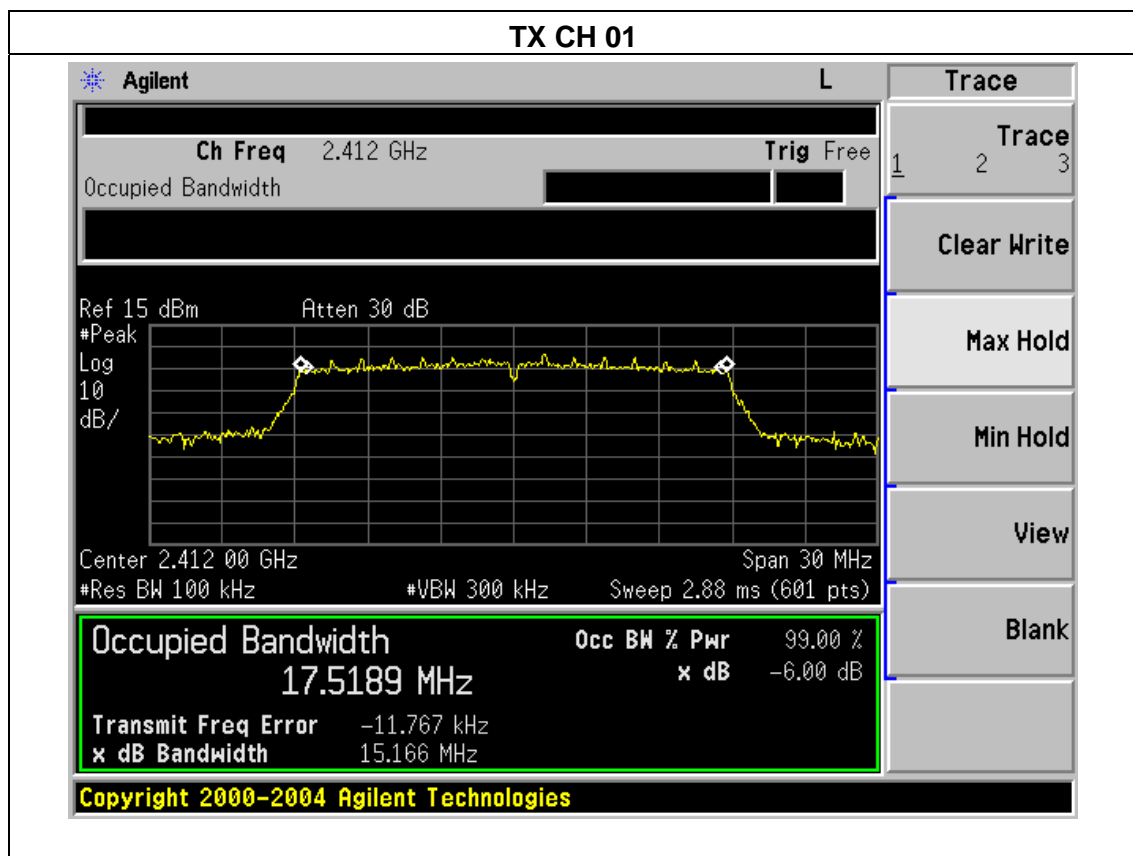

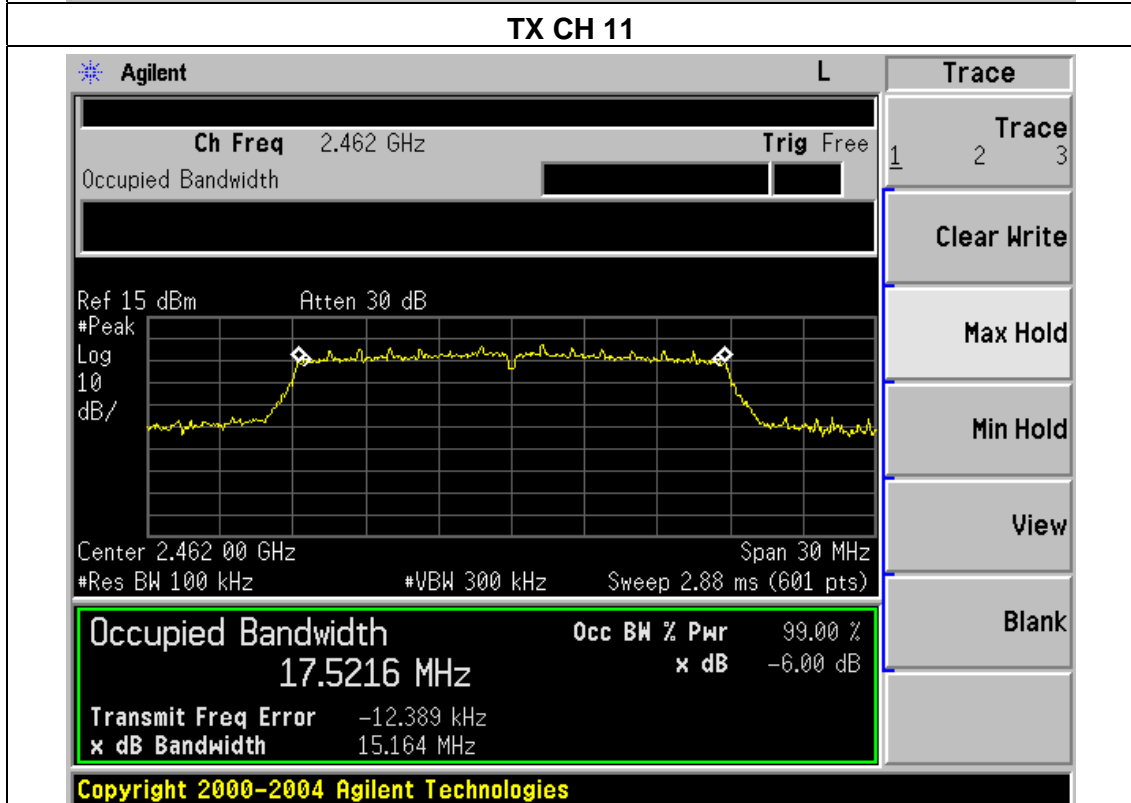
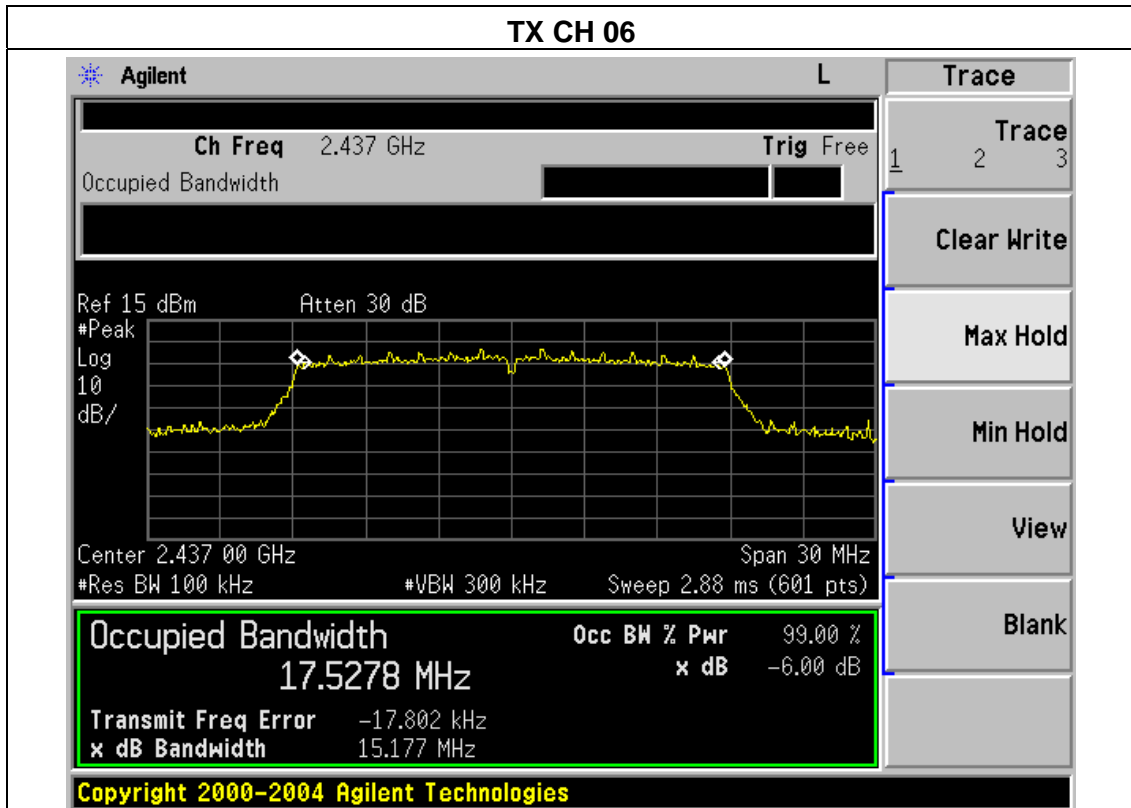

EUT :	smartphone	Model Name :	E535
Temperature :	25 °C	Relative Humidity :	56%
Pressure :	1012 hPa	Test Voltage :	DC 3.8V
Test Mode :	TX n Mode(40M) /CH03, CH06, CH09		

Channel	Frequency (MHz)	6dB bandwidth (MHz)	Limit (kHz)	Result
Low	2422	35.279	500	Pass
Middle	2437	35.293	500	Pass
High	2452	35.277	500	Pass

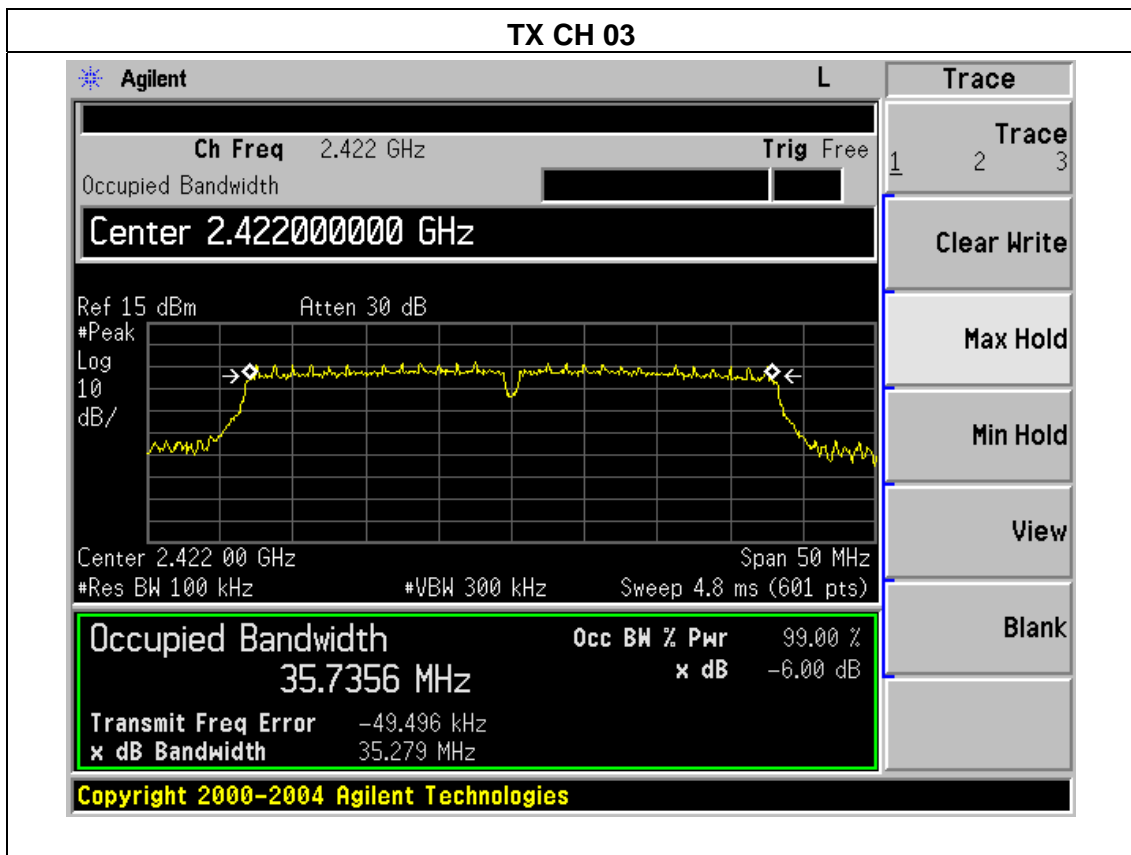

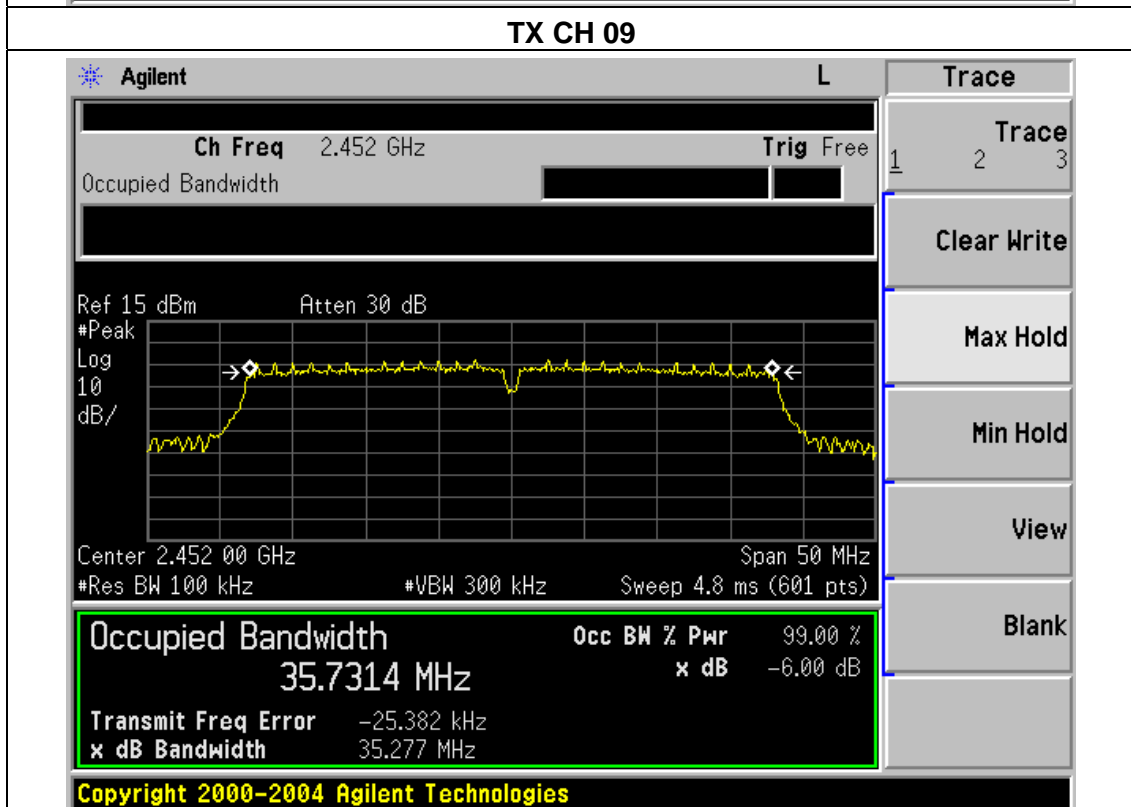
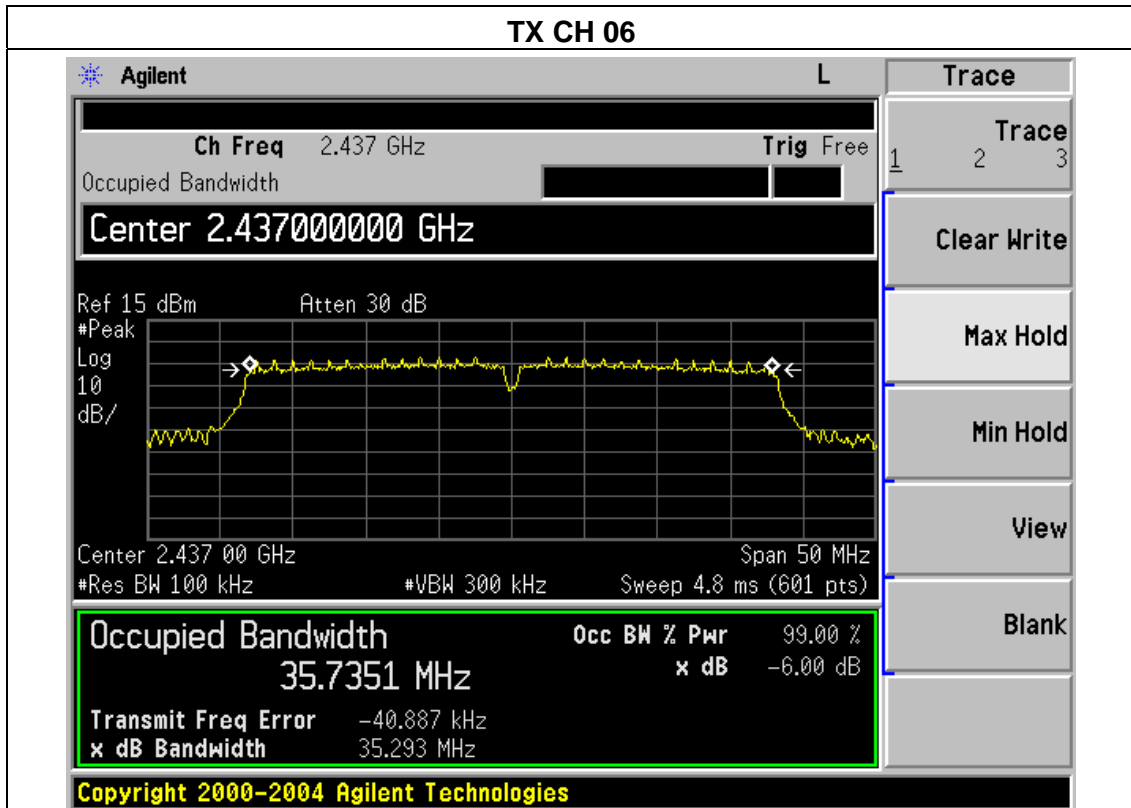

6. PEAK OUTPUT POWER TEST

6.1 APPLIED PROCEDURES / LIMIT

FCC Part15 (15.247) , Subpart C				
Section	Test Item	Limit	Frequency Range (MHz)	Result
15.247(b)(3)	Peak Output Power	1 watt or 30dBm	2400-2483.5	PASS

6.1.1 TEST PROCEDURE

- a. The EUT was directly connected to the Power meter

6.1.2 DEVIATION FROM STANDARD

No deviation.

6.1.3 TEST SETUP

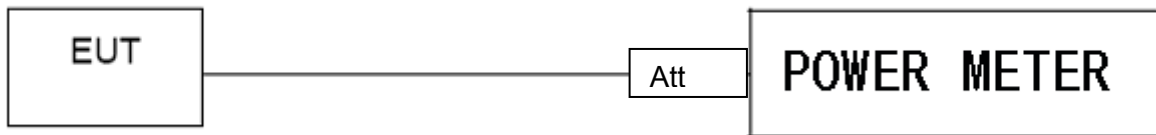

6.1.4 EUT OPERATION CONDITIONS

The EUT tested system was configured as the statements of 2.4 Unless otherwise a special operating condition is specified in the follows during the testing.

6.1.5 TEST RESULTS

EUT :	smartphone	Model Name :	E535
Temperature :	25 °C	Relative Humidity :	60%
Pressure :	1012 hPa	Test Voltage :	DC 3.8V
Test Mode :	TX b/g/n(20M/40M) Mode		

TX 802.11b Mode				
Test Channel	Frequency	Maximum Peak Conducted Output Power (PK)	Maximum Peak Conducted Output Power (AV)	LIMIT
	(MHz)	(dBm)	(dBm)	dBm
CH01	2412	15.94	13.12	30
CH06	2437	15.96	13.14	30
CH11	2462	15.97	13.15	30
TX 802.11g Mode				
CH01	2412	14.66	11.53	30
CH06	2437	14.75	11.62	30
CH11	2462	14.72	11.59	30
TX 802.11n(20) Mode				
CH01	2412	13.96	11.73	30
CH06	2437	13.95	11.72	30
CH11	2462	13.97	11.74	30
TX 802.11n(40) Mode				
CH03	2422	12.11	9.69	30
CH06	2437	12.24	9.82	30
CH09	2452	12.18	9.76	30

7. 100 KHZ BANDWIDTH OF FREQUENCY BAND EDGE

APPLICABLE STANDARD

In any 100 kHz bandwidth outside the frequency band in which the spread spectrum or digitally modulated intentional radiator is operating, the radio frequency power that is produced by the intentional radiator shall be at least 20 dB below that in the 100 kHz bandwidth within the band that contains the highest level of the desired power, based on either an RF conducted or a radiated measurement, provided the transmitter demonstrates compliance with the peak conducted power limits. If the transmitter complies with the conducted power limits based on the use of RMS averaging over a time interval, as permitted under paragraph (b)(3) of this section, the attenuation required under this paragraph shall be 30 dB instead of 20 dB. Attenuation below the general limits specified in §15.209(a) is not required. In addition, radiated emissions which fall in the restricted bands, as defined in §15.205(a), must also comply with the radiated emission limits specified in §15.209(a) (see §15.205(c)).

TEST PROCEDURE

- a) Check the calibration of the measuring instrument using either an internal calibrator or a known signal from an external generator.
- b) Position the EUT without connection to measurement instrument. Turn on the EUT and connect its antenna terminal to measurement instrument via a low loss cable. Then set it to any one measured frequency within its operating range, and make sure the instrument is operated in its linear range.
- c) Set RBW to 100 kHz and VBW of spectrum analyzer to 300 kHz with a convenient frequency span including 100 kHz bandwidth from band edge.
- d) Measure the highest amplitude appearing on spectral display and set it as a reference level. Plot the graph with marking the highest point and edge frequency.
- e) Repeat above procedures until all measured frequencies were complete.

7.1 DEVIATION FROM STANDARD

No deviation.

7.2 TEST SETUP

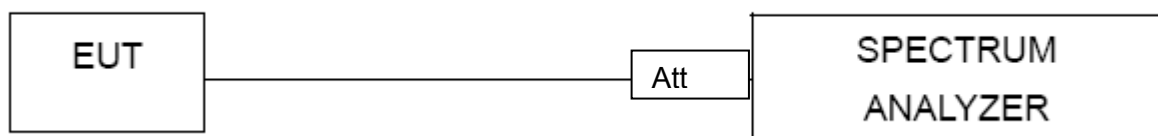

7.3 EUT OPERATION CONDITIONS

The EUT tested system was configured as the statements of 2.4 Unless otherwise a special operating condition is specified in the follows during the testing.

7.4 TEST RESULTS

EUT :	smartphone	Model Name :	E535
Temperature :	25 °C	Relative Humidity :	56%
Pressure :	1012 hPa	Test Voltage :	DC 3.8V

Frequency Band MHz	Delta Peak to band emission (dBc)	> Limit (dBc)	Result
802.11b mode			
2400	48.38	20	Pass
2483.5	61.35	20	Pass
802.11g mode			
2400	35.05	20	Pass
2483.5	41.64	20	Pass
802.11n-HT20 mode			
2400	35.73	20	Pass
2483.5	42.66	20	Pass
802.11n-HT40 mode			
2400	37.17	20	Pass
2483.5	39.12	20	Pass

Radiated band edge:

Frequency (MHz)	Meter Reading (dBμV)	Factor (dB)	Emission Level (dBμV/m)	Limits (dBμV/m)	Margin (dB)	Detector Type	Comment
802.11b							
2390	58.67	-13.06	45.61	74	-28.39	peak	Vertical
2390	58.4	-13.06	45.34	74	-28.66	peak	Horizontal
2483.5	59.59	-12.78	46.81	74	-27.19	peak	Vertical
2483.5	59.61	-12.78	46.83	74	-27.17	peak	Horizontal
802.11g							
2390	58.25	-13.06	45.19	74	-28.81	peak	Vertical
2390	57.48	-13.06	44.42	74	-29.58	peak	Horizontal
2483.5	58.97	-12.78	46.19	74	-27.81	peak	Vertical
2483.5	59.36	-12.78	46.58	74	-27.42	peak	Horizontal
802.11n (20)							
2390	61.18	-13.06	48.12	74	-25.88	peak	Vertical
2390	60.96	-13.06	47.9	74	-26.10	peak	Horizontal
2483.5	61.1	-12.78	48.32	74	-25.68	peak	Vertical
2483.5	61.24	-12.78	48.46	74	-25.54	peak	Horizontal
802.11n (40)							
2390	61.94	-13.06	48.88	74	-25.12	peak	Vertical
2390	63.09	-13.06	50.03	74	-23.97	peak	Horizontal
2483.5	61.59	-12.78	48.81	74	-25.19	peak	Vertical
2483.5	61.56	-12.78	48.78	74	-25.22	peak	Horizontal

Note: Test method to see chapter 3.2 . When PK value is lower than the Average value limit, average not record.

802.11b: Band Edge, Right Side

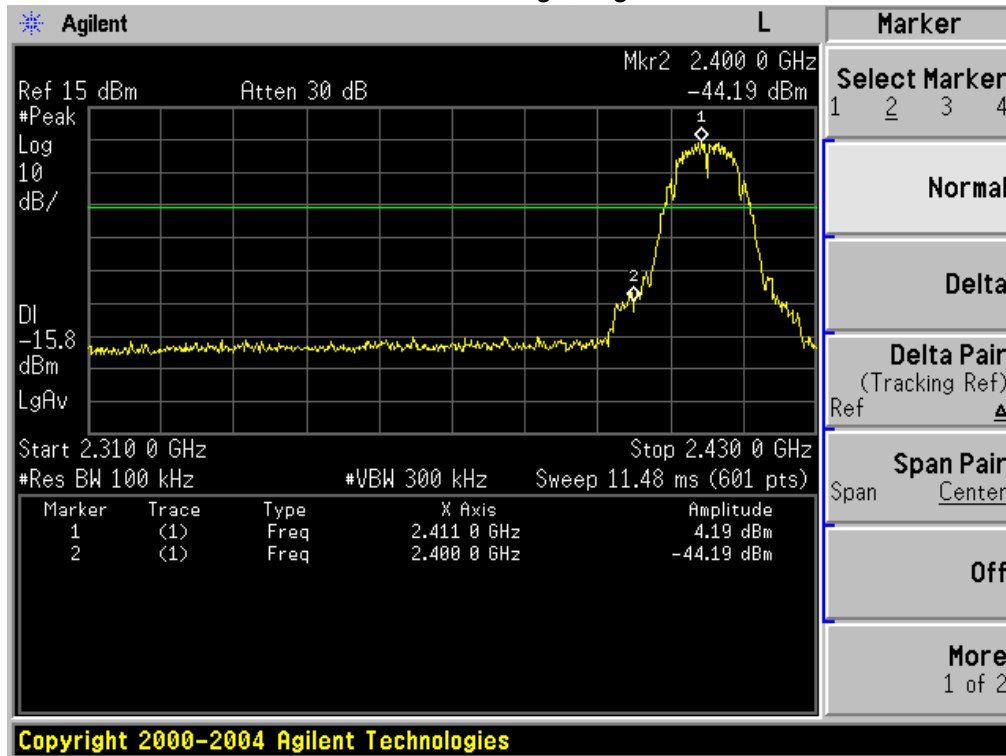

802.11b: Band Edge, Left Side

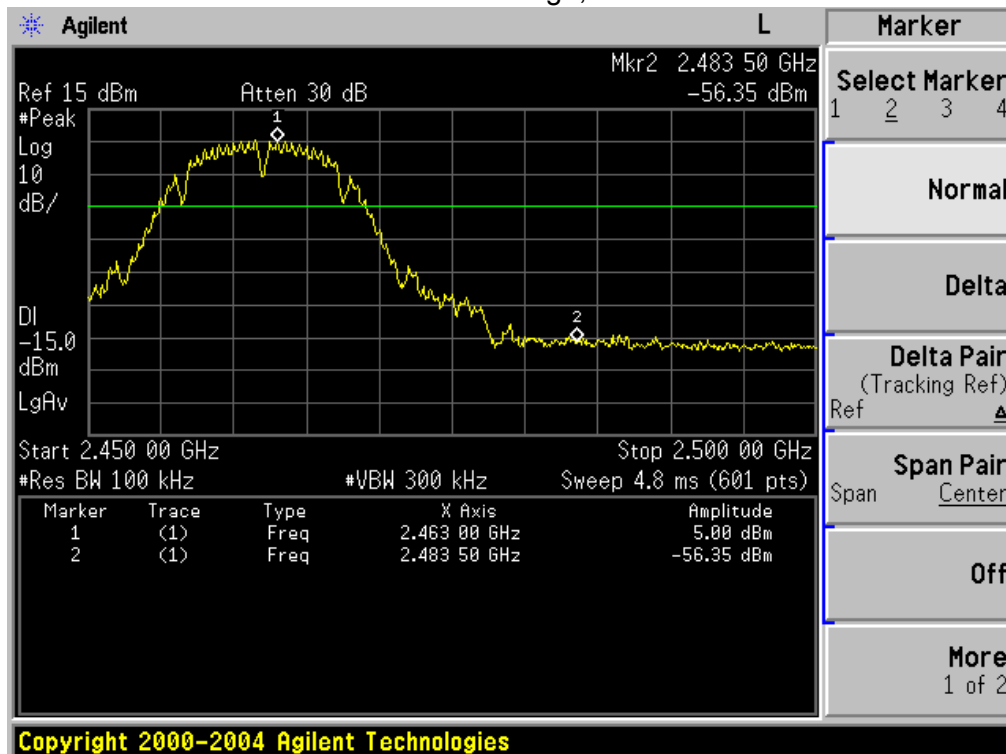

802.11g: Band Edge, Right Side

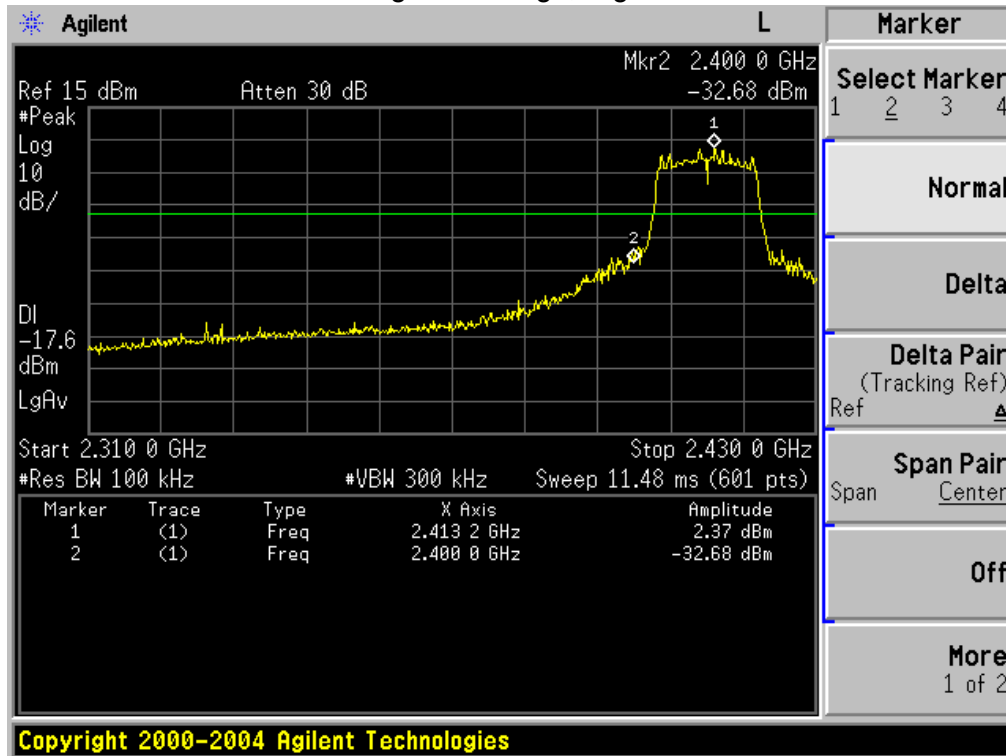

802.11g: Band Edge, Left Side

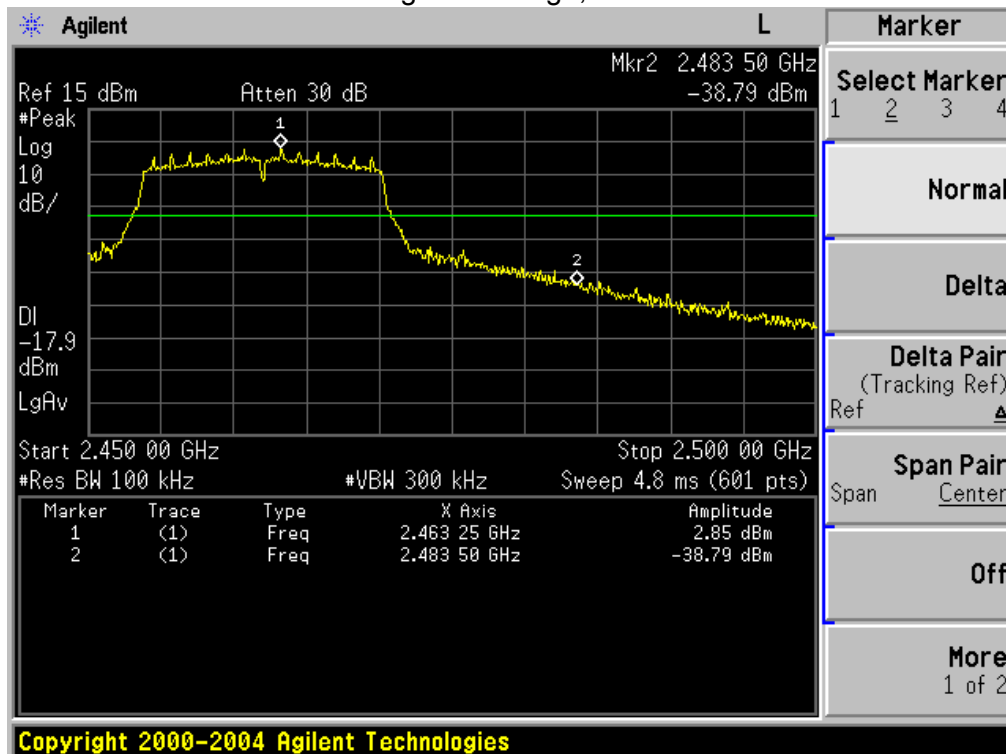

802.11n-HT20: Band Edge, Right Side

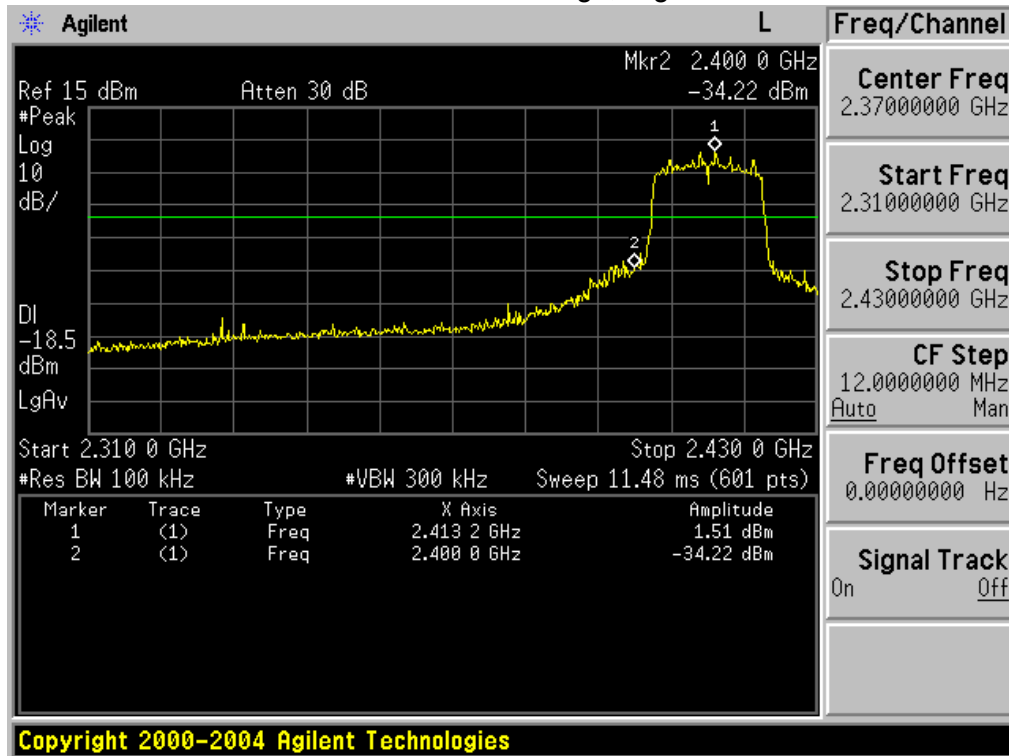

802.11n-HT20: Band Edge, Left Side

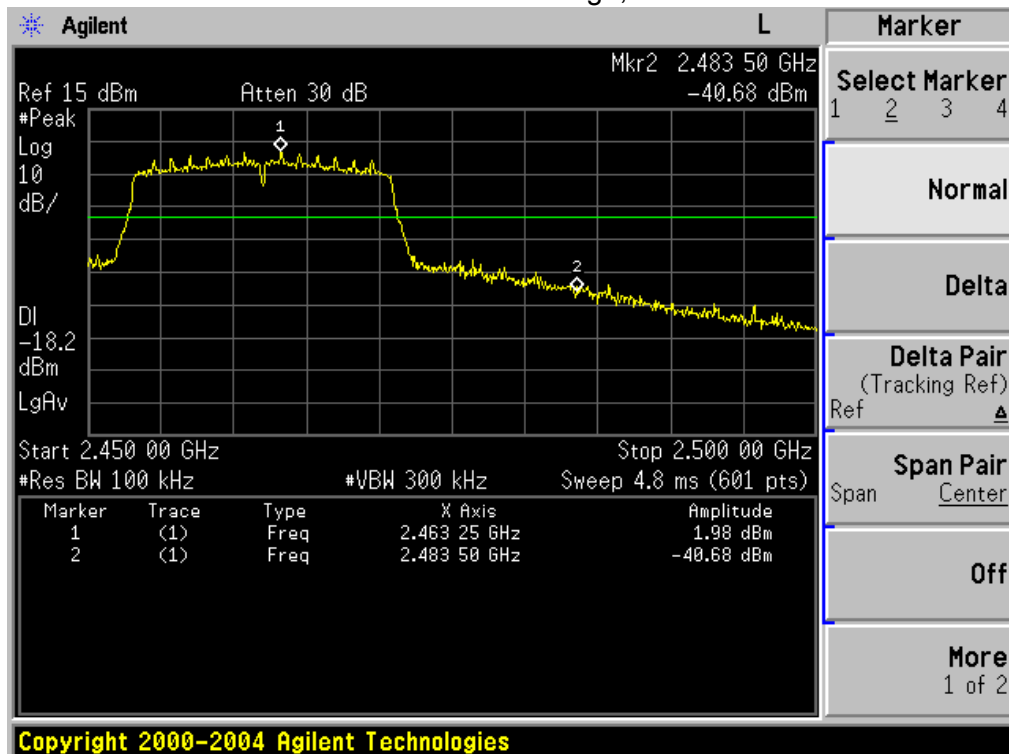

802.11n-HT40: Band Edge, Right Side

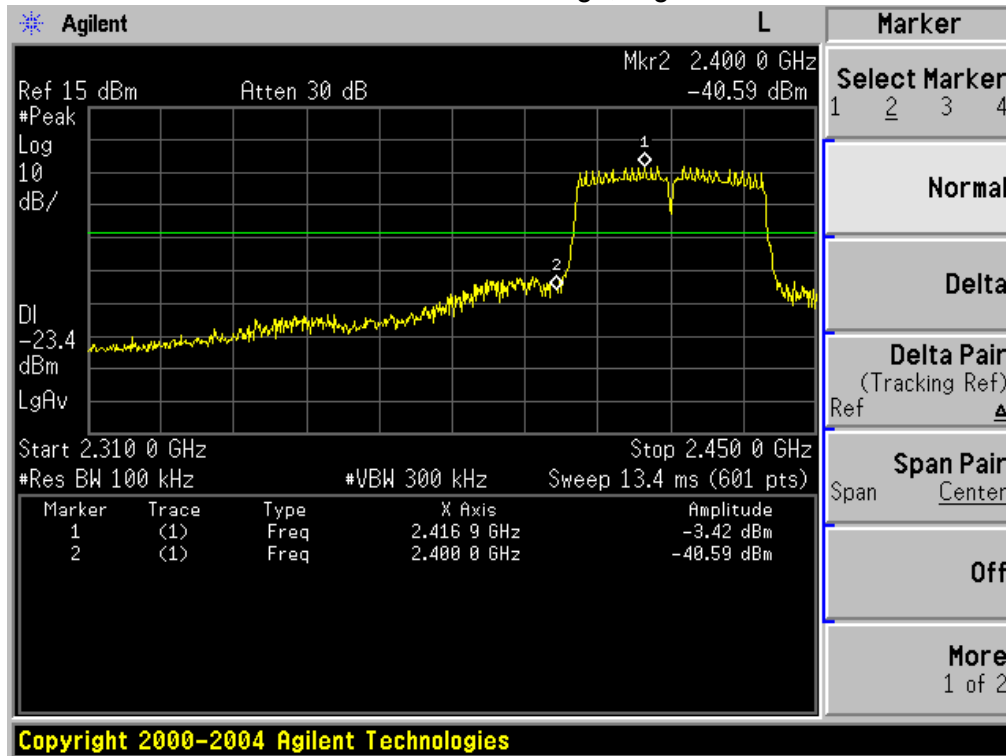

802.11n-HT40: Band Edge, Left Side

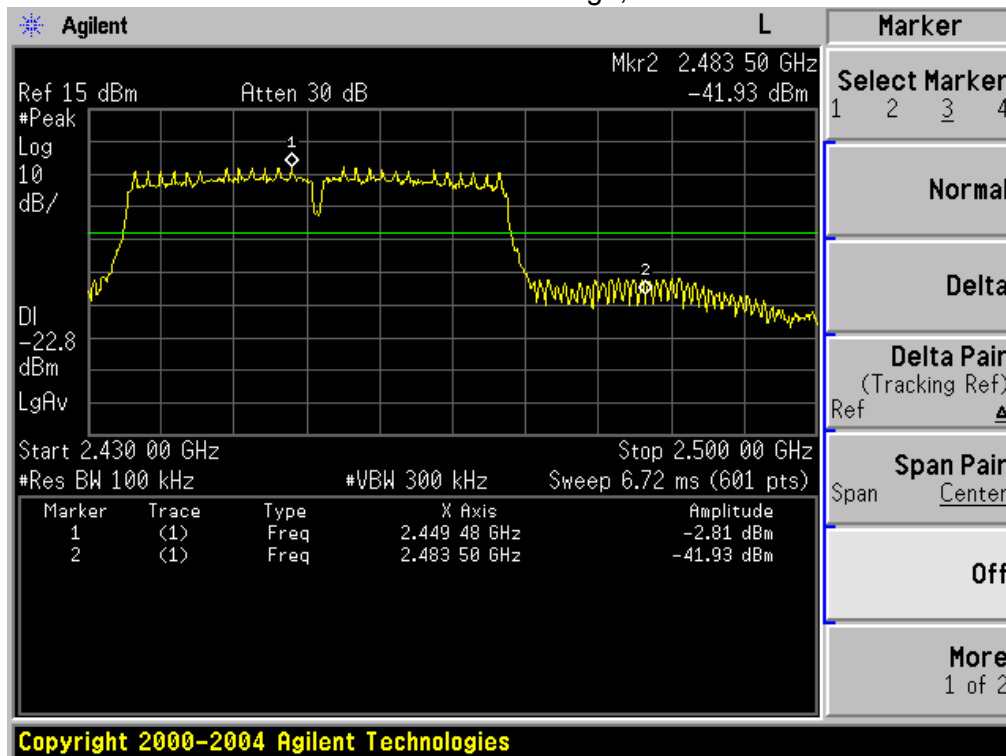

8. ANTENNA REQUIREMENT

8.1 STANDARD REQUIREMENT

15.203 requirement: For intentional device, according to 15.203: an intentional radiator shall be designed to ensure that no antenna other than that furnished by the responsible party shall be used with the device.

8.2 EUT ANTENNA

The EUT antenna is permanent attached antenna. It comply with the standard requirement.

9. EUT TEST PHOTO

Radiated Measurement Photos

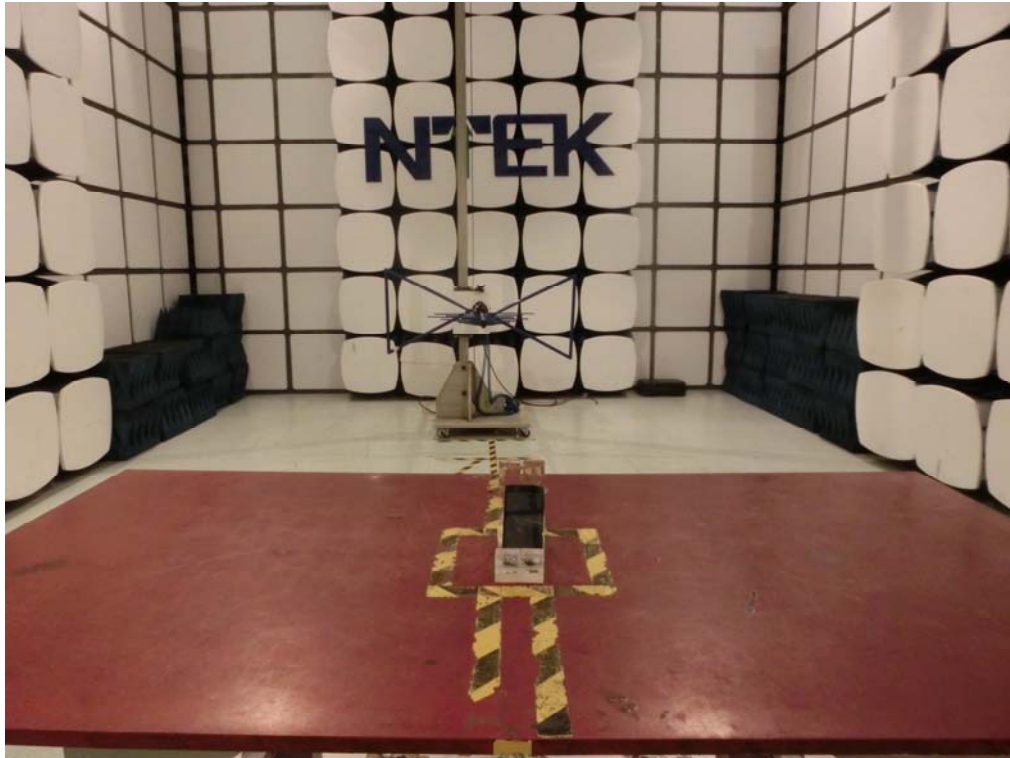

CONDUCTED EMISSION Photos

