

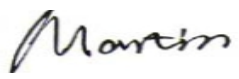

FCC TEST REPORT

47 CFR FCC Part 15 Subpart B

Report Reference No.....:	MWR160229106	
FCC ID.....:	RQQHLT-E55UTM	
Compiled by (position+printed name+signature)..:	File administrators Martin Ao	
Supervised by (position+printed name+signature)..:	Test Engineer Yuchao Wang	
Approved by (position+printed name+signature)..:	Manager Dixon Hao	
Date of issue.....:	Feb. 29, 2016	
Representative Laboratory Name ..:	Maxwell International Co., Ltd.	
Address ..:	Room 509, Hongfa center building, Baoan District, Shenzhen, Guangdong, China	
Testing Laboratory Name ..:	Shenzhen CTL Testing Technology Co., Ltd.	
Address ..:	Floor 1-A, Baisha Technology Park, No.3011, Shahexi Road, Nanshan District, Shenzhen, China 518055	
Applicant's name.....:	HYUNDAI CORPORATION	
Address ..:	140-2, Kye-dong, Chongro-ku, Seoul, South Korea	
Test specification ..:		
Standard ..:	47 CFR FCC Part 15 Subpart B - Unintentional Radiators ANSI C63.4: 2014	
TRF Originator.....:	Maxwell International Co., Ltd.	
Maxwell International Co., Ltd. All rights reserved.		
This publication may be reproduced in whole or in part for non-commercial purposes as long as the Maxwell International Co., Ltd. as copyright owner and source of the material. Maxwell International Co., Ltd. takes no responsibility for and will not assume liability for damages resulting from the reader's interpretation of the reproduced material due to its placement and context.		
Test item description ..:	Mobile Phone	
Trade Mark ..:	HYUNDAI	
Manufacturer.....:	Shenzhen Rainbow Time Technology Co.,Ltd	
Model/Type reference.....:	TITAN 5K	
Listed Models ..:	/	
Rating ..:	DC 3.70V	
Hardware version ..:	5101DW_WI_V02	
Software version ..:	V2.0	
Result.....:	PASS	

TEST REPORT

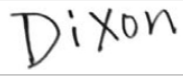
Test Report No. :	MWR160229106	Feb. 29, 2016
		Date of issue

Equipment under Test : Mobile Phone

Model /Type : TITAN 5K

Listed Models : /

Applicant : **HYUNDAI CORPORATION**

Address : 140-2, Kye-dong, Chongro-ku, Seoul, South Korea

Manufacturer : **Shenzhen Rainbow Time Technology Co.,Ltd**

Address : Room 905, ChangHong Technology Building, Science and Technology Park, Nanshan District, Shenzhen, China

Test Result:	PASS
---------------------	-------------

The test report merely corresponds to the test sample.
It is not permitted to copy extracts of these test result without the written permission of the test laboratory.

Revision History

Revision	Issue Date	Revisions	Revised By
00	2016-02-29	Initial Issue	Dixon Hao

Contents

1	<u>TEST STANDARDS.....</u>	5
2	<u>SUMMARY</u>	6
2.1	General Remarks	6
2.2	Product Description	6
2.3	Equipment under Test	7
2.4	Short description of the Equipment under Test (EUT)	7
2.5	EUT operation mode	7
2.6	Related Submittal(s) / Grant (s)	7
2.7	Internal Identification of AE used during the test	7
2.8	Modifications	7
2.9	EUT configuration	8
2.10	Configuration of Tested System	8
3	<u>TEST ENVIRONMENT.....</u>	9
3.1	Address of the test laboratory	9
3.2	Test Facility	9
3.3	Environmental conditions	9
3.4	Statement of the measurement uncertainty	9
3.5	Equipments Used during the Test	10
4	<u>TEST CONDITIONS AND RESULTS.....</u>	11
4.1	Conducted Emissions Test	11
4.2	Radiated Emission Test	14
5	<u>TEST SETUP PHOTOS OF THE EUT</u>	18
6	<u>EXTERNAL PHOTOS OF THE EUT.....</u>	18
7	<u>INTERNAL PHOTOS OF THE EUT.....</u>	18

1 TEST STANDARDS

The tests were performed according to following standards:

[47 CFR FCC Part 15 Subpart B](#) - Unintentional Radiators

[ANSI C63.4: 2014](#) – American National Standard for Methods of Measurement of Radio-Noise Emissions from Low-Voltage Electrical and Electronic Equipment in the Range of 9 kHz to 40GHz

2 SUMMARY

2.1 General Remarks

Date of receipt of test sample	:	Feb. 15, 2016
Testing commenced on	:	Feb. 16, 2016
Testing concluded on	:	Feb. 29, 2016

2.2 Product Description

The **HYUNDAI CORPORATION**'s Model: TITAN 5K or the "EUT" as referred to in this report; more general information as follows, for more details, refer to the user's manual of the EUT.

Name of EUT	Mobile Phone
Model Number	TITAN 5K
Modulation Type	GMSK for GSM/GPRS, 8-PSK for EDGE,QPSK for UMTS
Antenna Type	Internal
UMTS Operation Frequency Band	Device supported UMTS FDD Band II, FDD Band V
WLAN FCC Operation frequency	IEEE 802.11b:2412-2462MHz IEEE 802.11g:2412-2462MHz IEEE 802.11n HT20:2412-2462MHz IEEE 802.11n HT40:2422-2452MHz
BT FCC Operation frequency	2402MHz-2480MHz
HSDPA Release Version	Release 10
HSUPA Release Version	Release 6
DC-HSUPA Release Version	Not Supported
WCDMA Release Version	R99
WLAN FCC Modulation Type	IEEE 802.11b: DSSS(CCK,DQPSK,DBPSK) IEEE 802.11g: OFDM(64QAM, 16QAM, QPSK, BPSK) IEEE 802.11n HT20: OFDM (64QAM, 16QAM, QPSK,BPSK) IEEE 802.11n HT40: OFDM (64QAM, 16QAM, QPSK,BPSK)
BT Modulation Type	GFSK,8DPSK, π /4DQPSK(BT 3.0+EDR)
Hardware version	5101DW_WI_V02
Software version	V2.0
Android version	Android 5.1
GPS function	Supported
WLAN	Supported 802.11b/802.11g/802.11n
Bluetooth	Supported BT 4.0/BT 3.0+EDR
GSM/EDGE/GPRS	Supported GSM/GPRS/EDGE
GSM/EDGE/GPRS Power Class	GSM850:Power Class 4/ PCS1900:Power Class 1
GSM/EDGE/GPRS Operation Frequency	GSM850 :824.2MHz-848.8MHz/PCS1900:1850.2MHz-1909.8MHz
GSM/EDGE/GPRS Operation Frequency Band	GSM850/PCS1900/GPRS850/GPRS1900/EDGE850/EDGE1900
GSM Release Version	R99
GPRS/EDGE Multislot Class	GPRS/EDGE: Multi-slot Class 12
Extreme temp. Tolerance	-30°C to +50°C
Extreme vol. Limits	3.40VDC to 4.20VDC (nominal: 3.70VDC)
GPRS operation mode	Class B

2.3 Equipment under Test

Power supply system utilised

Power supply voltage	:	<input type="radio"/>	120V / 60 Hz	<input type="radio"/>	115V / 60Hz
		<input type="radio"/>	12 V DC	<input type="radio"/>	24 V DC
		<input checked="" type="radio"/>	Other (specified in blank below)		

DC 3.70V

2.4 Short description of the Equipment under Test (EUT)

2.4.1 General Description

TITAN 5K is subscriber equipment in the WCDMA/GSM system. The HSPA/UMTS frequency band is Band I, Band II and Band V; The GSM/GPRS/EDGE frequency band includes GSM850 and GSM900 and DCS1800 and PCS1900, but only Band II, Band V, GSM850 and PCS1900 bands test data included in this report. The Mobile Phone implements such functions as RF signal receiving/transmitting, HSPA/UMTS and GSM/GPRS/EDGE protocol processing, voice, video MMS service, GPS and WIFI etc. Externally it provides micro SD card interface, earphone port (to provide voice service) and SIM card interface. It also provides Bluetooth module to synchronize data between a PC and the phone, or to use the built-in modem of the phone to access the Internet with a PC, or to exchange data with other Bluetooth devices.

NOTE: Unless otherwise noted in the report, the functional boards installed in the units shall be selected from the below list, but not means all the functional boards listed below shall be installed in one unit.

2.4.2 Test Environments

NOTE: The values used in the test report maybe stringent than the declared.

Environment Parameter	Selected Values During Tests		
NTNV	Temperature	Voltage	Relative Humidity
	Ambient	3.7VDC	Ambient

2.5 EUT operation mode

The EUT has been tested under typical operating condition.

2.6 Related Submittal(s) / Grant (s)

This submittal(s) (test report) is intended for **FCC ID: FCC ID: RQQHLT-E55UTM** filing to comply with FCC Part 15, Subpart B Rules.

2.7 Internal Identification of AE used during the test

AE ID*	Description
AE1	Charger

AE1
 Model: DC500
 INPUT: AC180-240V~ 50/60Hz 0.15A
 OUTPUT: DC 5.0V 1000mA

*AE ID: is used to identify the test sample in the lab internally.
 We not used AE1 when for FCC Part 15B test.

2.8 Modifications

No modifications were implemented to meet testing criteria.

2.9 EUT configuration

The following peripheral devices and interface cables were connected during the measurement:

● - supplied by the manufacturer

○ - supplied by the lab

○	Power Cable	Length (m) :	/
		Shield :	/
		Detachable :	/
○	Multimeter	Manufacturer :	/
		Model No. :	/

2.10 Configuration of Tested System

Configuration of Tested System

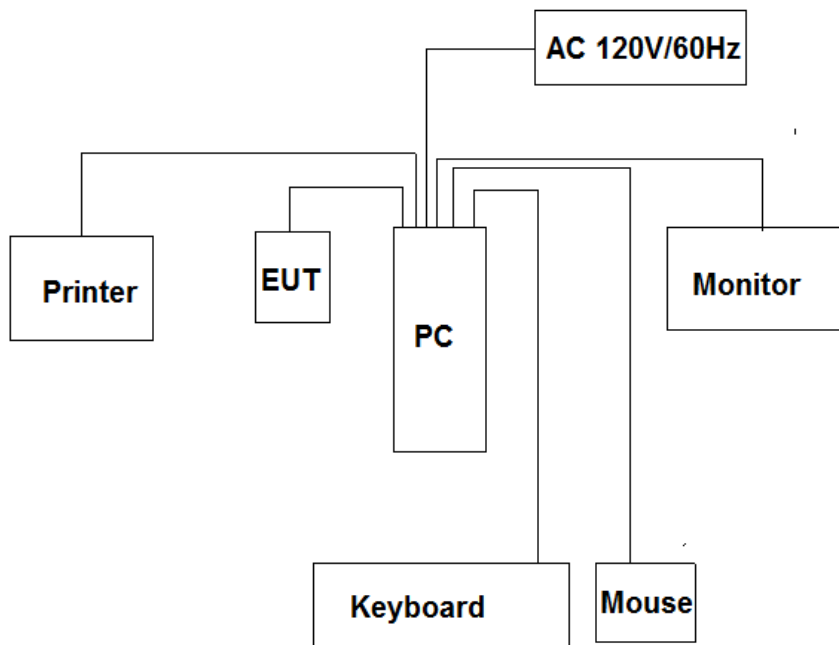

Equipment Used in Tested System

No.	Equipment	Manufacturer	Model No.	Serial No.	Length	shielded/unshielded	Notes
1	PC	HP	Pavalion	A131101550	/	/	DOC
2	Mouse	DELL	MO56UO A	G0E02SY7	1.00m	unshielded	DOC
3	Keyboard	DELL	KB212	H548787	1.00m	unshielded	DOC
4	Monitor	DELL	W1972a	6CM3212F7C	/	/	DOC
5	Printer	Epson	R230	R8792T58	/	/	DOC
6	USB Cable (EUT to PC)	Genshuo	USB 2.0	N/A	0.60m	unshielded	N/A
7	Power line	/	/	N/A	1.00m	unshielded	N/A

3 TEST ENVIRONMENT

3.1 Address of the test laboratory

Shenzhen CTL Testing Technology Co., Ltd.

Floor 1-A, Baisha Technology Park, No. 3011, Shahexi Road, Nanshan, Shenzhen 518055 China

There is one 3m semi-anechoic chamber and two line conducted labs for final test. The Test Sites meet the requirements in documents ANSI C63.4, CISPR 22/EN 55022 and CISPR16-4-1 SVSWR requirements.

3.2 Test Facility

The test facility is recognized, certified, or accredited by the following organizations:

IC Registration No.: 9618B

The 3m alternate test site of Shenzhen CTL Testing Technology Co., Ltd. EMC Laboratory has been registered by Certification and Engineer Bureau of Industry Canada for the performance of with Registration No.: 9618B on November 13, 2013.

FCC-Registration No.: 970318

Shenzhen CTL Testing Technology Co., Ltd. EMC Laboratory has been registered and fully described in a report filed with the (FCC) Federal Communications Commission. The acceptance letter from the FCC is maintained in our files. Registration 970318, December 19, 2013.

3.3 Environmental conditions

During the measurement the environmental conditions were within the listed ranges:

Temperature: 15-35 ° C

Humidity: 30-60 %

Atmospheric pressure: 950-1050mbar

3.4 Statement of the measurement uncertainty

The data and results referenced in this document are true and accurate. The reader is cautioned that there may be errors within the calibration limits of the equipment and facilities. The measurement uncertainty was calculated for all measurements listed in this test report acc. to CISPR 16 - 4 "Specification for radio disturbance and immunity measuring apparatus and methods – Part 4: Uncertainty in EMC Measurements" and is documented in the Shenzhen CTL Testing Technology Co., Ltd. quality system acc. to DIN EN ISO/IEC 17025. Furthermore, component and process variability of devices similar to that tested may result in additional deviation. The manufacturer has the sole responsibility of continued compliance of the device.

Hereafter the best measurement capability for CTL laboratory is reported:

Test	Range	Measurement Uncertainty	Notes
Radiated Emission	30~1000MHz	4.5 dB	(1)
Radiated Emission	1~18GHz	4.6 dB	(1)
Conducted Disturbance	0.009~30MHz	3.5 dB	(1)

(1) This uncertainty represents an expanded uncertainty expressed at approximately the 95% confidence level using a coverage factor of k=2.

3.5 Equipments Used during the Test

Test Equipment	Manufacturer	Model No.	Serial No.	Calibration Date	Calibration Due Date
LISN	R&S	ENV216	3560.6550.12	2015/06/02	2016/06/01
LISN	R&S	ESH2-Z5	860014/010	2015/06/02	2016/06/01
Bilog Antenna	Sunol Sciences Corp.	JB1	A061713	2015/06/02	2016/06/01
EMI Test Receiver	R&S	ESCI	103710	2015/06/02	2016/06/01
Spectrum Analyzer	Agilent	N9020A	MY49100067	2015/05/21	2016/05/20
Controller	EM Electronics	Controller EM 1000	N/A	2015/05/21	2016/05/20
Horn Antenna	Sunol Sciences Corp.	DRH-118	A062013	2015/05/19	2016/05/18
Active Loop Antenna	SCHWARZBECK	FMZB1519	1519-037	2015/05/19	2016/05/18
Amplifier	Agilent	8349B	3008A02306	2015/05/19	2016/05/18
Amplifier	Agilent	8447D	2944A10176	2015/05/19	2016/05/18
Temperature/ Humidity Meter	Gangxing	CTH-608	02	2015/05/20	2016/05/19
High-Pass Filter	K&L	9SH10-2700/X12750-O/O	N/A	2015/05/20	2016/05/19
High-Pass Filter	K&L	41H10-1375/U12750-O/O	N/A	2015/05/20	2016/05/19
Coaxial Cables	HUBER+SUHNER	SUCOFLEX 104PEA-10M	10m	2015/06/02	2016/06/01
Coaxial Cables	HUBER+SUHNER	SUCOFLEX 104PEA-3M	3m	2015/06/02	2016/06/01
Coaxial Cables	HUBER+SUHNER	SUCOFLEX 104PEA-3M	3m	2015/06/02	2016/06/01
RF Cable	Megalon	RF-A303	N/A	2015/06/02	2016/06/01
Power Sensor	R&S	NRP-Z4	823.3618.03	2015/06/02	2016/06/01
Power Meter	R&S	NRVS	1020.1809.02	2015/06/02	2016/06/01

4 TEST CONDITIONS AND RESULTS

4.1 Conducted Emissions Test

TEST CONFIGURATION

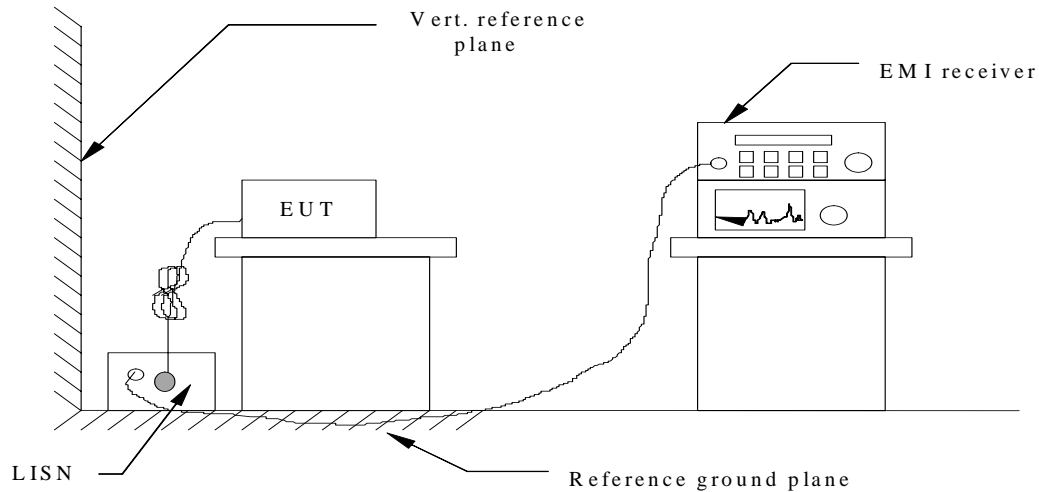

TEST PROCEDURE

1. The equipment was set up as per the test configuration to simulate typical actual usage per the user's manual. The EUT is a tabletop system; a wooden table with a height of 0.8 meters is used and is placed on the ground plane as per ANSI C63.4-2014.
2. Support equipment, if needed, was placed as per ANSI C63.4-2014.
3. All I/O cables were positioned to simulate typical actual usage as per ANSI C63.4-2014.
4. The EUT received AC120V/60Hz power through a Line Impedance Stabilization Network (LISN) which supplied power source and was grounded to the ground plane.
5. All support equipments received AC power from a second LISN, if any.
6. The EUT test program was started. Emissions were measured on each current carrying line of the EUT using a spectrum Analyzer / Receiver connected to the LISN powering the EUT. The LISN has two monitoring points: Line 1 (Hot Side) and Line 2 (Neutral Side). Two scans were taken: one with Line 1 connected to Analyzer / Receiver and Line 2 connected to a 50 ohm load; the second scan had Line 1 connected to a 50 ohm load and Line 2 connected to the Analyzer / Receiver.
7. Analyzer / Receiver scanned from 150 KHz to 30MHz for emissions in each of the test modes.
8. During the above scans, the emissions were maximized by cable manipulation.

CONDUCTED POWER LINE EMISSION LIMIT

For unintentional device, according to § 15.107(a) Line Conducted Emission Limits is as following :

Frequency (MHz)	Maximum RF Line Voltage (dB μ V)			
	CLASS A		CLASS B	
	Q.P.	Ave.	Q.P.	Ave.
0.15 - 0.50	79	66	66-56*	56-46*
0.50 - 5.00	73	60	56	46
5.00 - 30.0	73	60	60	50

* Decreasing linearly with the logarithm of the frequency

TEST RESULTS

Note: We tested the playing video Mode, Data transmission (connected PC) Mode, camera Mode and so on, and recorded the worst case at the playing video Mode.

L:

SCAN TABLE: "Voltage (9K-30M)FIN"

Short Description: 150K-30M Voltage

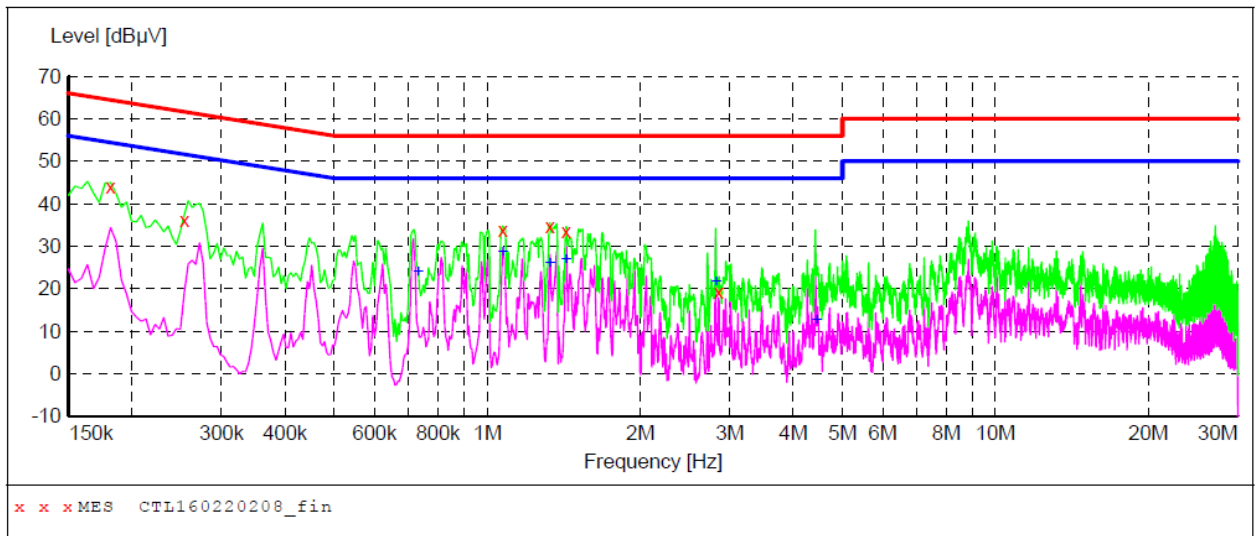

MEASUREMENT RESULT: "CTL160220208_fin"

2/20/2016 5:39PM

Frequency MHz	Level dBµV	Transd dB	Limit dBµV	Margin dB	Detector	Line	PE
0.181501	44.00	10.2	64	20.4	QP	L1	GND
0.253501	36.10	10.2	62	25.5	QP	L1	GND
1.072501	33.90	10.3	56	22.1	QP	L1	GND
1.329001	34.70	10.3	56	21.3	QP	L1	GND
1.428001	33.60	10.3	56	22.4	QP	L1	GND
2.850001	19.30	10.4	56	36.7	QP	L1	GND

MEASUREMENT RESULT: "CTL160220208_fin2"

2/20/2016 5:39PM

Frequency MHz	Level dBµV	Transd dB	Limit dBµV	Margin dB	Detector	Line	PE
0.730501	23.80	10.2	46	22.2	AV	L1	GND
1.072501	28.50	10.3	46	17.5	AV	L1	GND
1.329001	26.00	10.3	46	20.0	AV	L1	GND
1.428001	26.90	10.3	46	19.1	AV	L1	GND
2.818501	21.60	10.4	46	24.4	AV	L1	GND
4.443001	12.50	10.4	46	33.5	AV	L1	GND

N:

SCAN TABLE: "Voltage (9K-30M) FIN"

Short Description: 150K-30M Voltage

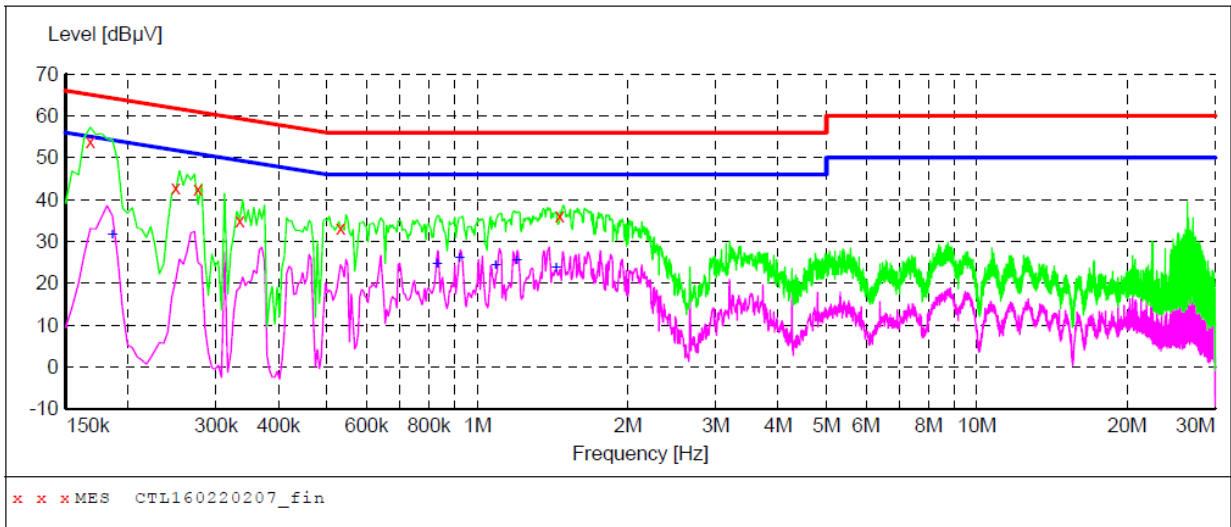

MEASUREMENT RESULT: "CTL160220207_fin"

2/20/2016 5:14PM

Frequency MHz	Level dBµV	Transd dB	Limit dBµV	Margin dB	Detector	Line	PE
0.168001	53.90	10.2	65	11.2	QP	N	GND
0.249001	42.70	10.2	62	19.1	QP	N	GND
0.276001	42.60	10.2	61	18.3	QP	N	GND
0.334501	35.00	10.2	59	24.3	QP	N	GND
0.532501	33.30	10.2	56	22.7	QP	N	GND
1.459501	36.20	10.3	56	19.8	QP	N	GND

MEASUREMENT RESULT: "CTL160220207_fin2"

2/20/2016 5:14PM

Frequency MHz	Level dBµV	Transd dB	Limit dBµV	Margin dB	Detector	Line	PE
0.186001	31.40	10.2	54	22.8	AV	N	GND
0.829501	24.40	10.2	46	21.6	AV	N	GND
0.919501	25.90	10.3	46	20.1	AV	N	GND
1.086001	24.10	10.3	46	21.9	AV	N	GND
1.198501	25.30	10.3	46	20.7	AV	N	GND
1.437001	23.60	10.3	46	22.4	AV	N	GND

4.2 Radiated Emission Test

TEST CONFIGURATION

Frequency range: 30MHz – 1000MHz

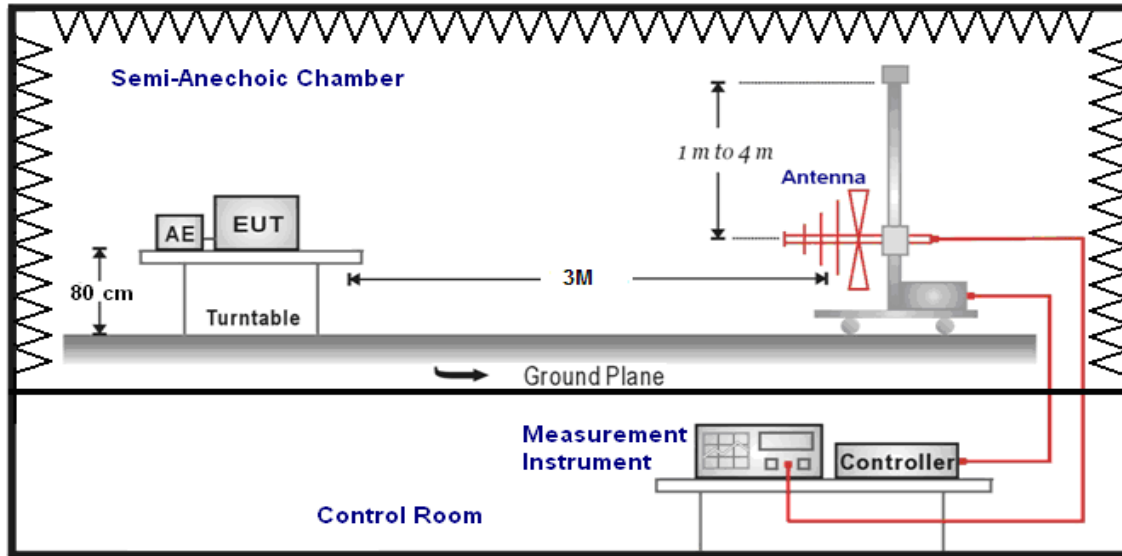

Frequency range above 1GHz-25GHz

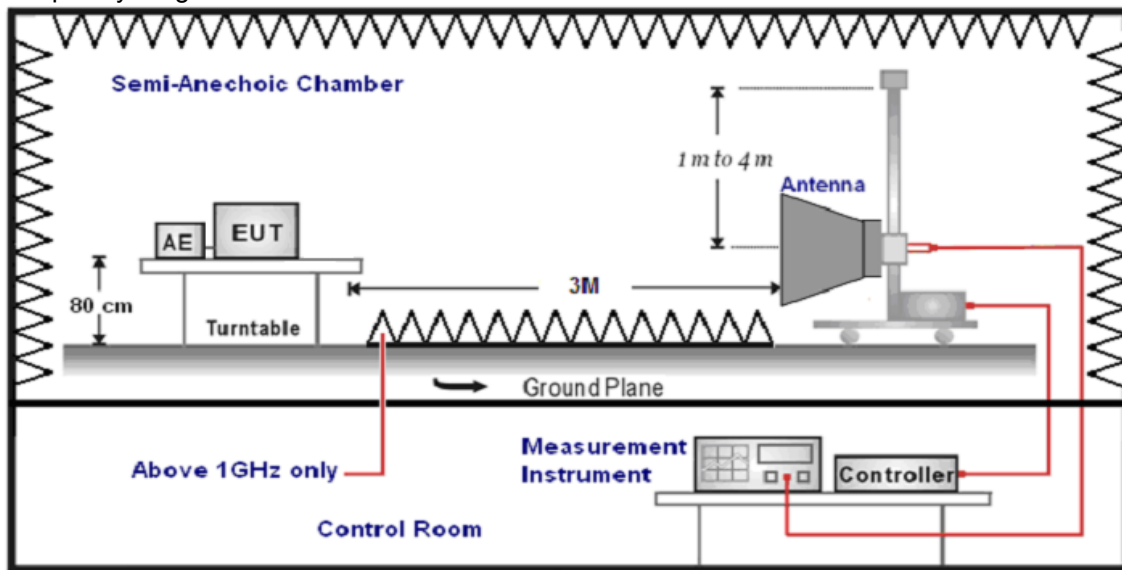

TEST PROCEDURE

1. The EUT is placed on a turntable, which is 0.8m above ground plane.
2. The turntable shall be rotated for 360 degrees to determine the position of maximum emission level.
3. EUT is set 3m away from the receiving antenna, which is varied from 1m to 4m to find out the highest emissions.
4. Maximum procedure was performed on the six highest emissions to ensure EUT compliance.
5. And also, each emission was to be maximized by changing the polarization of receiving antenna both horizontal and vertical.
6. Repeat above procedures until the measurements for all frequencies are complete.
7. The maximum operation frequency was 1.2GHz, the radiated emission test frequency from 30 MHz to 6GHz.

8. The distance between test antenna and EUT as following table states:

Test Frequency range	Test Antenna Type	Test Distance
30MHz-1GHz	Ultra-Broadband Antenna	3
1GHz-6GHz	Double Ridged Horn Antenna	3

9. Setting test receiver/spectrum as following table states:

Test Frequency range	Test Receiver/Spectrum Setting	Detector
30MHz-1GHz	RBW=120KHz/VBW=1000KHz,Sweep time=Auto	QP
1GHz-6GHz	Peak Value: RBW=1MHz/VBW=3MHz, Sweep time=Auto	Peak (Receiver)
	Average Value: RBW=1MHz/VBW=3MHz, Sweep time=Auto	Average (Receiver)

FIELD STRENGTH CALCULATION

The field strength is calculated by adding the Antenna Factor and Cable Factor and subtracting the Amplifier Gain and Duty Cycle Correction Factor (if any) from the measured reading. The basic equation with a sample calculation is as follows:

$$FS = RA + AF + CL - AG$$

Where FS = Field Strength	CL = Cable Attenuation Factor (Cable Loss)
RA = Reading Amplitude	AG = Amplifier Gain
AF = Antenna Factor	

For example

Frequency (MHz)	FS (dB μ V/m)	RA (dB μ V/m)	AF (dB)	CL (dB)	AG (dB)	Transd (dB)
300.00	40	58.1	12.2	1.6	31.90	-18.1

$$\text{Transd} = \text{AF} + \text{CL} - \text{AG}$$

RADIATION LIMIT

For unintentional device, according to § 15.109(a), except for Class A digital devices, the field strength of radiated emissions from unintentional radiators at a distance of 3 meters shall not exceed the following values:

Frequency (MHz)	Distance (Meters)	Radiated (dB μ V/m)	Radiated (μ V/m)
0.009-0.49	300	$20\log(2400/F(\text{KHz}))+80$	$2400/F(\text{KHz})$
0.49-1.705	30	$20\log(24000/F(\text{KHz}))+40$	$24000/F(\text{KHz})$
1.705-30	30	$20\log(30)+40$	30
30-88	3	40.0	100
88-216	3	43.5	150
216-960	3	46.0	200
Above 960	3	54.0	500

TEST RESULTS

Polarization **Horizontal**

SWEEP TABLE: "test (30M-1G)"

Start Frequency	Stop Frequency	Detector	Meas. Time	IF Bandw.	Field Strength Transducer
30.0 MHz	1.0 GHz	MaxPeak	300.0 ms	120 kHz	JB1

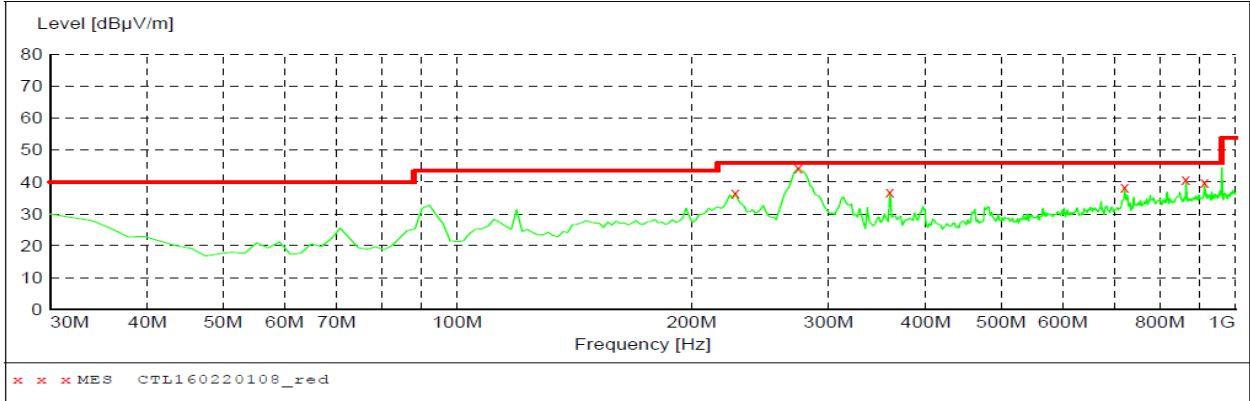

MEASUREMENT RESULT: "CTL160220108_red"

2/20/2016 10:12AM

Frequency MHz	Level dBuV/m	Transd dB	Limit dBuV/m	Margin dB	Det.	Height cm	Azimuth deg	Polarization
227.880000	36.50	14.1	46.0	9.5	---	0.0	0.00	HORIZONTAL
274.440000	44.40	15.3	46.0	1.6	---	0.0	0.00	HORIZONTAL
359.800000	36.70	17.3	46.0	9.3	---	0.0	0.00	HORIZONTAL
720.640000	38.20	23.7	46.0	7.8	---	0.0	0.00	HORIZONTAL
864.200000	40.70	25.5	46.0	5.3	---	0.0	0.00	HORIZONTAL
912.700000	40.00	26.2	46.0	6.0	---	0.0	0.00	HORIZONTAL

30MHz-1GHz

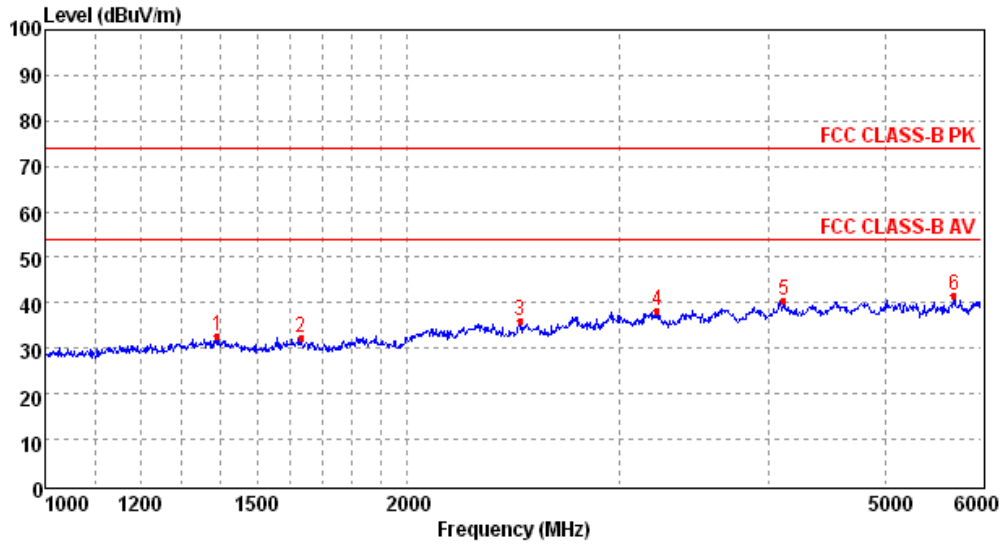

Mark	Frequency MHz	Level dBuV/m	Factor dB	Reading dBuV/m	Limit dBuV/m	Margin dB	Polarization	Det.
1	1390.53	32.58	-8.08	40.66	74.00	41.42	HORIZONTAL	Peak
2	1630.93	32.51	-8.38	40.89	74.00	41.49	HORIZONTAL	Peak
3	2480.41	36.03	-5.22	41.25	74.00	37.97	HORIZONTAL	Peak
4	3227.83	38.45	-2.84	41.29	74.00	35.55	HORIZONTAL	Peak
5	4111.13	40.46	0.03	40.43	74.00	33.54	HORIZONTAL	Peak
6	5696.20	41.66	3.62	38.04	74.00	32.34	HORIZONTAL	Peak

1GHz-6GHz

Polarization **Vertical**

SWEEP TABLE: "test (30M-1G)"

Short Description:		Field Strength			
Start Frequency	Stop Frequency	Detector	Meas. Time	IF Bandw.	Transducer
30.0 MHz	1.0 GHz	MaxPeak	300.0 ms	120 kHz	JB1

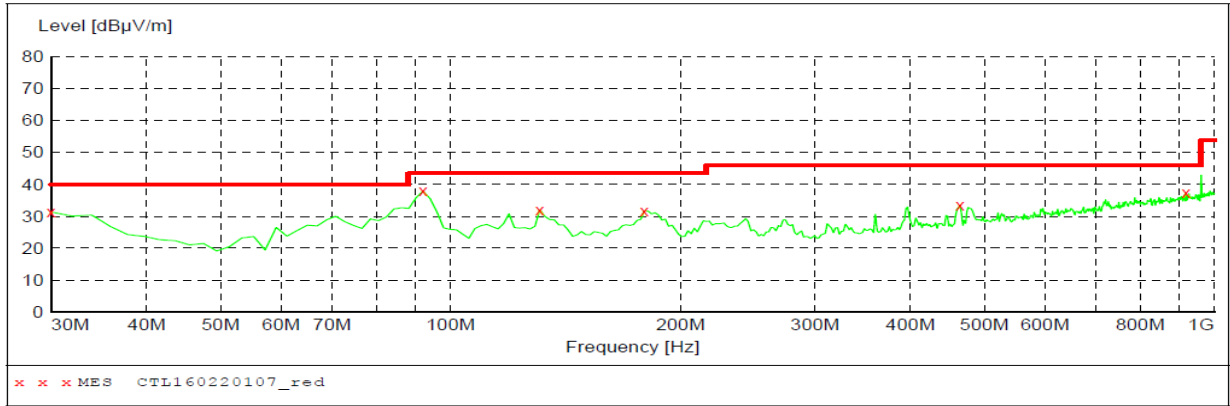

MEASUREMENT RESULT: "CTL160220107_red"

2/20/2016 10:11AM

Frequency MHz	Level dBuV/m	Transd dB	Limit dBuV/m	Margin dB	Det.	Height cm	Azimuth deg	Polarization
30.000000	31.30	21.1	40.0	8.7	---	0.0	0.00	VERTICAL
92.080000	37.90	10.0	43.5	5.6	---	0.0	0.00	VERTICAL
130.880000	32.10	14.9	43.5	11.4	---	0.0	0.00	VERTICAL
179.380000	31.70	13.3	43.5	11.8	---	0.0	0.00	VERTICAL
464.560000	33.50	19.7	46.0	12.5	---	0.0	0.00	VERTICAL
918.520000	37.30	26.3	46.0	8.7	---	0.0	0.00	VERTICAL

30MHz-1GHz

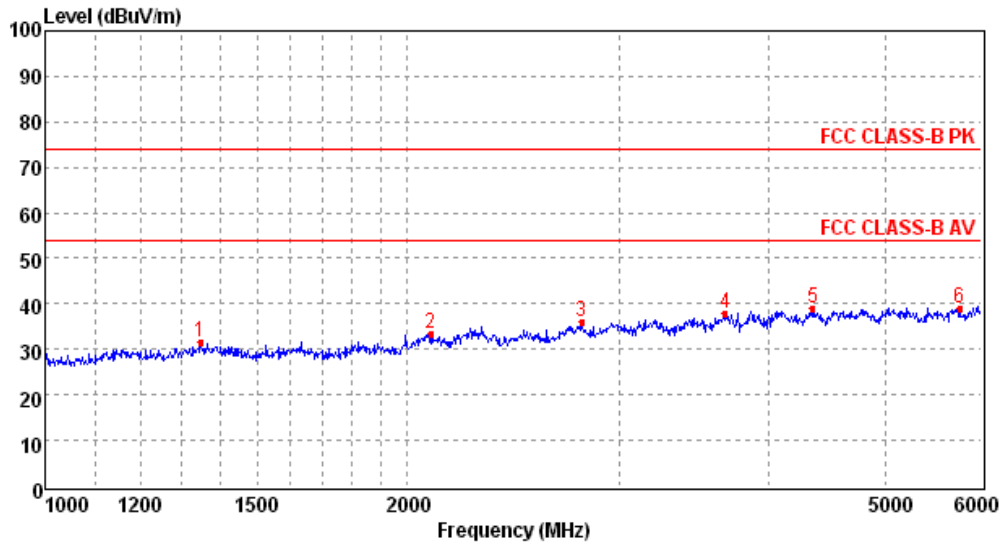

Mark	Frequency MHz	Level dBuV/m	Factor dB	Reading dBuV/m	Limit dBuV/m	Margin dB	Polarization	Det.
1	1346.40	31.51	-8.02	39.53	74.00	42.49	VERTICAL	Peak
2	2092.18	33.49	-5.99	39.48	74.00	40.51	VERTICAL	Peak
3	2791.78	36.24	-3.85	40.09	74.00	37.76	VERTICAL	Peak
4	3678.88	38.02	-1.50	39.52	74.00	35.98	VERTICAL	Peak
5	4345.94	39.04	0.73	38.31	74.00	34.96	VERTICAL	Peak
6	5757.76	39.14	3.90	35.24	74.00	34.86	VERTICAL	Peak

1GHz-6GHz

5 Test Setup Photos of the EUT

Please refer to separated files for Test Setup Photos of the EUT.

6 External Photos of the EUT

Please refer to separated files for External Photos of the EUT.

7 Internal Photos of the EUT

Please refer to separated files for Internal Photos of the EUT.

.....**End of Report**.....