



Shenzhen Global Test Service Co.,Ltd.

No.7-101 and 8A-104, Building 7 and 8, DCC Cultural and Creative Garden, No.98, Pingxin North Road, Shangmugu Community, Pinghu Street, Longgang District, Shenzhen, Guangdong

FCC PART 15 SUBPART C TEST REPORT

FCC PART 15.247

Report Reference No......: **GTS20190515004-1-2-3**

FCC ID.....: **RQQHLT-E553TA**

Compiled by

(position+printed name+signature)...: File administrators Jimmy Wang

Supervised by

(position+printed name+signature)...: Test Engineer Aaron Tan



Approved by

(position+printed name+signature)...: Manager Jason Hu

Date of issue.....: May.25, 2019

Representative Laboratory Name .: **Shenzhen Global Test Service Co.,Ltd.**

Address.....: No.7-101 and 8A-104, Building 7 and 8, DCC Cultural and Creative Garden, No.98, Pingxin North Road, Shangmugu Community, Pinghu Street, Longgang District, Shenzhen, Guangdong, China

Applicant's name.....: **HYUNDAI CORPORATION**

Address: 25,Yulgok-ro 2-Gil, Jongno-gu, Seoul, South Korea

Test specification

Standard: **FCC Part 15.247**

TRF Originator.....: Shenzhen Global Test Service Co.,Ltd.

Shenzhen Global Test Service Co.,Ltd. All rights reserved.

This publication may be reproduced in whole or in part for non-commercial purposes as long as the Shenzhen Global Test Service Co.,Ltd. is acknowledged as copyright owner and source of the material. Shenzhen Global Test Service Co.,Ltd. takes no responsibility for and will not assume liability for damages resulting from the reader's interpretation of the reproduced material due to its placement and context.

Test item description

Trade Mark: HYUNDAI

Manufacturer: Shenzhen Tinnu Mobile Technology Corp.

Model/Type reference.....: E553

Listed Models: /

Modulation Type: CCK/DSSS, OFDM

Operation Frequency.....: From 2412 - 2462MHz

Hardware Version: K210AG V0.20

Software Version: V1.0

Rating: DC 3.85V from battery and DC 5V From Adapter

Result.....: **PASS**

TEST REPORT

Test Report No. :	GTS20190515004-1-2-3	May. 25, 2019
		Date of issue

Equipment under Test : Smart Phone

Model /Type : E553

Listed Models : /

Applicant : **HYUNDAI CORPORATION**

Address : 25,Yulgok-ro 2-Gil, Jongno-gu, Seoul, South Korea

Manufacturer : **Shenzhen Tinno Mobile Technology Corp**

Address : 4/F.,H-3 Building,OCT Eastern Industrial Park. NO.1 XiangShan East Road.,Nan Shan District,Shenzhen,P.R.China.

Test Result:	PASS
---------------------	-------------

The test report merely corresponds to the test sample.
 It is not permitted to copy extracts of these test result without the written permission of the test laboratory.

Contents

<u>1</u>	<u>TEST STANDARDS</u>	<u>4</u>
<u>2</u>	<u>SUMMARY</u>	<u>5</u>
2.1	General Remarks	5
2.2	Product Description	5
2.3	Equipment Under Test	5
2.4	Short description of the Equipment under Test (EUT)	5
2.5	EUT operation mode	5
2.6	Block Diagram of Test Setup	6
2.7	Related Submittal(s) / Grant (s)	6
2.8	EUT configuration	6
2.9	Modifications	6
<u>3</u>	<u>TEST ENVIRONMENT</u>	<u>7</u>
3.1	Address of the test laboratory	7
3.2	Test Facility	7
3.3	Environmental conditions	7
3.4	Test Description	8
3.5	Statement of the measurement uncertainty	8
3.6	Equipments Used during the Test	9
<u>4</u>	<u>TEST CONDITIONS AND RESULTS.....</u>	<u>10</u>
4.1	AC Power Conducted Emission	10
4.2	Radiated Emission	13
4.3	Maximum Conducted Output Power	19
4.4	Power Spectral Density	20
4.5	6dB Bandwidth	23
4.6	Out-of-band Emissions	26
4.7	Antenna Requirement	33
<u>5</u>	<u>TEST SETUP PHOTOS OF THE EUT</u>	<u>34</u>
<u>6</u>	<u>PHOTOS OF THE EUT</u>	<u>35</u>

1 TEST STANDARDS

The tests were performed according to following standards:

[FCC Rules Part 15.247](#): Frequency Hopping, Direct Spread Spectrum and Hybrid Systems that are in operation within the bands of 902-928 MHz, 2400-2483.5 MHz, and 5725-5850 MHz.

[ANSI C63.10-2013](#): American National Standard for Testing Unlicensed Wireless Devices

[KDB558074 D01 v05r02](#): Guidance for Compliance Measurements on Digital Transmission Systems (DTS) ,Frequency Hopping Spread Spectrum System(HFSS), and Hybrid System Devices Operating Under §15.247 of The FCC rules.

2 SUMMARY

2.1 General Remarks

Date of receipt of test sample	:	May.01, 2019
Testing commenced on	:	May.01, 2019
Testing concluded on	:	May.25, 2019

2.2 Product Description

Product Name:	Smart Phone
Model/Type reference:	E553
Power supply:	DC 3.85V from battery and DC 5V From Adapter
Adapter information :	Model: AS5010B Input: 100-240V~, 50/60Hz 0.15A Output:DC5V---1000m A
WIFI :	
Supported type:	802.11b/802.11g/802.11n(H20)
Modulation:	802.11b: DSSS 802.11g/802.11n(H20): OFDM
Operation frequency:	802.11b/802.11g/802.11n(H20): 2412MHz~2462MHz
Channel number:	802.11b/802.11g/802.11n(H20): 11
Channel separation:	5MHz
Antenna type:	FPC antenna
Antenna gain:	-0.9dBi

2.3 Equipment Under Test

Power supply system utilised

Power supply voltage	:	<input type="radio"/> 230V / 50 Hz	<input type="radio"/> 120V / 60Hz
		<input type="radio"/> 12 V DC	<input type="radio"/> 24 V DC
		<input checked="" type="radio"/> Other (specified in blank below)	

DC 3.85V from battery and DC 5V From Adapter

2.4 Short description of the Equipment under Test (EUT)

This is a Smart Phone.

For more details, refer to the user's manual of the EUT.

2.5 EUT operation mode

The application provider specific test software(Realtek MPtool) to control sample in continuous TX and RX (Duty Cycle >98%)
for testing meet KDB558074 test requirement.

IEEE 802.11b/g/n: Thirteen channels are provided to the EUT.

Channel	Frequency(MHz)	Channel	Frequency(MHz)
1	2412	8	2447
2	2417	9	2452
3	2422	10	2457
4	2427	11	2462
5	2432		
6	2437		
7	2442		

2.6 Block Diagram of Test Setup

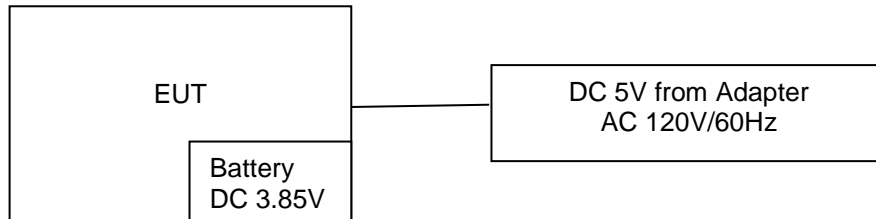

2.7 Related Submittal(s) / Grant (s)

This submittal(s) (test report) is intended for **FCC ID:RQQHLT-E553TA** filing to comply with Section 15.247 of the FCC Part 15, Subpart C Rules.

2.8 EUT configuration

The following peripheral devices and interface cables were connected during the measurement:

- supplied by the manufacturer
- Supplied by the lab

<input type="radio"/>		M/N:	
<input type="radio"/>		Manufacturer:	

2.9 Modifications

No modifications were implemented to meet testing criteria.

3 TEST ENVIRONMENT

3.1 Address of the test laboratory

Shenzhen Global Test Service Co.,Ltd.

No.7-101 and 8A-104, Building 7 and 8, DCC Cultural and Creative Garden, No.98, Pingxin North Road, Shangmugu Community, Pinghu Street, Longgang District, Shenzhen, Guangdong

The 3m-Semi anechoic test site fulfils CISPR 16-1-4 according to ANSI C63.4:2014 and CISPR 16-1-4:2010 SVSWR requirement for radiated emission above 1GHz.

3.2 Test Facility

The test facility is recognized, certified, or accredited by the following organizations:

FCC-Registration No.: 165725

Shenzhen Global Test Service Co.,Ltd EMC Laboratory has been registered and fully described in a report filed with the (FCC) Federal Communications Commission. The acceptance letter from the FCC is maintained in our files.

A2LA-Lab Cert. No.: 4758.01

Shenzhen Global Test Service Co.,Ltd. EMC Laboratory has been accredited by A2LA for technical competence in the field of electrical testing, and proved to be in compliance with ISO/IEC 17025: 2005 General Requirements for the Competence of Testing and Calibration Laboratories and any additional program requirements in the identified field of testing.

CNAS-Lab Code: L8169

Shenzhen Global Test Service Co.,Ltd. has been assessed and proved to be in compliance with CNAS-CL01 Accreditation Criteria for Testing and Calibration Laboratories (identical to ISO/IEC 17025: 2005 General Requirements) for the Competence of Testing and Calibration Laboratories. Date of Registration: Dec. 11, 2015. Valid time is until Dec. 10, 2018.

3.3 Environmental conditions

During the measurement the environmental conditions were within the listed ranges:

Temperature:	15-35 ° C
Humidity:	30-60 %
Atmospheric pressure:	950-1050mbar

3.4 Test Description

FCC PART 15.247		
FCC Part 15.207	AC Power Conducted Emission	PASS
FCC Part 15.247(a)(2)	6dB Bandwidth	PASS
FCC Part 15.247(d)	Spurious RF Conducted Emission	PASS
FCC Part 15.247(b)	Maximum Conducted Output Power	PASS
FCC Part 15.247(e)	Power Spectral Density	PASS
FCC Part 15.109/ 15.205/ 15.209	Radiated Emissions	PASS
FCC Part 15.247(d)	Band Edge	PASS
FCC Part 15.203/15.247 (b)	Antenna Requirement	PASS

Data Rate Used:

Preliminary tests were performed in different data rate to find the worst radiated emission. The data rate shown in the table below is the worst-case rate with respect to the specific test item. Investigation has been done on all the possible configurations for searching the worst cases. The following table is a list of the test modes shown in this test report.

Test Items	Mode	Data Rate	Channel
Maximum Peak Conducted Output Power Power Spectral Density 6dB Bandwidth Spurious RF conducted emission Radiated Emission 9KHz~1GHz& Radiated Emission 1GHz~10 th Harmonic	11b/DSSS	1 Mbps	1/6/11
	11g/OFDM	6 Mbps	1/6/11
	11n(20MHz)/OFDM	6.5Mbps	1/6/11
Band Edge	11b/DSSS	1 Mbps	1/11
	11g/OFDM	6 Mbps	1/11
	11n(20MHz)/OFDM	6.5Mbps	1/11

3.5 Statement of the measurement uncertainty

The data and results referenced in this document are true and accurate. The reader is cautioned that there may be errors within the calibration limits of the equipment and facilities. The measurement uncertainty was calculated for all measurements listed in this test report acc. to CISPR 16 - 4 „Specification for radio disturbance and immunity measuring apparatus and methods – Part 4: Uncertainty in EMC Measurements“ and is documented in the Shenzhen Global Test Service Co.,Ltd quality system acc. to DIN EN ISO/IEC 17025. Furthermore, component and process variability of devices similar to that tested may result in additional deviation. The manufacturer has the sole responsibility of continued compliance of the device.

Hereafter the best measurement capability for Shenzhen GTS laboratory is reported:

Test	Range	Measurement Uncertainty	Notes
Radiated Emission	30~1000MHz	4.10 dB	(1)
Radiated Emission	1~18GHz	4.32 dB	(1)
Radiated Emission	18-40GHz	5.54 dB	(1)
Conducted Disturbance	0.15~30MHz	3.12 dB	(1)

- (1) This uncertainty represents an expanded uncertainty expressed at approximately the 95% confidence level using a coverage factor of k=2.

3.6 Equipments Used during the Test

Test Equipment	Manufacturer	Model No.	Serial No.	Calibration Date	Calibration Due Date
LISN	R&S	ENV216	3560.6550.08	2018/09/20	2019/09/19
LISN	R&S	ESH2-Z5	893606/008	2018/09/20	2019/09/19
Bilog Antenna	Schwarzbeck	VULB9163	976	2018/09/20	2019/09/19
EMI Test Receiver	R&S	ESC17	101102	2018/09/20	2019/09/19
Spectrum Analyzer	Agilent	N9020A	MY48010425	2018/09/20	2019/09/19
Spectrum Analyzer	R&S	FSP40	100019	2018/06/05	2019/06/04
Controller	EM Electronics	Controller EM 1000	N/A	N/A	N/A
Horn Antenna	Schwarzbeck	BBHA 9120D	01622	2018/09/20	2019/09/19
Active Loop Antenna	SCHWARZBEC K	FMZB1519	1519-037	2018/09/20	2019/09/19
Broadband Horn Antenna	SCHWARZBEC K	BBHA 9170	971	2018/09/20	2019/09/19
Amplifier	Schwarzbeck	BBV 9743	#202	2018/09/20	2019/09/19
Amplifier	EMCI	EMC051845B	980355	2018/09/20	2019/09/19
Temperature/Humidity Meter	Gangxing	CTH-608	02	2018/09/20	2019/09/19
High-Pass Filter	K&L	9SH10- 2700/X12750- O/O	KL142031	2018/09/20	2019/09/19
High-Pass Filter	K&L	41H10- 1375/U12750- O/O	KL142032	2018/09/20	2019/09/19
RF Cable(below 1GHz)	HUBER+SUHNE R	RG214	RE01	2018/09/20	2019/09/19
RF Cable(above 1GHz)	HUBER+SUHNE R	RG214	RE02	2018/09/20	2019/09/19
Data acquisition card	Agilent	U2531A	TW53323507	2018/09/20	2019/09/19
Power Sensor	Agilent	U2021XA	MY5365004	2018/09/20	2019/09/19
EMI Test Software	R&S	ES-K1	V1.7.1	2018/09/20	2019/09/19
EMI Test Software	JS Tonscend	JS32-RE	2.0.1.5	2018/09/20	2019/09/19

Note: The Cal.Interval was one year.

4 TEST CONDITIONS AND RESULTS

4.1 AC Power Conducted Emission

TEST CONFIGURATION

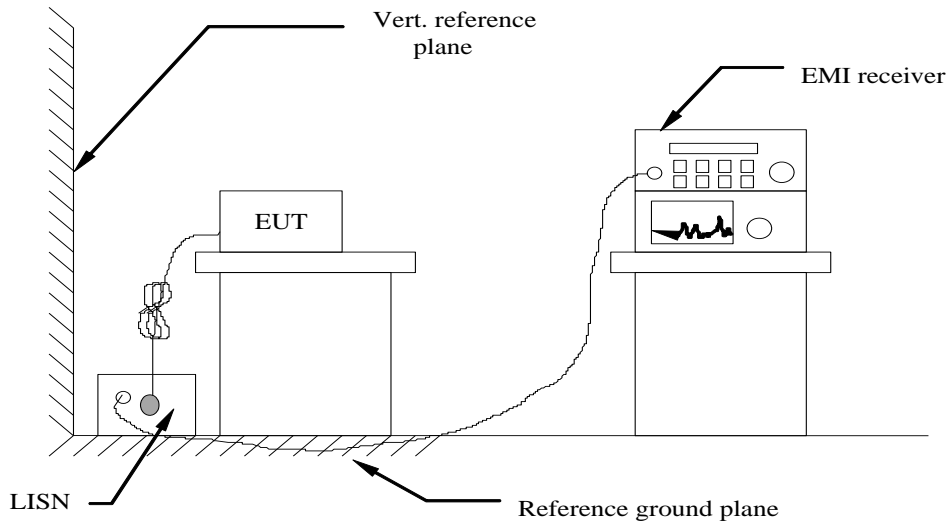

TEST PROCEDURE

- 1 The equipment was set up as per the test configuration to simulate typical actual usage per the user's manual. The EUT is a tabletop system, a wooden table with a height of 0.8 meters is used and is placed on the ground plane as per ANSI C63.10-2013.
- 2 Support equipment, if needed, was placed as per ANSI C63.10-2013
- 3 All I/O cables were positioned to simulate typical actual usage as per ANSI C63.10-2013
- 4 The EUT received DC 12V power from adapter, the adapter received AC120V/60Hz and AC 240V/60Hz power through a Line Impedance Stabilization Network (LISN) which supplied power source and was grounded to the ground plane.
- 5 All support equipments received AC power from a second LISN, if any.
- 6 The EUT test program was started. Emissions were measured on each current carrying line of the EUT using a spectrum Analyzer / Receiver connected to the LISN powering the EUT. The LISN has two monitoring points: Line 1 (Hot Side) and Line 2 (Neutral Side). Two scans were taken: one with Line 1 connected to Analyzer / Receiver and Line 2 connected to a 50 ohm load; the second scan had Line 1 connected to a 50 ohm load and Line 2 connected to the Analyzer / Receiver.
- 7 Analyzer / Receiver scanned from 150 KHz to 30MHz for emissions in each of the test modes.
- 8 During the above scans, the emissions were maximized by cable manipulation.

AC Power Conducted Emission Limit

For intentional device, according to § 15.207(a) AC Power Conducted Emission Limits is as following :

Frequency range (MHz)	Limit (dBuV)	
	Quasi-peak	Average
0.15-0.5	66 to 56*	56 to 46*
0.5-5	56	46
5-30	60	50

* Decreases with the logarithm of the frequency.

TEST RESULTS

Remark:

1. All modes of 802.11b/g/n were tested at Low, Middle, and High channel; only the worst result of 802.11b CH11 was reported as below:
2. Both 120 VAC, 50/60 Hz and 240 VAC, 50/60 Hz power supply have been tested, only the worst result of 120 VAC, 60 Hz was reported as below:.

Power supply:	AC 120V/60Hz(adapter)	Polarization	L
---------------	-----------------------	--------------	---

SCAN TABLE: "Voltage (9K-30M) FIN"
 Short Description: 150K-30M Voltage

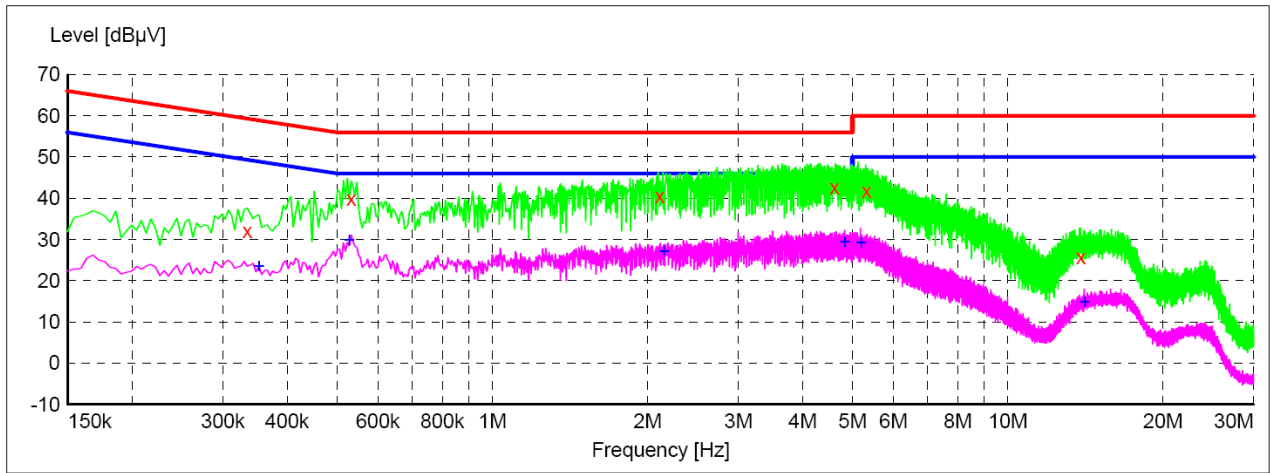

x x x MES GTS190514121_fin

MEASUREMENT RESULT: "GTS190514121_fin"

5/14/2019 11:43AM

Frequency MHz	Level dBµV	Transd dB	Limit dBµV	Margin dB	Detector	Line	PE
0.334500	32.10	9.9	59	27.2	QP	L1	GND
0.532500	39.90	9.8	56	16.1	QP	L1	GND
2.112000	40.40	9.5	56	15.6	QP	L1	GND
4.614000	42.60	9.3	56	13.4	QP	L1	GND
5.320500	41.80	9.3	60	18.2	QP	L1	GND
13.870500	25.60	8.3	60	34.4	QP	L1	GND

MEASUREMENT RESULT: "GTS190514121_fin2"

5/14/2019 11:43AM

Frequency MHz	Level dBµV	Transd dB	Limit dBµV	Margin dB	Detector	Line	PE
0.352500	23.50	9.9	49	25.4	AV	L1	GND
0.528000	29.80	9.8	46	16.2	AV	L1	GND
2.157000	27.10	9.5	46	18.9	AV	L1	GND
4.830000	29.50	9.3	46	16.5	AV	L1	GND
5.199000	29.30	9.3	50	20.7	AV	L1	GND
14.113500	14.80	8.3	50	35.2	AV	L1	GND

Power supply:

AC 120V/60Hz(adapter)

Polarization

N

SCAN TABLE: "Voltage (9K-30M)FIN"

Short Description: 150K-30M Voltage

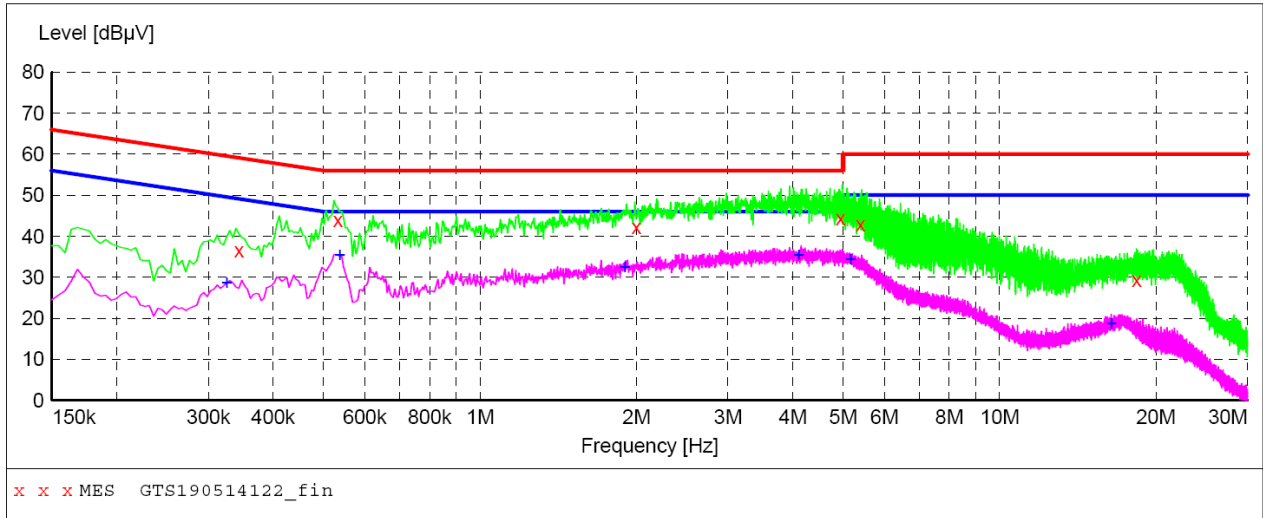

MEASUREMENT RESULT: "GTS190514122_fin"

5/14/2019 11:46AM

Frequency MHz	Level dBµV	Transd dB	Limit dBµV	Margin dB	Detector	Line	PE
0.343500	36.40	9.9	59	22.7	QP	N	GND
0.532500	44.00	9.8	56	12.0	QP	N	GND
1.999500	42.20	9.5	56	13.8	QP	N	GND
4.942500	44.30	9.3	56	11.7	QP	N	GND
5.397000	42.80	9.3	60	17.2	QP	N	GND
18.343500	29.40	7.4	60	30.6	QP	N	GND

MEASUREMENT RESULT: "GTS190514122_fin2"

5/14/2019 11:46AM

Frequency MHz	Level dBµV	Transd dB	Limit dBµV	Margin dB	Detector	Line	PE
0.325500	28.60	9.9	50	21.0	AV	N	GND
0.537000	35.40	9.8	46	10.6	AV	N	GND
1.900500	32.60	9.5	46	13.4	AV	N	GND
4.105500	35.40	9.4	46	10.6	AV	N	GND
5.163000	34.30	9.3	50	15.7	AV	N	GND
16.413000	18.70	7.8	50	31.3	AV	N	GND

4.2 Radiated Emission

TEST CONFIGURATION

Frequency range 9 KHz – 30MHz

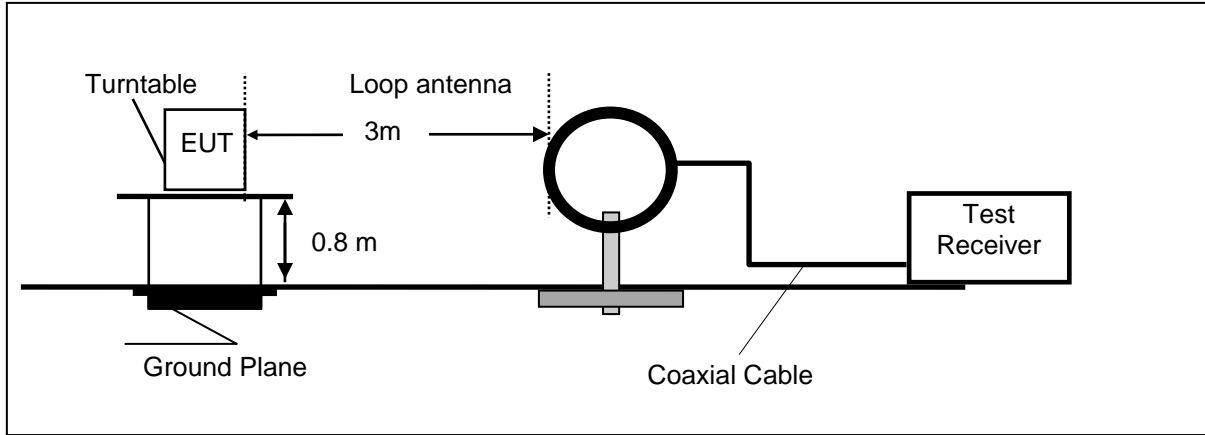

Frequency range 30MHz – 1000MHz

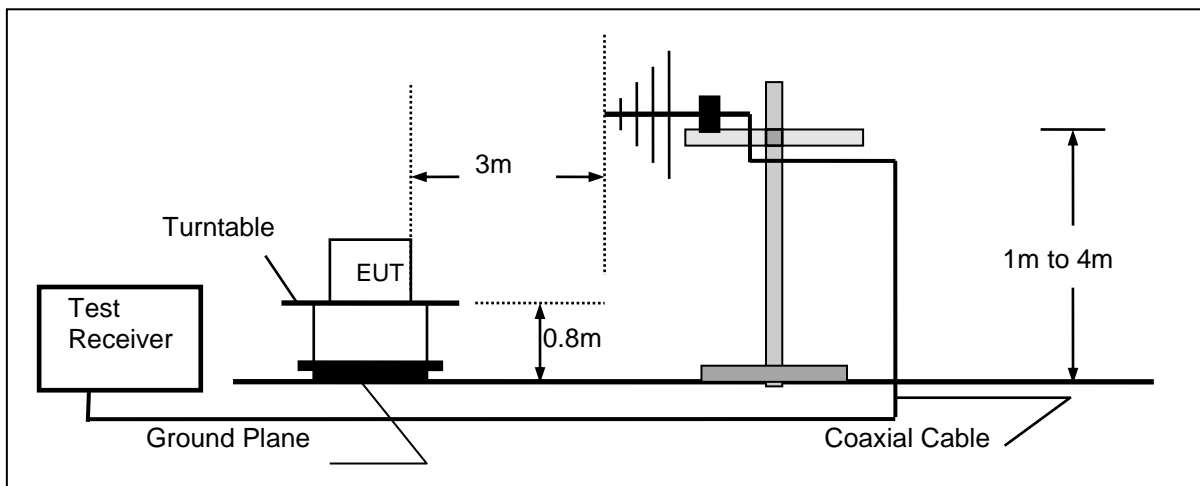

Frequency range above 1GHz-25GHz

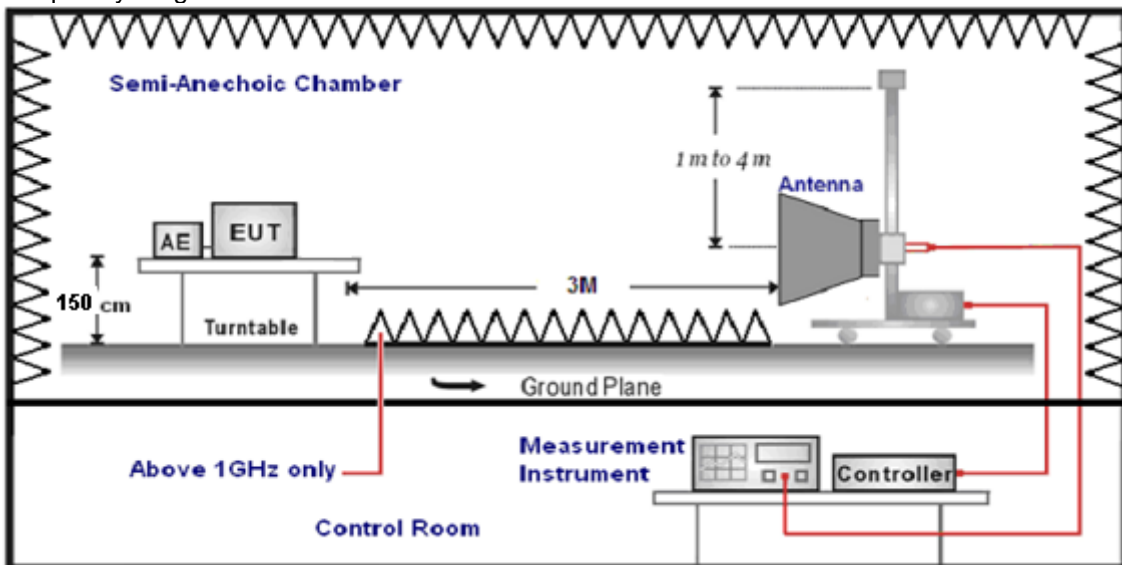

TEST PROCEDURE

1. The EUT was placed on a turn table which is 0.8m above ground plane when testing frequency range 9 KHz –1GHz;the EUT was placed on a turn table which is 1.5m above ground plane when testing frequency range 1GHz – 25GHz.
2. Maximum procedure was performed by raising the receiving antenna from 1m to 4m and rotating the turn table from 0° to 360° to acquire the highest emissions from EUT.
3. And also, each emission was to be maximized by changing the polarization of receiving antenna both horizontal and vertical.
4. Repeat above procedures until all frequency measurements have been completed.
5. Radiated emission test frequency band from 9KHz to 25GHz.
6. The distance between test antenna and EUT as following table states:

Test Frequency range	Test Antenna Type	Test Distance
9KHz-30MHz	Active Loop Antenna	3
30MHz-1GHz	Ultra-Broadband Antenna	3
1GHz-18GHz	Double Ridged Horn Antenna	3
18GHz-25GHz	Horn Antenna	1

7. Setting test receiver/spectrum as following table states:

Test Frequency range	Test Receiver/Spectrum Setting	Detector
9KHz-150KHz	RBW=200Hz/VBW=3KHz,Sweep time=Auto	QP
150KHz-30MHz	RBW=9KHz/VBW=100KHz,Sweep time=Auto	QP
30MHz-1GHz	RBW=120KHz/VBW=1000KHz,Sweep time=Auto	QP
1GHz-40GHz	Peak Value: RBW=1MHz/VBW=3MHz, Sweep time=Auto Average Value: RBW=1MHz/VBW=10Hz, Sweep time=Auto	Peak

Field Strength Calculation

The field strength is calculated by adding the Antenna Factor and Cable Factor and subtracting the Amplifier Gain and Duty Cycle Correction Factor(if any) from the measured reading. The basic equation with a sample calculation is as follows:

FS = RA + AF + CL - AG

Where FS = Field Strength	CL = Cable Attenuation Factor (Cable Loss)
RA = Reading Amplitude	AG = Amplifier Gain
AF = Antenna Factor	

Transd=AF +CL-AG

RADIATION LIMIT

For intentional device, according to § 15.209(a), the general requirement of field strength of radiated emission from intentional radiators at a distance of 3 meters shall not exceed the following table. According to § 15.247(d), in any 100kHz bandwidth outside the frequency band in which the EUT is operating, the radio frequency power that is produced by the intentional radiator shall be at least 20dB below that in the100kHz bandwidth within the band that contains the highest level of desired power.

The pre-test have done for the EUT in three axes and found the worst emission at position shown in test setup photos.

Frequency (MHz)	Distance (Meters)	Radiated (dBµV/m)	Radiated (µV/m)
0.009-0.49	3	20log(2400/F(KHz))+40log(300/3)	2400/F(KHz)
0.49-1.705	3	20log(24000/F(KHz))+ 40log(30/3)	24000/F(KHz)
1.705-30	3	20log(30)+ 40log(30/3)	30
30-88	3	40.0	100
88-216	3	43.5	150
216-960	3	46.0	200
Above 960	3	54.0	500

TEST RESULTS

Remark:

1. This test was performed with EUT in X, Y, Z position and the worse case was found when EUT in X position.
2. All three channels (lowest/middle/highest) of each mode were measured below 1GHz and recorded worst case at 802.11b low channel.
3. All three channels (lowest/middle/highest) of each mode were measured above 1GHz and recorded worst case at 802.11b mode.
4. Radiated emission test from 9 KHz to 10th harmonic of fundamental was verified, and no emission found except system noise floor in 9 KHz to 30MHz and not recorded in this report.

For 30MHz-1GHz

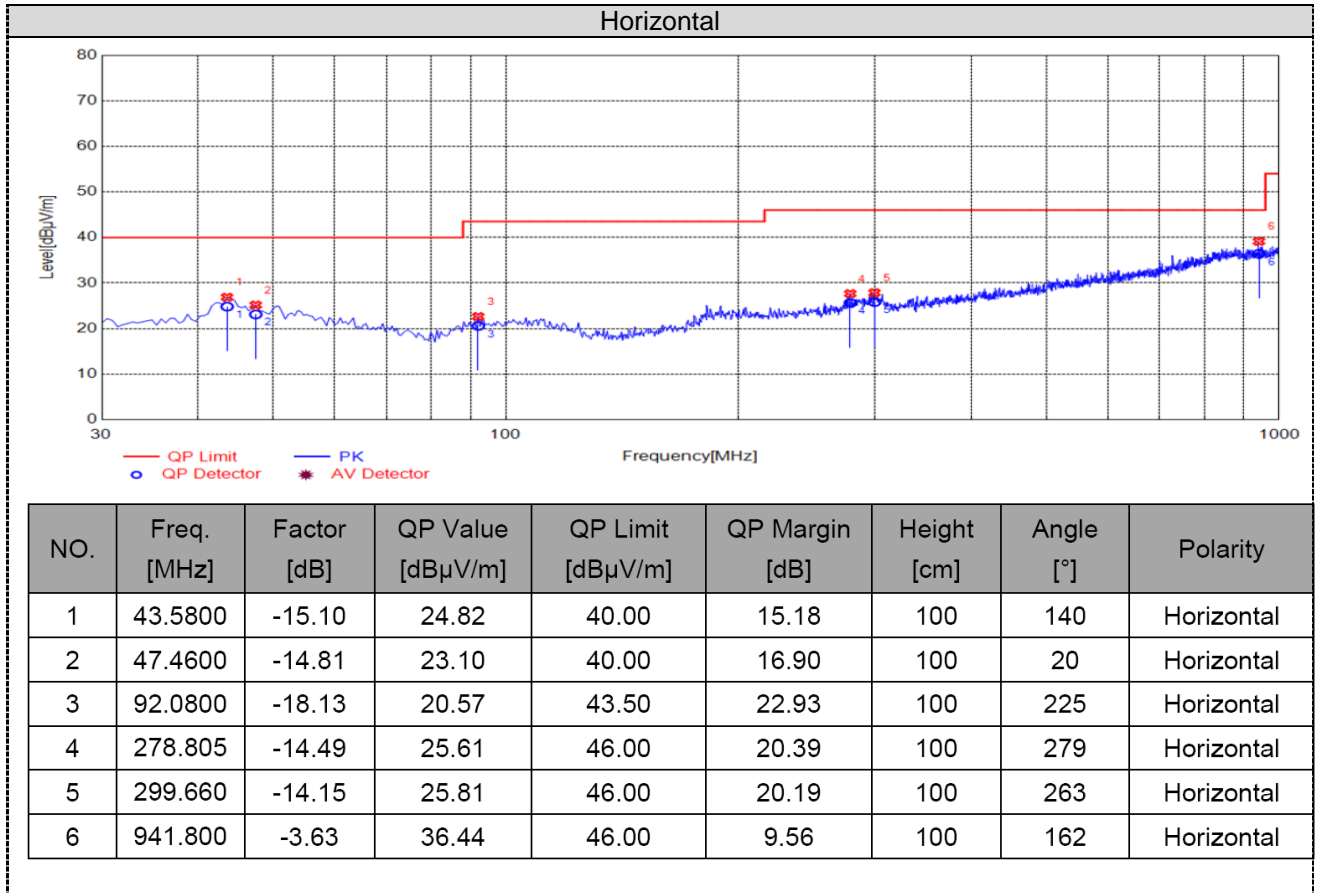

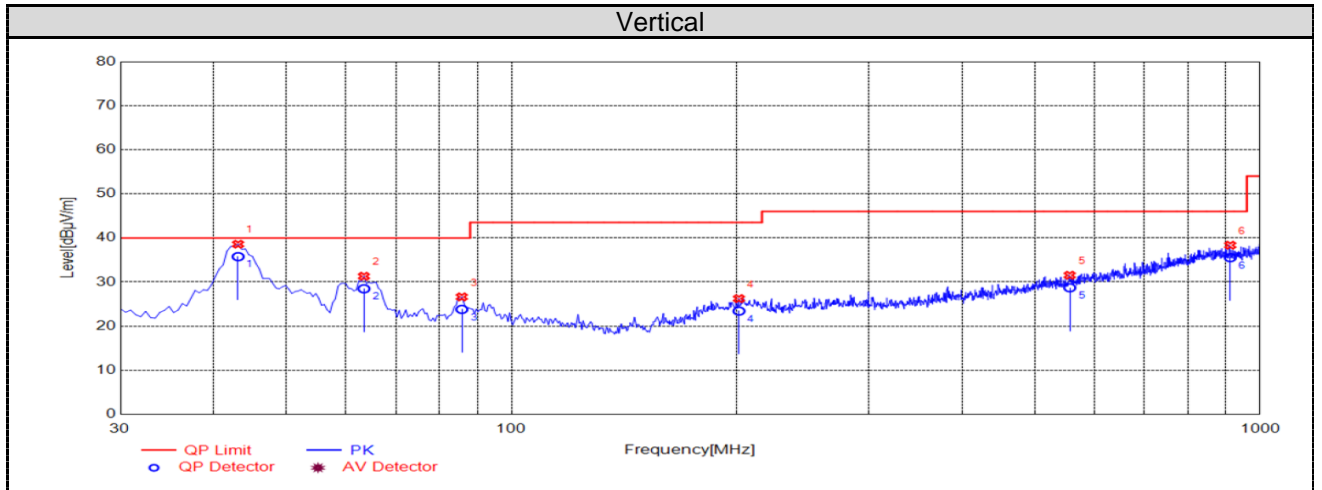

NO.	Freq. [MHz]	Factor [dB]	QP Value [dBμV/m]	QP Limit [dBμV/m]	QP Margin [dB]	Height [cm]	Angle [°]	Polarity
1	43.0950	-15.22	35.75	40.00	4.25	100	121	Vertical
2	63.4650	-17.98	28.47	40.00	11.53	100	118	Vertical
3	85.7750	-19.50	23.80	40.00	16.20	100	180	Vertical
4	201.205	-16.47	23.41	43.50	20.09	100	208	Vertical
5	556.710	-8.76	28.70	46.00	17.30	100	163	Vertical
6	912.215	-3.81	35.52	46.00	10.48	100	147	Vertical

For 1GHz to 25GHz

Note: 802.11b/802.11g/802.11n (H20) all have been tested, only worse case 802.11b mode 1Mbps is reported

Polar (H/V)	Frequency (MHz)	Meter Reading (dBuV)	Antenna Factor (dB)	Cable loss (dB)	Preamp factor (dB)	Emission Level (dBuV/m)	Limits (dBuV/m)	Margin (dB)	Detector Type
802.11b-2412MHz									
V	4824	39.33	30.28	7.01	26.63	49.99	74	24.01	PK
V	--	--	--	--	--	--	54	--	AV
H	4824	37.09	30.28	7.01	26.63	47.75	74	26.25	PK
H	--	--	--	--	--	--	54	--	AV
V	7236	25.64	36.59	8.91	24.98	46.16	74	27.84	PK
V	--	--	--	--	--	--	54	--	AV
H	7236	25.17	36.59	8.91	24.98	45.69	74	28.31	PK
H	--	--	--	--	--	--	54	--	AV
802.11b-2437MHz									
V	4874	39.06	30.36	7.62	26.63	50.41	74	23.59	PK
V	--	--	--	--	--	--	54	--	AV
H	4874	37.81	30.36	7.62	26.63	49.16	74	24.84	PK
H	--	--	--	--	--	--	54	--	AV
V	7311	26.57	36.61	8.84	24.98	47.04	74	26.96	PK
V	--	--	--	--	--	--	54	--	AV
H	7311	25.47	36.61	8.84	24.98	45.94	74	28.06	PK
H	--	--	--	--	--	--	54	--	AV
802.11b-2462MHz									
V	4924	39.58	30.43	7.94	26.63	51.32	74	22.68	PK
V	--	--	--	--	--	--	54	--	AV
H	4924	36.97	30.43	7.94	26.63	48.71	74	25.29	PK
H	--	--	--	--	--	--	54	--	AV
V	7386	26.89	36.78	8.45	24.98	47.14	74	26.86	PK
V	--	--	--	--	--	--	54	--	AV
H	7386	26.26	36.78	8.45	24.98	46.51	74	27.49	PK
H	--	--	--	--	--	--	54	--	AV

Note:

- 1) Emission level (dBuV/m) = Meter Reading+ antenna Factor+ cable loss- preamp factor.
- 2) Margin value = Limits-Emission level.
- 3) -- Mean the PK detector measured value is below average limit.
- 4) The other emission levels were very low against the limit.
- 5) RBW1MHz VBW3MHz Peak detector is for PK value; RBW 1MHz VBW10Hz Peak detector is for AV value.

Results of Band Edges Test (Radiated)

Note: 802.11b/802.11g/802.11n (H20) all have been tested, only worse case 802.11b is reported

Polar (H/V)	Frequency	Meter Reading	Antenna Factor	Cable loss	Preamp factor	Emission Level	Limits	Margin	Detector Type
	(MHz)	(dBuV)	(dB)	(dB)	(dB)	(dBuV/m)	(dBuV/m)	(dB)	
802.11b-2412MHz									
V	2390	46.42	28.72	5.11	28.48	51.77	74	22.23	PK
V	--	--	--	--	--	--	54	--	AV
H	2390	44.21	28.72	5.11	28.48	49.56	74	24.44	PK
H	--	--	--	--	--	--	54	--	AV
V	2400	38.87	28.78	5.25	27.65	45.25	74	28.75	PK
V	--	--	--	--	--	--	54	--	AV
H	2400	38.5	28.78	5.25	27.65	44.88	74	29.12	PK
H	--	--	--	--	--	--	54	--	AV
802.11b-2462MHz									
V	2483.50	43.78	28.93	5.34	27.49	50.56	74	23.44	PK
V	--	--	--	--	--	--	54	--	AV
H	2483.50	42.2	28.93	5.34	27.49	48.98	74	25.02	PK
H	--	--	--	--	--	--	54	--	AV
V	2500.00	38.87	28.96	5.75	27.32	46.26	74	27.74	PK
V	--	--	--	--	--	--	54	--	AV
H	2500.00	38.26	28.96	5.75	27.32	45.65	74	28.35	PK
H	--	--	--	--	--	--	54	--	AV

Note:

- 1) Emission level (dBuV/m) = Meter Reading+ antenna Factor+ cable loss- preamp factor.
- 2) Margin value = Limits-Emission level.
- 3) -- Mean the PK detector measured value is below average limit.
- 4) The other emission levels were very low against the limit.
- 5) RBW1MHz VBW3MHz Peak detector is for PK value; RBW 1MHz VBW10Hz Peak detector is for AV value.

4.3 Maximum Conducted Output Power

Limit

The Maximum Peak Output Power Measurement is 30dBm.

Test Procedure

Remove the antenna from the EUT and then connect a low loss RF cable from the antenna port to the power sensor.

Test Configuration

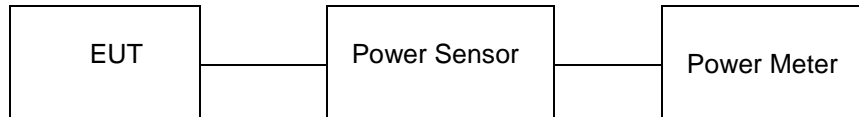

Test Results

WIFI				
Type	Channel	Output power PK (dBm)	Limit (dBm)	Result
802.11b	01	17.05	30.00	Pass
	06	18.01		
	11	18.16		
802.11g	01	17.13	30.00	Pass
	06	18.25		
	11	18.53		
802.11n(HT20)	01	18.01	30.00	Pass
	06	19.13		
	11	19.58		

Note:

- 1) Measured output power at difference data rate for each mode and recorded worst case for each mode.
- 2) Test results including cable loss.
- 3) Worst case data at 1 Mbps at IEEE 802.11b; 6Mbps at IEEE 802.11g; 6.5Mbps at IEEE 802.11n HT20

4.4 Power Spectral Density

Limit

For digitally modulated systems, the power spectral density conducted from the intentional radiator to the antenna shall not be greater than 8 dBm in any 3 kHz band during any time interval of continuous transmission.

Test Procedure

1. Use this procedure when the maximum peak conducted output power in the fundamental emission is used to demonstrate compliance.
2. Set the RBW \geq 3 kHz.
3. Set the VBW \geq 3 \times RBW.
4. Set the span to 1.5 times the DTS channel bandwidth.
5. Detector = peak.
6. Sweep time = auto couple.
7. Trace mode = max hold.
8. Allow trace to fully stabilize.
9. Use the peak marker function to determine the maximum power level.
10. If measured value exceeds limit, reduce RBW (no less than 3 kHz) and repeat.
11. The resulting peak PSD level must be 8dBm.

Test Configuration

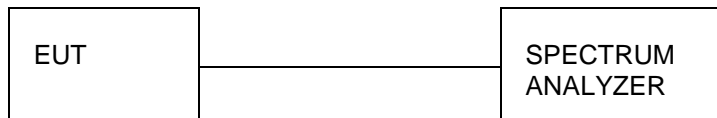

Test Results

WIFI				
Type	Channel	Power Spectral Density (dBm/3KHz)	Limit (dBm/3KHz)	Result
802.11b	01	-14.854	8.00	Pass
	06	-13.767		
	11	-13.777		
802.11g	01	-17.758	8.00	Pass
	06	-16.214		
	11	-14.783		
802.11n(HT20)	01	-17.358	8.00	Pass
	06	-16.008		
	11	-15.253		

Note:

- 1) Measured peak power spectrum density at difference data rate for each mode and recorded worst case for each mode.
- 2) Test results including cable loss;
- 3) Worst case data at 1Mbps at IEEE 802.11b; 6Mbps at IEEE 802.11g; 6.5Mbps at IEEE 802.11n HT20;

Please refer to following plots;

802.11b

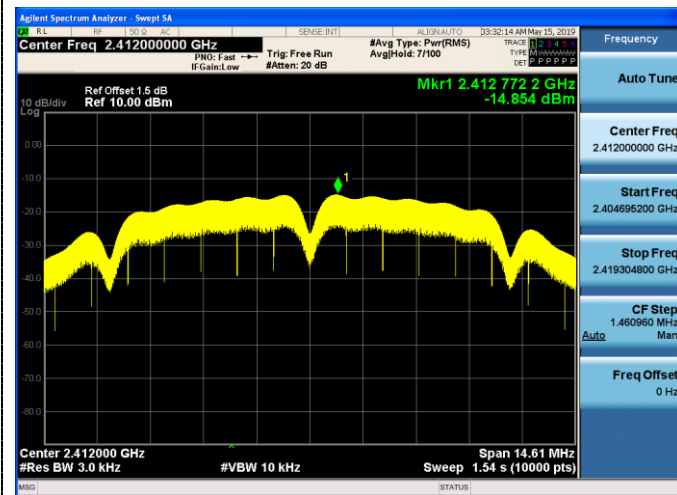

802.11g

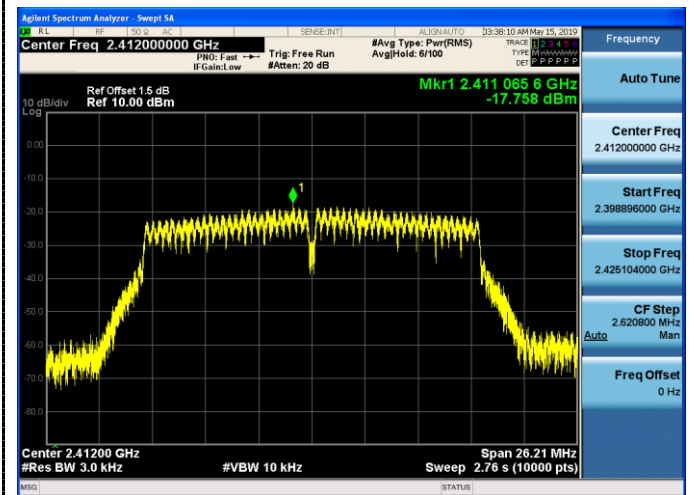

CH01

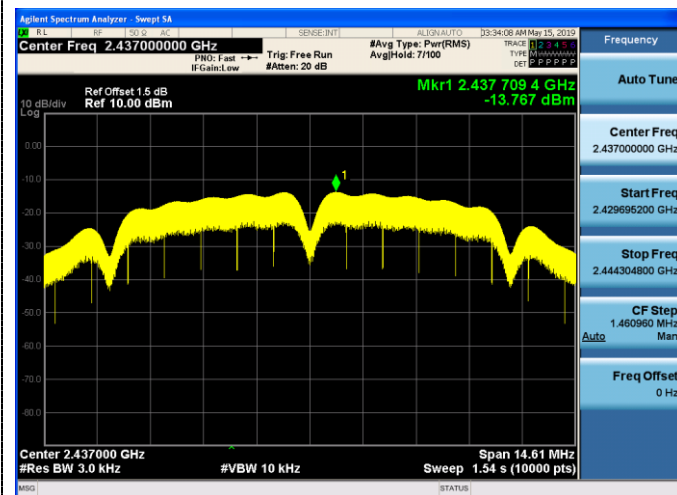

CH01

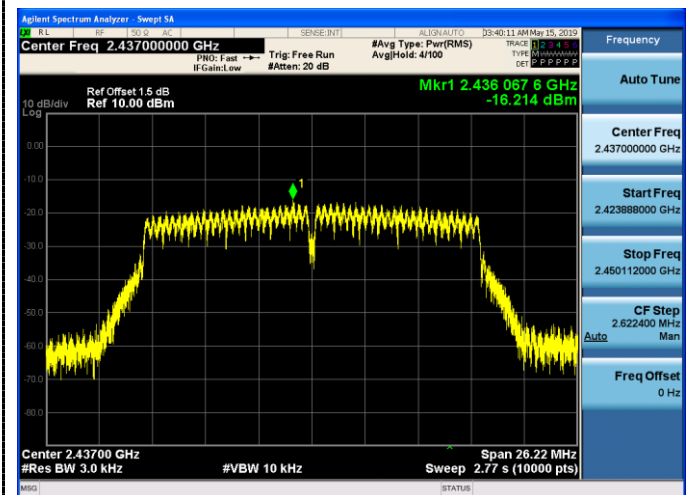

CH06

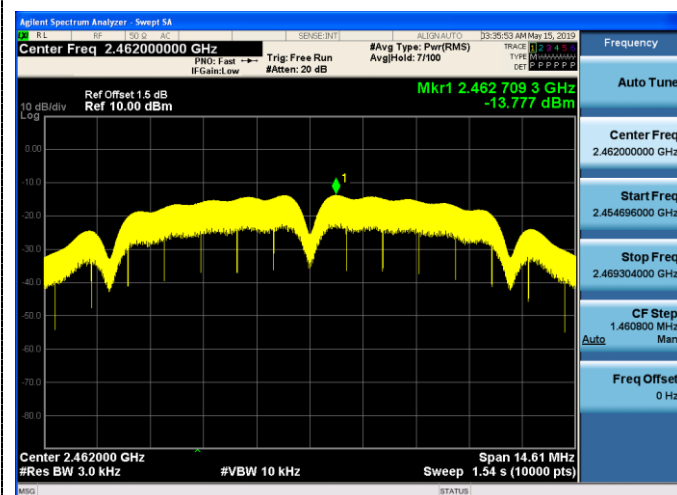

CH06

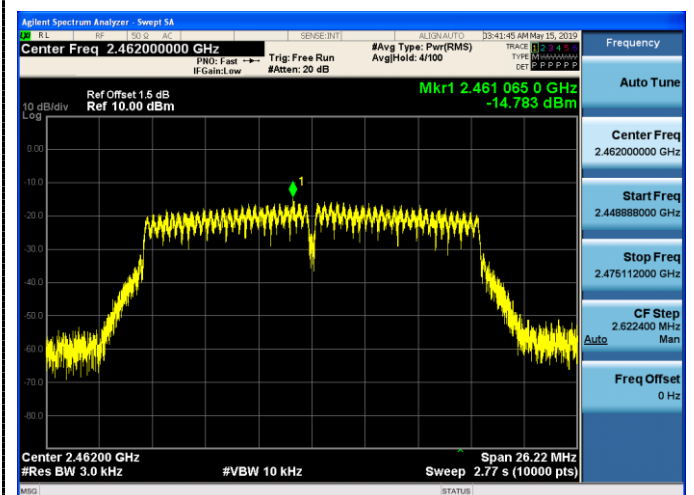

CH11

CH11

802.11n(HT20)

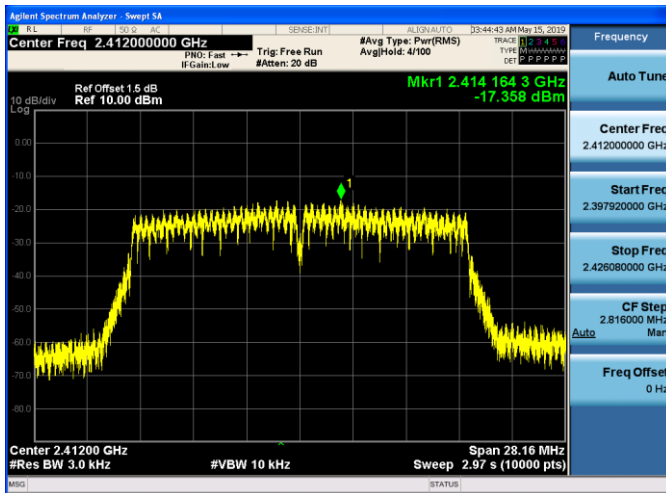

CH01

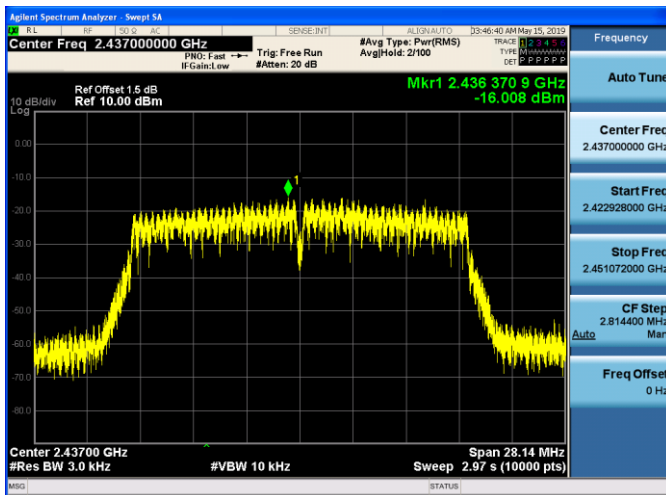

CH06

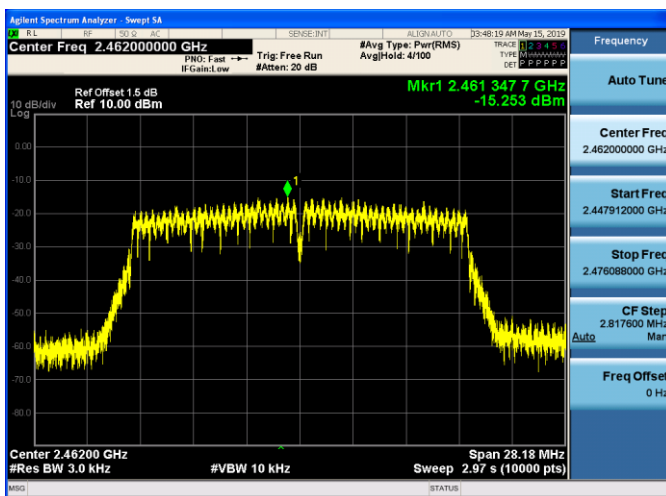

CH11

4.5 6dB Bandwidth

Limit

For digital modulation systems, the minimum 6 dB bandwidth shall be at least 500 kHz

Test Procedure

The transmitter output was connected to the spectrum analyzer through an attenuator. The bandwidth of the fundamental frequency was measured by spectrum analyzer with 100 KHz RBW and 300 KHz VBW. The 6dB bandwidth is defined as the total spectrum the power of which is higher than peak power minus 6dB.

Test Configuration

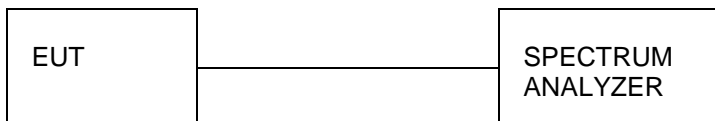

Test Results

WIFI

Type	Channel	6dB Bandwidth (MHz)	99% OBW (MHz)	Limit (KHz)	Result
802.11b	01	9.131	12.728	≥500	Pass
	06	9.131	12.888		
	11	9.130	12.932		
802.11g	01	16.38	16.355	≥500	Pass
	06	16.39	16.366		
	11	16.39	16.419		
802.11n(HT20)	01	17.60	17.555	≥500	Pass
	06	17.59	17.555		
	11	17.61	17.566		

Note:

- 1) Measured peak power spectrum density at difference data rate for each mode and recorded worst case for each mode.
- 2) Test results including cable loss;
- 3) Worst case data at 1Mbps at IEEE 802.11b; 6Mbps at IEEE 802.11g; 6.5Mbps at IEEE 802.11n HT20,

Please refer to following plots;

802.11b

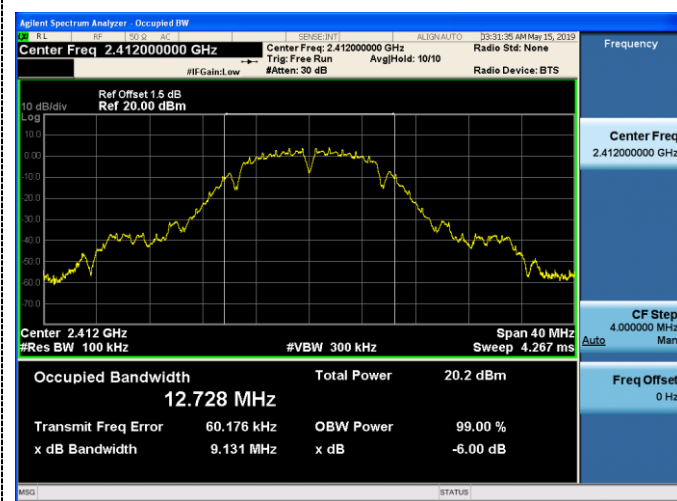

802.11g

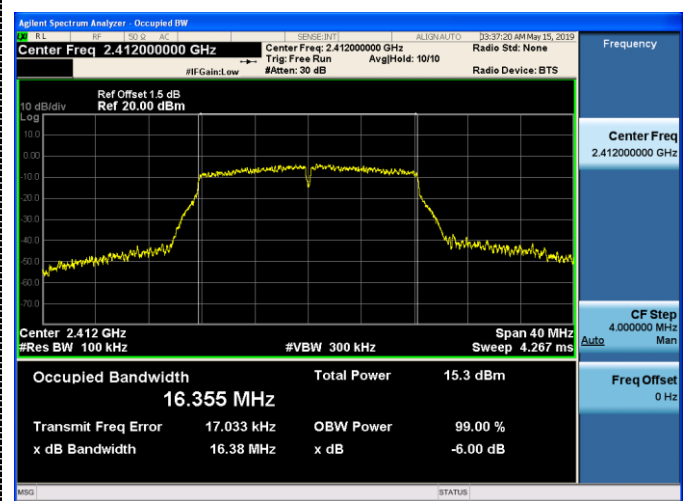

CH01

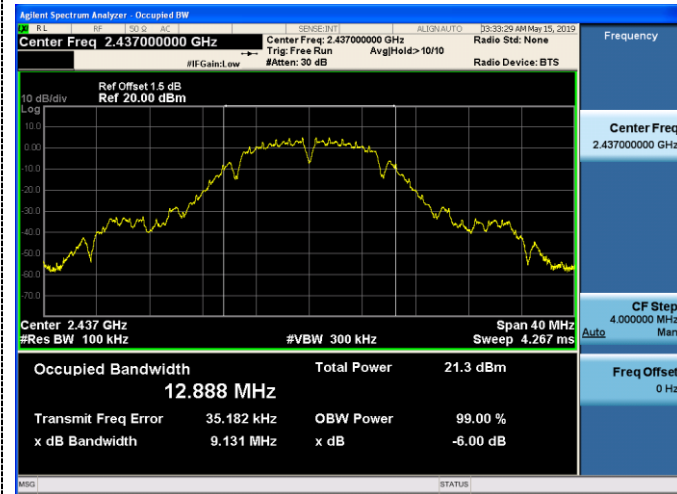

CH01

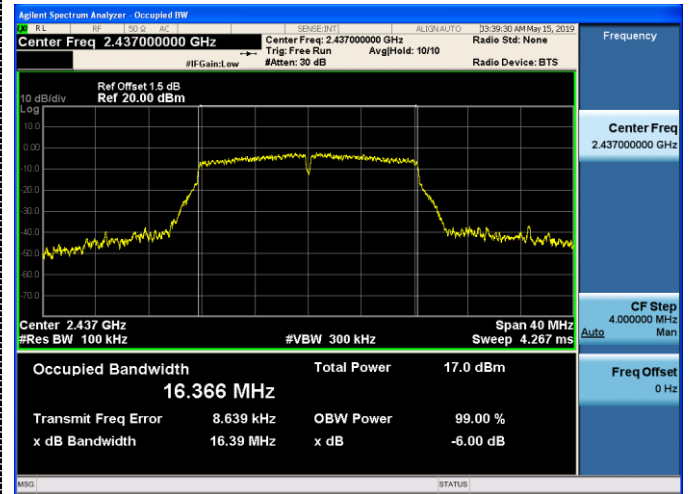

CH06

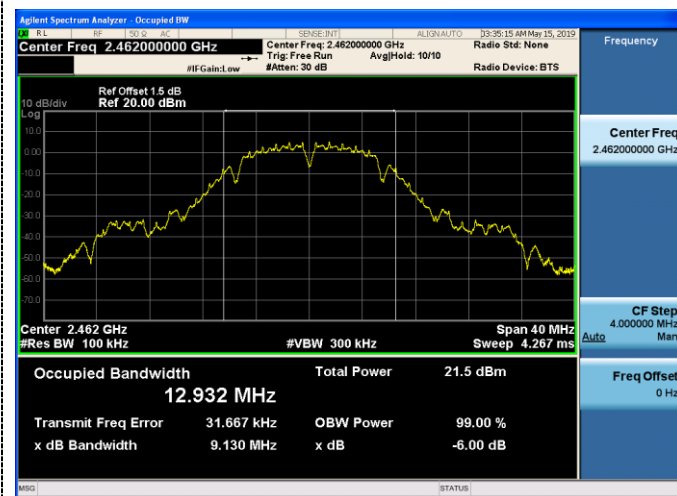

CH06

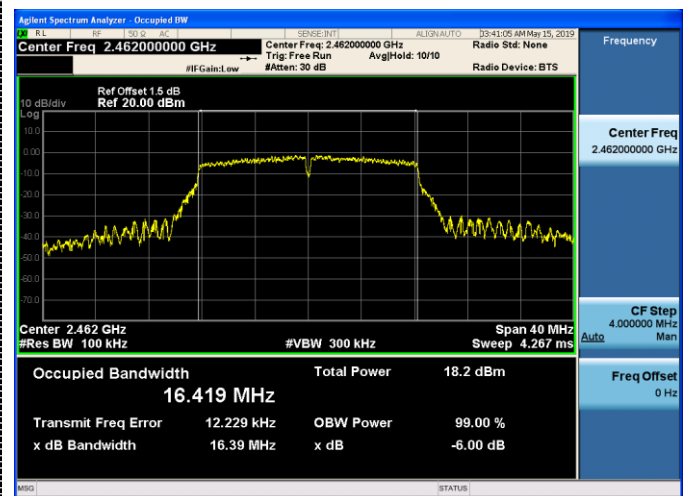

CH11



CH11



802.11n(HT20)

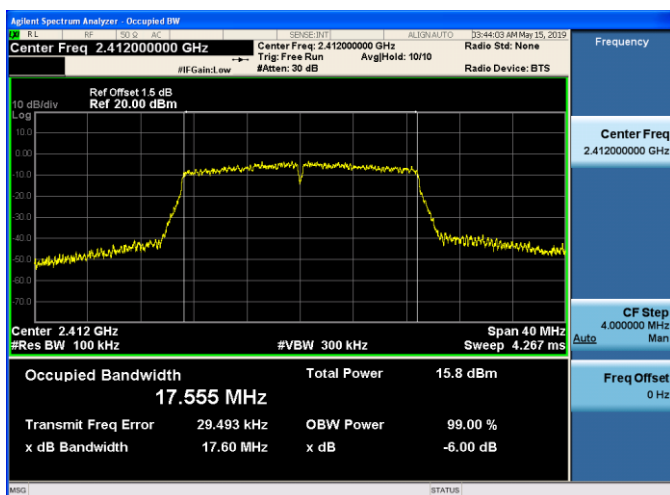

CH01

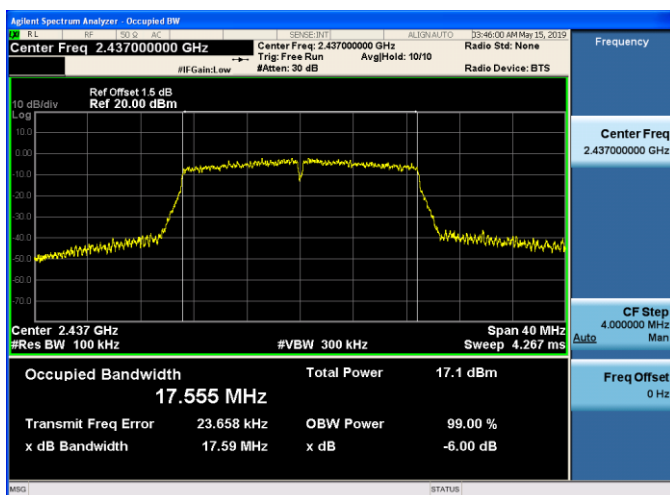

CH06

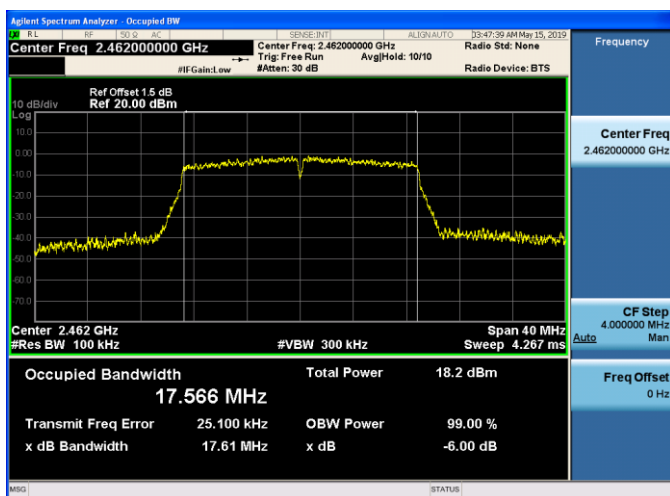

CH11

4.6 Out-of-band Emissions

Limit

In any 100 kHz bandwidth outside the frequency band in which the spread spectrum or digitally modulated intentional radiator is operating, the radio frequency power that is produced by the intentional radiator shall be at least 20 dB below that in the 100 kHz bandwidth within the band that contains the highest level of the desired power, based on either an RF conducted or a radiated measurement, provided the transmitter demonstrates compliance with the peak conducted power limits. If the transmitter complies with the conducted power limits based on the use of RMS averaging over a time interval, as permitted under paragraph (b)(3) of this section, the attenuation required under this paragraph shall be 30 dB instead of 20 dB. Attenuation below the general limits specified in §15.209(a) is not required.

Test Procedure

Connect the transmitter output to spectrum analyzer using a low loss RF cable, and set the spectrum analyzer to RBW=100 kHz, VBW= 300 kHz, peak detector , and max hold. Measurements utilizing these setting are made of the in-band reference level, bandedge and out-of-band emissions.

Test Configuration

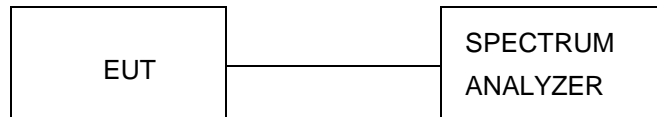

Test Results

Remark: The measurement frequency range is from 30MHz to the 10th harmonic of the fundamental frequency. The lowest, middle and highest channels are tested to verify the spurious emissions and bandage measurement data. And record the worst data in the report.

Test plot as follows:

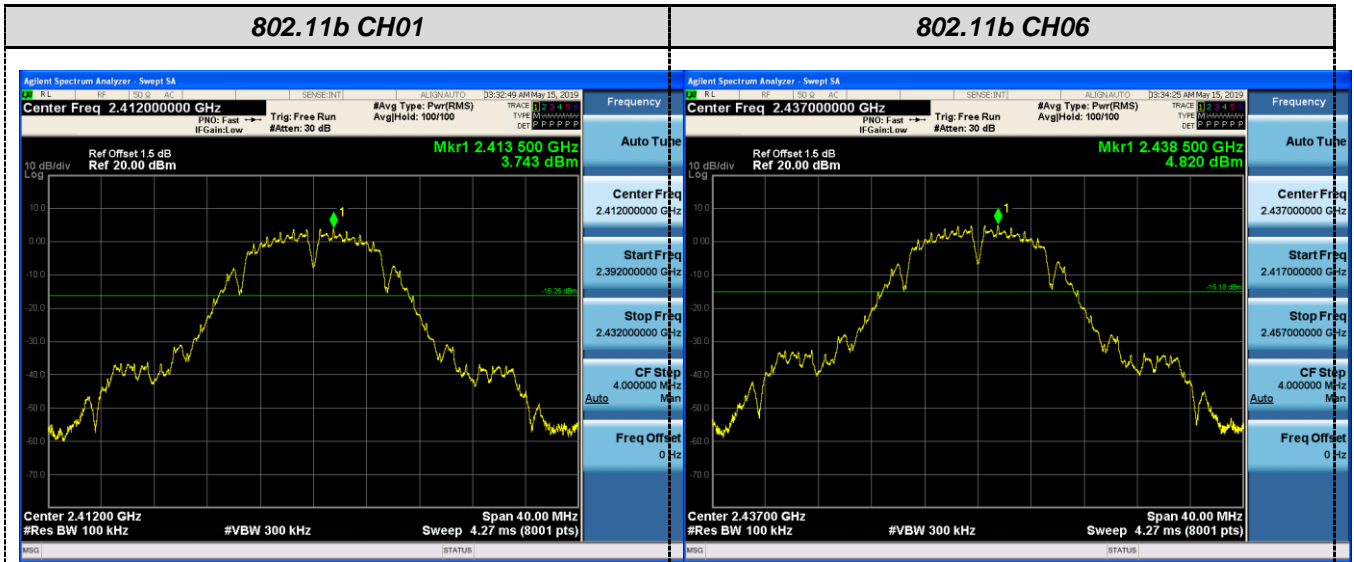

Reference

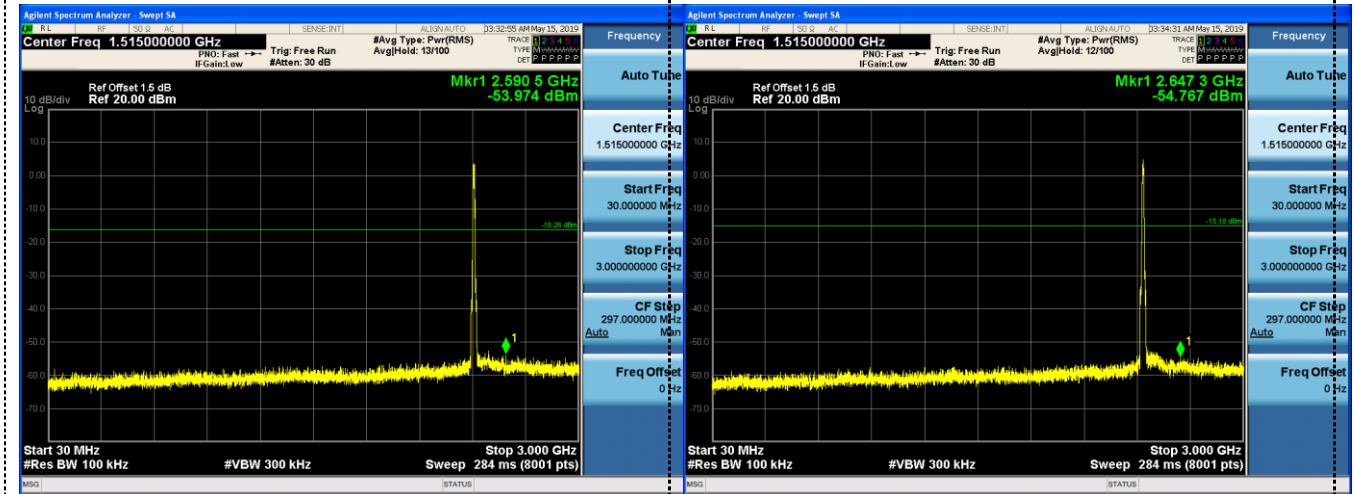

30MHz-3GHz

30MHz-3GHz

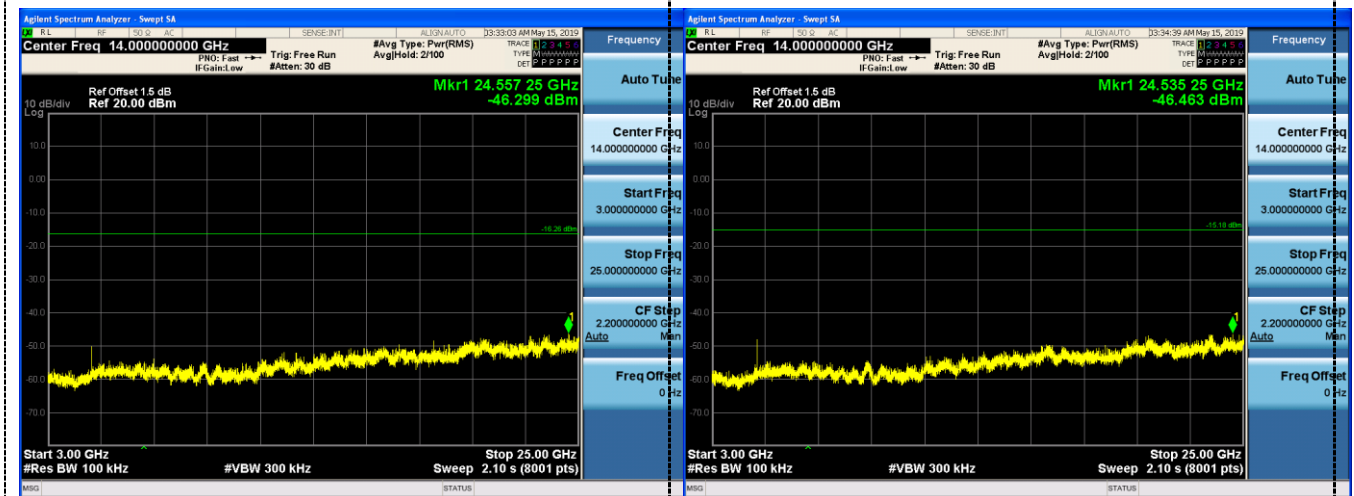

3GHz-25GHz

3GHz-25GHz

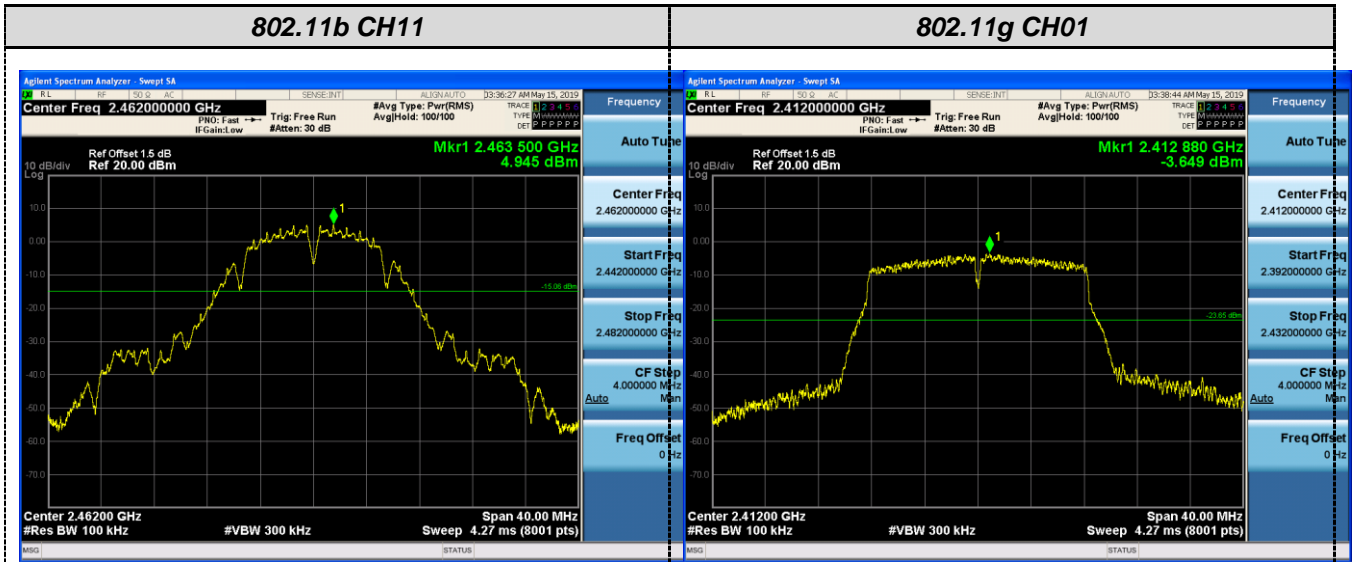

Reference

Reference

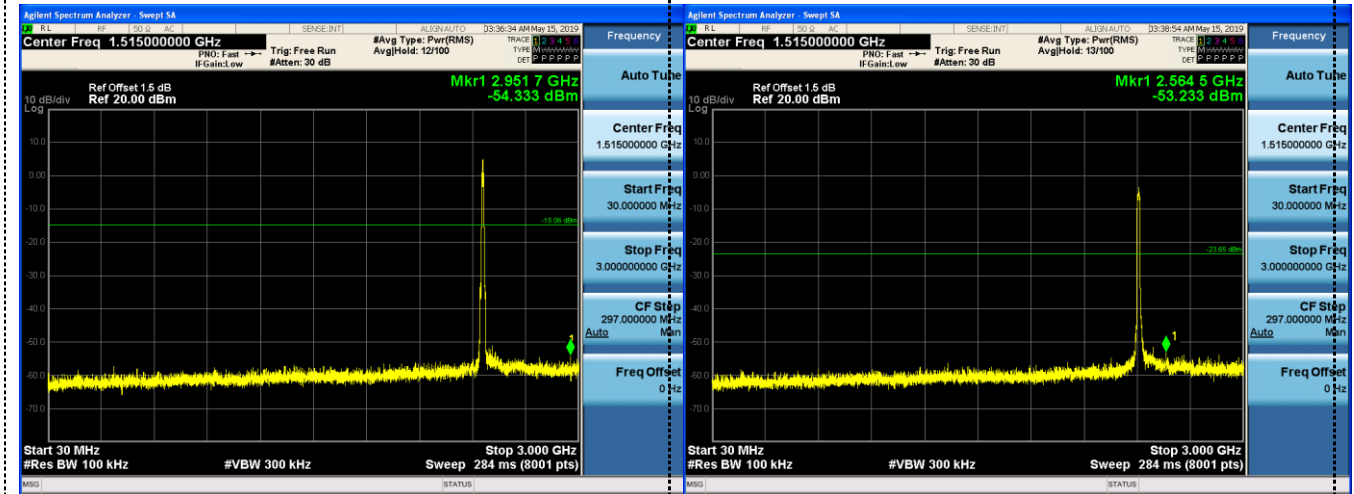

30MHz-3GHz

30MHz-3GHz

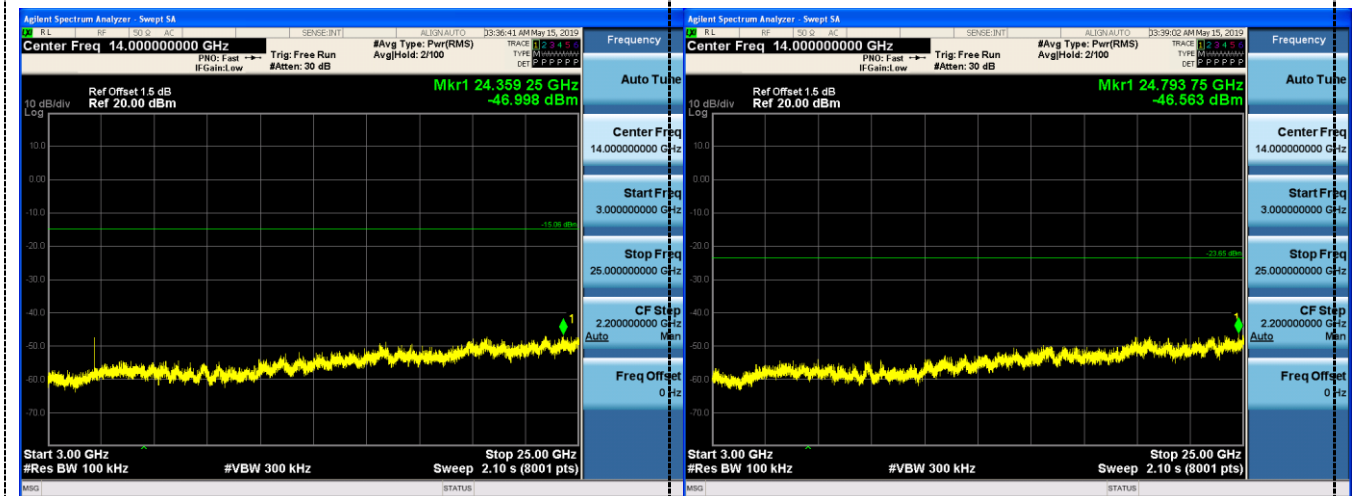

3GHz-25GHz

3GHz-25GHz

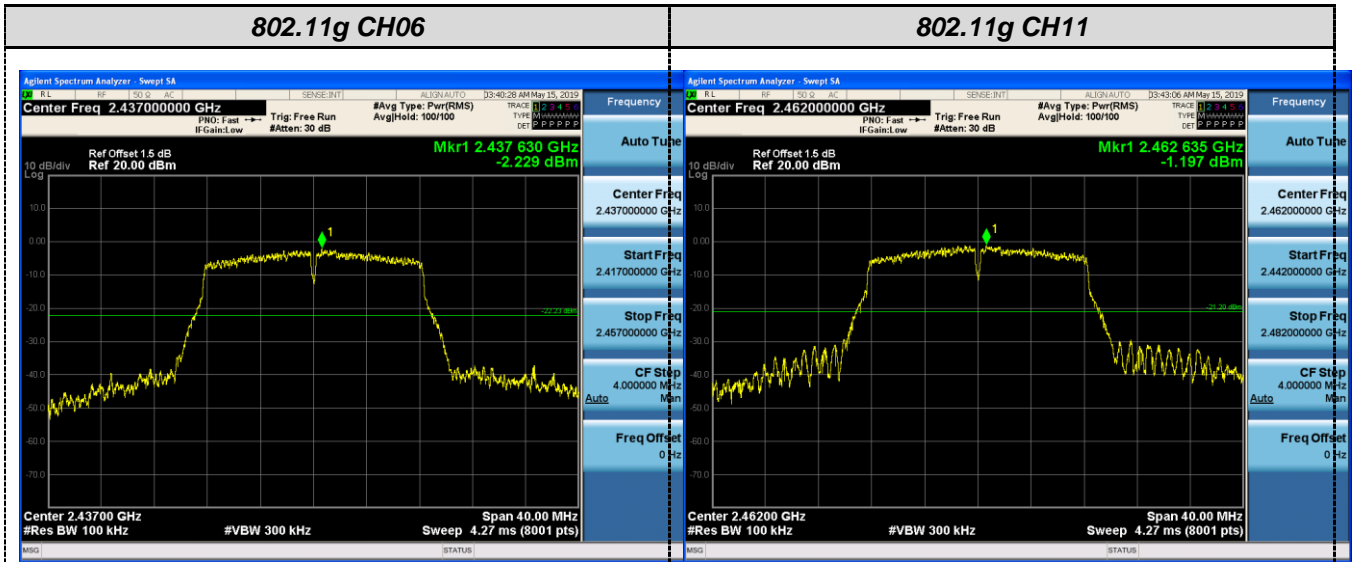

Reference

Reference

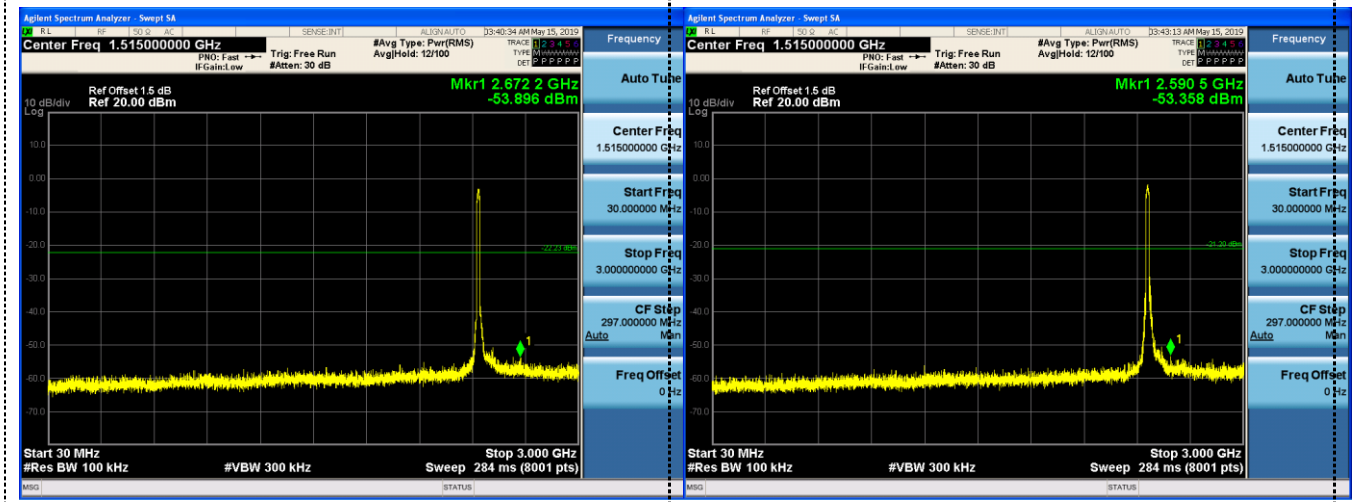

30MHz-3GHz

30MHz-3GHz

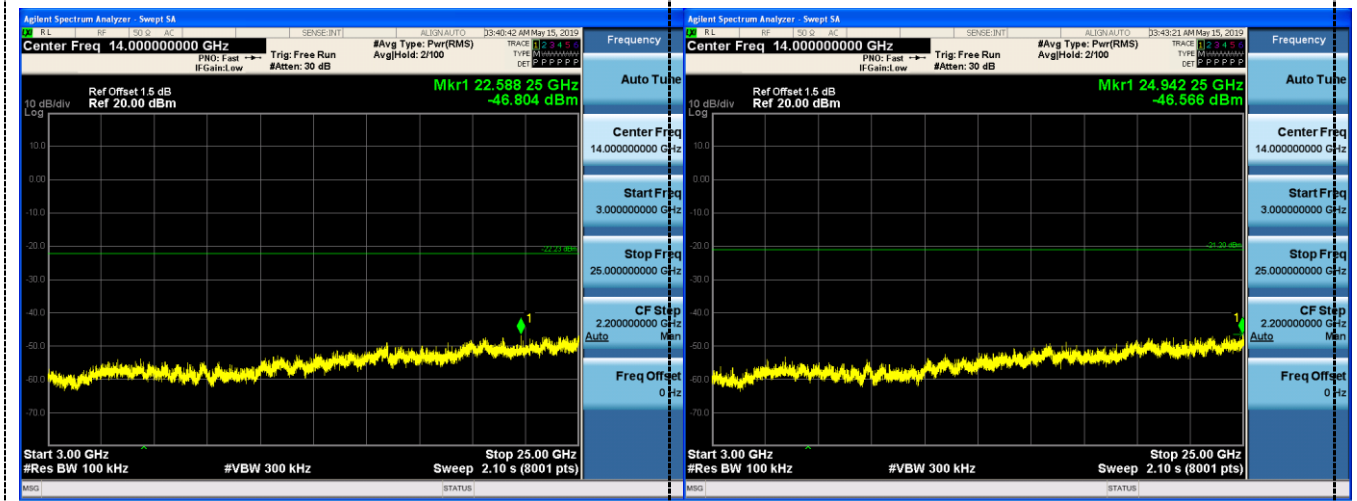

3GHz-25GHz

3GHz-25GHz

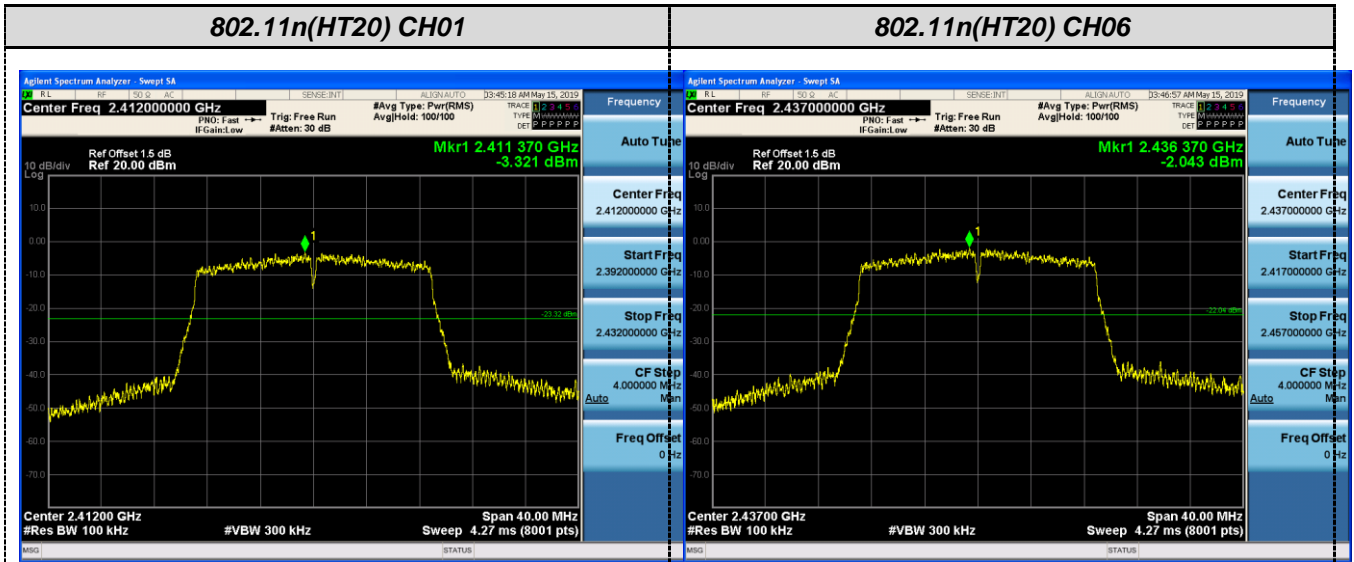

Reference

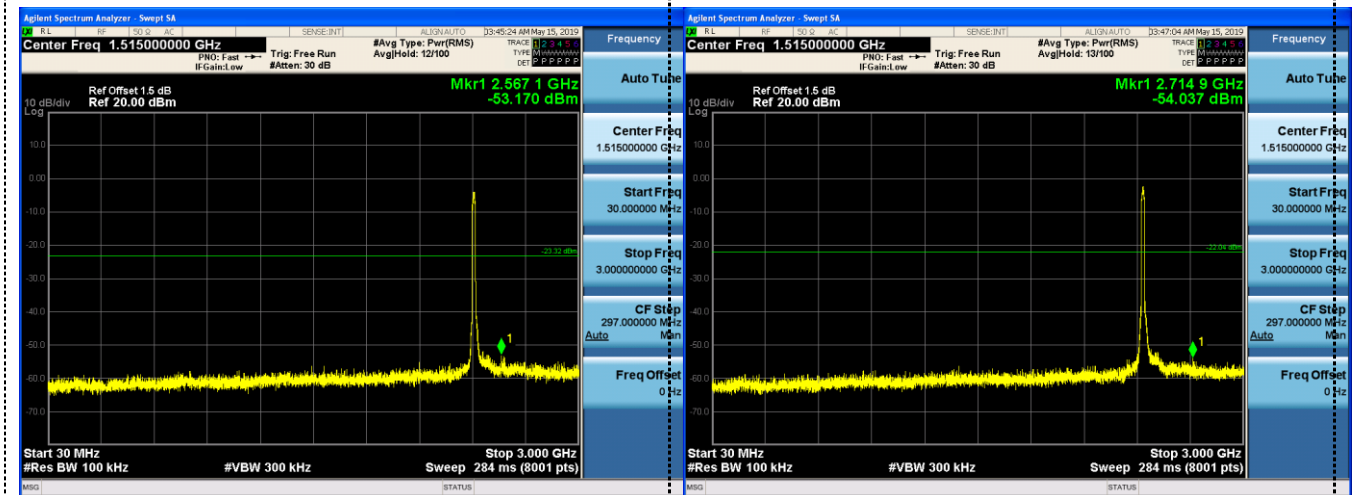

30MHz-3GHz

30MHz-3GHz

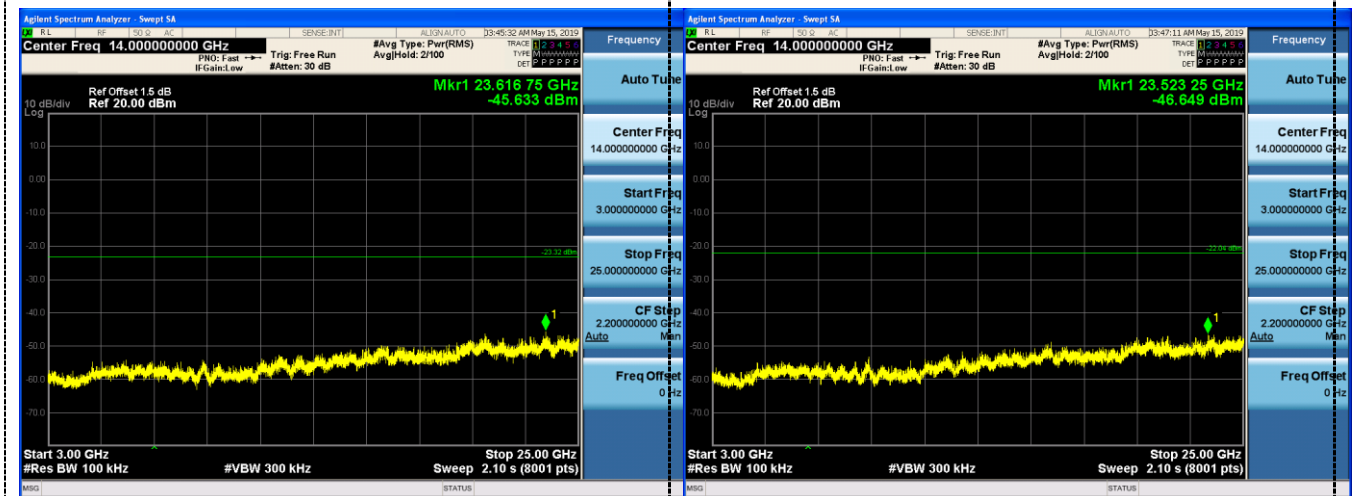

3GHz-25GHz

3GHz-25GHz

802.11n(HT20) CH11

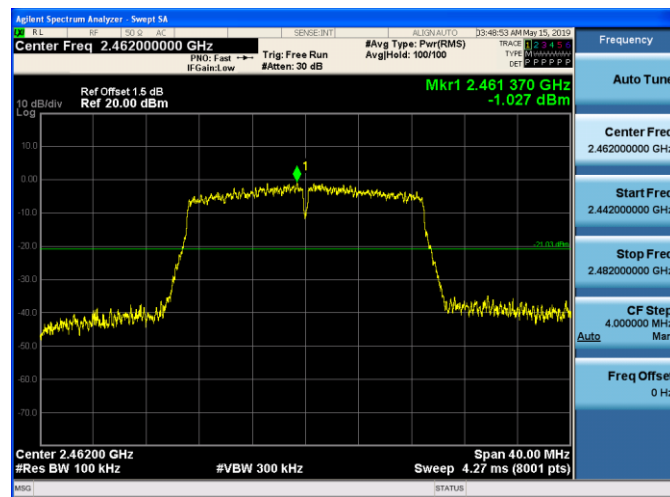

Reference

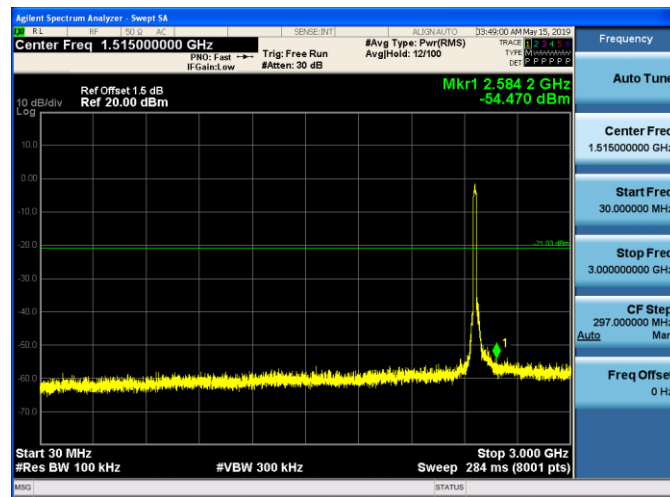

30MHz-3GHz

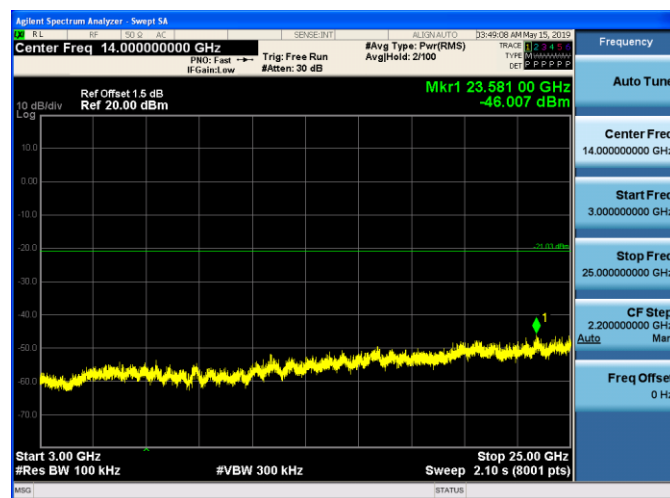

3GHz-25GHz

Band-edge Measurements for RF Conducted Emissions:

802.11b

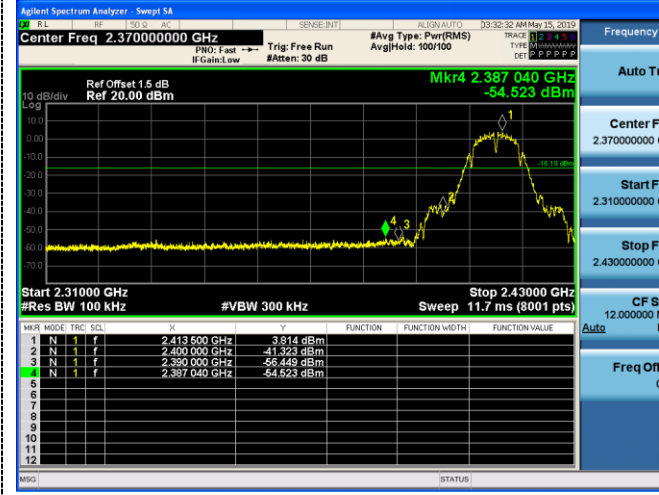

Left bandedge

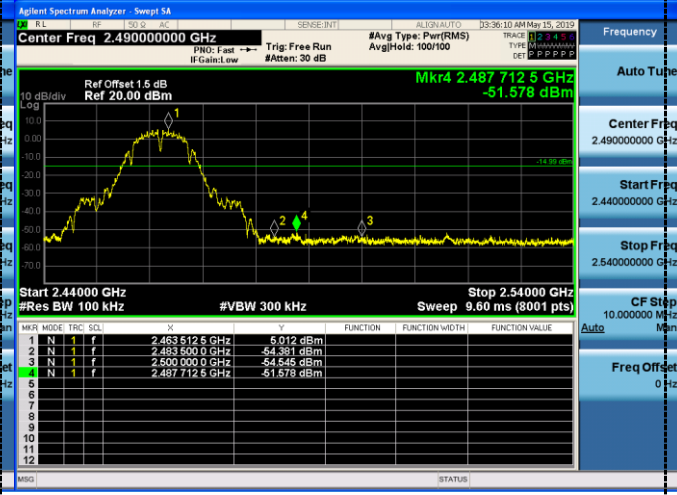

Right bandedge

802.11g

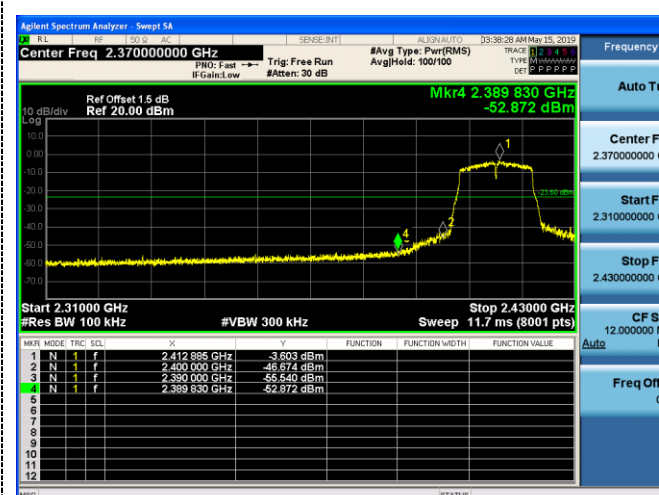

Left bandedge

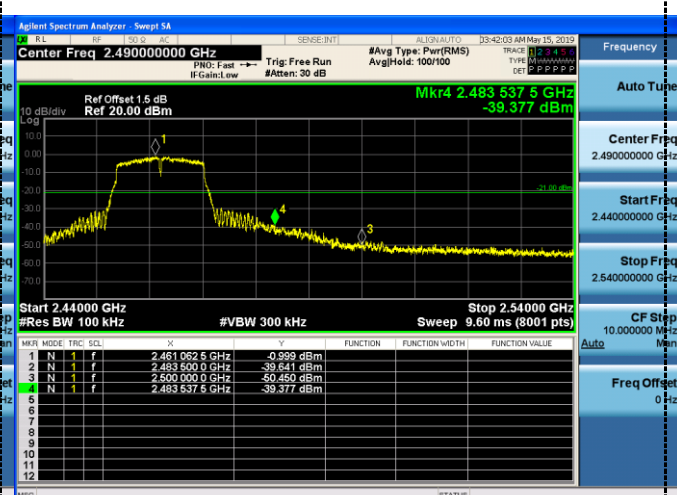

Right bandedge

802.11n(HT20)

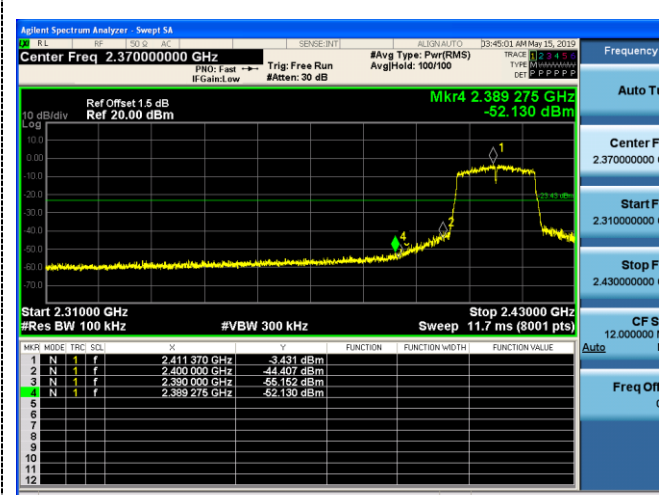

Left bandedge

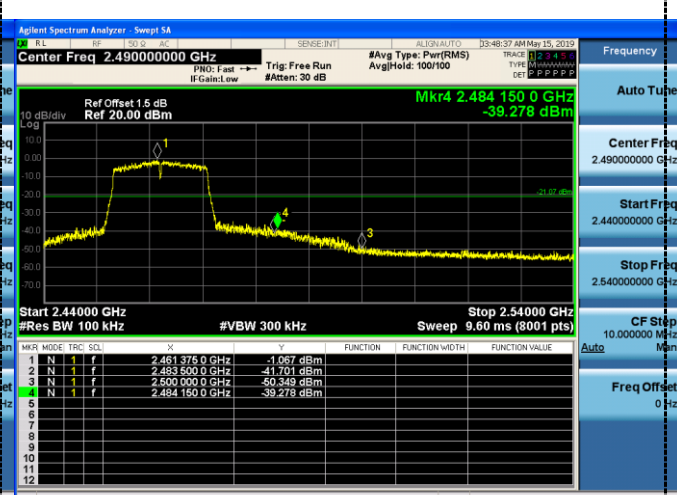

Right bandedge

4.7 Antenna Requirement

Standard Applicable

For intentional device, according to FCC 47 CFR Section 15.203:

An intentional radiator shall be designed to ensure that no antenna other than that furnished by the responsible party shall be used with the device. The use of a permanently attached antenna or of an antenna that uses a unique coupling to the intentional radiator, the manufacturer may design the unit so that a broken antenna can be replaced by the user, but the use of a standard antenna jack or electrical connector is prohibited

FCC CFR Title 47 Part 15 Subpart C Section 15.247(c) (1) (I):

(i) Systems operating in the 2400-2483.5 MHz band that is used exclusively for fixed. Point-to-point operations may employ transmitting antennas with directional gain greater than 6dBi provided the maximum conducted output power of the intentional radiator is reduced by 1 dB for every 3 dB that the directional gain of the antenna exceeds 6dBi.

Test Result:

The maximum gain of antenna was 0.8dBi for 2.4GHz WIFI.

5 Test Setup Photos of the EUT



6 Photos of the EUT

Reference to the test report No. GTS20190515004-1-2-1

******* End of Report *******