

## SAR TEST REPORT

**Report Reference No.....: MWR150600107**

**FCC ID.....: RQQLT-E435**

Compiled by  
( position+printed name+signature)..: File administrators Martin Ao



Supervised by  
( position+printed name+signature)..: Test Engineer Martin Ao

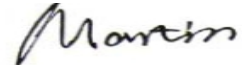

Approved by  
( position+printed name+signature)..: Manager Dixon Hao

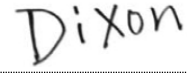

Date of issue.....: Jun 18, 2015

**Representative Laboratory Name : Maxwell International Co., Ltd.**

Address.....: Room 509,Hongfacenter building, Baoan District, Shenzhen, Guangdong, China

**Testing Laboratory Name.....: The Testing and Technology Center for Industrial Products of Shenzhen Entry-Exit Inspection and Quarantine Bureau**

Address.....: No.289, 8th Industry Road, NanshanDistrict,Shenzhen,Guangdong

**Applicant's name.....: HYUNDAI CORPORATION**

Address.....: 140-2, Kye-dong, Chongro-ku, Seoul, South Korea

**Test specification.....:**

Standard.....: **ANSI C95.1-1999**  
**47CFR §2.1093**

TRF Originator.....: **Maxwell International Co., Ltd.**

**Maxwell International Co., Ltd. All rights reserved.**

This publication may be reproduced in whole or in part for non-commercial purposes as long as the Maxwell International Co., Ltd. as copyright owner and source of the material. Maxwell International Co., Ltd. takes no responsibility for and will not assume liability for damages resulting from the reader's interpretation of the reproduced material due to its placement and context.

**Test item description.....: Mobile Phone**

Trade Mark.....: HYUNDAI

**Manufacturer.....: WASAM TECHNOLOGY (SHEN ZHEN) CO.,LTD.**

Model/Type reference.....: E435

Listed Models .....: N/A

Operation Frequency..... GSM 850MHz/PCS1900MHz/WiFi2450/BT/UMTS Band II/V

Modulation Type..... GSM(GMSK, 8PSK), Bluetooth(GFSK,8DPSK,II/4DQPSK),  
DSSS(CCK,DQPSK,DBPSK),OFDM(64QAM,16QAM,QPSK,  
BPSK), UMTS(QPSK)

Hardware version.....: T6461 - V2.0

Software version .....: T6461\_MUSO\_V1\_20150529.rar

Rating.....: DC 3.80V

Result.....: **PASS**

**TEST REPORT**

<b>Test Report No. :</b>	<b>MWR150600107</b>	Jun 18, 2015
		Date of issue

Equipment under Test : Mobile Phone

Model /Type : E435

Listed Models : N/A

**Applicant** : **HYUNDAI CORPORATION**

Address : 140-2, Kye-dong, Chongro-ku, Seoul, South Korea

**Manufacturer** : **WASAM TECHNOLOGY (SHEN ZHEN) CO.,LTD.**

Address : Room A30, 9th floor, Silvercorp International Tower No 707-713, Nathan Road, mongkok, Kowloon, Hong Kong

<b>Test Result:</b>	<b>PASS</b>
---------------------	-------------

The test report merely corresponds to the test sample.  
It is not permitted to copy extracts of these test result without the written permission of the test laboratory.

## Contents

<b>1.</b>	<b>TEST STANDARDS</b>	<b>4</b>
<b>2.</b>	<b>SUMMARY</b>	<b>5</b>
2.1.	General Remarks	5
2.2.	Product Description	5
2.3.	Statement of Compliance	6
2.4.	Equipment under Test	7
2.5.	EUT configuration	8
2.6.	Note	8
<b>3.</b>	<b>TEST ENVIRONMENT</b>	<b>9</b>
3.1.	Address of the test laboratory	9
3.2.	Test Facility	9
3.3.	Environmental conditions	9
3.4.	SAR Limits	9
3.5.	Equipments Used during the Test	10
<b>4.</b>	<b>SAR MEASUREMENTS SYSTEM CONFIGURATION</b>	<b>11</b>
4.1.	SAR Measurement Set-up	11
4.2.	DASY5 E-field Probe System	12
4.3.	Phantoms	12
4.4.	Device Holder	13
4.5.	Scanning Procedure	13
4.6.	Data Storage and Evaluation	14
4.7.	Tissue Dielectric Parameters for Head and Body Phantoms	16
4.8.	Tissue equivalent liquid properties	16
4.9.	System Check	16
4.10.	SAR measurement procedure	18
4.11.	Power Reduction	27
<b>5.</b>	<b>TEST CONDITIONS AND RESULTS</b>	<b>28</b>
5.1.	Conducted Power Results	28
5.2.	Simultaneous TX SAR Considerations	33
5.3.	SAR Measurement Results	37
5.4.	SAR Measurement Variability	41
5.5.	General description of test procedures	42
5.6.	Measurement Uncertainty for System Check (300MHz-3GHz)	43
5.7.	System Check Results	45
5.8.	SAR Test Graph Results	51
<b>6.</b>	<b>CALIBRATION CERTIFICATE</b>	<b>61</b>
6.1.	Probe Calibration Certificate	61
6.2.	D835V2 Dipole Calibration Certificate	72
6.3.	D1900V2 Dipole Calibration Certificate	80
6.4.	D2450V2 Dipole Calibration Certificate	88
6.5.	DAE4 Calibration Certificate	96
<b>7.</b>	<b>TEST SETUP PHOTOS</b>	<b>99</b>

## 8. EXTERNAL PHOTOS OF THE EUT

105

**1. TEST STANDARDS**

The tests were performed according to following standards:

[IEEE Std C95.1, 1999](#): IEEE Standard for Safety Levels with Respect to Human Exposure to Radio Frequency Electromagnetic Fields, 3 KHz to 300 GHz. It specifies the maximum exposure limit of 1.6 W/kg as averaged over any 1 gram of tissue for portable devices being used within 20 cm of the user in the uncontrolled environment.

[IEEE Std 1528™-2003](#): IEEE Recommended Practice for Determining the Peak Spatial-Average Specific Absorption Rate (SAR) in the Human Head from Wireless Communications Devices: Measurement Techniques.

[KDB 447498 D01 Mobile Portable RF Exposure v05r02](#): Mobile and Portable Device RF Exposure Procedures and Equipment Authorization Policies

[KDB865664 D01 SAR measurement 100 MHz to 6 GHz v02](#): SAR Measurement Requirements for 100 MHz to 6 GHz

[KDB865664 D02 SAR Reporting v01](#): RF Exposure Compliance Reporting and Documentation Considerations

[KDB248227 D01 802.11 Wi-Fi SAR v02](#): SAR GUIDANCE FOR IEEE 802.11 (Wi-Fi) TRANSMITTERS

[FCC Part 2.1093 Radiofrequency Radiation Exposure Evaluation](#): Portable Devices

[KDB941225 D01 3G SAR Procedures v03](#): 3G SAR MEAUREMENT PROCEDURES

[KDB941225 D06 Hot Spot SAR v02](#): SAR EVALUATION PROCEDURES FOR PORTABLE DEVICES WITH WIRELESS ROUTER CAPABILITIES

[KDB 648474 D04, Handset SAR v01r02](#): SAR Evaluation Considerations for Wireless Handsets

## 2. SUMMARY

### 2.1. General Remarks

Date of receipt of test sample	:	May 25, 2015
Testing commenced on	:	Jun 02, 2015
Testing concluded on	:	Jun 08, 2015

### 2.2. Product Description

The **HYUNDAI CORPORATION**'s Model:E435 or the "EUT" as referred to in this report; more general information as follows, for more details, refer to the user's manual of the EUT.

General Description	
Model Number	E435
FCC ID	RQQHLT-E435
Modulation Type	GMSK for GSM/GPRS/EGPRS;QPSK for WCDMA
Antenna Type	Internal
Device category	Portable Device
Exposure category	General population/uncontrolled environment
EUT Type	Production Unit
Rated Voltage	DC 3.70 Battery
Hotspot	Supported, power not reduced when Hotspot open
<i>The EUT is GSM850/900/DCS1800/PCS1900, UMTS Band II,V mobile phone. the mobile phone is intended for speech and Multimedia Message Service (MMS) transmission. It is equipped with GPRS/EDGE class 12 for GSM850, PCS1900, UMTS Band II, Band V and Bluetooth, WiFi, and camera functions. For more information see the following datasheet</i>	

Technical Characteristics	
2G	
Support Networks	GSM, GPRS, EDGE
Support Band	GSM850/PCS1900
Uplink Frequency	GSM/GPRS/EDGE 850: 824~849MHz GSM/GPRS/EDGE 1900: 1850~1910MHz
Downlink Frequency	GSM/GPRS/EDGE 850: 869~894MHz GSM/GPRS/EDGE 1900: 1930~1990MHz
Type of Modulation	GMSK, 8PSK for only downlink
Antenna Type	Internal Antenna
GPRS/EDGE Class	Class 12
HSDPA UE Category	10
HSUPA UE Category	6
GSM Release Version	R99
GPRS operation mode	Class B
DTM Mode	Not Supported
3G	
Support Networks	UMTS
Support Band	UMTS Band II, Band V
Type of Modulation	QPSK
Antenna Type	Internal Antenna
WiFi	
Support Standards	802.11b, 802.11g, 802.11n
Frequency Range	2412-2462MHz for 11b/g/n(HT20) 2422-2452MHz for 11n(HT40)
Type of Modulation	CCK, OFDM, QPSK, BPSK, 16QAM, 64QAM
Data Rate	1-11Mbps, 6-54Mbps, up to 150Mbps
Quantity of Channels	11 for 11b/g/n(HT20), 7 for 11n(HT40)
Channel Separation	5MHz

Antenna Type	Internal Antenna
Bluetooth	
Bluetooth Version	V3.0+EDR/V4.0
Frequency Range	2402-2480MHz
Data Rate	1Mbps, 2Mbps, 3Mbps
Modulation	GFSK, $\pi/4$ QDPSK, 8DPSK
Quantity of Channels	79/40
Channel Separation	1MHz/2MHz
Antenna Type	Internal Antenna

The 3-AXIS ACCELEROMETER sensor cannot use as power reduction and it is only used as screen orientation or compass etc.

### 2.3. Statement of Compliance

The maximum of results of SAR found during testing for E435are follows:

Classment Class	Frequency Band	Operating Mode	The Highest SAR Summary			MAX Simultaneous transmission SAR(W/Kg)
			Head (1g SAR(W/Kg))	Hotspot (1g SAR(W/Kg))	Body-worn (1g SAR(W/Kg))	
PCE	GSM 850	Voice/Data	<b>0.407</b>	<b>0.697</b>	<b>0.766</b>	<b>1.502</b>
	GSM1900	Voice/Data	<b>0.482</b>	<b>0.903</b>	<b>0.972</b>	
	UMTS Band II	RMC	<b>0.531</b>	<b>0.850</b>	<b>0.951</b>	
	UMTS Band V	RMC	<b>0.572</b>	<b>0.945</b>	<b>0.979</b>	
DTS	WiFi(802.11)	Data	<b>0.560</b>	<b>0.647</b>	<b>0.784</b>	
DSS	Bluetooth	Data	<b>N/A</b>	<b>N/A</b>	<b>N/A</b>	

The SAR values found for the smart phone are below the maximum recommended levels of 1.6W/Kg as averaged over any 1g tissue according to the ANSI C95.1-1999.

For body worn operation, this device has been tested and meets FCC RF exposure guidelines when used with any accessory that contains no metal and which provides a minimum separation distance of 5mm between this device and the body of the user. User of other accessories may not ensure compliance with FCC RF exposure guidelines. And the test distance of Hotspot mode is 10mm.

The EUT battery must be fully charged and checked periodically during the test to ascertain uniform power output.

**Simultaneous transmission:**

#### Head Exposure Conditions

##### Simultaneous transmission SAR for WiFi and GSM/UMTS

Test Position	SAR Type	GSM850 Reported SAR <sub>1-g</sub> (W/Kg)	GSM1900 Reported SAR <sub>1-g</sub> (W/Kg)	UMTS Band II Reported SAR <sub>1-g</sub> (W/Kg)	UMTS Band V Reported SAR <sub>1-g</sub> (W/Kg)	WiFi Reported SAR <sub>1-g</sub> (W/Kg)	MAX. $\Sigma$ SAR <sub>1-g</sub> (W/Kg)	SAR <sub>1-g</sub> Limit (W/Kg)	Peak location separation ratio	Simut. Meas. Required
Left/Cheek	1-g	<b>0.407</b>	<b>0.482</b>	<b>0.531</b>	<b>0.572</b>	0.249	<b>0.821</b>	1.6	no	no
Left/Tilt	1-g	0.345	0.407	0.478	0.521	0.218	0.739	1.6	no	no
Right/Cheek	1-g	0.337	0.413	0.465	0.501	<b>0.300</b>	0.801	1.6	no	no
Right/Tilt	1-g	0.303	0.367	0.439	0.459	0.249	0.708	1.6	no	no

##### Simultaneous transmission SAR for Bluetooth and GSM/UMTS

Test Position	SAR Type	GSM850 Reported SAR <sub>1-g</sub> (W/Kg)	GSM1900 Reported SAR <sub>1-g</sub> (W/Kg)	UMTS Band II Reported SAR <sub>1-g</sub> (W/Kg)	UMTS Band V Reported SAR <sub>1-g</sub> (W/Kg)	Bluetooth Estimated SAR <sub>1-g</sub> (W/Kg)	MAX. $\Sigma$ SAR <sub>1-g</sub> (W/Kg)	SAR <sub>1-g</sub> Limit (W/Kg)	Peak location separation ratio	Simut. Meas. Required
Left/Cheek	1-g	<b>0.407</b>	<b>0.482</b>	<b>0.531</b>	<b>0.572</b>	0.05	<b>0.622</b>	1.6	no	no
Left/Tilt	1-g	0.345	0.407	0.478	0.521	0.05	0.571	1.6	no	no
Right/Cheek	1-g	0.337	0.413	0.465	0.501	0.05	0.551	1.6	no	no
Right/Tilt	1-g	0.303	0.367	0.439	0.459	0.05	0.509	1.6	no	no

## Body-Worn Accessory Exposure Conditions

### Simultaneous transmission SAR for WiFi and GSM/UMTS

Test Position	SAR Type	GSM850 Reported SAR <sub>1-g</sub> (W/Kg)	GSM1900 Reported SAR <sub>1-g</sub> (W/Kg)	UMTS Band II Reported SAR <sub>1-g</sub> (W/Kg)	UMTS Band V Reported SAR <sub>1-g</sub> (W/Kg)	WiFi Reported SAR <sub>1-g</sub> (W/Kg)	MAX. ΣSAR <sub>1-g</sub> (W/Kg)	SAR <sub>1-g</sub> Limit (W/Kg)	Peak location separation ratio	Simut. Meas. Required
Rear Side	1-g	<b>0.766</b>	<b>0.972</b>	<b>0.951</b>	<b>0.979</b>	0.523	<b>1.502</b>	1.6	no	no
Front Side	1-g	0.723	0.875	0.829	0.920	0.325	1.245	1.6	no	no

### Simultaneous transmission SAR for Bluetooth and GSM/UMTS

Test Position	SAR Type	GSM850 Reported SAR <sub>1-g</sub> (W/Kg)	GSM1900 Reported SAR <sub>1-g</sub> (W/Kg)	UMTS Band II Reported SAR <sub>1-g</sub> (W/Kg)	UMTS Band V Reported SAR <sub>1-g</sub> (W/Kg)	Bluetooth Estimated SAR <sub>1-g</sub> (W/Kg)	MAX. ΣSAR <sub>1-g</sub> (W/Kg)	SAR <sub>1-g</sub> Limit (W/Kg)	Peak location separation ratio	Simut. Meas. Required
Rear Side	1-g	<b>0.766</b>	<b>0.972</b>	<b>0.951</b>	<b>0.979</b>	0.05	<b>1.029</b>	1.6	no	no
Front Side	1-g	0.723	0.875	0.829	0.920	0.05	0.970	1.6	no	no

## Hotspot SAR

### Simultaneous transmission SAR for WiFi and GSM/UMTS (Hotspot Open)

Test Position	SAR Type	GSM850 Reported SAR <sub>1-g</sub> (W/Kg)	GSM1900 Reported SAR <sub>1-g</sub> (W/Kg)	UMTS Band II Reported SAR <sub>1-g</sub> (W/Kg)	UMTS Band V Reported SAR <sub>1-g</sub> (W/Kg)	WiFi Reported SAR <sub>1-g</sub> (W/Kg)	MAX. ΣSAR <sub>1-g</sub> (W/Kg)	SAR <sub>1-g</sub> Limit (W/Kg)	Peak location separation ratio	Simut. Meas. Required
Rear Side	1-g	<b>0.679</b>	<b>0.903</b>	<b>0.850</b>	<b>0.945</b>	<b>0.387</b>	<b>1.332</b>	1.6	no	no
Front Side	1-g	0.588	0.703	0.737	0.765	0.346	1.111	1.6	no	no
Left Side	1-g	0.310	0.453	0.497	0.496	0.361	0.858	1.6	no	no
Right Side	1-g	0.613	0.854	0.775	0.791	N/A	0.854	1.6	no	no
Top Side	1-g	N/A	N/A	N/A	N/A	0.353	0.353	1.6	no	no
Bottom Side	1-g	0.653	0.875	0.827	0.798	N/A	0.875	1.6	no	no

### Simultaneous transmission SAR for Bluetooth and GSM/UMTS (Hotspot Open)

Test Position	SAR Type	GSM850 Reported SAR <sub>1-g</sub> (W/Kg)	GSM1900 Reported SAR <sub>1-g</sub> (W/Kg)	UMTS Band II Reported SAR <sub>1-g</sub> (W/Kg)	UMTS Band V Reported SAR <sub>1-g</sub> (W/Kg)	Bluetooth Estimated SAR <sub>1-g</sub> (W/Kg)	MAX. ΣSAR <sub>1-g</sub> (W/Kg)	SAR <sub>1-g</sub> Limit (W/Kg)	Peak location separation ratio	Simut. Meas. Required
Rear Side	1-g	<b>0.679</b>	<b>0.903</b>	<b>0.850</b>	<b>0.945</b>	0.03	<b>0.975</b>	1.6	no	no
Front Side	1-g	0.588	0.703	0.737	0.765	0.03	0.795	1.6	no	no
Left Side	1-g	0.310	0.453	0.497	0.496	0.03	0.527	1.6	no	no
Right Side	1-g	0.613	0.854	0.775	0.791	0.03	0.884	1.6	no	no
Top Side	1-g	N/A	N/A	N/A	N/A	0.03	0.030	1.6	no	no
Bottom Side	1-g	0.653	0.875	0.827	0.798	0.03	0.905	1.6	no	no

Note:

1. The WiFi and BT share same antenna, so cannot transmit at same time.
2. The value with block color is the maximum values of standalone
3. The value with blue color is the maximum values of ΣSAR<sub>1-g</sub>

## 2.4. Equipment under Test

### Power supply system utilised

Power supply voltage	:	<input type="radio"/> 120V / 60 Hz	<input type="radio"/> 115V / 60Hz
		<input type="radio"/> 12 V DC	<input type="radio"/> 24 V DC
		<input checked="" type="radio"/> Other (specified in blank below)	

DC 3.80 V

## 2.5. EUT configuration

The following peripheral devices and interface cables were connected during the measurement:

● - supplied by the manufacturer

○ - supplied by the lab

○	Power Cable	Length (m) :	/
		Shield :	/
		Detachable :	/
○	Multimeter	Manufacturer :	/
		Model No. :	/

## 2.6. Note

- The EUT is a Mobile Phone with WCDMA/GSM/GPRS/EDGE,WiFi and Bluetooth fuction,The functions of the EUT listed as below:

	Test Standards	Reference Report
GSM/GPRS/EDGE	FCC Part 22/FCC Part 24	MWR150600101
WCDMA	FCC Part 22/FCC Part 24	MWR150600102
Bluetooth	FCC Part 15 C 15.247	MWR150600103
BLE	FCC Part 15 C 15.247	MWR150600104
WiFi	FCC Part 15 C 15.247	MWR150600105
USB Port	FCC Part 15 B	MWR150600106
SAR	FCC Part 2 §2.1093	MWR150600107



### 3. TEST ENVIRONMENT

#### 3.1. Address of the test laboratory

**The Testing and Technology Center for Industrial Products of Shenzhen Entry-Exit Inspection and Quarantine Bureau**

No.289, 8th Industry Road, Nanshan District, Shenzhen, Guangdong, China

The sites are constructed in conformance with the requirements of ANSI C63.7, ANSI C63.4 (2009) and CISPR Publication 22.

#### 3.2. Test Facility

The test facility is recognized, certified, or accredited by the following organizations:

##### **CNAS-Lab Code: L2872**

The Testing and Technology Center for Industrial Products of Shenzhen Entry-Exit Inspection and Quarantine Bureau has been assessed and proved to be in compliance with CNAS-CL01 Accreditation Criteria for Testing and Calibration Laboratories (identical to ISO/IEC 17025: 2005 General Requirements) for the Competence of Testing and Calibration Laboratories, Date of Registration: May 11, 2014. Valid time is until May 12, 2017.

#### 3.3. Environmental conditions

During the measurement the environmental conditions were within the listed ranges:

Temperature:	18-25 ° C
Humidity:	40-65 %
Atmospheric pressure:	950-1050mbar

#### 3.4. SAR Limits

FCC Limit (1g Tissue)

EXPOSURE LIMITS	SAR (W/kg)	
	(General Population /Uncontrolled Exposure Environment)	(Occupational /Controlled Exposure Environment)
Spatial Average (averaged over the whole body)	0.08	0.4
Spatial Peak (averaged over any 1 g of tissue)	1.60	8.0
Spatial Peak (hands/wrists/feet/ankles averaged over 10 g)	4.0	20.0

Population/Uncontrolled Environments are defined as locations where there is the exposure of individual who have no knowledge or control of their exposure.

Occupational/Controlled Environments are defined as locations where there is exposure that may be incurred by people who are aware of the potential for exposure (i.e. as a result of employment or occupation).

### 3.5. Equipments Used during the Test

Test Equipment	Manufacturer	Type/Model	Serial Number	Calibration	
				Last Calibration	Calibration Interval
Data Acquisition Electronics DAEx	SPEAG	DAE4	1315	2014/07/22	1
E-field Probe	SPEAG	ES3DV3	3292	2014/08/15	1
System Validation Dipole D835V2	SPEAG	D835V2	4d134	2014/07/24	3
System Validation Dipole 1900V2	SPEAG	D1900V2	5d072	2013/12/12	3
System Validation Dipole 2450V2	SPEAG	D2450V2	884	2014/09/01	3
Network analyzer	Agilent	8753E	US37390562	2014/03/18	1
Universal Radio Communication Tester	ROHDE & SCHWARZ	CMU200	112012	2014/10/22	1
Dielectric Probe Kit	Agilent	85070E	US44020288	/	/
Power meter	Agilent	E4417A	GB41292254	2014/10/22	1
Power Meter	Agilent	E7356A	GB54762536	2014/10/25	1
Power sensor	Agilent	8481H	MY41095360	2014/10/22	1
Power Sensor	Agilent	E9327A	Us40441788	2015/03/18	1
Signal generator	IFR	2032	203002/100	2014/10/22	1
Amplifier	AR	75A250	302205	2014/10/22	1
The temporary antenna connector	MMCX - SMA	1547	23657478	2014/10/19	1

Note:

- 1) Per KDB865664D01 requirements for dipole calibration, the test laboratory has adopted three year extended calibration interval. Each measured dipole is expected to evaluate with following criteria at least on annual interval.
  - a) There is no physical damage on the dipole;
  - b) System check with specific dipole is within 10% of calibrated values;
  - c) The most recent return-loss results, measured at least annually, deviates by no more than 20% from the previous measurement;
  - d) The most recent measurement of the real or imaginary parts of the impedance, measured at least annually is within 50  $\Omega$  from the previous measurement.
- 2) Network analyzer probe calibration against air, distilled water and a shorting block performed before measuring liquid parameters.

## 4. SAR Measurements System configuration

### 4.1. SAR Measurement Set-up

The DASY5 system for performing compliance tests consists of the following items:

A standard high precision 6-axis robot (Stäubli RX family) with controller and software. An arm extension for accommodating the data acquisition electronics (DAE).

A dosimetric probe, i.e. an isotropic E-field probe optimized and calibrated for usage in tissue simulating liquid. The probe is equipped with an optical surface detector system.

A data acquisition electronic (DAE) which performs the signal amplification, signal multiplexing, AD-conversion, offset measurements, mechanical surface detection, collision detection, etc. The unit is battery powered with standard or rechargeable batteries. The signal is optically transmitted to the EOC.

A unit to operate the optical surface detector which is connected to the EOC.

The Electro-Optical Coupler (EOC) performs the conversion from the optical into a digital electric signal of the DAE. The EOC is connected to the DASY5 measurement server.

The DASY5 measurement server, which performs all real-time data evaluation for field measurements and surface detection, controls robot movements and handles safety operation. A computer operating Windows 2003.

DASY5 software and SEMCAD data evaluation software.

Remote control with teach panel and additional circuitry for robot safety such as warning lamps, etc.

The generic twin phantom enabling the testing of left-hand and right-hand usage.

The device holder for handheld mobile phones.

Tissue simulating liquid mixed according to the given recipes.

System validation dipoles allowing to validate the proper functioning of the system.

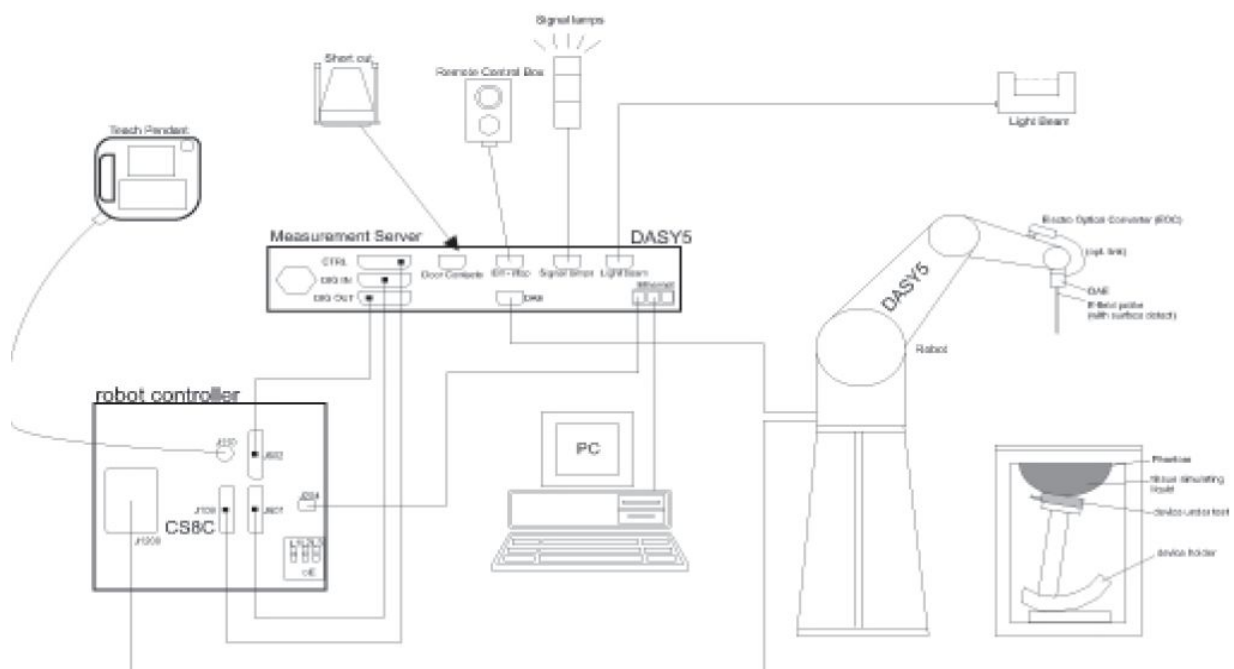

## 4.2. DASY5 E-field Probe System

The SAR measurements were conducted with the dosimetric probe ES3DV3 (manufactured by SPEAG), designed in the classical triangular configuration and optimized for dosimetric evaluation.

### Probe Specification

Construction	Symmetrical design with triangular core Interleaved sensors Built-in shielding against static charges PEEK enclosure material (resistant to organic solvents, e.g., DGBE)
Calibration	ISO/IEC 17025 calibration service available.
Frequency	10 MHz to 4 GHz; Linearity: $\pm 0.2$ dB (30 MHz to 4 GHz)
Directivity	$\pm 0.2$ dB in HSL (rotation around probe axis) $\pm 0.3$ dB in tissue material (rotation normal to probe axis)
Dynamic Range	5 $\mu$ W/g to > 100 mW/g; Linearity: $\pm 0.2$ dB
Dimensions	Overall length: 337 mm (Tip: 20 mm) Tip diameter: 3.9 mm (Body: 12 mm) Distance from probe tip to dipole centers: 2.0 mm
Application	General dosimetry up to 4 GHz Dosimetry in strong gradient fields Compliance tests of mobile phones
Compatibility	DASY3, DASY4, DASY52 SAR and higher, EASY4/MRI



### Isotropic E-Field Probe

The isotropic E-Field probe has been fully calibrated and assessed for isotropicity, and boundary effect within a controlled environment. Depending on the frequency for which the probe is calibrated the method utilized for calibration will change.

The E-Field probe utilizes a triangular sensor arrangement as detailed in the diagram below:

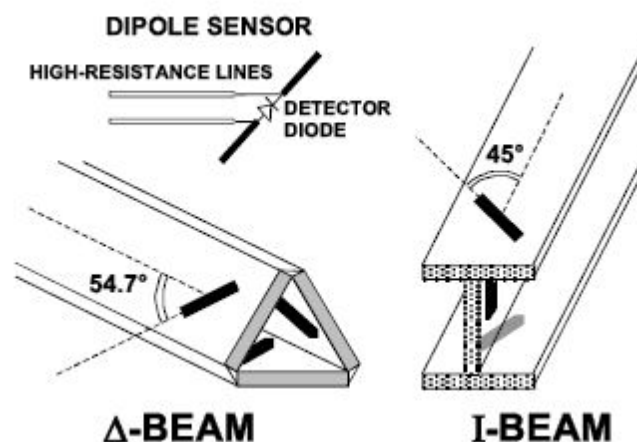

## 4.3. Phantoms

The phantom used for all tests i.e. for both system checks and device testing, was the twin-headed "SAM Phantom", manufactured by SPEAG. The SAM twin phantom is a fiberglass shell phantom with 2mm shell thickness (except the ear region, where shell thickness increases to 6mm).

System checking was performed using the flat section, whilst Head SAR tests used the left and right head profile sections. Body SAR testing also used the flat section between the head profiles.



SAM Twin Phantom

#### 4.4. Device Holder

The device was placed in the device holder (illustrated below) that is supplied by SPEAG as an integral part of the DASY system.

The DASY device holder is designed to cope with the different positions given in the standard. It has two scales for device rotation (with respect to the body axis) and device inclination (with respect to the line between the ear reference points). The rotation centers for both scales is the ear reference point (ERP). Thus the device needs no repositioning when changing the angles.

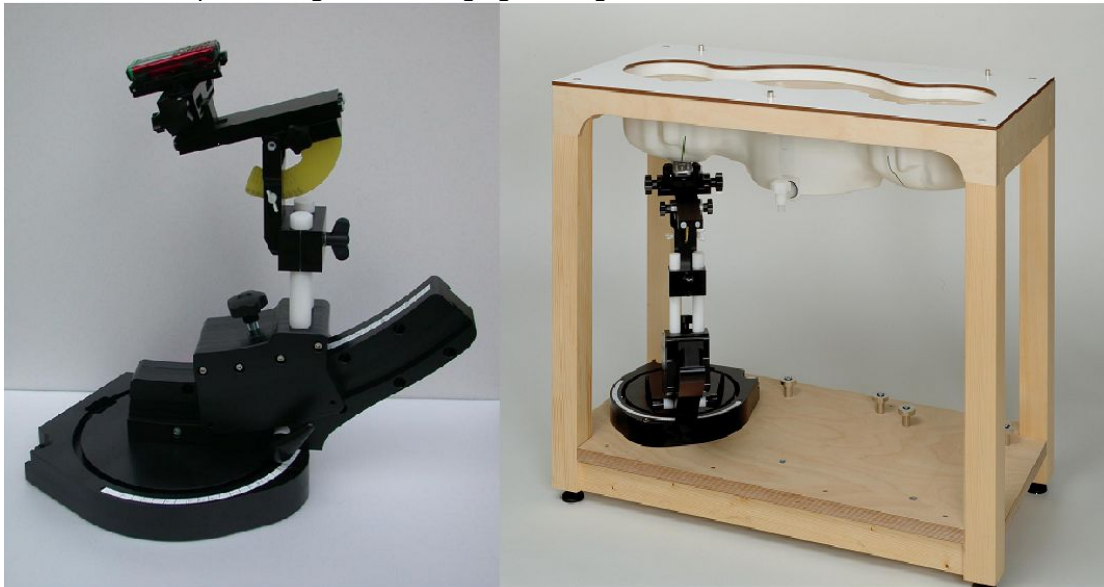

Device holder supplied by SPEAG

#### 4.5. Scanning Procedure

The DASY5 installation includes predefined files with recommended procedures for measurements and validation. They are read-only document files and destined as fully defined but unmeasured masks. All test positions (head or body-worn) are tested with the same configuration of test steps differing only in the grid definition for the different test positions.

The “reference” and “drift” measurements are located at the beginning and end of the batch process. They measure the field drift at one single point in the liquid over the complete procedure. The indicated drift is

mainly the variation of the DUT's output power and should vary max.  $\pm 5\%$ .

The "surface check" measurement tests the optical surface detection system of the DASY5 system by repeatedly detecting the surface with the optical and mechanical surface detector and comparing the results. The output gives the detecting heights of both systems, the difference between the two systems and the standard deviation of the detection repeatability. Air bubbles or refraction in the liquid due to separation of the sugar-water mixture gives poor repeatability (above  $\pm 0.1\text{mm}$ ). To prevent wrong results tests are only executed when the liquid is free of air bubbles. The difference between the optical surface detection and the actual surface depends on the probe and is specified with each probe (It does not depend on the surface reflectivity or the probe angle to the surface within  $\pm 30^\circ$ .)

#### Area Scan

The Area Scan is used as a fast scan in two dimensions to find the area of high field values before running a detailed measurement around the hot spot. Before starting the area scan a grid spacing of 15 mm x 15 mm is set. During the scan the distance of the probe to the phantom remains unchanged. After finishing area scan, the field maxima within a range of 2 dB will be ascertained.

#### Zoom Scan

Zoom Scans are used to estimate the peak spatial SAR values within a cubic averaging volume containing 1 g and 10 g of simulated tissue. The default Zoom Scan is done by 7x7x7 points within a cube whose base is centered around the maxima found in the preceding area scan.

#### Spatial Peak Detection

The procedure for spatial peak SAR evaluation has been implemented and can determine values of masses of 1g and 10g, as well as for user-specific masses. The DASY5 system allows evaluations that combine measured data and robot positions, such as: • maximum search • extrapolation • boundary correction • peak search for averaged SAR. During a maximum search, global and local maxima searches are automatically performed in 2-D after each Area Scan measurement with at least 6 measurement points. It is based on the evaluation of the local SAR gradient calculated by the Quadratic Shepard's method. The algorithm will find the global maximum and all local maxima within -2 dB of the global maxima for all SAR distributions.

Extrapolation routines are used to obtain SAR values between the lowest measurement points and the inner phantom surface. The extrapolation distance is determined by the surface detection distance and the probe sensor offset. Several measurements at different distances are necessary for the extrapolation. Extrapolation routines require at least 10 measurement points in 3-D space. They are used in the Zoom Scan to obtain SAR values between the lowest measurement points and the inner phantom surface. The routine uses the modified Quadratic Shepard's method for extrapolation. For a grid using 7x7x7 measurement points with 5mm resolution amounting to 343 measurement points, the uncertainty of the extrapolation routines is less than 1% for 1g and 10g cubes.

A Z-axis scan measures the total SAR value at the x-and y-position of the maximum SAR value found during the cube 7x7x7 scan. The probe is moved away in z-direction from the bottom of the SAM phantom in 5mm steps.

**Table 1: Area and Zoom Scan Resolutions per FCC KDB Publication 865664 D01**

Frequency	Maximum Area Scan Resolution (mm) ( $\Delta x_{\text{area}}, \Delta y_{\text{area}}$ )	Maximum Zoom Scan Resolution (mm) ( $\Delta x_{\text{zoom}}, \Delta y_{\text{zoom}}$ )	Maximum Zoom Scan Spatial Resolution (mm) $\Delta z_{\text{zoom}}(n)$	Minimum Zoom Scan Volume (mm) (x,y,z)
$\leq 2$ GHz	$\leq 15$	$\leq 8$	$\leq 5$	$\geq 30$
2-3 GHz	$\leq 12$	$\leq 5$	$\leq 5$	$\geq 30$
3-4 GHz	$\leq 12$	$\leq 5$	$\leq 4$	$\geq 28$
4-5 GHz	$\leq 10$	$\leq 4$	$\leq 3$	$\geq 25$
5-6 GHz	$\leq 10$	$\leq 4$	$\leq 2$	$\geq 22$

## 4.6. Data Storage and Evaluation

### Data Storage

The DASY5 software stores the acquired data from the data acquisition electronics as raw data (in microvolt readings from the probe sensors), together with all necessary software parameters for the data evaluation (probe calibration data, liquid parameters and device frequency and modulation data) in measurement files with the extension ".DA4". The software evaluates the desired unit and format for output each time the data is visualized or exported. This allows verification of the complete software setup even after the measurement and allows correction of incorrect parameter settings. For example, if a measurement has been performed with a wrong crest factor parameter in the device setup, the parameter can be corrected afterwards and the data can be re-evaluated.

The measured data can be visualized or exported in different units or formats, depending on the selected probe type ([V/m], [A/m], [°C], [mW/g], [mW/cm<sup>2</sup>], [dBrel], etc.). Some of these units are not available in certain situations or show meaningless results, e.g., a SAR output in a lossless media will always be zero. Raw data can also be exported to perform the evaluation with other software packages.

#### Data Evaluation

The SEMCAD software automatically executes the following procedures to calculate the field units from the microvolt readings at the probe connector. The parameters used in the evaluation are stored in the configuration modules of the software:

Probe parameters:	- Sensitivity	Normi, ai0, ai1, ai2
	- Conversion factor	ConvFi
	- Diode compression point	Dcpi
Device parameters:	- Frequency	f
	- Crest factor	cf
Media parameters:	- Conductivity	σ
	- Density	ρ

These parameters must be set correctly in the software. They can be found in the component documents or they can be imported into the software from the configuration files issued for the DASY5 components. In the direct measuring mode of the multimeter option, the parameters of the actual system setup are used. In the scan visualization and export modes, the parameters stored in the corresponding document files are used.

The first step of the evaluation is a linearization of the filtered input signal to account for the compression characteristics of the detector diode. The compensation depends on the input signal, the diode type and the DC-transmission factor from the diode to the evaluation electronics. If the exciting field is pulsed, the crest factor of the signal must be known to correctly compensate for peak power. The formula for each channel can be given as:

$$V_i = U_i + U_i^2 \cdot \frac{cf}{dcp_i}$$

With	$V_i$	= compensated signal of channel i	(i = x, y, z)
	$U_i$	= input signal of channel i	(i = x, y, z)
	cf	= crest factor of exciting field	(DASY parameter)
	dcp <sub>i</sub>	= diode compression point	(DASY parameter)

From the compensated input signals the primary field data for each channel can be evaluated:

$$\text{E - fieldprobes : } E_i = \sqrt{\frac{V_i}{\text{Norm}_i \cdot \text{ConvF}}}$$

$$\text{H - fieldprobes : } H_i = \sqrt{V_i} \cdot \frac{a_{i0} + a_{i1}f + a_{i2}f^2}{f}$$

With	$V_i$	= compensated signal of channel i	(i = x, y, z)
	$\text{Norm}_i$	= sensor sensitivity of channel i	(i = x, y, z)
		[mV/(V/m) <sup>2</sup> ] for E-field Probes	
	ConvF	= sensitivity enhancement in solution	
	$a_{ij}$	= sensor sensitivity factors for H-field probes	
	f	= carrier frequency [GHz]	
	$E_i$	= electric field strength of channel i in V/m	
	$H_i$	= magnetic field strength of channel i in A/m	

The RSS value of the field components gives the total field strength (Hermitian magnitude):

$$E_{tot} = \sqrt{E_x^2 + E_y^2 + E_z^2}$$

The primary field data are used to calculate the derived field units.

$$SAR = E_{tot}^2 \cdot \frac{\sigma}{\rho \cdot 1'000}$$

with	SAR	= local specific absorption rate in mW/g
	$E_{tot}$	= total field strength in V/m
	σ	= conductivity in [mho/m] or [Siemens/m]
	ρ	= equivalent tissue density in g/cm <sup>3</sup>

Note that the density is normally set to 1 (or 1.06), to account for actual brain density rather than the density of the simulation liquid.

#### 4.7. Tissue Dielectric Parameters for Head and Body Phantoms

The liquid is consisted of water,salt,Glycol,Sugar,Preventol and Cellulose.The liquid has previously been proven to be suited for worst-case.It's satisfying the latest tissue dielectric parameters requirements proposed by the KDB865664.

The composition of the tissue simulating liquid

Ingredient (% Weight)	835MHz		1900MHz		1750 MHz		2450MHz		2600MHz	
	Head	Body	Head	Body	Head	Body	Head	Body	Head	Body
Water	41.45	52.5	55.242	69.91	55.782	69.82	62.7	73.2	62.3	72.6
Salt	1.45	1.40	0.306	0.13	0.401	0.12	0.50	0.10	0.20	0.10
Sugar	56	45.0	0.00	0.00	0.00	0.00	0.00	0.00	0.00	0.00
Preventol	0.10	0.10	0.00	0.00	0.00	0.00	0.00	0.00	0.00	0.00
HEC	1.00	1.00	0.00	0.00	0.00	0.00	0.00	0.00	0.00	0.00
DGBE	0.00	0.00	44.452	29.96	43.817	30.06	36.8	26.7	37.5	27.3

Target Frequency (MHz)	Head		Body	
	$\epsilon_r$	$\sigma(S/m)$	$\epsilon_r$	$\sigma(S/m)$
150	52.3	0.76	61.9	0.80
300	45.3	0.87	58.2	0.92
450	43.5	0.87	56.7	0.94
835	41.5	0.90	55.2	0.97
900	41.5	0.97	55.0	1.05
915	41.5	0.98	55.0	1.06
1450	40.5	1.20	54.0	1.30
1610	40.3	1.29	53.8	1.40
1800-2000	40.0	1.40	53.3	1.52
2450	39.2	1.80	52.7	1.95
3000	38.5	2.40	52.0	2.73
5800	35.3	5.27	48.2	6.00

#### 4.8. Tissue equivalent liquid properties

Dielectric performance of Head and Body tissue simulating liquid

Tissue Type	Measured Frequency (MHz)	Target Tissue		Measured Tissue				Liquid Temp.	Test Data
		$\epsilon_r$	$\sigma$	$\epsilon_r$	Dev. %	$\sigma$	Dev. %		
850H	824	41.56	0.90	41.78	0.53%	0.92	2.22%	22 degree	2015-06-02
	836	41.50	0.90	41.61	0.27%	0.91	1.11%		
	848	41.50	0.92	41.39	-0.27%	0.95	3.26%		
1900H	1850	40.00	1.40	39.95	-0.12%	1.41	0.71%	22 degree	2015-06-04
	1880	40.00	1.40	39.97	-0.08%	1.45	3.57%		
	1909	40.00	1.40	39.73	-0.68%	1.46	4.28%		
2450H	2412	39.27	1.77	39.46	0.48%	1.79	1.13%	22 degree	2015-06-06
	2437	39.22	1.79	39.28	0.15%	1.84	2.79%		
	2462	39.18	1.81	39.21	0.08%	1.86	2.76%		
850B	824	55.24	0.97	53.77	-2.66%	0.98	1.03%	22 degree	2015-06-03
	836	55.20	0.97	53.51	-3.06%	0.99	2.06%		
	848	55.16	0.99	53.46	-3.08%	1.02	3.03%		
1900B	1850	53.30	1.52	53.30	0.00%	1.48	-2.63%	22 degree	2015-06-05
	1880	53.30	1.52	53.10	-0.38%	1.50	-1.32%		
	1909	53.30	1.52	53.00	-0.56%	1.53	0.66%		
2450B	2412	52.75	1.91	52.80	0.09%	2.00	4.71%	22 degree	2015-06-07
	2437	52.72	1.94	52.65	-0.13%	2.03	4.64%		
	2462	52.68	1.97	52.70	0.04%	2.06	4.57%		

#### 4.9. System Check

The purpose of the system check is to verify that the system operates within its specifications at the decide test frequency.The system check is simple check of repeatability to make sure that the system works correctly at the time of the compliance test;

System check results have to be equal or near the values determined during dipole calibration with the



relevant liquids and test system ( $\pm 10\%$ ).

System check is performed regularly on all frequency bands where tests are performed with the DASY5 system.

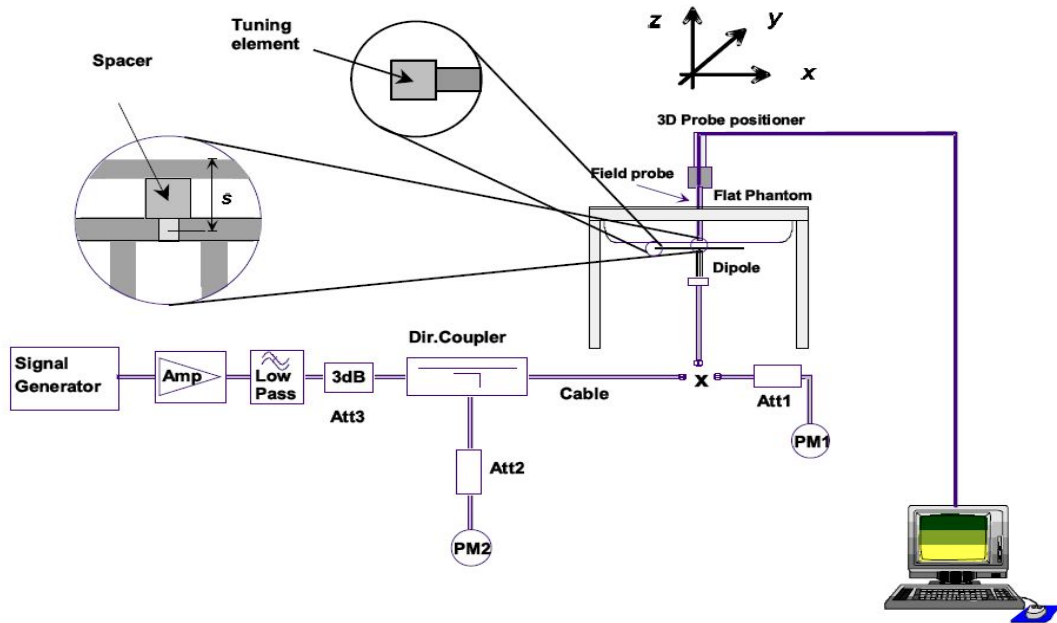

The output power on dipole port must be calibrated to 30 dBm (1000mW) before dipole is connected.

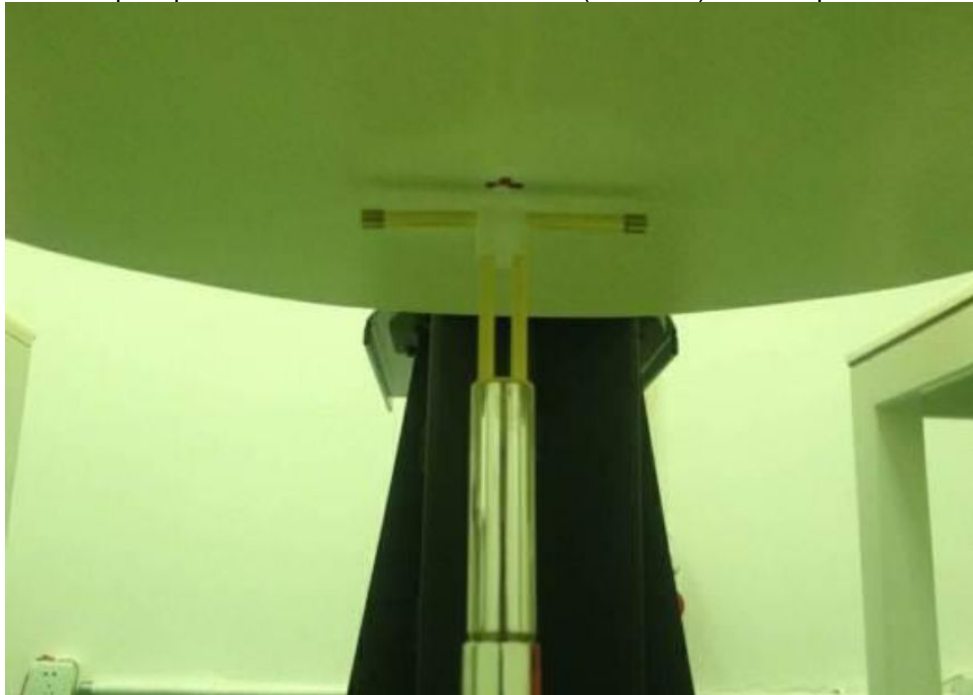

Photo of Dipole Setup

System Validation of Head

Measurement is made at temperature 22.0 °C and relative humidity 55%.							
Liquid temperature during the test: 22.0°C							
Measurement Date: 835MHz Jun 02 <sup>th</sup> , 2015;1900MHz Jun 04 <sup>th</sup> ;2015, 2450MHz Jun 06 <sup>th</sup> ;2015							
Verification results	Frequency (MHz)	Target value (W/kg)		Measured value (W/kg)		Deviation	
		10 g Average	1 g Average	10 g Average	1 g Average	10 g Average	1 g Average
	835	6.27	9.62	6.25	9.60	-0.32%	-0.21%
	1900	20.20	38.30	20.60	38.90	1.98%	1.57%
2450	24.60	52.10	25.10	54.00	2.03%	3.65%	

## System Validation of Body

Measurement is made at temperature 22.0 °C and relative humidity 55%.							
Liquid temperature during the test: 22.0°C							
Measurement Date: 835MHz Jun 03 <sup>th</sup> , 2015;1900MHz Jun 05 <sup>th</sup> ;2015, 2450MHz Jun 07 <sup>th</sup> ;2015							
Verification results	Frequency (MHz)	Target value (W/kg)		Measured value (W/kg)		Deviation	
		10 g Average	1 g Average	10 g Average	1 g Average	10 g Average	1 g Average
	835	6.50	9.77	6.44	9.63	-0.92%	-1.43%
	1900	21.00	39.90	20.80	39.10	-0.95%	-2.01%
2450	24.20	51.60	24.30	53.00	0.41%	2.71%	

## 4.10. SAR measurement procedure

### 4.10.1 SAR Measurement Procedure

- Use base station simulator to configure EUT WWAN transmission in radiated connection, and engineering software to configure EUT WLAN/BT continuously transmission, at maximum RF power, in the highest power channel.
- Place the EUT in the positions as Appendix D demonstrates.
- Set scan area, grid size and other setting on the DASY software.
- Measure SAR results for the highest power channel on each testing position.
- Find out the largest SAR result on these testing positions of each band
- Measure SAR results for other channels in worst SAR testing position if the reported SAR of highest power channel is larger than 0.8 W/kg

According to the test standard, the recommended procedure for assessing the peak spatial-average SAR value consists of the following steps:

- Power reference measurement
- Area scan
- Zoom scan
- Power drift measurement

### 4.10.2 General Measurement Procedure

The area and zoom scan resolutions specified in the table below must be applied to the SAR measurements and fully documented in SAR reports to qualify for TCB approval. Probe boundary effect error compensation is required for measurements with the probe tip closer than half a probe tip diameter to the phantom surface. Both the probe tip diameter and sensor offset distance must satisfy measurement protocols; to ensure probe boundary effect errors are minimized and the higher fields closest to the phantom surface can be correctly measured and extrapolated to the phantom surface for computing 1-g SAR. Tolerances of the post-processing algorithms must be verified by the test laboratory for the scan resolutions used in the SAR measurements, according to the reference distribution functions specified in IEEE Std 1528-2003. The results should be documented as part of the system validation records and may be requested to support test results when all the measurement parameters in the following table are not satisfied.

		$\leq 3$ GHz	$> 3$ GHz
Maximum distance from closest measurement point (geometric center of probe sensors) to phantom surface		$5 \pm 1$ mm	$\frac{1}{2}\delta \ln(2) \pm 0.5$ mm
Maximum probe angle from probe axis to phantom surface normal at the measurement location		$30^\circ \pm 1^\circ$	$20^\circ \pm 1^\circ$
Maximum area scan spatial resolution: $\Delta x_{Area}$ , $\Delta y_{Area}$		$\leq 2$ GHz: $\leq 15$ mm 2 – 3 GHz: $\leq 12$ mm	3 – 4 GHz: $\leq 12$ mm 4 – 6 GHz: $\leq 10$ mm
		When the x or y dimension of the test device, in the measurement plane orientation, is smaller than the above, the measurement resolution must be $\leq$ the corresponding x or y dimension of the test device with at least one measurement point on the test device.	
Maximum zoom scan spatial resolution: $\Delta x_{Zoom}$ , $\Delta y_{Zoom}$		$\leq 2$ GHz: $\leq 8$ mm 2 – 3 GHz: $\leq 5$ mm*	3 – 4 GHz: $\leq 5$ mm* 4 – 6 GHz: $\leq 4$ mm*
Maximum zoom scan spatial resolution, normal to phantom surface	uniform grid: $\Delta z_{Zoom}(n)$	$\leq 5$ mm	3 – 4 GHz: $\leq 4$ mm 4 – 5 GHz: $\leq 3$ mm 5 – 6 GHz: $\leq 2$ mm
	graded grid $\Delta z_{Zoom}(1)$ : between 1 <sup>st</sup> two points closest to phantom surface	$\leq 4$ mm	3 – 4 GHz: $\leq 3$ mm 4 – 5 GHz: $\leq 2.5$ mm 5 – 6 GHz: $\leq 2$ mm
	$\Delta z_{Zoom}(n>1)$ : between subsequent points	$\leq 1.5 \cdot \Delta z_{Zoom}(n-1)$	
Minimum zoom scan volume	x, y, z	$\geq 30$ mm	3 – 4 GHz: $\geq 28$ mm 4 – 5 GHz: $\geq 25$ mm 5 – 6 GHz: $\geq 22$ mm
Note: $\delta$ is the penetration depth of a plane-wave at normal incidence to the tissue medium; see draft standard IEEE P1528-2011 for details.			
* When zoom scan is required and the <i>reported</i> SAR from the area scan based <i>1-g SAR estimation</i> procedures of KDB 447498 is $\leq 1.4$ W/kg, $\leq 8$ mm, $\leq 7$ mm and $\leq 5$ mm zoom scan resolution may be applied, respectively, for 2 GHz to 3 GHz, 3 GHz to 4 GHz and 4 GHz to 6 GHz.			

#### 4.10.3 Conducted power measurement

- For WWAN power measurement, use base station simulator connection with RF cable, at maximum power in each supported wireless interface and frequency band.
- Read the WWAN RF power level from the base station simulator.
- For WLAN/BT power measurement, use engineering software to configure EUT WLAN/BT continuously Transmission, at maximum RF power in each supported wireless interface and frequency band.
- Connect EUT RF port through RF cable to the power meter, and measure WLAN/BT output power.

#### 4.10.4 SAR measurement

##### 4.10.4.1 GSM Test Configuration

SAR tests for GSM 850 and GSM 1900, a communication link is set up with a System Simulator (SS) by air link. Using CMU200 the power level is set to "5" for GSM 850, set to "0" for GSM 1900. Since the GPRS class is 12 for this EUT, it has at most 4 timeslots in uplink and at most 4 timeslots in downlink, the maximum total timeslots is 5. the EGPRS class is 12 for this EUT, it has at most 4 timeslots in uplink and at most 4 timeslots in downlink, the maximum total timeslots is 5.

SAR test reduction for GPRS and EDGE modes is determined by the source-based time-averaged output power specified for production units, including tune-up tolerance. The data mode with highest specified time-averaged output power should be tested for SAR compliance in the applicable exposure conditions. For modes with the same specified maximum output power and tolerance, the higher number time-slot configuration should be tested. GSM voice and GPRS data use GMSK, which is a constant amplitude modulation with minimal peak to average power difference within the time-slot burst. For EDGE, GMSK is used for MCS 1 – MCS 4 and 8-PSK is used for MCS 5 – MCS 9; where 8-PSK has an inherently higher peak-to-average power ratio. The GMSK and 8-PSK EDGE configurations are considered separately for SAR

compliance. The GMSK EDGE configurations are grouped with GPRS and considered with respect to time-averaged maximum output power to determine compliance. The 3G SAR test reduction procedure is applied to 8-PSK EDGE with GMSK GPRS/EDGE as the primary mode.

#### 4.10.4.2 UMTS Test Configuration

##### 3G SAR Test Reduction Procedure

In the following procedures, the mode tested for SAR is referred to as the primary mode. The equivalent modes considered for SAR test reduction are denoted as secondary modes. Both primary and secondary modes must be in the same frequency band. When the maximum output power and tune-up tolerance specified for production units in a secondary mode is  $\leq \frac{1}{4}$  dB higher than the primary mode or when the highest reported SAR of the primary mode is scaled by the ratio of specified maximum output power and tune-up tolerance of secondary to primary mode and the adjusted SAR is  $\leq 1.2$  W/kg, SAR measurement is not required for the secondary mode.<sup>3</sup> This is referred to as the 3G SAR test reduction procedure in the following SAR test guidance, where the primary mode is identified in the applicable wireless mode test procedures and the secondary mode is wireless mode being considered for SAR test reduction by that procedure. When the 3G SAR test reduction procedure is not satisfied, it is identified as “otherwise” in the applicable procedures; SAR measurement is required for the secondary mode.

##### Output power Verification

Maximum output power is verified on the high, middle and low channels according to procedures described in section 5.2 of 3GPP TS 34.121, using the appropriate RMC or AMR with TPC (transmit power control) set to all “1’s” for WCDMA/HSDPA or by applying the required inner loop power control procedures to maintain maximum output power while HSUPA is active. Results for all applicable physical channel configurations (DPCCH, DPDCHn and spreading codes, HSDPA, HSPA) are required in the SAR report. All configurations that are not supported by the handset or cannot be measured due to technical or equipment limitations must be clearly identified.

##### Head SAR

SAR for next to the ear head exposure is measured using a 12.2 kbps RMC with TPC bits configured to all “1’s”. The 3G SAR test reduction procedure is applied to AMR configurations with 12.2 kbps RMC as the primary mode. Otherwise, SAR is measured for 12.2 kbps AMR in 3.4 kbps SRB (signaling radio bearer) using the highest reported SAR configuration in 12.2 kbps RMC for head exposure.

##### Body-Worn Accessory SAR

SAR for body-worn accessory configurations is measured using a 12.2 kbps RMC with TPC bits configured to all “1’s”. The 3G SAR test reduction procedure is applied to other spreading codes and multiple DPDCHn configurations supported by the handset with 12.2 kbps RMC as the primary mode. Otherwise, SAR is measured using an applicable RMC configuration with the corresponding spreading code or DPDCHn, for the highest reported body-worn accessory exposure SAR configuration in 12.2 kbps RMC. When more than 2 DPDCHn are supported by the handset, it may be necessary to configure additional DPDCHn using FTM (Factory Test Mode) or other chipset based test approaches with parameters similar to those used in 384 kbps and 768 kbps RMC.

##### Handsets with Release 5 HSDPA

The 3G SAR test reduction procedure is applied to HSDPA body-worn accessory configurations with 12.2 kbps RMC as the primary mode. Otherwise, SAR is measured for HSDPA using the HSDPA body SAR procedures in the “Release 5 HSDPA Data Devices” section of this document, for the highest reported SAR body-worn accessory exposure configuration in 12.2 kbps RMC. Handsets with both HSDPA and HSUPA are tested according to Release 6 HSPA test procedures.

HSDPA should be configured according to the UE category of a test device. The number of HSDSCH/HS-PDSCHs, HARQ processes, minimum inter-TTI interval, transport block sizes and RV coding sequence are defined by the H-set. To maintain a consistent test configuration and stable transmission conditions, QPSK is used in the H-set for SAR testing. HS-DPCCH should be configured with a CQI feedback cycle of 4 ms with a CQI repetition factor of 2 to maintain a constant rate of active CQI slots. DPCCH and DPDCH gain factors ( $\beta_c$ ,  $\beta_d$ ), and HS-DPCCH power offset parameters ( $\Delta_{ACK}$ ,  $\Delta_{NACK}$ ,  $\Delta_{CQI}$ ) should be set according to values indicated in the Table below. The CQI value is determined by the UE category, transport block size, number of HS-PDSCHs and modulation used in the H-set.

**Table 2: Subtests for UMTS Release 5 HSDPA**

Sub-set	$\beta_c$	$\beta_d$	$\beta_d$ (SF)	$\beta_c/\beta_d$	$\beta_{hs}$ (note 1, note 2)	CM(dB) (note 3)	MPR(dB)
1	2/15	15/15	64	2/15	4/15	0.0	0.0
2	12/15 (note 4)	15/15 (note 4)	64	12/15 (note 4)	24/15	1.0	0.0
3	15/15	8/15	64	15/8	30/15	1.5	0.5
4	15/15	4/15	64	15/4	30/15	1.5	0.5

Note1:  $\Delta_{ACK}$ ,  $\Delta_{NACK}$  and  $\Delta_{CQI} = 8 \Leftrightarrow A_{hs} = \beta_{hs}/\beta_c = 30/15 \Leftrightarrow \beta_{hs} = 30/15 * \beta_c$   
Note2: CM=1 for  $\beta_c/\beta_d = 12/15$ ,  $\beta_{hs}/\beta_c = 24/15$ .  
Note3: For subtest 2 the  $\beta_c/\beta_d$  ratio of 12/15 for the TFC during the measurement period(TF1,TF0) is achieved by setting the signaled gain factors for the reference TFC (TFC1,TF1) to  $\beta_c=11/15$  and  $\beta_d=15/15$ .

### HSUPA Test Configuration

The 3G SAR test reduction procedure is applied to HSPA (HSUPA/HSDPA with RMC) body-worn accessory configurations with 12.2 kbps RMC as the primary mode. Otherwise, SAR is measured for HSPA using the HSPA body SAR procedures in the "Release 6 HSPA Data Devices" section of this document, for the highest reported body-worn accessory exposure SAR configuration in 12.2 kbps RMC. When VOIP is applicable for next to the ear head exposure in HSPA, the 3G SAR test reduction procedure is applied to HSPA with 12.2 kbps RMC as the primary mode; otherwise, the same HSPA configuration used for body-worn accessory measurements is tested for next to the ear head exposure.

Due to inner loop power control requirements in HSPA, a communication test set is required for output power and SAR tests. The 12.2 kbps RMC, FRC H-set 1 and E-DCH configurations for HSPA are configured according to the  $\beta$  values indicated in Table 2 and other applicable procedures described in the 'WCDMA Handset' and 'Release 5 HSDPA Data Devices' sections of this document

**Table 3: Sub-Test 5 Setup for Release 6 HSUPA**

Sub-set	$\beta_c$	$\beta_d$	$\beta_d$ (SF)	$\beta_c/\beta_d$	$\beta_{hs}^{(1)}$	$\beta_{ec}$	$\beta_{ed}$	$\beta_{ed}$ (SF)	$\beta_{ed}$ (codes)	CM <sup>(2)</sup> (dB)	MPR (dB)	AG <sup>(4)</sup> Index	E- TFCI
1	11/15 <sup>(3)</sup>	15/15 <sup>(3)</sup>	64	11/15 <sup>(3)</sup>	22/15	209/225	1039/225	4	1	1.0	0.0	20	75
2	6/15	15/15	64	6/15	12/15	12/15	94/75	4	1	3.0	2.0	12	67
3	15/15	9/15	64	15/9	30/15	30/15	$\beta_{ed1}:47/15$ $\beta_{ed2}:47/15$	4	2	2.0	1.0	15	92
4	2/15	15/15	64	2/15	4/15	2/15	56/75	4	1	3.0	2.0	17	71
5	15/15 <sup>(4)</sup>	15/15 <sup>(4)</sup>	64	15/15 <sup>(4)</sup>	30/15	24/15	134/15	4	1	1.0	0.0	21	81

Note 1:  $\Delta_{ACK}$ ,  $\Delta_{NACK}$  and  $\Delta_{CQI} = 8 \Leftrightarrow A_{hs} = \beta_{hs}/\beta_c = 30/15 \Leftrightarrow \beta_{hs} = 30/15 * \beta_c$ .  
Note 2: CM = 1 for  $\beta_c/\beta_d = 12/15$ ,  $\beta_{hs}/\beta_c = 24/15$ . For all other combinations of DPDCH, DPCCH, HS- DPCCH, E-DPDCH and E-DPCCH the MPR is based on the relative CM difference.  
Note 3: For subtest 1 the  $\beta_c/\beta_d$  ratio of 11/15 for the TFC during the measurement period (TF1, TF0) is achieved by setting the signaled gain factors for the reference TFC (TF1, TF1) to  $\beta_c = 10/15$  and  $\beta_d = 15/15$ .  
Note 4: For subtest 5 the  $\beta_c/\beta_d$  ratio of 15/15 for the TFC during the measurement period (TF1, TF0) is achieved by setting the signaled gain factors for the reference TFC (TF1, TF1) to  $\beta_c = 14/15$  and  $\beta_d = 15/15$ .  
Note 5: Testing UE using E-DPDCH Physical Layer category 1 Sub-test 3 is not required according to TS 25.306 Figure 5.1g.  
Note 6:  $\beta_{ed}$  can not be set directly; it is set by Absolute Grant Value.

Table 4: HSUPA UE category

UE E-DCH Category	Maximum E-DCH Codes Transmitted	Number of HARQ Processes	E-DCH TTI (ms)	Minimum Spreading Factor	Maximum E-DCH Transport Block Bits	Max Rate (Mbps)
1	1	4	10	4	7110	0.7296
2	2	8	2	4	2798	1.4592
	2	4	10	4	14484	
3	2	4	10	4	14484	1.4592
4	2	8	2	2	5772	2.9185
	2	4	10	2	20000	2.00
5	2	4	10	2	20000	2.00
6 (No DPDCH)	4	8	2	2 SF2 & 2 SF4	11484	5.76
	4	4	10		20000	2.00
7 (No DPDCH)	4	8	2	2 SF2 & 2 SF4	22996	?
	4	4	10		20000	?

NOTE: When 4 codes are transmitted in parallel, two codes shall be transmitted with SF2 and two with SF4. UE Categories 1 to 6 supports QPSK only. UE Category 7 supports QPSK and 16QAM. (TS25.306-7.3.0)

#### HSPA, HSPA+ and DC-HSDPA Test Configuration

measurement is required for HSPA, HSPA+ or DC-HSDPA, a KDB inquiry is required to confirm that the wireless mode configurations in the test setup have remained stable throughout the SAR measurements.<sup>35</sup> Without prior KDB confirmation to determine the SAR results are acceptable, a PBA is required for TCB approval.

SAR test exclusion for HSPA, HSPA+ and DC-HSDPA is determined according to the following:

1) The HSPA procedures are applied to configure 3GPP Rel. 6 HSPA devices in the required sub-test mode(s) to determine SAR test exclusion.

2) SAR is required for Rel. 7 HSPA+ when SAR is required for Rel. 6 HSPA; otherwise, the 3G SAR test reduction procedure is applied to (uplink) HSPA+ with 12.2 kbps RMC as the primary mode.<sup>36</sup> Power is measured for HSPA+ that supports uplink 16 QAM according to configurations in Table C.11.1.4 of 3GPP TS 34.121-1 to determine SAR test reduction.

3) SAR is required for Rel. 8 DC-HSDPA when SAR is required for Rel. 5 HSDPA; otherwise, the 3G SAR test reduction procedure is applied to DC-HSDPA with 12.2 kbps RMC as the primary mode. Power is measured for DC-HSDPA according to the H-Set 12, FRC configuration in Table C.8.1.12 of 3GPP TS 34.121-1 to determine SAR test reduction. A primary and a secondary serving HS-DSCH Cell are required to perform the power measurement and for the results to be acceptable.

4) Regardless of whether a PBA is required, the following information must be verified and included in the SAR report for devices supporting HSPA, HSPA+ or DC-HSDPA: a) The output power measurement results and applicable release version(s) of 3GPP TS 34.121.

i) Power measurement difficulties due to test equipment setup or availability must be resolved between the grantee and its test lab.

b) The power measurement results are in agreement with the individual device implementation and specifications. When Enhanced MPR (E-MPR) applies, the normal MPR targets may be modified according to the Cubic Metric (CM) measured by the device, which must be taken into consideration.

c) The UE category, operating parameters, such as the  $\beta$  and  $\Delta$  values used to configure the device for testing, power setback procedures described in 3GPP TS 34.121 for the power measurements, and HSPA/HSPA+ channel conditions (active and stable) for the entire duration of the measurement according to the required E-TFCI and AG index values.

5) When SAR measurement is required, the test configurations, procedures and power measurement results must be clearly described to confirm that the required test parameters are used, including E-TFCI and AG index stability and output power conditions.



Table 5: HS-DSCH UE category

Table 5.1a: FDD HS-DSCH physical layer categories

HS-DSCH category	Maximum number of HS-DSCH codes received	Minimum inter-TTI interval	Maximum number of bits of an HS-DSCH transport block received within an HS-DSCH TTI NOTE 1	Total number of soft channel bits	Supported modulations without MIMO operation or dual cell operation	Supported modulations with MIMO operation and without dual cell operation	Supported modulations with dual cell operation	
Category 1	5	3	7298	19200	QPSK, 16QAM	Not applicable (MIMO not supported)	Not applicable (dual cell operation not supported)	
Category 2	5	3	7298	28800				
Category 3	5	2	7298	28800				
Category 4	5	2	7298	38400				
Category 5	5	1	7298	57600				
Category 6	5	1	7298	67200				
Category 7	10	1	14411	115200				
Category 8	10	1	14411	134400				
Category 9	15	1	20251	172800				
Category 10	15	1	27952	172800				
Category 11	5	2	3630	14400				QPSK
Category 12	5	1	3630	28800				QPSK, 16QAM, 64QAM
Category 13	15	1	35280	259200				
Category 14	15	1	42192	259200				QPSK, 16QAM
Category 15	15	1	23370	345600				
Category 16	15	1	27952	345600	QPSK, 16QAM, 64QAM	-		
Category 17 NOTE 2	15	1	35280	259200			-	QPSK, 16QAM
			23370	345600	-	QPSK, 16QAM		
Category 18 NOTE 3	15	1	42192	259200	QPSK, 16QAM, 64QAM	-		
			27952	345600	-	QPSK, 16QAM		
Category 19	15	1	35280	518400	QPSK, 16QAM, 64QAM			
Category 20	15	1	42192	518400				
Category 21	15	1	23370	345600	-	-	QPSK, 16QAM	
Category 22	15	1	27952	345600				
Category 23	15	1	35280	518400				
Category 24	15	1	42192	518400			QPSK, 16QAM, 64QAM	

#### 4.10.5 WIFI Test Configuration

For WiFi SAR testing, WiFi engineering testing software installed on the DUT can provide continuous transmitting RF signal. The Tx power is set to 11.5 for 802.11 b mode by software. This RF signal utilized in SAR measurement has almost 100% duty cycle and its crest factor is 1.

The SAR measurement and test reduction procedures are structured according to either the DSSS or OFDM transmission mode configurations used in each standalone frequency band and aggregated band. For devices that operate in exposure configurations that require multiple test positions, additional SAR test reduction may be applied. The maximum output power specified for production units, including tune-up tolerance, are used to determine initial SAR test requirements for the 802.11 transmission modes in a frequency band. SAR is measured using the highest measured maximum output power channel for the initial test configuration (section 5.1). SAR measurement and test reduction for the remaining 802.11 modes and test channels are determined according to measured or specified maximum output power and reported SAR of the initial measurements. The general test reduction and SAR measurement approaches are summarized in the following:

1. The maximum output power specified for production units are determined for all applicable 802.11 transmission modes in each standalone and aggregated frequency band. Maximum output power is measured for the highest maximum output power configuration(s) in each frequency band according to the default power measurement procedures (section 4). Channels with measured maximum output power within ¼ dB are considered to have the same maximum output.

2. For OFDM transmission configurations in the 2.4 GHz and 5 GHz bands, an “initial test configuration” (section 5.3.2) is first determined for each standalone and aggregated frequency band according to the maximum output power and tune-up tolerance specified for production units.
  - a. When the same maximum power is specified for multiple transmission modes in a frequency band, the largest channel bandwidth, lowest order modulation, lowest data rate and lowest order 802.11a/g/n/ac mode is used for SAR measurement, on the highest measured output power channel in the initial test configuration, for each frequency band (section 5.3.2)
  - b. SAR is measured for OFDM configurations using the initial test configuration procedures (section 5.3.3). Additional frequency band specific SAR test reduction may be considered for individual frequency bands (sections 5.2 and 5.3).
  - c. Depending on the reported SAR of the highest maximum output power channel tested in the initial test configuration, SAR test reduction may apply to subsequent highest output channels in the initial test configuration to reduce the number of SAR measurements.
3. The Initial test configuration does not apply to DSSS. The 2.4 GHz band SAR test requirements (section 3.1) and 802.11b DSSS procedures (section 5.2.1) are used to establish the transmission configurations required for SAR measurement.
4. An “initial test position” (section 5.1) is applied to further reduce the number of SAR tests for devices operating in next to the ear, UMPC mini-tablet or hotspot mode exposure configurations that require multiple test positions .
  - a. SAR is measured for 802.11b according to the 2.4 GHz DSSS procedure (section 5.2.1) using the exposure condition established by the initial test position.
  - b. SAR is measured for 2.4 GHz and 5 GHz OFDM configurations using the initial test configuration. 802.11b/g/n operating modes are tested independently according to the service requirements in each frequency band. 802.11b/g/n modes are tested on the maximum average output channel.
5. The Initial test position does not apply to devices that require a fixed exposure test position. SAR is measured in a fixed exposure test position for these devices in 802.11b according to the 2.4 GHz DSSS procedure (section 5.2.1) or in 2.4 GHz and 5 GHz OFDM configurations using the initial test configuration procedures (section 5.3.3).
6. The “subsequent test configuration” (section 5.3.4) procedures are applied to determine if additional SAR measurements are required for the remaining OFDM transmission modes that have not been tested in the initial test configuration. SAR test exclusion is determined according to reported SAR in the initial test configuration and maximum output power specified or measured for these other OFDM configurations.

#### 2.4 GHz Band (§15.247)

The maximum output power permitted for devices authorized under §15.247 is 1 W conducted and 36 dBm EIRP.<sup>6</sup> Within the frequency range of 2400 – 2483.5 MHz, currently a total of 13 channels may be used in the U.S. However, non-overlapping frequency channels are necessary to minimize interference degradation; therefore, channels 1, 6 and 11 are used most often. Channels 12 and 13, in general, require reduced output power to satisfy bandedge radiated field strength requirements at 2483.5 MHz. Provided higher maximum output power is not specified for the other channels, channels 1, 6 and 11 are used to configure 22 MHz DSSS and 20 MHz OFDM channels for SAR measurements; otherwise, the closest adjacent channel with the highest maximum output power specified for production units should be tested instead of channels 1, 6 or 11.<sup>7</sup> When 40 MHz channels are supported, and provided higher maximum output power is not specified for other applicable 40 MHz channels, channel 6 is used to measure SAR; otherwise, the channel with highest specified maximum output power should be tested instead. In addition, SAR test reduction with respect to reported SAR and transmission band width according to section 4.3.3 of KDB Publication 447498 may also be applied.

#### U-NII-1 and U-NII-2A Bands (§15.407)

The maximum output power permitted for devices authorized under §15.407 U-NII-1 band (5.15 – 5.25 GHz), is 250 - 1000 mW conducted and 21 – 36 dBm EIRP, depending on transmitter configurations and antenna operating requirements.<sup>8</sup> For U-NII-2A band (5.25 – 5.35 GHz), the maximum output power is 250 mW conducted and 30 dBm EIRP. When applicable, a lower maximum output power may be required to satisfy emission bandwidth restrictions for these bands. When both bands apply to a device, SAR test reduction may be considered for each exposure configuration according to procedures in section 5.3.1.

#### U-NII-2C, U-NII-3 Bands (§15.407) and 5.8 GHz Band (§15.247)

The maximum output power permitted for devices authorized under §15.407 U-NII-2C band (5.470 – 5.725) is 250 mW conducted and 30 dBm EIRP. For U-NII-3 band (5.725 – 5.850 GHz) the maximum output power permitted is 1 W conducted and 36 dBm EIRP.<sup>9</sup> When applicable, a lower maximum output power may be required due to emission bandwidth restrictions for these bands. In addition, when Terminal Doppler Weather Radar (TDWR) restriction applies, the channels at 5.60 – 5.65 GHz in U-NII-2C band must be disabled with acceptable mechanisms and documented in the equipment certification to avoid SAR requirements.<sup>10</sup> TDWR restriction does not apply under the new rules; all channels that operate at 5.60 – 5.65 GHz must be included to apply the SAR test reduction and measurement procedures.



## 2.4 GHz SAR Procedures

Separate SAR procedures are applied to DSSS and OFDM configurations in the 2.4 GHz band to simplify DSSS test requirements. For 802.11b DSSS SAR measurements, DSSS SAR procedure applies to fixed exposure test position and initial test position procedure applies to multiple exposure test positions. When SAR measurement is required for an OFDM configuration, the initial test configuration, subsequent test configuration and initial test position procedures are applied. The SAR test exclusion requirements for 802.11g/n OFDM configurations are described in section 5.2.2.

### 1. 802.11b DSSS SAR Test Requirements

SAR is measured for 2.4 GHz 802.11b DSSS using either a fixed test position or, when applicable, the initial test position procedure. SAR test reduction is determined according to the following:

- a. When the reported SAR of the highest measured maximum output power channel (section 3.1) for the exposure configuration is  $\leq 0.8$  W/kg, no further SAR testing is required for 802.11b DSSS in that exposure configuration.
- b. When the reported SAR is  $> 0.8$  W/kg, SAR is required for that exposure configuration using the next highest measured output power channel. When any reported SAR is  $> 1.2$  W/kg, SAR is required for the third channel; i.e., all channels require testing.

### 2. 2.4 GHz 802.11g/n OFDM SAR Test Exclusion Requirements

When SAR measurement is required for 2.4 GHz 802.11g/n OFDM configurations, the measurement and test reduction procedures for OFDM are applied (section 5.3). SAR is not required for the following 2.4 GHz OFDM conditions.

- a. When KDB Publication 447498 SAR test exclusion applies to the OFDM configuration
- b. When the highest reported SAR for DSSS is adjusted by the ratio of OFDM to DSSS specified maximum output power and the adjusted SAR is  $\leq 1.2$  W/kg.

### 3. SAR Test Requirements for OFDM Configurations

When SAR measurement is required for 802.11 a/g/n/ac OFDM configurations, each standalone and frequency aggregated band is considered separately for SAR test reduction. When the same transmitter and antenna(s) are used for U-NII-1 and U-NII-2A bands, additional SAR test reduction applies. When band gap channels between U-NII-2C band and 5.8 GHz U-NII-3 or §15.247 band are supported, the highest maximum output power transmission mode configuration and maximum output power channel across the bands must be used to determine SAR test reduction, according to the initial test configuration and subsequent test configuration requirements.<sup>20</sup> In applying the initial test configuration and subsequent test configuration procedures, the 802.11 transmission configuration with the highest specified maximum output power and the channel within a test configuration with the highest measured maximum output power should be clearly distinguished to apply the procedures.

### 4. U-NII-1 and U-NII-2A Bands

For devices that operate in only one of the U-NII-1 and U-NII-2A bands, the normally required SAR procedures for OFDM configurations are applied. For devices that operate in both U-NII bands using the same transmitter and antenna(s), SAR test reduction is determined according to the following, with respect to the highest reported SAR and maximum output power specified for production units. The procedures are applied independently to each exposure configuration; for example, head, body, hotspot mode etc.

- a. When the same maximum output power is specified for both bands, begin SAR measurement in U-NII-2A band by applying the OFDM SAR requirements.<sup>21</sup> If the highest reported SAR for a test configuration is  $\leq 1.2$  W/kg, SAR is not required for U-NII-1 band for that configuration (802.11 mode and exposure condition); otherwise, both bands are tested independently for SAR.
- b. When different maximum output power is specified for the bands, begin SAR measurement in the band with higher specified maximum output power. The highest reported SAR for the tested configuration is adjusted by the ratio of lower to higher specified maximum output power for the two bands. When the adjusted SAR is  $\leq 1.2$  W/kg, SAR is not required for the band with lower maximum output power in that test configuration; otherwise, both bands are tested independently for SAR.
- c. The two U-NII bands may be aggregated to support a 160 MHz channel on channel number 50. Without additional testing, the maximum output power for this is limited to the lower of the maximum output power certified for the two bands. When SAR measurement is required for at least one of the bands and the highest reported SAR adjusted by the ratio of specified maximum output power of aggregated to standalone band is  $> 1.2$  W/kg, SAR is required for the 160 MHz channel. This procedure does not apply to an aggregated band with maximum output higher than the standalone band(s); the aggregated band must be tested independently for SAR. SAR is not required when the 160 MHz channel is operating at a reduced maximum power and also qualifies for SAR test exclusion.

### 5. OFDM Transmission Mode SAR Test Configuration and Channel Selection Requirements

The initial test configuration for 2.4 GHz and 5 GHz OFDM transmission modes is determined by the 802.11 configuration with the highest maximum output power specified for production units, including tune-up tolerance, in each standalone and aggregated frequency band. SAR for the initial test configuration is measured using the highest maximum output power channel determined by the default power measurement procedures (section 4). When multiple configurations in a frequency band have the same specified maximum output power, the initial test configuration is determined according to the following steps applied sequentially.

- a. The largest channel bandwidth configuration is selected among the multiple configurations with the same specified maximum output power.
- b. If multiple configurations have the same specified maximum output power and largest channel bandwidth, the lowest order modulation among the largest channel bandwidth configurations is selected.
- c. If multiple configurations have the same specified maximum output power, largest channel bandwidth and lowest order modulation, the lowest data rate configuration among these configurations is selected.
- d. When multiple transmission modes (802.11a/g/n/ac) have the same specified maximum output power, largest channel bandwidth, lowest order modulation and lowest data rate, the lowest order 802.11 mode is selected; i.e., 802.11a is chosen over 802.11n then 802.11ac or 802.11g is chosen over 802.11n.

After an initial test configuration is determined, if multiple test channels have the same measured maximum output power, the channel chosen for SAR measurement is determined according to the following. These channel selection procedures apply to both the initial test configuration and subsequent test configuration(s), with respect to the default power measurement procedures or additional power measurements required for further SAR test reduction. The same procedures also apply to subsequent highest output power channel(s) selection.

- a. Channels with measured maximum output power within  $\frac{1}{4}$  dB of each other are considered to have the same maximum output.
- b. When there are multiple test channels with the same measured maximum output power, the channel closest to mid-band frequency is selected for SAR measurement.
- c. When there are multiple test channels with the same measured maximum output power and equal separation from mid-band frequency; for example, high and low channels or two mid-band channels, the higher frequency (number) channel is selected for SAR measurement.

#### 6. Initial Test Configuration Procedures

An initial test configuration is determined for OFDM transmission modes according to the channel bandwidth, modulation and data rate combination(s) with the highest maximum output power specified for production units in each standalone and aggregated frequency band. SAR is measured using the highest measured maximum output power channel. For configurations with the same specified or measured maximum output power, additional transmission mode and test channel selection procedures are required (see section 5.3.2). SAR test reduction of subsequent highest output test channels is based on the reported SAR of the initial test configuration.

For next to the ear, hotspot mode and UMC mini-tablet exposure configurations where multiple test positions are required, the initial test position procedure is applied to minimize the number of test positions required for SAR measurement using the initial test configuration transmission mode.<sup>23</sup> For fixed exposure conditions that do not have multiple SAR test positions, SAR is measured in the transmission mode determined by the initial test configuration. When the reported SAR of the initial test configuration is  $> 0.8$  W/kg, SAR measurement is required for the subsequent next highest measured output power channel(s) in the initial test configuration until the reported SAR is  $\leq 1.2$  W/kg or all required channels are tested.

#### 7. Subsequent Test Configuration Procedures

SAR measurement requirements for the remaining 802.11 transmission mode configurations that have not been tested in the initial test configuration are determined separately for each standalone and aggregated frequency band, in each exposure condition, according to the maximum output power specified for production units. The initial test position procedure is applied to next to the ear, UMPC mini-tablet and hotspot mode configurations. When the same maximum output power is specified for multiple transmission modes, the procedures in section 5.3.2 are applied to determine the test configuration. Additional power measurements may be required to determine if SAR measurements are required for subsequent highest output power channels in a subsequent test configuration. The subsequent test configuration and SAR measurement procedures are described in the following.

- a. When SAR test exclusion provisions of KDB Publication 447498 are applicable and SAR measurement is not required for the initial test configuration, SAR is also not required for the next highest maximum output power transmission mode subsequent test configuration(s) in that frequency band or aggregated band and exposure configuration.
- b. When the highest reported SAR for the initial test configuration (when applicable, include subsequent highest output channels), according to the initial test position or fixed exposure position requirements, is adjusted by the ratio of the subsequent test configuration to initial test configuration specified maximum output power and the adjusted SAR is  $\leq 1.2$  W/kg, SAR is not required for that subsequent test configuration.
- c. The number of channels in the initial test configuration and subsequent test configuration can be different due to differences in channel bandwidth. When SAR measurement is required for a subsequent test configuration and the channel bandwidth is smaller than that in the initial test configuration, all channels in the subsequent test configuration that overlap with the larger bandwidth channel tested in the initial test configuration should be used to determine the highest maximum output power channel. This step requires additional power measurement to identify the highest maximum output power channel in the subsequent test configuration to determine SAR test reduction.
  - 1). SAR should first be measured for the channel with highest measured output power in the subsequent test configuration.

- 2). SAR for subsequent highest measured maximum output power channels in the subsequent test configuration is required only when the reported SAR of the preceding higher maximum output power channel(s) in the subsequent test configuration is  $> 1.2$  W/kg or until all required channels are tested.
- a) For channels with the same measured maximum output power, SAR should be measured using the channel closest to the center frequency of the larger channel bandwidth channel in the initial test configuration.
- d. SAR measurements for the remaining highest specified maximum output power OFDM transmission mode configurations that have not been tested in the initial test configuration (highest maximum output) or subsequent test configuration(s) (subsequent next highest maximum output power) is determined by applying the subsequent test configuration procedures in this section to the remaining configurations according to the following:
- 1) replace "subsequent test configuration" with "next subsequent test configuration" (i.e., subsequent next highest specified maximum output power configuration)
  - 2) replace "initial test configuration" with "all tested higher output power configurations"

#### **4.10.5 Power Drift**

To control the output power stability during the SAR test, DASY5 system calculates the power drift by measuring the E-field at the same location at the beginning and at the end of the measurement for each test position. These drift values can be found in Table 14.1 to Table 14.11 labeled as: (Power Drift [dB]). This ensures that the power drift during one measurement is within 5%.

#### **4.10.6 Area Scan Based 1-g SAR**

##### **4.10.6.1 Requirement of KDB**

According to the KDB447498 D01 v05, when the implementation is based the specific polynomial fit algorithm as presented at the 29th Bioelectromagnetics Society meeting (2007) and the estimated 1-g SAR is  $\leq 1.2$  W/kg, a zoom scan measurement is not required provided it is also not needed for any other purpose; for example, if the peak SAR location required for simultaneous transmission SAR test exclusion can be determined accurately by the SAR system or manually to discriminate between distinctive peaks and scattered noisy SAR distributions from area scans.

There must not be any warning or alert messages due to various measurement concerns identified by the SAR system; for example, noise in measurements, peaks too close to scan boundary, peaks are too sharp, spatial resolution and uncertainty issues etc. The SAR system verification must also demonstrate that the area scan estimated 1-g SAR is within 3% of the zoom scan 1-g SAR (See Annex B). When all the SAR results for each exposure condition in a frequency band and wireless mode are based on estimated 1-g SAR, the 1-g SAR for the highest SAR configuration must be determined by a zoom scan.

#### **4.11. Power Reduction**

The product without any power reduction.

## 5. TEST CONDITIONS AND RESULTS

### 5.1. Conducted Power Results

Max Conducted power measurement results and power drift from tune-up tolerance provide by manufacturer:

**For WCDMA and GSM Conducted Output Power(Peak and Burst AV)**

#### TEST CONFIGURATION

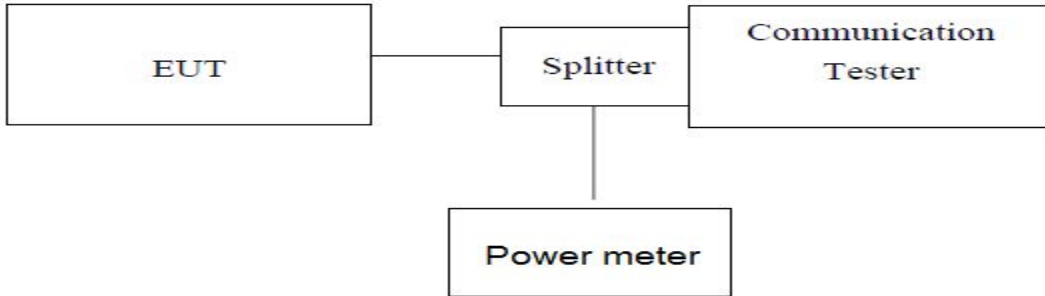

*Note: Measurement setup for testing on Antenna connector*

#### TEST PROCEDURE

- 1.The transmitter output port was connected to base station.
- 2.The RFoutput of EUT was connected to the power meter by RF cable and attenuator, the path loss was compensated to the results for each measurement.
3. Set EUT at maximum power through base station.
4. Select lowest, middle, and highest channels for each band and different modulation.
5. Measure the maximum PK burst power and maximum Avg. burst power.

**For WIFI and BT Conducted Output Power(Peak and AV)**

#### TEST CONFIGURATION



#### TEST PROCEDURE

Connect antenna port into power meter and reading Peak or AV values

Maximum conducted output power: measurements may be performed using a wideband RF power meter with a thermocouple detector or equivalent if all of the conditions listed below are satisfied.

1. The EUT is configured to transmit continuously,
2. At all times when the EUT is transmitting, it shall be transmitting at its maximum power control level.
3. The integration period of the power meter exceeds the repetition period of the transmitted signal by at least a factor of five.

**Conducted Power Measurement Results(GSM 850/1900)**

GSM 850		Burst Conducted power (dBm)			/	Average power (dBm)		
		Channel/Frequency(MHz)				Channel/Frequency(MHz)		
		128/824.2	190/836.6	251/848.8		128/824.2	190/836.6	251/848.8
GSM		31.17	31.76	31.84	-9.03dB	22.14	22.73	22.81
GPRS (GMSK)	1TX slot	31.07	31.57	31.79	-9.03dB	22.04	22.54	22.76
	2TX slot	29.28	29.33	29.67	-6.02dB	23.26	23.31	23.65
	3TX slot	28.63	28.77	28.97	-4.26dB	24.37	24.51	24.71
	4TX slot	<b>27.56</b>	<b>27.63</b>	<b>27.85</b>	<b>-3.01dB</b>	<b>24.55</b>	<b>24.62</b>	<b>24.84</b>
EGPRS (GMSK)	1TX slot	31.18	31.11	31.32	-9.03dB	22.15	22.08	22.29
	2TX slot	29.72	29.78	29.95	-6.02dB	23.70	23.76	23.93
	3TX slot	28.69	28.66	28.84	-4.26dB	24.43	24.40	24.58
	4TX slot	<b>27.48</b>	<b>27.58</b>	<b>27.77</b>	<b>-3.01dB</b>	<b>24.47</b>	<b>24.57</b>	<b>24.76</b>

GSM 1900		Burst Conducted power (dBm)			/	Average power (dBm)		
		Channel/Frequency(MHz)				Channel/Frequency(MHz)		
		512/ 1850.2	661/ 1880	810/ 1909.8		512/ 1850.2	661/ 1880	810/ 1909.8
GSM		28.59	29.17	29.25	-9.03dB	19.56	20.14	20.22
GPRS (GMSK)	1TX slot	28.71	29.11	29.26	-9.03dB	19.68	20.08	20.23
	2TX slot	26.90	26.99	27.31	-6.02dB	20.88	20.97	21.29
	3TX slot	25.34	25.46	25.53	-4.26dB	21.08	21.20	21.27
	4TX slot	24.86	25.04	25.17	-3.01dB	21.85	22.03	22.16
EGPRS (GMSK)	1TX slot	28.17	28.25	28.30	-9.03dB	19.14	19.22	19.27
	2TX slot	26.74	26.86	26.93	-6.02dB	20.72	20.84	20.91
	3TX slot	25.26	25.22	25.56	-4.26dB	21.00	20.96	21.30
	4TX slot	24.73	25.05	25.16	-3.01dB	21.72	22.04	22.15

## NOTES:

## 1) Division Factors

To average the power, the division factor is as follows:

1TX-slot = 1 transmit time slot out of 8 time slots=> conducted power divided by (8/1) => -9.03dB

2TX-slots = 2 transmit time slots out of 8 time slots=> conducted power divided by (8/2) => -6.02dB

3TX-slots = 3 transmit time slots out of 8 time slots=> conducted power divided by (8/3) => -4.26dB

4TX-slots = 4 transmit time slots out of 8 time slots=> conducted power divided by (8/4) => -3.01dB

According to the conducted power as above, the body measurements are performed with 4Txslots for GPRS850 and GPRS1900.

## Conducted Power Measurement Results(UMTS Band II/V)

Item	band	UMTS Band II result (dBm)			UMTS Band V result (dBm)		
		Channel/Frequency(MHz)			Channel/Frequency(MHz)		
	ARFCN	9262/1852.4	9400/1880	9538/1907.6	4132/826.4	4183/836.6	4233/846.6
RMC	12.2kbps RMC	22.51	22.89	22.95	22.09	22.24	21.87
	64kbps RMC	22.46	22.62	22.55	22.19	22.35	21.50
	144kbps RMC	22.51	22.57	22.42	22.23	22.21	21.36
	384kbps RMC	22.38	22.36	22.26	22.14	22.28	21.67
HSDPA	Sub - Test 1	21.57	21.66	21.53	21.54	21.71	20.57
	Sub - Test 2	21.58	21.67	21.51	21.71	21.69	20.56
	Sub - Test 3	21.15	21.21	21.06	21.28	21.26	20.18
	Sub - Test 4	21.12	21.18	21.04	21.25	21.23	20.14
HSUPA	Sub - Test 1	20.73	20.88	20.72	20.69	20.66	20.59
	Sub - Test 2	20.74	20.83	20.73	20.68	20.75	20.51
	Sub - Test 3	20.75	20.81	20.74	20.73	20.71	20.59
	Sub - Test 4	20.32	20.44	20.24	20.31	20.21	20.01
	Sub - Test 5	20.75	20.85	20.73	20.68	20.70	20.56

Note : When the maximum output power and tune-up tolerance specified for production units in a secondary mode is  $\leq 1/2$ dB higher than the primary mode (RMC12.2kbps) or when the highest reported SAR of the primary mode is scaled by the ratio of specified maximum output power and tune-up tolerance of secondary to primary mode and the adjusted SAR is  $\leq 1.2$  W/kg, SAR measurement is not required for the secondary mode.

## WLAN

Mode	Channel	Frequency (MHz)	Worst case Data rate of worst case	Conducted Average Output Power (dBm)
802.11b	1	2412	1Mbps	9.88
	6	2437	1Mbps	9.91
	11	2462	1Mbps	10.06
802.11g	1	2412	6Mbps	9.01
	6	2437	6Mbps	9.66
	11	2462	6Mbps	9.37
802.11n HT20	1	2412	6.5 Mbps	8.85
	6	2437	6.5 Mbps	9.74
	11	2462	6.5 Mbps	9.17
802.11n HT40	3	2422	13.5 Mbps	6.73
	6	2437	13.5 Mbps	7.84
	9	2452	13.5 Mbps	6.91

**Note:** SAR is not required for the following 2.4 GHz OFDM conditions as the highest reported SAR for DSSS is adjusted by the ratio of OFDM to DSSS specified maximum output power and the adjusted SAR is  $\leq 1.2$  W/kg.

**Bluetooth**

Mode	Channel	Frequency (MHz)	Conducted Average Power (dBm)
BLE-GFSK	00	2402	-8.04
	19	2440	-7.97
	39	2480	-8.16
GFSK	00	2402	-0.59
	39	2441	0.05
	78	2480	0.29
8DPSK	00	2402	-0.68
	39	2441	-0.06
	78	2480	0.10
$\pi/4$ DQPSK	00	2402	-0.67
	39	2441	-0.06
	78	2480	0.02

**Manufacturing tolerance****GSM Speech**

<b>GSM 850 (GMSK) (Burst Average Power)</b>			
Channel	Channel 251	Channel 190	Channel 190
Target (dBm)	31.00	31.00	31.00
Tolerance $\pm$ (dB)	1	1	1
<b>GSM 1900 (GMSK) (Burst Average Power)</b>			
Channel	Channel 810	Channel 661	Channel 512
Target (dBm)	29.00	29.00	29.00
Tolerance $\pm$ (dB)	1	1	1

<b>GSM 850 GPRS (GMSK) (Burst Average Power)</b>				
Channel		251	190	128
1 Txslot	Target (dBm)	31.0	31.0	31.0
	Tolerance $\pm$ (dB)	1	1	1
2 Txslot	Target (dBm)	29.0	29.0	29.0
	Tolerance $\pm$ (dB)	1	1	1
3 Txslot	Target (dBm)	28.0	28.0	28.0
	Tolerance $\pm$ (dB)	1	1	1
4 Txslot	Target (dBm)	27.0	27.0	27.0
	Tolerance $\pm$ (dB)	1	1	1
<b>GSM 850 EDGE (GMSK) (Burst Average Power)</b>				
Channel		251	190	128
1 Txslot	Target (dBm)	31.0	31.0	31.0
	Tolerance $\pm$ (dB)	1	1	1
2 Txslot	Target (dBm)	29.0	29.0	29.0
	Tolerance $\pm$ (dB)	1	1	1
3 Txslot	Target (dBm)	28.0	28.0	28.0
	Tolerance $\pm$ (dB)	1	1	1
4 Txslot	Target (dBm)	27.0	27.0	27.0
	Tolerance $\pm$ (dB)	1	1	1
<b>GSM 1900 GPRS (GMSK) (Burst Average Power)</b>				
Channel		810	661	512
1 Txslot	Target (dBm)	29.00	29.00	29.00
	Tolerance $\pm$ (dB)	1	1	1
2 Txslot	Target (dBm)	27.0	27.0	27.0
	Tolerance $\pm$ (dB)	1	1	1
3 Txslot	Target (dBm)	25.0	25.0	25.0
	Tolerance $\pm$ (dB)	1	1	1
4 Txslot	Target (dBm)	25.0	25.0	25.0
	Tolerance $\pm$ (dB)	1	1	1

<b>GSM 1900 EDGE (GMSK) (Burst Average Power)</b>				
Channel		810	661	512
1 Txslot	Target (dBm)	29.00	29.00	29.00
	Tolerance $\pm$ (dB)	1	1	1
2 Txslot	Target (dBm)	27.0	27.0	27.0
	Tolerance $\pm$ (dB)	1	1	1
3 Txslot	Target (dBm)	25.0	25.0	25.0
	Tolerance $\pm$ (dB)	1	1	1
4 Txslot	Target (dBm)	25.0	25.0	25.0
	Tolerance $\pm$ (dB)	1	1	1

**UMTS**

<b>UMTS Band V</b>				
Channel	Channel 4132	Channel 4182	Channel 4233	
Target (dBm)	22.0	22.0	21.0	
Tolerance $\pm$ (dB)	1	1	1	
<b>UMTS Band V HSDPA(sub-test 1)</b>				
Channel	Channel 4132	Channel 4182	Channel 4233	
Target (dBm)	21.0	21.0	21.0	
Tolerance $\pm$ (dB)	1	1	1	
<b>UMTS Band V HSDPA(sub-test 2)</b>				
Channel	Channel 4132	Channel 4182	Channel 4233	
Target (dBm)	21.0	21.0	21.0	
Tolerance $\pm$ (dB)	1	1	1	
<b>UMTS Band V HSDPA(sub-test 3)</b>				
Channel	Channel 4132	Channel 4182	Channel 4233	
Target (dBm)	21.0	21.0	21.0	
Tolerance $\pm$ (dB)	1	1	1	
<b>UMTS Band V HSDPA(sub-test 4)</b>				
Channel	Channel 4132	Channel 4182	Channel 4233	
Target (dBm)	21.0	21.0	21.0	
Tolerance $\pm$ (dB)	1	1	1	
<b>UMTS Band V HSUPA(sub-test 1)</b>				
Channel	Channel 4132	Channel 4182	Channel 4233	
Target (dBm)	20.0	20.0	20.0	
Tolerance $\pm$ (dB)	1	1	1	
<b>UMTS Band V HSUPA(sub-test 2)</b>				
Channel	Channel 4132	Channel 4182	Channel 4233	
Target (dBm)	20.0	20.0	20.0	
Tolerance $\pm$ (dB)	1	1	1	
<b>UMTS Band V HSUPA(sub-test 3)</b>				
Channel	Channel 4132	Channel 4182	Channel 4233	
Target (dBm)	20.0	20.0	20.0	
Tolerance $\pm$ (dB)	1	1	1	
<b>UMTS Band V HSUPA(sub-test 4)</b>				
Channel	Channel 4132	Channel 4182	Channel 4233	
Target (dBm)	20.0	20.0	20.0	
Tolerance $\pm$ (dB)	1	1	1	
<b>UMTS Band V HSUPA(sub-test 5)</b>				
Channel	Channel 4132	Channel 4182	Channel 4233	
Target (dBm)	20.0	20.0	20.0	
Tolerance $\pm$ (dB)	1	1	1	
<b>UMTS Band II</b>				
Channel	Channel 9262	Channel 9400	Channel 9538	
Target (dBm)	22.0	22.0	22.0	
Tolerance $\pm$ (dB)	1	1	1	
<b>UMTS Band II HSDPA(sub-test 1)</b>				
Channel	Channel 9262	Channel 9400	Channel 9538	
Target (dBm)	21.0	21.0	21.0	
Tolerance $\pm$ (dB)	1	1	1	
<b>UMTS Band II HSDPA(sub-test 2)</b>				
Channel	Channel 9262	Channel 9400	Channel 9538	
Target (dBm)	21.0	21.0	21.0	
Tolerance $\pm$ (dB)	1	1	1	

Target (dBm)	21.0	21.0	21.0
Tolerance $\pm$ (dB)	1	1	1
<b>UMTS Band II HSDPA(sub-test 3)</b>			
Channel	Channel 9262	Channel 9400	Channel 9538
Target (dBm)	21.0	21.0	21.0
Tolerance $\pm$ (dB)	1	1	1
<b>UMTS Band II HSDPA(sub-test 4)</b>			
Channel	Channel 9262	Channel 9400	Channel 9538
Target (dBm)	21.0	21.0	21.0
Tolerance $\pm$ (dB)	1	1	1
<b>UMTS Band II HSUPA(sub-test 1)</b>			
Channel	Channel 9262	Channel 9400	Channel 9538
Target (dBm)	20.0	20.0	20.0
Tolerance $\pm$ (dB)	1	1	1
<b>UMTS Band II HSUPA(sub-test 2)</b>			
Channel	Channel 9262	Channel 9400	Channel 9538
Target (dBm)	20.0	20.0	20.0
Tolerance $\pm$ (dB)	1	1	1
<b>UMTS Band II HSUPA(sub-test 3)</b>			
Channel	Channel 9262	Channel 9400	Channel 9538
Target (dBm)	20.0	20.0	20.0
Tolerance $\pm$ (dB)	1	1	1
<b>UMTS Band II HSUPA(sub-test 4)</b>			
Channel	Channel 9262	Channel 9400	Channel 9538
Target (dBm)	20.0	20.0	20.0
Tolerance $\pm$ (dB)	1	1	1
<b>UMTS Band II HSUPA(sub-test 5)</b>			
Channel	Channel 9262	Channel 9400	Channel 9538
Target (dBm)	20.0	20.0	20.0
Tolerance $\pm$ (dB)	1	1	1

**WiFi**

<b>802.11b (Average)</b>			
Channel	Channel 1	Channel 6	Channel 11
Target (dBm)	10.0	10.0	10.0
Tolerance $\pm$ (dB)	1	1	1
<b>802.11g (Average)</b>			
Channel	Channel 1	Channel 6	Channel 11
Target (dBm)	9.0	9.0	9.0
Tolerance $\pm$ (dB)	1	1	1
<b>802.11n HT20 (Average)</b>			
Channel	Channel 1	Channel 6	Channel 11
Target (dBm)	9.0	9.0	9.0
Tolerance $\pm$ (dB)	1	1	1
<b>802.11n HT40 (Average)</b>			
Channel	Channel 3	Channel 6	Channel 9
Target (dBm)	7.0	7.0	7.0
Tolerance $\pm$ (dB)	1	1	1

**Bluetooth**

<b>BLE-GFSK (Average)</b>			
Channel	Channel 00	Channel 19	Channel 39
Target (dBm)	-8.00	-8.00	-8.00
Tolerance $\pm$ (dB)	1	1	1
<b>GFSK (Average)</b>			
Channel	Channel 00	Channel 39	Channel 78
Target (dBm)	0.00	0.00	0.00
Tolerance $\pm$ (dB)	1	1	1
<b>8DPSK (Average)</b>			
Channel	Channel 00	Channel 39	Channel 78
Target (dBm)	0.00	0.00	0.00
Tolerance $\pm$ (dB)	1	1	1



$\pi/4$ DQPSK (Average)			
Channel	Channel 00	Channel 39	Channel 78
Target (dBm)	0.00	0.00	0.00
Tolerance $\pm$ (dB)	1	1	1

## 5.2. Simultaneous TX SAR Considerations

### 5.2.1 Introduction

The following procedures adopted from “FCC SAR Considerations for Cell Phones with Multiple Transmitters” are applicable to handsets with built-in unlicensed transmitters such as 802.11 a/b/g/n and Bluetooth devices which may simultaneously transmit with the licensed transmitter.

For the DUT, the BT and WiFi modules sharing same antenna, GSM and UMTS module sharing a single antenna;

Application Simultaneous Transmission information:

Air-Interface	Band (MHz)	Type	Simultaneous Transmissions	Voice over Digital Transport(Data)
GSM	850	VO	Yes, WLAN or BT/BLE	N/A
	1900	VO		
	GPRS/EDGE	DT	Yes, WLAN or BT/BLE	N/A
UMTS	Band II/Band V	DT	Yes, WLAN or BT/BLE	N/A
WLAN	2450	DT	Yes, GSM, GPRS, EDGE, UMTS	Yes
BT/BLE	2450	DT	Yes, GSM, GPRS, EDGE, UMTS	N/A

Note: VO-Voice Service only; DT-Digital Transport

Note: BT and WLAN can be active at the same time, but only with interleaving of packages switched on board level. That means that they don't transmit at the same time.

BLE-Bluetooth low energy;

BT- Classical Bluetooth

### 5.2.2 Transmit Antennas and SAR Measurement Positions

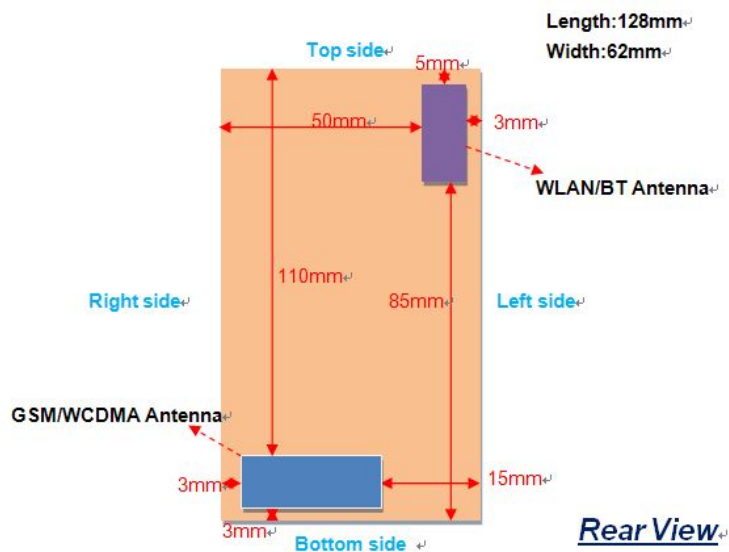

Note:

1). Per KDB648474 D04, because the overall diagonal distance of this devices is 150mm < 160mm, it is not considered a “Phablet” device.

2). According to the KDB941225 D06 Hot Spot SAR v02, the edges with less than 2.5 cm distance to the antennas need to be tested for SAR.

#### Hotspot mode SAR measurement positions

Hotspot mode SAR measurement positions						
mode	front	rear	left egde	right egde	top egde	bottom egde
GSM 850	yes	yes	yes	yes	no	yes
GSM 1900	yes	yes	yes	yes	no	yes
UMTS FDD Band II	yes	yes	yes	yes	no	yes
UMTS FDD Band V	yes	yes	yes	yes	no	yes
WiFi240	yes	yes	yes	no	yes	no

#### 5.2.2 Standalone SAR Test Exclusion Considerations

Standalone 1-g head or body SAR evaluation by measurement or numerical simulation is not required when the corresponding SAR Exclusion Threshold condition, listed below, is satisfied.

The 1-g and 10-g SAR test exclusion thresholds for 100 MHz to 6 GHz at test separation distances  $\leq 50$  mm are determined by::

$[(\text{max. power of channel, including tune-up tolerance, mW}) / (\text{min. test separation distance, mm})] \cdot [\sqrt{f(\text{GHz})}] \leq 3.0$  for 1-g SAR and  $\leq 7.5$  for 10-g extremity SAR, where

- f(GHz) is the RF channel transmit frequency in GHz
- Power and distance are rounded to the nearest mW and mm before calculation
- The result is rounded to one decimal place for comparison
- 3.0 and 7.5 are referred to as the numeric thresholds in the step 2 below

The test exclusions are applicable only when the minimum test separation distance is  $\leq 50$  mm and for transmission frequencies between 100 MHz and 6 GHz. When the minimum test separation distance is  $< 5$  mm, a distance of 5 mm according to 5) in section 4.1 is applied to determine SAR test exclusion.

Standalone SAR test exclusion considerations							
Communication system	Frequency (MHz)	Configuration	Maximum Average Power (dBm)	Separation Distance (mm)	Calculation Result	SAR Exclusion Thresholds	Standalone SAR Exclusion
GSM 850	835	Head	22.97	5	36.2	3.0	no
		Body*	24.99	5	57.7	3.0	no
GSM 1900	1900	Head	20.97	5	34.5	3.0	no
		Body*	22.99	5	54.9	3.0	no
UMTS Band II	1900	Head	23.00	5	55.0	3.0	no
		Body*	23.00	5	55.0	3.0	no
UMTS Band V	850	Head	23.00	5	36.8	3.0	no
		Body*	23.00	5	36.8	3.0	no
WiFi 2450	2450	Head	11.00	5	3.9	3.0	no
		Body*	11.00	5	3.9	3.0	no
Bluetooth	2450	Head	1.00	5	0.4	3.0	yes
		Body*	1.00	5	0.4	3.0	yes

Note:

1. Maximum average power including tune-up tolerance;
2. Bluetooth including BLE and classical Bluetooth;
3. When the minimum test separation distance is < 5 mm, a distance of 5 mm is applied to determine SAR test exclusion
4. Body including Hotspot mode as body use distance is 10mm from manufacturer declaration of user manual.

#### 5.2.4 Standalone SAR Test Exclusion Considerations and Estimated SAR

Per KDB447498 requires when the standalone SAR test exclusion of section 4.3.1 is applied to an antenna that transmits simultaneously with other antennas, the standalone SAR must be estimated according to the following to determine simultaneous transmission SAR test exclusion;

- $(\text{max. power of channel, including tune-up tolerance, mW}) / (\text{min. test separation distance, mm}) \cdot [\sqrt{f(\text{GHz})} / x]$  W/kg for test separation distances  $\leq 50$  mm; where  $x = 7.5$  for 1-g SAR, and  $x = 18.75$  for 10-g SAR.
- 0.4 W/kg for 1-g SAR and 1.0 W/kg for 10-g SAR, when the test separation distances is > 50 mm

Per FCC KD B447498 D01, simultaneous transmission SAR test exclusion may be applied when the sum of the 1-g SAR for all the transmitting antenna in a specific physical test configuration is  $\leq 1.6$  W/Kg. When the sum is greater than the SAR limit, SAR test exclusion is determined by the SAR to peak location separation ratio.

$$\text{Ratio} = \frac{(SAR_1 + SAR_2)^{1.5}}{(\text{peak location separation, mm})} < 0.04$$

Estimated stand alone SAR					
Communication system	Frequency (MHz)	Configuration	Maximum Power (including tune-up tolerance) (dBm)	Separation Distance (mm)	Estimated SAR <sub>1-g</sub> (W/kg)
Bluetooth*	2450	Head	1.00	5	0.05
Bluetooth*	2450	Hotspot	1.00	10	0.03
Bluetooth*	2450	Body Worn	1.00	5	0.05

Bluetooth\*- Including Lower power Bluetooth

## 5.2.5 Evaluation of Simultaneous SAR

**Head Exposure Conditions****Simultaneous transmission SAR for WiFi and GSM/UMTS**

Test Position	SAR Type	GSM850 Reported SAR <sub>1-g</sub> (W/Kg)	GSM1900 Reported SAR <sub>1-g</sub> (W/Kg)	UMTS Band II Reported SAR <sub>1-g</sub> (W/Kg)	UMTS Band V Reported SAR <sub>1-g</sub> (W/Kg)	WiFi Reported SAR <sub>1-g</sub> (W/Kg)	MAX. ΣSAR <sub>1-g</sub> (W/Kg)	SAR <sub>1-g</sub> Limit (W/Kg)	Peak location separation ratio	Simut. Meas. Required
Left/Cheek	1-g	<b>0.407</b>	<b>0.482</b>	<b>0.531</b>	<b>0.572</b>	0.249	<b>0.821</b>	1.6	no	no
Left/Tilt	1-g	0.345	0.407	0.478	0.521	0.218	0.739	1.6	no	no
Right/Cheek	1-g	0.337	0.413	0.465	0.501	<b>0.300</b>	0.801	1.6	no	no
Right/Tilt	1-g	0.303	0.367	0.439	0.459	0.249	0.708	1.6	no	no

**Simultaneous transmission SAR for Bluetooth and GSM/UMTS**

Test Position	SAR Type	GSM850 Reported SAR <sub>1-g</sub> (W/Kg)	GSM1900 Reported SAR <sub>1-g</sub> (W/Kg)	UMTS Band II Reported SAR <sub>1-g</sub> (W/Kg)	UMTS Band V Reported SAR <sub>1-g</sub> (W/Kg)	Bluetooth Estimated SAR <sub>1-g</sub> (W/Kg)	MAX. ΣSAR <sub>1-g</sub> (W/Kg)	SAR <sub>1-g</sub> Limit (W/Kg)	Peak location separation ratio	Simut. Meas. Required
Left/Cheek	1-g	<b>0.407</b>	<b>0.482</b>	<b>0.531</b>	<b>0.572</b>	0.05	<b>0.622</b>	1.6	no	no
Left/Tilt	1-g	0.345	0.407	0.478	0.521	0.05	0.571	1.6	no	no
Right/Cheek	1-g	0.337	0.413	0.465	0.501	0.05	0.551	1.6	no	no
Right/Tilt	1-g	0.303	0.367	0.439	0.459	0.05	0.509	1.6	no	no

**Body-Worn Accessory Exposure Conditions****Simultaneous transmission SAR for WiFi and GSM/UMTS**

Test Position	SAR Type	GSM850 Reported SAR <sub>1-g</sub> (W/Kg)	GSM1900 Reported SAR <sub>1-g</sub> (W/Kg)	UMTS Band II Reported SAR <sub>1-g</sub> (W/Kg)	UMTS Band V Reported SAR <sub>1-g</sub> (W/Kg)	WiFi Reported SAR <sub>1-g</sub> (W/Kg)	MAX. ΣSAR <sub>1-g</sub> (W/Kg)	SAR <sub>1-g</sub> Limit (W/Kg)	Peak location separation ratio	Simut. Meas. Required
Rear Side	1-g	0.766	0.972	0.951	0.979	0.523	1.502	1.6	no	no
Front Side	1-g	0.723	0.875	0.829	0.920	0.325	1.245	1.6	no	no

**Simultaneous transmission SAR for Bluetooth and GSM/UMTS**

Test Position	SAR Type	GSM850 Reported SAR <sub>1-g</sub> (W/Kg)	GSM1900 Reported SAR <sub>1-g</sub> (W/Kg)	UMTS Band II Reported SAR <sub>1-g</sub> (W/Kg)	UMTS Band V Reported SAR <sub>1-g</sub> (W/Kg)	Bluetooth Estimated SAR <sub>1-g</sub> (W/Kg)	MAX. ΣSAR <sub>1-g</sub> (W/Kg)	SAR <sub>1-g</sub> Limit (W/Kg)	Peak location separation ratio	Simut. Meas. Required
Rear Side	1-g	0.766	0.972	0.951	0.979	0.05	1.029	1.6	no	no
Front Side	1-g	0.723	0.875	0.829	0.920	0.05	0.970	1.6	no	no

Note: The test distance of Body-Worn is 5mm.

**Hotspot SAR****Simultaneous transmission SAR for WiFi and GSM/UMTS (Hotspot Open)**

Test Position	SAR Type	GSM850 Reported SAR <sub>1-g</sub> (W/Kg)	GSM1900 Reported SAR <sub>1-g</sub> (W/Kg)	UMTS Band II Reported SAR <sub>1-g</sub> (W/Kg)	UMTS Band V Reported SAR <sub>1-g</sub> (W/Kg)	WiFi Reported SAR <sub>1-g</sub> (W/Kg)	MAX. ΣSAR <sub>1-g</sub> (W/Kg)	SAR <sub>1-g</sub> Limit (W/Kg)	Peak location separation ratio	Simut. Meas. Required
Rear Side	1-g	<b>0.679</b>	<b>0.903</b>	<b>0.850</b>	<b>0.945</b>	<b>0.387</b>	<b>1.332</b>	1.6	no	no
Front Side	1-g	0.588	0.703	0.737	0.765	0.346	1.111	1.6	no	no
Left Side	1-g	0.310	0.453	0.497	0.496	0.361	0.858	1.6	no	no
Right Side	1-g	0.613	0.854	0.775	0.791	N/A	0.854	1.6	no	no
Top Side	1-g	N/A	N/A	N/A	N/A	0.353	0.353	1.6	no	no
Bottom Side	1-g	0.653	0.875	0.827	0.798	N/A	0.875	1.6	no	no

**Simultaneous transmission SAR for Bluetooth and GSM/UMTS (Hotspot Open)**

Test Position	SAR Type	GSM850 Reported SAR <sub>1-g</sub> (W/Kg)	GSM1900 Reported SAR <sub>1-g</sub> (W/Kg)	UMTS Band II Reported SAR <sub>1-g</sub> (W/Kg)	UMTS Band V Reported SAR <sub>1-g</sub> (W/Kg)	Bluetooth Estimated SAR <sub>1-g</sub> (W/Kg)	MAX. ΣSAR <sub>1-g</sub> (W/Kg)	SAR <sub>1-g</sub> Limit (W/Kg)	Peak location separation ratio	Simut. Meas. Required
Rear Side	1-g	<b>0.679</b>	<b>0.903</b>	<b>0.850</b>	<b>0.945</b>	0.03	<b>0.975</b>	1.6	no	no
Front Side	1-g	0.588	0.703	0.737	0.765	0.03	0.795	1.6	no	no
Left Side	1-g	0.310	0.453	0.497	0.496	0.03	0.527	1.6	no	no
Right Side	1-g	0.613	0.854	0.775	0.791	0.03	0.884	1.6	no	no
Top Side	1-g	N/A	N/A	N/A	N/A	0.03	0.030	1.6	no	no
Bottom Side	1-g	0.653	0.875	0.827	0.798	0.03	0.905	1.6	no	no

Note: The test distance of Hotspot is 10mm.

Note:

1. The WiFi and BT share same antenna, so cannot transmit at same time.
2. The value with block color is the maximum values of standalone
3. The value with blue color is the maximum values of ΣSAR<sub>1-g</sub>

**5.3. SAR Measurement Results**

The calculated SAR is obtained by the following formula:

$$\text{Reported SAR} = \text{Measured SAR} * 10^{(P_{\text{target}} - P_{\text{measured}})/10}$$

$$\text{Scaling factor} = 10^{(P_{\text{target}} - P_{\text{measured}})/10}$$

$$\text{Reported SAR} = \text{Measured SAR} * \text{Scaling factor}$$

Where

$P_{\text{target}}$  is the power of manufacturing upper limit;

$P_{\text{measured}}$  is the measured power;

Measured SAR is measured SAR at measured power which including power drift)

Reported SAR which including Power Drift and Scaling factor

The product with 2 SIMs and 2 SIMs (SIM1 and SIM2) can not used Simultaneous, we tested 2 SIMs (SIM1 and SIM2) and recorded worst case at SIM 1

**Duty Cycle**

Test Mode	Duty Cycle
Speech for GSM850/1900	1:8
GPRS850/1900	1:2
UMTS	1:1
WiFi2450	1:1

Table 5: SAR Values [GSM 850 (GSM/GPRS/EDGE)]

Ch.	Freq. (MHz)	Time slots	Test Position	Maximum Allowed Power (dBm)	Conducted Power (dBm)	Power drift	Scaling Factor	SAR <sub>1-g</sub> results(W/kg)		Graph Results
								Measured	Reported	
<b>measured / reported SAR numbers - Head</b>										
190	836.60	GSM	Left/Cheek	32.00	31.76	-0.03	1.06	0.384	<b>0.407</b>	Plot 1
190	836.60	GSM	Left/Tilt	32.00	31.76	-0.02	1.06	0.325	0.345	N/A
190	836.60	GSM	Right/Cheek	32.00	31.76	-0.10	1.06	0.318	0.337	N/A
190	836.60	GSM	Right/Tilt	32.00	31.76	-0.06	1.06	0.286	0.303	N/A
<b>measured / reported SAR numbers - Body (hotspot open, distance 10mm)</b>										
190	836.60	4Txslots	Rear Side	28.00	27.63	-0.05	1.09	0.623	<b>0.679</b>	N/A
190	836.60	4Txslots	Front Side	28.00	27.63	0.07	1.09	0.539	0.588	N/A
190	836.60	4Txslots	Left Side	28.00	27.63	-0.11	1.09	0.284	0.310	N/A
190	836.60	4Txslots	Right Side	28.00	27.63	-0.10	1.09	0.562	0.613	N/A
N/A	N/A	N/A	Top Side	N/A	N/A	N/A	N/A	N/A	N/A	N/A
190	836.60	4Txslots	Bottom Side	28.00	27.63	0.09	1.09	0.599	0.653	N/A
<b>Worst Case Position of Body with EGPRS (hotspot open, distance 10mm)</b>										
190	836.60	4Txslots	Rear Side	28.00	27.58	0.02	1.10	0.606	0.667	N/A
<b>measured / reported SAR numbers – Body worn (distance 5mm)</b>										
190	836.60	GSM	Rear Side	32.00	31.76	-0.03	1.06	0.723	<b>0.766</b>	Plot 2
190	836.60	GSM	Front Side	32.00	31.76	-0.15	1.06	0.682	0.723	N/A

## Note:

1. The value with block color is the maximum Reported SAR Value of each test band.
2. Per FCC KDB Publication 447498 D01, if the reported (scaled) SAR measured at the middle channel or highest output power channel for each test configuration is  $\leq 0.8$  W/kg then testing at the other channels is optional for such test configuration(s).
3. When multiple slots are used, SAR should be tested to account for the maximum source-based time-averaged output power.
4. Per FCC KDB Publication 648474 D04, SAR was evaluated without a headset connected to the device. Since the reported SAR was  $\leq 1.2$  W/kg, no additional SAR evaluations using a headset cable were required.

Table 6: SAR Values [GSM 1900 (GSM/GPRS/EDGE)]

Ch.	Freq. (MHz)	time slots	Test Position	Maximum Allowed Power (dBm)	Conducted Power (dBm)	Power drift	Scaling Factor	SAR <sub>1-g</sub> results(W/kg)		Graph Results
								Measured	Reported	
<b>measured / reported SAR numbers - Head</b>										
661	1880.0	GSM	Left/Cheek	30.00	29.17	-0.08	1.21	0.398	<b>0.482</b>	Plot 3
661	1880.0	GSM	Left/Tilt	30.00	29.17	-0.12	1.21	0.336	0.407	N/A
661	1880.0	GSM	Right/Cheek	30.00	29.17	-0.09	1.21	0.341	0.413	N/A
661	1880.0	GSM	Right/Tilt	30.00	29.17	-0.06	1.21	0.303	0.367	N/A
<b>measured / reported SAR numbers – Body (hotspot open, distance 10mm)</b>										
512	1850.2	4Txslots	Rear Side	26.00	24.86	0.01	1.30	0.673	0.875	N/A
661	1880.0	4Txslots		26.00	25.04	0.06	1.25	0.722	<b>0.903</b>	N/A
810	1909.8	4Txslots		26.00	25.17	-0.04	1.21	0.701	0.848	N/A
661	1880.0	4Txslots	Front Side	26.00	25.04	0.06	1.25	0.562	0.703	N/A
661	1880.0	4Txslots	Left Side	26.00	25.04	0.06	1.25	0.362	0.453	N/A
512	1850.2	4Txslots	Right Side	26.00	24.86	-0.05	1.30	0.625	0.813	N/A
661	1880.0	4Txslots		26.00	25.04	-0.04	1.25	0.683	0.854	N/A
810	1909.8	4Txslots		26.00	25.17	-0.02	1.21	0.618	0.748	N/A
N/A	N/A	N/A	Top Side	N/A	N/A	N/A	N/A	N/A	N/A	N/A
512	1850.2	4Txslots	Bottom Side	26.00	24.86	0.11	1.30	0.638	0.829	N/A
661	1880.0	4Txslots		26.00	25.04	0.06	1.25	0.700	0.875	N/A
810	1909.8	4Txslots		26.00	25.17	-0.15	1.21	0.662	0.801	N/A
<b>Worst Case Position of Body with EGPRS (hotspot open, distance 10mm)</b>										
512	1850.2	4Txslots	Rear Side	26.00	24.73	-0.12	1.34	0.573	0.768	N/A
661	1880.0	4Txslots		26.00	25.05	0.06	1.24	0.675	0.837	N/A
810	1909.8	4Txslots		26.00	25.16	-0.07	1.21	0.622	0.753	N/A
<b>measured / reported SAR numbers – Body worn (distance 5mm)</b>										
512	1850.2	GSM	Rear Side	30.00	28.59	-0.08	1.38	0.675	0.934	N/A
661	1880.0	GSM	Rear Side	30.00	29.17	-0.13	1.21	0.803	<b>0.972</b>	Plot 4

810	1909.8	GSM	Rear Side	30.00	29.25	-0.10	1.19	0.796	0.946	N/A
512	1850.2	GSM	Front Side	30.00	28.59	-0.06	1.38	0.589	0.815	N/A
661	1880.0	GSM	Front Side	30.00	29.17	-0.01	1.21	0.723	0.875	N/A
810	1909.8	GSM	Front Side	30.00	29.25	0.05	1.19	0.695	0.826	N/A

## Repeated SAR

Ch.	Freq. (MHz)	Time slots	Test Position	Maximum Allowed Power (dBm)	Conducted Power (dBm)	Power drift	Scaling Factor	SAR <sub>1-g</sub> results(W/kg)		Graph Results
								Measured	Reported	
<i>measured / reported SAR numbers - Body (Body-worn, distance 5mm)</i>										
661	1880.0	GSM	Rear Side	30.00	29.17	-0.11	1.21	0.795	0.962	N/A

## Note:

1. The value with block color is the maximum Reported SAR Value of each test band.
2. Per FCC KDB Publication 447498 D01, if the reported (scaled) SAR measured at the middle channel or highest output power channel for each test configuration is  $\leq 0.8$  W/kg then testing at the other channels is optional for such test configuration(s).
3. When multiple slots are used, SAR should be tested to account for the maximum source-based time-averaged output power.
4. Per FCC KDB Publication 648474 D04, SAR was evaluated without a headset connected to the device. Since the reported SAR was  $\leq 1.2$  W/kg, no additional SAR evaluations using a headset cable were required.

Table 7: SAR Values [UMTS Band II (WCDMA/HSDPA/HSUPA)]

Ch.	Freq. (MHz)	Channel Type	Test Position	Maximum Allowed Power (dBm)	Conducted Power (dBm)	Power drift	Scaling Factor	SAR <sub>1-g</sub> results(W/kg)		Graph Results
								Measured	Reported	
<i>measured / reported SAR numbers - Head</i>										
9440	1880.0	RMC	Left/Cheek	23.00	22.89	-0.03	1.03	0.516	<b>0.531</b>	Plot 5
9440	1880.0	RMC	Left/Tilt	23.00	22.89	-0.02	1.03	0.464	0.478	N/A
9440	1880.0	RMC	Right/Cheek	23.00	22.89	-0.10	1.03	0.451	0.465	N/A
9440	1880.0	RMC	Right/Tilt	23.00	22.89	-0.09	1.03	0.426	0.439	N/A
<i>measured / reported SAR numbers - Body (hotspot open, distance 10mm)</i>										
9262	1852.4	RMC	Rear Side	23.00	22.51	-0.15	1.11	0.743	0.825	N/A
9440	1880.0	RMC		23.00	22.89	-0.05	1.03	0.825	<b>0.850</b>	N/A
9538	1907.6	RMC		23.00	22.95	0.07	1.01	0.796	0.804	N/A
9440	1880.0	RMC	Front Side	23.00	22.89	-0.11	1.03	0.716	0.737	N/A
9440	1880.0	RMC	Left Side	23.00	22.89	-0.05	1.03	0.483	0.497	N/A
9440	1880.0	RMC	Right Side	23.00	22.89	0.03	1.03	0.752	0.775	N/A
N/A	N/A	N/A	Top Side	N/A	N/A	N/A	N/A	N/A	N/A	N/A
9262	1852.4	RMC	Bottom Side	23.00	22.51	-0.15	1.11	0.737	0.818	N/A
9440	1880.0	RMC		23.00	22.89	-0.05	1.03	0.803	0.827	N/A
9538	1907.6	RMC		23.00	22.95	0.07	1.01	0.755	0.763	N/A
<i>measured / reported SAR numbers - Body worn (distance 5mm)</i>										
9262	1852.4	RMC	Rear Side	23.00	22.51	0.06	1.11	0.895	0.993	N/A
9440	1880.0	RMC	Rear Side	23.00	22.89	-0.05	1.03	0.923	<b>0.951</b>	Plot 6
9538	1907.6	RMC	Rear Side	23.00	22.95	-0.06	1.01	0.905	0.914	N/A
9262	1852.4	RMC	Front Side	23.00	22.51	-0.07	1.11	0.721	0.800	N/A
9440	1880.0	RMC	Front Side	23.00	22.89	-0.09	1.03	0.805	0.829	N/A
9538	1907.6	RMC	Front Side	23.00	22.95	0.05	1.01	0.791	0.799	N/A

## Repeated SAR

Ch.	Freq. (MHz)	Time slots	Test Position	Maximum Allowed Power (dBm)	Conducted Power (dBm)	Power drift	Scaling Factor	SAR <sub>1-g</sub> results(W/kg)		Graph Results
								Measured	Reported	
<i>measured / reported SAR numbers - Body (Body-worn, distance 5mm)</i>										
9440	1880.0	RMC	Rear Side	23.00	22.89	-0.14	1.03	0.899	0.926	N/A

## Note:

1. The value with block color is the maximum Reported SAR Value of each test band.
2. Per FCC KDB Publication 447498 D01, if the reported (scaled) SAR measured at the middle channel or highest output power channel for each test configuration is  $\leq 0.8$  W/kg then testing at the other channels is optional for such test configuration(s).

3. Per FCC KDB Publication 648474 D04, SAR was evaluated without a headset connected to the device. Since the reported SAR was  $\leq 1.2$  W/kg, no additional SAR evaluations using a headset cable were required.
4. When the maximum output power and tune-up tolerance specified for production units in a secondary mode is  $\leq \frac{1}{4}$  dB higher than the primary mode or when the highest reported SAR of the primary mode is scaled by the ratio of specified maximum output power and tune-up tolerance of secondary to primary mode and the adjusted SAR is  $\leq 1.2$  W/kg, SAR measurement is not required for the secondary mode.
5. Channel Type RMC states RMC 12.2kbps.

Table 8: SAR Values [UMTS Band V (WCDMA/HSDPA/HSUPA)]

Ch.	Freq. (MHz)	Channel Type	Test Position	Maximum Allowed Power (dBm)	Conducted Power (dBm)	Power drift	Scaling Factor	SAR <sub>1-g</sub> results(W/kg)		Graph Results
								Measured	Reported	
<b>measured / reported SAR numbers - Head</b>										
4183	836.6	RMC	Left/Cheek	23.00	22.24	-0.13	1.19	0.481	<b>0.572</b>	Plot 7
4183	836.6	RMC	Left/Tilt	23.00	22.24	-0.03	1.19	0.438	0.521	N/A
4183	836.6	RMC	Right/Cheek	23.00	22.24	-0.04	1.19	0.421	0.501	N/A
4183	836.6	RMC	Right/Tilt	23.00	22.24	-0.06	1.19	0.386	0.459	N/A
<b>measured / reported SAR numbers - Body (hotspot open, distance 10mm)</b>										
4132	826.4	RMC	Rear Side	23.00	22.09	-0.05	1.23	0.636	0.782	N/A
4183	836.6	RMC		23.00	22.24	-0.05	1.19	0.794	<b>0.945</b>	N/A
4233	846.6	RMC		23.00	21.87	-0.05	1.30	0.622	0.809	N/A
4183	836.6	RMC	Front Side	23.00	22.24	0.07	1.19	0.643	0.765	N/A
4183	836.6	RMC	Left Side	23.00	22.24	-0.09	1.19	0.417	0.496	N/A
4183	836.6	RMC	Right Side	23.00	22.24	-0.05	1.19	0.665	0.791	N/A
N/A	N/A	N/A	Top Side	N/A	N/A	N/A	N/A	N/A	N/A	N/A
4183	836.6	RMC	Bottom Side	23.00	22.24	0.03	1.19	0.671	0.798	N/A
<b>measured / reported SAR numbers – Body worn (distance 5mm)</b>										
4132	826.4	RMC	Rear Side	23.00	22.09	-0.09	1.23	0.784	0.964	N/A
4183	836.6	RMC	Rear Side	23.00	22.24	-0.12	1.19	0.823	<b>0.979</b>	Plot 8
4233	846.6	RMC	Rear Side	23.00	21.87	-0.16	1.30	0.705	0.917	N/A
4132	826.4	RMC	Front Side	23.00	22.09	-0.09	1.23	0.726	0.893	N/A
4183	836.6	RMC	Front Side	23.00	22.24	-0.06	1.19	0.773	0.920	N/A
4233	846.6	RMC	Front Side	23.00	21.87	-0.04	1.30	0.685	0.891	N/A

## Repeated SAR

Ch.	Freq. (MHz)	Time slots	Test Position	Maximum Allowed Power (dBm)	Conducted Power (dBm)	Power drift	Scaling Factor	SAR <sub>1-g</sub> results(W/kg)		Graph Results
								Measured	Reported	
<b>measured / reported SAR numbers - Body (Body-worn, distance 5mm)</b>										
4183	836.6	RMC	Rear Side	23.00	22.24	-0.11	1.19	0.805	0.958	N/A

## Note:

- The value with block color is the maximum Reported SAR Value of each test band.
- Per FCC KDB Publication 447498 D01, if the reported (scaled) SAR measured at the middle channel or highest output power channel for each test configuration is  $\leq 0.8$  W/kg then testing at the other channels is optional for such test configuration(s).
- Per FCC KDB Publication 648474 D04, SAR was evaluated without a headset connected to the device. Since the reported SAR was  $\leq 1.2$  W/kg, no additional SAR evaluations using a headset cable were required.
- When the maximum output power and tune-up tolerance specified for production units in a secondary mode is  $\leq \frac{1}{4}$  dB higher than the primary mode or when the highest reported SAR of the primary mode is scaled by the ratio of specified maximum output power and tune-up tolerance of secondary to primary mode and the adjusted SAR is  $\leq 1.2$  W/kg, SAR measurement is not required for the secondary mode.
- Channel Type RMC states RMC 12.2kbps.



Table 9: SAR Values [WiFi 802.11b/g/n]

Ch.	Freq. (MHz)	Service	Test Position	Maximum Allowed Power (dBm)	Conducted Power (dBm)	Power drift	Scaling Factor	SAR <sub>1-g</sub> results(W/kg)		Graph Results
								Measured	Reported	
<b>measured / reported SAR numbers - Head</b>										
11	2462	DSSS	Left/Cheek	11.00	10.06	-0.03	1.24	0.201	0.249	N/A
11	2462	DSSS	Left/Tilt	11.00	10.06	-0.02	1.24	0.176	0.218	N/A
11	2462	DSSS	Right/Cheek	11.00	10.06	-0.10	1.24	0.242	<b>0.300</b>	Plot 9
11	2462	DSSS	Right/Tilt	11.00	10.06	-0.05	1.24	0.201	0.249	N/A
<b>measured / reported SAR numbers - Body (hotspot open, distance 10mm)</b>										
11	2462	DSSS	Rear Side	11.00	10.06	-0.01	1.24	0.312	<b>0.387</b>	Plot 10
11	2462	DSSS	Front Side	11.00	10.06	-0.05	1.24	0.279	0.346	N/A
11	2462	DSSS	Left Side	11.00	10.06	-0.05	1.24	0.291	0.361	N/A
N/A	N/A	N/A	Right Side	N/A	N/A	N/A	N/A	N/A	N/A	N/A
11	2462	DSSS	Top Side	11.00	10.06	-0.02	1.24	0.40	0.500	N/A
N/A	N/A	N/A	Bottom Side	N/A	N/A	N/A	N/A	N/A	N/A	N/A
<b>measured / reported SAR numbers – Body worn (distance 5mm)</b>										
11	2462	DSSS	Rear Side	11.00	10.06	-0.12	1.24	0.422	0.523	N/A
11	2462	DSSS	Front Side	11.00	10.06	-0.16	1.24	0.262	0.325	N/A

**Note:**

- The value with block color is the maximum Reported SAR Value of each test band.
- Per FCC KDB Publication 447498 D01, if the reported (scaled) SAR measured at the middle channel or highest output power channel for each test configuration is  $\leq 0.8$  W/kg then testing at the other channels is optional for such test configuration(s).
- Per KDB 248227-When the reported SAR of the highest measured maximum output power channel (section 3.1) for the exposure configuration is  $\leq 0.8$  W/kg, no further SAR testing is required for 802.11b DSSS in that exposure configuration, When the reported SAR is  $> 0.8$  W/kg, SAR is required for that exposure configuration using the next highest measured output power channel. When any reported SAR is  $> 1.2$  W/kg, SAR is required for the third channel; i.e., all channels require testing
- Per KDB 248227-SAR is measured using the highest measured maximum output power channel for the initial test configuration.
- Per KDB 248227- Channels with measured maximum output power within  $\frac{1}{4}$  dB of each other are considered to have the same maximum output, When there are multiple test channels with the same measured maximum output power, the channel closest to mid-band frequency is selected for SAR measurement. And when there are multiple test channels with the same measured maximum output power and equal separation from mid-band frequency; for example, high and low channels or two mid-band channels, the higher frequency (number) channel is selected for SAR measurement.
- Per KDB 248227- When the highest reported SAR for DSSS is adjusted by the ratio of OFDM to DSSS specified maximum output power and the adjusted SAR is  $\leq 1.2$  W/kg. (The highest reported SAR for DSSS is adjusted by the ratio of OFDM to DSSS specified maximum output power was **0.308 W/Kg** for Head and **0.439 W/Kg** for Body/Hotspot)

**5.4. SAR Measurement Variability**

According to KDB865664, Repeated measurements are required only when the measured SAR is  $\geq 0.80$  W/kg. If the measured SAR value of the initial repeated measurement is  $< 1.45$  W/kg with  $\leq 20\%$  variation, only one repeated measurement is required to reaffirm that the results are not expected to have substantial variations, which may introduce significant compliance concerns. A second repeated measurement is required only if the measured result for the initial repeated measurement is within 10% of the SAR limit and vary by more than 20%, which are often related to device and measurement setup difficulties. The following procedures are applied to determine if repeated measurements are required. The same procedures should be adapted for measurements according to extremity and occupational exposure limits by applying a factor of 2.5 for extremity exposure and a factor of 5 for occupational exposure to the corresponding SAR thresholds.<sup>19</sup> The repeated measurement results must be clearly identified in the SAR report. All measured SAR, including the repeated results, must be considered to determine compliance and for reporting according to KDB 690783. Repeated measurement is not required when the original highest measured SAR is  $< 0.80$  W/kg; steps 2) through 4) do not apply.

- When the original highest measured SAR is  $\geq 0.80$  W/kg, repeat that measurement once.
- Perform a second repeated measurement only if the ratio of largest to smallest SAR for the original and first repeated measurements is  $> 1.20$  or when the original or repeated measurement is  $\geq 1.45$  W/kg ( $\sim 10\%$  from the 1-g SAR limit).

- 3) Perform a third repeated measurement only if the original, first or second repeated measurement is  $\geq 1.5$  W/kg and the ratio of largest to smallest SAR for the original, first and second repeated measurements is  $> 1.20$ .
- 4) Perform a third repeated measurement only if the original, first or second repeated measurement is  $\geq 1.5$  W/kg and the ratio of largest to smallest SAR for the original, first and second repeated measurements is  $> 1.20$ .

## 5.5. General description of test procedures

1. The DUT is tested using CMU 200 communications testers as controller unit to set test channels and maximum output power to the DUT, as well as for measuring the conducted peak power.
2. Test positions as described in the tables above are in accordance with the specified test standard.
3. Tests in body position were performed in that configuration, which generates the highest time based averaged output power (see conducted power results).
4. Tests in head position with GSM were performed in voice mode with 1 timeslot unless GPRS/EGPRS/DTM function allows parallel voice and data traffic on 2 or more timeslots.
5. UMTS was tested in RMC mode with 12.2 kbit/s and TPC bits set to 'all 1'.
6. WiFi was tested in 802.11b/g/n mode with 1 Mbit/s and 6 Mbit/s. According to KDB 248227 the SAR testing for 802.11g/n is not required since When the highest reported SAR for DSSS is adjusted by the ratio of OFDM to DSSS specified maximum output power and the adjusted SAR is  $\leq 1.2$  W/kg.
7. Required WiFi test channels were selected according to KDB 248227
8. According to FCC KDB pub 248227 D01, Channels with measured maximum output power within  $\frac{1}{4}$  dB of each other are considered to have the same maximum output, When there are multiple test channels with the same measured maximum output power, the channel closest to mid-band frequency is selected for SAR measurement and when there are multiple test channels with the same measured maximum output power and equal separation from mid-band frequency; for example, high and low channels or two mid-band channels, the higher frequency (number) channel is selected for SAR measurement.
9. According to FCC KDB pub 941225 D06 this device has been tested with 10 mm distance to the phantom for operation in WiFi hot spot mode.
10. Per FCC KDB pub 941225 D06 the edges with antennas within 2.5 cm are required to be evaluated for SAR to cover WiFi hot spot function.
11. According to IEEE 1528 the SAR test shall be performed at middle channel. Testing of top and bottom channel is optional.
12. According to KDB 447498 D01 testing of other required channels within the operating mode of a frequency band is not required when the reported 1-g or 10-g SAR for the mid-band or highest output power channel is:
  - $\leq 0.8$  W/kg or 2.0 W/kg, for 1-g or 10-g respectively, when the transmission band is  $\leq 100$  MHz
  - $\leq 0.6$  W/kg or 1.5 W/kg, for 1-g or 10-g respectively, when the transmission band is between 100 MHz and 200 MHz
  - $\leq 0.4$  W/kg or 1.0 W/kg, for 1-g or 10-g respectively, when the transmission band is  $\geq 200$  MHz
13. IEEE 1528-2003 require the middle channel to be tested first. This generally applies to wireless devices that are designed to operate in technologies with tight tolerances for maximum output power variations across channels in the band. When the maximum output power variation across the required test channels is  $> \frac{1}{2}$  dB, instead of the middle channel, the highest output power channel must be used.
14. Per KDB648474 D04 require when the reported SAR for a body-worn accessory, measured without a headset connected to the handset, is  $< 1.2$  W/kg.
15. Per KDB648474 D04 require when the separation distance required for body-worn accessory testing is larger than or equal to that tested for hotspot mode, using the same wireless mode test configuration for voice and data, such as UMTS, LTE and Wi-Fi, and for the same surface of the phone, the hotspot mode SAR data may be used to support body-worn accessory SAR compliance for that particular configuration (surface)
16. 10-g extremity SAR is required only for the surfaces and edges with hotspot mode 1-g SAR  $> 1.2$  W/kg.
17. Per KDB648474 D04 require for phablet SAR test considerations, For smart phones with a display diagonal dimension  $> 15.0$  cm or an overall diagonal dimension  $> 16.0$  cm, When hotspot mode applies, 10-g extremity SAR is required only for the surfaces and edges with hotspot mode 1-g reported SAR  $> 1.2$  W/kg.
18. 10-g extremity SAR is required only for the surfaces and edges with hotspot mode 1-g SAR  $> 1.2$  W/kg.

### 5.6. Measurement Uncertainty for System Check (300MHz-3GHz)

<i>Measurement Uncertainty for System Check (300MHz-3GHz)</i>										
No.	Error Description	Type	Uncertainty Value	Probably Distribution	Div.	(Ci) 1g	(Ci) 10g	Std. Unc. (1g)	Std. Unc. (10g)	Degree of freedom
<b>Measurement System</b>										
1	Probe calibration	B	5.50%	N	1	1	1	5.50%	5.50%	∞
2	Axial isotropy	B	4.70%	R	$\sqrt{3}$	0.7	0.7	1.90%	1.90%	∞
3	Hemispherical isotropy	B	9.60%	R	$\sqrt{3}$	0.7	0.7	3.90%	3.90%	∞
4	Boundary Effects	B	1.00%	R	$\sqrt{3}$	1	1	0.60%	0.60%	∞
5	Probe Linearity	B	4.70%	R	$\sqrt{3}$	1	1	2.70%	2.70%	∞
6	Detection limit	B	1.00%	R	$\sqrt{3}$	1	1	0.60%	0.60%	∞
7	RF ambient conditions-noise	B	0.00%	R	$\sqrt{3}$	1	1	0.00%	0.00%	∞
8	RF ambient conditions-reflection	B	0.00%	R	$\sqrt{3}$	1	1	0.00%	0.00%	∞
9	Response time	B	0.80%	R	$\sqrt{3}$	1	1	0.50%	0.50%	∞
10	Integration time	B	5.00%	R	$\sqrt{3}$	1	1	2.90%	2.90%	∞
11	RF ambient	B	3.00%	R	$\sqrt{3}$	1	1	1.70%	1.70%	∞
12	Probe positioned mech. restrictions	B	0.40%	R	$\sqrt{3}$	1	1	0.20%	0.20%	∞
13	Probe positioning with respect to phantom shell	B	2.90%	R	$\sqrt{3}$	1	1	1.70%	1.70%	∞
14	Max.SAR evaluation	B	3.90%	R	$\sqrt{3}$	1	1	2.30%	2.30%	∞
<b>Test Sample Related</b>										
15	Test sample positioning	A	1.80%	N	1	1	1	1.80%	1.80%	∞
16	Device holder uncertainty	A	1.70%	N	1	1	1	1.70%	1.70%	∞
17	Drift of output power	B	5.00%	R	$\sqrt{3}$	1	1	2.90%	2.90%	∞
<b>Phantom and Set-up</b>										
18	Phantom uncertainty	B	4.00%	R	$\sqrt{3}$	1	1	2.30%	2.30%	∞
19	Liquid conductivity (target)	B	5.00%	R	$\sqrt{3}$	0.64	0.43	1.80%	1.20%	∞
20	Liquid conductivity (meas.)	A	0.44%	N	1	0.64	0.43	0.28%	0.19%	∞
21	Liquid permittivity (target)	B	5.00%	R	$\sqrt{3}$	0.64	0.43	1.80%	1.20%	∞
22	Liquid cpermittivity	A	0.12%	N	1	0.64	0.43	0.05%	0.05%	∞

	(meas.)									
Combined standard uncertainty	$u_c = \sqrt{\sum_{i=1}^{22} c_i^2 u_i^2}$	/	/	/	/	/	10.12%	9.97%	$\infty$	
Expanded uncertainty (confidence interval of 95 %)	$u_e = 2u_c$	/	R	K=2	/	/	20.24%	19.94%	$\infty$	

## 5.7. System Check Results

### System Performance Check at 835 MHz Head

DUT: Dipole 835 MHz; Type: D835V2; Serial: 4d134

Date/Time: 02/06/2015 AM

Communication System: CW; Frequency: 835 MHz; Duty Cycle: 1:1

Medium parameters used (interpolated):  $f = 835$  MHz;  $\sigma = 0.91$  S/m;  $\epsilon_r = 41.61$ ;  $\rho = 1000$  kg/m<sup>3</sup>

Phantom section: Flat Section

DASY5 Configuration:

Probe: ES3DV3 – SN3292; ConvF(6.23,6.23, 6.23); Calibrated: 08/15/2014;

Sensor-Surface: 3mm (Mechanical Surface Detection)

Electronics: DAE4 Sn1315; Calibrated: 07/22/2014;

Phantom: SAM 1; Type: SAM;

Measurement SW: DASY52, Version 52.8 (2); SEMCAD X Version 14.6.5 (6469)

**Area Scan (71x71x1):** Measurement grid: dx=15.00 mm, dy=15.00 mm

Maximum value of SAR (interpolated) = 10.3 W/Kg

**Zoom Scan (7x7x7)/Cube 0:** Measurement grid: dx=5mm, dy=5mm, dz=5mm

Reference Value = 100.3 V/m; Power Drift = -0.03 dB

Peak SAR (extrapolated) = 11.40 W/kg

**SAR(1 g) = 9.60 W/Kg; SAR(10 g) = 6.25 W/Kg**

Maximum value of SAR (measured) = 11.3 W/Kg

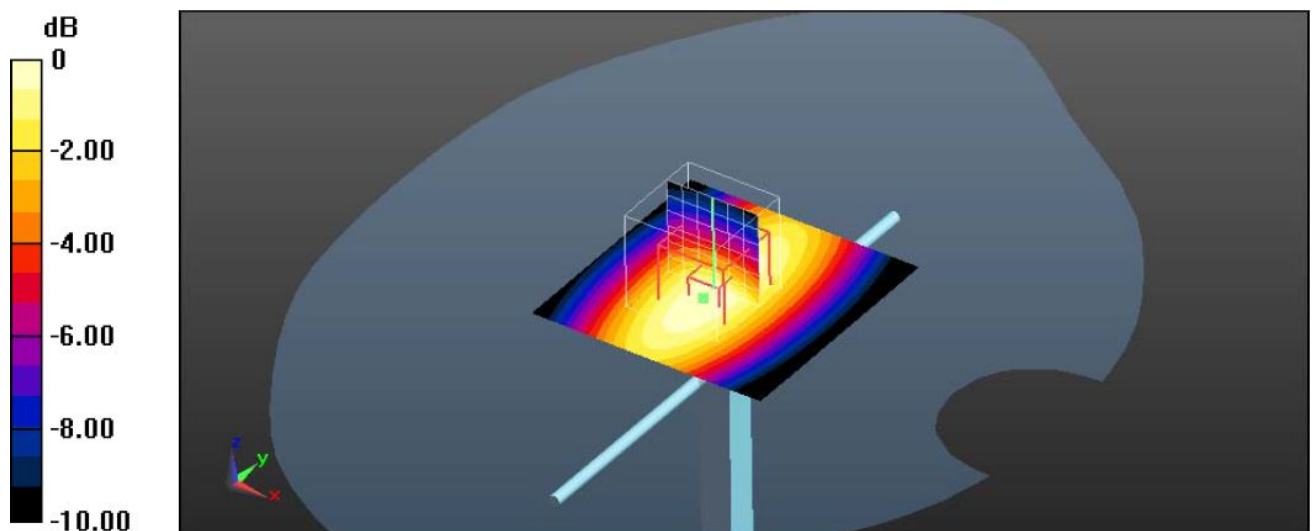

0 dB = 11.3 W/Kg

System Performance Check 835MHz Head 1000 mW

**System Performance Check at 835 MHz Body**

DUT: Dipole 835 MHz; Type: D835V2; Serial: 4d134

Date/Time: 03/06/2015 PM

Communication System: CW; Frequency: 835 MHz; Duty Cycle: 1:1

Medium parameters used (interpolated):  $f = 835$  MHz;  $\sigma = 0.99$  S/m;  $\epsilon_r = 53.51$ ;  $\rho = 1000$  kg/m<sup>3</sup>

Phantom section: Flat Section

DASY5 Configuration:

Probe: ES3DV3 – SN3292; ConvF(6.11,6.11, 6.11); Calibrated: 08/15/2014;

Sensor-Surface: 3mm (Mechanical Surface Detection)

Electronics: DAE4 Sn1315; Calibrated: 07/22/2014;

Phantom: SAM 1; Type: SAM;

Measurement SW: DASY52, Version 52.8 (2); SEMCAD X Version 14.6.5 (6469)

**Area Scan (71x71x1):** Measurement grid: dx=15.00 mm, dy=15.00 mm

Maximum value of SAR (interpolated) = 10.3 W/Kg

**Zoom Scan (7x7x7)/Cube 0:** Measurement grid: dx=5mm, dy=5mm, dz=5mm

Reference Value = 109.9 V/m; Power Drift = -0.01 dB

Peak SAR (extrapolated) = 13.1 W/kg

**SAR(1 g) = 9.63 W/Kg; SAR(10 g) = 6.44 W/Kg**

Maximum value of SAR (measured) = 10.8 W/Kg

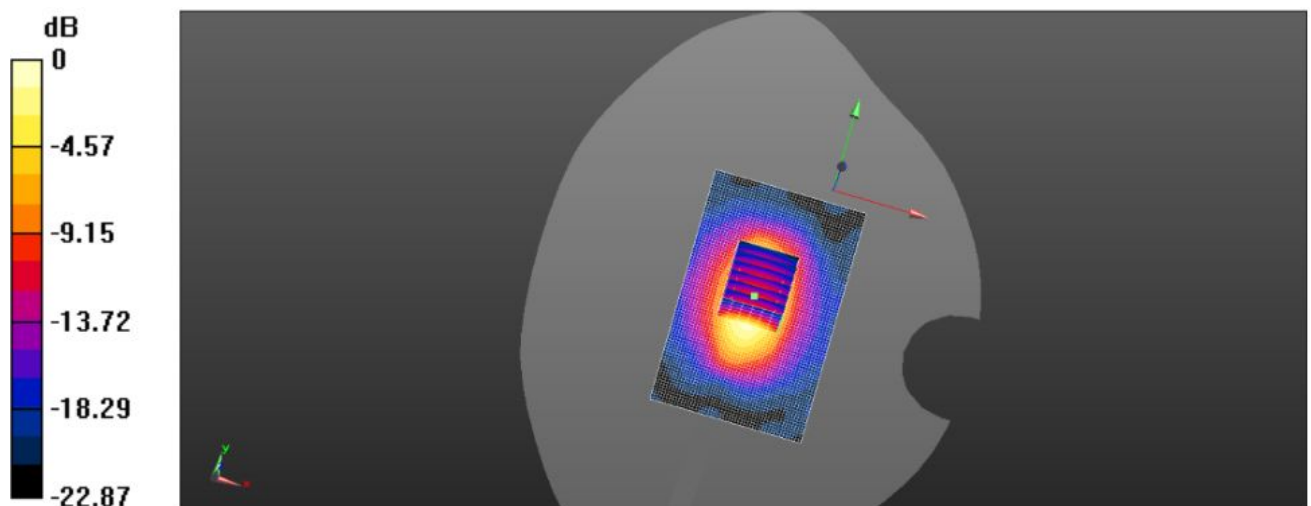

0 dB = 10.80 W/Kg

System Performance Check 835MHz Body 1000mW

**System Performance Check at 1900 MHz Head**

DUT: Dipole 1900 MHz; Type: D1900V2; Serial: 5d072

Date/Time: 04/06/2015 AM

Communication System: CW; Frequency: 1900 MHz; Duty Cycle: 1:1

Medium parameters used (interpolated):  $f = 1900$  MHz;  $\sigma = 1.45$  S/m;  $\epsilon_r = 39.88$ ;  $\rho = 1000$  kg/m<sup>3</sup>

Phantom section: Flat Section

DASY5 Configuration:

Probe: ES3DV3 – SN3292; ConvF(5.03,5.03, 5.03); Calibrated: 08/15/2014;

Sensor-Surface: 3mm (Mechanical Surface Detection)

Electronics: DAE4 Sn1315; Calibrated: 07/22/2014;

Phantom: SAM 1; Type: SAM;

Measurement SW: DASY52, Version 52.8 (1); SEMCAD X Version 14.6.5 (6469)

**Area Scan (71x71x71):** Measurement grid: dx=15.00 mm, dy=15.00 mm

Maximum value of SAR (interpolated) = 48.9 W/Kg

**Zoom Scan (7x7x7)/Cube 0:** Measurement grid: dx=5mm, dy=5mm, dz=5mm

Reference Value = 178.7 V/m; Power Drift = -0.02 dB

Peak SAR (extrapolated) = 69.8 W/Kg

**SAR(1 g) = 38.90 W/Kg; SAR(10 g) = 20.60 W/Kg**

Maximum value of SAR (measured) = 44.2 W/Kg

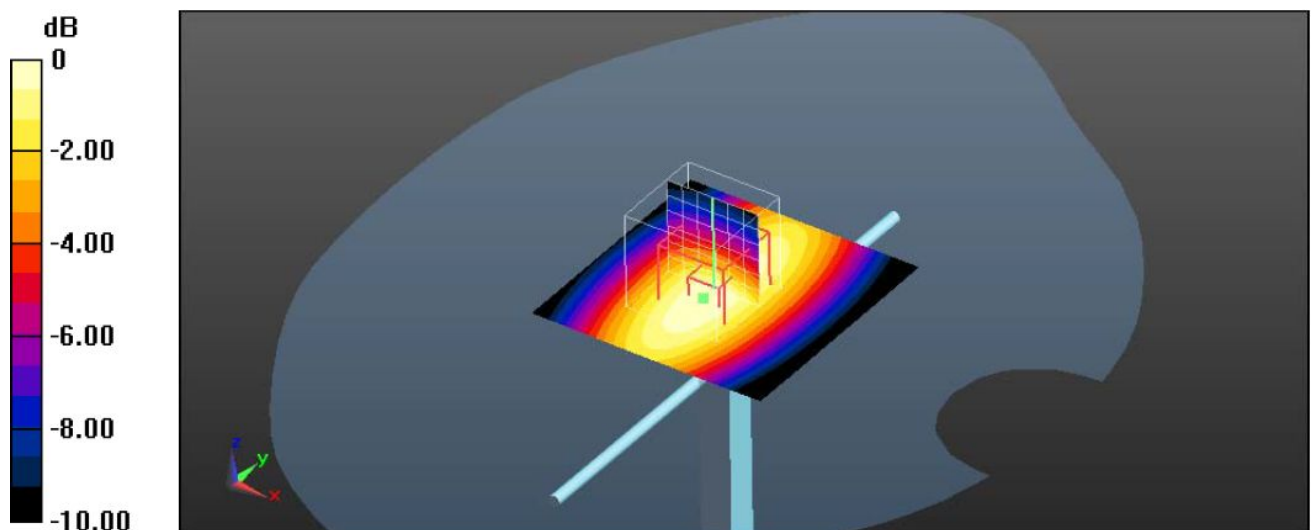

0 dB = 44.20 W/Kg

System Performance Check 1900MHz Body 1000mW

**System Performance Check at 1900 MHz Body**

DUT: Dipole 1900 MHz; Type: D1900V2; Serial: 5d072

Date/Time: 05/06/2015 PM

Communication System: CW; Frequency: 1900 MHz; Duty Cycle: 1:1

Medium parameters used (interpolated):  $f = 1900$  MHz;  $\sigma = 1.53$  S/m;  $\epsilon_r = 53.10$ ;  $\rho = 1000$  kg/m<sup>3</sup>

Phantom section: Flat Section

DASY5 Configuration:

Probe: ES3DV3 – SN3292; ConvF(4.66,4.66, 4.66); Calibrated: 08/15/2014;

Sensor-Surface: 3mm (Mechanical Surface Detection)

Electronics: DAE4 Sn1315; Calibrated: 07/22/2014;

Phantom: SAM 1; Type: SAM;

Measurement SW: DASY52, Version 52.8 (1); SEMCAD X Version 14.6.5 (6469)

**Area Scan (71x71x71):** Measurement grid: dx=15.00 mm, dy=15.00 mm

Maximum value of SAR (interpolated) = 51.50 W/Kg

**Zoom Scan (7x7x7)/Cube 0:** Measurement grid: dx=5mm, dy=5mm, dz=5mm

Reference Value = 175.60 V/m; Power Drift = 0.02 dB

Peak SAR (extrapolated) = 59.8 W/Kg

**SAR(1 g) = 39.10 W/Kg; SAR(10 g) = 20.80 W/Kg**

Maximum value of SAR (measured) = 45.20 W/Kg

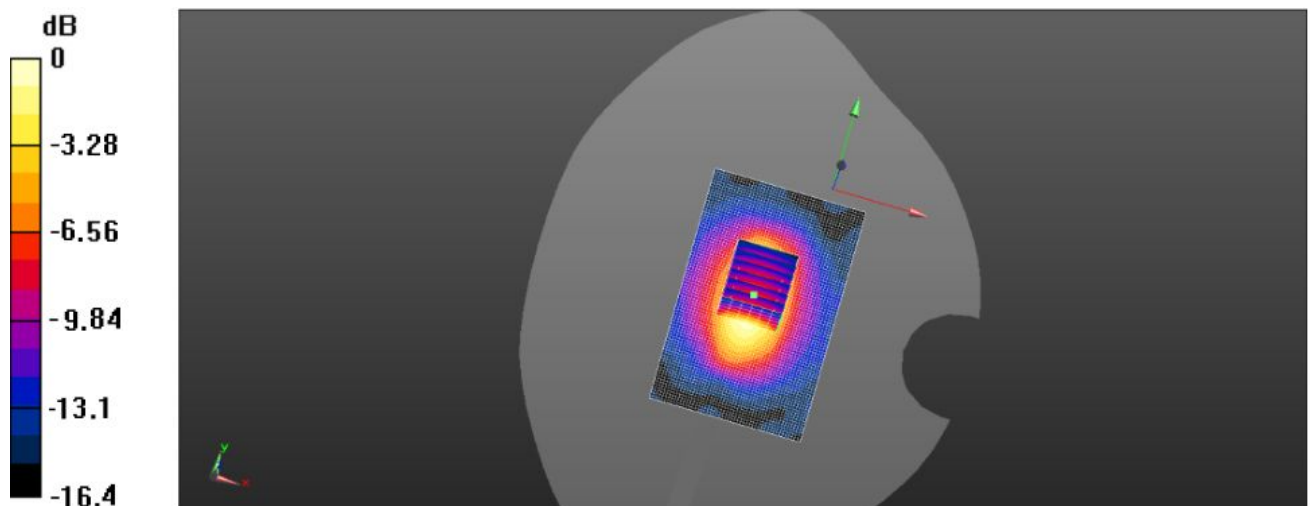

0 dB = 45.20 W/Kg

System Performance Check 1900MHz Body 1000mW



**System Performance Check at 2450 MHz Head**

DUT: Dipole 2450 MHz; Type: D2450V2; Serial: 884

Date/Time: 06/06/2015 AM

Communication System: CW; Frequency: 2450 MHz; Duty Cycle: 1:1

Medium parameters used (interpolated):  $f = 2450$  MHz;  $\sigma = 1.86$  S/m;  $\epsilon_r = 39.25$ ;  $\rho = 1000$  kg/m<sup>3</sup>

Phantom section: Flat Section

DASY5 Configuration:

Probe: ES3DV3 – SN3292; ConvF(4.43,4.43, 4.43); Calibrated: 08/15/2014;

Sensor-Surface: 3mm (Mechanical Surface Detection)

Electronics: DAE4 Sn1315; Calibrated: 07/22/2014;

Phantom: SAM 1; Type: SAM;

Measurement SW: DASY52, Version 52.8 (1); SEMCAD X Version 14.6.5 (6469)

**Area Scan (71x71x71):** Measurement grid: dx=15.00 mm, dy=15.00 mm

Maximum value of SAR (interpolated) = 63.8 W/Kg

**Zoom Scan (7x7x7)/Cube 0:** Measurement grid: dx=5mm, dy=5mm, dz=5mm

Reference Value = 188.8 V/m; Power Drift = -0.11 dB

Peak SAR (extrapolated) = 120.10 W/Kg

**SAR(1 g) = 25.10 W/Kg; SAR(10 g) = 54.10 W/Kg**

Maximum value of SAR (measured) = 61.9 W/Kg

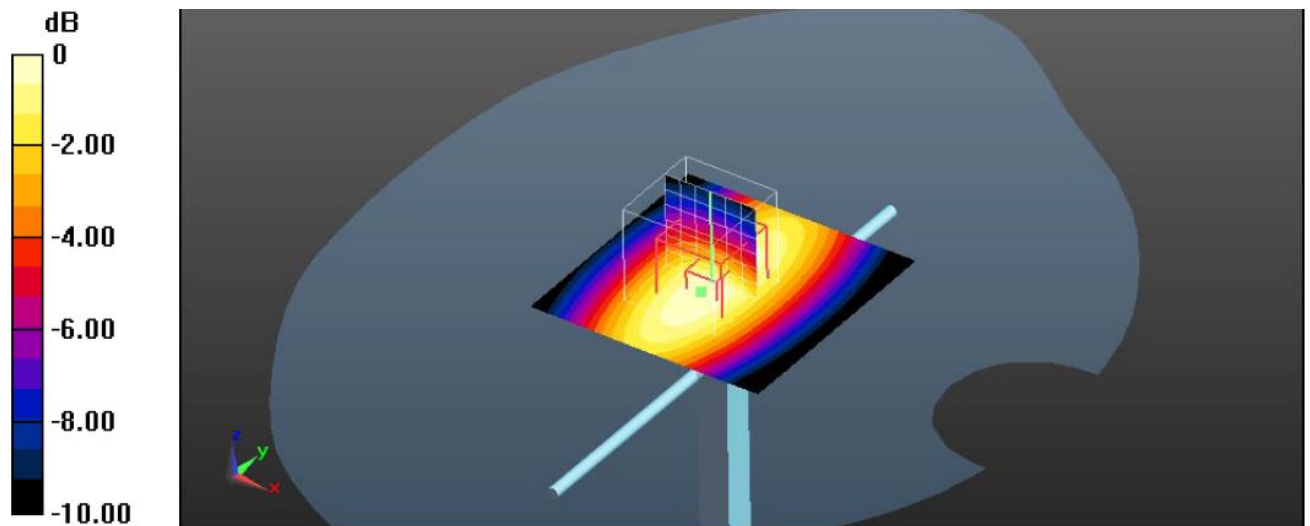

0 dB = 61.9 W/Kg

System Performance Check 2450MHz Head 1000mW

**System Performance Check at 2450 MHz Body**

DUT: Dipole 2450 MHz; Type: D2450V2; Serial: 884

Date/Time: 07/06/2015 PM

Communication System: CW; Frequency: 2450 MHz; Duty Cycle: 1:1

Medium parameters used (interpolated):  $f = 2450$  MHz;  $\sigma = 2.03$  S/m;  $\epsilon_r = 52.70$ ;  $\rho = 1000$  kg/m<sup>3</sup>

Phantom section: Flat Section

DASY5 Configuration:

Probe: ES3DV3 – SN3292; ConvF(4.23,4.23, 4.23); Calibrated: 08/15/2014;

Sensor-Surface: 3mm (Mechanical Surface Detection)

Electronics: DAE4 Sn1315; Calibrated: 07/22/2014;

Phantom: SAM 1; Type: SAM;

Measurement SW: DASY52, Version 52.8 (1); SEMCAD X Version 14.6.5 (6469)

**Area Scan (71x71x71):** Measurement grid: dx=15.00 mm, dy=15.00 mm

Maximum value of SAR (interpolated) = 66.2 W/Kg

**Zoom Scan (7x7x7)/Cube 0:** Measurement grid: dx=5mm, dy=5mm, dz=5mm

Reference Value = 176.6 V/m; Power Drift = -0.06 dB

Peak SAR (extrapolated) = 111.6 W/Kg

**SAR(1 g) = 53.00 W/Kg; SAR(10 g) = 24.30 W/Kg**

Maximum value of SAR (measured) = 60.9 W/Kg

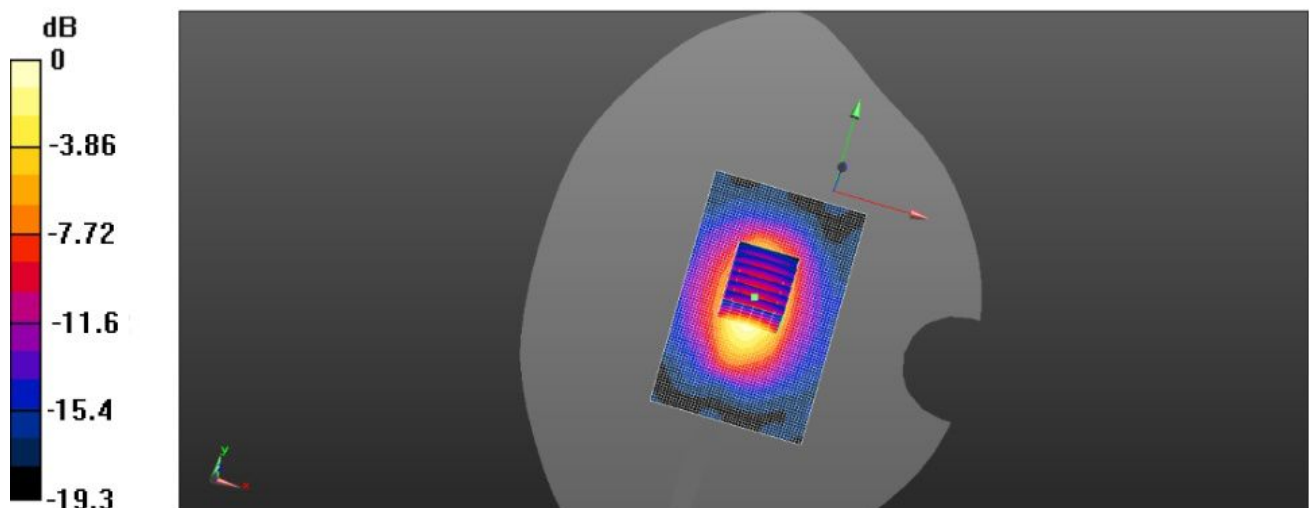

0 dB = 60.9 W/Kg

System Performance Check 2450MHz Body 1000mW

## 5.8. SAR Test Graph Results

SAR plots for **the highest measured SAR** in each exposure configuration, wireless mode and frequency band combination according to FCC KDB 865664 D02

### GSM850 Left Head Cheek Middle Channel

Communication System: Customer System; Frequency: 836.6 MHz; Duty Cycle: 1:8

Medium parameters used (interpolated):  $f = 836.6$  MHz;  $\sigma = 0.91$  S/m;  $\epsilon_r = 41.61$ ;  $\rho = 1000$  kg/m<sup>3</sup>

Phantom section : Left Section

Probe: ES3DV3 – SN3292; ConvF(6.23,6.23, 6.23); Calibrated: 08/15/2014;

Sensor-Surface: 3mm (Mechanical Surface Detection)

Electronics: DAE4 Sn1315; Calibrated: 07/22/2014;

Measurement SW: DASY52, Version 52.8 (2); SEMCAD X Version 14.6.6 (6824)

**Area Scan (91x121x1):** Measurement grid: dx=15.0 mm, dy=15.0 mm

Maximum value of SAR (interpolated) = 0.354 W/Kg

**Zoom Scan (7x7x7)/Cube 0:** Measurement grid: dx=5mm, dy=5mm, dz=5mm

Reference Value = 6.421 V/m; Power Drift = -0.03 dB

Peak SAR (extrapolated) = 0.523 W/Kg

**SAR(1 g) = 0.384 W/Kg; SAR(10 g) = 0.219 W/Kg**

Maximum value of SAR (measured) = 0.510 W/Kg

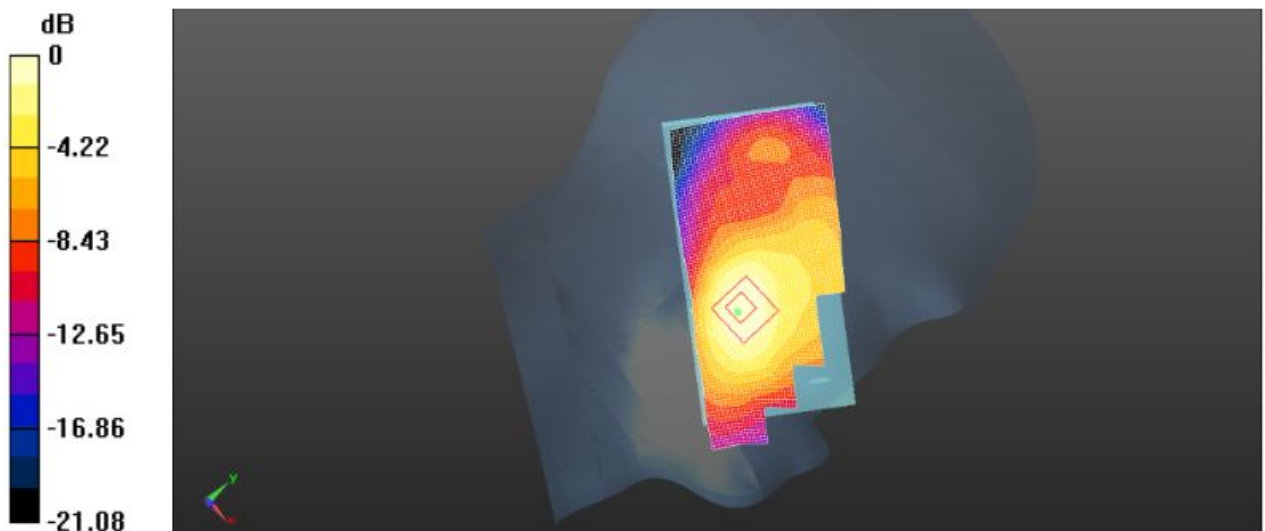

0 dB = 0.510 W/Kg

Plot 1: Left Head Cheek (GSM850 Middle Channel)

**GSM850 Body –Worn(Voice) Middle Channel**

Communication System: Customer System; Frequency: 836.6 MHz;Duty Cycle:1:8

Medium parameters used (interpolated):  $f = 836.6$  MHz;  $\sigma = 0.99$  S/m;  $\epsilon_r = 53.51$ ;  $\rho = 1000$  kg/m<sup>3</sup>

Phantom section : Body- worn

Probe: ES3DV3 – SN3292; ConvF(6.11,6.11, 6.11); Calibrated: 08/15/2014;

Sensor-Surface: 3mm (Mechanical Surface Detection)

Electronics: DAE4 Sn1315; Calibrated: 07/22/2014;

Phantom: SAM 1; Type: SAM;

Measurement SW: DASY52, Version 52.8 (2); SEMCAD X Version 14.6.6 (6824)

**Area Scan (101x111x1):** Measurement grid: dx=15.0 mm, dy=15.0 mm

Maximum value of SAR (interpolated) = 0.810 W/kg

**Zoom Scan (7x7x7)/Cube 0:** Measurement grid: dx=5mm, dy=5mm, dz=5mm

Reference Value = 28.570 V/m; Power Drift = -0.03 dB

Peak SAR (extrapolated) = 0.915 W/kg

**SAR(1 g) = 0.723 W/kg; SAR(10 g) = 0.484 W/kg**

Maximum value of SAR (measured) = 0.815 W/kg

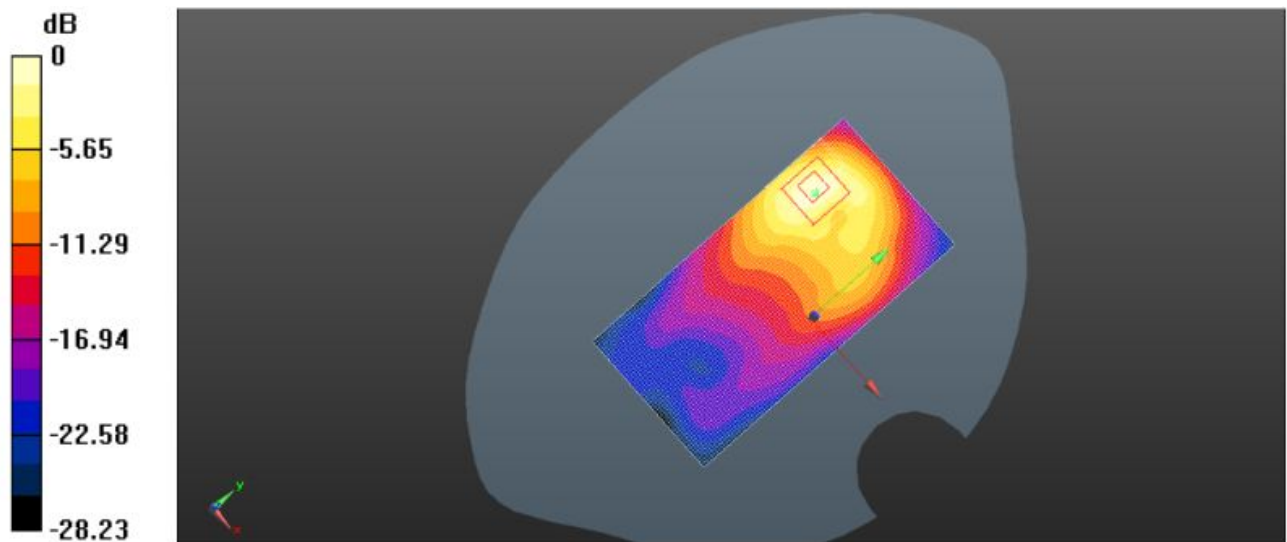

0dB = 0.815W/kg

Plot 2: Body Rear Side (GSM850 Body –Worn(Voice) Middle Channel)

**GSM1900 Left Head Cheek Middle Channel**

Communication System: Customer System; Frequency: 1880.0 MHz; Duty Cycle: 1:8

Medium parameters used (interpolated):  $f = 1880.0$  MHz;  $\sigma = 1.45$  S/m;  $\epsilon_r = 39.97$ ;  $\rho = 1000$  kg/m<sup>3</sup>

Phantom section : Left Section

Probe: ES3DV3 – SN3292; ConvF(5.03,5.03, 5.03); Calibrated: 08/15/2014;

Sensor-Surface: 3mm (Mechanical Surface Detection)

Electronics: DAE4 Sn1315; Calibrated: 07/22/2014;

Phantom: SAM 1; Type: SAM;

Measurement SW: DASY52, Version 52.8 (2); SEMCAD X Version 14.6.6 (6824)

**Area Scan (91x121x1):** Measurement grid: dx=15.0 mm, dy=15.0 mm

Maximum value of SAR (interpolated) = 0.479 W/Kg

**Zoom Scan (7x7x7)/Cube 0:** Measurement grid: dx=5mm, dy=5mm, dz=5mm

Reference Value = 4.293 V/m; Power Drift = -0.08 dB

Peak SAR (extrapolated) = 0.611 W/Kg

**SAR(1 g) = 0.398 W/Kg; SAR(10 g) = 0.236 W/Kg**

Maximum value of SAR (measured) = 0.587 W/Kg

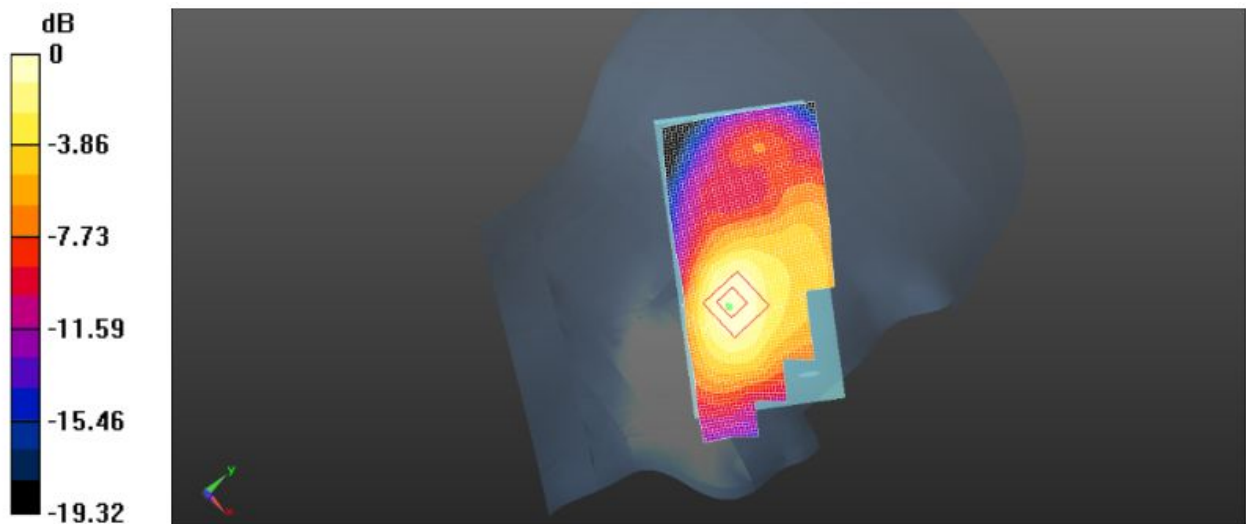

0dB = 0.587 W/kg

Plot 3: Left Head Cheek (GSM1900 Middle Channel)

**GSM1900 Body –Worn(Voice) Middle Channel**

Communication System: Customer System; Frequency: 1880.0 MHz;Duty Cycle:1:8

Medium parameters used (interpolated):  $f = 1880.0$  MHz;  $\sigma = 1.50$  S/m;  $\epsilon_r = 53.10$ ;  $\rho = 1000$  kg/m<sup>3</sup>

Phantom section : Body- worn

Probe: ES3DV3 – SN3292; ConvF(4.66,4.66, 4.66); Calibrated: 08/15/2014;

Sensor-Surface: 3mm (Mechanical Surface Detection)

Electronics: DAE4 Sn1315; Calibrated: 07/22/2014;

Phantom: SAM 1; Type: SAM;

Measurement SW: DASY52, Version 52.8 (2); SEMCAD X Version 14.6.6 (6824)

**Area Scan (91x121x1):** Measurement grid: dx=15.0 mm, dy=15.0 mm

Maximum value of SAR (interpolated) = 0.661 W/Kg

**Zoom Scan (7x7x7)/Cube 0:** Measurement grid: dx=5mm, dy=5mm, dz=5mm

Reference Value = 10.409 V/m; Power Drift = -0.13dB

Peak SAR (extrapolated) = 0.891 W/Kg

**SAR(1 g) = 0.803 W/Kg; SAR(10 g) = 0.603 W/Kg**

Maximum value of SAR (measured) = 0.891 W/Kg

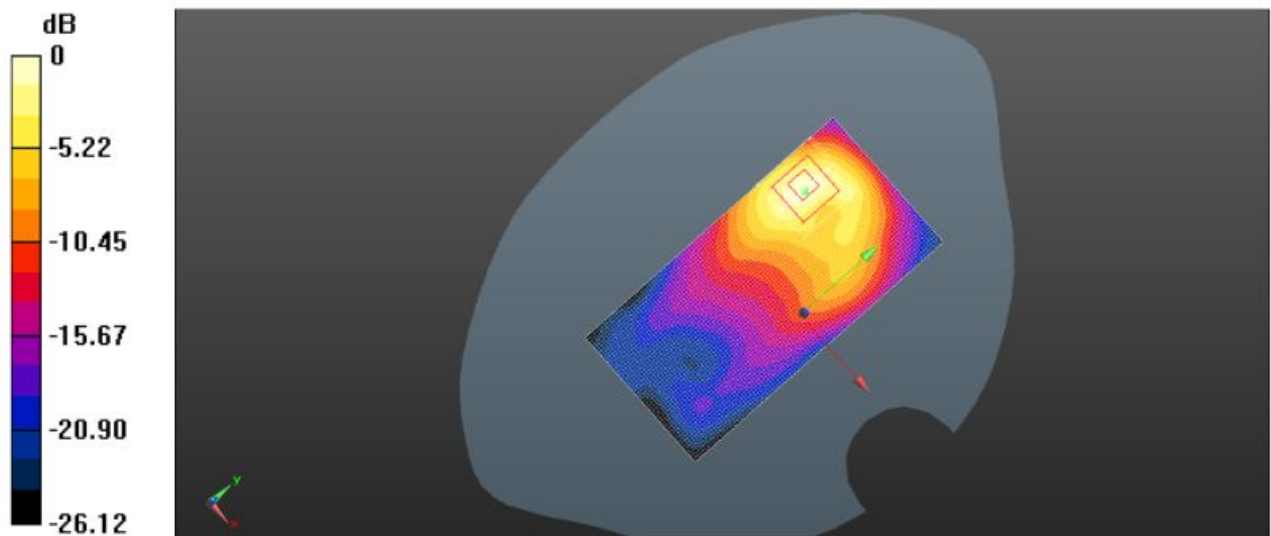

0dB = 0.891 W/Kg

Plot 4: Body Rear Side (GSM1900 Body –Worn(Voice) Middle Channel)

**UMTS Band II Left Head Cheek Middle Channel**

Communication System: Customer System; Frequency: 1880.0 MHz; Duty Cycle: 1:1

Medium parameters used (interpolated):  $f = 1880.0$  MHz;  $\sigma = 1.45$  S/m;  $\epsilon_r = 39.97$ ;  $\rho = 1000$  kg/m<sup>3</sup>

Phantom section : Left Section

Probe: ES3DV3 – SN3292; ConvF(5.03,5.03, 5.03); Calibrated: 08/15/2014;

Sensor-Surface: 3mm (Mechanical Surface Detection)

Electronics: DAE4 Sn1315; Calibrated: 07/22/2014;

Phantom: SAM 1; Type: SAM;

Measurement SW: DASY52, Version 52.8 (2); SEMCAD X Version 14.6.6 (6824)

**Area Scan (91x121x1):** Measurement grid: dx=15.0 mm, dy=15.0 mm

Maximum value of SAR (interpolated) = 0.492 W/Kg

**Zoom Scan (7x7x7)/Cube 0:** Measurement grid: dx=5mm, dy=5mm, dz=5mm

Reference Value = 8.081 V/m; Power Drift = -0.03 dB

Peak SAR (extrapolated) = 0.611 W/Kg

**SAR(1 g) = 0.516 W/Kg; SAR(10 g) = 0.354 W/Kg**

Maximum value of SAR (measured) = 0.695 W/Kg

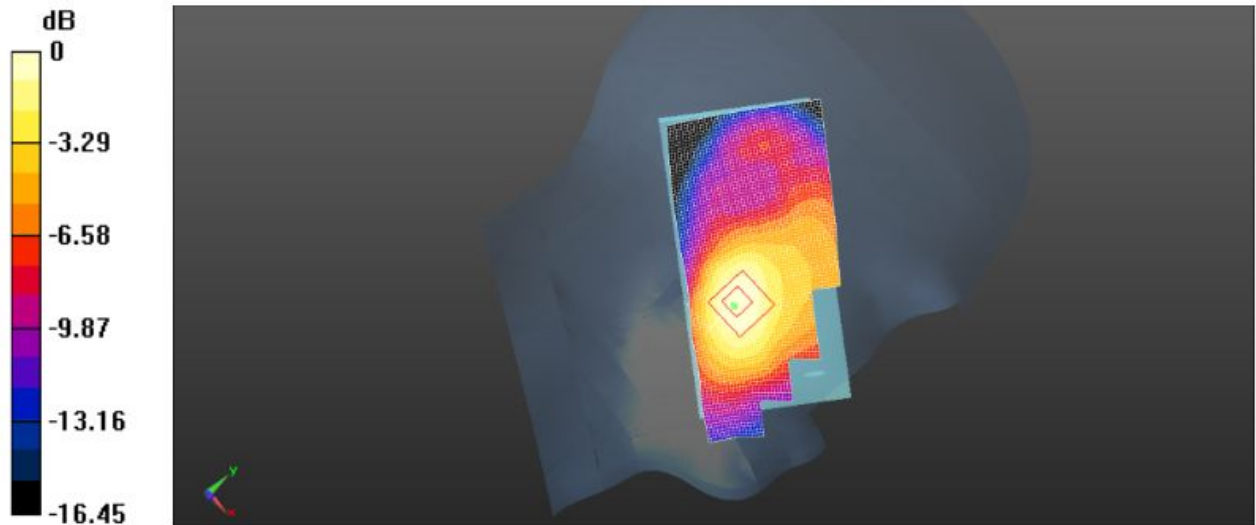

0dB = 0.695 W/kg

Plot 5: Left Head Cheek (UMTS Band II Middle Channel)

**UMTS Band II Body-Worn Middle Channel**

Communication System: Customer System; Frequency: 1880.0 MHz; Duty Cycle: 1:1

Medium parameters used (interpolated):  $f = 1880.0$  MHz;  $\sigma = 1.50$  S/m;  $\epsilon_r = 53.10$ ;  $\rho = 1000$  kg/m<sup>3</sup>

Phantom section : Body- worn

Probe: ES3DV3 – SN3292; ConvF(4.66,4.66, 4.66); Calibrated: 08/15/2014;

Sensor-Surface: 3mm (Mechanical Surface Detection)

Electronics: DAE4 Sn1315; Calibrated: 07/22/2014;

Phantom: SAM 1; Type: SAM;

Measurement SW: DASY52, Version 52.8 (2); SEMCAD X Version 14.6.6 (6824)

**Area Scan (91x121x1):** Measurement grid: dx=15.0 mm, dy=15.0 mm

Maximum value of SAR (interpolated) = 0.975 W/Kg

**Zoom Scan (7x7x7)/Cube 0:** Measurement grid: dx=5mm, dy=5mm, dz=5mm

Reference Value = 15.506 V/m; Power Drift = -0.05 dB

Peak SAR (extrapolated) = 1.258 W/Kg

**SAR(1 g) = 0.923 W/Kg; SAR(10 g) = 0.697W/Kg**

Maximum value of SAR (measured) = 0.998 W/Kg

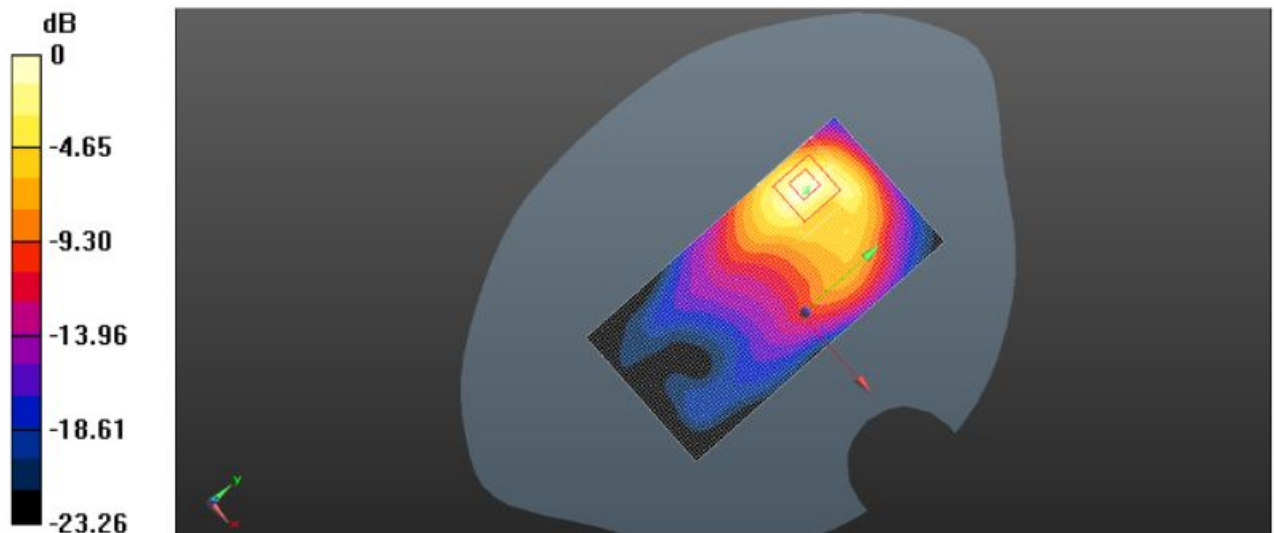

0dB = 0.998 W/Kg

Plot 6: Body Rear Side (UMTS Band II Body-Worn Middle Channel)



**UMTS Band V Left Head Cheek Middle Channel**

Communication System: Customer System; Frequency: 836.6 MHz; Duty Cycle: 1:1

Medium parameters used (interpolated):  $f = 836.6$  MHz;  $\sigma = 0.91$  S/m;  $\epsilon_r = 41.61$ ;  $\rho = 1000$  kg/m<sup>3</sup>

Phantom section : Left Section

Probe: ES3DV3 – SN3292; ConvF(6.23,6.23, 6.23); Calibrated: 08/15/2014;

Sensor-Surface: 3mm (Mechanical Surface Detection)

Electronics: DAE4 Sn1315; Calibrated: 07/22/2014;

Measurement SW: DASY52, Version 52.8 (2); SEMCAD X Version 14.6.6 (6824)

**Area Scan (91x121x1):** Measurement grid: dx=15.0 mm, dy=15.0 mm

Maximum value of SAR (interpolated) = 0.604 W/Kg

**Zoom Scan (7x7x7)/Cube 0:** Measurement grid: dx=5mm, dy=5mm, dz=5mm

Reference Value = 9.548 V/m; Power Drift = -0.04 dB

Peak SAR (extrapolated) = 0.680 W/Kg

**SAR(1 g) = 0.481 W/Kg; SAR(10 g) = 0.324 W/Kg**

Maximum value of SAR (measured) = 0.649 W/Kg

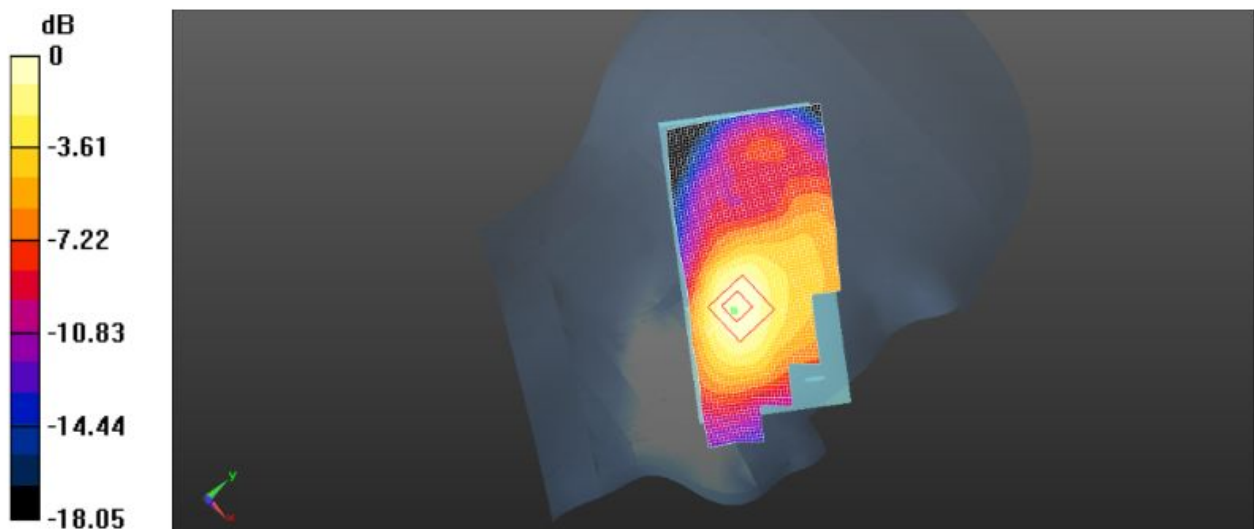

0 dB = 0.649 W/Kg

Plot 7: Left Head Cheek (UMTS Band V Middle Channel)

**UMTS Band V Body-Worn Middle Channel**

Communication System: Customer System; Frequency: 836.6 MHz; Duty Cycle: 1:1

Medium parameters used (interpolated):  $f = 836.6$  MHz;  $\sigma = 0.99$  S/m;  $\epsilon_r = 53.51$ ;  $\rho = 1000$  kg/m<sup>3</sup>

Phantom section : Body- worn

Probe: ES3DV3 – SN3292; ConvF(6.11,6.11, 6.11); Calibrated: 08/15/2014;

Sensor-Surface: 3mm (Mechanical Surface Detection)

Electronics: DAE4 Sn1315; Calibrated: 07/22/2014;

Phantom: SAM 1; Type: SAM;

Measurement SW: DASY52, Version 52.8 (2); SEMCAD X Version 14.6.6 (6824)

**Area Scan (101x111x1):** Measurement grid: dx=15.0 mm, dy=15.0 mm

Maximum value of SAR (interpolated) = 0.948 W/kg

**Zoom Scan (7x7x7)/Cube 0:** Measurement grid: dx=5mm, dy=5mm, dz=5mm

Reference Value = 30.590 V/m; Power Drift = -0.12 dB

Peak SAR (extrapolated) = 1.09 W/Kg

**SAR(1 g) = 0.823 W/Kg; SAR(10 g) = 0.523 W/Kg**

Maximum value of SAR (measured) = 0.974 W/Kg

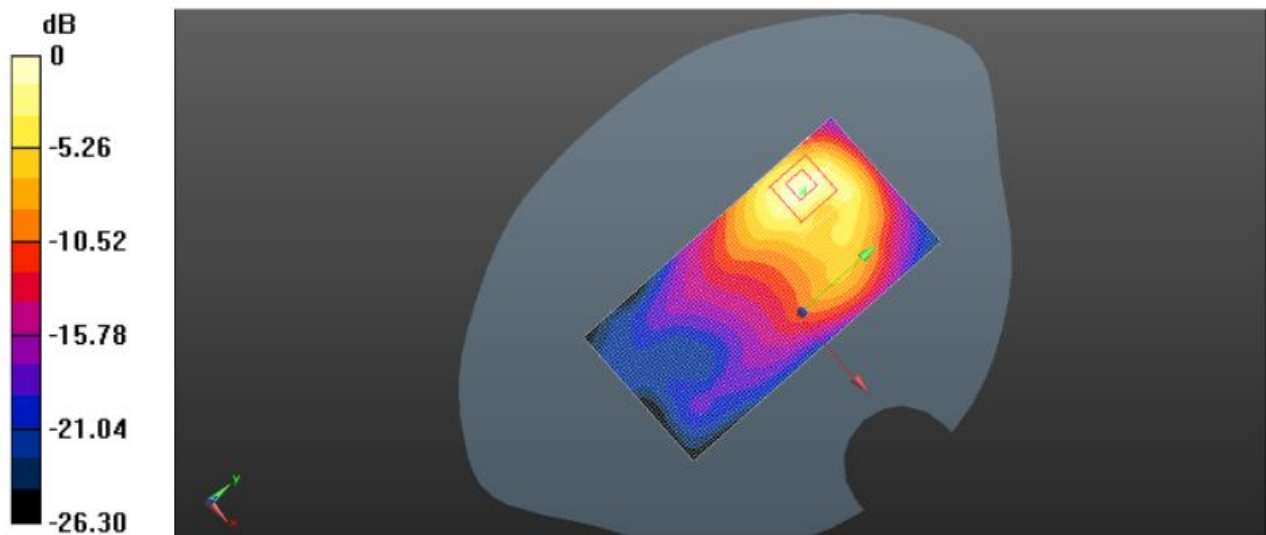

0dB = 0.974 W/kg

Plot 8: Body Rear Side (UMTS Band V Body-Worn Middle Channel)

**WiFi2450 Right Head Cheek Middle Channel (WiFi2450 Middle Channel-Channel 11-2462MHz (1Mbps))**

Communication System: Customer System; Frequency: 2462.0 MHz; Duty Cycle: 1:1

Medium parameters used (interpolated):  $f = 2462.0$  MHz;  $\sigma = 1.79$  S/m;  $\epsilon_r = 39.46$ ;  $\rho = 1000$  kg/m<sup>3</sup>

Phantom section : Right Section

Probe: ES3DV3 – SN3292; ConvF(4.43,4.43, 4.43); Calibrated: 08/15/2014;

Sensor-Surface: 3mm (Mechanical Surface Detection)

Electronics: DAE4 Sn1315; Calibrated: 07/22/2014;

Phantom: SAM 1; Type: SAM;

Measurement SW: DASY52, Version 52.8 (2); SEMCAD X Version 14.6.6 (6824)

**Area Scan (91x121x1):** Measurement grid: dx=1.50 mm, dy=1.50 mm

Maximum value of SAR (interpolated) = 0.487 W/Kg

**Zoom Scan (7x7x7)/Cube 0:** Measurement grid: dx=5mm, dy=5mm, dz=5mm

Reference Value = 6.322 V/m; Power Drift = -0.10 dB

Peak SAR (extrapolated) = 0.389 W/Kg

**SAR(1 g) = 0.242 W/Kg; SAR(10 g) = 0.274 W/Kg**

Maximum value of SAR (measured) = 0.344 W/Kg

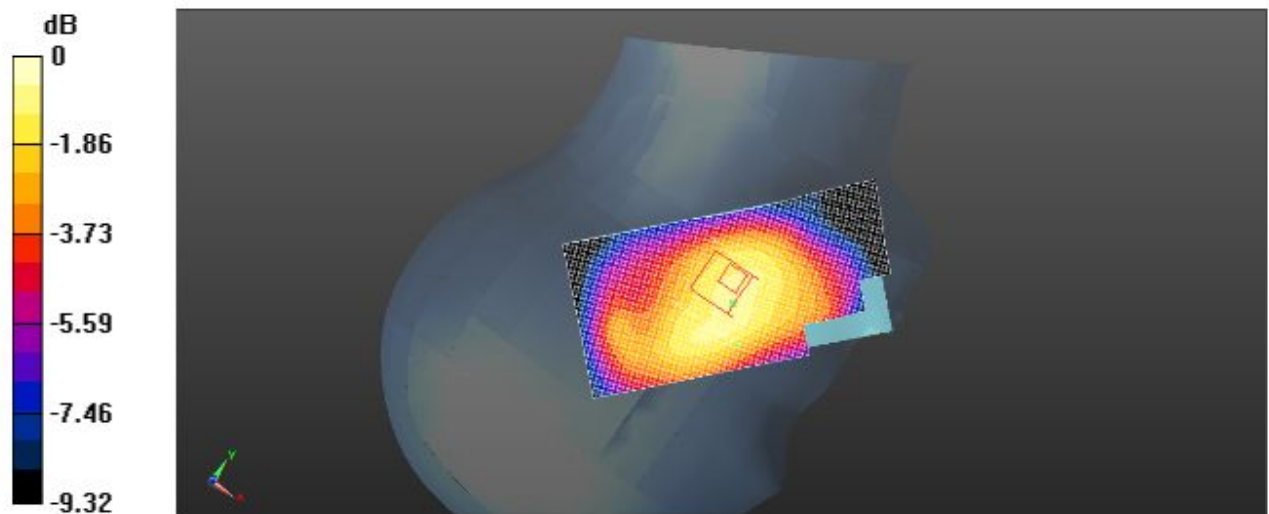

0 dB = 0.344 W/Kg

Plot 9: Right Head Cheek (WiFi2450 Middle Channel-Channel 11-2462MHz (1Mbps))

**WiFi2450 Body Hotspot Middle Channel (WiFi2450 Middle Channel-Channel 11-2462MHz (1Mbps))**

Communication System: Customer System; Frequency: 2462.0 MHz;Duty Cycle:1:1

Medium parameters used (interpolated):  $f = 2462.0$  MHz;  $\sigma = 2.00$  S/m;  $\epsilon_r = 52.80$ ;  $\rho = 1000$  kg/m<sup>3</sup>

Phantom section : Body- worn

Probe: ES3DV3 – SN3292; ConvF(4.23,4.23, 4.23); Calibrated: 08/15/2014;

Sensor-Surface: 3mm (Mechanical Surface Detection)

Electronics: DAE4 Sn1315; Calibrated: 07/22/2014;

Phantom: SAM 1; Type: SAM;

Measurement SW: DASY52, Version 52.8 (2); SEMCAD X Version 14.6.6 (6824)

**Area Scan (91x121x1):** Measurement grid: dx=15.0 mm, dy=15.0 mm

Maximum value of SAR (interpolated) = 0.456 W/Kg

**Zoom Scan (7x7x7)/Cube 0:** Measurement grid: dx=5mm, dy=5mm, dz=5mm

Reference Value = 7.351 V/m; Power Drift = -0.12 dB

Peak SAR (extrapolated) = 0.504 W/kg

**SAR(1 g) = 0.422 W/Kg; SAR(10 g) = 0.387 W/Kg**

Maximum value of SAR (measured) = 0.478 W/kg

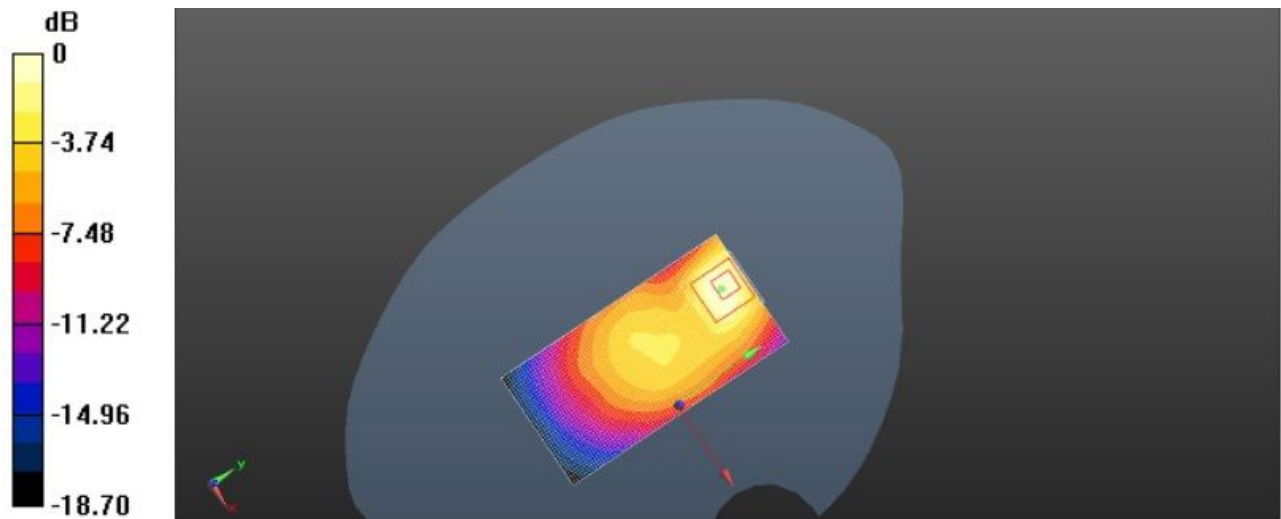

0 dB = 0.478 W/Kg

Plot 10: Body Rear Side (WiFi2450 Middle Channel-Channel 11-2462MHz (1Mbps))

# 6. Calibration Certificate

## 6.1. Probe Calibration Certificate

**Calibration Laboratory of  
Schmid & Partner  
Engineering AG**  
Zeughausstrasse 43, 8004 Zurich, Switzerland



**S** Schweizerischer Kalibrierdienst  
**C** Service suisse d'étalonnage  
**S** Servizio svizzero di taratura  
Swiss Calibration Service

Accredited by the Swiss Accreditation Service (SAS)  
The Swiss Accreditation Service is one of the signatories to the EA  
Multilateral Agreement for the recognition of calibration certificates

Accreditation No.: **SCS 108**

Client **CIQ (Auden)**

Certificate No: **ES3-3292\_Aug14**

### CALIBRATION CERTIFICATE

Object **ES3DV3 - SN:3292**

Calibration procedure(s) **QA CAL-01.v9, QA CAL-12.v9, QA CAL-23.v5, QA CAL-25.v6  
Calibration procedure for dosimetric E-field probes**

Calibration date: **August 15, 2014**

This calibration certificate documents the traceability to national standards, which realize the physical units of measurements (SI).  
The measurements and the uncertainties with confidence probability are given on the following pages and are part of the certificate.

All calibrations have been conducted in the closed laboratory facility: environment temperature (22 ± 3)°C and humidity < 70%.

Calibration Equipment used (M&TE critical for calibration)

Primary Standards	ID	Cal Date (Certificate No.)	Scheduled Calibration
Power meter E4419B	GB41293874	03-Apr-14 (No. 217-01911)	Apr-15
Power sensor E4412A	MY41498087	03-Apr-14 (No. 217-01911)	Apr-15
Reference 3 dB Attenuator	SN: S5054 (3c)	03-Apr-14 (No. 217-01915)	Apr-15
Reference 20 dB Attenuator	SN: S5277 (20x)	03-Apr-14 (No. 217-01919)	Apr-15
Reference 30 dB Attenuator	SN: S5129 (30b)	03-Apr-14 (No. 217-01920)	Apr-15
Reference Probe ES3DV2	SN: 3013	30-Dec-13 (No. ES3-3013_Dec13)	Dec-14
DAE4	SN: 660	13-Dec-13 (No. DAE4-660_Dec13)	Dec-14
Secondary Standards	ID	Check Date (in house)	Scheduled Check
RF generator HP 8648C	US3642U01700	4-Aug-99 (in house check Apr-13)	In house check: Apr-16
Network Analyzer HP 8753E	US37390585	18-Oct-01 (in house check Oct-13)	In house check: Oct-14

Calibrated by:	Name Claudio Leubler	Function Laboratory Technician	Signature 
Approved by:	Katja Pokovic	Technical Manager	
			Issued: August 15, 2014
This calibration certificate shall not be reproduced except in full without written approval of the laboratory.			



**Calibration Laboratory of**  
Schmid & Partner  
Engineering AG  
Zeughausstrasse 43, 8004 Zurich, Switzerland



S Schweizerischer Kalibrierdienst  
C Service suisse d'étalonnage  
S Servizio svizzero di taratura  
S Swiss Calibration Service

Accredited by the Swiss Accreditation Service (SAS)

Accreditation No.: SCS 108

The Swiss Accreditation Service is one of the signatories to the EA  
Multilateral Agreement for the recognition of calibration certificates

#### Glossary:

TSL	tissue simulating liquid
NORM <sub>x,y,z</sub>	sensitivity in free space
ConvF	sensitivity in TSL / NORM <sub>x,y,z</sub>
DCP	diode compression point
CF	crest factor (1/duty_cycle) of the RF signal
A, B, C, D	modulation dependent linearization parameters
Polarization $\phi$	$\phi$ rotation around probe axis
Polarization $\vartheta$	$\vartheta$ rotation around an axis that is in the plane normal to probe axis (at measurement center), i.e., $\vartheta = 0$ is normal to probe axis
Connector Angle	information used in DASY system to align probe sensor X to the robot coordinate system

#### Calibration is Performed According to the Following Standards:

- IEEE Std 1528-2013, "IEEE Recommended Practice for Determining the Peak Spatial-Averaged Specific Absorption Rate (SAR) in the Human Head from Wireless Communications Devices: Measurement Techniques", June 2013
- IEC 62209-1, "Procedure to measure the Specific Absorption Rate (SAR) for hand-held devices used in close proximity to the ear (frequency range of 300 MHz to 3 GHz)", February 2005

#### Methods Applied and Interpretation of Parameters:

- NORM<sub>x,y,z</sub>**: Assessed for E-field polarization  $\vartheta = 0$  ( $f \leq 900$  MHz in TEM-cell;  $f > 1800$  MHz: R22 waveguide). NORM<sub>x,y,z</sub> are only intermediate values, i.e., the uncertainties of NORM<sub>x,y,z</sub> does not affect the E<sup>2</sup>-field uncertainty inside TSL (see below ConvF).
- NORM(f)<sub>x,y,z</sub>** = NORM<sub>x,y,z</sub> \* frequency\_response (see Frequency Response Chart). This linearization is implemented in DASY4 software versions later than 4.2. The uncertainty of the frequency response is included in the stated uncertainty of ConvF.
- DCP<sub>x,y,z</sub>**: DCP are numerical linearization parameters assessed based on the data of power sweep with CW signal (no uncertainty required). DCP does not depend on frequency nor media.
- PAR**: PAR is the Peak to Average Ratio that is not calibrated but determined based on the signal characteristics
- A<sub>x,y,z</sub>; B<sub>x,y,z</sub>; C<sub>x,y,z</sub>; D<sub>x,y,z</sub>; VR<sub>x,y,z</sub>**: A, B, C, D are numerical linearization parameters assessed based on the data of power sweep for specific modulation signal. The parameters do not depend on frequency nor media. VR is the maximum calibration range expressed in RMS voltage across the diode.
- ConvF and Boundary Effect Parameters**: Assessed in flat phantom using E-field (or Temperature Transfer Standard for  $f \leq 800$  MHz) and inside waveguide using analytical field distributions based on power measurements for  $f > 800$  MHz. The same setups are used for assessment of the parameters applied for boundary compensation (alpha, depth) of which typical uncertainty values are given. These parameters are used in DASY4 software to improve probe accuracy close to the boundary. The sensitivity in TSL corresponds to NORM<sub>x,y,z</sub> \* ConvF whereby the uncertainty corresponds to that given for ConvF. A frequency dependent ConvF is used in DASY version 4.4 and higher which allows extending the validity from  $\pm 50$  MHz to  $\pm 100$  MHz.
- Spherical isotropy (3D deviation from isotropy)**: in a field of low gradients realized using a flat phantom exposed by a patch antenna.
- Sensor Offset**: The sensor offset corresponds to the offset of virtual measurement center from the probe tip (on probe axis). No tolerance required.
- Connector Angle**: The angle is assessed using the information gained by determining the NORM<sub>x</sub> (no uncertainty required).

ES3DV3 – SN:3292

August 15, 2014

# Probe ES3DV3

## SN:3292

Manufactured:	July 6, 2010
Repaired:	July 28, 2014
Calibrated:	August 15, 2014

Calibrated for DASY/EASY Systems  
(Note: non-compatible with DASY2 system!)

ES3DV3- SN:3292

August 15, 2014

**DASY/EASY - Parameters of Probe: ES3DV3 - SN:3292****Basic Calibration Parameters**

	Sensor X	Sensor Y	Sensor Z	Unc (k=2)
Norm ( $\mu\text{V}/(\text{V}/\text{m})^2$ ) <sup>A</sup>	0.89	0.95	1.46	$\pm 10.1 \%$
DCP (mV) <sup>B</sup>	107.1	106.1	103.9	

**Modulation Calibration Parameters**

UID	Communication System Name		A dB	B dB $\sqrt{\mu\text{V}}$	C	D dB	VR mV	Unc <sup>E</sup> (k=2)
0	CW	X	0.0	0.0	1.0	0.00	209.7	$\pm 3.8 \%$
		Y	0.0	0.0	1.0		218.8	
		Z	0.0	0.0	1.0		198.5	

The reported uncertainty of measurement is stated as the standard uncertainty of measurement multiplied by the coverage factor  $k=2$ , which for a normal distribution corresponds to a coverage probability of approximately 95%.

<sup>A</sup> The uncertainties of NormX,Y,Z do not affect the  $E^2$ -field uncertainty inside TSL (see Pages 5 and 6).

<sup>B</sup> Numerical linearization parameter: uncertainty not required.

<sup>E</sup> Uncertainty is determined using the max. deviation from linear response applying rectangular distribution and is expressed for the square of the field value.



ES3DV3– SN:3292

August 15, 2014

## DASY/EASY - Parameters of Probe: ES3DV3 - SN:3292

### Calibration Parameter Determined in Head Tissue Simulating Media

f (MHz) <sup>C</sup>	Relative Permittivity <sup>F</sup>	Conductivity (S/m) <sup>F</sup>	ConvF X	ConvF Y	ConvF Z	Alpha <sup>G</sup>	Depth <sup>G</sup> (mm)	Unct. (k=2)
450	43.5	0.87	6.71	6.71	6.71	0.18	1.80	± 13.3 %
835	41.5	0.90	6.23	6.23	6.23	0.80	1.11	± 12.0 %
900	41.5	0.97	6.71	6.71	6.71	0.71	1.17	± 12.0 %
1810	40.0	1.40	5.07	5.07	5.07	0.61	1.36	± 12.0 %
1900	40.0	1.40	5.03	5.03	5.03	0.45	1.55	± 12.0 %
2100	39.8	1.49	5.04	5.04	5.04	0.77	1.17	± 12.0 %
2450	39.2	1.80	4.43	4.43	4.43	0.73	1.23	± 12.0 %

<sup>C</sup> Frequency validity above 300 MHz of ± 100 MHz only applies for DASY v4.4 and higher (see Page 2), else it is restricted to ± 50 MHz. The uncertainty is the RSS of the ConvF uncertainty at calibration frequency and the uncertainty for the indicated frequency band. Frequency validity below 300 MHz is ± 10, 25, 40, 50 and 70 MHz for ConvF assessments at 30, 64, 128, 150 and 220 MHz respectively. Above 5 GHz frequency validity can be extended to ± 110 MHz.

<sup>F</sup> At frequencies below 3 GHz, the validity of tissue parameters ( $\epsilon$  and  $\sigma$ ) can be relaxed to ± 10% if liquid compensation formula is applied to measured SAR values. At frequencies above 3 GHz, the validity of tissue parameters ( $\epsilon$  and  $\sigma$ ) is restricted to ± 5%. The uncertainty is the RSS of the ConvF uncertainty for indicated target tissue parameters.

<sup>G</sup> Alpha/Depth are determined during calibration. SPEAG warrants that the remaining deviation due to the boundary effect after compensation is always less than ± 1% for frequencies below 3 GHz and below ± 2% for frequencies between 3-6 GHz at any distance larger than half the probe tip diameter from the boundary.

ES3DV3- SN:3292

August 15, 2014

## DASY/EASY - Parameters of Probe: ES3DV3 - SN:3292

### Calibration Parameter Determined in Body Tissue Simulating Media

f (MHz) <sup>C</sup>	Relative Permittivity <sup>F</sup>	Conductivity (S/m) <sup>F</sup>	ConvF X	ConvF Y	ConvF Z	Alpha <sup>G</sup>	Depth (mm) <sup>G</sup>	Unct. (k=2)
450	56.7	0.94	7.10	7.10	7.10	0.13	1.00	± 13.3 %
835	55.2	0.97	6.11	6.11	6.11	0.36	1.78	± 12.0 %
900	55.0	1.05	5.97	5.97	5.97	0.73	1.22	± 12.0 %
1810	53.3	1.52	4.79	4.79	4.79	0.59	1.45	± 12.0 %
1900	53.3	1.52	4.66	4.66	4.66	0.41	1.79	± 12.0 %
2100	53.2	1.62	4.77	4.77	4.77	0.63	1.42	± 12.0 %
2450	52.7	1.95	4.23	4.23	4.23	0.66	0.98	± 12.0 %

<sup>C</sup> Frequency validity above 300 MHz of ± 100 MHz only applies for DASY v4.4 and higher (see Page 2), else it is restricted to ± 50 MHz. The uncertainty is the RSS of the ConvF uncertainty at calibration frequency and the uncertainty for the indicated frequency band. Frequency validity below 300 MHz is ± 10, 25, 40, 50 and 70 MHz for ConvF assessments at 30, 64, 128, 150 and 220 MHz respectively. Above 5 GHz frequency validity can be extended to ± 110 MHz.

<sup>F</sup> At frequencies below 3 GHz, the validity of tissue parameters ( $\epsilon$  and  $\sigma$ ) can be relaxed to ± 10% if liquid compensation formula is applied to measured SAR values. At frequencies above 3 GHz, the validity of tissue parameters ( $\epsilon$  and  $\sigma$ ) is restricted to ± 5%. The uncertainty is the RSS of the ConvF uncertainty for indicated target tissue parameters.

<sup>G</sup> Alpha/Depth are determined during calibration. SPEAG warrants that the remaining deviation due to the boundary effect after compensation is always less than ± 1% for frequencies below 3 GHz and below ± 2% for frequencies between 3-6 GHz at any distance larger than half the probe tip diameter from the boundary.

ES3DV3- SN:3292

August 15, 2014

### Frequency Response of E-Field (TEM-Cell:ifi110 EXX, Waveguide: R22)

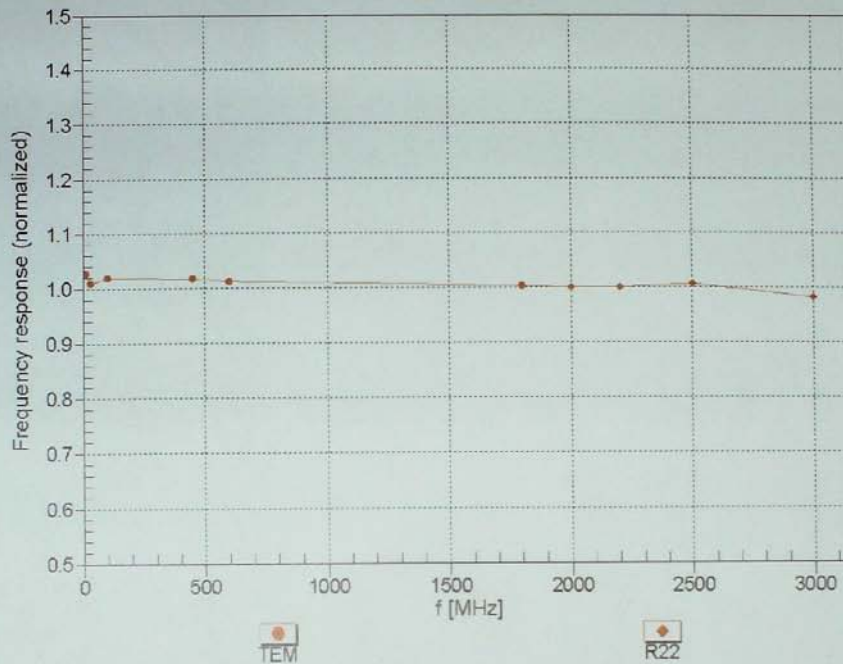

Uncertainty of Frequency Response of E-field:  $\pm 6.3\%$  (k=2)



ES3DV3-SN:3292

August 15, 2014

### Receiving Pattern ( $\phi$ ), $\theta = 0^\circ$

f=600 MHz,TEM

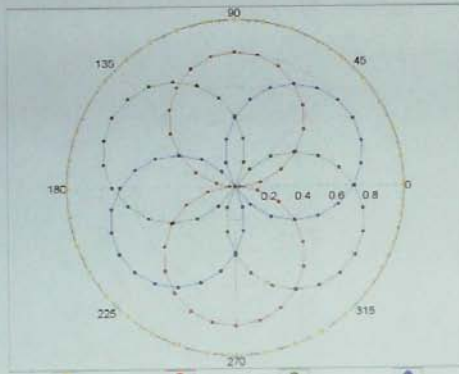

f=1800 MHz,R22

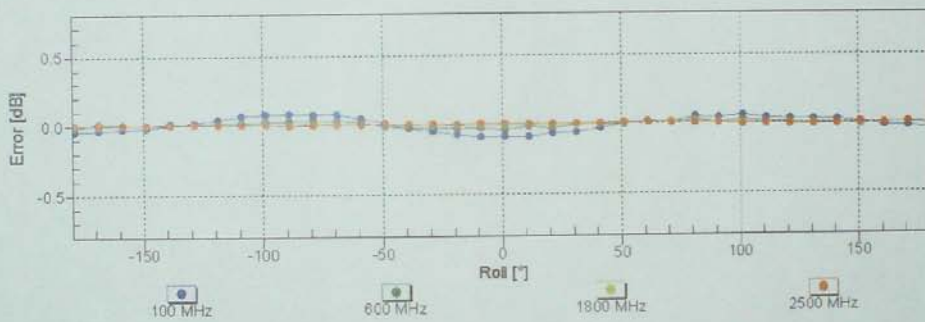
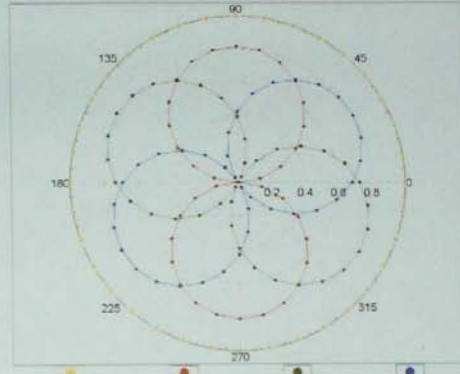

Uncertainty of Axial Isotropy Assessment:  $\pm 0.5\%$  (k=2)

ES3DV3- SN:3292

August 15, 2014

### Dynamic Range $f(SAR_{head})$ (TEM cell , $f_{eval}= 1900$ MHz)

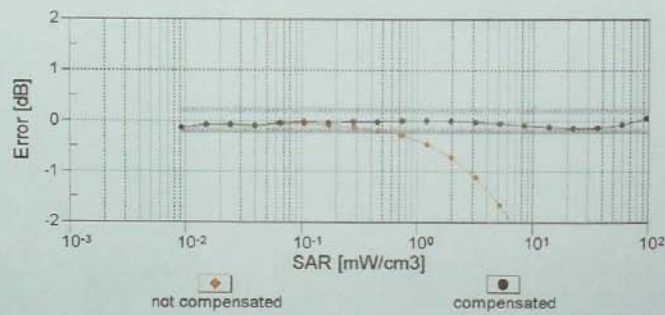
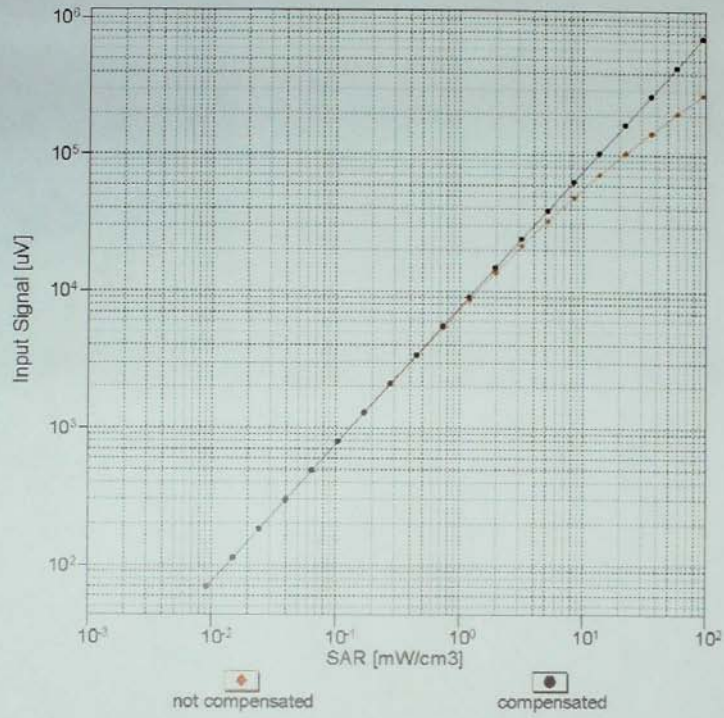

Uncertainty of Linearity Assessment:  $\pm 0.6\%$  (k=2)

ES3DV3- SN:3292

August 15, 2014

### Conversion Factor Assessment

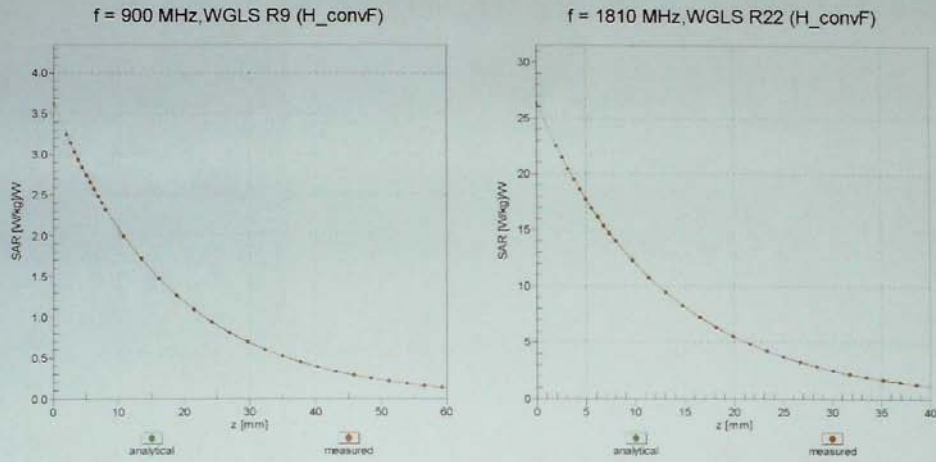

### Deviation from Isotropy in Liquid Error ( $\phi, \vartheta$ ), f = 900 MHz

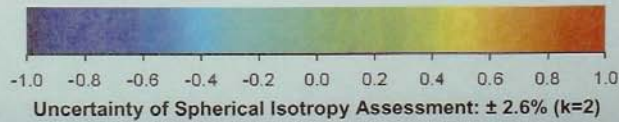
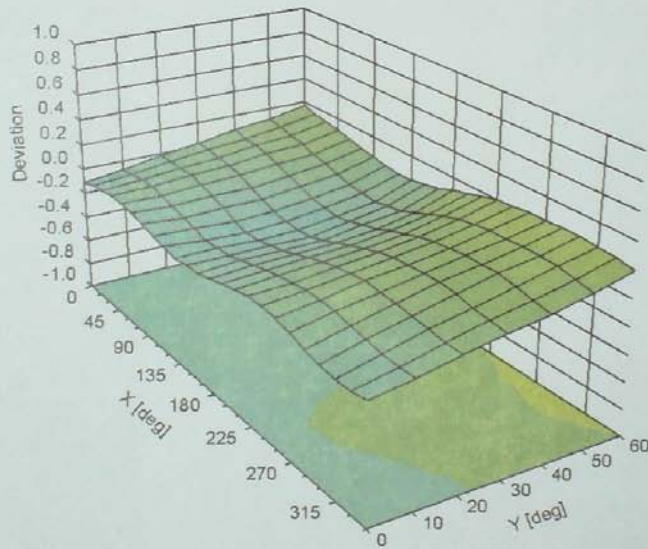



ES3DV3- SN:3292

August 15, 2014

**DASY/EASY - Parameters of Probe: ES3DV3 - SN:3292****Other Probe Parameters**

Sensor Arrangement	Triangular
Connector Angle (°)	-8.9
Mechanical Surface Detection Mode	enabled
Optical Surface Detection Mode	disabled
Probe Overall Length	337 mm
Probe Body Diameter	10 mm
Tip Length	10 mm
Tip Diameter	4 mm
Probe Tip to Sensor X Calibration Point	2 mm
Probe Tip to Sensor Y Calibration Point	2 mm
Probe Tip to Sensor Z Calibration Point	2 mm
Recommended Measurement Distance from Surface	3 mm

6.2. D835V2 Dipole Calibration Certificate



In Collaboration with  
**s p e a g**  
CALIBRATION LABORATORY



CALIBRATION  
No. L0570

Add: No.51 Xueyuan Road, Haidian District, Beijing, 100191, China  
Tel: +86-10-62304633-2079 Fax: +86-10-62304633-2504  
E-mail: cttl@chinattl.com Http://www.chinattl.cn

Client **CIQ-SZ(Auden)** Certificate No: **Z14-97067**

---

### CALIBRATION CERTIFICATE

Object: **D835V2 - SN: 4d134**

Calibration Procedure(s): **TMC-OS-E-02-194**  
Calibration procedure for dipole validation kits



Calibration date: **July 24, 2014**

This calibration Certificate documents the traceability to national standards, which realize the physical units of measurements(SI). The measurements and the uncertainties with confidence probability are given on the following pages and are part of the certificate.

All calibrations have been conducted in the closed laboratory facility: environment temperature(22±3)°C and humidity<70%.

Calibration Equipment used (M&TE critical for calibration)

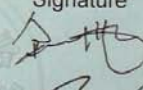
Primary Standards	ID #	Cal Date(Calibrated by, Certificate No.)	Scheduled Calibration
Power Meter NRVD	102083	11-Sep-13 (TMC, No.JZ13-443)	Sep-14
Power sensor NRV-Z5	100595	11-Sep-13 (TMC, No. JZ13-443)	Sep -14
Reference Probe EX3DV4	SN 3846	3- Sep-13 (SPEAG, No.EX3-3846_Sep13)	Sep-14
DAE4	SN 1331	23-Jan-14 (SPEAG, DAE4-1331_Jan14)	Jan -15
Signal Generator E4438C	MY49070393	13-Nov-13 (TMC, No.JZ13-394)	Nov-14
Network Analyzer E8362B	MY43021135	19-Oct-13 (TMC, No.JZ13-278)	Oct-14

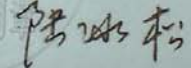
	Name	Function	Signature
Calibrated by:	Yu Zongying	SAR Test Engineer	
Reviewed by:	Qi Dianyuan	SAR Project Leader	
Approved by:	Lu Bingsong	Deputy Director of the laboratory	

Issued: July 28, 2014

This calibration certificate shall not be reproduced except in full without written approval of the laboratory.

Certificate No: Z14-97067

Page 1 of 8



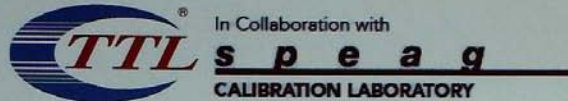

Add: No.51 Xueyuan Road, Haidian District, Beijing, 100191, China  
 Tel: +86-10-62304633-2079 Fax: +86-10-62304633-2504  
 E-mail: cttl@chinattl.com Http://www.chinattl.cn

**Glossary:**

TSL	tissue simulating liquid
ConvF	sensitivity in TSL / NORM <sub>x,y,z</sub>
N/A	not applicable or not measured

**Calibration is Performed According to the Following Standards:**

- IEEE Std 1528-2013, "IEEE Recommended Practice for Determining the Peak Spatial-Averaged Specific Absorption Rate (SAR) in the Human Head from Wireless Communications Devices: Measurement Techniques", June 2013
- IEC 62209-1, "Procedure to measure the Specific Absorption Rate (SAR) For hand-held devices used in close proximity to the ear (frequency range of 300MHz to 3GHz)", February 2005
- KDB865664, SAR Measurement Requirements for 100 MHz to 6 GHz

**Additional Documentation:**

- DASY4/5 System Handbook

**Methods Applied and Interpretation of Parameters:**

- Measurement Conditions:* Further details are available from the Validation Report at the end of the certificate. All figures stated in the certificate are valid at the frequency indicated.
- Antenna Parameters with TSL:* The dipole is mounted with the spacer to position its feed point exactly below the center marking of the flat phantom section, with the arms oriented parallel to the body axis.
- Feed Point Impedance and Return Loss:* These parameters are measured with the dipole positioned under the liquid filled phantom. The impedance stated is transformed from the measurement at the SMA connector to the feed point. The Return Loss ensures low reflected power. No uncertainty required.
- Electrical Delay:* One-way delay between the SMA connector and the antenna feed point. No uncertainty required.
- SAR measured:* SAR measured at the stated antenna input power.
- SAR normalized:* SAR as measured, normalized to an input power of 1 W at the antenna connector.
- SAR for nominal TSL parameters:* The measured TSL parameters are used to calculate the nominal SAR result.

The reported uncertainty of measurement is stated as the standard uncertainty of Measurement multiplied by the coverage factor  $k=2$ , which for a normal distribution Corresponds to a coverage probability of approximately 95%.

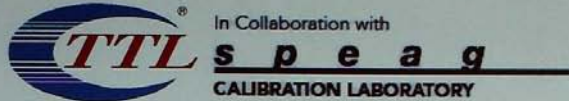

Add: No.51 Xueyuan Road, Haidian District, Beijing, 100191, China  
 Tel: +86-10-62304633-2079 Fax: +86-10-62304633-2504  
 E-mail: cttl@chinattl.com Http://www.chinattl.cn



### Measurement Conditions

DASY system configuration, as far as not given on page 1.

DASY Version	DASY52	52.8.8.1222
Extrapolation	Advanced Extrapolation	
Phantom	Triple Flat Phantom 5.1C	
Distance Dipole Center - TSL	15 mm	with Spacer
Zoom Scan Resolution	dx, dy, dz = 5 mm	
Frequency	835 MHz $\pm$ 1 MHz	

### Head TSL parameters

The following parameters and calculations were applied.

	Temperature	Permittivity	Conductivity
Nominal Head TSL parameters	22.0 °C	41.5	0.90 mho/m
Measured Head TSL parameters	(22.0 $\pm$ 0.2) °C	41.7 $\pm$ 6 %	0.90 mho/m $\pm$ 6 %
Head TSL temperature change during test	<1.0 °C	----	----

### SAR result with Head TSL

SAR averaged over 1 $cm^3$ (1 g) of Head TSL	Condition	
SAR measured	250 mW input power	2.41 mW / g
SAR for nominal Head TSL parameters	normalized to 1W	9.62 mW / g $\pm$ 20.8 % (k=2)
SAR averaged over 10 $cm^3$ (10 g) of Head TSL	Condition	
SAR measured	250 mW input power	1.57 mW / g
SAR for nominal Head TSL parameters	normalized to 1W	6.27 mW / g $\pm$ 20.4 % (k=2)

### Body TSL parameters

The following parameters and calculations were applied.

	Temperature	Permittivity	Conductivity
Nominal Body TSL parameters	22.0 °C	55.2	0.97 mho/m
Measured Body TSL parameters	(22.0 $\pm$ 0.2) °C	55.6 $\pm$ 6 %	0.99 mho/m $\pm$ 6 %
Body TSL temperature change during test	<1.0 °C	----	----

### SAR result with Body TSL

SAR averaged over 1 $cm^3$ (1 g) of Body TSL	Condition	
SAR measured	250 mW input power	2.47 mW / g
SAR for nominal Body TSL parameters	normalized to 1W	9.77 mW / g $\pm$ 20.8 % (k=2)
SAR averaged over 10 $cm^3$ (10 g) of Body TSL	Condition	
SAR measured	250 mW input power	1.64 mW / g
SAR for nominal Body TSL parameters	normalized to 1W	6.50 mW / g $\pm$ 20.4 % (k=2)



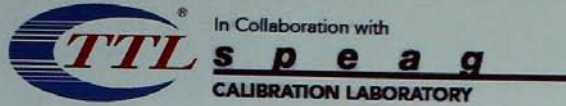

Add: No.51 Xueyuan Road, Haidian District, Beijing, 100191, China  
Tel: +86-10-62304633-2079 Fax: +86-10-62304633-2504  
E-mail: cttl@chinattl.com Http://www.chinattl.cn



## Appendix

### Antenna Parameters with Head TSL

Impedance, transformed to feed point	$48.8\Omega + 3.34j\Omega$
Return Loss	- 28.9dB

### Antenna Parameters with Body TSL

Impedance, transformed to feed point	$50.9\Omega + 7.08j\Omega$
Return Loss	- 23.0dB

### General Antenna Parameters and Design

Electrical Delay (one direction)	1.261 ns
----------------------------------	----------

After long term use with 100W radiated power, only a slight warming of the dipole near the feedpoint can be measured.

The dipole is made of standard semirigid coaxial cable. The center conductor of the feeding line is directly connected to the second arm of the dipole. The antenna is therefore short-circuited for DC-signals. On some of the dipoles, small end caps are added to the dipole arms in order to improve matching when loaded according to the position as explained in the "Measurement Conditions" paragraph. The SAR data are not affected by this change. The overall dipole length is still according to the Standard.

No excessive force must be applied to the dipole arms, because they might bend or the soldered connections near the feedpoint may be damaged.

### Additional EUT Data

Manufactured by	SPEAG
-----------------	-------