

FCC PART 22/24 TEST REPORT

FCC Part 22 /Part 24

Report Reference No..... : MWR150600102

FCC ID..... : RQQLT-E435

Compiled by
(position+printed name+signature)..: File administrators Martin Ao



Supervised by
(position+printed name+signature)..: Test Engineer Martin Ao



Approved by
(position+printed name+signature)..: Manager Dixon Hao



Date of issue.....: Jun 17, 2015

Representative Laboratory Name. : Maxwell International Co., Ltd.

Address.....: Room 509,Hongfacenter building, Baoan District, Shenzhen,

Testing Laboratory Name.....: Shenzhen CTL Testing Technology Co., Ltd.

Address.....: Floor 1-A, Baisha Technology Park, No. 3011, Shahexi Road,
Nanshan,Shenzhen,China

Applicant's name.....: HYUNDAI CORPORATION

Address.....: 140-2, Kye-dong, Chongro-ku, Seoul, South Korea

Test specification..... :

Standard.....: **FCC Part 22: PUBLIC MOBILE SERVICES**

FCC Part 24: PERSONAL COMMUNICATIONS SERVICES

TRF Originator.....: Maxwell International Co., Ltd. .

Maxwell International Co., Ltd. All rights reserved.

This publication may be reproduced in whole or in part for non-commercial purposes as long as the Maxwell International Co., Ltd. as copyright owner and source of the material. Maxwell International Co., Ltd. takes no responsibility for and will not assume liability for damages resulting from the reader's interpretation of the reproduced material due to its placement and context.

Test item description.....: Mobile Phone

Trade Mark.....: HYUNDAI

Manufacturer.....: WASAM TECHNOLOGY (SHEN ZHEN) CO.,LTD.

Model/Type reference.....: E435

Listed Models: N/A

Ratings.....: DC 3.80V

Modulation: QPSK

Hardware version.....: T6461 - V2.0

Software version: T6461_MUSO_V1_20150529.rar

Frequency.....: WCDMA Band II & WCDMA Band V

Result.....: **PASS**

TEST REPORT

Test Report No. :	MWR150600102	Jun 17, 2015
		Date of issue

Equipment under Test : Mobile Phone

Model /Type : E435

Listed Models : N/A

Applicant : **HYUNDAI CORPORATION**

Address : 140-2, Kye-dong, Chongro-ku, Seoul, South Korea

Manufacturer : **WASAM TECHNOLOGY (SHEN ZHEN) CO.,LTD.**

Address : B,F Building, (Hengqiang Industrial Park), Bogang Taifeng Industrial Zone, Shajing Town, Bao' an District, Shenzhen, China

Test Result:	PASS
---------------------	-------------

The test report merely corresponds to the test sample.
It is not permitted to copy extracts of these test result without the written permission of the test laboratory.

Contents

1.	TEST STANDARDS	4
2.	SUMMARY	5
2.1.	General Remarks	5
2.2.	Product Description	5
2.3.	Equipment under Test	6
2.4.	Short description of the Equipment under Test (EUT)	6
2.5.	Internal Identification of AE used during the test	7
2.6.	Normal Accessory setting	7
2.7.	EUT configuration	7
2.8.	Related Submittal(s) / Grant (s)	7
2.9.	Modifications	7
2.10.	General Test Conditions/Configurations	8
2.11.	Note	8
3.	TEST ENVIRONMENT	9
3.1.	Address of the test laboratory	9
3.2.	Test Facility	9
3.3.	Environmental conditions	9
3.4.	Test Description	9
3.5.	Equipments Used during the Test	10
4.	TEST CONDITIONS AND RESULTS	12
4.1.	Output Power	12
4.2.	Radiated Spurious Emssion	15
4.3.	Occupied Bandwidth and Emission Bandwith	18
4.4.	Band Edge Compliance	20
4.5.	Spurious Emssion on Antenna Port	22
4.6.	Frequency Stability Test	28
5.	TEST SETUP PHOTOS OF THE EUT	30

1. TEST STANDARDS

The tests were performed according to following standards:

[FCC Part 22 \(10-1-12 Edition\)](#): PRIVATE LAND MOBILE RADIO SERVICES.

[FCC Part 24\(10-1-12 Edition\)](#): PUBLIC MOBILE SERVICES

[TIA/EIA 603 D June 2010](#): Land Mobile FM or PM Communications Equipment Measurement and Performance Standards.

[47 CFR FCC Part 15 Subpart B](#): - Unintentional Radiators

[FCC Part 2](#): FREQUENCY ALLOCATIONS AND RADIO TREATY MATTERS; GENERAL RULES AND REGULATIONS

[ANSI C63.4:2009](#): Methods of Measurement of Radio-Noise Emissions from Low-Voltage Electrical and Electronic Equipment in the Range of 9 kHz to 40 GHz

[FCCKDB971168D01](#) Power Meas License Digital Systems

2. SUMMARY

2.1. General Remarks

Date of receipt of test sample	:	May 04, 2015
Testing commenced on	:	May 05,2015
Testing concluded on	:	Jun 16, 2015

2.2. Product Description

The **HYUNDAI CORPORATION** 's Model: E435 or the "EUT" as referred to in this report; more general information as follows, for more details, refer to the user's manual of the EUT.

Name of EUT	Mobile Phone
Model Number	E435
Modulation Type	GMSK for GSM/GPRS/EDGE, 8-PSK for EDGE only Downlink,QPSK for UMTS
Antenna Type	Internal
UMTS Operation Frequency Band	Device supported UMTS FDD Band II and FDD Band V
WLAN FCC Operation frequency	IEEE 802.11b:2412-2462MHz IEEE 802.11g:2412-2462MHz IEEE 802.11n HT20:2412-2462MHz IEEE 802.11n HT40:2422-2452MHz
BT CE Operation frequency	2402MHz-2480MHz
HSDPA Release Version	Release 7
HSUPA Release Version	Release 6
DC-HSUPA Release Version	Not Supported
WCDMA Release Version	R99
WLAN FCC Modulation Type	IEEE 802.11b: DSSS(CCK,DQPSK,DBPSK) IEEE 802.11g: OFDM(64QAM, 16QAM, QPSK, BPSK) IEEE 802.11n HT20: OFDM (64QAM, 16QAM, QPSK,BPSK) IEEE 802.11n HT40: OFDM (64QAM, 16QAM, QPSK,BPSK)
BT Modulation Type	GFSK (BT 4.0)/GFSK,8DPSK, π /4DQPSK(BT 3.0+EDR)
Hardware version	T6461 - V2.0
Software version	T6461_MUSO_V1_20150529.rar
Android version	Android 4.4.2
GPS function	Supported
WLAN	Supported 802.11b/802.11g/802.11n
Bluetooth	Supported BT 4.0/BT 3.0+EDR
GSM/EDGE/GPRS	Supported GSM/GPRS/EDGE
GSM/EDGE/GPRS Power Class	GSM850:Power Class 4/PCS1900:Power Class 1
GSM/EDGE/GPRS Operation Frequency	GSM850 :824.2MHz-848.8MHz PCS1900:1852.4MHz-907.6MHz
GSM/EDGE/GPRS Operation Frequency Band	GSM850/PCS1900/GPRS850/ GPRS1900/EDGE850/EDGE1900
GSM Release Version	R99
GPRS/EDGE Multislot Class	GPRS/EDGE: Multi-slot Class 12
Extreme temp. Tolerance	-30°C to +50°C
Extreme vol. Limits	3.50VDC to 4.35VDC (nominal: 3.80VDC)
GPRS operation mode	Class B
EGPRS operation mode	Class B

2.3. Equipment under Test

Power supply system utilised

Power supply voltage	:	<input type="radio"/> 120V / 60 Hz	<input type="radio"/> 115V / 60Hz
		<input type="radio"/> 12 V DC	<input type="radio"/> 24 V DC
		<input checked="" type="radio"/> Other (specified in blank below)	

DC 3.80V

Test frequency list

Test Mode	TX/RX	RF Channel		
		Low(L)	Middle (M)	High (H)
GSM850	TX	Channel 128	Channel 190	Channel 251
		824.2 MHz	836.6 MHz	848.8 MHz
	RX	Channel 128	Channel 190	Channel 251
		869.2 MHz	881.6 MHz	893.8 MHz
Test Mode	TX/RX	RF Channel		
		Low(L)	Middle (M)	High (H)
GSM1900	TX	Channel 512	Channel 661	Channel 810
		1850.2 MHz	1880.0 MHz	1909.8 MHz
	RX	Channel 512	Channel 661	Channel 810
		1930.2 MHz	1960.0 MHz	1989.8 MHz
Test Mode	TX/RX	RF Channel		
		Low(L)	Middle (M)	High (H)
WCDMA850	TX	Channel 4132	Channel 4182	Channel 4233
		826.4 MHz	836.4 MHz	846.6 MHz
	RX	Channel 4357	Channel 4407	Channel 4458
		871.4 MHz	881.4 MHz	891.6 MHz
Test Mode	TX/RX	RF Channel		
		Low(L)	Middle (M)	High (H)
WCDMA1900	TX	Channel 9262	Channel 9400	Channel 9538
		1852.4 MHz	1880.0 MHz	1907.6 MHz
	RX	Channel 9662	Channel 9800	Channel 9938
		1932.4 MHz	1960.0 MHz	1987.6 MHz

2.4. Short description of the Equipment under Test (EUT)

2.4.1 General Description

E435 is subscriber equipment in the WCDMA/GSM system. The HSPA/UMTS frequency band is Band II, Band V; The GSM/GPRS/EDGE (EDGE downlink only) frequency band includes GSM850 and GSM900 and DCS1800 and PCS1900, but only Band II and Band V and GSM850 and PCS1900 bands test data included in this report. The Mobile Phone implements such functions as RF signal receiving/transmitting, HSPA/UMTS and GSM/GPRS/EDGE protocol processing, voice, video MMS service, GPS, AGPS and WIFI etc. Externally it provides micro SD card interface, earphone port (to provide voice service) and SIM card interface. It also provides Bluetooth module to synchronize data between a PC and the phone, or to use the built-in modem of the phone to access the Internet with a PC, or to exchange data with other Bluetooth devices.

NOTE: Unless otherwise noted in the report, the functional boards installed in the units shall be selected from the below list, but not means all the functional boards listed below shall be installed in one unit.

2.4.2 Technical Specification

Characteristics	Description	
Radio System Type	<input checked="" type="checkbox"/> GSM/ <input checked="" type="checkbox"/> UMTS	
Supported Frequency Range	GSM850/WCDMA850	Transmission(TX): 824 to 849MHz Receiving(RX): 869 to 894MHz
	GSM1900/WCDMA1900	Transmission(TX): 1850 to 1910MHz Receiving(RX): 1930 to 1990MHz
TX and RX Antenna Ports	TX& RX port:	1
Supported Channel Bandwidth Designation of Emissions (Note: the necessary bandwidth of which is the worst value from the measured occupied bandwidths for each type of channel bandwidth configuration.)	GSM system:	200 kHz
	UMTS system:	5 MHz
	GSM850:	250KGXW
	GSM1900:	248KGXW
	UMTS 850:	4M18F9W
	UMTS 1900:	4M20F9W

2.5. Internal Identification of AE used during the test

AE ID*	Description
AE1	Charger

AE1

Model: E435

INPUT:100-240V 50/60Hz 0.15A

OUTPUT: DC 5.0V,500mAh

2.6. Normal Accessory setting

Fully charged battery was used during the test.

2.7. EUT configuration

The following peripheral devices and interface cables were connected during the measurement:

● - supplied by the manufacturer

○ - supplied by the lab

<input type="radio"/>	Power Cable	Length (m) :	/
		Shield :	/
		Detachable :	/
<input type="radio"/>	Multimeter	Manufacturer :	/
		Model No. :	/

2.8. Related Submittal(s) / Grant (s)

This submittal(s) (test report) is intended for FCC ID: RQQHLT-E435 filing to comply with FCC Part 22 and Part 24 Rules

2.9. Modifications

No modifications were implemented to meet testing criteria.

2.10. General Test Conditions/Configurations

2.10.1 Test Modes

NOTE: The test mode(s) are selected according to relevant radio technology specifications.

Test Mode	Test Modes Description
GSM/TM1	GSM system, GSM,GMSK modulation
GSM/TM2	GSM system, GPRS, GMSK modulation
GSM/TM3	GSM system, EDGE, GMSK modulation
UMTS/TM1	WCDMA system, QPSK modulation
UMTS/TM2	HSDPA system, QPSK modulation
UMTS/TM3	HSUPA system, QPSK modulation

Note:

1. This EUT owns two SIM cards, after we perform the pretest for these two SIM cards; we found the SIM 1 is the worst case, so its result is recorded in this report.
2. EDGE and GPRS use same modulation type (GMSK), we test only GPRS according to 3GPPP TS 151 010 requirement.

2.10.2 Test Environment

Environment Parameter	Selected Values During Tests	
Relative Humidity	Ambient	
Temperature	TN	Ambient
Voltage	VL	3.50V
	VN	3.80V
	VH	4.35V

NOTE: VL=lower extreme test voltage VN=nominal voltage
VH=upper extreme test voltage TN=normal temperature

2.11. Note

1. The EUT is a Mobile Phone with WCDMA/GSM/GPRS/EDGE,WiFi and Bluetooth fuction,The functions of the EUT listed as below:

	Test Standards	Reference Report
GSM/GPRS/EDGE	FCC Part 22/FCC Part 24	MWR150600101
WCDMA	FCC Part 22/FCC Part 24	MWR150600102
Bluetooth	FCC Part 15 C 15.247	MWR150600103
BLE	FCC Part 15 C 15.247	MWR150600104
WiFi	FCC Part 15 C 15.247	MWR150600105
USB Port	FCC Part 15 B	MWR150600106
SAR	FCC Part 2 §2.1093	MWR150600107

3. TEST ENVIRONMENT

3.1. Address of the test laboratory

Shenzhen CTL Testing Technology Co., Ltd.

Floor 1-A, Baisha Technology Park, No. 3011, Shahexi Road, Nanshan, Shenzhen, China
The sites are constructed in conformance with the requirements of ANSI C63.7, ANSI C63.4 (2003) and CISPR Publication 22.

3.2. Test Facility

The test facility is recognized, certified, or accredited by the following organizations:

FCC-Registration No.: 970318

Shenzhen CTL Testing Technology Co., Ltd. has been registered and fully described in a report filed with the (FCC) Federal Communications Commission. The acceptance letter from the FCC is maintained in our files. Registration 970318, Dec 19, 2013

3.3. Environmental conditions

During the measurement the environmental conditions were within the listed ranges:

Temperature:	15-35 ° C
Humidity:	30-60 %
Atmospheric pressure:	950-1050mbar

(1) expressed at approximately the 95% confidence level using a coverage factor of k=1.96.

3.4. Test Description

3.4.1 Cellular Band (824-849MHz paired with 869-894MHz)

Test Item	FCC Rule No.	Requirements	Verdict
Effective(Isotropic) Radiated Output Power	§2.1046, §22.913	FCC: ERP ≤ 7W.	Pass
Modulation Characteristics	§2.1047	Digital modulation	N/A
Bandwidth	§2.1049	OBW: No limit. EBW: No limit.	Pass
Band Edges Compliance	§2.1051, §22.917	≤-13dBm/1%*EBW, in 1MHz bands immediately outside and adjacent to The frequency block.	Pass
Spurious Emission at Antenna Terminals	§2.1051, §22.917	FCC: ≤ -13dBm/100kHz, from 9kHz to 10th harmonics but outside authorized operating frequency ranges.	Pass
Field Strength of Spurious Radiation	§2.1053, §22.917	FCC: ≤ -13dBm/100kHz.	Pass
Frequency Stability	§2.1055, §22.355	≤ ±2.5ppm.	Pass

NOTE 1: For the verdict, the "N/A" denotes "not applicable", the "N/T" de notes "not tested".

3.4.2 PCS Band (1850-1915MHz paired with 1930-1995MHz)

Test Item	FCC Rule	Requirements	Verdict
-----------	----------	--------------	---------

	No.		
Effective(Isotropic) Radiated Output Power	§2.1046, §24.232	EIRP \leq 2W	Pass
Peak-Average Ratio	§2.1046, §24.232	FCC:Limits \leq 13dB	N/A
Modulation Characteristics	§2.1047	Digital modulation	N/A
Bandwidth	§2.1049	OBW: No limit. EBW: No limit.	Pass
Band Edges Compliance	§2.1051, §24.238	\leq -13dBm/1%*EBW, In 1MHz bands immediately outside and adjacent to The frequency block.	Pass
Spurious Emission at Antenna Terminals	§2.1051, §24.238	\leq -13dBm/1MHz, from 9kHz to10th harmonics but outside authorized Operating frequency ranges.	Pass
Field Strength of Spurious Radiation	§2.1053, §24.238	\leq -13dBm/1MHz.	Pass
Frequency Stability	§2.1055, §24.235	FCC: within authorized frequency block.	Pass

NOTE 1: For the verdict, the "N/A" denotes "not applicable", the "N/T" de notes "not tested".

Remark:

1. The measurement uncertainty is not included in the test result.

3.5. Equipments Used during the Test

Output Power(Conducted) & Occupied Bandwidth & Emission Bandwidth & Band Edge Compliance & Conducted Spurious Emission					
No.	Equipment	Manufacturer	Model No.	Serial No.	Last Cal.
1	Radio Communication Tester	R&S	CMU200	115419	2015/05/22
2	Spectrum Analyzer	Rohde&Schwarz	FSU26	201148	2014/07/02
3	Splitter	Mini-Circuit	ZAPD-4	400059	2014/06/22
4	RF cable 1	MURATA	MXHS83QE3000	1420355	2014/10/19
5	RF cable 2	MURATA	MXHS83QE3000	1420356	2014/10/19
6	Spectrum Analyzer	Agilent	E4407B	MY45108355	2015/05/21
7	Power meter	Rohde & Schwarz	NRVD	260540	2014/07/02
8	Power Sensor	Rohde&Schwarz	NRR-Z81	256697	2014/07/02

Frequency Stability					
No.	Equipment	Manufacturer	Model No.	Serial No.	Last Cal.
1	Radio Communication Tester	R&S	CMU200	115419	2015/05/22
2	Spectrum Analyzer	Rohde&Schwarz	FSU26	201148	2014/07/02
3	Spectrum Analyzer	Agilent	E4407B	MY45108355	2015/05/21
4	Splitter	Mini-Circuit	ZAPD-4	400059	2014/06/22
5	RF cable 1	MURATA	MXHS83QE3000	1420355	2014/10/19

Output Power (Radiated) & Radiated Spurious Emission					
Item	Test Equipment	Manufacturer	Model No.	Serial No.	Last Cal.
1	Bilog Antenna	Sunol Sciences Corp.	JB1	A061713	2014/07/12
2	Bilog Antenna	Sunol Sciences Corp.	JB1	A061714	2014/07/12
3	EMI TEST Receivcer	Rohde&Schwarz	ESCI3	103710	2014/07/02
4	EMI TEST Software	Audix	E3	N/A	N/A
5	EMI TEST Software	Rohde&Schwarz	ESK1	N/A	N/A
6	HORN ANTENNA	Sunol Sciences Corp.	DRH-118	A062013	2014/07/12
7	HORN ANTENNA	Sunol Sciences Corp.	DRH-118	A062014	2014/07/12
8	Amplifer	HP	8447D	3113A07663	2014/10/26
9	Preamplifier	HP	8349B	3155A00882	2014/07/03
10	Loop Antenna	Rohde&Schwarz	HFH2-Z2	100020	2014/06/29
11	TURNTABLE	MATURO	TT2.0	----	N/A

12	ANTENNA MAST	MATURO	TAM-4.0-P	----	N/A
13	Horn Antenna	SCHWARZBECK	BBHA9170	25849	2014/06/21
14	Horn Antenna	SCHWARZBECK	BBHA9170	25850	2014/06/21
15	Radio Communication Tester	R&S	CMU200	115419	2015/05/22
16	Splitter	Mini-Circuit	ZAPD-4	400062	2014/06/22
17	Coaxial Cables	HUBER+SUHNER	SUCOFLEX 104PEA-10M	10m	2014/10/19
18	Coaxial Cables	HUBER+SUHNER	SUCOFLEX 104PEA-3M	3m	2014/10/19
19	Spectrum Analyzer	Agilent	E4407B	MY45108355	2015/05/21
20	SIGNAL GENERATOR	Agilent	E4421B	US40051744	2015/05/20

The calibration interval was one year.

4. TEST CONDITIONS AND RESULTS

4.1. Output Power

TEST APPLICABLE

During the process of testing, the EUT was controlled via Agilent Digital Radio Communication tester (CMU200) to ensure max power transmission and proper modulation. This result contains output power and EIRP measurements for the EUT. In all cases, output power is within the specified limits.

4.1.1. Conducted Output Power

TEST CONFIGURATION

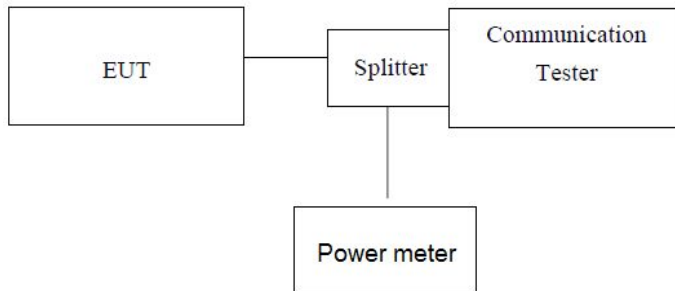

Note: Measurement setup for testing on Antenna connector

TEST PROCEDURE

1. The transmitter output port was connected to base station.
2. The RF output of EUT was connected to the power meter by RF cable and attenuator, the path loss was compensated to the results for each measurement.
3. Set EUT at maximum power through base station.
4. Select lowest, middle, and highest channels for each band and different modulation.
5. Measure the maximum PK burst power and maximum Avg. burst power.
6. These measurements were done at 3 frequencies, 1850.20 MHz, 1880.00 MHz and 1907.60 MHz for WCDMA band II; 826.40 MHz, 836.60 MHz and 846.60 MHz for WCDMA band V. (low, middle and high of operational frequency range).

TEST CONDITION

RBW	VBW	Sweep Time	Span
10MHz	10MHz	800ms	50MHz

TEST RESULTS

UMTS/TM1/WCDMA V			
Channel	Frequency (MHz)	Peak (dBm)	Burst AV(dBm)
4132	826.40	22.30	22.09
4183	836.60	22.55	22.24
4233	846.60	22.08	21.87

UMTS/TM1/WCDMA II			
Channel	Frequency (MHz)	Peak (dBm)	Burst AV(dBm)
9262	1852.40	22.87	22.51
9400	1880.00	23.25	22.89
9538	1907.60	23.40	23.00

4.1.2. Radiated Output Power

TEST DESCRIPTION

This is the test for the maximum radiated power from the EUT.

Rule Part 24.232(c) specifies, "Mobile/portable stations are limited to 2 watts e.i.r.p. Peak power" and 24.232(e) specifies that "Peak transmit power must be measured over any interval of continuous transmission using instrumentation calibrated in terms of an rms-equivalent voltage." Rule Part 22.913(a) specifies "The ERP of mobile transmitters and auxiliary test transmitters must not exceed 7 Watts."

TEST CONFIGURATION

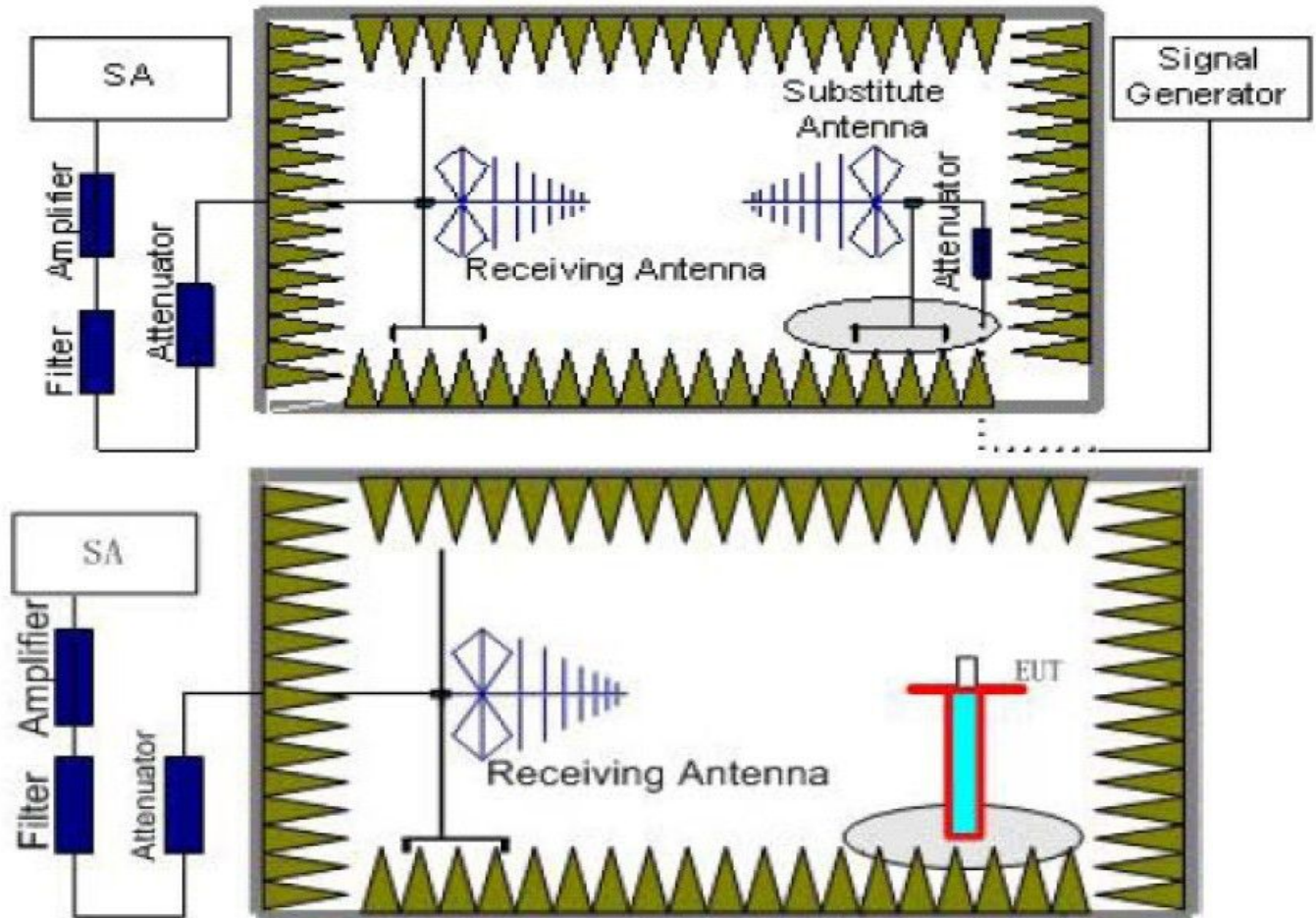

TEST PROCEDURE

1. EUT was placed on a 1.50 meter high non-conductive stand at a 3 meter test distance from the receive antenna. A receiving antenna was placed on the antenna mast 3 meters from the EUT for emission measurements. The height of receiving antenna is 1.50m. Detected emissions were maximized at each frequency by rotating the EUT through 360° and adjusting the receiving antenna polarization. The radiated emission measurements of all transmit frequencies in three channels (High, Middle, Low) were measured with peak detector.
2. A log-periodic antenna or double-ridged waveguide horn antenna shall be substituted in place of the EUT. The log-periodic antenna will be driven by a signal generator and the level will be adjusted till the same power value on the spectrum analyzer or receiver. The level of the spurious emissions can be calculated through the level of the signal generator, cable loss, the gain of the substitution antenna and the reading of the spectrum analyzer or receiver.
3. The EUT is then put into continuously transmitting mode at its maximum power level during the test. Set Test Receiver or Spectrum RBW=10MHz, VBW=10MHz, And the maximum value of the receiver should be recorded as (P_r).
4. The EUT shall be replaced by a substitution antenna. In the chamber, an substitution antenna for the frequency band of interest is placed at the reference point of the chamber. An RF Signal source for the frequency band of interest is connected to the substitution antenna with a cable that has been constructed to not interfere with the radiation pattern of the antenna. A power (P_{Mea}) is applied to the input of the substitution antenna, and adjust the level of the signal generator output until the value of the receiver

reach the previously recorded (P_r). The power of signal source (P_{Mea}) is recorded. The test should be performed by rotating the test item and adjusting the receiving antenna polarization.

5. A amplifier should be connected to the Signal Source output port. And the cable should be connect between the Amplifier and the Substitution Antenna. The cable loss (P_{cl}), the Substitution Antenna Gain (G_a) and the Amplifier Gain (P_{Ag}) should be recorded after test.

The measurement results are obtained as described below:

$$\text{Power(EIRP)} = P_{Mea} - P_{Ag} - P_{cl} + G_a$$

We used SMF100A microwave signal generator which signal level can up to 33dBm, so we not used power Amplifier for substitution test; The measurement results are amend as described below:

$$\text{Power(EIRP)} = P_{Mea} - P_{cl} + G_a$$

6. This value is EIRP since the measurement is calibrated using an antenna of known gain (2.15 dBi) and known input power.
7. ERP can be calculated from EIRP by subtracting the gain of the dipole, $ERP = EIRP - 2.15\text{dBi}$.

TEST LIMIT

Note: We test the H direction and V direction and V direction is worse.

According to 22.913(a) and 24.232(c), the ERP should be not exceeding following table limits:

	Burst Peak EIRP
WCDMA Band II	33dBm (2W)
	Burst Peak ERP
WCDMA Band V	38.45dBm (7W)

TEST RESULTS

UMTS/TM1/WCDMA Band II		
Frequency (MHz)	EIRP (dBm)	Polarization
1852.4	18.37	V
1880.0	18.20	V
1907.6	18.10	V
UMTS/TM1/ WCDMA Band V		
Frequency (MHz)	ERP (dBm)	Polarization
826.40	19.08	V
836.60	19.16	V
846.60	19.48	V

4.2. Radiated Spurious Emission

TEST APPLICABLE

According to the TIA/EIA 603D:2010 test method, The Receiver or Spectrum was scanned from 9 KHz to the 10th harmonic of the highest frequency generated within the equipment, which is the transmitted carrier that can be as high as 1910 MHz The resolution bandwidth is set as outlined in Part 24.238 and Part 22.917. The spectrum is scanned with the mobile station transmitting at carrier frequencies that pertain to low, mid and high channels of WCDMA Band II and WCDMA Band V.

TEST CONFIGURATION

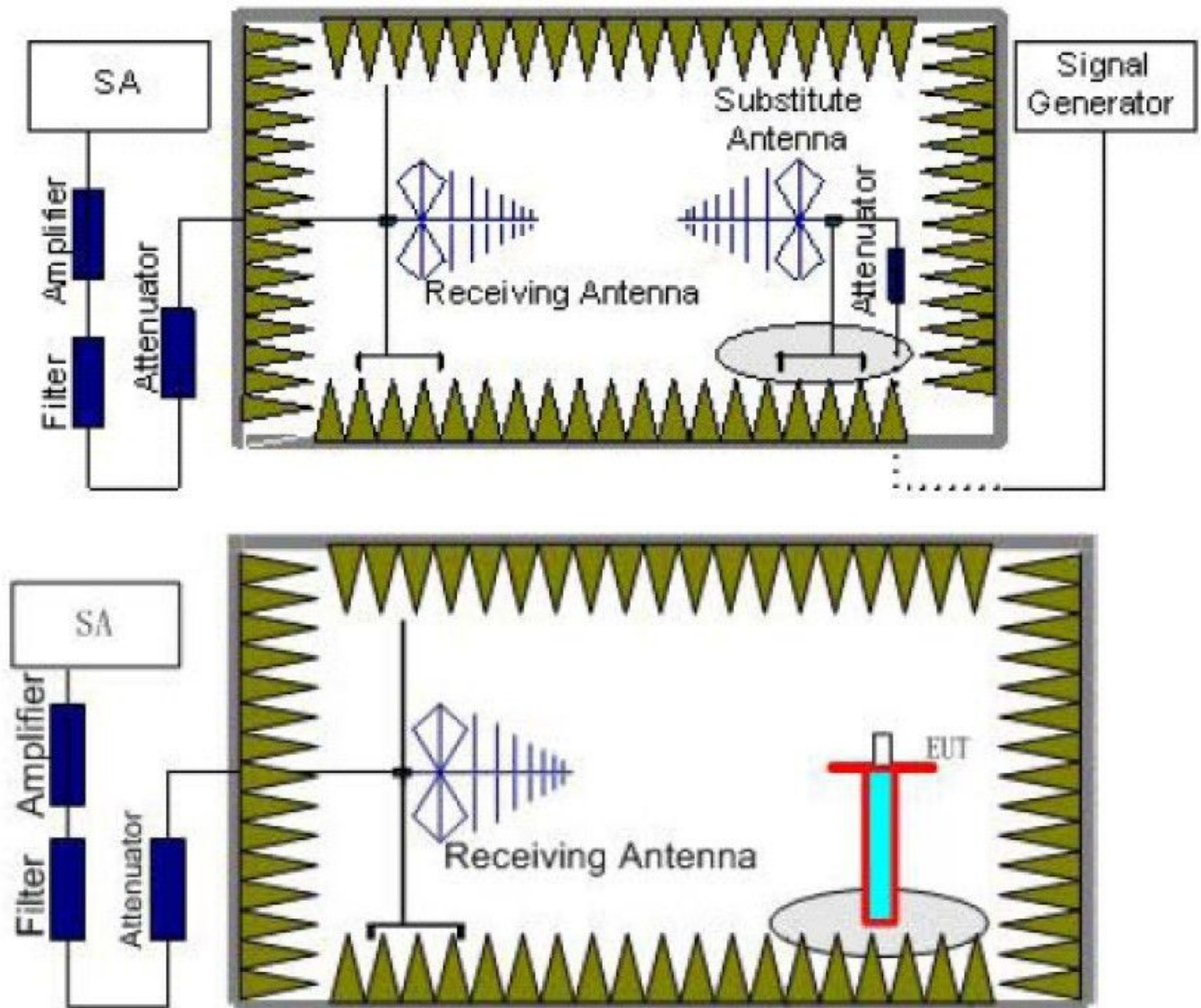

TEST PROCEDURE

1. EUT was placed on a 1.50 meter high non-conductive stand at a 3 meter test distance from the receive antenna. A receiving antenna was placed on the antenna mast 3 meters from the EUT for emission measurements. The height of receiving antenna is 1.50m. Detected emissions were maximized at each frequency by rotating the EUT through 360° and adjusting the receiving antenna polarization. The radiated emission measurements of all transmit frequencies in three channels (High, Middle, Low) were measured with peak detector.
2. A log-periodic antenna or double-ridged waveguide horn antenna shall be substituted in place of the EUT. The log-periodic antenna will be driven by a signal generator and the level will be adjusted till the same power value on the spectrum analyzer or receiver. The level of the spurious emissions can be calculated through the level of the signal generator, cable loss, the gain of the substitution antenna and the reading of the spectrum analyzer or receiver.

3. The EUT is then put into continuously transmitting mode at its maximum power level during the test. Set Test Receiver or Spectrum RBW=1MHz, VBW=3MHz, And the maximum value of the receiver should be recorded as (P_r).
4. The EUT shall be replaced by a substitution antenna. In the chamber, an substitution antenna for the frequency band of interest is placed at the reference point of the chamber. An RF Signal source for the frequency band of interest is connected to the substitution antenna with a cable that has been constructed to not interfere with the radiation pattern of the antenna. A power (P_{Mea}) is applied to the input of the substitution antenna, and adjust the level of the signal generator output until the value of the receiver reach the previously recorded (P_r). The power of signal source (P_{Mea}) is recorded. The test should be performed by rotating the test item and adjusting the receiving antenna polarization.
5. A amplifier should be connected to the Signal Source output port. And the cable should be connect between the Amplifier and the Substitution Antenna. The cable loss (P_{cl}), the Substitution Antenna Gain (G_a) and the Amplifier Gain (P_{Ag}) should be recorded after test.
The measurement results are obtained as described below:
Power(EIRP)= $P_{Mea} - P_{Ag} - P_{cl} + G_a$
6. This value is EIRP since the measurement is calibrated using an antenna of known gain (2.15 dBi) and known input power.
7. ERP can be calculated from EIRP by subtracting the gain of the dipole, ERP = EIRP -2.15dBi.
8. In order to make sure test results more clearly, we set frequency range and sweep time for difference frequency range as follows table:

Working Frequency	Subrange (GHz)	RBW	VBW	Sweep time (s)
UMTS/TM1/ WCDMA Band V	0.00009~0.15	1KHz	3KHz	30
	0.00015~0.03	10KHz	30KHz	10
	0.03~1	100KHz	300KHz	10
	1~2	1 MHz	3 MHz	2
	2~5	1 MHz	3 MHz	3
	5~8	1 MHz	3 MHz	3
	8~10	1 MHz	3 MHz	3
UMTS/TM1/ WCDMA Band II	0.00009~0.15	1KHz	3KHz	30
	0.00015~0.03	10KHz	30KHz	10
	0.03~1	100KHz	300KHz	10
	1~2	1 MHz	3 MHz	2
	2~5	1 MHz	3 MHz	3
	5~8	1 MHz	3 MHz	3
	8~11	1 MHz	3 MHz	3
	11~14	1 MHz	3 MHz	3
	14~18	1 MHz	3 MHz	3
	18~20	1 MHz	3 MHz	2

TEST LIMITS

According to 24.238 and 22.917 specify that the power of any emission outside of the authorized operating frequency ranges must be attenuated below the transmitting power (P) by a factor of at least $43 + 10 \log(P)$ dB.

The specification that emissions shall be attenuated below the transmitter power (P) by at least $43 + 10 \log(P)$ dB, translates in the relevant power range (1 to 0.001 W) to -13 dBm. At 1 W the specified minimum attenuation becomes 43 dB and relative to a 30 dBm (1 W) carrier becomes a limit of -13 dBm. At 0.001 W (0 dBm) the minimum attenuation is 13 dB, which again yields a limit of -13 dBm. In this way a translation of the specification from relative to absolute terms is carried out.

Frequency	Channel	Frequency Range	Verdict
UMTS/TM1/ WCDMA Band V	Low	9KHz-10GHz	PASS
	Middle	9KHz -10GHz	PASS
	High	9KHz -10GHz	PASS
UMTS/TM1/ WCDMA Band II	Low	9KHz -20GHz	PASS
	Middle	9KHz -20GHz	PASS
	High	9KHz -20GHz	PASS

UMTS/TM1/ WCDMA Band V							
Channel Number: 4132				Test Frequency: 826.40 MHz			
Frequency (MHz)	P _{Mea} (dBm)	Path Loss	Antenna Gain	Correction (dB)	Peak ERP(dBm)	Limit (dBm)	Polarization
1652.80	-42.08	4.32	6.77	2.15	-39.63	-13.00	H
2479.20	---			2.15	---	-13.00	H
1652.80	-35.41	4.32	6.77	2.15	-32.96	-13.00	V
2479.20	---			2.15	---	-13.00	V

UMTS/TM1/ WCDMA Band V							
Channel Number: 4183				Test Frequency: 836.60 MHz			
Frequency (MHz)	P _{Mea} (dBm)	Path Loss	Antenna Gain	Correction (dB)	Peak ERP(dBm)	Limit (dBm)	Polarization
1673.20	-40.33	4.55	6.77	2.15	-38.11	-13.00	H
2509.80	---			2.15	---	-13.00	H
1673.20	-34.91	4.55	6.77	2.15	-32.69	-13.00	V
2509.80	---			2.15	---	-13.00	V

UMTS/TM1/ WCDMA Band V							
Channel Number: 4233				Test Frequency: 846.60 MHz			
Frequency (MHz)	P _{Mea} (dBm)	Path Loss	Antenna Gain	Correction (dB)	Peak ERP(dBm)	Limit (dBm)	Polarization
1693.20	-44.09	4.29	6.83	2.15	-41.55	-13.00	H
2539.80	---			2.15	---	-13.00	H
1693.20	-39.14	4.29	6.83	2.15	-36.6	-13.00	V
2539.80	---			2.15	---	-13.00	V

UMTS/TM1/ WCDMA Band II							
Channel Number: 9262				Test Frequency: 1852.40 MHz			
Frequency (MHz)	P _{Mea} (dBm)	Path Loss	Antenna Gain	Correction (dB)	Peak ERP(dBm)	Limit (dBm)	Polarization
3704.80	-45.51	4.55	12.34	2.15	-37.72	-13.00	H
5557.20	---			2.15	---	-13.00	H
3704.80	-46.68	4.55	12.34	2.15	-38.89	-13.00	V
5557.20	---			2.15	---	-13.00	V

UMTS/TM1/ WCDMA Band II							
Channel Number: 9400				Test Frequency: 1880.00 MHz			
Frequency (MHz)	P _{Mea} (dBm)	Path Loss	Antenna Gain	Correction (dB)	Peak ERP(dBm)	Limit (dBm)	Polarization
3760.00	-44.19	4.55	12.40	2.15	-36.34	-13.00	H
5640.00	---			2.15	---	-13.00	H
3760.00	-46.22	4.55	12.40	2.15	-38.37	-13.00	V
5640.00	---			2.15	---	-13.00	V

UMTS/TM1/ WCDMA Band II							
Channel Number: 9538				Test Frequency: 1907.60 MHz			
Frequency (MHz)	P _{Mea} (dBm)	Path Loss	Antenna Gain	Correction (dB)	Peak ERP(dBm)	Limit (dBm)	Polarization
3815.20	-45.39	4.51	12.43	2.15	-37.47	-13.00	H
5722.80	---			2.15	---	-13.00	H
3815.20	-47.70	4.51	12.43	2.15	-39.78	-13.00	V
5722.80	---			2.15	---	-13.00	V

Note:

1. In general, the worse case attenuation requirement shown above was applied.
2. *** means that the emission level is too low to be measured or at least 20 dB down than the limit.

4.3. Occupied Bandwidth and Emission Bandwidth

TEST APPLICABLE

Similar to conducted emissions; occupied bandwidth measurements are only provided for selected frequencies in order to reduce the amount of submitted data. Data were taken at the extreme and mid frequencies of WCDMA Band II and WCDMA band V. The table below lists the measured 99% Bandwidth and -26dBc Bandwidth.

TEST CONFIGURATION

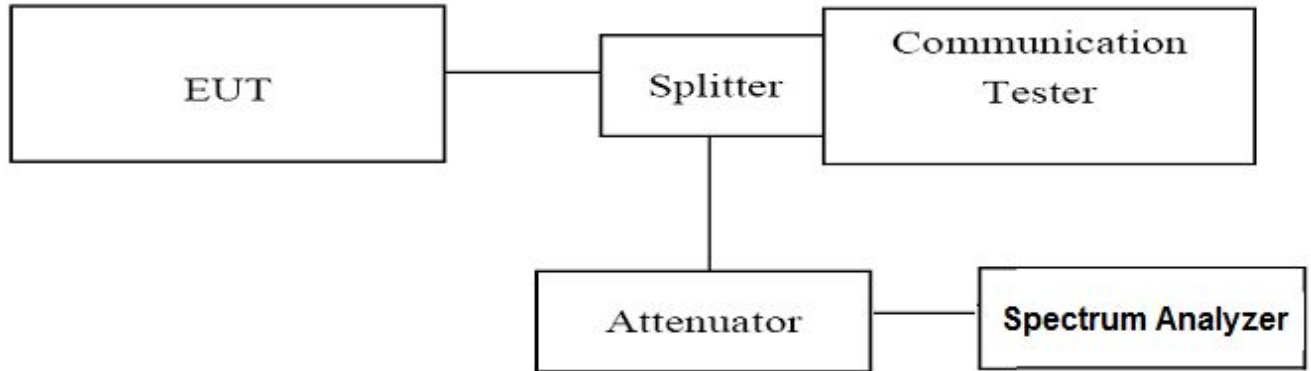

TEST PROCEDURE

1. The EUT was set up for the max output power with pseudo random data modulation;
2. The Occupied bandwidth and Emission Bandwidth were measured with Spectrum Analyzer FSU26(peak);
3. Set RBW=50 KHz,VBW=300 KHz,Span=10MHz;
4. Set SPA Max hold and View, Set 99% Occupied Bandwidth/ Set -26dBc Occupied Bandwidth
5. These measurements were done at 3 frequencies, 1850.20 MHz, 1880.00 MHz and 1709.80 MHz for WCDMA band II; 826.40 MHz, 836.60 MHz and 846.60 MHz for WCDMA band V. (low, middle and high of operational frequency range).

TEST RESULTS

UMTS/TM1/ WCDMA Band II				
Channel Number	Frequency (MHz)	Occupied Bandwidth (99% BW) (kHz)	Emission Bandwidth (26 dBc BW) (kHz)	Verdict
9262	1852.4	4182.7	4663	PASS
9400	1880.0	4166.7	4663	PASS
9538	1907.6	4166.7	4696	PASS

UMTS/TM1/ WCDMA Band V				
Channel Number	Frequency (MHz)	Occupied Bandwidth (99% BW) (kHz)	Emission Bandwidth (26 dBc BW) (kHz)	Verdict
4132	826.40	4198.7	4663	PASS
4183	836.60	4182.7	4663	PASS
4233	846.60	4150.6	4663	PASS

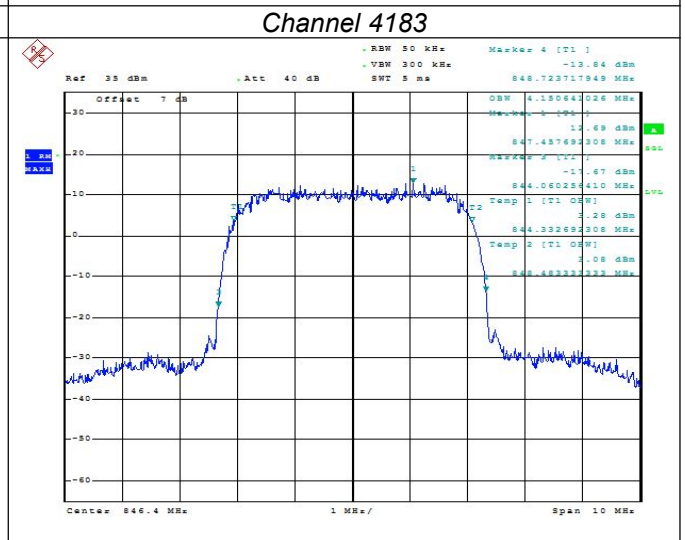
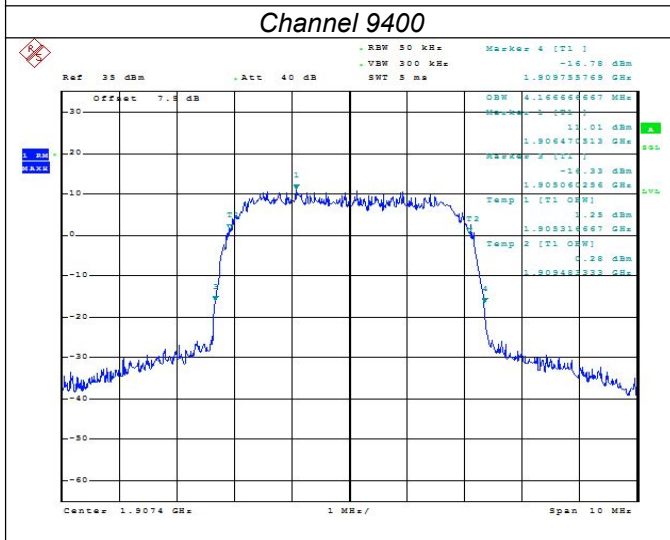
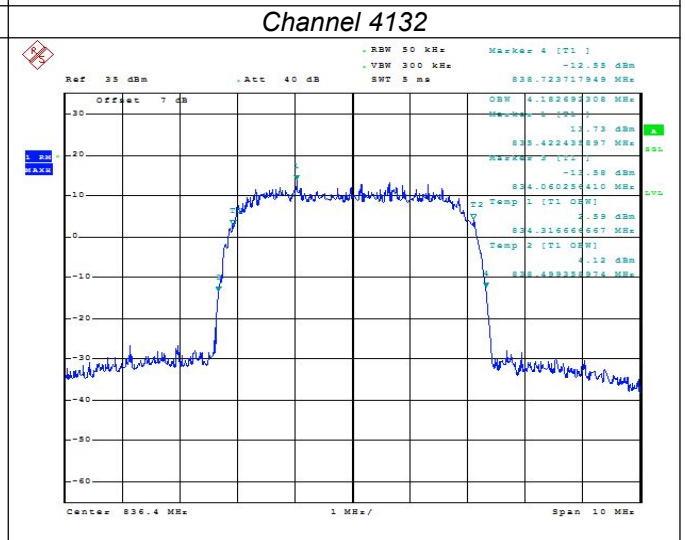
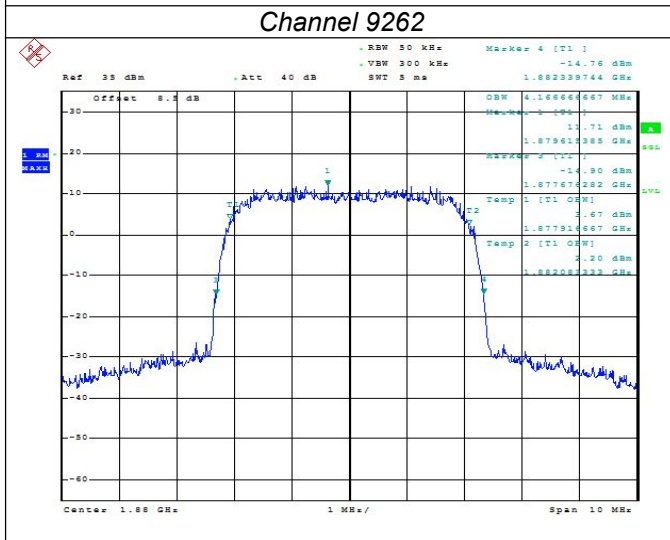
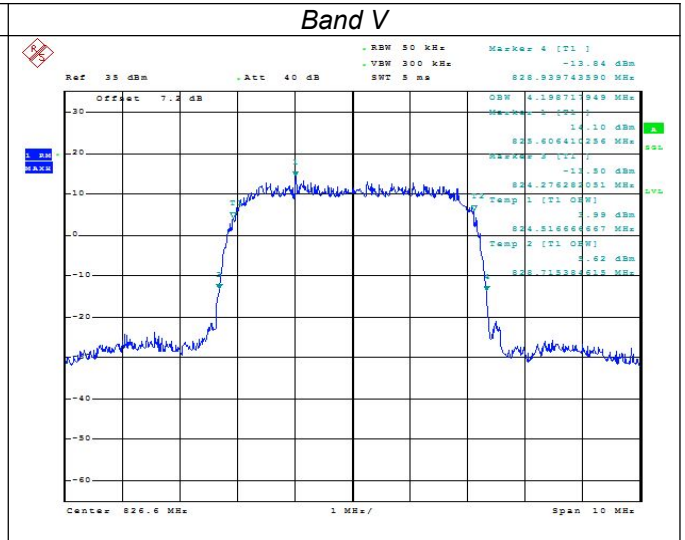
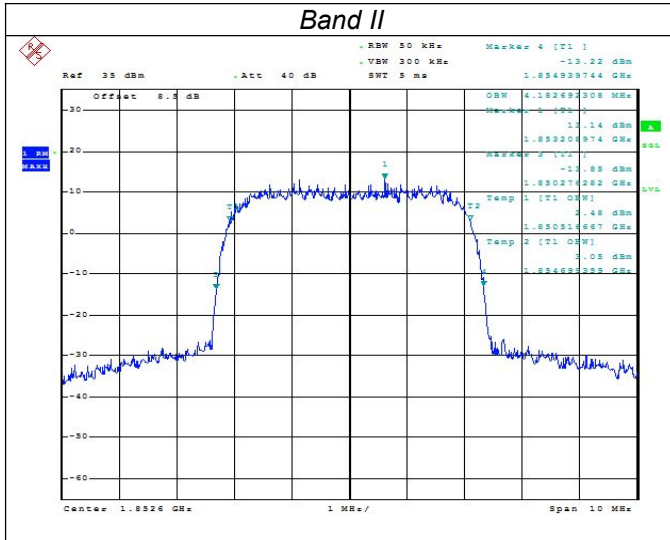

Channel 9538

Channel 4233

4.4. Band Edge Compliance

TEST APPLICABLE

During the process of testing, the EUT was controlled via Agilent Digital Radio Communication tester (CMU200) to ensure max power transmission and proper modulation.

TEST CONFIGURATION

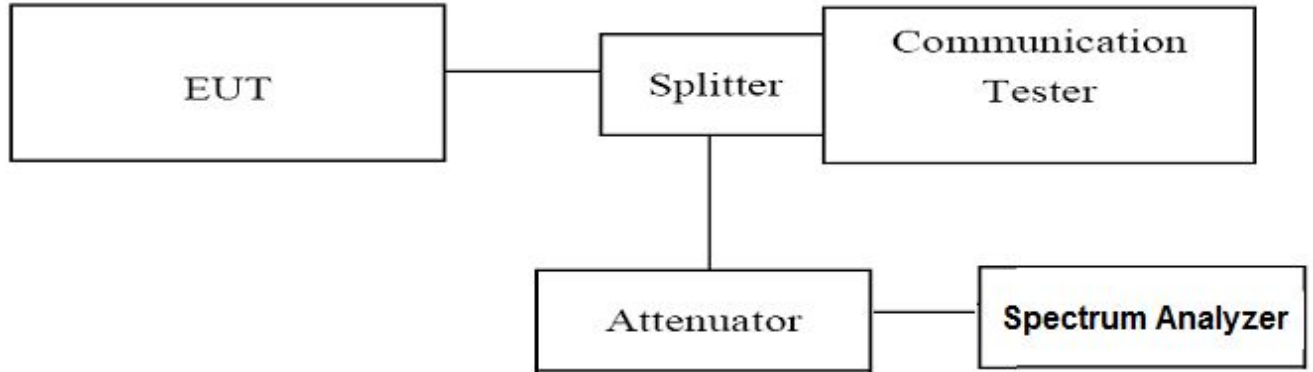

TEST PROCEDURE

1. The EUT was set up for the max output power with pseudo random data modulation;
2. The power was measured with Spectrum Analyzer FSU26;
3. Set RBW=50 KHz,VBW=300 KHz,Span=2MHz,;Detector: RMS;
4. These measurements were done at 2 frequencies, 1850.20 MHz and 1709.80 MHz for WCDMA band II; 826.40 MHz and 846.60 MHz for WCDMA band V. (low and high of operational frequency range).

TEST RESULTS

WCDMA Band II					
Channel Number	Frequency (MHz)	Measurement Results		Limit (dBm)	Verdict
		Frequency (MHz)	Values (dBm)		
9262	1852.4	1849.91	-24.76	-13.00	Pass
9538	1907.6	1910.04	-25.94	-13.00	Pass

WCDMA Band V					
Channel Number	Frequency (MHz)	Measurement Results		Limit (dBm)	Verdict
		Frequency (MHz)	Values (dBm)		
4132	826.4	823.01	-23.30	-13.00	Pass
4233	846.6	849.93	-26.29	-13.00	Pass

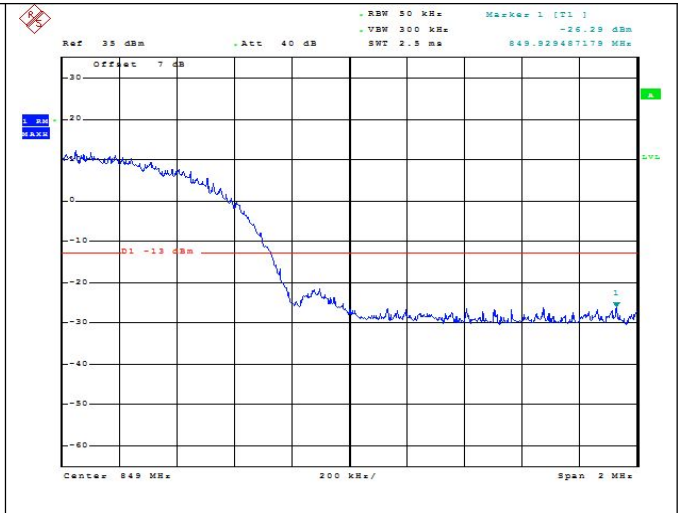
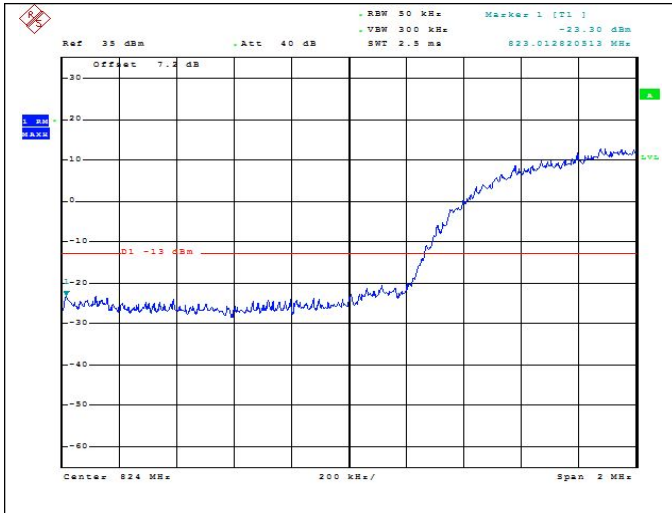

4.5. Spurious Emission on Antenna Port

TEST APPLICABLE

The following steps outline the procedure used to measure the conducted emissions from the EUT.

1. Determine frequency range for measurements: From CFR 2.1057 the spectrum should be investigated from the lowest radio frequency generated in the equipment up to at least the 10th harmonic of the carrier frequency. For the equipment of WCDMA band II, this equates to a frequency range of 9 KHz to 20GHz, data taken from 9 KHz to 25 GHz. For WCDMA Band V, data taken from 9 KHz to 13.6 GHz.
2. The sweep time is set automatically by instrument itself. That should be the optimal sweep time for the span and the RBW. If the sweep time is too short, that is sweep is too fast, the sweep result is not accurate; if the sweep time is too long, that is sweep is too low, some frequency components may be lost. The instrument will give an optimal sweep time according the selected span and RBW.
3. The procedure to get the conducted spurious emission is as follows:
The trace mode is set to MaxHold to get the highest signal at each frequency;
Wait 25 seconds;
Get the result.
4. Determine EUT transmit frequencies: below outlines the band edge frequencies pertinent to conducted emissions testing.

TEST CONFIGURATION

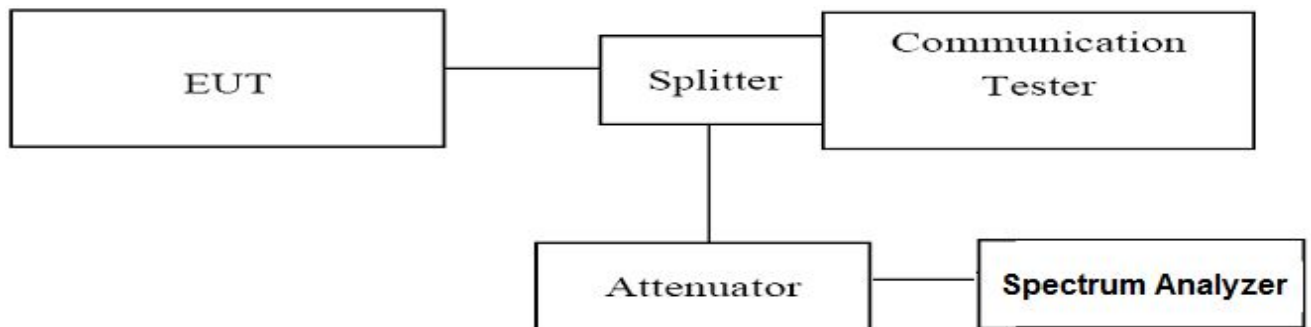

TEST PROCEDURE

1. The EUT was set up for the max output power with pseudo random data modulation;
2. The power was measured with Rhode & Schwarz Spectrum Analyzer FSU (peak) and Agilent Spectrum Analyzer N9020A (peak);
3. These measurements were done at 3 frequencies, 1850.20 MHz, 1880.00 MHz and 1709.80 MHz for WCDMA band II; 826.40 MHz, 836.60 MHz and 846.60 MHz for WCDMA band V. (low, middle and high of operational frequency range).

TEST LIMIT

Part 24.238 and Part 22.917 specify that the power of any emission outside of the authorized operating frequency ranges must be attenuated below the transmitting power (P) by a factor of at least $43 + 10 \log(P)$ dB.

The specification that emissions shall be attenuated below the transmitter power (P) by at least $43 + 10 \log(P)$ dB, translates in the relevant power range (1 to 0.001 W) to -13 dBm. At 1 W the specified minimum attenuation becomes 43 dB and relative to a 30 dBm (1 W) carrier becomes a limit of -13 dBm. At 0.001 W (0 dBm) the minimum attenuation is 13 dB, which again yields a limit of -13 dBm. In this way a translation of the specification from relative to absolute terms is carried out.

TEST RESULTS

4.6.1 For UMTS/TM1/WCDMA Band II Test Results

A. Test Verdict

Test Mode/ Channel	Frequency (MHz)	Frequency Range	Limit (dBm)	Verdict
UMTS/TM1/WCDMA Band II/9262	1852.40	30MHz-1GHz	-13.00	PASS
		1GHz-7GHz	-13.00	PASS
		7GHz-13.6GHz	-13.00	PASS
		13.6GHz-20GHz	-13.00	PASS
UMTS/TM1/WCDMA Band II/9400	1880.00	30MHz-1GHz	-13.00	PASS
		1GHz-7GHz	-13.00	PASS
		7GHz-13.6GHz	-13.00	PASS
		13.6GHz-20GHz	-13.00	PASS
UMTS/TM1/WCDMA Band II/9538	1907.60	30MHz-1GHz	-13.00	PASS
		1GHz-7GHz	-13.00	PASS
		7GHz-13.6GHz	-13.00	PASS
		13.6GHz-20GHz	-13.00	PASS

Note:

1. In general, the worse case attenuation requirement shown above was applied.
2. *** means that the emission level is too low to be measured or at least 20 dB down than the limit.

B. Test Plots

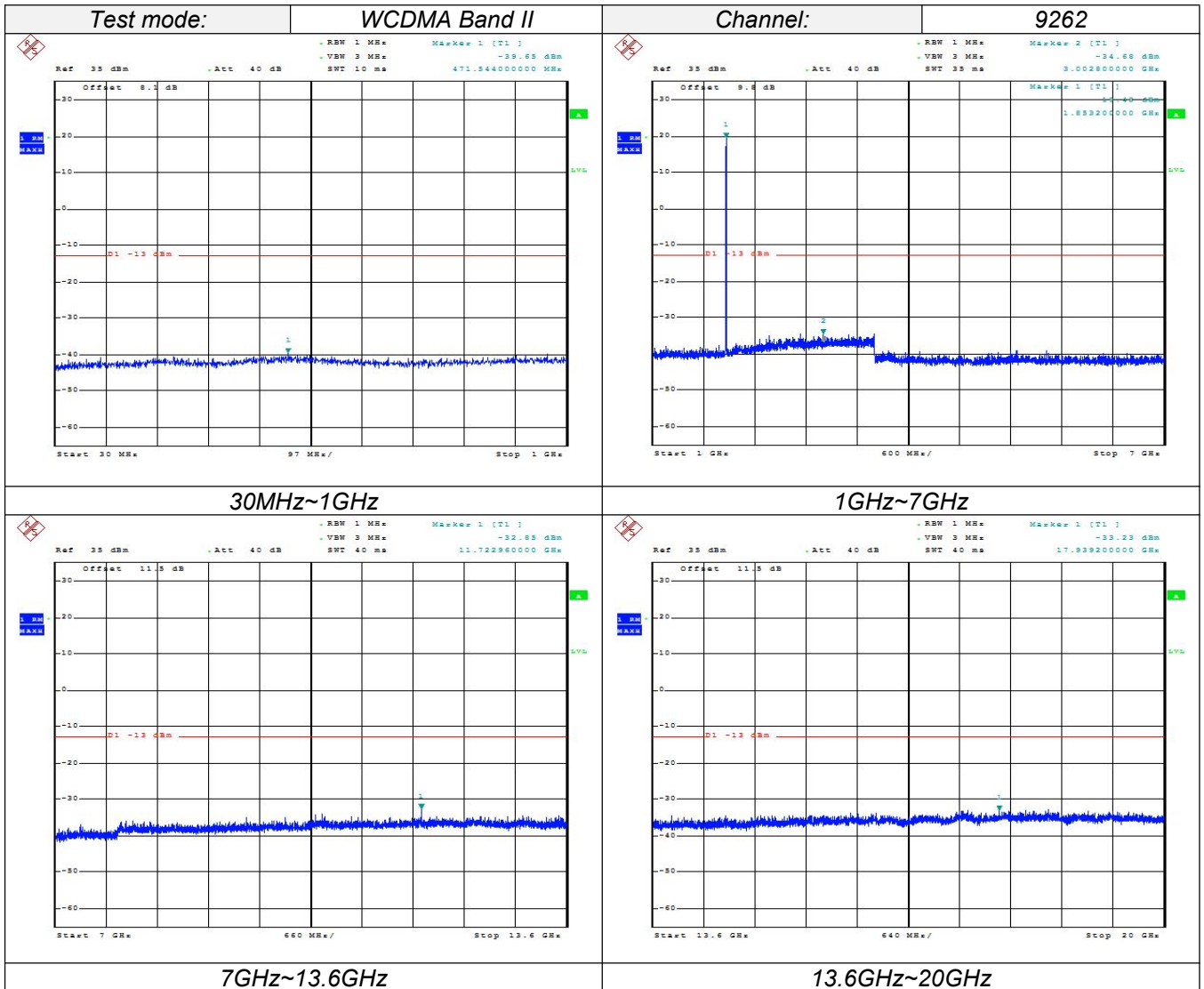

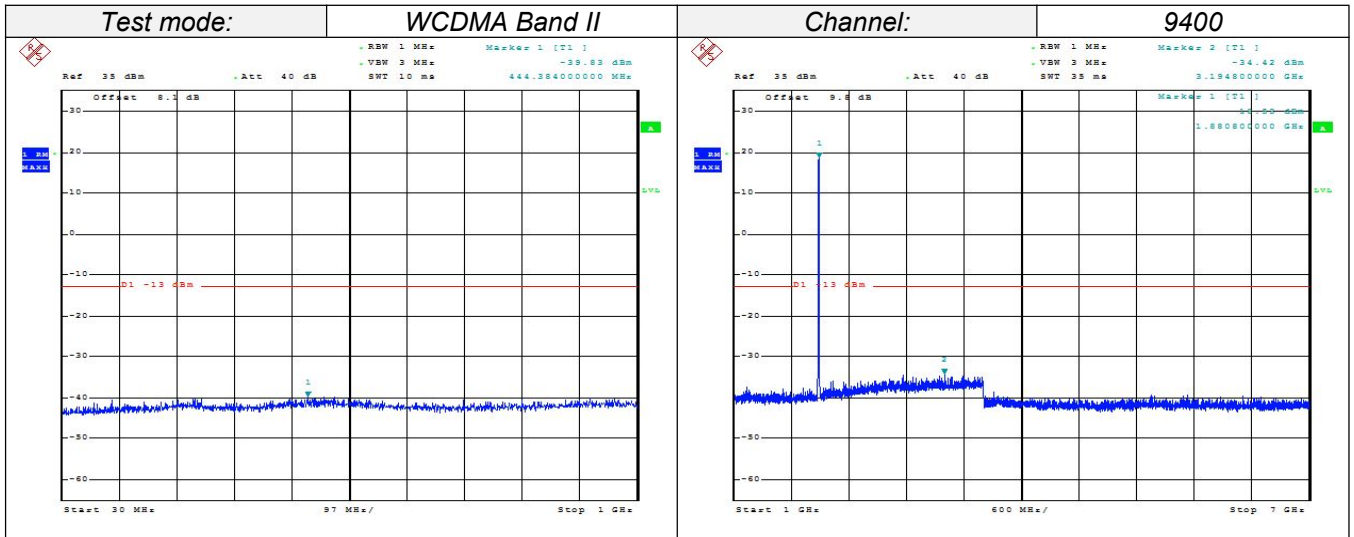

30MHz~1GHz

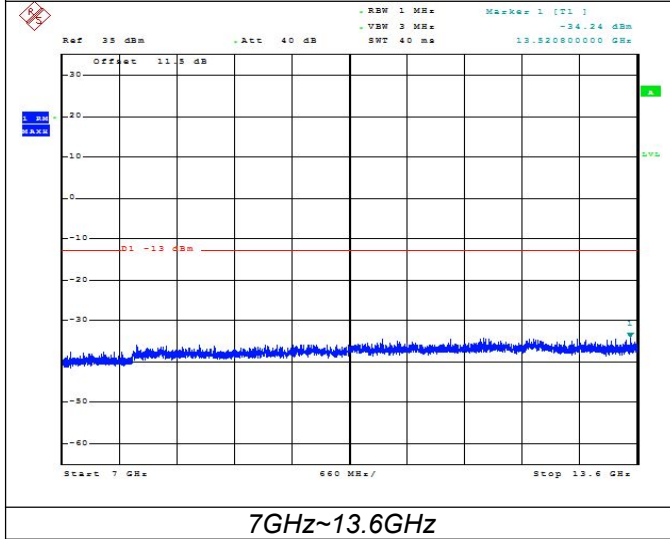

7GHz~13.6GHz

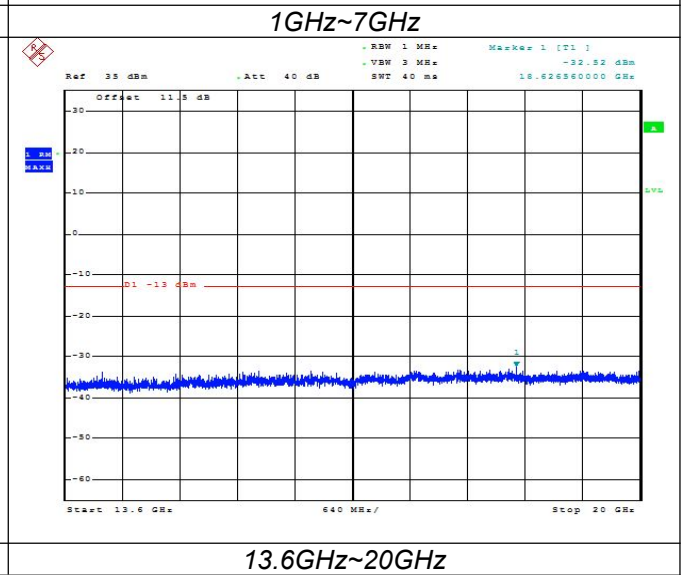

1GHz~7GHz

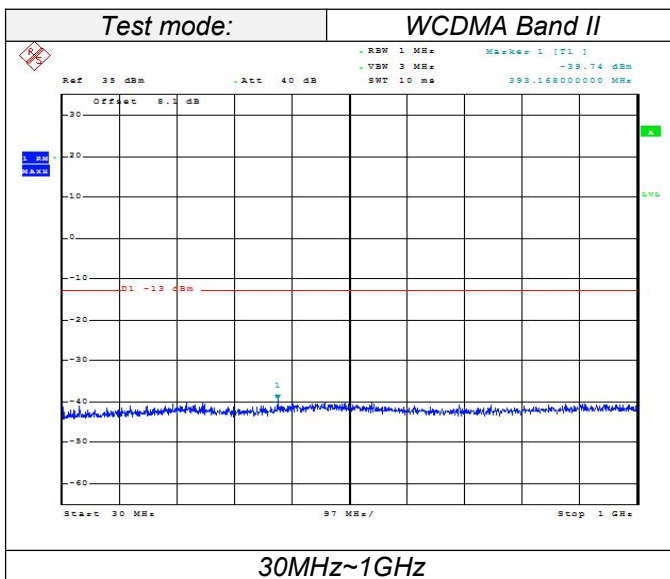

30MHz~1GHz

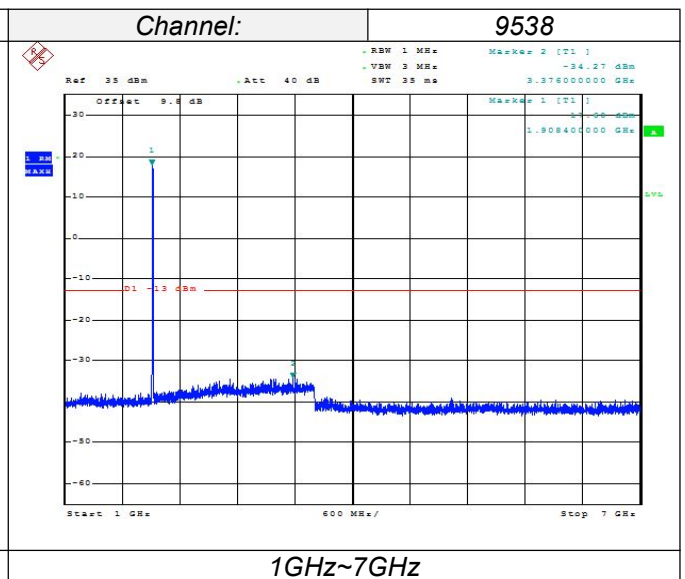

1GHz~7GHz

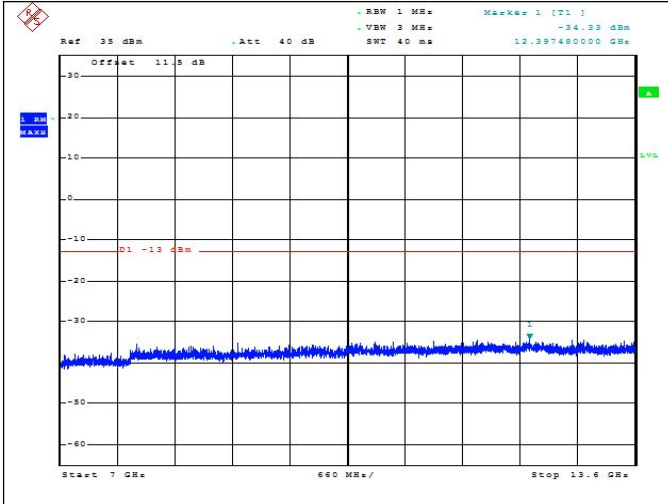

7GHz~13.6GHz

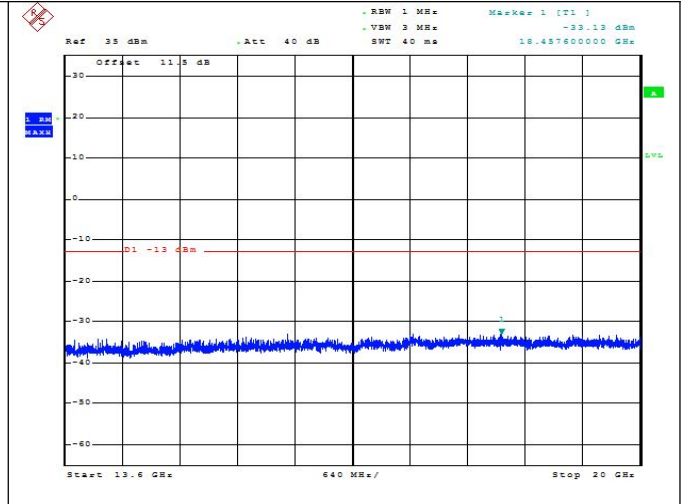

13.6GHz~20GHz

4.6.2 For UMTS/TM1/WCDMA Band V Test Results

A. Test Verdict

Test Mode/ Channel	Frequency (MHz)	Frequency Range	Limit (dBm)	Verdict
UMTS/TM1/WCDMA Band V/4132	826.40	30MHz-1GHz	-13.00	PASS
		1GHz-9GHz	-13.00	PASS
UMTS/TM1/WCDMA Band V/4183	836.60	30MHz-1GHz	-13.00	PASS
		1GHz-9GHz	-13.00	PASS
UMTS/TM1/WCDMA Band V/4233	846.60	30MHz-1GHz	-13.00	PASS
		1GHz-9GHz	-13.00	PASS

Note:

1. In general, the worse case attenuation requirement shown above was applied.
2. "----" means that the emission level is too low to be measured or at least 20 dB down than the limit.

B. Test Plots

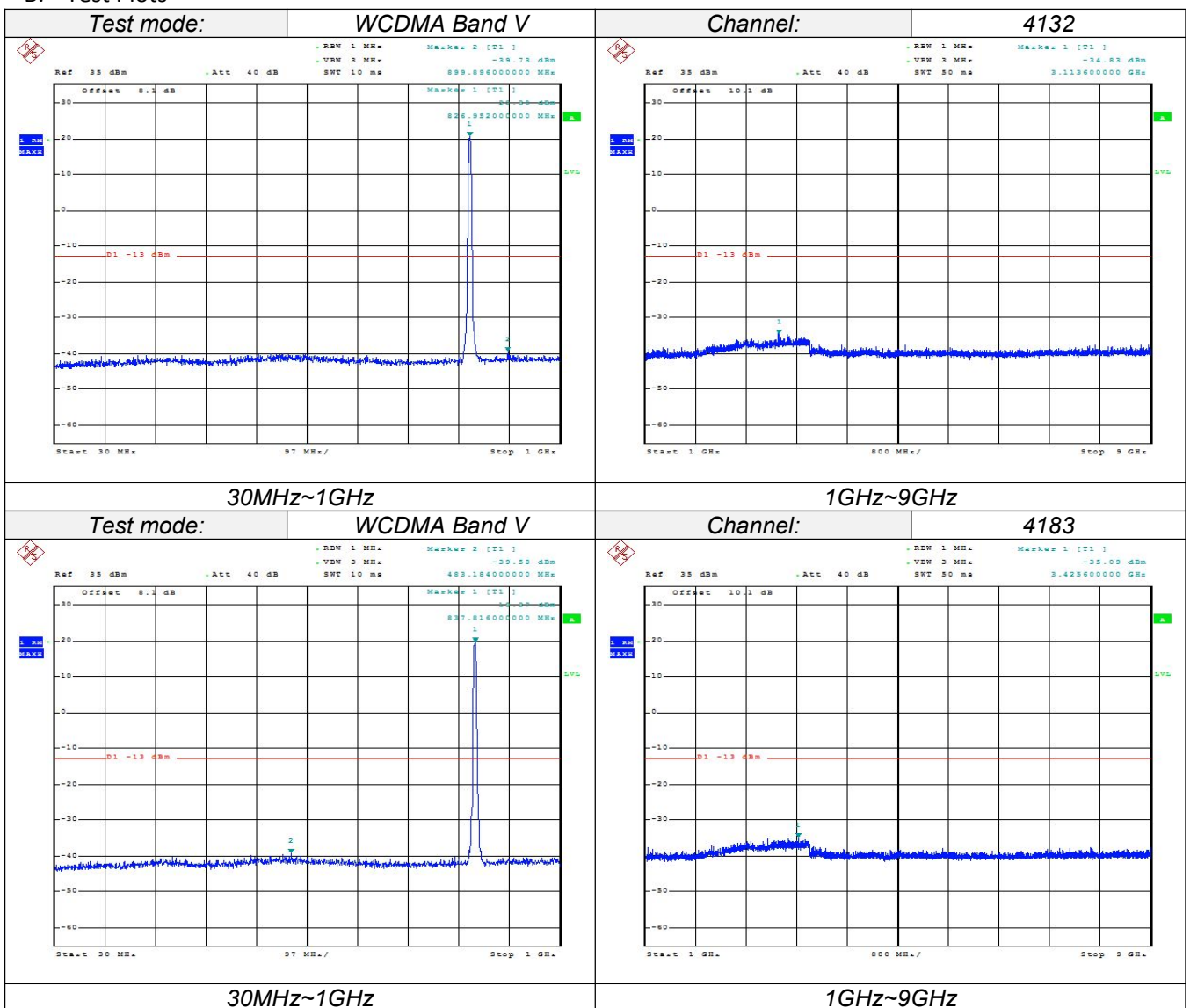

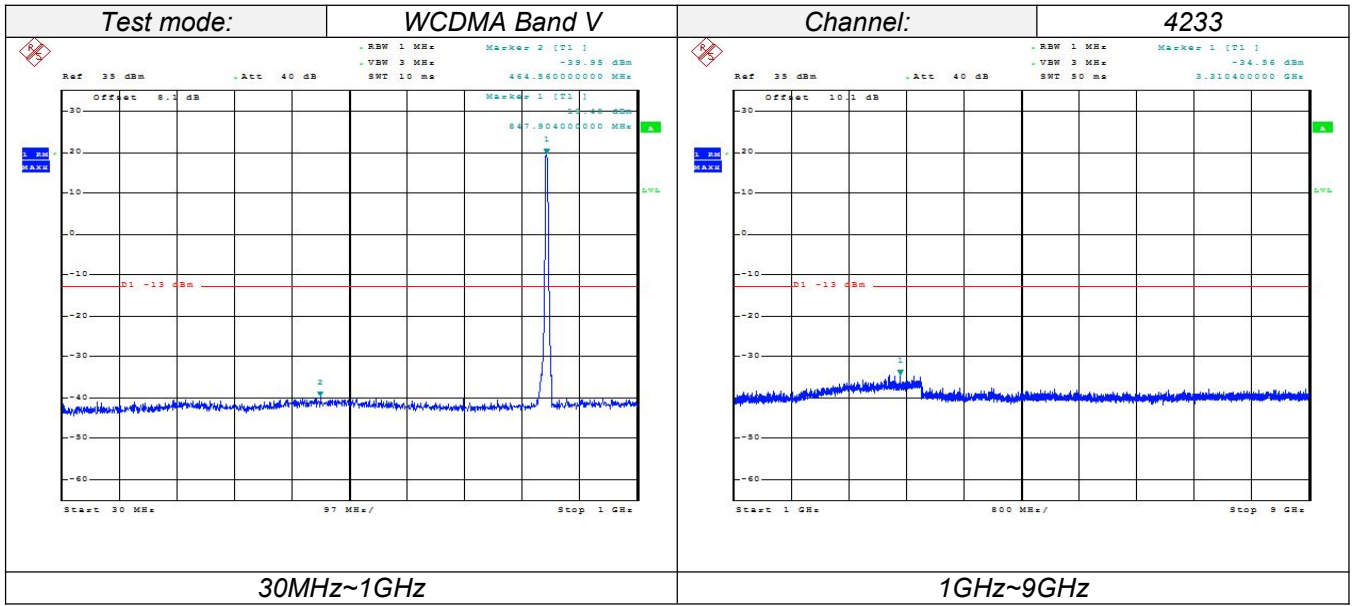

4.6. Frequency Stability Test

TEST APPLICABLE

1. According to FCC Part 2 Section 2.1055 (a)(1), the frequency stability shall be measured with variation of ambient temperature from -30°C to $+50^{\circ}\text{C}$ centigrade.
2. According to FCC Part 2 Section 2.1055 (E) (2), for battery powered equipment, the frequency stability shall be measured with reducing primary supply voltage to the battery operating end point, which is specified by the manufacture.
3. Vary primary supply voltage from 85 to 115 percent of the nominal value for other than hand carried voltage equipment and the end voltage point was 3.40V.

TEST PROCEDURE

In order to measure the carrier frequency under the condition of AFC lock, it is necessary to make measurements with the EUT in a "call mode". This is accomplished with the use of R&S CMU200 DIGITAL RADIO COMMUNICATION TESTER.

1. Measure the carrier frequency at room temperature;
2. Subject the EUT to overnight soak at -30°C ;
3. With the EUT, powered via nominal voltage, connected to the CMU200 and in a simulated call on middle channel of PCS 1900 and GSM850, measure the carrier frequency. These measurements should be made within 2 minutes of Powering up the EUT, to prevent significant self-warming;
4. Repeat the above measurements at 10°C increments from -30°C to $+50^{\circ}\text{C}$. Allow at least 0.5 hours at each temperature, unpowered, before making measurements;
5. Remeasure carrier frequency at room temperature with nominal voltage. Vary supply voltage from minimum voltage to maximum voltage, in 0.1Volt increments remeasuring carrier frequency at each voltage. Pause at nominal voltage for 0.5 hours unpowered, to allow any self-heating to stabilize, before continuing;
6. Subject the EUT to overnight soak at $+50^{\circ}\text{C}$;
7. With the EUT, powered via nominal voltage, connected to the CMU200 and in a simulated call on the centre channel, measure the carrier frequency. These measurements should be made within 2 minutes of Powering up the EUT, to prevent significant self-warming;
8. Repeat the above measurements at 10°C increments from $+50^{\circ}\text{C}$ to -30°C . Allow at least 0.5 hours at each temperature, unpowered, before making measurements;
9. At all temperature levels hold the temperature to $\pm 0.5^{\circ}\text{C}$ during the measurement procedure;

TEST CONFIGURATION

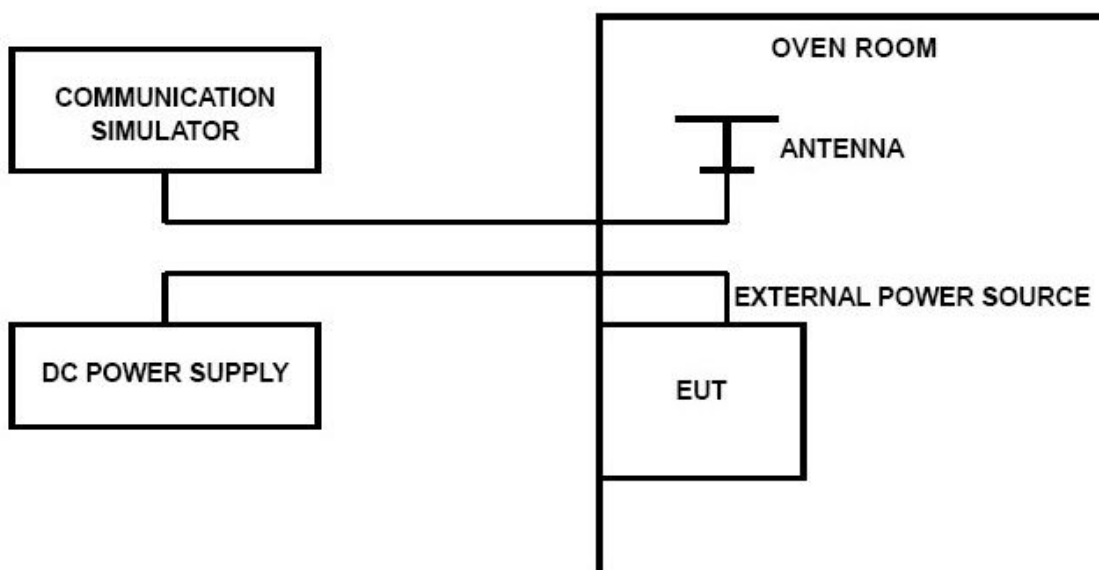

TEST LIMITS

For Hand carried battery powered equipment

According to the JTC standard the frequency stability of the carrier shall be accurate to within 0.1 ppm of the received frequency from the base station. This accuracy is sufficient to meet Sec. 24.235, Frequency Stability.

The frequency stability shall be sufficient to ensure that the fundamental emission stays within the authorized frequency block. As this transceiver is considered "Hand carried, battery powered equipment" Section 2.1055(d)(2) applies. This requires that the lower voltage for frequency stability testing be specified by the manufacturer. This transceiver is specified to operate with an input voltage of between 3.50VDC and 4.35VDC, with a nominal voltage of 3.80DC. Operation above or below these voltage limits is prohibited by transceiver software in order to prevent improper operation as well as to protect components from overstress. These voltages represent a tolerance of -10 % and +12.5 %. For the purposes of measuring frequency stability these voltage limits are to be used.

For equipment powered by primary supply voltage

According to the JTC standard the frequency stability of the carrier shall be accurate to within 0.1 ppm of the received frequency from the base station. This accuracy is sufficient to meet Sec. 24.235, Frequency Stability. The frequency stability shall be sufficient to ensure that the fundamental emission stays within the authorized frequency block. For this EUT section 2.1055(d)(1) applies. This requires varying primary supply voltage from 85 to 115 percent of the nominal value for other than hand carried battery equipment.

TEST RESULTS

UMTS/TM1/WCDMA Band II					
DC Power	Temperature (°C)	Frequency error(Hz)	Frequency error(ppm)	Limit (ppm)	Verdict
3.50	25	37.54	0.02	2.50	PASS
3.80	25	30.44	0.02	2.50	PASS
4.35	25	35.02	0.02	2.50	PASS
3.80	-30	32.50	0.02	2.50	PASS
3.80	-20	33.42	0.02	2.50	PASS
3.80	-10	39.37	0.02	2.50	PASS
3.80	0	29.53	0.02	2.50	PASS
3.80	10	31.81	0.02	2.50	PASS
3.80	20	34.10	0.02	2.50	PASS
3.80	30	39.14	0.02	2.50	PASS
3.80	40	32.50	0.02	2.50	PASS
3.80	50	37.49	0.02	2.50	PASS

UMTS/TM1/WCDMA Band V					
DC Power	Temperature (°C)	Frequency error(Hz)	Frequency error(ppm)	Limit (ppm)	Verdict
3.50	20	17.40	0.02	2.50	PASS
3.80	20	14.19	0.02	2.50	PASS
4.35	20	20.37	0.02	2.50	PASS
3.80	-30	14.42	0.02	2.50	PASS
3.80	-20	18.54	0.02	2.50	PASS
3.80	-10	18.31	0.02	2.50	PASS
3.80	0	23.12	0.03	2.50	PASS
3.80	10	13.50	0.02	2.50	PASS
3.80	20	14.19	0.02	2.50	PASS
3.80	30	19.00	0.02	2.50	PASS
3.80	40	12.59	0.02	2.50	PASS
3.80	50	17.39	0.02	2.50	PASS

5. Test Setup Photos of the EUT



.....End of Report.....