

## FCC PART 22/24 TEST REPORT

### FCC Part 22 /Part 24

**Report Reference No.....: MWR1411000102**

**FCC ID.....: RQQLT-E355**

Compiled by  
( position+printed name+signature)..: File administrators Martin Ao



Supervised by  
( position+printed name+signature)..: Test Engineer Martin Ao



Approved by  
( position+printed name+signature)..: Manager Dixon Hao



Date of issue.....: Nov 07, 2014

**Representative Laboratory Name. : Maxwell International Co., Ltd.**

Address.....: Room 509, Hongfa center building, Baoan District, Shenzhen, Guangdong, China

**Testing Laboratory Name.....: Shenzhen CTL Testing Technology Co., Ltd.**

Address.....: Floor 1-A, Baisha Technology Park, No. 3011, Shahehexi Road, Nanshan, Shenzhen, China

**Applicant's name.....: HYUNDAI CORPORATION**

Address.....: 140-2, Kye-dong, Chongro-ku, Seoul, South Korea

**Test specification.....:**

Standard.....: **FCC Part 22: PUBLIC MOBILE SERVICES**

**FCC Part 24: PERSONAL COMMUNICATIONS SERVICES**

TRF Originator.....: Maxwell International Co., Ltd.

Master TRF.....: Dated 2011-05

**Maxwell International Co., Ltd. All rights reserved.**

This publication may be reproduced in whole or in part for non-commercial purposes as long as the Maxwell International Co., Ltd. as copyright owner and source of the material. Maxwell International Co., Ltd. takes no responsibility for and will not assume liability for damages resulting from the reader's interpretation of the reproduced material due to its placement and context.

**Test item description.....: Mobile Phone**

Trade Mark.....: HYUNDAI

**Manufacturer.....: WASAM TECHNOLOGY (SHEN ZHEN) CO.,LTD.**

Model/Type reference.....: E355

Listed Models .....: E365

Ratings.....: DC 3.70V

Modulation .....: QPSK

Hardware version.....: WW805V 0.5

Software version .....: WW805\_72\_HS\_HYUNDAI\_3G\_324\_KK\_EN\_B25  
\_CO\_V03\_20141027\_1115

Frequency.....: WCDMA Band II & WCDMA Band V

Result.....: **PASS**

**TEST REPORT**

<b>Test Report No. :</b>	<b>MWR1411000102</b>	Nov 07, 2014 Date of issue
--------------------------	----------------------	-------------------------------

Equipment under Test : Mobile Phone

Model /Type : E355

Listed Models : E365

**Applicant** : **HYUNDAI CORPORATION**

Address : 140-2, Kye-dong, Chongro-ku, Seoul, South Korea

**Manufacturer** : **WASAM TECHNOLOGY (SHEN ZHEN) CO.,LTD.**

Address : B,F Building, (Hengqiang Industrial Park), Bogang Taifeng Industrial Zone, Shajing Town, Bao'an District, Shenzhen, China.

<b>Test Result:</b>	<b>PASS</b>
---------------------	-------------

The test report merely corresponds to the test sample.  
It is not permitted to copy extracts of these test result without the written permission of the test laboratory.

## Contents

<b>1. TEST STANDARDS .....</b>	<b>4</b>
<b>2. SUMMARY .....</b>	<b>5</b>
2.1. General Remarks.....	5
2.2. Product Description.....	5
2.3. Equipment under Test.....	5
2.4. Short description of the Equipment under Test (EUT).....	6
2.5. Internal Identification of AE used during the test.....	6
2.6. Normal Accessory setting.....	7
2.7. EUT configuration.....	7
2.8. Related Submittal(s) / Grant (s).....	7
2.9. Modifications.....	7
2.10. General Test Conditions/Configurations.....	7
2.11. Note.....	8
<b>3. TEST ENVIRONMENT .....</b>	<b>9</b>
3.1. Address of the test laboratory.....	9
3.2. Test Facility.....	9
3.3. Environmental conditions.....	9
3.4. Statement of the measurement uncertainty.....	9
3.5. Test Description.....	10
3.6. Equipments Used during the Test.....	11
<b>4. TEST CONDITIONS AND RESULTS .....</b>	<b>12</b>
4.1. OUTPUT POWER.....	12
4.2. Radiated Spurious Emssion.....	15
4.3. OCCUPIED BANDWIDTH.....	18
4.4. EMISSION BANDWIDTH.....	23
4.5. BAND EDGE COMPLIANCE.....	28
4.6. Spurious Emssion on Antenna Port.....	31
4.7. Frequency Stability Test.....	62
<b>5. TEST SETUP PHOTOS OF THE EUT .....</b>	<b>65</b>

## 1. TEST STANDARDS

The tests were performed according to following standards:

[FCC Part 22 \(10-1-12 Edition\)](#): PRIVATE LAND MOBILE RADIO SERVICES.

[FCC Part 24\(10-1-12 Edition\)](#): PUBLIC MOBILE SERVICES

[TIA/EIA 603 D June 2010](#): Land Mobile FM or PM Communications Equipment Measurement and Performance Standards.

[47 CFR FCC Part 15 Subpart B](#): - Unintentional Radiators

[FCC Part 2](#): FREQUENCY ALLOCA-TIONS AND RADIO TREATY MAT-TERS; GENERAL RULES AND REG-ULATIONS

[ANSI C63.4:2009](#): Methods of Measurement of Radio-Noise Emissions from Low-Voltage Electrical and Electronic Equipment in the Range of 9 kHz to 40 GHz

[FCC KDB971168D01](#) Power Meas License Digital Systems

## 2. SUMMARY

### 2.1. General Remarks

Date of receipt of test sample	:	Oct 10, 2014
Testing commenced on	:	Oct 11, 2014
Testing concluded on	:	Nov 06, 2014

### 2.2. Product Description

The **HYUNDAI CORPORATION's** Model: E355 or the "EUT" as referred to in this report; more general information as follows, for more details, refer to the user's manual of the EUT.

Name of EUT	Mobile Phone
Model Number	E355
FCC ID	RQQHLT-E355
Modulation Type	GMSK for GSM/GPRS;QPSK for WCDMA
Antenna Type	Internal
GSM/EDGE/GPRS	Supported GPRS
Extreme temp. Tolerance	-30°C to +50°C
Extreme vol. Limits	3.40VDC to 4.20VDC (nominal: 3.70VDC)
GSM Operation Frequency Band	GSM 850MHz/ PCS 1900MHz
GSM Release Version	R99
GPRS operation mode	Class B
GPRS Multislot Class	12
EGPRS Multislot Class	Only support downlink mode

### 2.3. Equipment under Test

#### Power supply system utilised

Power supply voltage	:	<input type="radio"/> 120V / 60 Hz	<input type="radio"/> 115V / 60Hz
		<input type="radio"/> 12 V DC	<input type="radio"/> 24 V DC
		<input checked="" type="radio"/> Other (specified in blank below)	

DC 3.70V

#### Test frequency list

Test Mode	TX/RX	RF Channel		
		Low(L)	Middle (M)	High (H)
GSM850	TX	Channel 128	Channel 190	Channel 251
		824.2 MHz	836.6 MHz	848.8 MHz
	RX	Channel 128	Channel 190	Channel 251
		869.2 MHz	881.6 MHz	893.8 MHz
Test Mode	TX/RX	RF Channel		
		Low(L)	Middle (M)	High (H)
GSM1900	TX	Channel 512	Channel 661	Channel 810
		1850.2 MHz	1880.0 MHz	1909.8 MHz
	RX	Channel 512	Channel 661	Channel 810
		1930.2 MHz	1960.0 MHz	1989.8 MHz
Test Mode	TX/RX	RF Channel		
		Low(L)	Middle (M)	High (H)
WCDMA850	TX	Channel 4132	Channel 4182	Channel 4233
		826.4 MHz	836.4 MHz	846.6 MHz

	RX	Channel 4357 871.4 MHz	Channel 4407 881.4 MHz	Channel 4458 891.6 MHz
Test Mode	TX/RX	RF Channel		
		Low(L)	Middle (M)	High (H)
WCDMA1900	TX	Channel 9262 1852.4 MHz	Channel 9400 1880.0 MHz	Channel 9538 1907.6 MHz
		RX	Channel 9662 1932.4 MHz	Channel 9800 1960.0 MHz

## 2.4. Short description of the Equipment under Test (EUT)

### 2.4.1 General Description

E355 is subscriber equipment in the WCDMA/GSM system. The HSPA/UMTS frequency band is Band II, Band V; The GSM/GPRS/EDGE (EDGE downlink only) frequency band includes GSM850 and GSM900 and DCS1800 and PCS1900, but only Band II and Band V and GSM850 and PCS1900 bands test data included in this report. The Mobile Phone implements such functions as RF signal receiving/transmitting, HSPA/UMTS and GSM/GPRS/EDGE protocol processing, voice, video MMS service, GPS, AGPS and WIFI etc. Externally it provides micro SD card interface, earphone port (to provide voice service) and SIM card interface. It also provides Bluetooth module to synchronize data between a PC and the phone, or to use the built-in modem of the phone to access the Internet with a PC, or to exchange data with other Bluetooth devices.

NOTE: Unless otherwise noted in the report, the functional boards installed in the units shall be selected from the below list, but not means all the functional boards listed below shall be installed in one unit.

### 2.4.3 Technical Specification

Characteristics	Description	
Radio System Type	<input checked="" type="checkbox"/> GSM/ <input checked="" type="checkbox"/> UMTS	
Supported Frequency Range	GSM850/WCDMA850	Transmission(TX): 824 to 849MHz Receiving(RX): 869 to 894MHz
	GSM1900/WCDMA1900	Transmission(TX): 1850 to 1910MHz Receiving(RX): 1930 to 1990MHz
TX and RX Antenna Ports	TX& RX port:	1
Supported Channel Bandwidth Designation of Emissions (Note: the necessary bandwidth of which is the worst value from the measured occupied bandwidths for each type of channel bandwidth configuration.)	GSM system:	200 kHz
	UMTS system:	5 MHz
	GSM850:	248KGXW
	GSM1900:	244KGXW
	UMTS 850:	4M17F9W
UMTS 1900:	4M18F9W	

## 2.5. Internal Identification of AE used during the test

AE ID*	Description
AE1	Battery
AE2	Charger

AE1

Model: E355

INPUT: 100-300V 50/60HZ 0.15A

OUTPUT: DC 5.0V,500mAh

\*AE ID: is used to identify the test sample in the lab internally.

## 2.6. Normal Accessory setting

Fully charged battery was used during the test.

## 2.7. EUT configuration

The following peripheral devices and interface cables were connected during the measurement:

● - supplied by the manufacturer

○ - supplied by the lab

<input type="radio"/>	Power Cable	Length (m) :	/
		Shield :	/
		Detachable :	/
<input type="radio"/>	Multimeter	Manufacturer :	/
		Model No. :	/

## 2.8. Related Submittal(s) / Grant (s)

This submittal(s) (test report) is intended for **FCC ID: RQQLT-E355** filing to comply with FCC Part 22 and Part 24 Rules

## 2.9. Modifications

No modifications were implemented to meet testing criteria.

## 2.10. General Test Conditions/Configurations

### 2.10.1 Test Modes

NOTE: The test mode(s) are selected according to relevant radio technology specifications.

Test Mode	Test Modes Description
GSM/TM1	GSM system, GSM, GMSK modulation
GSM/TM2	GSM system, GPRS, GMSK modulation
UMTS/TM1	WCDMA system, QPSK modulation
UMTS/TM2	HSDPA system, QPSK modulation
UMTS/TM3	HSUPA system, QPSK modulation

Note: This EUT owns two SIM cards, after we perform the pretest for these two SIM cards; we found the SIM 1 is the worst case, so its result is recorded in this report.

### 2.10.2 Test Environment

Environment Parameter	Selected Values During Tests	
Relative Humidity	Ambient	
Temperature	TN	Ambient
Voltage	VL	3.4V
	VN	3.7V
	VH	4.2V

NOTE: VL=lower extreme test voltage VN=nominal voltage  
VH=upper extreme test voltage TN=normal temperature

**2.11. Note**

1. The EUT is a Mobile Phone with WCDMA/GSM/GPRS,WiFi and Bluetooth fuction,The functions of the EUT listed as below:

	Test Standards	Reference Report
GSM/GPRS	FCC Part 22/FCC Part 24	MWR1411000101
WCDMA	FCC Part 22/FCC Part 24	MWR1411000102
Bluetooth	FCC Part 15 C 15.247	MWR1411000103
BLE	FCC Part 15 C 15.247	MWR1411000104
WiFi	FCC Part 15 C 15.247	MWR1411000105
USB Port	FCC Part 15 B	MWR1411000106
SAR	FCC Part 2 §2.1093	MWR1411000107



### 3. TEST ENVIRONMENT

#### 3.1. Address of the test laboratory

**Shenzhen CTL Testing Technology Co., Ltd.**

Floor 1-A, Baisha Technology Park, No. 3011, Shahexi Road, Nanshan, Shenzhen, China

The sites are constructed in conformance with the requirements of ANSI C63.7, ANSI C63.4 (2003) and CISPR Publication 22.

#### 3.2. Test Facility

The test facility is recognized, certified, or accredited by the following organizations:

##### FCC-Registration No.: 970318

Shenzhen CTL Testing Technology Co., Ltd. has been registered and fully described in a report filed with the (FCC) Federal Communications Commission. The acceptance letter from the FCC is maintained in our files. Registration 970318, Dec 19, 2013

#### 3.3. Environmental conditions

During the measurement the environmental conditions were within the listed ranges:

Temperature:	15-35 ° C
Humidity:	30-60 %
Atmospheric pressure:	950-1050mbar

#### 3.4. Statement of the measurement uncertainty

The data and results referenced in this document are true and accurate. The reader is cautioned that there may be errors within the calibration limits of the equipment and facilities. The measurement uncertainty was calculated for all measurements listed in this test report acc. to CISPR 16 - 4 „Specification for radio disturbance and immunity measuring apparatus and methods – Part 4: Uncertainty in EMC Measurements“ and is documented in the Shenzhen CTL Testing Technology Co., Ltd. quality system acc. to DIN EN ISO/IEC 17025. Furthermore, component and process variability of devices similar to that tested may result in additional deviation. The manufacturer has the sole responsibility of continued compliance of the device.

Hereafter the best measurement capability for Shenzhen CTL Testing Technology Co., Ltd. is reported:

Test Items	Measurement Uncertainty	Notes
Frequency stability	25 Hz	(1)
Transmitter power conducted	0.57 dB	(1)
Transmitter power Radiated	2.20 dB	(1)
Conducted spurious emission 9KHz-40 GHz	1.60 dB	(1)
Radiated spurious emission 9KHz-12.75 GHz	2.20 dB	(1)
Conducted Emission 9KHz-30MHz	3.39 dB	(1)
Radiated Emission 9KHz-30MHz	2.88 dB	(1)
Radiated Emission 30~1000MHz	4.24 dB	(1)
Radiated Emissio 1~18GHz	5.16 dB	(1)
Radiated Emissio 18-40GHz	5.54 dB	(1)
Occupied Bandwidth	-----	(1)
Emission Mask	-----	(1)
Modulation Characteristic	-----	(1)
Transmitter Frequency Behavior	-----	(1)

(1) This uncertainty represents an expanded uncertainty expressed at approximately the 95% confidence level using a coverage factor of k=1.96.

### 3.5. Test Description

#### 3.5.1 Cellular Band (824-849MHz paired with 869-894MHz)

Test Item	FCC Rule No.	Requirements	Verdict
Effective(Isotropic) Radiated Power Output Data	§2.1046, §22.913	FCC: ERP ≤ 7W.	Pass
Modulation Characteristics	§2.1047	Digital modulation	N/A
Bandwidth	§2.1049	OBW: No limit. EBW: No limit.	Pass
Band Edges Compliance	§2.1051, §22.917	≤-13dBm/1%*EBW, in 1MHz bands immediately outside and adjacent to The frequency block.	Pass
Spurious Emission at Antenna Terminals	§2.1051, §22.917	FCC: ≤ -13dBm/100kHz, from 9kHz to 10th harmonics but outside authorized operating frequency ranges.	Pass
Field Strength of Spurious Radiation	§2.1053, §22.917	FCC: ≤ -13dBm/100kHz.	Pass
Frequency Stability	§2.1055, §22.355	≤ ±2.5ppm.	Pass
NOTE 1: For the verdict, the "N/A" denotes "not applicable", the "N/T" de notes "not tested".			

#### 3.5.2 PCS Band (1850-1915MHz paired with 1930-1995MHz)

Test Item	FCC Rule No.	Requirements	Verdict
Effective (Isotropic) Radiated Power Output Data	§2.1046, §24.232	EIRP ≤ 2W	Pass
Peak-Average Ratio	§2.1046, §24.232	FCC: Limits ≤ 13dB	N/A
Modulation Characteristics	§2.1047	Digital modulation	N/A
Bandwidth	§2.1049	OBW: No limit. EBW: No limit.	Pass
Band Edges Compliance	§2.1051, §24.238	≤ -13dBm/1%*EBW, In 1MHz bands immediately outside and adjacent to The frequency block.	Pass
Spurious Emission at Antenna Terminals	§2.1051, §24.238	≤-13dBm/1MHz, from 9kHz to 10th harmonics but outside authorized Operating frequency ranges.	Pass
Field Strength of Spurious Radiation	§2.1053, §24.238	≤ -13dBm/1MHz.	Pass
Frequency Stability	§2.1055, §24.235	FCC: within authorized frequency block.	Pass
NOTE 1: For the verdict, the "N/A" denotes "not applicable", the "N/T" de notes "not tested".			

Remark:

1. The measurement uncertainty is not included in the test result.

### 3.6. Equipments Used during the Test

<b>Output Power(Conducted) &amp; Occupied Bandwidth &amp; Emission Bandwidth &amp; Band Edge Compliance &amp; Conducted Spurious Emission</b>					
No.	Equipment	Manufacturer	Model No.	Serial No.	Last Cal.
1	UNIVERSAL RADIO COMMUNICATION	Rohde&Schwarz	CMU200	112012	2014/06/21
2	Spectrum Analyzer	Rohde&Schwarz	FSU26	201148	2014/07/02
3	Splitter	Mini-Circuit	ZAPD-4	400059	2014/06/22
4	MXA Signal Analyzer	Agilent	N9020A	MY53420615	2014/05/12
5	RF Cable1	/	Cable000001	/	2014/07/06
6	RF Cable2	/	Cable000002	/	2014/07/06
7	RF Cable3	/	Cable000003	/	2014/07/06

<b>Frequency Stability</b>					
No.	Equipment	Manufacturer	Model No.	Serial No.	Last Cal.
1	UNIVERSAL RADIO COMMUNICATION	Rohde&Schwarz	CMU200	112012	2014/06/21
2	Spectrum Analyzer	Rohde&Schwarz	FSU26	201148	2014/07/02
3	Climate Chamber	ESPEC	EL-10KA	05107008	2014/06/28
4	Splitter	Mini-Circuit	ZAPD-4	400059	2014/06/22
5	RF Cable1	/	Cable000001	/	2014/07/06

<b>Output Power (Radiated) &amp; Radiated Spurious Emission</b>					
Item	Test Equipment	Manufacturer	Model No.	Serial No.	Last Cal.
1	Bilog Antenna	Sunol Sciences Corp.	JB1	A061713	2014/07/12
2	EMI TEST Receivcer	Rohde&Schwarz	ESCI3	103710	2014/07/02
3	EMI TEST Software	Audix	E3	N/A	N/A
4	EMI TEST Software	Rohde&Schwarz	ESK1	N/A	N/A
5	HORN ANTENNA	Sunol Sciences Corp.	DRH-118	A062013	2014/07/12
6	Amplifer	HP	8447D	3113A07663	2014/10/26
7	Preamplifier	HP	8349B	3155A00882	2014/07/03
8	Amplifer	Compliance Direction systems	PAP1-4060	129	2014/07/03
9	Loop Antenna	Rohde&Schwarz	HFH2-Z2	100020	2014/06/29
10	TURNTABLE	MATURO	TT2.0	----	N/A
11	ANTENNA MAST	MATURO	TAM-4.0-P	----	N/A
12	Horn Antenna	SCHWARZBECK	BBHA9170	25849	2014/06/21
13	Spectrum Analyzer	Rohde&Schwarz	FSU26	201148	2014/07/02
14	Signal Generator	Rohde&Schwarz	SMF100A	101932	2014/06/21
15	UNIVERSAL RADIO COMMUNICATION	Rohde&Schwarz	CMU200	112012	2014/06/21
16	Splitter	Mini-Circuit	ZAPD-4	400062	2014/06/22
17	RF Cable 5	/	Cable000005	/	2014/07/06
18	RF Cable 6	/	Cable000006	/	2014/07/06
19	RF Cable 7	/	Cable000007	/	2014/07/06

The calibration interval was one year.

## 4. TEST CONDITIONS AND RESULTS

### 4.1. OUTPUT POWER

#### TEST APPLICABLE

During the process of testing, the EUT was controlled via Rhode & Schwarz Digital Radio Communication tester (CMU200) to ensure max power transmission and proper modulation. This result contains output power and EIRP measurements for the EUT. In all cases, output power is within the specified limits.

#### 4.1.1. Conducted Output Power

#### TEST CONFIGURATION

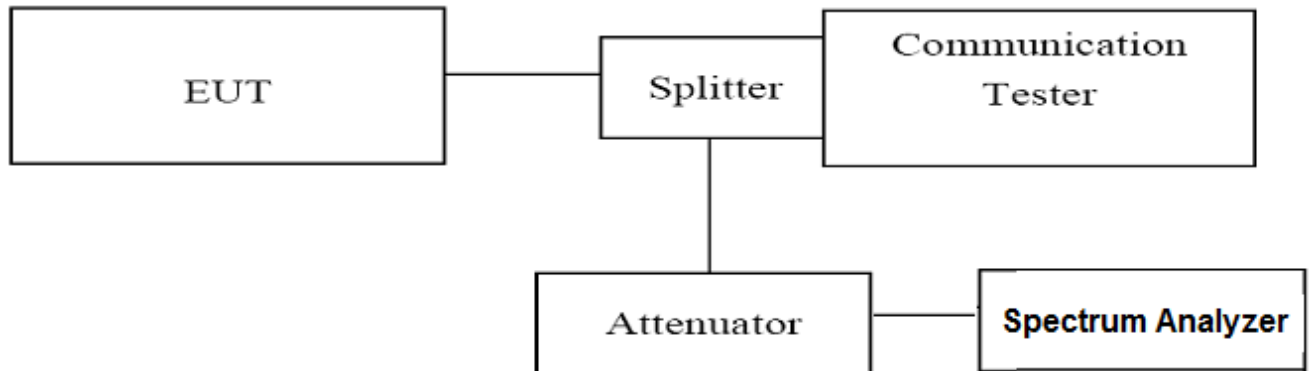

#### TEST PROCEDURE

1. The EUT was set up for the max output power with pseudo random data modulation.
2. The power was measured with Agilent Spectrum Analyzer N9020A (peak)
3. These measurements were done at 3 frequencies, 1850.20 MHz, 1880.00 MHz and 1907.60 MHz for WCDMA band II; 826.40 MHz, 836.60 MHz and 846.60 MHz for WCDMA band V. (low, middle and high of operational frequency range).

#### TEST CONDITION

RBW	VBW	Sweep Time	Span
10MHz	10MHz	800ms	50MHz

#### TEST RESULTS

UMTS/TM1/WCDMA V		
Channel	Frequency (MHz)	Output Power(dBm)
4132	826.40	23.65
4183	836.60	23.41
4233	846.60	23.19

UMTS/TM1/WCDMA II		
Channel	Frequency (MHz)	Output Power(dBm)
9262	1852.40	23.50
9400	1880.00	23.71
9538	1907.60	23.31

#### 4.1.2. Radiated Output Power

##### TEST DESCRIPTION

This is the test for the maximum radiated power from the EUT.

Rule Part 24.232(c) specifies, "Mobile/portable stations are limited to 2 watts e.i.r.p. Peak power" and 24.232(e) specifies that "Peak transmit power must be measured over any interval of continuous transmission using instrumentation calibrated in terms of an rms-equivalent voltage." Rule Part 22.913(a) specifies "The ERP of mobile transmitters and auxiliary test transmitters must not exceed 7 Watts."

##### TEST CONFIGURATION

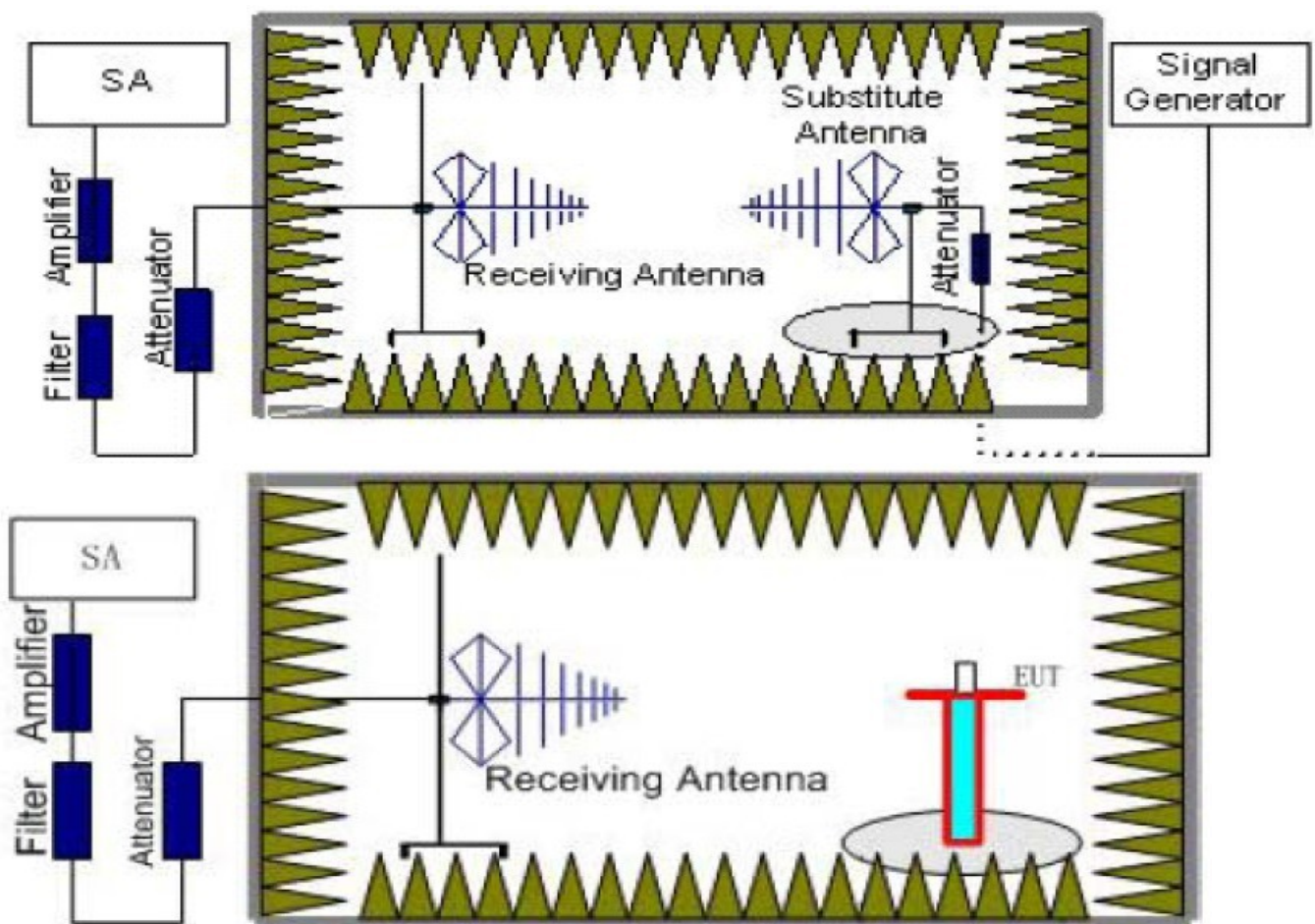

##### TEST PROCEDURE

1. EUT was placed on a 1.50 meter high non-conductive stand at a 3 meter test distance from the receive antenna. A receiving antenna was placed on the antenna mast 3 meters from the EUT for emission measurements. The height of receiving antenna is 1.50m. Detected emissions were maximized at each frequency by rotating the EUT through 360° and adjusting the receiving antenna polarization. The radiated emission measurements of all transmit frequencies in three channels (High, Middle, Low) were measured with peak detector.
2. A log-periodic antenna or double-ridged waveguide horn antenna shall be substituted in place of the EUT. The log-periodic antenna will be driven by a signal generator and the level will be adjusted till the same power value on the spectrum analyzer or receiver. The level of the spurious emissions can be calculated through the level of the signal generator, cable loss, the gain of the substitution antenna and the reading of the spectrum analyzer or receiver.

3. The EUT is then put into continuously transmitting mode at its maximum power level during the test. Set Test Receiver or Spectrum RBW=10MHz, VBW=10MHz, And the maximum value of the receiver should be recorded as ( $P_r$ ).
4. The EUT shall be replaced by a substitution antenna. In the chamber, an substitution antenna for the frequency band of interest is placed at the reference point of the chamber. An RF Signal source for the frequency band of interest is connected to the substitution antenna with a cable that has been constructed to not interfere with the radiation pattern of the antenna. A power ( $P_{Mea}$ ) is applied to the input of the substitution antenna, and adjust the level of the signal generator output until the value of the receiver reach the previously recorded ( $P_r$ ). The power of signal source ( $P_{Mea}$ ) is recorded. The test should be performed by rotating the test item and adjusting the receiving antenna polarization.
5. A amplifier should be connected to the Signal Source output port. And the cable should be connect between the Amplifier and the Substitution Antenna. The cable loss ( $P_{cl}$ ), the Substitution Antenna Gain ( $G_a$ ) and the Amplifier Gain ( $P_{Ag}$ ) should be recorded after test.  
The measurement results are obtained as described below:  
Power(EIRP)= $P_{Mea} - P_{Ag} - P_{cl} + G_a$   
We used SMF100A microwave signal generator which signal level can up to 33dBm,so we not used power Amplifier for substitution test; The measurement results are amend as described below:  
Power(EIRP)= $P_{Mea} - P_{cl} + G_a$
6. This value is EIRP since the measurement is calibrated using an antenna of known gain (2.15 dBi) and known input power.
7. ERP can be calculated from EIRP by subtracting the gain of the dipole, ERP = EIRP-2.15dBi.

**TEST LIMIT**

Note: We test the H direction and V direction and V direction is worse.

According to 22.913(a) and 24.232(c), the ERP should be not exceeding following table limits:

	<b>Burst Peak EIRP</b>
WCDMA Band II	33dBm (2W)
	<b>Burst Peak ERP</b>
WCDMA Band V	38.45dBm (7W)

**TEST RESULTS**

UMTS/TM1/WCDMA Band II						
Frequency (MHz)	$P_{Mea}$ (dBm)	$P_{cl}$ (dB)	$G_a$ Antenna Gain (dB)	Correction (dB)	EIRP (dBm)	Polarization
1852.4	18.25	3.52	8.35	2.15	23.08	V
1880.0	18.95	3.61	8.29	2.15	23.63	V
1907.6	18.15	3.67	8.37	2.15	22.85	V

UMTS/TM1/ WCDMA Band V						
Frequency (MHz)	$P_{Mea}$ (dBm)	$P_{cl}$ (dB)	$G_a$ Antenna Gain (dB)	Correction (dB)	ERP (dBm)	Polarization
826.40	17.93	1.56	8.45	2.15	22.67	V
836.60	18.22	1.50	8.45	2.15	23.02	V
846.60	17.68	1.67	8.39	2.15	22.25	V



## 4.2. Radiated Spurious Emission

### TEST APPLICABLE

According to the TIA/EIA 603D:2010 test method, The Receiver or Spectrum was scanned from 9 KHz to the 10<sup>th</sup> harmonic of the highest frequency generated within the equipment, which is the transmitted carrier that can be as high as 1910 MHz The resolution bandwidth is set as outlined in Part 24.238 and Part 22.917. The spectrum is scanned with the mobile station transmitting at carrier frequencies that pertain to low, mid and high channels of WCDMA Band II and WCDMA Band V.

### TEST CONFIGURATION

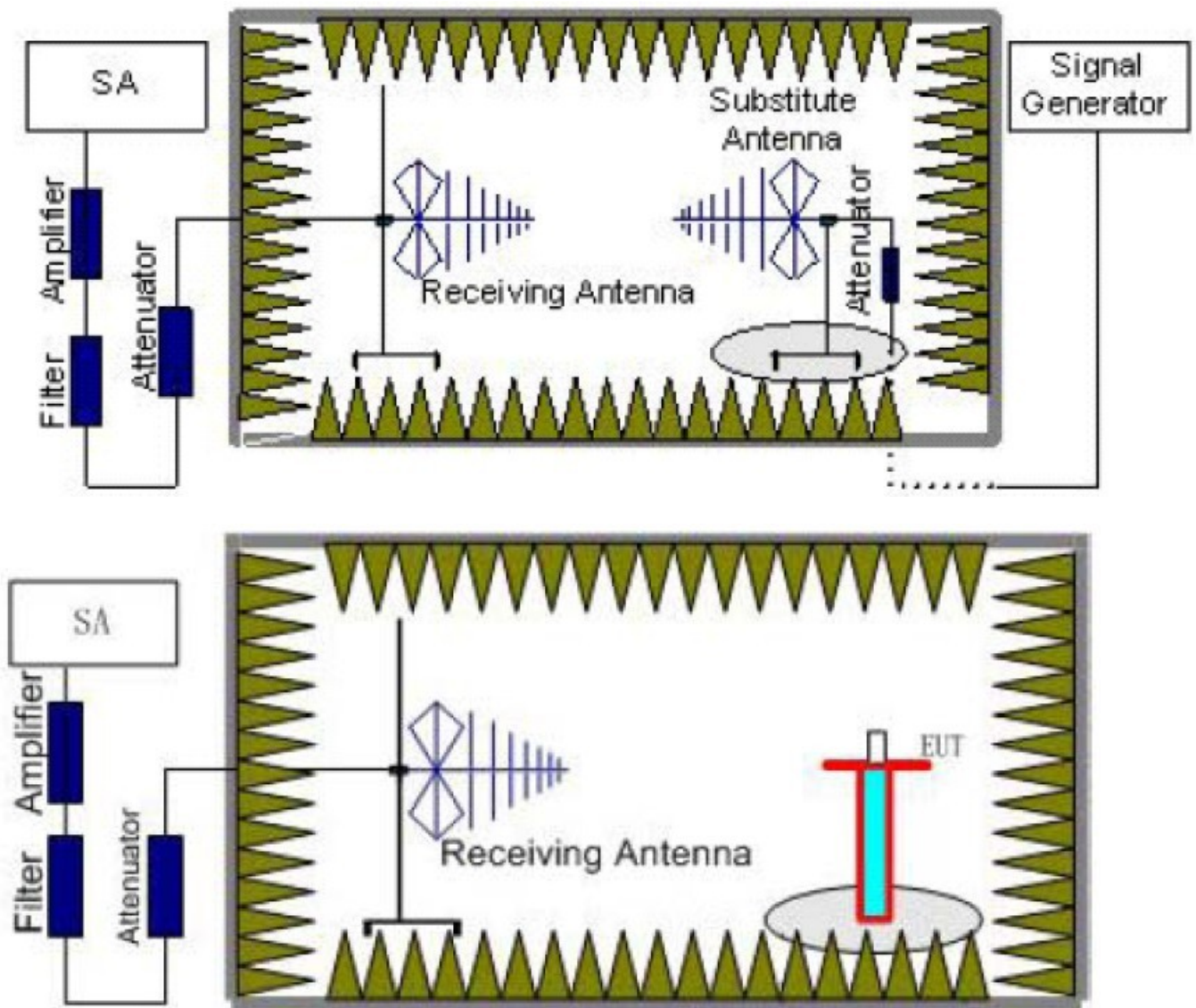

### TEST PROCEDURE

1. EUT was placed on a 1.50 meter high non-conductive stand at a 3 meter test distance from the receive antenna. A receiving antenna was placed on the antenna mast 3 meters from the EUT for emission

measurements. The height of receiving antenna is 1.50m. Detected emissions were maximized at each frequency by rotating the EUT through 360° and adjusting the receiving antenna polarization. The radiated emission measurements of all transmit frequencies in three channels (High, Middle, Low) were measured with peak detector.

2. A log-periodic antenna or double-ridged waveguide horn antenna shall be substituted in place of the EUT. The log-periodic antenna will be driven by a signal generator and the level will be adjusted till the same power value on the spectrum analyzer or receiver. The level of the spurious emissions can be calculated through the level of the signal generator, cable loss, the gain of the substitution antenna and the reading of the spectrum analyzer or receiver.
3. The EUT is then put into continuously transmitting mode at its maximum power level during the test. Set Test Receiver or Spectrum RBW=1MHz, VBW=3MHz, And the maximum value of the receiver should be recorded as (P<sub>r</sub>).
4. The EUT shall be replaced by a substitution antenna. In the chamber, an substitution antenna for the frequency band of interest is placed at the reference point of the chamber. An RF Signal source for the frequency band of interest is connected to the substitution antenna with a cable that has been constructed to not interfere with the radiation pattern of the antenna. A power (P<sub>Mea</sub>) is applied to the input of the substitution antenna, and adjust the level of the signal generator output until the value of the receiver reach the previously recorded (P<sub>r</sub>). The power of signal source (P<sub>Mea</sub>) is recorded. The test should be performed by rotating the test item and adjusting the receiving antenna polarization.
5. A amplifier should be connected to the Signal Source output port. And the cable should be connect between the Amplifier and the Substitution Antenna. The cable loss (P<sub>cl</sub>), the Substitution Antenna Gain (G<sub>a</sub>) and the Amplifier Gain (P<sub>Ag</sub>) should be recorded after test. The measurement results are obtained as described below:  
Power(EIRP)=P<sub>Mea</sub>- P<sub>Ag</sub> - P<sub>cl</sub> + G<sub>a</sub>
6. This value is EIRP since the measurement is calibrated using an antenna of known gain (2.15 dBi) and known input power.
7. ERP can be calculated from EIRP by subtracting the gain of the dipole, ERP = EIRP -2.15dBi.
8. In order to make sure test results more clearly, we set frequency range and sweep time for difference frequency range as follows table:

Working Frequency	Subrange (GHz)	RBW	VBW	Sweep time (s)
UMTS/TM1/ WCDMA Band V	0.00009~0.15	1KHz	3KHz	30
	0.00015~0.03	10KHz	30KHz	10
	0.03~1	100KHz	300KHz	10
	1~2	1 MHz	3 MHz	2
	2~5	1 MHz	3 MHz	3
	5~8	1 MHz	3 MHz	3
	8~10	1 MHz	3 MHz	3
UMTS/TM1/ WCDMA Band II	0.00009~0.15	1KHz	3KHz	30
	0.00015~0.03	10KHz	30KHz	10
	0.03~1	100KHz	300KHz	10
	1~2	1 MHz	3 MHz	2
	2~5	1 MHz	3 MHz	3
	5~8	1 MHz	3 MHz	3
	8~11	1 MHz	3 MHz	3
	11~14	1 MHz	3 MHz	3
	14~18	1 MHz	3 MHz	3
	18~20	1 MHz	3 MHz	2

**TEST LIMITS**

According to 24.238 and 22.917 specify that the power of any emission outside of the authorized operating frequency ranges must be attenuated below the transmitting power (P) by a factor of at least 43 + 10 log(P) dB.

The specification that emissions shall be attenuated below the transmitter power (P) by at least 43 + 10 log (P) dB, translates in the relevant power range (1 to 0.001 W) to -13 dBm. At 1 W the specified minimum attenuation becomes 43 dB and relative to a 30 dBm (1 W) carrier becomes a limit of -13 dBm. At 0.001 W (0 dBm) the minimum attenuation is 13 dB, which again yields a limit of -13 dBm. In this way a translation of the specification from relative to absolute terms is carried out.

Frequency	Channel	Frequency Range	Verdict
UMTS/TM1/ WCDMA Band V	Low	9KHz-10GHz	PASS
	Middle	9KHz -10GHz	PASS



UMTS/TM1/ WCDMA Band II	High	9KHz -10GHz	PASS
	Low	9KHz -20GHz	PASS
	Middle	9KHz -20GHz	PASS
	High	9KHz -20GHz	PASS

UMTS/TM1/ WCDMA Band V							
Channel Number: 4132				Test Frequency: 826.40 MHz			
Frequency (MHz)	P <sub>Mea</sub> (dBm)	Path Loss	Antenna Gain	Correction (dB)	Peak ERP(dBm)	Limit (dBm)	Polarization
1652.80	-39.98	4.32	6.77	2.15	-39.68	-13.00	H
2479.20	---			2.15	---	-13.00	H
1652.80	-35.31	4.32	6.77	2.15	-35.01	-13.00	V
2479.20	---			2.15	---	-13.00	V

UMTS/TM1/ WCDMA Band V							
Channel Number: 4183				Test Frequency: 836.60 MHz			
Frequency (MHz)	P <sub>Mea</sub> (dBm)	Path Loss	Antenna Gain	Correction (dB)	Peak ERP(dBm)	Limit (dBm)	Polarization
1673.20	-38.08	4.55	6.77	2.15	-38.01	-13.00	H
2509.80	---			2.15	---	-13.00	H
1673.20	-34.66	4.55	6.77	2.15	-34.59	-13.00	V
2509.80	---			2.15	---	-13.00	V

UMTS/TM1/ WCDMA Band V							
Channel Number: 4233				Test Frequency: 846.60 MHz			
Frequency (MHz)	P <sub>Mea</sub> (dBm)	Path Loss	Antenna Gain	Correction (dB)	Peak ERP(dBm)	Limit (dBm)	Polarization
1693.20	-41.84	4.29	6.83	2.15	-41.45	-13.00	H
2539.80	---			2.15	---	-13.00	H
1693.20	-38.89	4.29	6.83	2.15	-38.5	-13.00	V
2539.80	---			2.15	---	-13.00	V

UMTS/TM1/ WCDMA Band II							
Channel Number: 9262				Test Frequency: 1852.40 MHz			
Frequency (MHz)	P <sub>Mea</sub> (dBm)	Path Loss	Antenna Gain	Correction (dB)	Peak ERP(dBm)	Limit (dBm)	Polarization
3704.80	-43.26	4.55	12.34	2.15	-37.62	-13.00	H
5557.20	---			2.15	---	-13.00	H
3704.80	-46.43	4.55	12.34	2.15	-40.79	-13.00	V
5557.20	---			2.15	---	-13.00	V

UMTS/TM1/ WCDMA Band II							
Channel Number: 9400				Test Frequency: 1880.00 MHz			
Frequency (MHz)	P <sub>Mea</sub> (dBm)	Path Loss	Antenna Gain	Correction (dB)	Peak ERP(dBm)	Limit (dBm)	Polarization
3760.00	-41.94	4.55	12.40	2.15	-36.24	-13.00	H
5640.00	---			2.15	---	-13.00	H
3760.00	-45.97	4.55	12.40	2.15	-40.27	-13.00	V
5640.00	---			2.15	---	-13.00	V

UMTS/TM1/ WCDMA Band II							
Channel Number: 9538				Test Frequency: 1907.60 MHz			
Frequency (MHz)	P <sub>Mea</sub> (dBm)	Path Loss	Antenna Gain	Correction (dB)	Peak ERP(dBm)	Limit (dBm)	Polarization
3815.20	-43.14	4.51	12.43	2.15	-37.37	-13.00	H
5722.80	---			2.15	---	-13.00	H
3815.20	-47.45	4.51	12.43	2.15	-41.68	-13.00	V

5722.80	---			2.15	---	-13.00	V
---------	-----	--	--	------	-----	--------	---

Note: 1. In general, the worse case attenuation requirement shown above was applied.  
 3. \*\*\* means that the emission level is too low to be measured or at least 20 dB down than the limit.

### 4.3. OCCUPIED BANDWIDTH

#### TEST APPLICABLE

Similar to conducted emissions; occupied bandwidth measurements are only provided for selected frequencies in order to reduce the amount of submitted data. Data were taken at the extreme and mid frequencies of WCDMA Band II and WCDMA band V.. The table below lists the measured 99% BW.

#### TEST CONFIGURATION

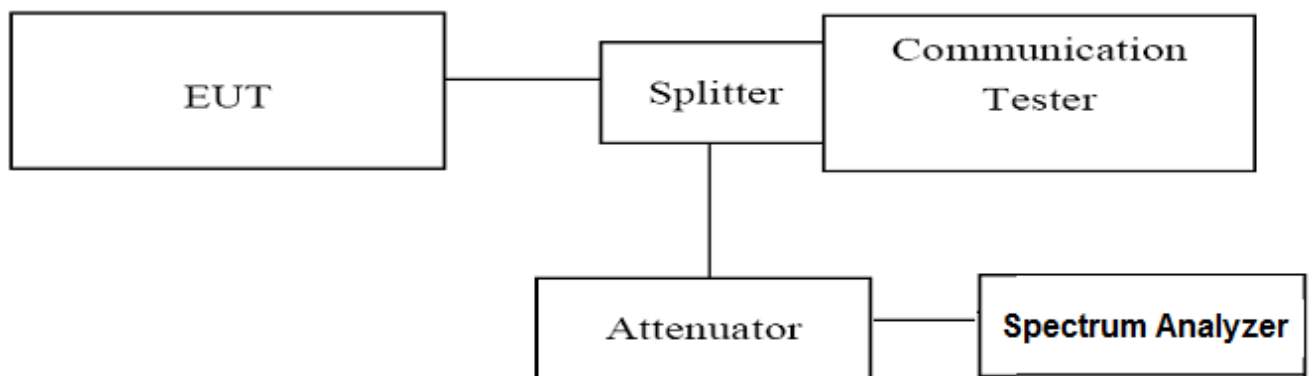

#### TEST PROCEDURE

1. The EUT was set up for the max output power with pseudo random data modulation;
2. The Occupied bandwidth was measured with Rhode & Schwarz Spectrum Analyzer FSU (peak);
3. Set RBW=5KHz,VBW=50KHz,Span=50MHz,SWT=5ms;
4. Set SPA Max hold and View, Set 99% Occupied Bandwidth
5. These measurements were done at 3 frequencies, 1850.20 MHz, 1880.00 MHz and 1709.80 MHz for WCDMA band II; 826.40 MHz, 836.60 MHz and 846.60 MHz for WCDMA band V. (low, middle and high of operational frequency range).

#### TEST RESULTS

UMTS/TM1/ WCDMA Band II				
Channel Number	Frequency (MHz)	Occupied Bandwidth (99% BW) ( MHz)	Refer to Plot	Verdict
9262	1852.4	4.167	Plot 4.3.1 A	PASS
9400	1880.0	4.182	Plot 4.3.1 B	PASS
9538	1907.6	4.151	Plot 4.3.1 C	PASS

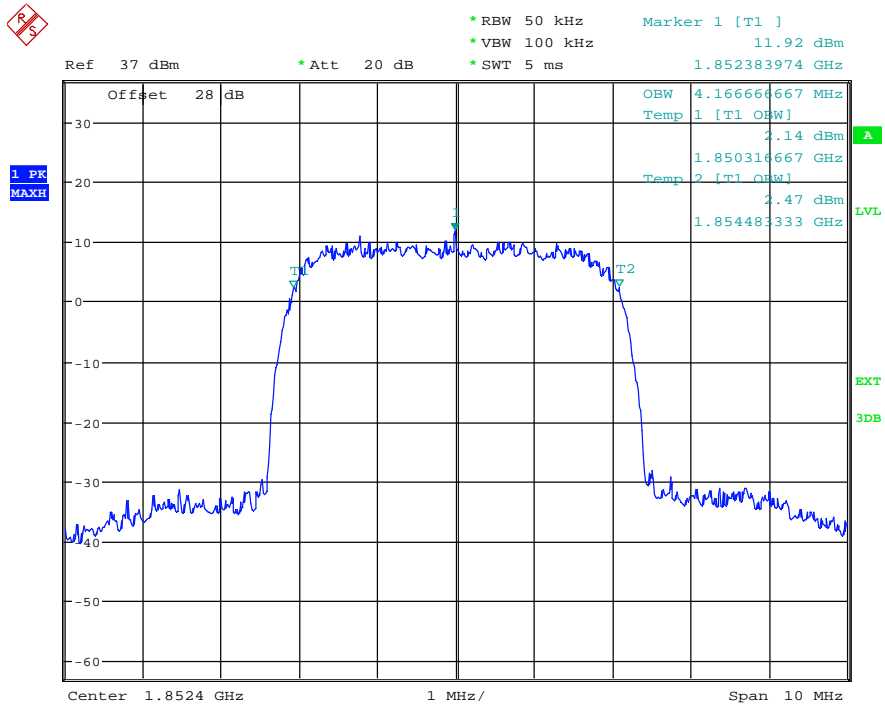

(Plot 4.3.1 A: Channel 9262: 1852.4MHz WCDMA Band II)

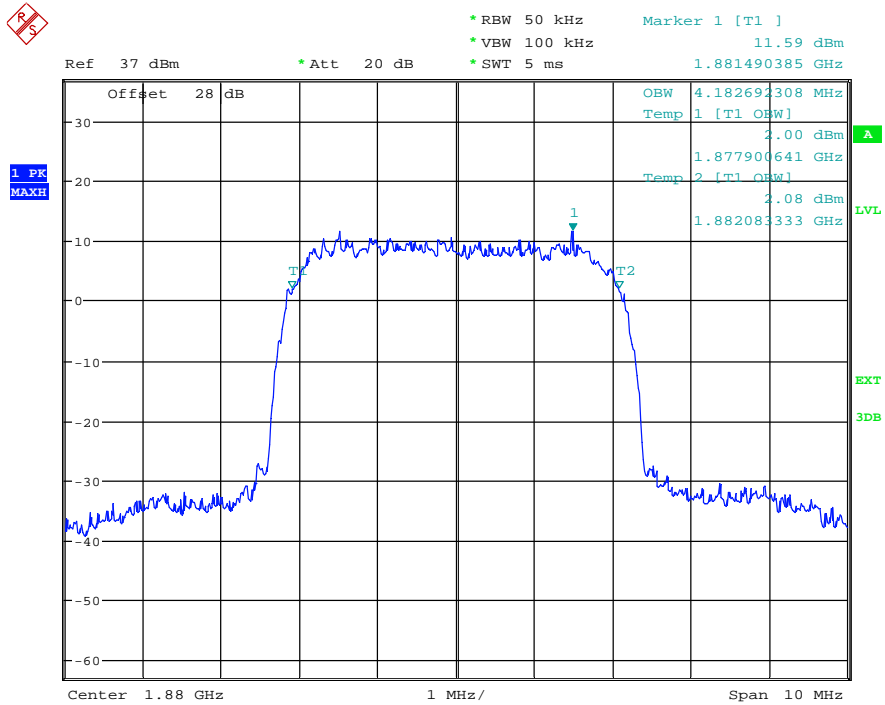

(Plot 4.3.1 B: Channel 9400: 1880.0MHz WCDMA Band II)

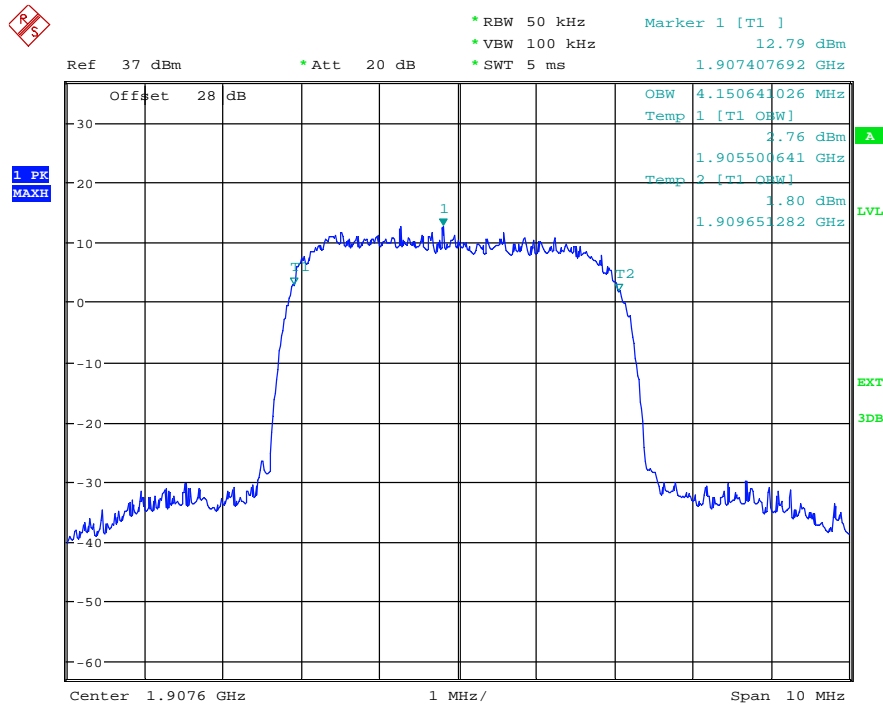

(Plot 4.3.1 C: Channel 9538: 1907.6MHz WCDMA Band II)

UMTS/TM1/ WCDMA Band V				
Channel Number	Frequency (MHz)	Occupied Bandwidth (99% BW) ( MHz)	Refer to Plot	Verdict
4132	826.40	4.167	Plot 4.3.2 A	PASS
4183	836.60	4.167	Plot 4.3.2 B	PASS
4233	846.60	4.151	Plot 4.3.2 C	PASS

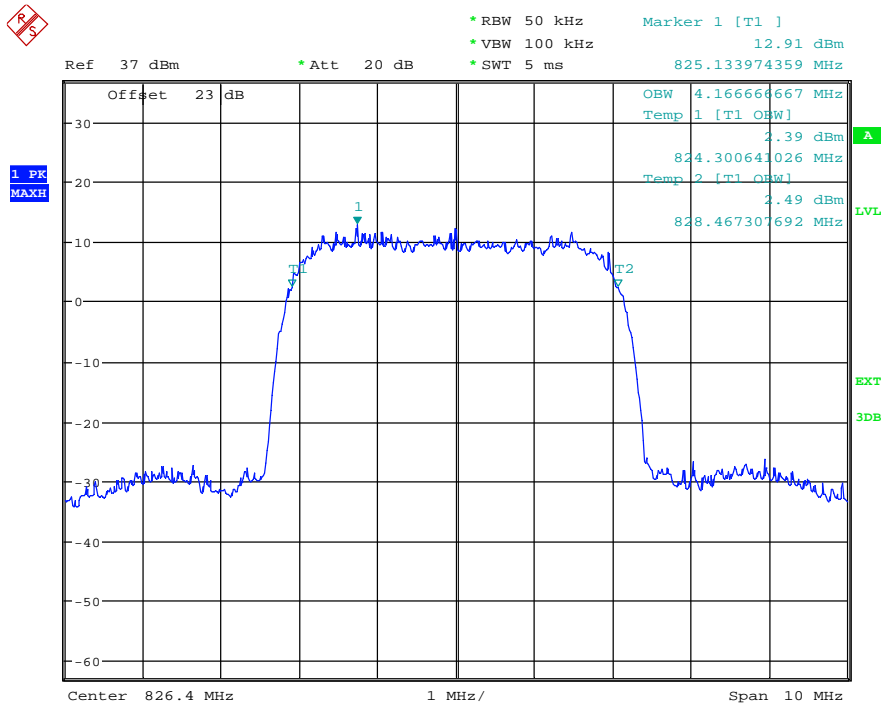

(Plot 4.3.2 A: Channel 4132:826.4MHz @ WCDMA Band V)

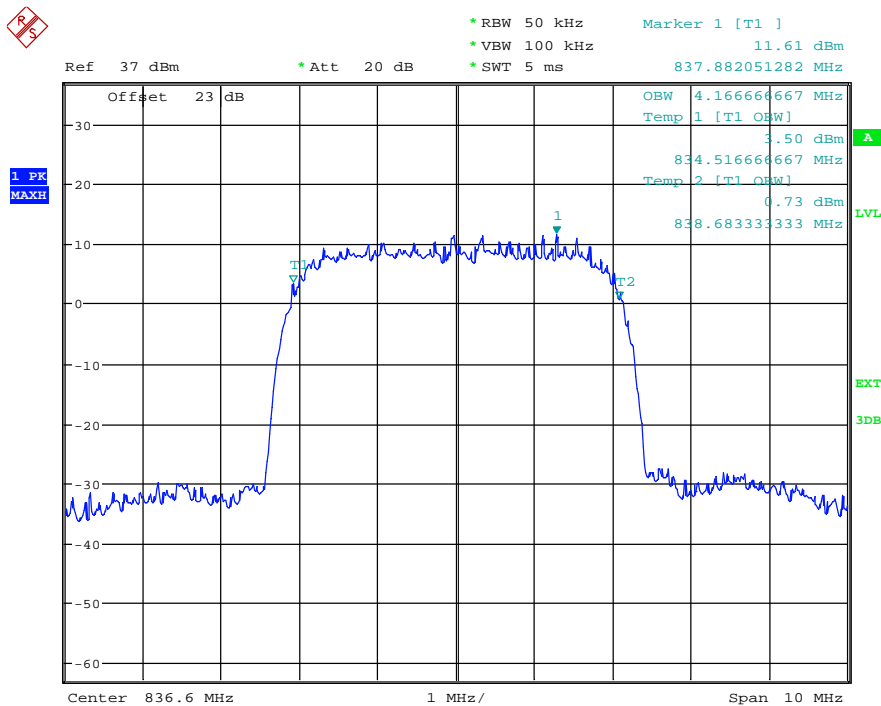

(Plot 4.3.2 B: Channel 4183:836.6MHz @ WCDMA Band V)



Ref 37 dBm      \* Att 20 dB      \* RBW 50 kHz      Marker 1 [T1 ]      11.35 dBm  
 \* VBW 100 kHz      846.567948718 MHz  
 \* SWT 5 ms

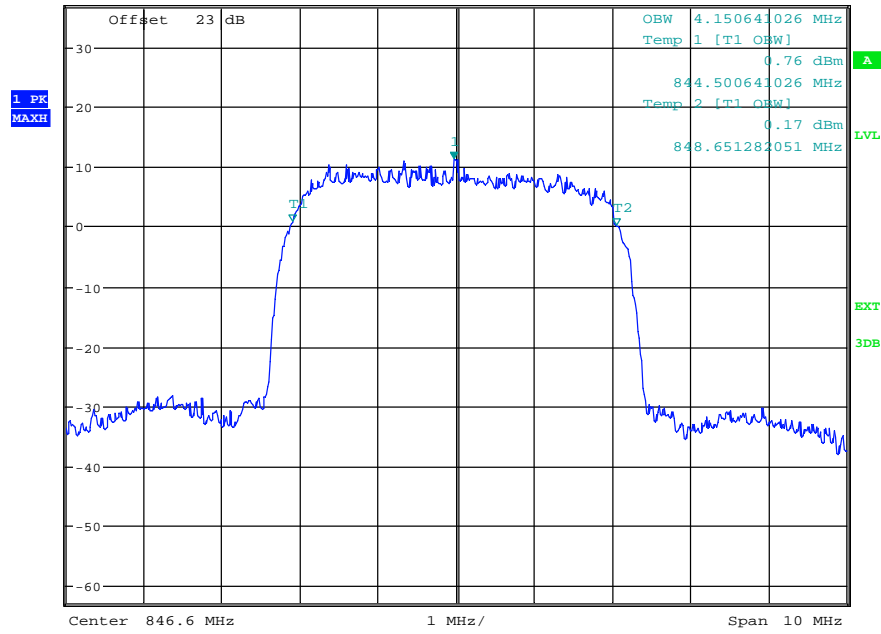

(Plot 4.3.2 C: Channel 4233:846.6MHz @ WCDMA Band V)

#### 4.4. EMISSION BANDWIDTH

##### TEST APPLICABLE

Similar to conducted emissions; occupied bandwidth measurements are only provided for selected frequencies in order to reduce the amount of submitted data. Data were taken at the extreme and mid frequencies of PCS1900 band and GSM850 band. The table below lists the measured -26dBc BW.

##### TEST CONFIGURATION

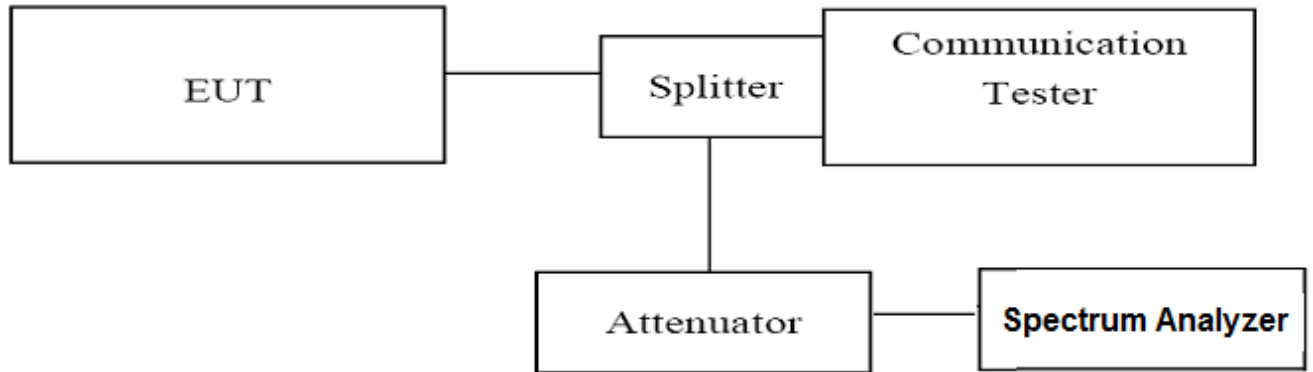

##### TEST PROCEDURE

6. The EUT was set up for the max output power with pseudo random data modulation;
7. The Occupied bandwidth was measured with Rhode & Schwarz Spectrum Analyzer FSU (peak);
8. Set RBW=5KHz,VBW=50KHz,Span=50MHz,SWT=5ms;
9. Set SPA Max hold and View, Set -26dBc Occupied Bandwidth
10. These measurements were done at 3 frequencies, 1850.20 MHz, 1880.00 MHz and 1709.80 MHz for WCDMA band II; 826.40 MHz, 836.60 MHz and 846.60 MHz for WCDMA band V. (low, middle and high of operational frequency range).

##### TEST RESULTS

UMTS/TM1/ WCDMA Band II				
Channel Number	Frequency (MHz)	Occupied Bandwidth (-26dBc BW) ( MHz)	Refer to Plot	Verdict
9262	1852.4	4.679	Plot 4.4.1 A	PASS
9400	1880.0	4.631	Plot 4.4.1 B	PASS
9538	1907.6	4.631	Plot 4.4.1 C	PASS

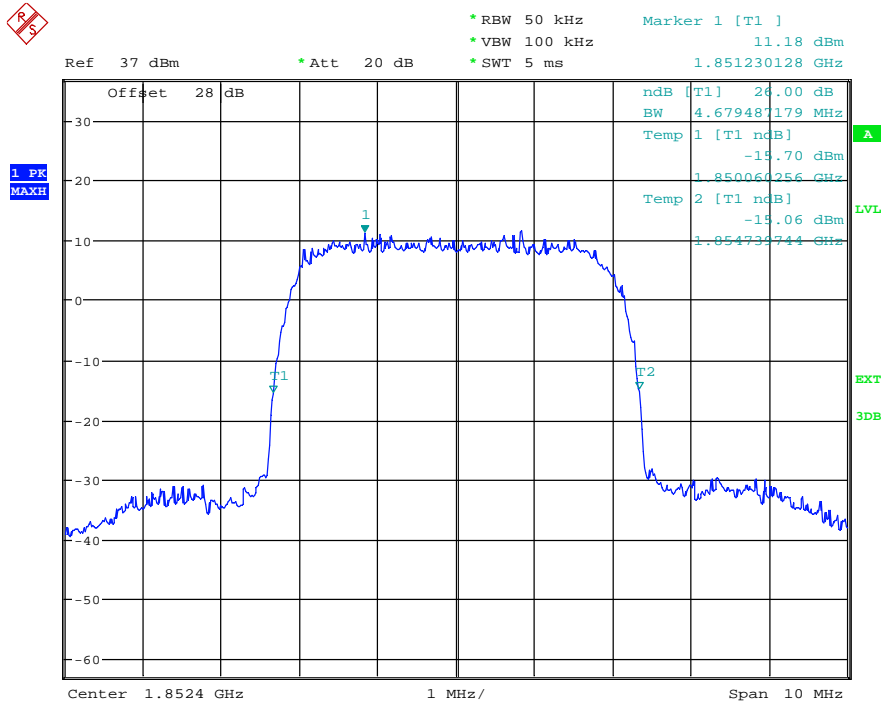

(Plot 4.4.1 A: Channel 9262: 1852.4MHz WCDMA Band II)

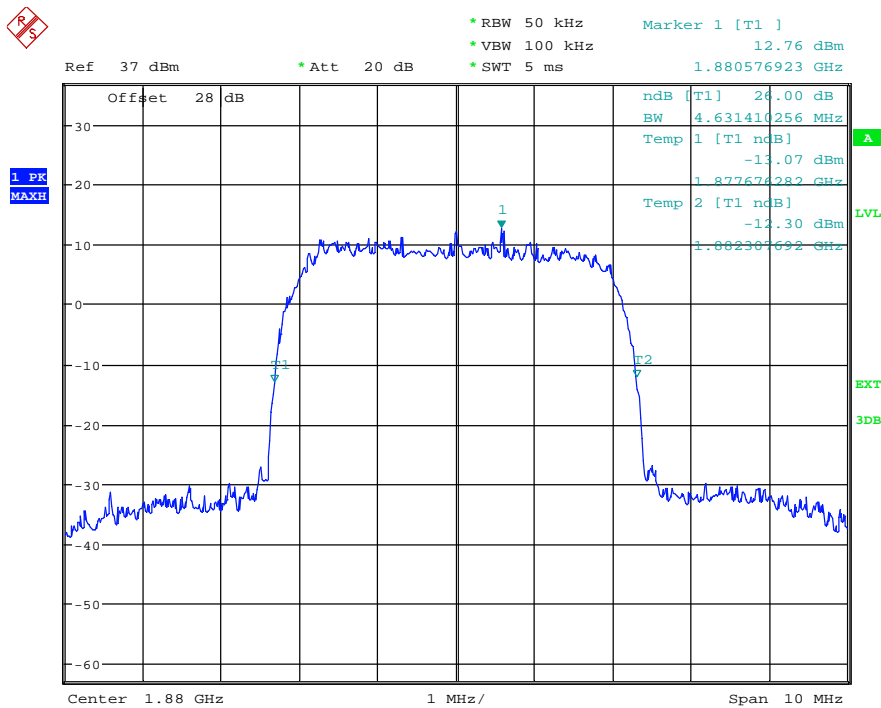

(Plot 4.4.1 B: Channel 9400: 1880.0MHz WCDMA Band II)



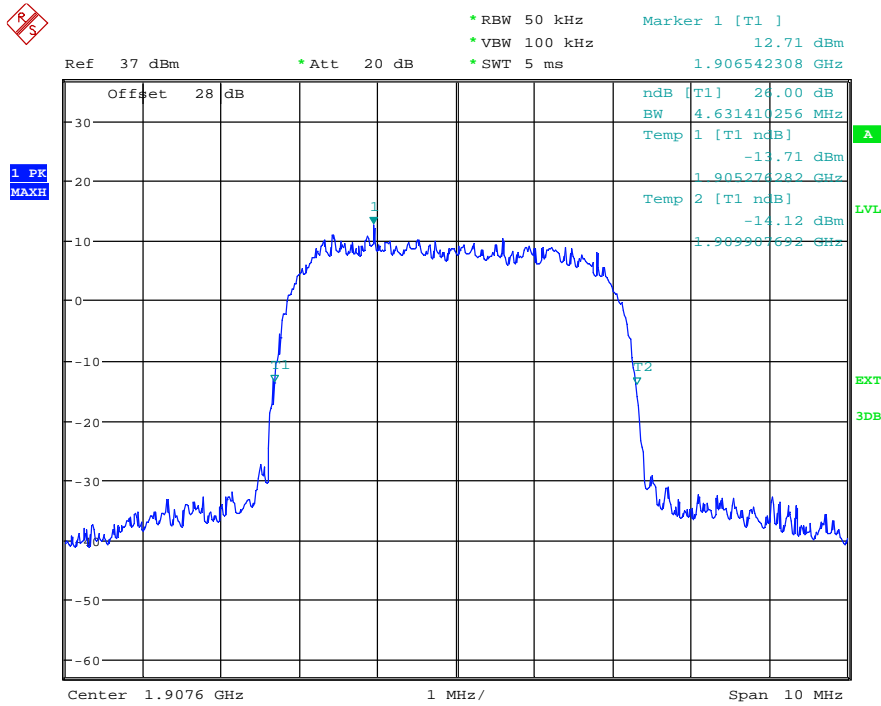

(Plot 4.4.1 C: Channel 9538: 1907.6MHz WCDMA Band II)

UMTS/TM1/ WCDMA Band V				
Channel Number	Frequency (MHz)	Occupied Bandwidth (-26dBc BW) ( MHz)	Refer to Plot	Verdict
4132	826.40	4.679	Plot 4.4.2 A	PASS
4183	836.60	4.664	Plot 4.4.2 B	PASS
4233	846.60	4.647	Plot 4.4.2 C	PASS

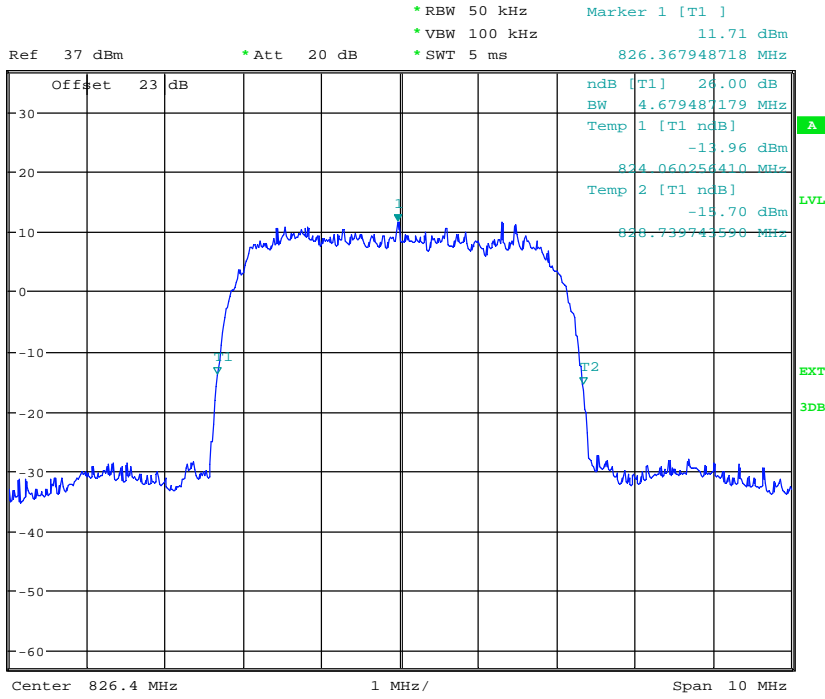

(Plot 4.4.2 A: Channel 4132:826.4MHz @ WCDMA Band V)

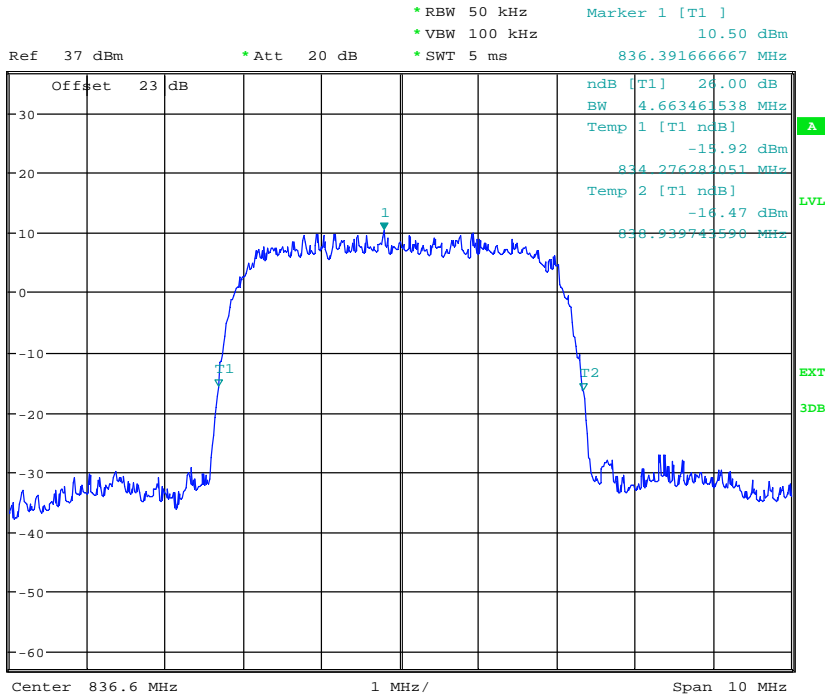

(Plot 4.4.2 B: Channel 4183:836.6MHz @ WCDMA Band V)



\*RBW 50 kHz      Marker 1 [T1 ]  
 \*VBW 100 kHz      11.65 dBm  
 \*SWT 5 ms      845.189743590 MHz

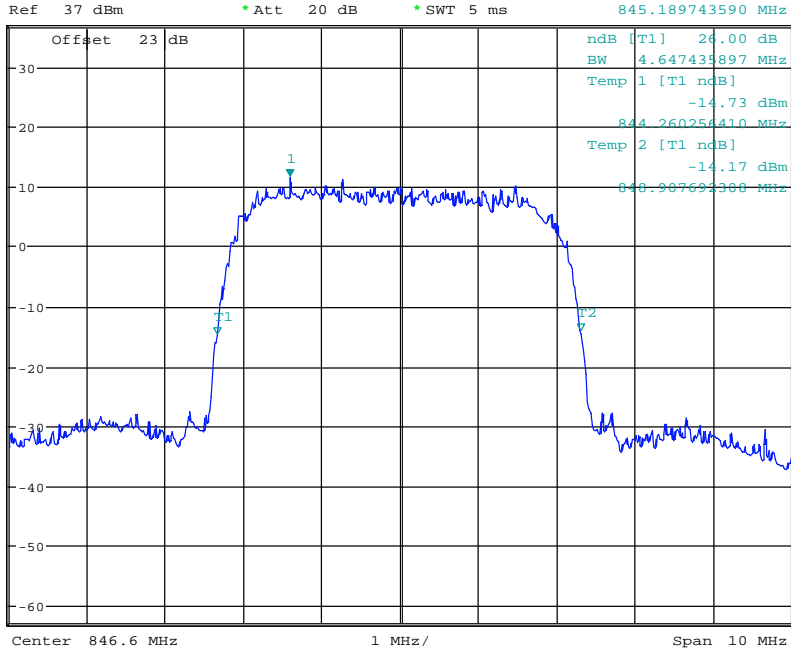

(Plot 4.4.2 C: Channel 4233:846.6MHz @ WCDMA Band V)

### 4.5. BAND EDGE COMPLIANCE

#### TEST APPLICABLE

During the process of testing, the EUT was controlled via Rhode & Schwarz Digital Radio Communication tester (CMU200) to ensure max power transmission and proper modulation.

#### TEST CONFIGURATION

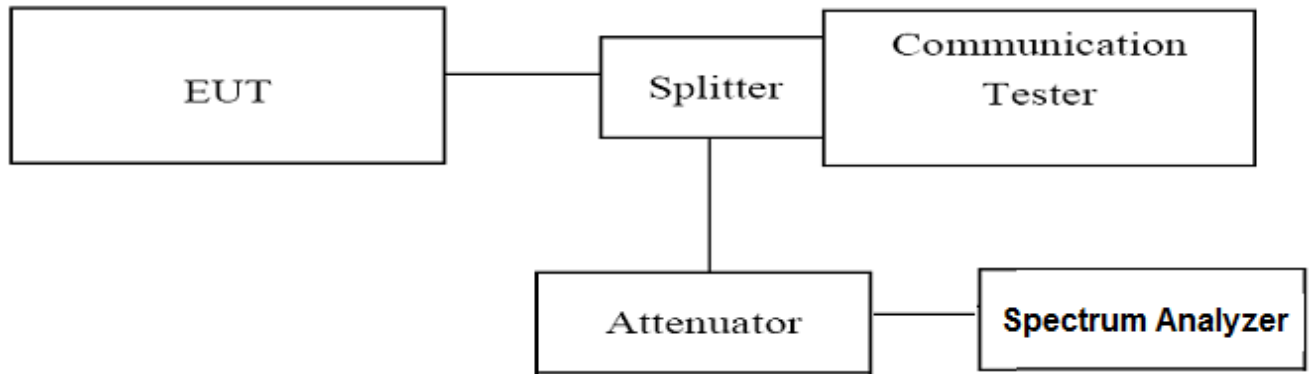

#### TEST PROCEDURE

1. The EUT was set up for the max output power with pseudo random data modulation;
2. The power was measured with Rhode & Schwarz Spectrum Analyzer FSU (AV);
3. Set RBW=5KHz,VBW=50KHz,Span=5MHz,SWT=300ms;
4. These measurements were done at 2 frequencies, 1850.20 MHz and 1709.80 MHz for WCDMA band II; 826.40 MHz and 846.60 MHz for WCDMA band V. (low and high of operational frequency range).

#### TEST RESULTS

UMTS/TM1/WCDMA Band II						
Channel Number	Frequency (MHz)	Measurement Results		Limit (dBm)	Refer to Plot	Verdict
		Frequency (MHz)	Values (dBm)			
9262	1852.4	1850.00	-25.89	-13.00	Plot 4.5.1 A	PASS
9538	1907.6	1910.69	-24.64	-13.00	Plot 4.5.1 B	PASS

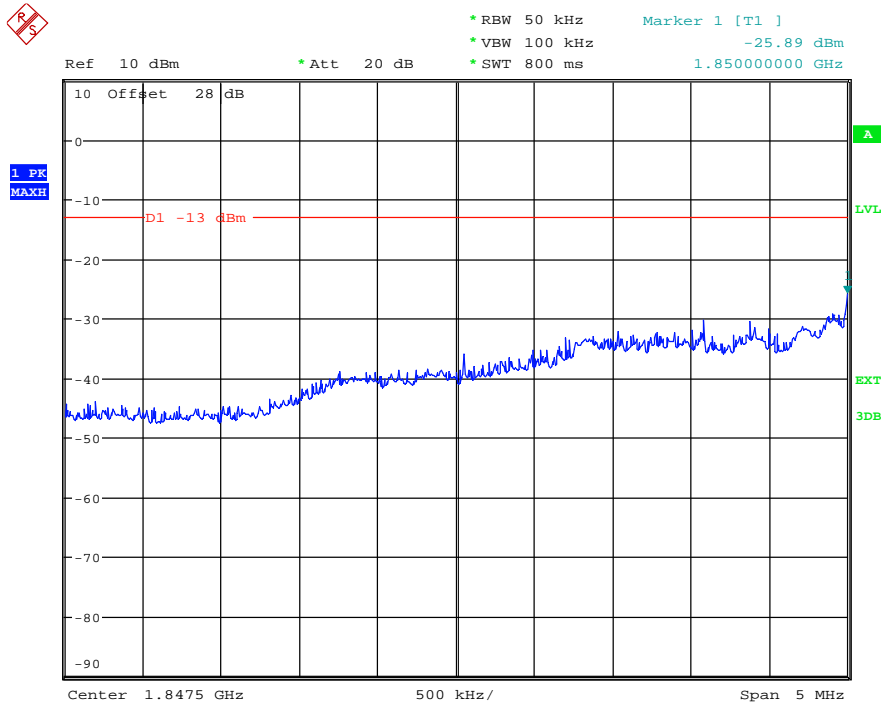

(Plot 4.5.1 A: Channel 9262: 1852.4MHz WCDMA Band II)

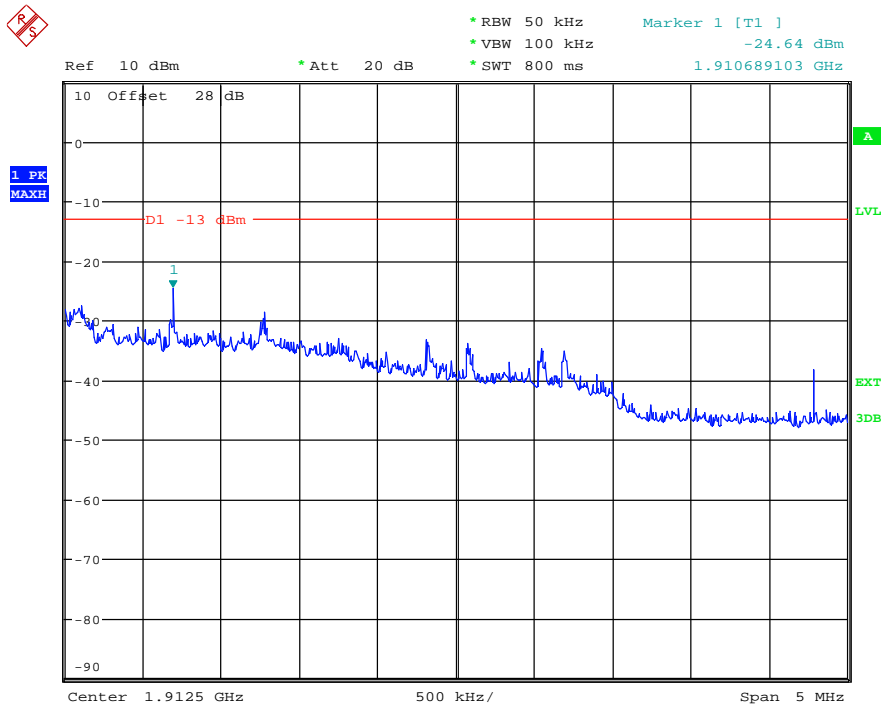

(Plot 4.5.1 B: Channel 9538: 1907.6MHz WCDMA Band II)

UMTS/TM1/WCDMA Band V						
Channel Number	Frequency (MHz)	Measurement Results		Limit (dBm)	Refer to Plot	Verdict
		Frequency (MHz)	Values (dBm)			
4132	826.40	824.74	-22.74	-13.00	Plot 4.5.2 A	PASS
4233	846.60	849.00	-26.02	-13.00	Plot 4.5.2 B	PASS

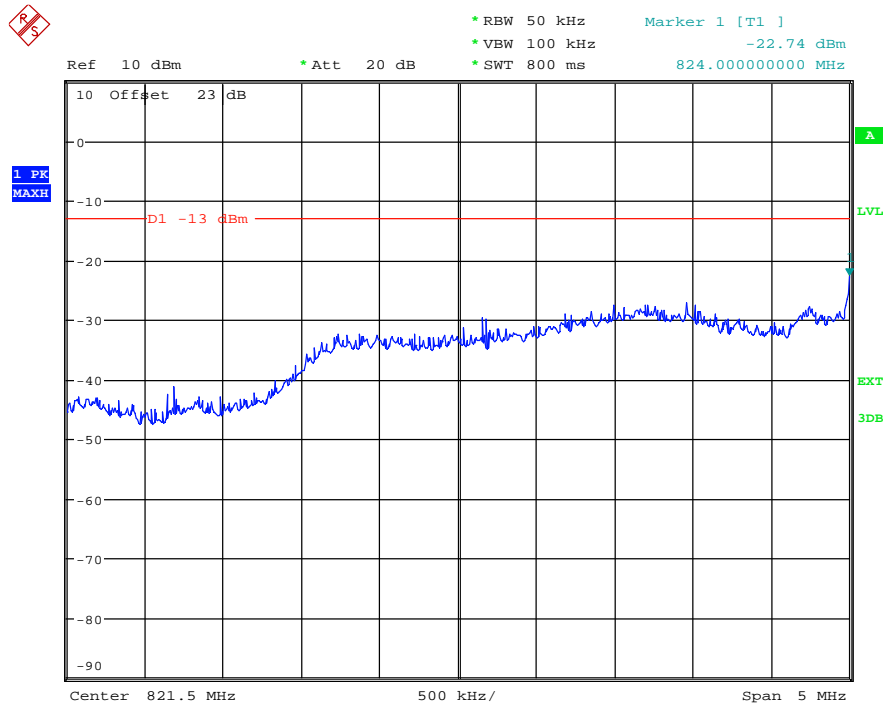

(Plot 4.5.2 A: Channel 4132: 826.4MHz @ WCDMA Band V)

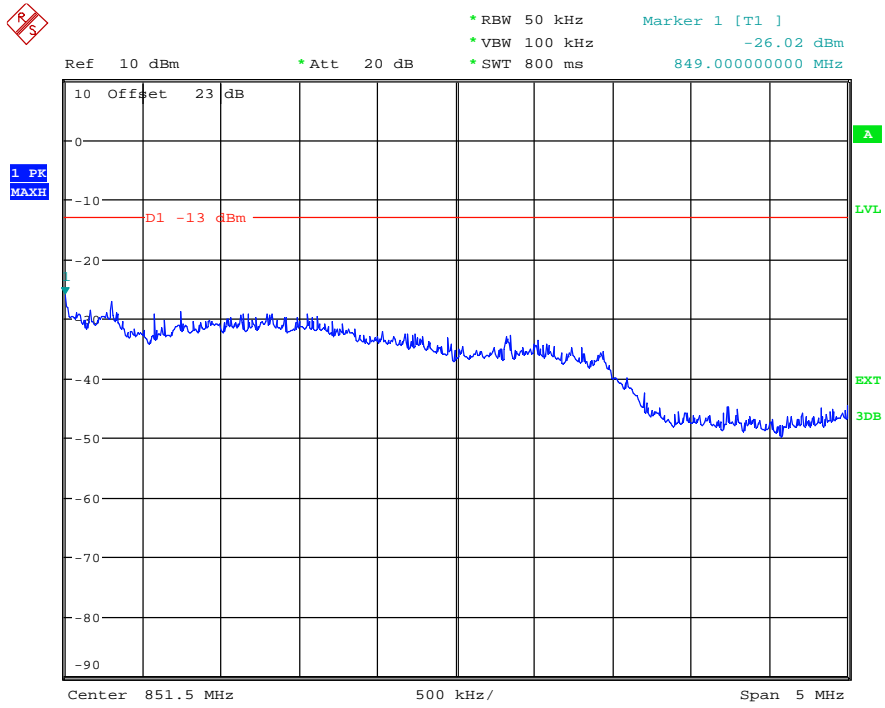

(Plot 4.5.2 B: Channel 4233: 846.6MHz @ WCDMA Band V)

#### 4.6. Spurious Emssion on Antenna Port

**TEST APPLICABLE**

The following steps outline the procedure used to measure the conducted emissions from the EUT.

1. Determine frequency range for measurements: From CFR 2.1057 the spectrum should be investigated from the lowest radio frequency generated in the equipment up to at least the 10th harmonic of the carrier frequency. For the equipment of WCDMA band II, this equates to a frequency range of 9 KHz to 20GHz, data taken from 9 KHz to 20 GHz. For WCDMA Band V, data taken from 9 KHz to 10 GHz.
2. The sweep time is set automatically by instrument itself. That should be the optimal sweep time for the span and the RBW. If the sweep time is too short, that is sweep is too fast, the sweep result is not accurate; if the sweep time is too long, that is sweep is too low, some frequency components may be lost. The instrument will give a optimal sweep time according the selected span and RBW.
3. The procedure to get the conducted spurious emission is as follows:  
The trace mode is set to MaxHold to get the highest signal at each frequency;  
Wait 25 seconds;  
Get the result.
4. Determine EUT transmit frequencies: below outlines the band edge frequencies pertinent to conducted emissions testing.

**TEST CONFIGURATION**

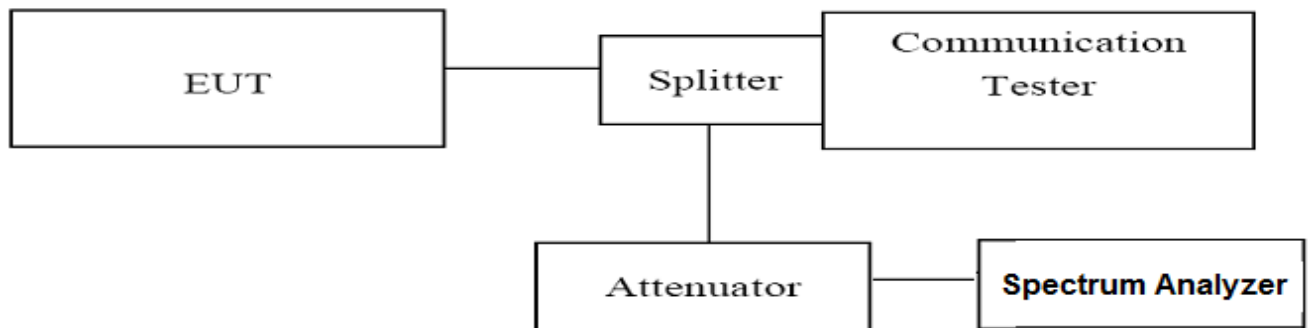

**TEST PROCEDURE**

1. The EUT was set up for the max output power with pseudo random data modulation;
2. The power was measured with Rhode & Schwarz Spectrum Analyzer FSU (peak) and Agilent Spectrum Analyzer N9020A (peak);
3. These measurements were done at 3 frequencies, 1850.20 MHz, 1880.00 MHz and 1709.80 MHz for WCDMA band II; 826.40 MHz, 836.60 MHz and 846.60 MHz for WCDMA band V. (low, middle and high of operational frequency range).

**TEST LIMIT**

Part 24.238 and Part 22.917 specify that the power of any emission outside of the authorized operating frequency ranges must be attenuated below the transmitting power (P) by a factor of at least  $43 + 10 \log(P)$  dB.

The specification that emissions shall be attenuated below the transmitter power (P) by at least  $43 + 10 \log (P)$  dB, translates in the relevant power range (1 to 0.001 W) to -13 dBm. At 1 W the specified minimum attenuation becomes 43 dB and relative to a 30 dBm (1 W) carrier becomes a limit of -13 dBm. At 0.001 W (0 dBm) the minimum attenuation is 13 dB, which again yields a limit of -13 dBm. In this way a translation of the specification from relative to absolute terms is carried out.

**TEST RESULTS**

**4.6.1 For WCDMA Band II Test Results**

A. Test Verdict

Test Mode/	Frequency	Frequency	Refer to Plot	Limit	Verdict
------------	-----------	-----------	---------------	-------	---------



Channel	(MHz)	Range		(dBm)	
UMTS/TM1/WCDMA Band II/9262	1852.40	9KHz-150KHz	Plot 4.6.1 A1	-13.00	PASS
		150KHz-30MHz	Plot 4.6.1 A2	-13.00	PASS
		30MHz-1GHz	Plot 4.6.1 A3	-13.00	PASS
		1GHz-2.5GHz	Plot 4.6.1 A4	-13.00	PASS
		2.5GHz-7.5GHz	Plot 4.6.1 A5	-13.00	PASS
		7.5GHz-10GHz	Plot 4.6.1 A6	-13.00	PASS
		10GHz-15GHz	Plot 4.6.1 A7	-13.00	PASS
		15GHz-20GHz	Plot 4.6.1 A8	-13.00	PASS
UMTS/TM1/WCDMA Band II/9400	1880.00	9KHz-150KHz	Plot 4.6.1 B1	-13.00	PASS
		150KHz-30MHz	Plot 4.6.1 B2	-13.00	PASS
		30MHz-1GHz	Plot 4.6.1 B3	-13.00	PASS
		1GHz-2.5GHz	Plot 4.6.1 B4	-13.00	PASS
		2.5GHz-7.5GHz	Plot 4.6.1 B5	-13.00	PASS
		7.5GHz-10GHz	Plot 4.6.1 B6	-13.00	PASS
		10GHz-15GHz	Plot 4.6.1 B7	-13.00	PASS
		15GHz-20GHz	Plot 4.6.1 B8	-13.00	PASS
UMTS/TM1/WCDMA Band II/9538	1907.60	9KHz-150KHz	Plot 4.6.1 C1	-13.00	PASS
		150KHz-30MHz	Plot 4.6.1 C2	-13.00	PASS
		30MHz-1GHz	Plot 4.6.1 C3	-13.00	PASS
		1GHz-2.5GHz	Plot 4.6.1 C4	-13.00	PASS
		2.5GHz-7.5GHz	Plot 4.6.1 C5	-13.00	PASS
		7.5GHz-10GHz	Plot 4.6.1 C6	-13.00	PASS
		10GHz-15GHz	Plot 4.6.1 C7	-13.00	PASS
		15GHz-20GHz	Plot 4.6.1 C8	-13.00	PASS
UMTS/TM1/WCDMA Band II/Idle	N/A	9KHz-150KHz	Plot 4.6.1 D1	-13.00	PASS
		150KHz-30MHz	Plot 4.6.1 D2	-13.00	PASS
		30MHz-1GHz	Plot 4.6.1 D3	-13.00	PASS
		1GHz-2.5GHz	Plot 4.6.1 D4	-13.00	PASS
		2.5GHz-7.5GHz	Plot 4.6.1 D5	-13.00	PASS
		7.5GHz-10GHz	Plot 4.6.1 D6	-13.00	PASS
		10GHz-15GHz	Plot 4.6.1 D7	-13.00	PASS
		15GHz-20GHz	Plot 4.6.1 D8	-13.00	PASS

Note: 1. In general, the worse case attenuation requirement shown above was applied.

2. \*\*\* means that the emission level is too low to be measured or at least 20 dB down than the limit.

B. Test Plots

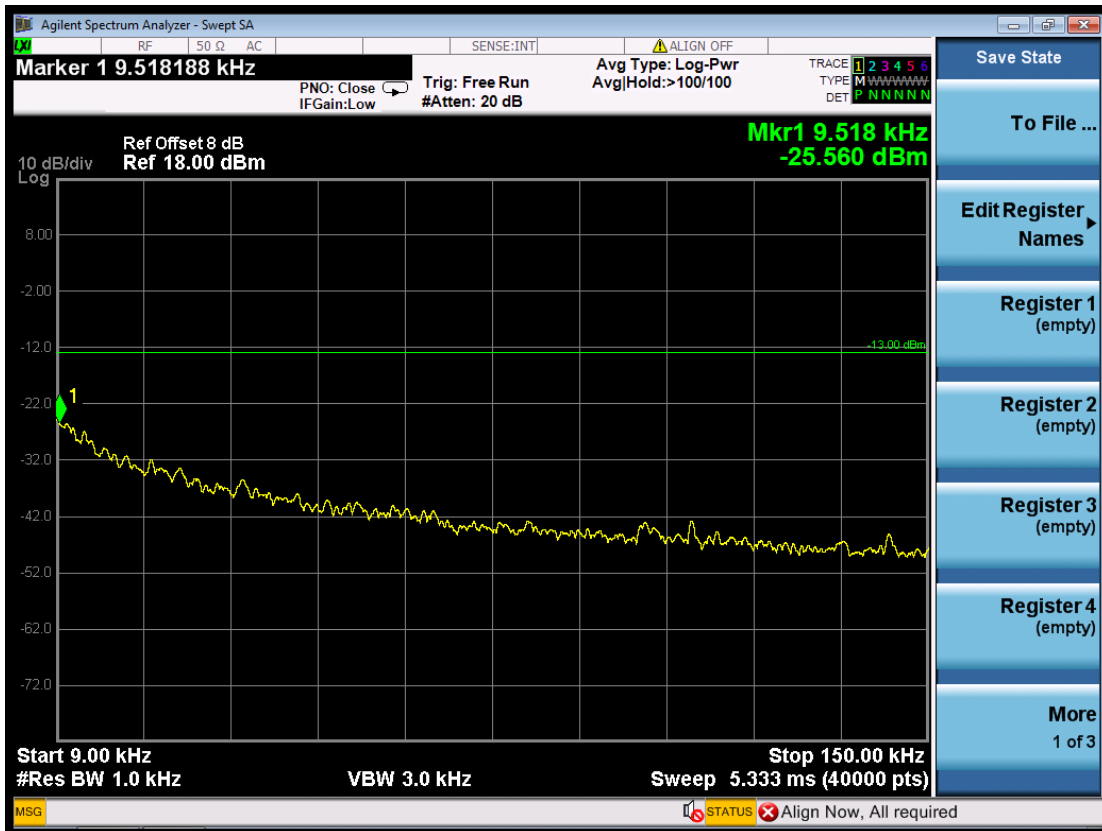

(Plot 4.6.1 A1: Channel 9262: 1852.4MHz @ Traffic WCDMA Band II)

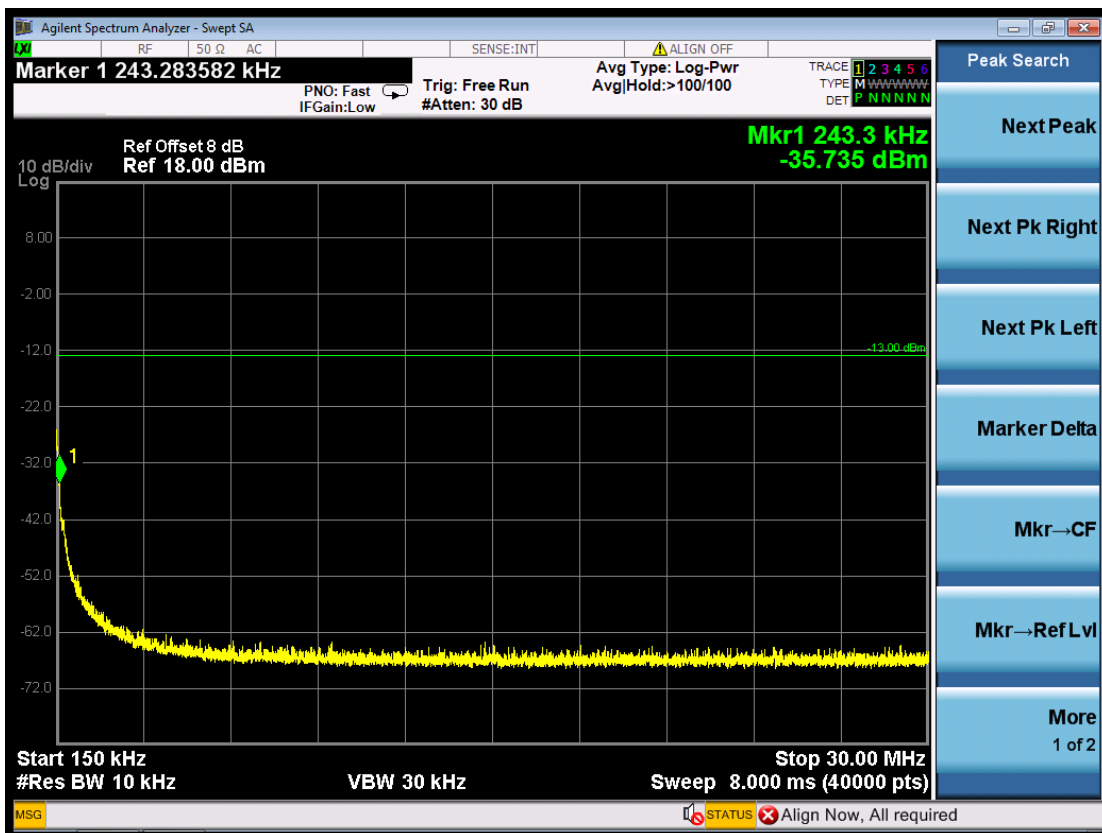

(Plot 4.6.1 A2: Channel 9262: 1852.4MHz @ Traffic WCDMA Band II)

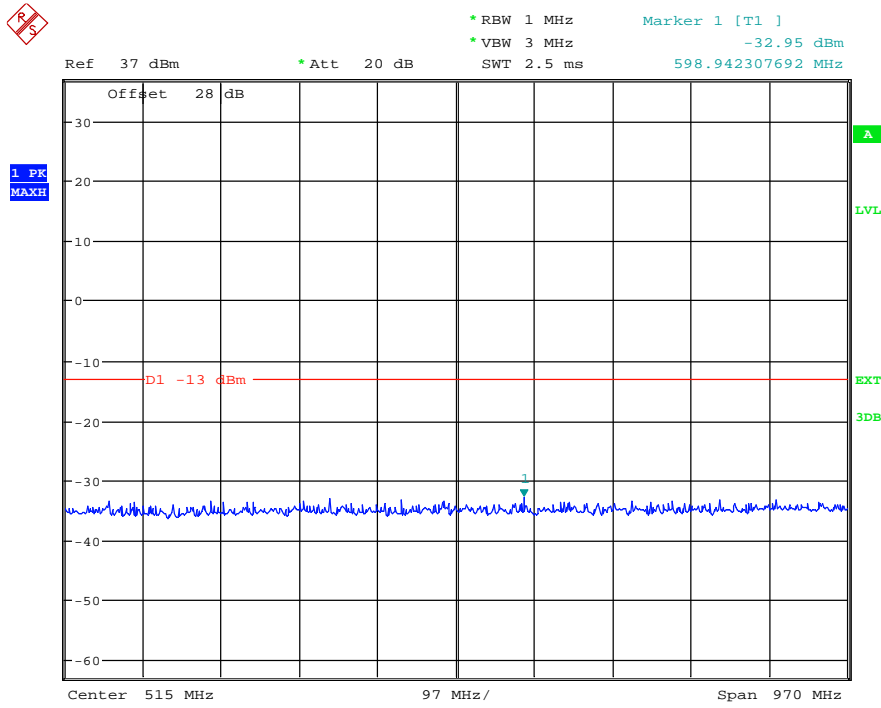

(Plot 4.6.1 A3: Channel 9262: 1852.4MHz @ Traffic WCDMA Band II)

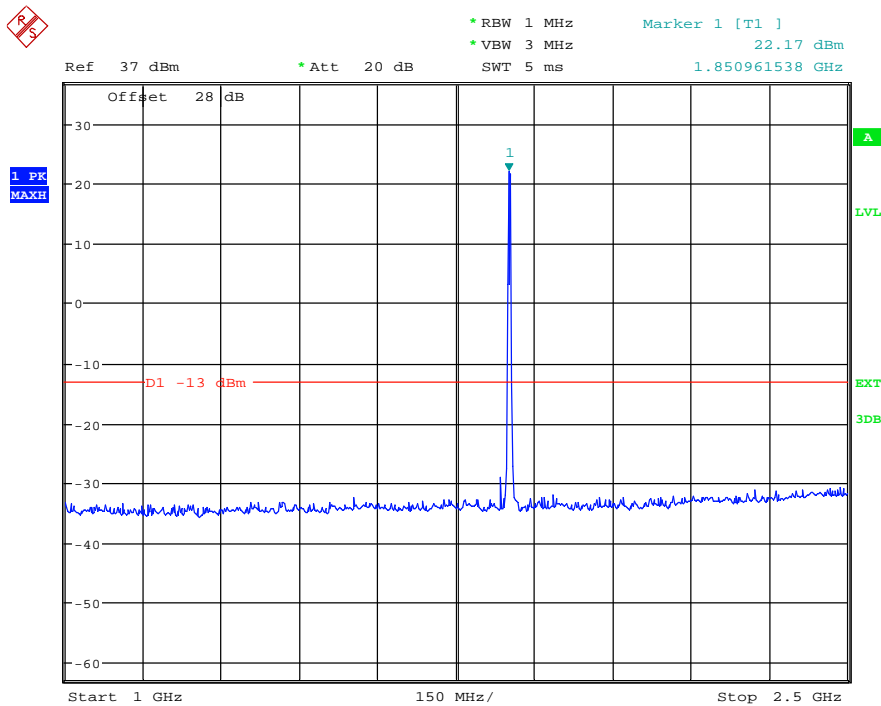

(Plot 4.6.1 A4: Channel 9262: 1852.4MHz @ Traffic WCDMA Band II)

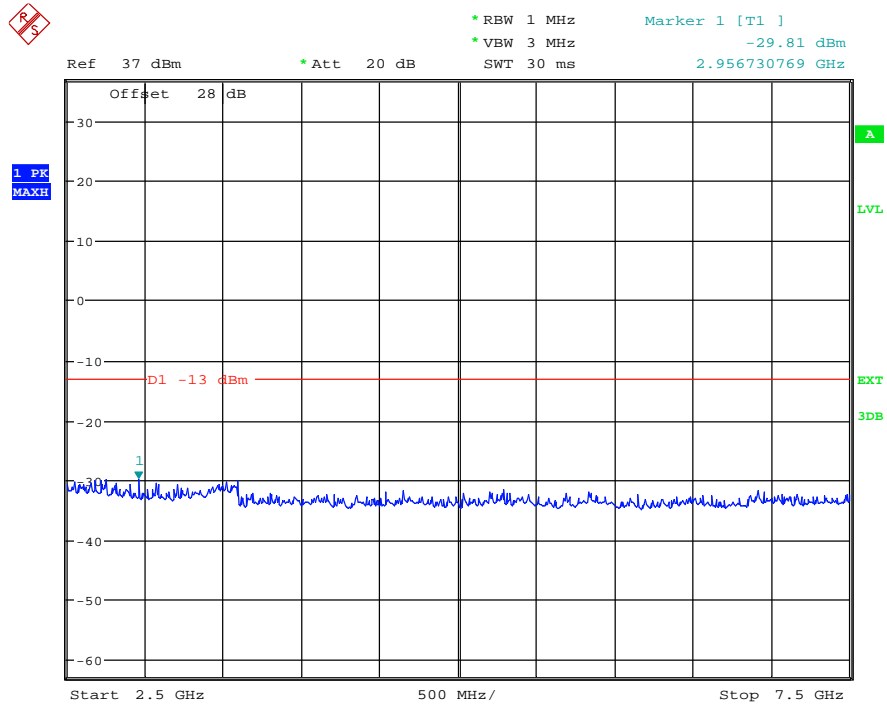

(Plot 4.6.1 A5: Channel 9262: 1852.4MHz @ Traffic WCDMA Band II)

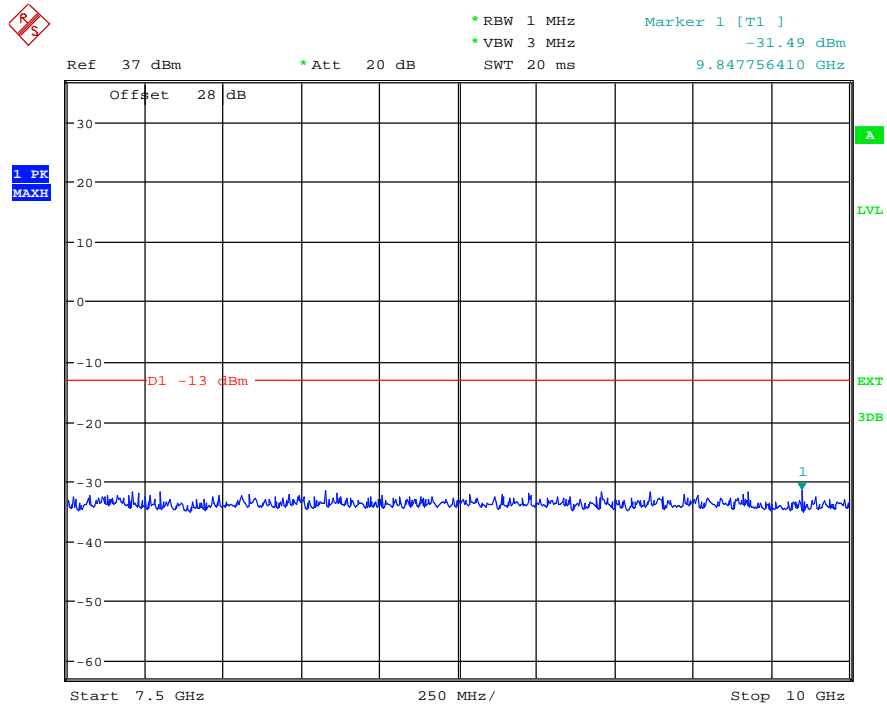

(Plot 4.6.1 A6: Channel 9262: 1852.4MHz @ Traffic WCDMA Band II)

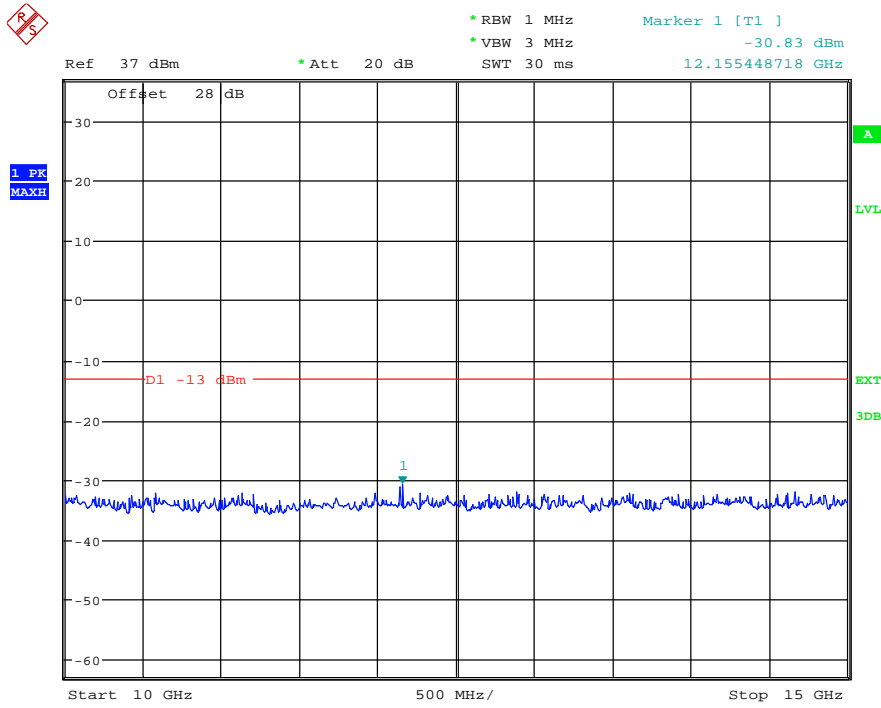

(Plot 4.6.1 A7: Channel 9262: 1852.4MHz @ Traffic WCDMA Band II)

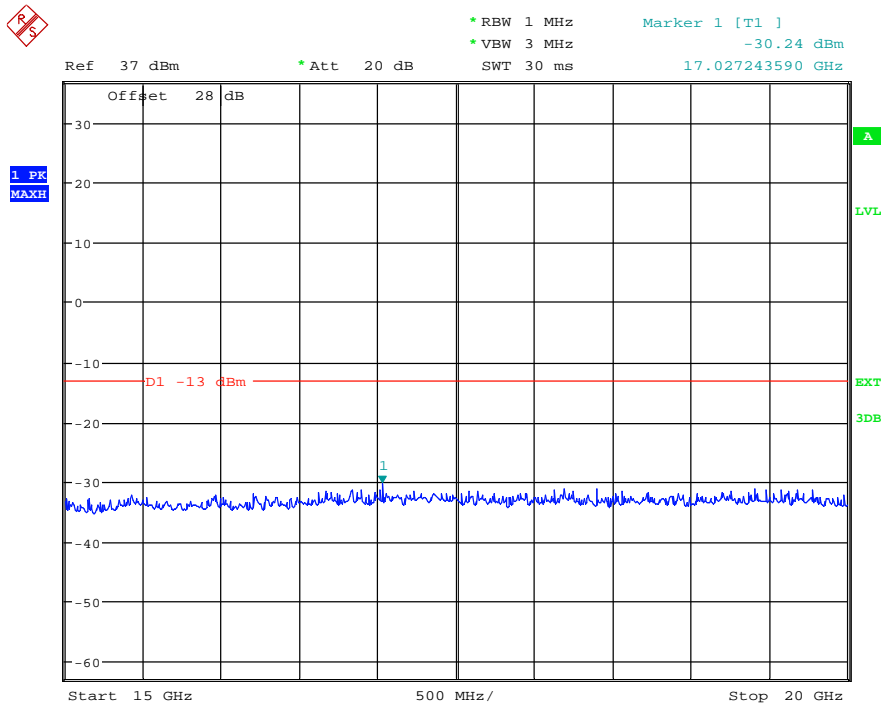

(Plot 4.6.1 A8: Channel 9262: 1852.4MHz @ Traffic WCDMA Band II)

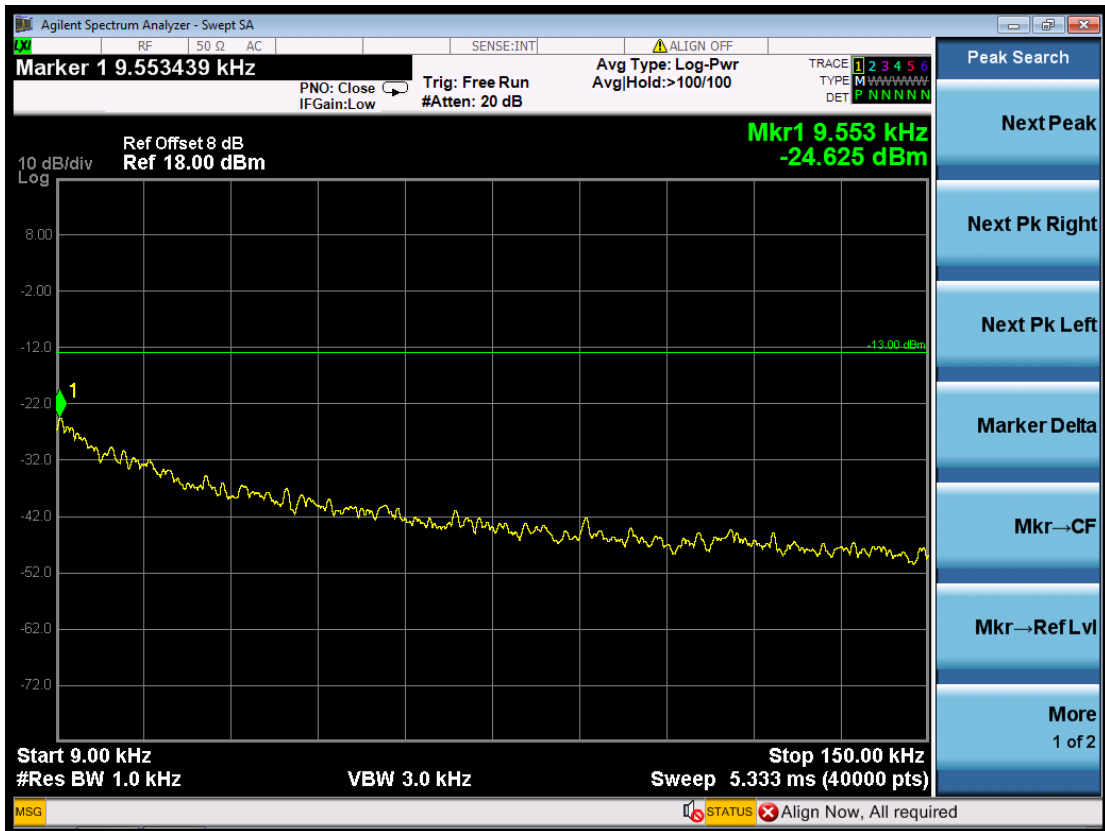

(Plot 4.6.1 B1: Channel 9400: 1880.0MHz @ Traffic WCDMA Band II)

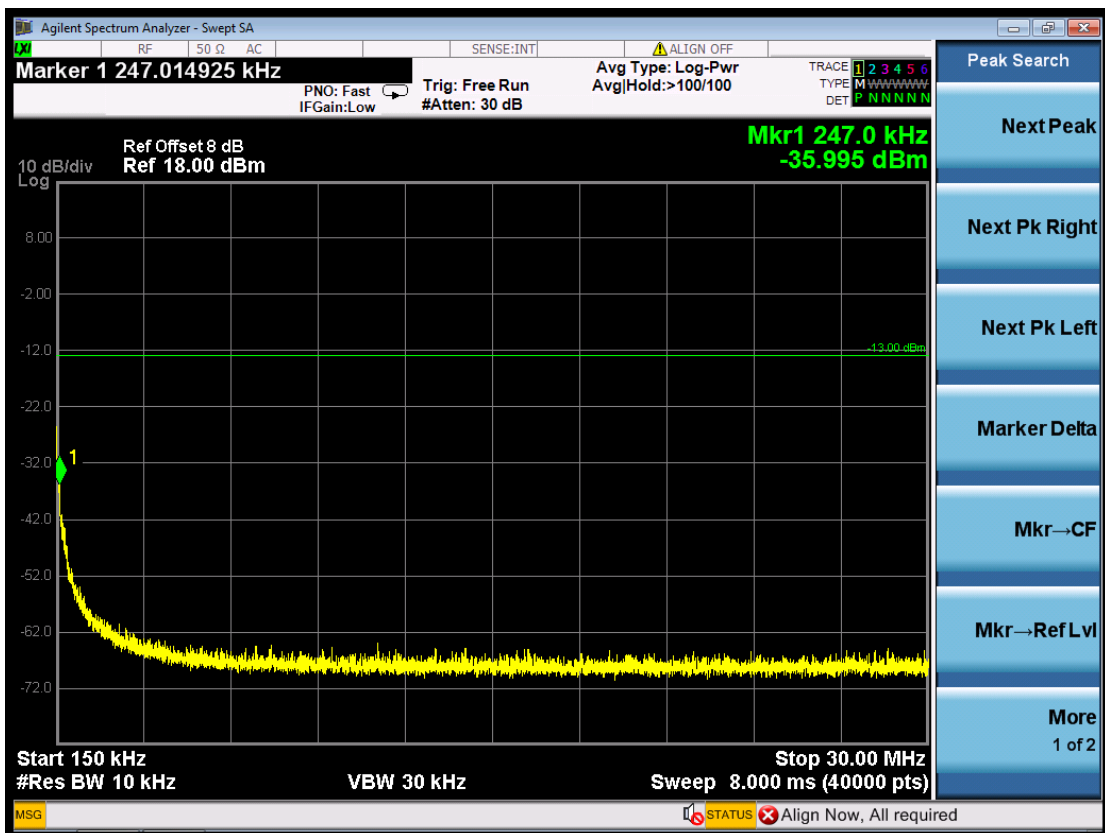

(Plot 4.6.1 B2: Channel 9400: 1880.0MHz @ Traffic WCDMA Band II)

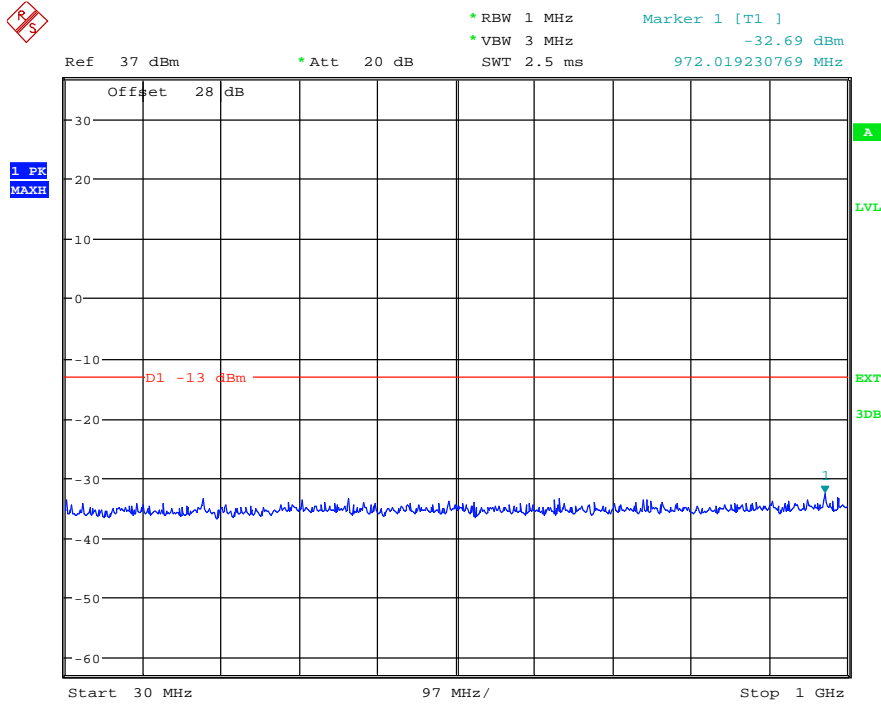

(Plot 4.6.1 B3: Channel 9400: 1880.0MHz @ Traffic WCDMA Band II)

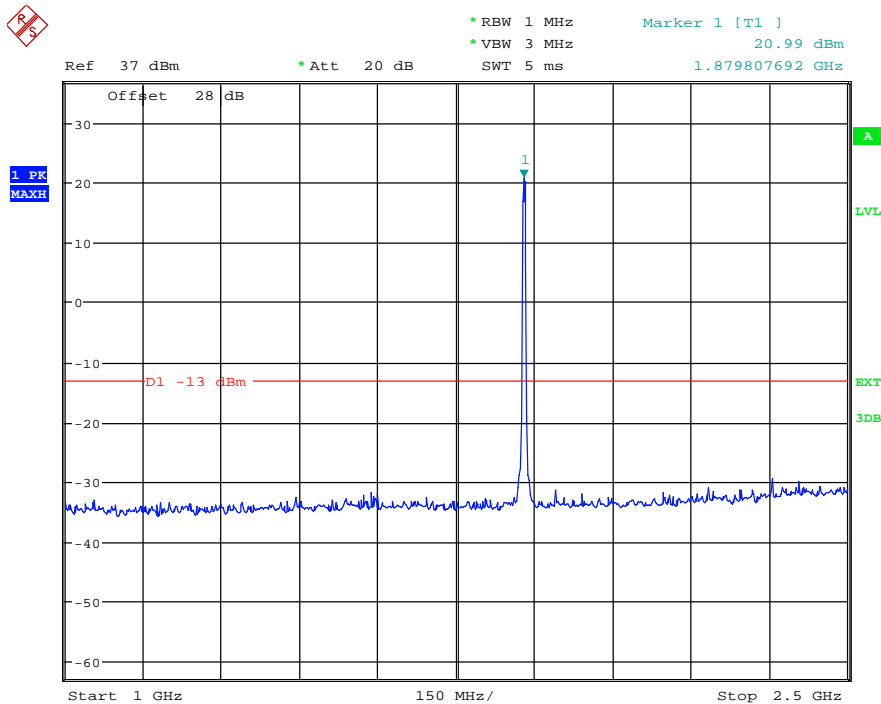

(Plot 4.6.1 B4: Channel 9400: 1880.0MHz @ Traffic WCDMA Band II)

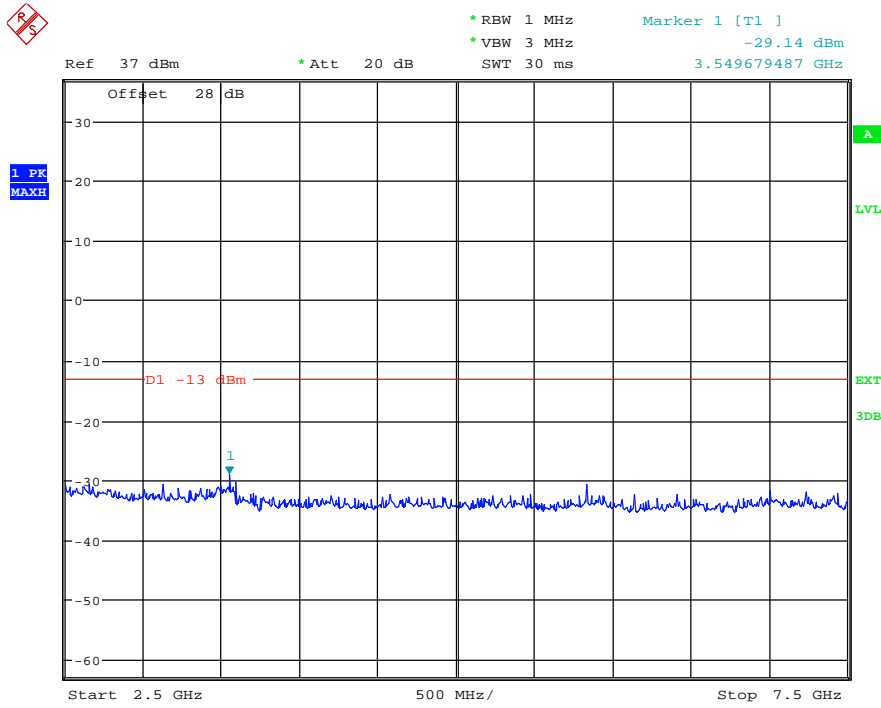

(Plot 4.6.1 B5: Channel 9400: 1880.0MHz @ Traffic WCDMA Band II)

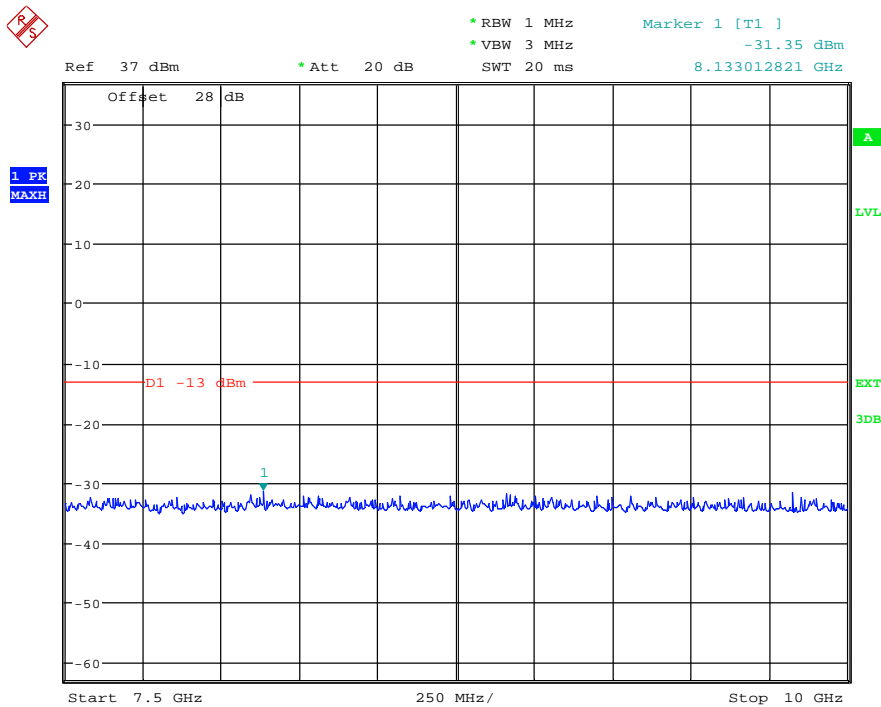

(Plot 4.6.1 B6: Channel 9400: 1880.0MHz @ Traffic WCDMA Band II)



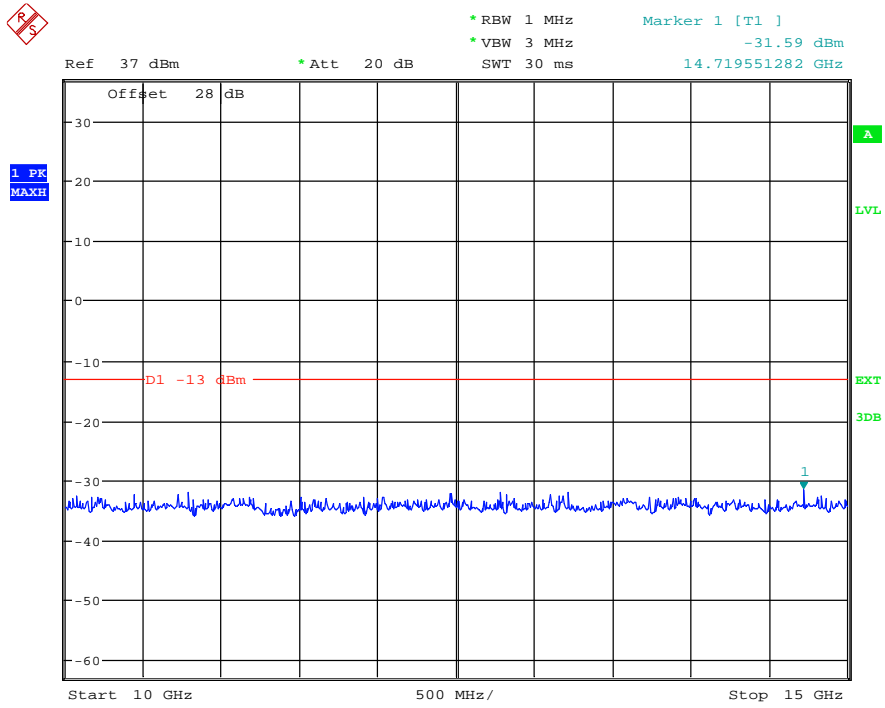

(Plot 4.6.1 B7: Channel 9400: 1880.0MHz @ Traffic WCDMA Band II)

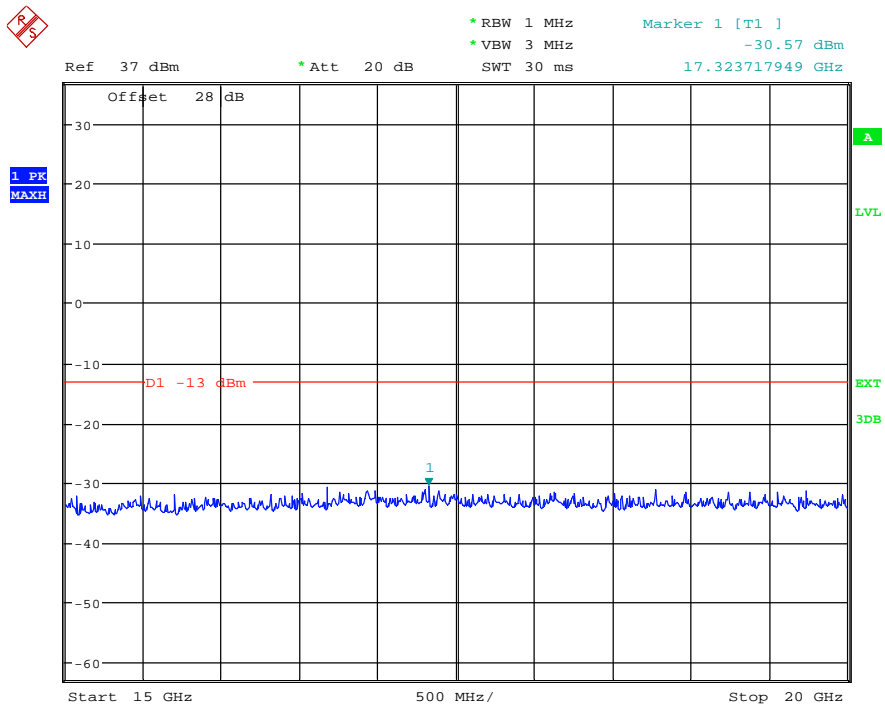

(Plot 4.6.1 B8: Channel 9400: 1880.0MHz @ Traffic WCDMA Band II)

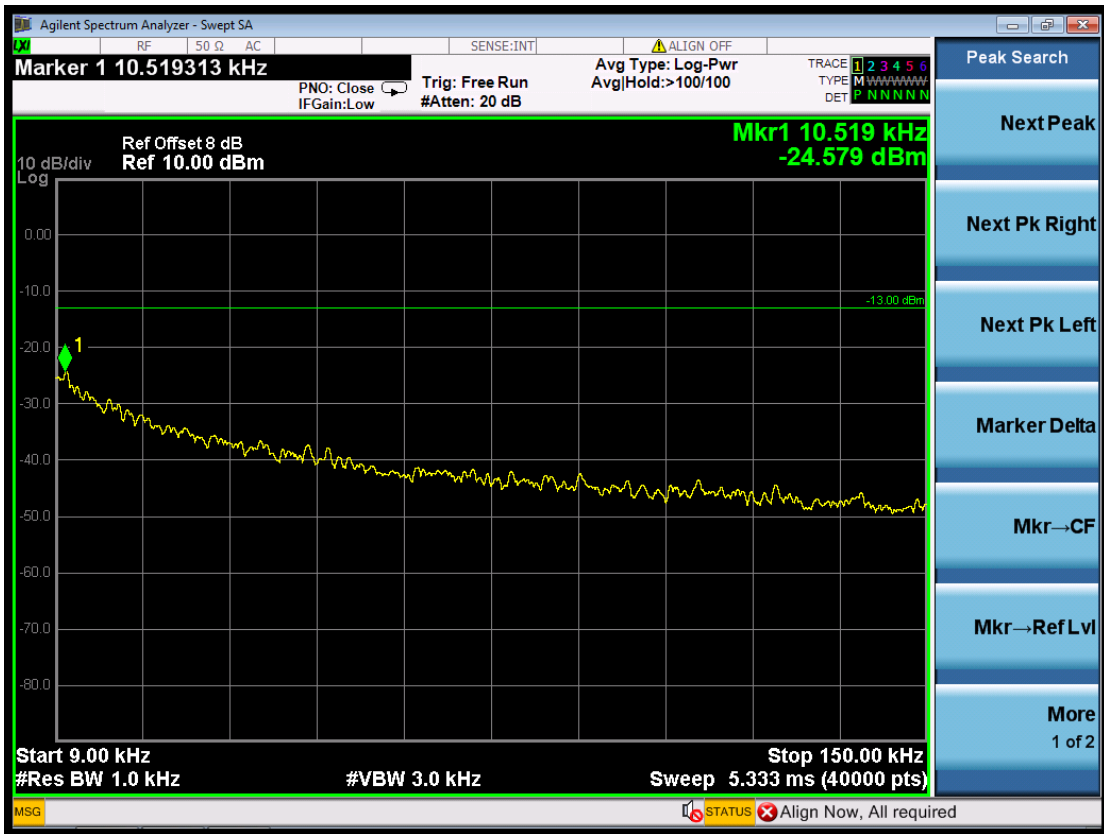

(Plot 4.6.1 C1: Channel 9538: 1907.6MHz @ Traffic WCDMA Band II)

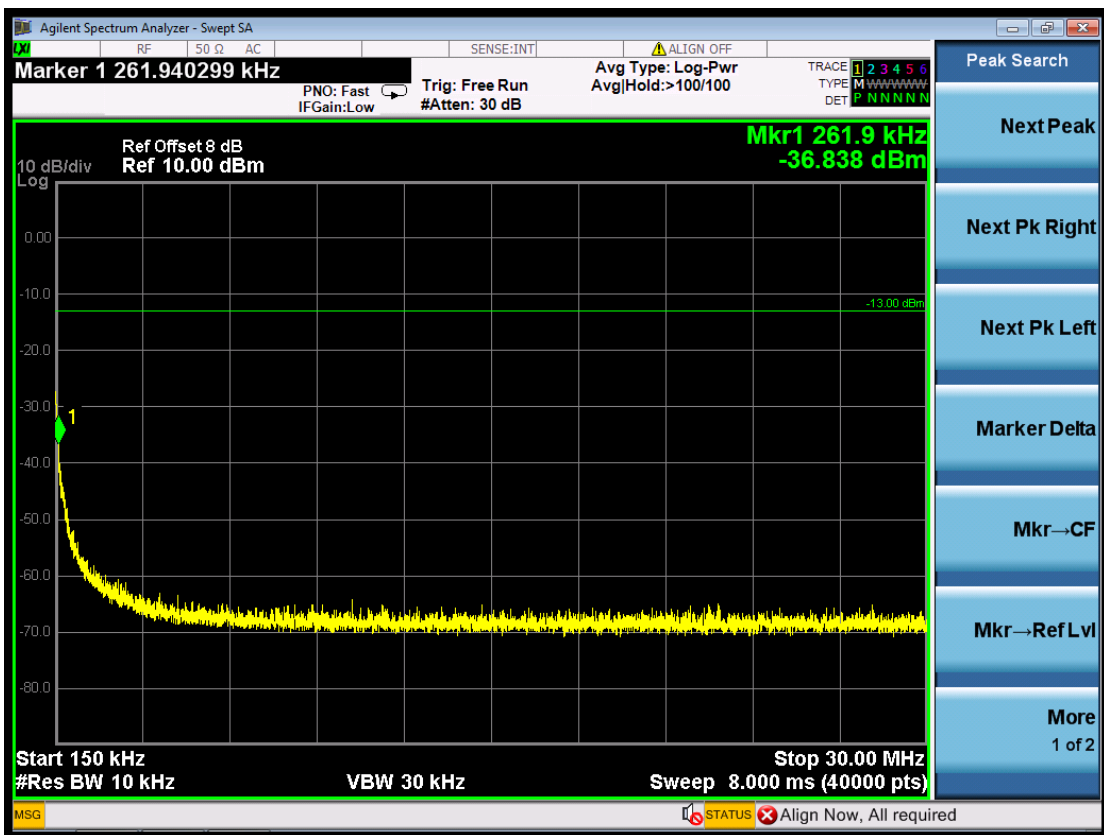

(Plot 4.6.1 C2: Channel 9538: 1907.6MHz @ Traffic WCDMA Band II)

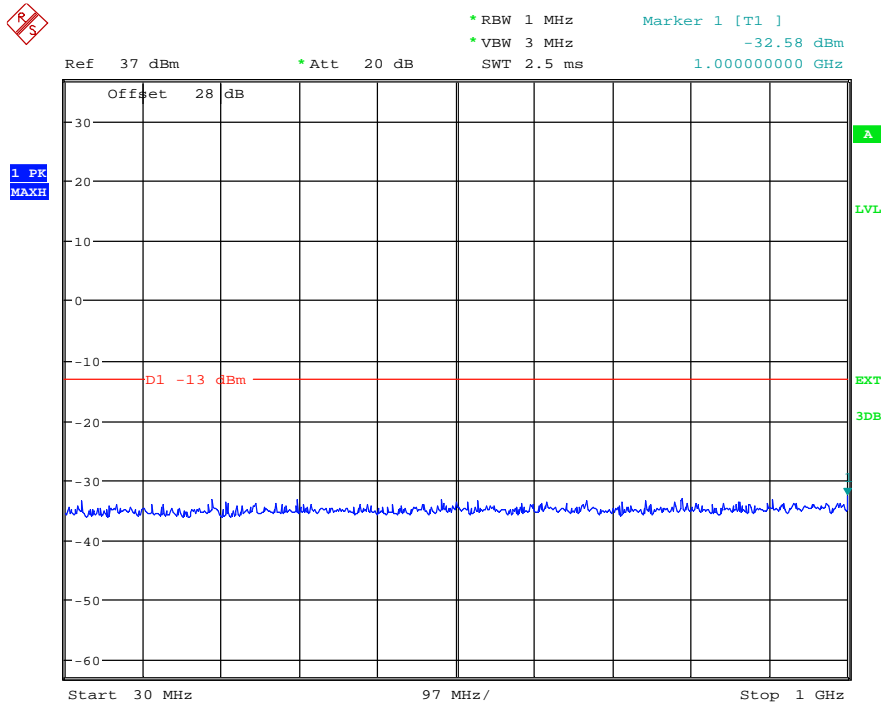

(Plot 4.6.1 C3: Channel 9538: 1907.6MHz @ Traffic WCDMA Band II)

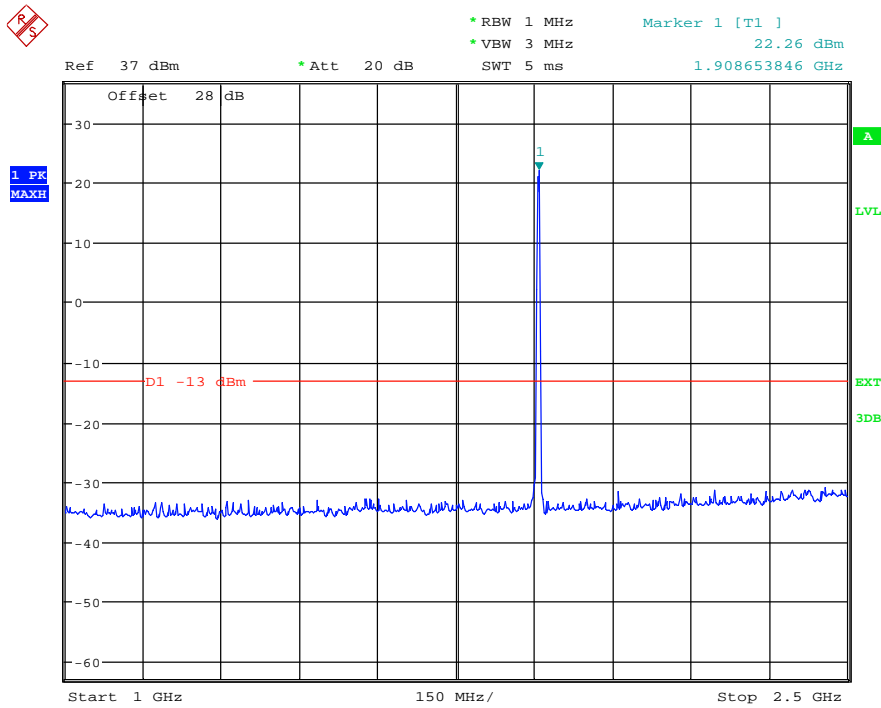

(Plot 4.6.1 C4: Channel 9538: 1907.6MHz @ Traffic WCDMA Band II)

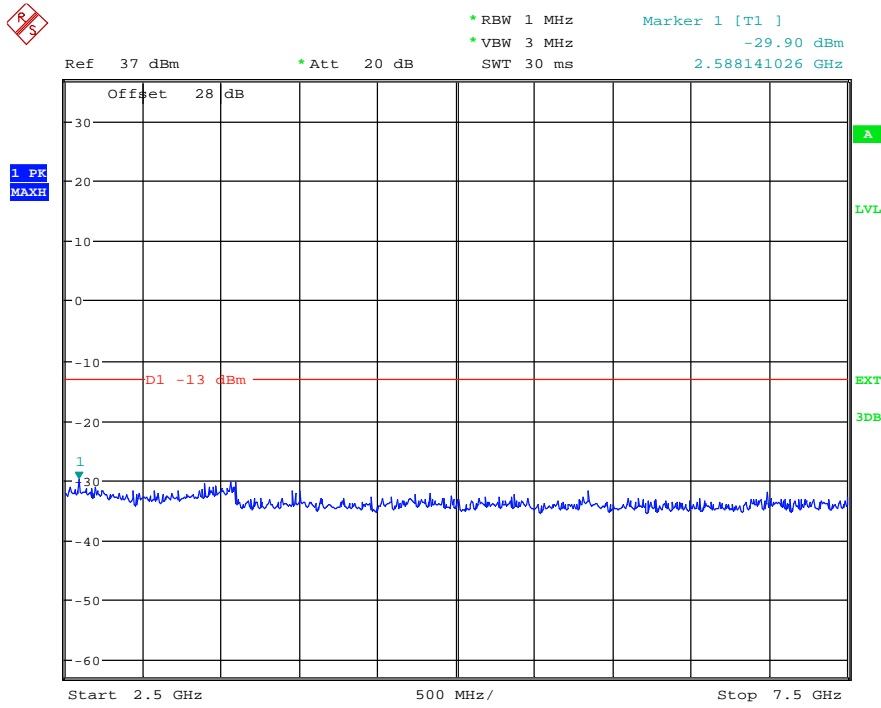

(Plot 4.6.1 C5: Channel 9538: 1907.6MHz @ Traffic WCDMA Band II)

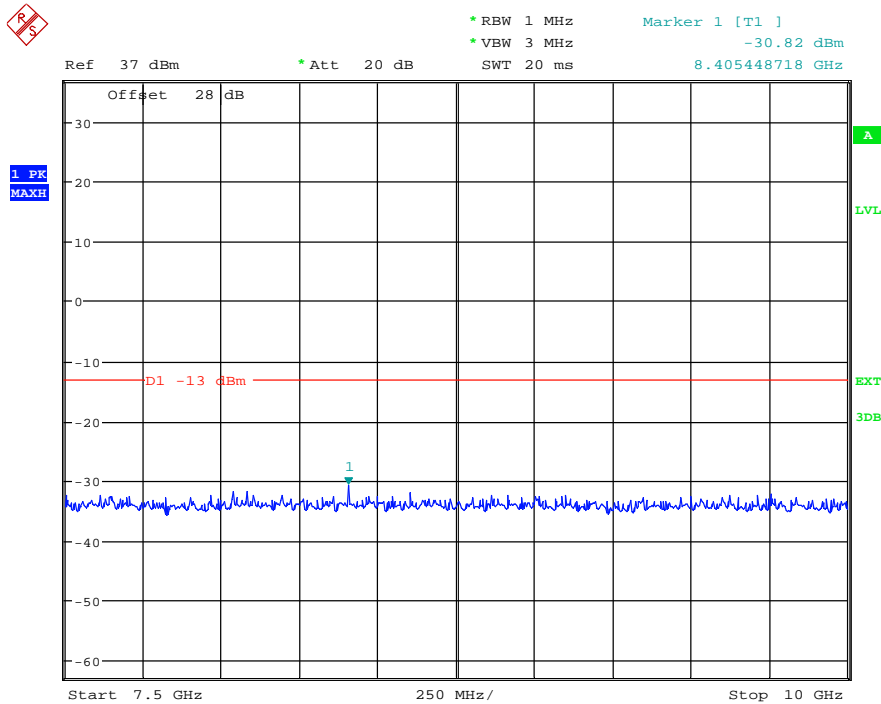

(Plot 4.6.1 C6: Channel 9538: 1907.6MHz @ Traffic WCDMA Band II)

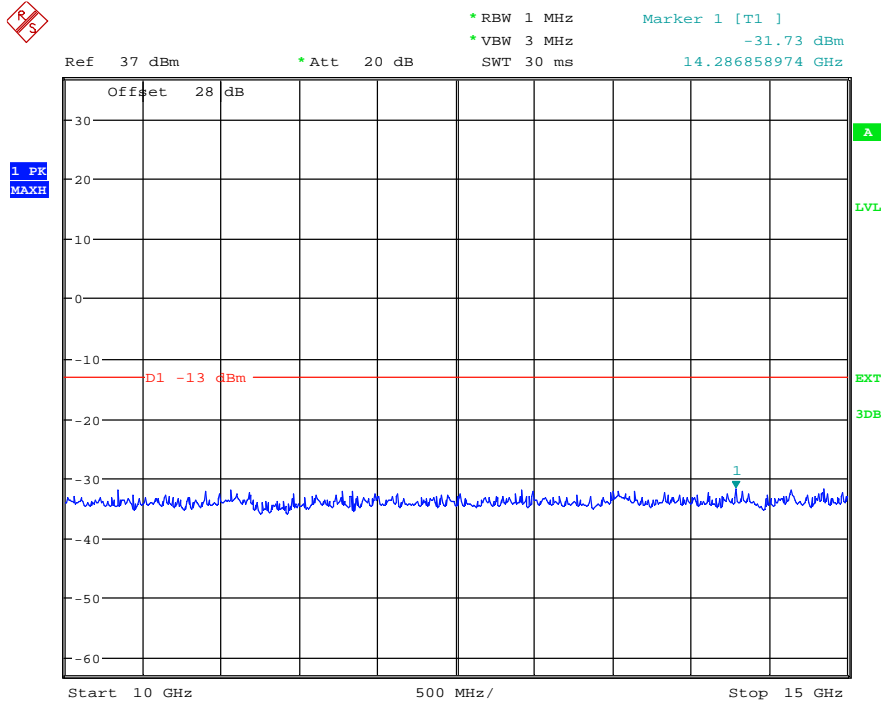

(Plot 4.6.1 C7: Channel 9538: 1907.6MHz @ Traffic WCDMA Band II)

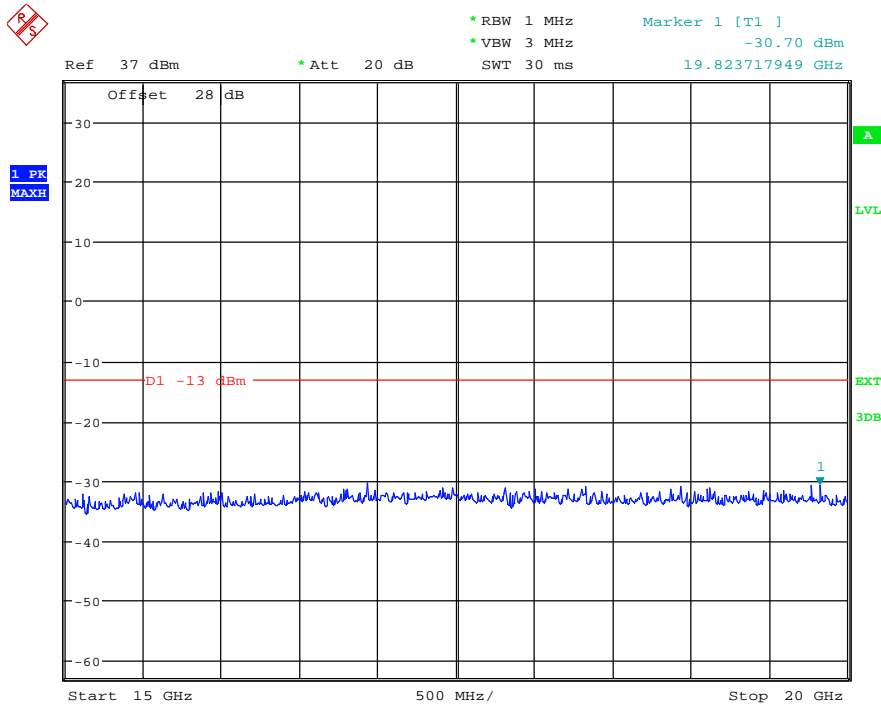

(Plot 4.6.1 C8: Channel 9538: 1907.6MHz @ Traffic WCDMA Band II)



(Plot 4.6.1 D1: Idle WCDMA Band II)

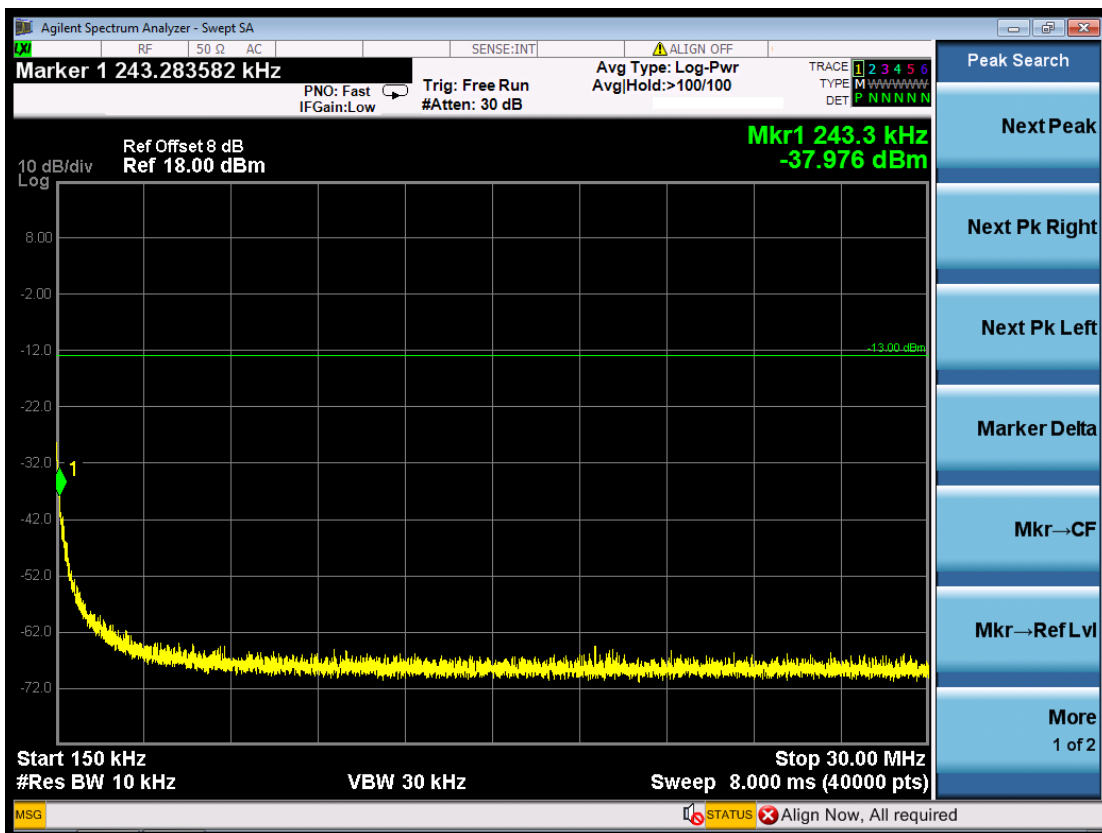

(Plot 4.6.1 D2: Idle WCDMA Band II)

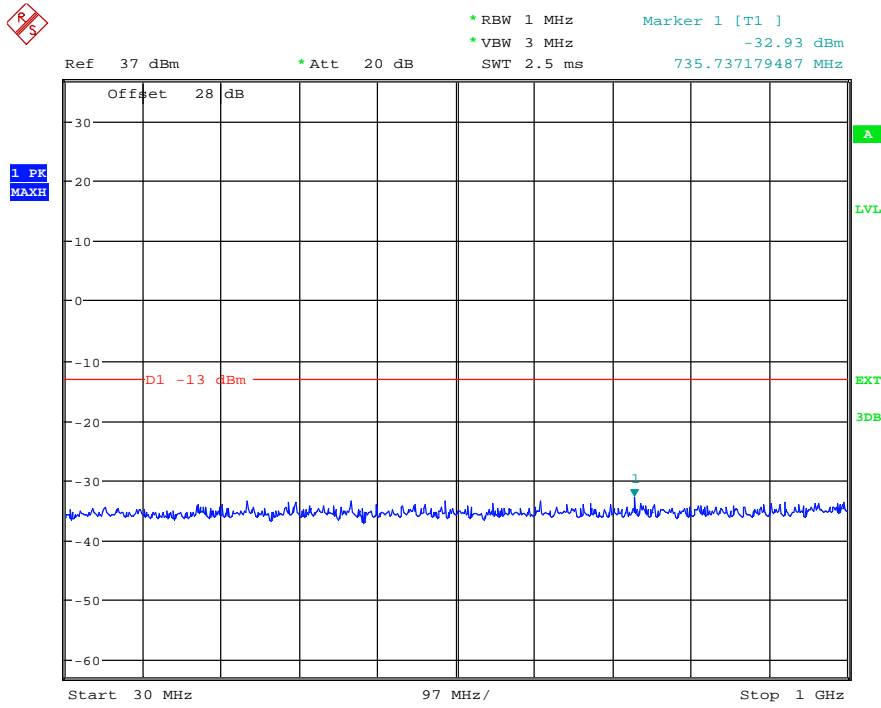

(Plot 4.6.1 D3: Idle WCDMA Band II)

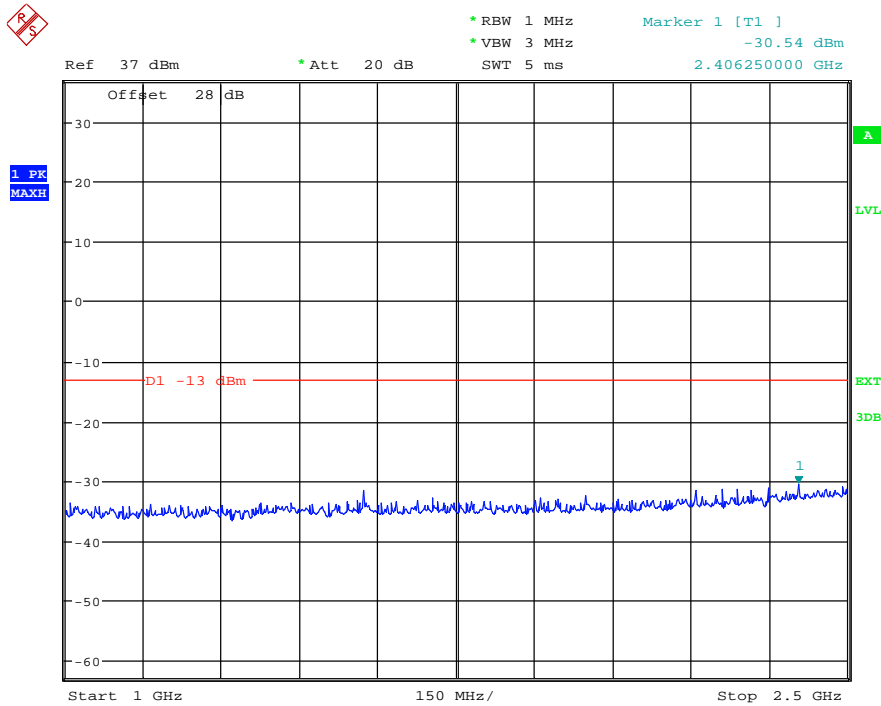

(Plot 4.6.1 D4: Idle WCDMA Band II)

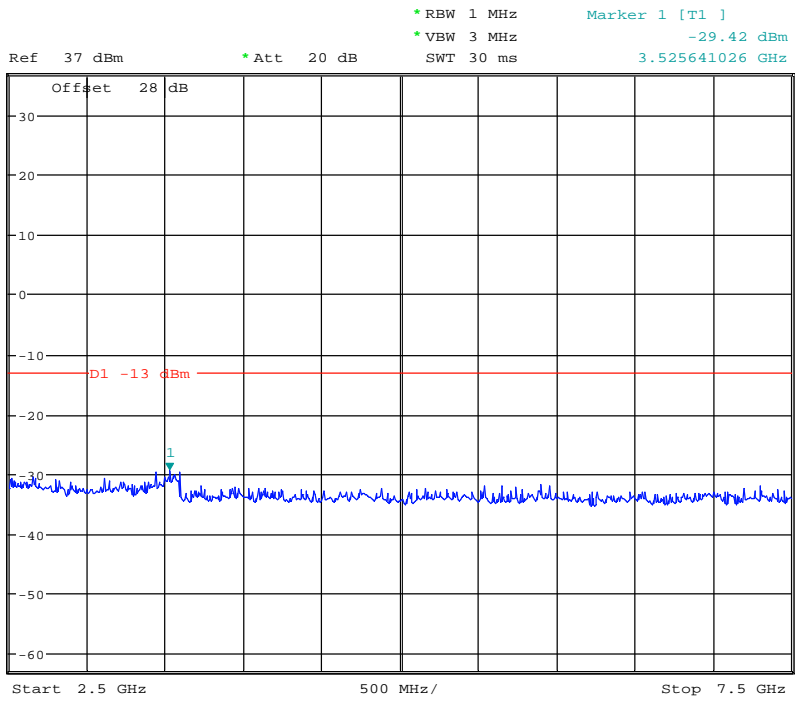

(Plot 4.6.1 D5: Idle WCDMA Band II)

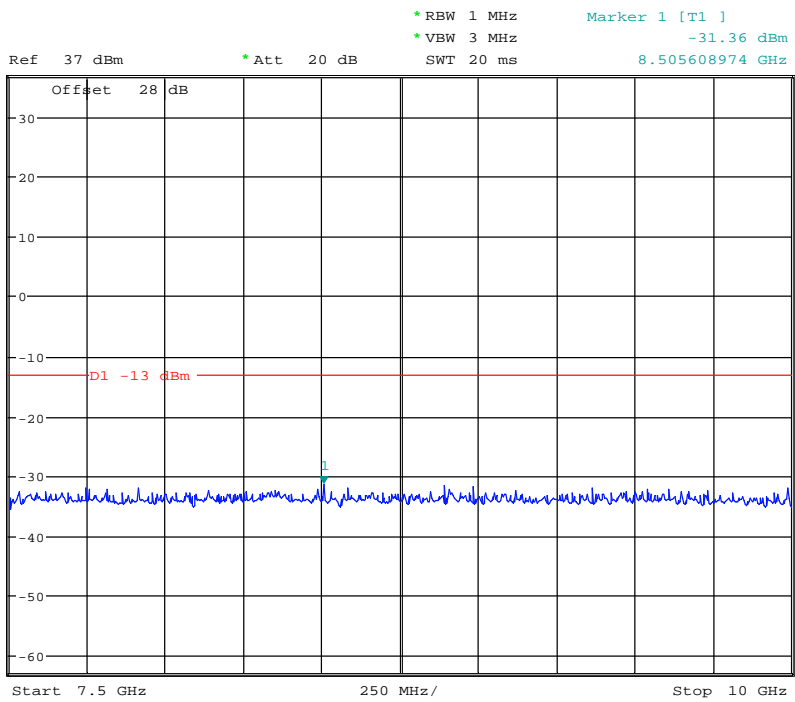

(Plot 4.6.1 D6: Idle WCDMA Band II)



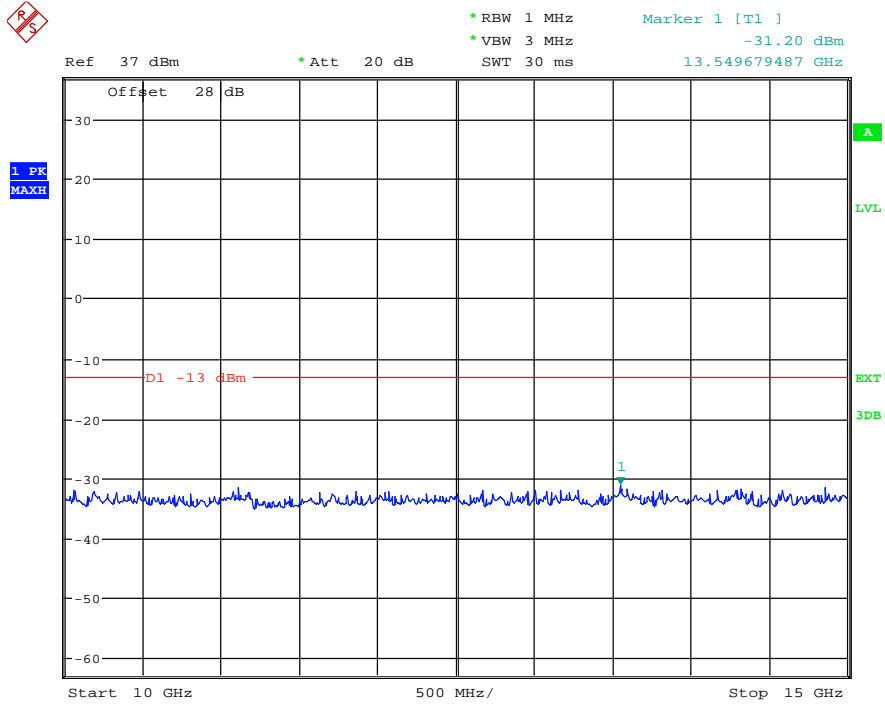

(Plot 4.6.1 D7: Idle WCDMA Band II)

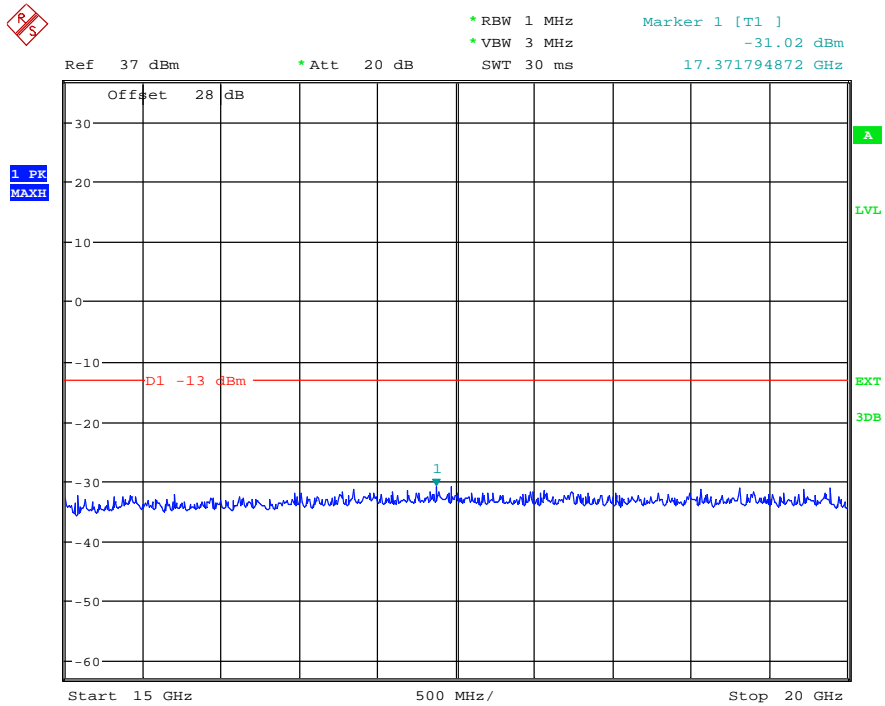

(Plot 4.6.1 D8: Idle WCDMA Band II)

### 4.6.2 For WCDMA Band V Test Results

#### A. Test Verdict

Test Mode/ Channel	Frequency (MHz)	Frequency Range	Refer to Plot	Limit (dBm)	Verdict
UMTS/TM1/WCDMA Band V/4132	826.40	9KHz-150KHz	Plot 4.6.2 A1	-13.00	PASS
		150KHz-30MHz	Plot 4.6.2 A2	-13.00	PASS
		30MHz-1GHz	Plot 4.6.2 A3	-13.00	PASS
		1GHz-2.5GHz	Plot 4.6.2 A4	-13.00	PASS
		2.5GHz-7.5GHz	Plot 4.6.2 A5	-13.00	PASS
		7.5GHz-10GHz	Plot 4.6.2 A6	-13.00	PASS
UMTS/TM1/WCDMA Band V/4183	836.60	9KHz-150KHz	Plot 4.6.2 B1	-13.00	PASS
		150KHz-30MHz	Plot 4.6.2 B2	-13.00	PASS
		30MHz-1GHz	Plot 4.6.2 B3	-13.00	PASS
		1GHz-2.5GHz	Plot 4.6.2 B4	-13.00	PASS
		2.5GHz-7.5GHz	Plot 4.6.2 B5	-13.00	PASS
		7.5GHz-10GHz	Plot 4.6.2 B6	-13.00	PASS
UMTS/TM1/WCDMA Band V/4233	846.60	9KHz-150KHz	Plot 4.6.2 C1	-13.00	PASS
		150KHz-30MHz	Plot 4.6.2 C2	-13.00	PASS
		30MHz-1GHz	Plot 4.6.2 C3	-13.00	PASS
		1GHz-2.5GHz	Plot 4.6.2 C4	-13.00	PASS
		2.5GHz-7.5GHz	Plot 4.6.2 C5	-13.00	PASS
		7.5GHz-10GHz	Plot 4.6.2 C6	-13.00	PASS
UMTS/TM1/WCDMA Band V/Idle	N/A	9KHz-150KHz	Plot 4.6.2 D1	-13.00	PASS
		150KHz-30MHz	Plot 4.6.2 D2	-13.00	PASS
		30MHz-1GHz	Plot 4.6.2 D3	-13.00	PASS
		1GHz-2.5GHz	Plot 4.6.2 D4	-13.00	PASS
		2.5GHz-7.5GHz	Plot 4.6.2 D5	-13.00	PASS
		7.5GHz-10GHz	Plot 4.6.2 D6	-13.00	PASS

Note: 1. In general, the worse case attenuation requirement shown above was applied.

2."---" means that the emission level is too low to be measured or at least 20 dB down than the limit.

#### B. Test Plots

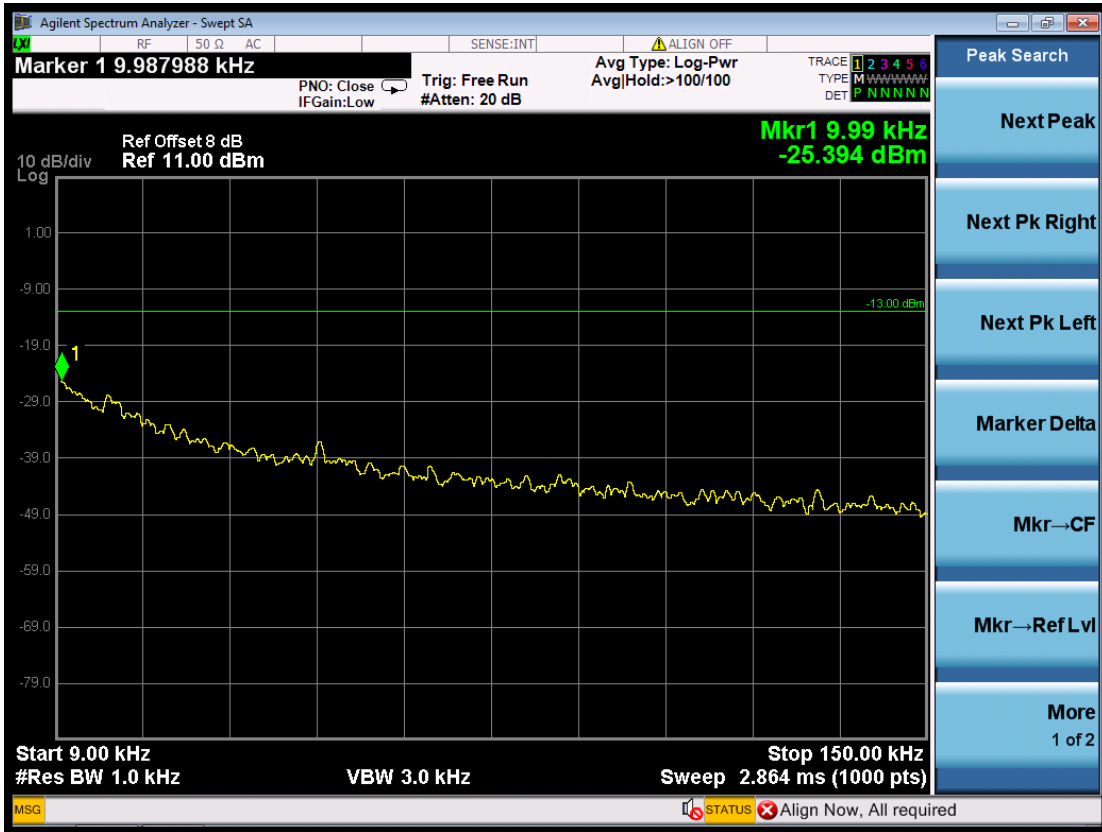

(Plot 4.6.2 A1: Channel 4132: 826.40 MHz @ WCDMA Band V)

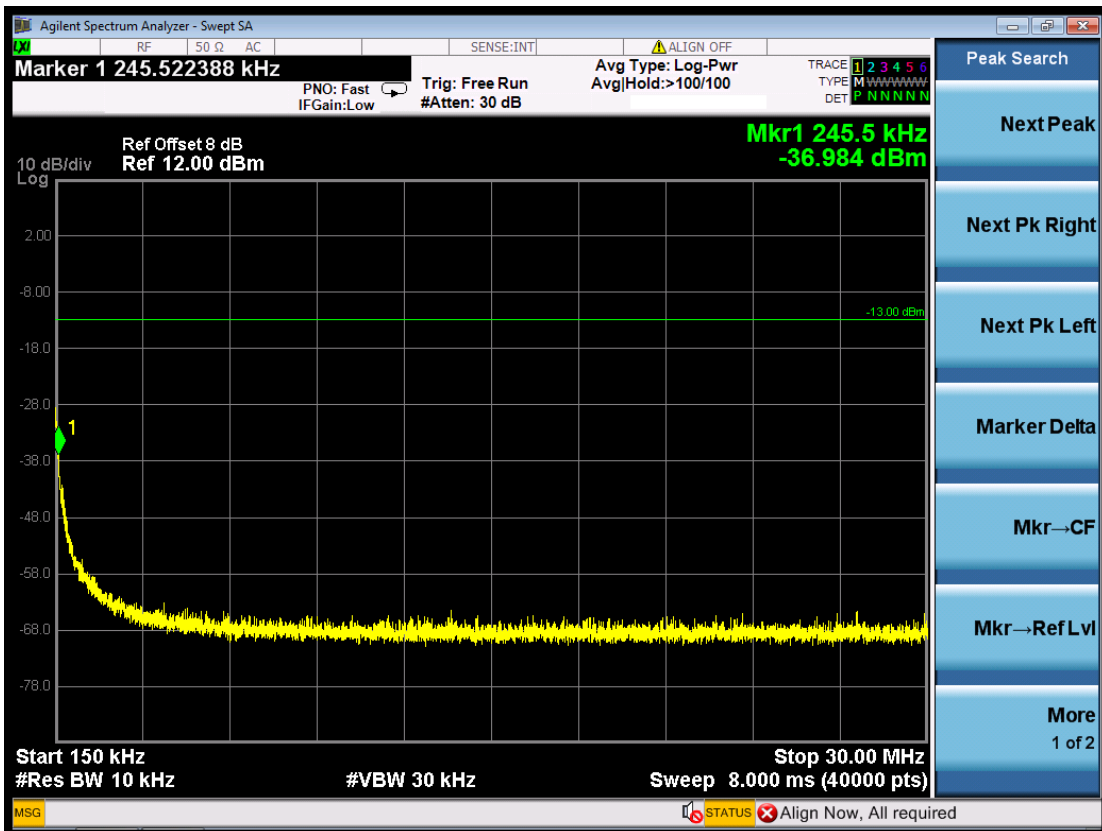

(Plot 4.6.2 A2: Channel 4132: 826.40 MHz @ WCDMA Band V)

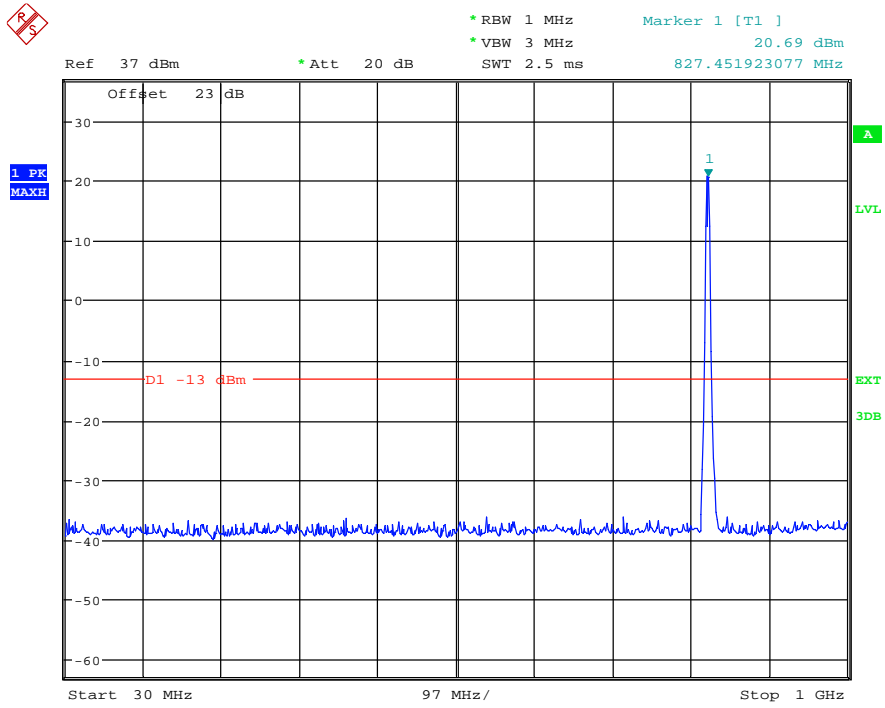

(Plot 4.6.2 A3: Channel 4132: 826.40 MHz @ WCDMA Band V)

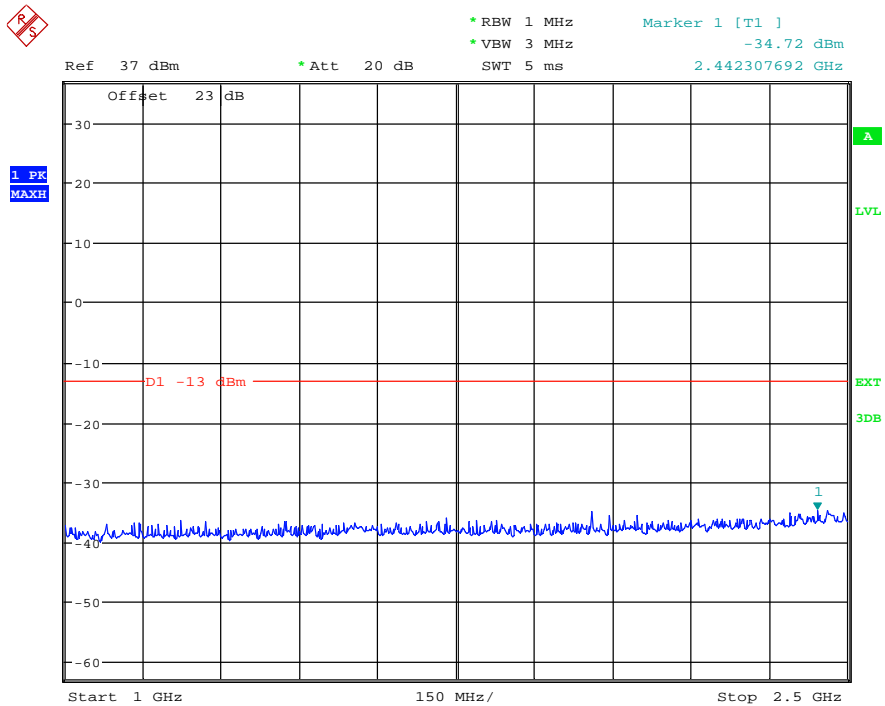

(Plot 4.6.2 A4: Channel 4132: 826.40 MHz @ WCDMA Band V)

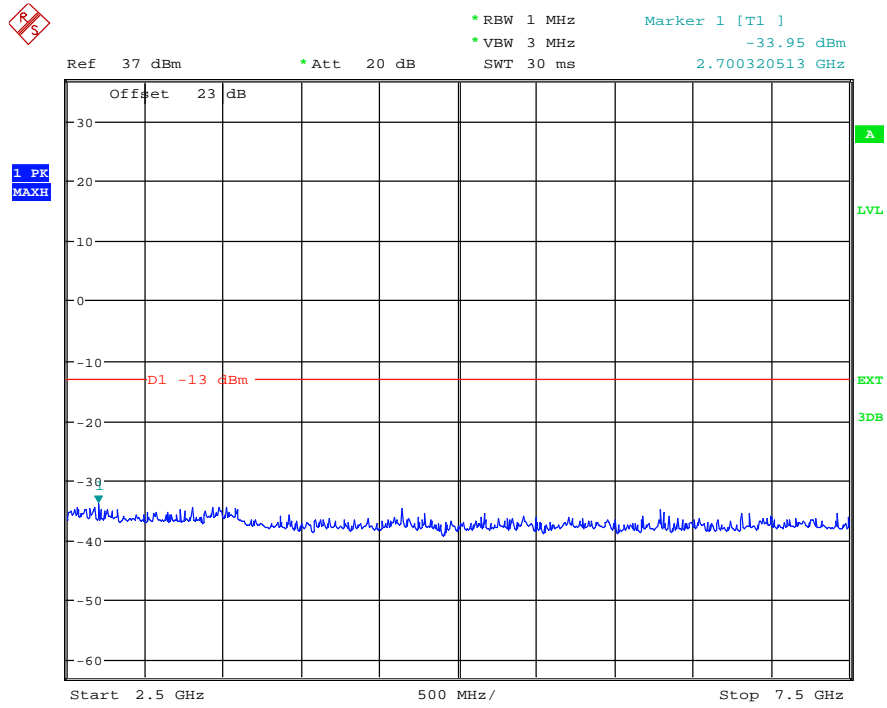

(Plot 4.6.2 A5: Channel 4132: 826.40 MHz @ WCDMA Band V)

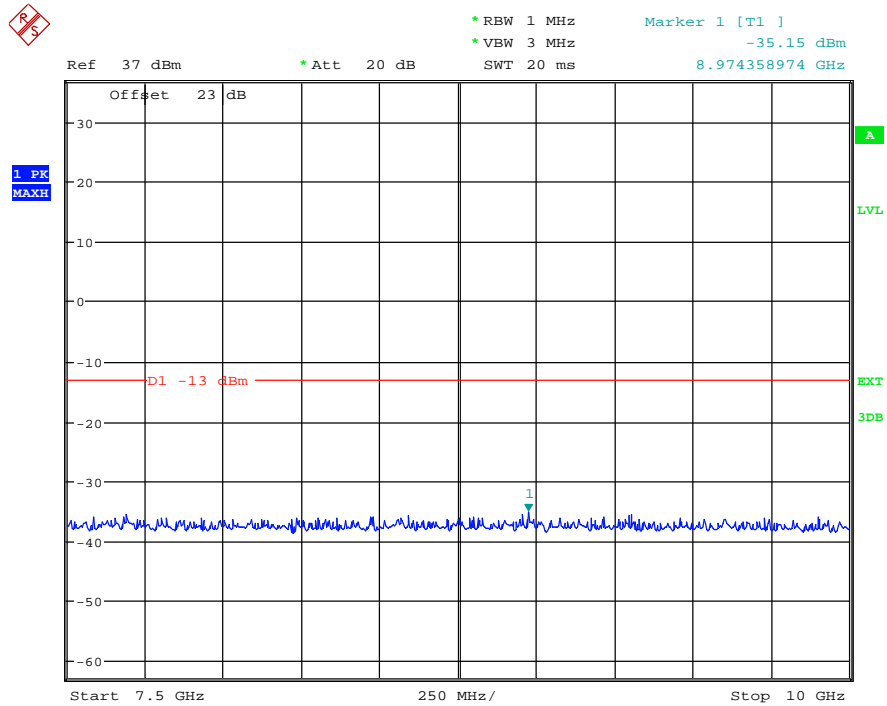

(Plot 4.6.2 A6: Channel 4132: 826.40 MHz @ WCDMA Band V)



(Plot 4.6.2 B1: Channel 4183: 836.60 MHz @ WCDMA Band V)

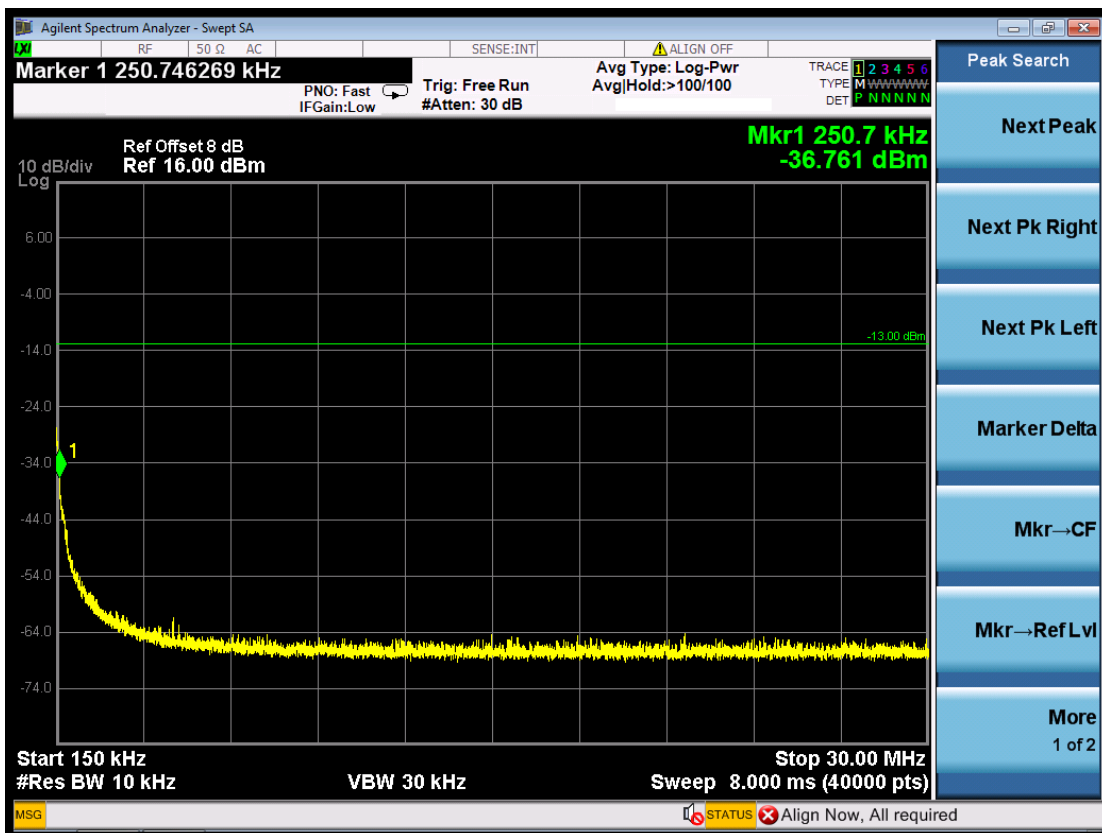

(Plot 4.6.2 B2: Channel 4183: 836.60 MHz @ WCDMA Band V)

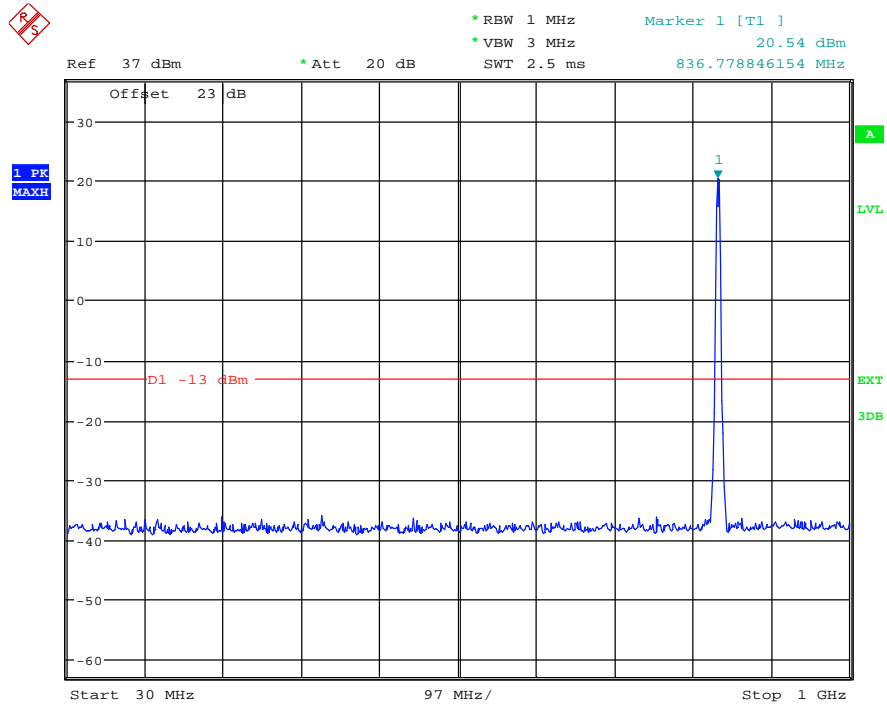

(Plot 4.6.2 B3: Channel 4183: 836.60 MHz @ WCDMA Band V)

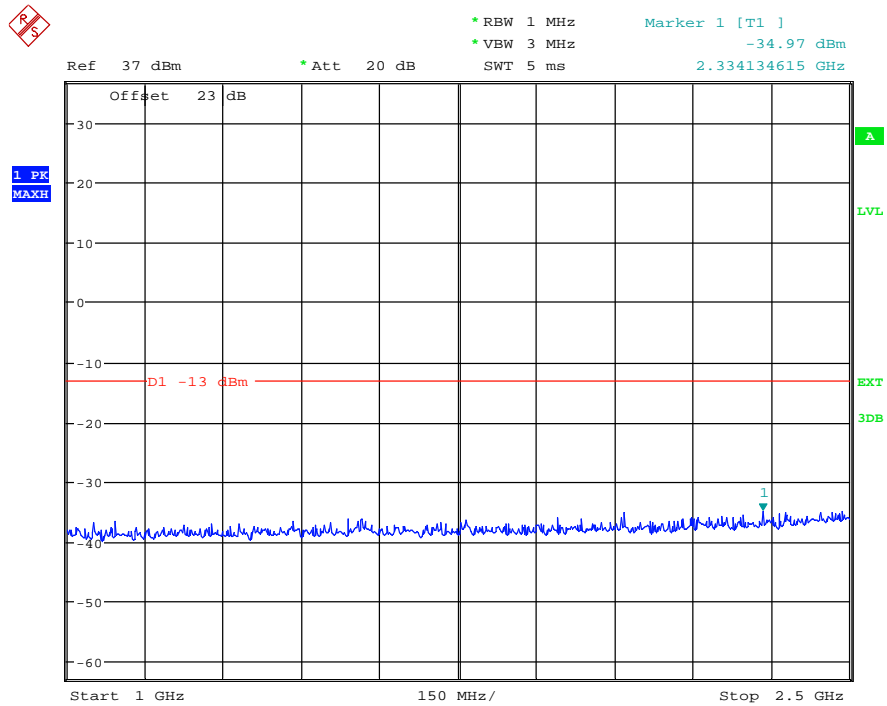

(Plot 4.6.2 B4: Channel 4183: 836.60 MHz @ WCDMA Band V)

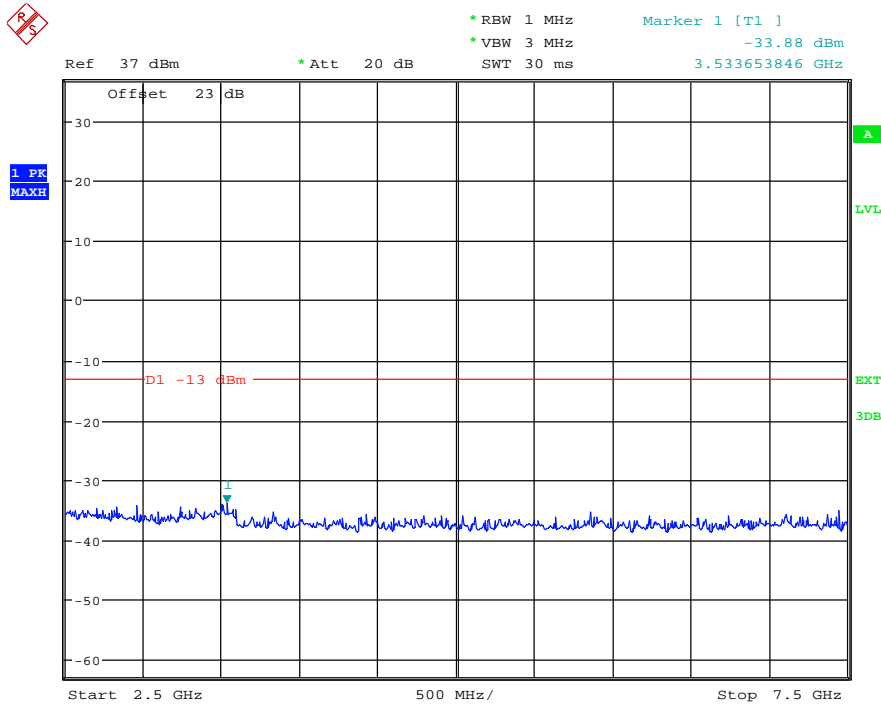

(Plot 4.6.2 B5: Channel 4183: 836.60 MHz @ WCDMA Band V)

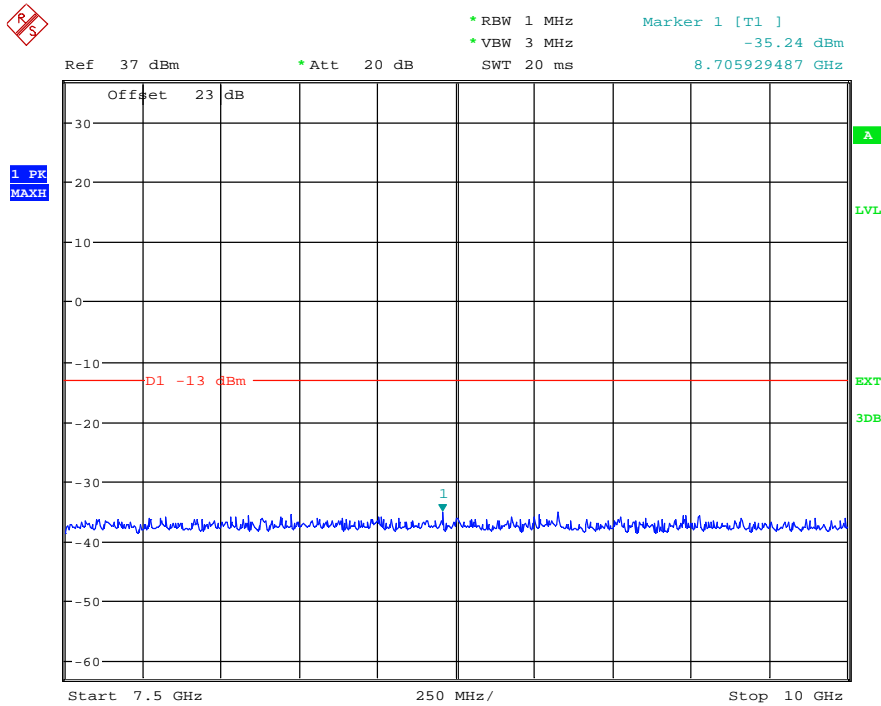

(Plot 4.6.2 B6: Channel 4183: 836.60 MHz @ WCDMA Band V)





(Plot 4.6.2 C1: Channel 4233: 846.60 MHz @ WCDMA Band V)

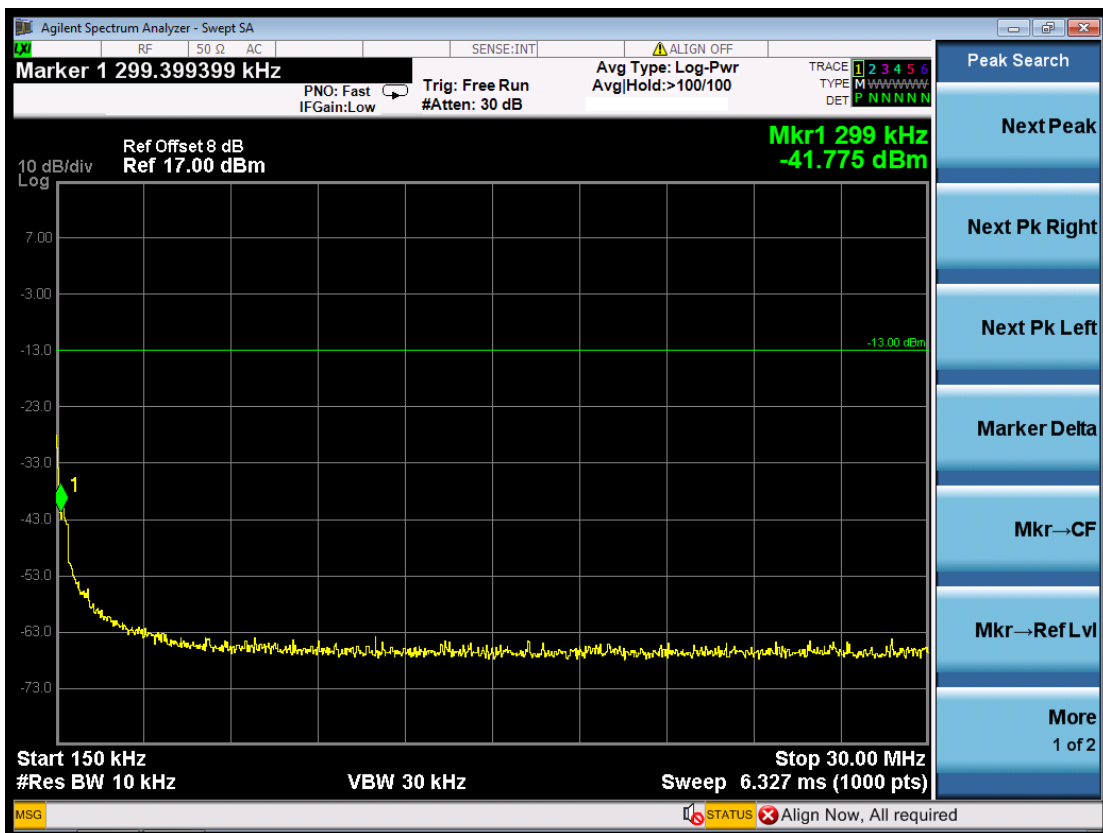

(Plot 4.6.2 C2: Channel 4233: 846.60 MHz @ WCDMA Band V)

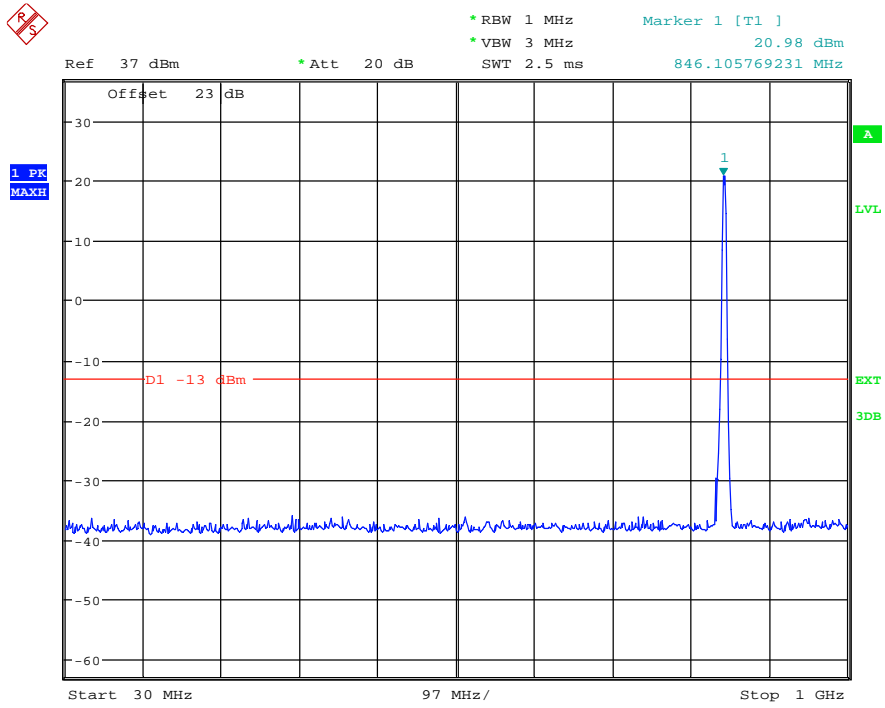

(Plot 4.6.2 C3: Channel 4233: 846.60 MHz @ WCDMA Band V)

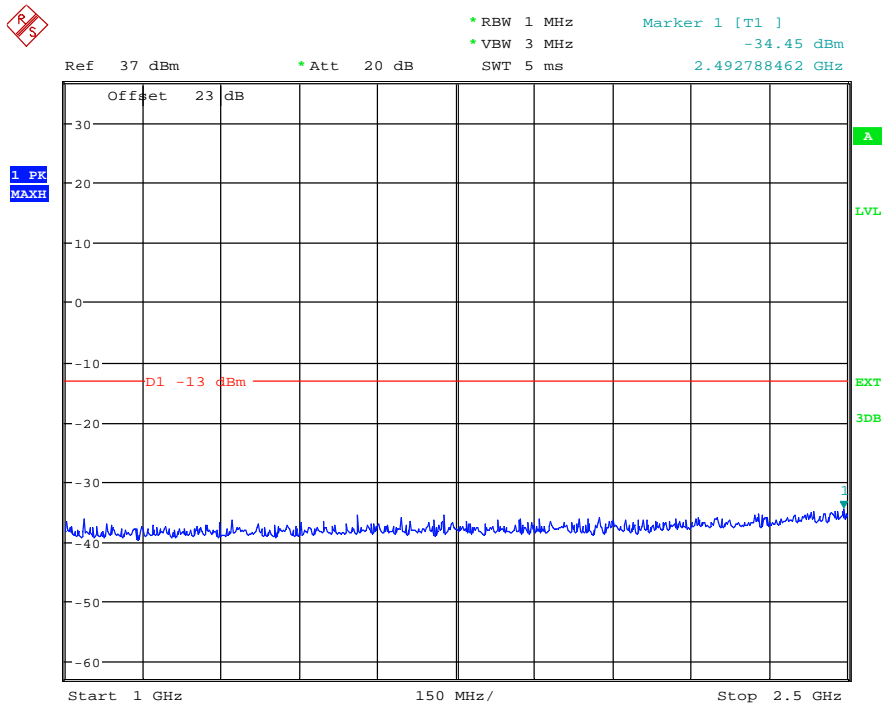

(Plot 4.6.2 C4: Channel 4233: 846.60 MHz @ WCDMA Band V)

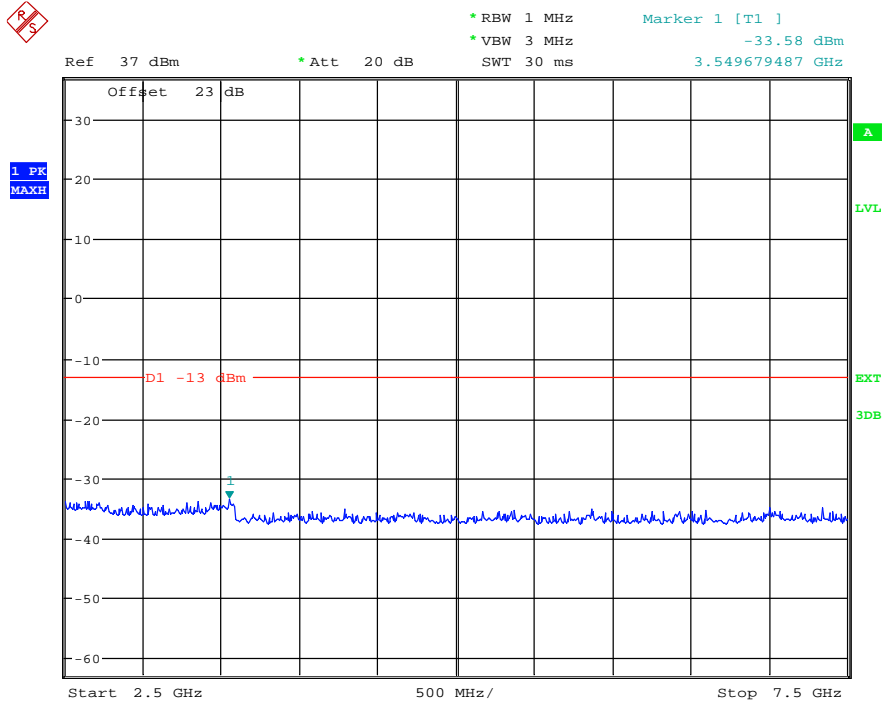

(Plot 4.6.2 C5: Channel 4233: 846.60 MHz @ WCDMA Band V)

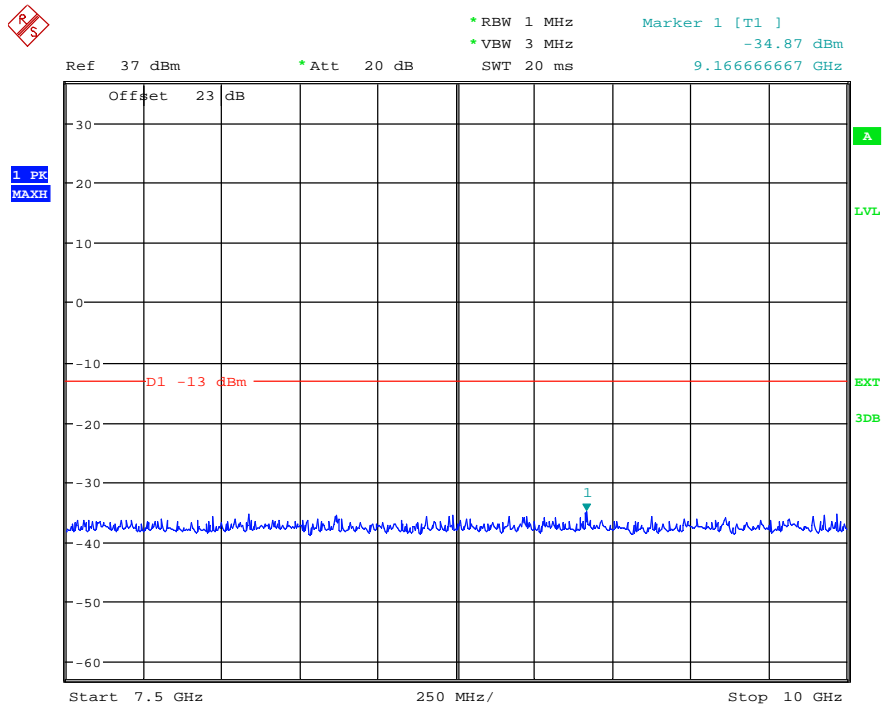

(Plot 4.6.2 C6: Channel 4233: 846.60 MHz @ WCDMA Band V)

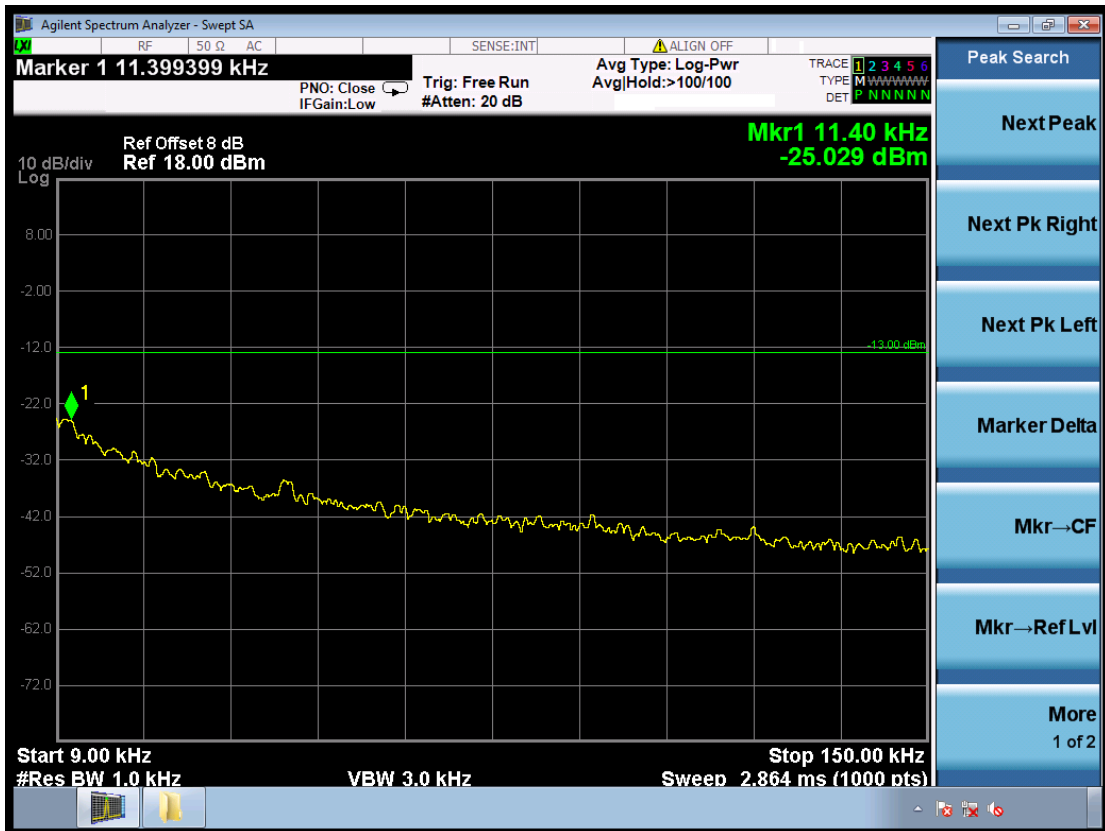

(Plot 4.6.2 D1: Idle @ WCDMA Band V)

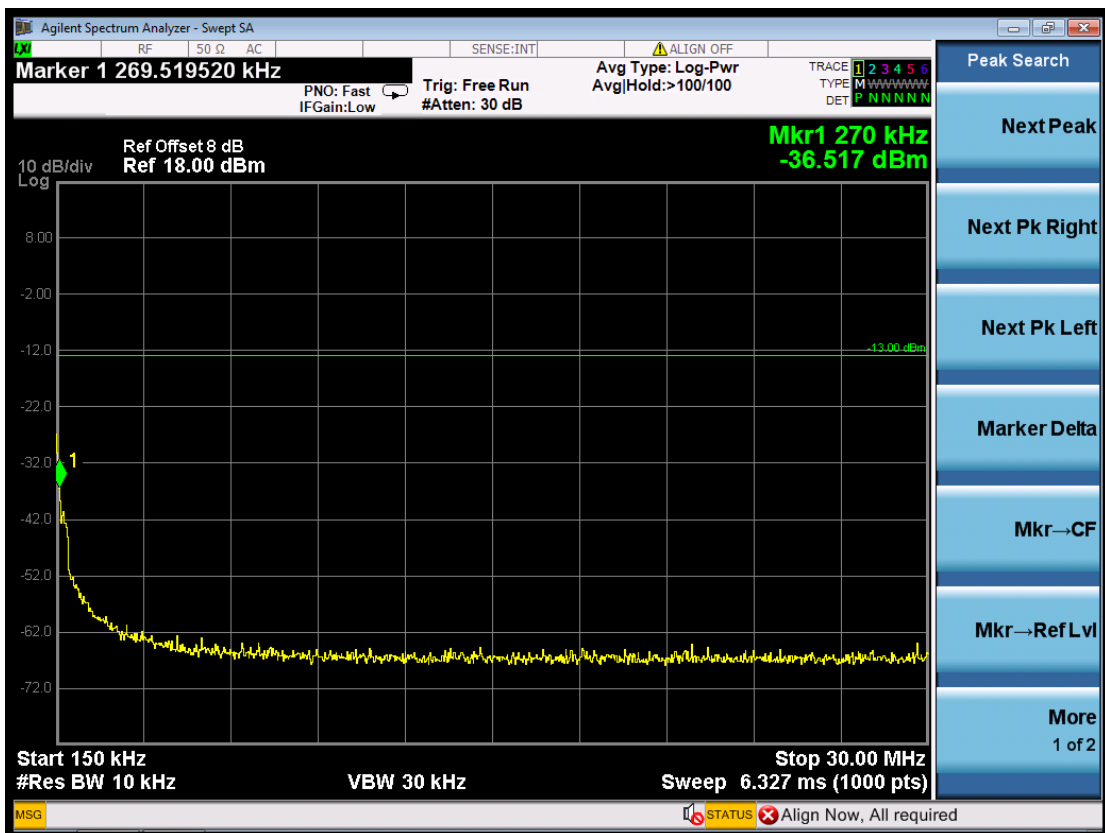

(Plot 4.6.2 D2: Idle @ WCDMA Band V)

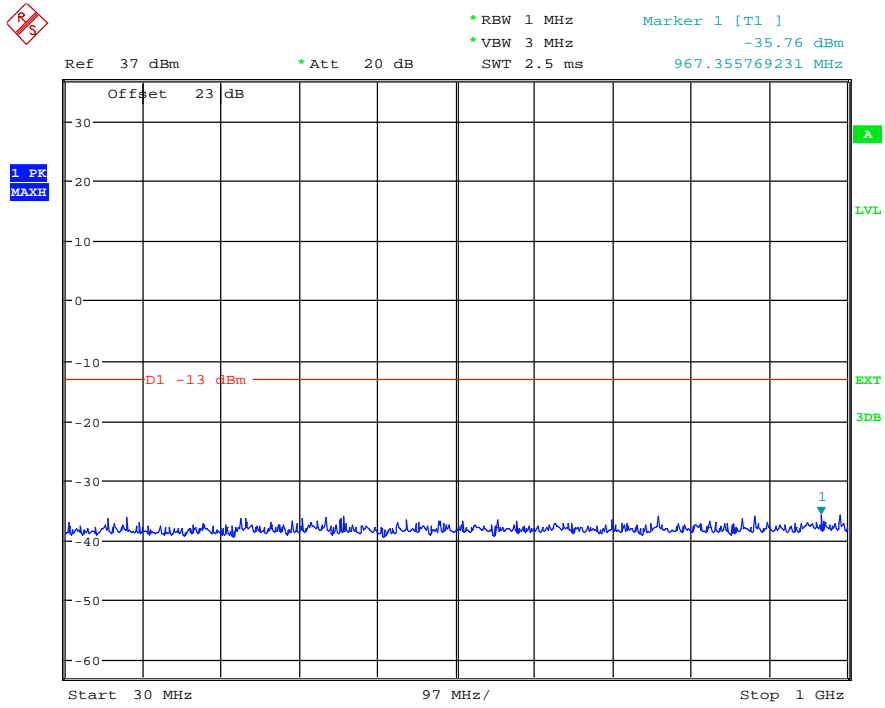

(Plot 4.6.2 D3: Idle @ WCDMA Band V)

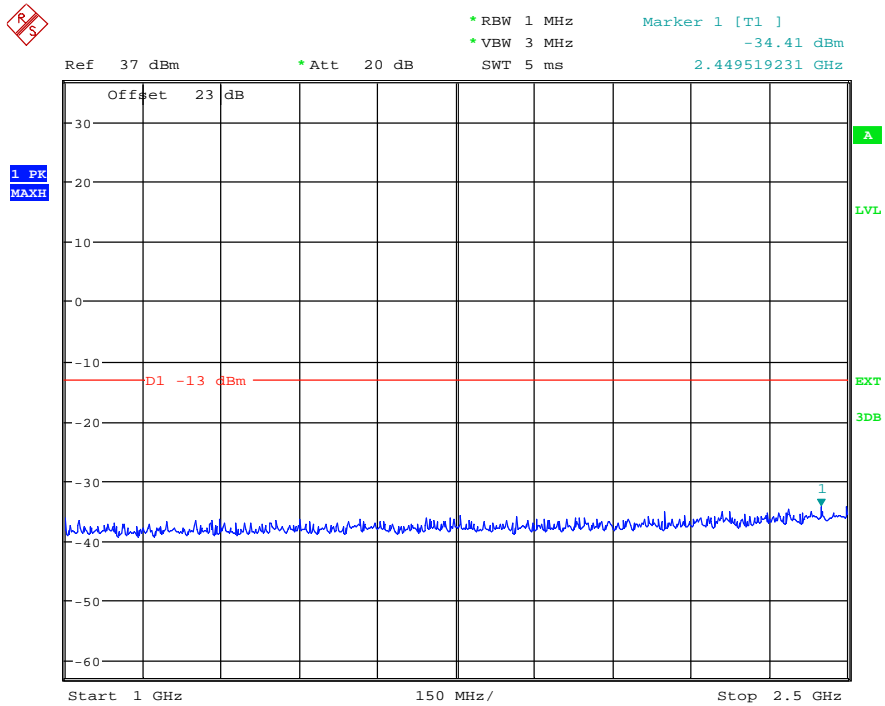

(Plot 4.6.2 D4: Idle @ WCDMA Band V)

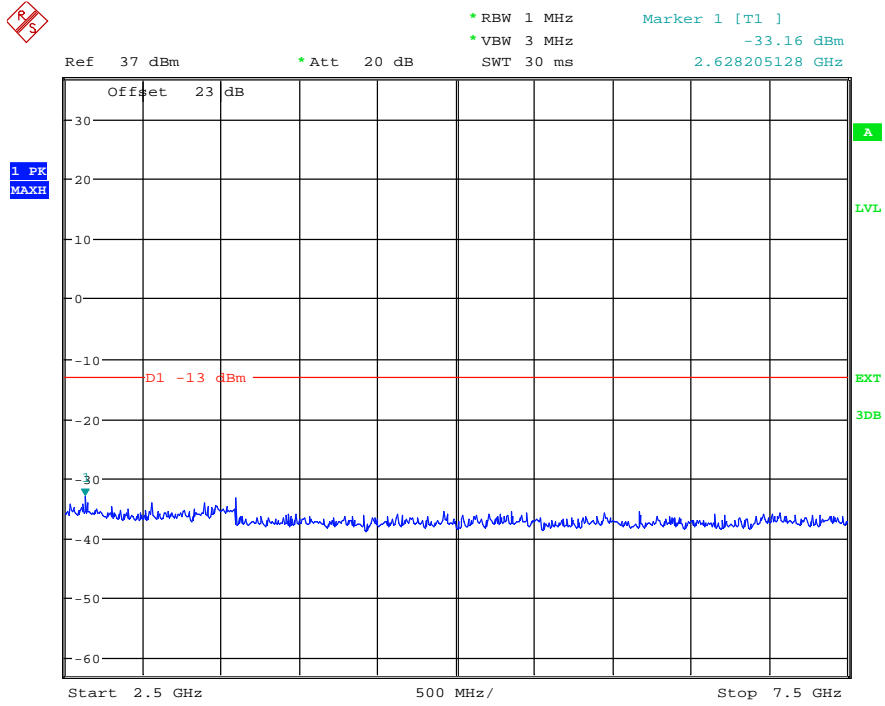

(Plot 4.6.2 D5: Idle @ WCDMA Band V)

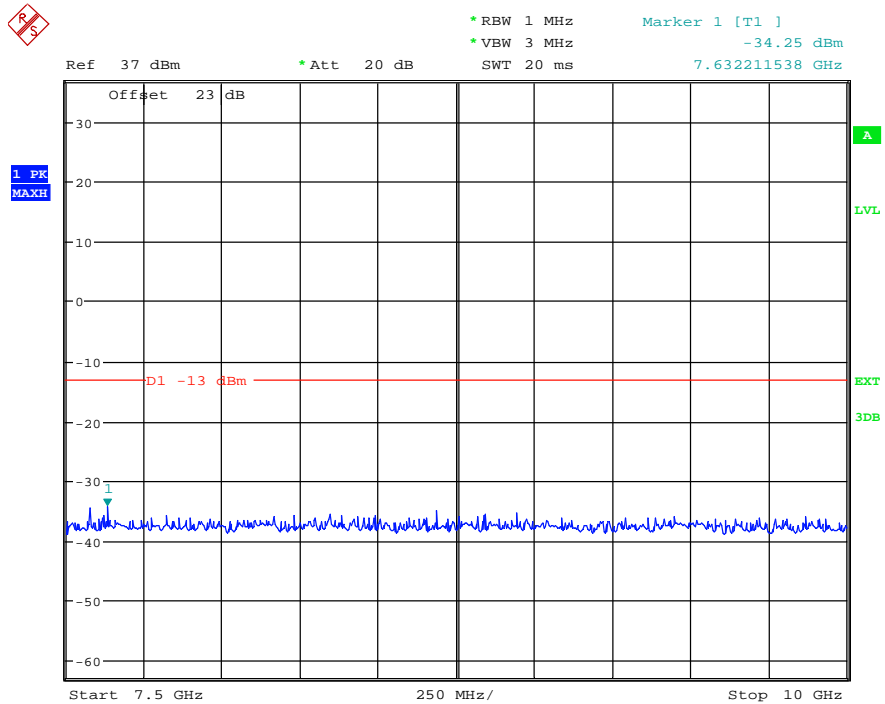

(Plot 4.6.2 D6: Idle @ WCDMA Band V)

### 4.7. Frequency Stability Test

**TEST APPLICABLE**

1. According to FCC Part 2 Section 2.1055 (a)(1), the frequency stability shall be measured with variation of ambient temperature from -30°C to +50°C centigrade.
2. According to FCC Part 2 Section 2.1055 (E) (2), for battery powered equipment, the frequency stability shall be measured with reducing primary supply voltage to the battery operating end point, which is specified by the manufacture.
3. Vary primary supply voltage from 85 to 115 percent of the nominal value for other than hand carried voltage equipment and the end voltage point was 3.40V.

**TEST PROCEDURE**

In order to measure the carrier frequency under the condition of AFC lock, it is necessary to make measurements with the EUT in a "call mode". This is accomplished with the use of R&S CMU200 DIGITAL RADIO COMMUNICATION TESTER.

1. Measure the carrier frequency at room temperature;
2. Subject the EUT to overnight soak at -30°C;
3. With the EUT, powered via nominal voltage, connected to the CMU200 and in a simulated call on middle channel of PCS 1900 and GSM850, measure the carrier frequency. These measurements should be made within 2 minutes of Powering up the EUT, to prevent significant self-warming;
4. Repeat the above measurements at 10°C increments from -30°C to +50°C. Allow at least 0.5 hours at each temperature, unpowered, before making measurements;
5. Remeasure carrier frequency at room temperature with nominal voltage. Vary supply voltage from minimum voltage to maximum voltage, in 0.1Volt increments remeasuring carrier frequency at each voltage. Pause at nominal voltage for 0.5 hours unpowered, to allow any self-heating to stabilize, before continuing;
6. Subject the EUT to overnight soak at +50°C;
7. With the EUT, powered via nominal voltage, connected to the CMU200 and in a simulated call on the centre channel, measure the carrier frequency. These measurements should be made within 2 minutes of Powering up the EUT, to prevent significant self-warming;
8. Repeat the above measurements at 10°C increments from +50°C to -30°C. Allow at least 0.5 hours at each temperature, unpowered, before making measurements;
9. At all temperature levels hold the temperature to +/- 0.5°C during the measurement procedure;

**TEST CONFIGURATION**

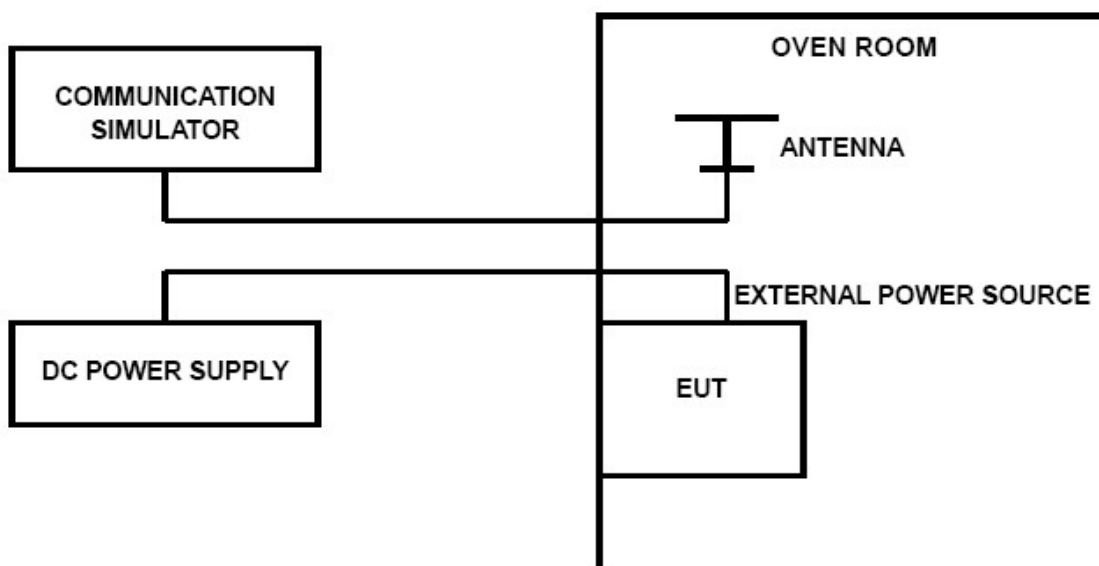

**TEST LIMITS**

***For Hand carried battery powered equipment***

According to the JTC standard the frequency stability of the carrier shall be accurate to within 0.1 ppm of the received frequency from the base station. This accuracy is sufficient to meet Sec. 24.235, Frequency Stability. The frequency stability shall be sufficient to ensure that the fundamental emission stays within the authorized frequency block. As this transceiver is considered "Hand carried, battery powered equipment" Section 2.1055(d)(2) applies. This requires that the lower voltage for frequency stability testing be specified by the

manufacturer. This transceiver is specified to operate with an input voltage of between 3.40VDC and 4.20VDC, with a nominal voltage of 3.70DC. Operation above or below these voltage limits is prohibited by transceiver software in order to prevent improper operation as well as to protect components from overstress. These voltages represent a tolerance of -10 % and +12.5 %. For the purposes of measuring frequency stability these voltage limits are to be used.

**For equipment powered by primary supply voltage**

According to the JTC standard the frequency stability of the carrier shall be accurate to within 0.1 ppm of the received frequency from the base station. This accuracy is sufficient to meet Sec. 24.235, Frequency Stability. The frequency stability shall be sufficient to ensure that the fundamental emission stays within the authorized frequency block. For this EUT section 2.1055(d)(1) applies. This requires varying primary supply voltage from 85 to 115 percent of the nominal value for other than hand carried battery equipment.

**TEST RESULTS**

UMTS/TM1/WCDMA Band II					
DC Power	Temperature (°C)	Frequency error(Hz)	Frequency error(ppm)	Limit (ppm)	Verdict
3.40	25	-10	0.01	2.50	PASS
3.70	25	-11	0.01	2.50	PASS
4.20	25	13	0.01	2.50	PASS
3.70	-30	14	0.01	2.50	PASS
3.70	-20	-15	0.01	2.50	PASS
3.70	-10	-16	0.01	2.50	PASS
3.70	0	12	0.01	2.50	PASS
3.70	10	-15	0.01	2.50	PASS
3.70	20	16	0.01	2.50	PASS
3.70	30	-14	0.01	2.50	PASS
3.70	40	-13	0.01	2.50	PASS
3.70	50	-14	0.01	2.50	PASS

UMTS/TM1/WCDMA Band V					
DC Power	Temperature (°C)	Frequency error(Hz)	Frequency error(ppm)	Limit (ppm)	Verdict
3.40	20	-8	0.01	2.50	PASS
3.70	20	5	0.01	2.50	PASS
4.20	20	6	0.01	2.50	PASS
3.70	-30	-6	0.01	2.50	PASS
3.70	-20	-7	0.01	2.50	PASS
3.70	-10	8	0.01	2.50	PASS
3.70	0	5	0.01	2.50	PASS
3.70	10	-2	0.00	2.50	PASS
3.70	20	-9	0.01	2.50	PASS
3.70	30	-4	0.00	2.50	PASS
3.70	40	-6	0.01	2.50	PASS
3.70	50	1	0.00	2.50	PASS



**5. Test Setup Photos of the EUT**

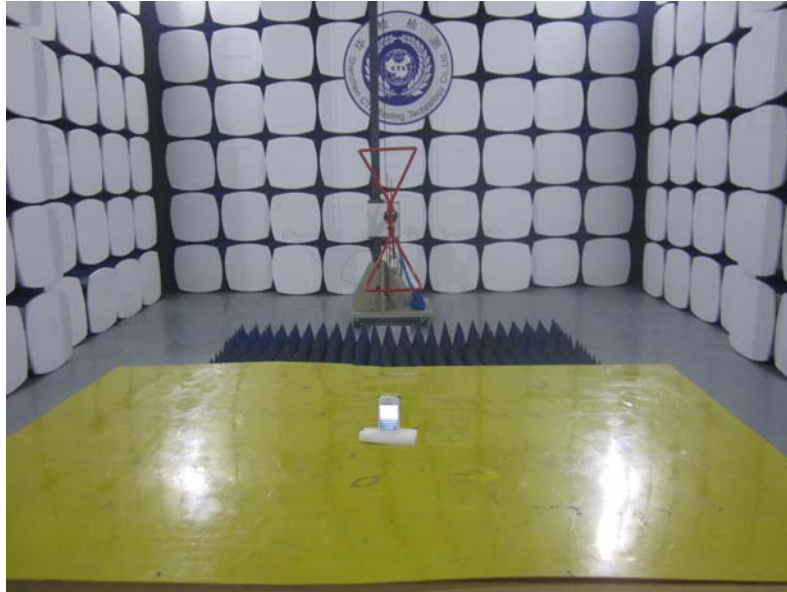

.....**End of Report**.....