

SAR EVALUATION REPORT

For

Hyundai Corporation

140-2, Kye-dong, Chongro-ku, Seoul, South Korea

FCC ID: RQQHLT-E24FSL

Report Type: Original Report	Product Type: Mobile Phone
Test Engineer: Wilson Chen	<i>Wilson Chen</i>
Report Number: RSZ150812011-20	
Report Date: 2015-09-15	
Reviewed By: SAR Engineer	<i>Bell Hu</i>
Test Laboratory:	Bay Area Compliance Laboratories Corp. (Dongguan) No.69 Pulongcun, Puxinhu Industrial Zone, Tangxia, Dongguan, Guangdong, China Tel: +86-769-86858888 Fax: +86-769-86858891 www.baclcorp.com.cn

Attestation of Test Results		
EUT Information	Company Name	Hyundai Corporation
	EUT Description	Mobile Phone
	FCC ID	RQQHLT-E24FSL
	Model Number:	Tested Model: E245S Multiple Models: E245SH
	Test Date	2015-09-09
MODE		Max. SAR Level(s) Reported(W/Kg)
GSM 850	1g Head SAR	0.856
	1g Body SAR	0.733
PCS 1900	1g Head SAR	1.11
	1g Body SAR	1.23
WCDMA 850	1g Head SAR	0.589
	1g Body SAR	0.572
WCDMA 1900	1g Head SAR	0.704
	1g Body SAR	0.504
Simultaneous	1g Head SAR	1.329
	1g Body SAR	1.303
Applicable Standards	ANSI / IEEE C95.1 : 2005 IEEE Standard for Safety Levels with Respect to Human Exposure to Radio Frequency Electromagnetic Fields,3 kHz to 300 GHz.	
	ANSI / IEEE C95.3 : 2002 IEEE Recommended Practice for Measurements and Computations of Radio Frequency Electromagnetic Fields With Respect to Human Exposure to Such Fields,100 kHz—300 GHz.	
	IEC 62209-1:2006 Human exposure to radio frequency fields from hand-held and body-mounted wireless communication devices – Human models, instrumentation, and procedures – Part 1: Procedure to determine the specific absorption rate (SAR) for hand-held devices used in close proximity to the ear (frequency range of 300 MHz to 3GHz)	
	IEC 62209-2:2010 Human exposure to radio frequency fields from hand-held and body-mounted wireless communication devices-Human models, instrumentation, and procedures-Part 2: Procedure to determine the specific absorption rate (SAR) for wireless communication devices used in close proximity to the human body (frequency range of 30 MHz to 6 GHz)	
	FCC 47 CFR part 2.1093 Radiofrequency radiation exposure evaluation: portable devices	
	IEEE1528:2013 IEEE Recommended Practice for Determining the Peak Spatial-Average Specific Absorption Rate (SAR) in the Human Head from Wireless Communications Devices: Measurement Techniques	
	KDB procedures KDB 447498 D01 General RF Exposure Guidance v05r02. KDB 648474 D04 Handset SAR v01r02. KDB 865664 D01 SAR measurement 100 MHz to 6 GHz v01r03 KDB 865664 D02 RF Exposure Reporting v01r01 KDB 941225 D01 3G SAR Procedures v03	
<p>Note: This wireless device has been shown to be capable of compliance for localized specific absorption rate (SAR) for General Population/Uncontrolled Exposure limits specified in ANSI/IEEE Standards and has been tested in accordance with the measurement procedures specified in IEEE 1528-2013 and RF exposure KDB procedures.</p> <p>The results and statements contained in this report pertain only to the device(s) evaluated.</p>		

TABLE OF CONTENTS

DOCUMENT REVISION HISTORY	5
EUT DESCRIPTION	6
TECHNICAL SPECIFICATION	6
REFERENCE, STANDARDS, AND GUIDELINES	7
SAR LIMITS	8
FACILITIES.....	9
DESCRIPTION OF TEST SYSTEM	10
EQUIPMENT LIST AND CALIBRATION	15
EQUIPMENTS LIST & CALIBRATION INFORMATION	15
SAR MEASUREMENT SYSTEM VERIFICATION	16
LIQUID VERIFICATION	16
SYSTEM ACCURACY VERIFICATION	19
SAR SYSTEM VALIDATION DATA	20
EUT TEST STRATEGY AND METHODOLOGY	24
TEST POSITIONS FOR DEVICE OPERATING NEXT TO A PERSON’S EAR.....	24
CHEEK/TOUCH POSITION	25
EAR/TILT POSITION	25
TEST POSITIONS FOR BODY-WORN AND OTHER CONFIGURATIONS	26
SAR EVALUATION PROCEDURE.....	27
TEST METHODOLOGY	27
CONDUCTED OUTPUT POWER MEASUREMENT	28
PROVISION APPLICABLE	28
TEST PROCEDURE	28
RADIO CONFIGURATION	28
MAXIMUM OUTPUT POWER AMONG PRODUCTION UNITS	32
TEST RESULTS:	33
SAR MEASUREMENT RESULTS.....	37
SAR TEST DATA.....	37
SAR SIMULTANEOUS TRANSMISSION DESCRIPTION	40
SAR PLOTS (SUMMARY OF THE HIGHEST SAR VALUES).....	43
APPENDIX A MEASUREMENT UNCERTAINTY	51
APPENDIX B – PROBE CALIBRATION CERTIFICATES.....	53
APPENDIX C DIPOLE CALIBRATION CERTIFICATES	64
APPENDIX D EUT TEST POSITION PHOTOS	82
LIQUID DEPTH \geq 15CM.....	82
LEFT HEAD CHEEK	82
LEFT HEAD TILT	83
RIGHT HEAD CHEEK	83
RIGHT HEAD TILT.....	84
BODY -WORN-BACK (15MM).....	84
APPENDIX E EUT PHOTOS.....	85
EUT – FRONT VIEW.....	85
EUT – BACK VIEW	85
EUT –LEFT SIDE VIEW	86
EUT – RIGHT SIDE VIEW	86

EUT – TOP VIEW87
EUT – BOTTOM VIEW.....87
EUT – UNCOVER VIEW.....88
PRODUCT SIMILARITY DECLARATION LETTER.....89

F I N A L

DOCUMENT REVISION HISTORY

Revision Number	Report Number	Description of Revision	Date of Revision
0	RSZ150812011-20	Original Report	2015-09-15

FINAL

EUT DESCRIPTION

This report has been prepared on behalf of Hyundai Corporation and their product, FCC ID: RQQHLLT-E24FSL, Model: E245S or the EUT (Equipment under Test) as referred to in the rest of this report.

*Note:

1. This series products model: E245S and E245SH, we select model: E245S to test, there is no electrical change has been made to the equipment, please refer to the product similarity letter.

Technical Specification

Product Type	Mobile Phone
Exposure Category:	Population / Uncontrolled
Antenna Type(s):	Internal Antenna
Body-Worn Accessories:	Portable
Face-Head Accessories:	None
Multi-slot Class:	Class12
Operation Mode :	GSM Voice, GPRS/EGPRS Data, WCDMA (Rel99, HSUPA, HSDPA) and Bluetooth
Frequency Band:	GSM 850 : 824-849 MHz(TX) ; 869-894 MHz(RX) PCS 1900: 1850-1910 MHz(TX) ; 1930-1990 MHz(RX) WCDMA850: 824-849 MHz(TX) ; 869-894 MHz(RX) WCDMA1900: 1850-1910 MHz(TX) ; 1930-1990 MHz(RX) Bluetooth3.0 : 2402MHz-2480MHz
Conducted RF Power:	GSM 850 : 32.63 dBm PCS 1900: 29.58 dBm WCDMA 850: 22.12 dBm WCDMA 1900: 22.13 dBm Bluetooth: 7.14dBm
Dimensions (L*W*H):	112mm (L) × 46 mm (W) × 13 mm (H)
Power Source:	3.8 VDC Rechargeable Battery
Normal Operation:	Head and Body-worn

REFERENCE, STANDARDS, AND GUIDELINES

FCC:

The Report and Order requires routine SAR evaluation prior to equipment authorization of portable transmitter devices, including portable telephones. For consumer products, the applicable limit is 1.6 mW/g as recommended by the ANSI/IEEE standard C95.1-1992 [6] for an uncontrolled environment (Paragraph 65). According to the Supplement C of OET Bulletin 65 "Evaluating Compliance with FCC Guide-lines for Human Exposure to Radio frequency Electromagnetic Fields", released on Jun 29, 2001 by the FCC, the device should be evaluated at maximum output power (radiated from the antenna) under "worst-case" conditions for normal or intended use, incorporating normal antenna operating positions, device peak performance frequencies and positions for maximum RF energy coupling.

This report describes the methodology and results of experiments performed on wireless data terminal. The objective was to determine if there is RF radiation and if radiation is found, what is the extent of radiation with respect to safety limits. SAR (Specific Absorption Rate) is the measure of RF exposure determined by the amount of RF energy absorbed by human body (or its parts) – to determine how the RF energy couples to the body or head which is a primary health concern for body worn devices. The limit below which the exposure to RF is considered safe by regulatory bodies in North America is 1.6 mW/g average over 1 gram of tissue mass.

CE:

The order requires routine SAR evaluation prior to equipment authorization of portable transmitter devices, including portable telephones. For consumer products, the applicable limit is 2 mW/g as recommended by EN62209-1 for an uncontrolled environment. According to the Standard, the device should be evaluated at maximum output power (radiated from the antenna) under "worst-case" conditions for normal or intended use, incorporating normal antenna operating positions, device peak performance frequencies and positions for maximum RF energy coupling.

This report describes the methodology and results of experiments performed on wireless data terminal. The objective was to determine if there is RF radiation and if radiation is found, what is the extent of radiation with respect to safety limits. SAR (Specific Absorption Rate) is the measure of RF exposure determined by the amount of RF energy absorbed by human body (or its parts) – to determine how the RF energy couples to the body or head which is a primary health concern for body worn devices. The limit below which the exposure to RF is considered safe by regulatory bodies in Europe is 2 mW/g average over 10 gram of tissue mass.

The test configurations were laid out on a specially designed test fixture to ensure the reproducibility of measurements. Each configuration was scanned for SAR. Analysis of each scan was carried out to characterize the above effects in the device.

SAR Limits

FCC Limit (1g Tissue)

EXPOSURE LIMITS	SAR (W/kg)	
	(General Population / Uncontrolled Exposure Environment)	(Occupational / Controlled Exposure Environment)
Spatial Average (averaged over the whole body)	0.08	0.4
Spatial Peak (averaged over any 1 g of tissue)	1.60	8.0
Spatial Peak (hands/wrists/feet/ankles averaged over 10 g)	4.0	20.0

CE Limit (10g Tissue)

EXPOSURE LIMITS	SAR (W/kg)	
	(General Population / Uncontrolled Exposure Environment)	(Occupational / Controlled Exposure Environment)
Spatial Average (averaged over the whole body)	0.08	0.4
Spatial Peak (averaged over any 10 g of tissue)	2.0	10
Spatial Peak (hands/wrists/feet/ankles averaged over 10 g)	4.0	20.0

Population/Uncontrolled Environments are defined as locations where there is the exposure of individual who have no knowledge or control of their exposure.

Occupational/Controlled Environments are defined as locations where there is exposure that may be incurred by people who are aware of the potential for exposure (i.e. as a result of employment or occupation).

General Population/Uncontrolled environments Spatial Peak limit 1.6W/kg (FCC) & 2 W/kg (CE) applied to the EUT.

FACILITIES

The Test site used by Bay Area Compliance Laboratories Corp. (Dongguan) to collect test data is located on the No.69 Pulongcun, Puxinhu Industrial Zone, Tangxia, Dongguan, Guangdong, China

F I N A L

DESCRIPTION OF TEST SYSTEM

These measurements were performed with the automated near-field scanning system DASY5 from Schmid & Partner Engineering AG (SPEAG) which is the Fifth generation of the system shown in the figure hereinafter:



DASY5 System Description

The DASY5 system for performing compliance tests consists of the following items:

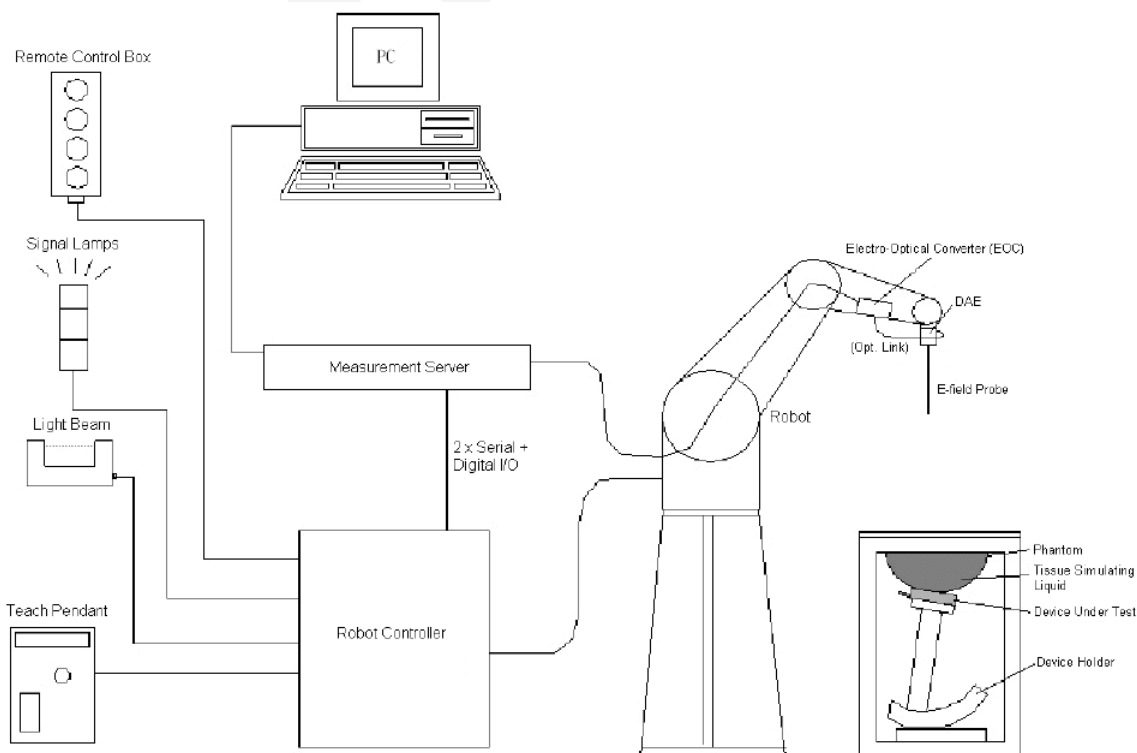

- A standard high precision 6-axis robot (Staubli TX=RX family) with controller, teach pendant and software. An arm extension for accommodating the data acquisition electronics (DAE).
- An isotropic field probe optimized and calibrated for the targeted measurement.
- A data acquisition electronics (DAE) which performs the signal amplification, signal multiplexing, AD-conversion, offset measurements, mechanical surface detection, collision detection, etc. The unit is battery powered with standard or rechargeable batteries. The signal is optically transmitted to the EOC.
- The Electro-optical converter (EOC) performs the conversion from optical to electrical signals for the digital communication to the DAE. To use optical surface detection, a special version of the EOC is required. The EOC signal is transmitted to the measurement server.
- The function of the measurement server is to perform the time critical tasks such as signal filtering, control of the robot operation and fast movement interrupts.
- The Light Beam used is for probe alignment. This improves the (absolute) accuracy of the probe positioning.
- A computer running Win7 professional operating system and the DASY52 software.
- Remote control and teach pendant as well as additional circuitry for robot safety such as warning lamps, etc.
- The phantom, the device holder and other accessories according to the targeted measurement.

DASY5 Measurement Server

The DASY5 measurement server is based on a PC/104 CPU board with a 400MHz intel ULV Celeron, 128MB chip-disk and 128MB RAM. The necessary circuits for communication with the DAE4 (or DAE3) electronics box, as well as the 16 bit AD converter system for optical detection and digital I/O interface are contained on the DASY5 I/O board, which is directly connected to the PC/104 bus of the CPU board.



The measurement server performs all real-time data evaluation of field measurements and surface detection, controls robot movements and handles safety operation. The PC operating system cannot interfere with these time critical processes. All connections are supervised by a watchdog, and disconnection of any of the cables to the measurement server will automatically disarm the robot and disable all program-controlled robot movements. Furthermore, the measurement server is equipped with an expansion port which is reserved for future applications. Please note that this expansion port does not have a standardized point out, and therefore only devices provided by SPEAG can be connected. Devices from any other supplier could seriously damage the measurement server.

Data Acquisition Electronics

The data acquisition electronics (DAE4) consist of a highly sensitive electrometer-grade preamplifier with auto-zeroing, a channel and gain-switching multiplexer, a fast 16 bit AD-converter and a command decoder with a control logic unit. Transmission to the measurement server is accomplished through an optical downlink for data and status information, as well as an optical uplink for commands and the clock.

The mechanical probe mounting device includes two different sensor systems for frontal and sideways probe contacts. They are used for mechanical surface detection and probe collision detection.

The input impedance of both the DAE4 as well as of the DAE3 box is 200MOhm; the inputs are symmetrical and floating. Common mode rejection is above 80 dB.

EX3DV4 E-Field Probes

Frequency	10 MHz to > 6 GHz Linearity: ± 0.2 dB (30 MHz to 6 GHz)
Directivity	± 0.3 dB in TSL (rotation around probe axis) ± 0.5 dB in TSL (rotation normal to probe axis)
Dynamic Range	10 µW/g to > 100 mW/g Linearity: ± 0.2 dB (noise: typically < 1 µW/g)
Dimensions	Overall length: 337 mm (Tip: 20 mm) Tip diameter: 2.5 mm (Body: 12 mm) Typical distance from probe tip to dipole centers: 1 mm
Application	High precision dosimetric measurements in any exposure scenario (e.g., very strong gradient fields); the only probe that enables compliance testing for frequencies up to 6 GHz with precision of better 30%.
Compatibility	DASY3, DASY4, DASY52 SAR and higher, EASY4/MRI

SAM Twin Phantom

The SAM twin phantom is a fiberglass shell phantom with 2mm shell thickness (except the ear region, where shell thickness increases to 6 mm). The phantom has three measurement areas:

- _ Left hand
- _ Right hand
- _ Flat phantom

The phantom table for the DASY systems based on the TX90XL and RX160L robots have the size of 100 x 50 x 85 cm (L xWx H).

The phantom table for the compact DASY systems based on the RX60L robot have the size of 100 x 75 x 91 cm (L xWx H); these tables are reinforced for mounting of the robot onto the table.

For easy dislocation these tables have fork lift cut outs at the bottom.

The bottom plate contains three pairs of bolts for locking the device holder. The device holder positions are adjusted to the standard measurement positions in the three sections. Only one device holder is necessary if two phantoms are used (e.g., for different liquids)

A white cover is provided to cover the phantom during o_-periods to prevent water evaporation and changes in the liquid parameters. Free space scans of devices on top of this phantom cover are possible.

Three reference marks are provided on the phantom counter. These reference marks are used to teach the absolute phantom position relative to the robot.



Device Holder for SAM Twin Phantom

The SAR in the phantom is approximately inversely proportional to the square of the distance between the source and the liquid surface. For a source in 5mm distance, a positioning uncertainty of ± 0.5 mm would produce a SAR uncertainty of $\pm 20\%$. An accurate device positioning is therefore crucial for accurate and repeatable measurements. The positions, in which the devices must be measured, are defined by the standards.

The DASY device holder is designed to cope with different positions given in the standard. It has two scales for the device rotation (with respect to the body axis) and the device inclination (with respect to the line between the ear reference points). The rotation centers for both scales are the ear reference point (ERP). Thus the device needs no repositioning when changing the angles.



The DASY device holder has been made out of low-loss POM material having the following dielectric parameters: relative permittivity $\epsilon_r=3$ and loss tangent $\tan \delta=0.02$. The amount of dielectric material has been reduced in the closest vicinity of the device, since measurements have suggested that the influence of the clamp on the test results could thus be lowered.

Robots

The DASY5 system uses the high precision industrial robots TX90XL from Staubli SA (France). The TX robot family is the successor of the well known RX robot family and offers the same features important for our application:

- High precision (repeatability 0.02mm)
- High reliability (industrial design)
- Low maintenance costs (virtually maintenance free due to direct drive gears; no belt drives)
- Jerk-free straight movements (brushless synchron motors; no stepper motors)
- Low ELF interference (motor control fields shielded via the closed metallic construction shields)

The above mentioned robots are controlled by the Staubli CS8c robot controllers. All information regarding the use and maintenance of the robot arm and the robot controller is contained on the CDs delivered along with the robot. Paper manuals are available upon request direct from Staubli.

Area Scans

Area scans are defined prior to the measurement process being executed with a user defined variable spacing between each measurement point (integral) allowing low uncertainty measurements to be conducted. Scans defined for FCC applications utilize a 10mm² step integral, with 1mm interpolation used to locate the peak SAR area used for zoom scan assessments.

Where the system identifies multiple SAR peaks (which are within 25% of peak value) the system will provide the user with the option of assessing each peak location individually for zoom scan averaging.

Zoom Scan (Cube Scan Averaging)

The averaging zoom scan volume utilized in the DASY5 software is in the shape of a cube and the side dimension of a 1 g or 10 g mass is dependent on the density of the liquid representing the simulated tissue. A density of 1000 kg/m³ is used to represent the head and body tissue density and not the phantom liquid density, in order to be consistent with the definition of the liquid dielectric properties, i.e. the side length of the 1 g cube is 10mm, with the side length of the 10 g cube 21,5mm.

When the cube intersects with the surface of the phantom, it is oriented so that 3 vertices touch the surface of the shell or the center of a face is tangent to the surface. The face of the cube closest to the surface is modified in order to conform to the tangent surface.

The zoom scan integer steps can be user defined so as to reduce uncertainty, but normal practice for typical test applications (including FCC) utilize a physical step of 5x5x8 (8mmx8mmx5mm) providing a volume of 32mm³ in the X & Y axis, and 35mm in the Z axis.

EQUIPMENT LIST AND CALIBRATION

Equipments List & Calibration Information

Equipment	Model	S/N	Calibration Date	Calibration Due Date
Robot	RX90	D03636	N/A	N/A
DASY5 Test Software	DASY52.8	N/A	N/A	N/A
DASY5 Measurement Server	DASY5 4.5.12	1470	N/A	N/A
Data Acquisition Electronics	DAE4	1459	2015-01-26	2016-01-26
E-Field Probe	EX3DV4	7329	2015-02-05	2016-02-05
Dipole, 835MHz	ALS-D-835-S-2	180-00558	2014-10-08	2017-10-08
Dipole,1900MHz	ALS-D-1900-S-2	210-00710	2013-10-09	2016-10-09
R&S, universal Radio Communication Tester	CMU200	105047	2014-11-20	2015-11-20
Mounting Device	MD4HHTV5	SD 000 H01 KA	N/A	N/A
Twin SAM	Twin SAM V5.0	1874	N/A	N/A
Simulated Tissue 835 MHz Head	TS-835-H	201504	Each Time	/
Simulated Tissue 835 MHz Body	TS-835-B	201505	Each Time	/
Simulated Tissue 1900 MHz Head	TS-1900-H	201506	Each Time	/
Simulated Tissue 1900 MHz Body	TS-1900-B	201507	Each Time	/
Network Analyzer	8752C	3140A02356	2015-06-03	2016-06-03
Dielectric probe kit	85070B	US33020324	2015-06-13	2016-06-13
Signal Generator	E4422B	MY41000355	2014-10-27	2015-10-27
Power Meter	EPM-441A	GB37481494	2014-11-03	2015-11-03
Power Meter Sensor	8481A	T-03-EM-127	2014-11-03	2015-11-03
Power Amplifier	5205PE	1015	N/A	N/A
Directional Coupler	488Z	N/A	N/A	N/A
attenuator	20dB, 100W	N/A	N/A	N/A

SAR MEASUREMENT SYSTEM VERIFICATION

Liquid Verification

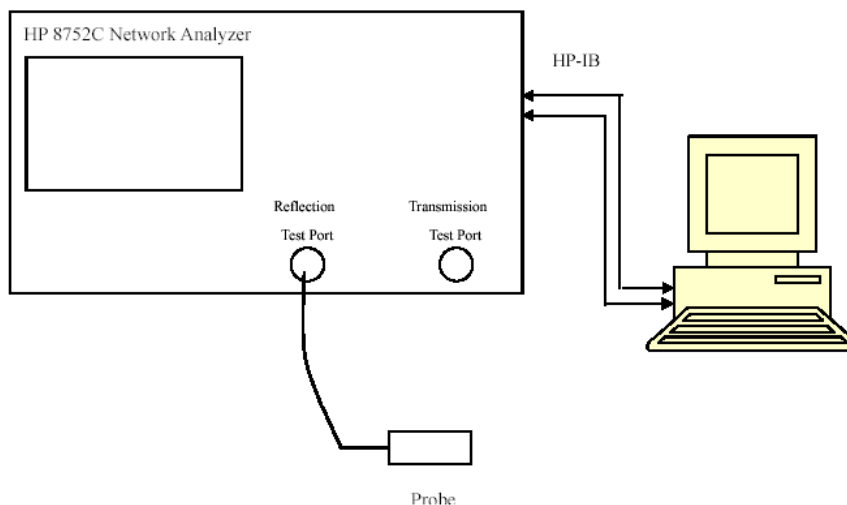

Liquid Verification Setup Block Diagram

Liquid Verification Results

Frequency	Liquid Type	Liquid Parameter		Target Value		Delta (%)		Tolerance (%)
		ϵ_r	σ (S/m)	ϵ_r	σ (S/m)	$\Delta\epsilon_r$	$\Delta\sigma$ (S/m)	
824.2	Head	41.00	0.91	41.50	0.90	-1.205	1.111	±5
	Body	53.86	0.95	55.20	0.97	-2.428	-2.062	±5
826.4	Head	41.06	0.91	41.50	0.90	-1.060	1.111	±5
	Body	53.82	0.95	55.20	0.97	-2.500	-2.062	±5
836.6	Head	41.02	0.92	41.50	0.90	-1.157	2.222	±5
	Body	53.79	0.96	55.20	0.97	-2.554	-1.031	±5
846.6	Head	41.05	0.91	41.50	0.90	-1.084	1.111	±5
	Body	53.79	0.97	55.20	0.97	-2.554	0.000	±5
848.8	Head	41.07	0.91	41.50	0.90	-1.036	1.111	±5
	Body	53.85	0.98	55.20	0.97	-2.446	1.031	±5
1850.2	Head	39.74	1.37	40.00	1.40	-0.650	-2.143	±5
	Body	52.05	1.5	53.30	1.52	-2.345	-1.316	±5
1852.4	Head	39.65	1.37	40.00	1.40	-0.875	-2.143	±5
	Body	51.82	1.5	53.30	1.52	-2.777	-1.316	±5
1880.0	Head	39.64	1.4	40.00	1.40	-0.900	0.000	±5
	Body	52.05	1.51	53.30	1.52	-2.345	-0.658	±5
1907.6	Head	39.62	1.42	40.00	1.40	-0.950	1.429	±5
	Body	52.02	1.54	53.30	1.52	-2.402	1.316	±5
1909.8	Head	39.63	1.42	40.00	1.40	-0.925	1.429	±5
	Body	51.81	1.55	53.30	1.52	-2.795	1.974	±5

*Liquid Verification was performed on 2015-09-09.

Please refer to the following tables.

835 MHz Head			835 MHz Body		
Frequency (MHz)	e'	e''	Frequency (MHz)	e'	e''
824.0	41.0002	19.7704	824.0	53.8584	20.6388
824.5	41.0514	19.7094	824.5	53.8095	20.6839
825.0	41.0007	19.6746	825.0	53.8246	20.6245
825.5	41.0897	19.6957	825.5	53.8301	20.6500
826.0	41.0016	19.7673	826.0	53.7902	20.6658
826.5	41.0561	19.7081	826.5	53.8236	20.6234
827.0	41.0962	19.7297	827.0	53.7735	20.6619
827.5	41.0471	19.7101	827.5	53.7791	20.6303
828.0	41.0530	19.7246	828.0	53.8300	20.6997
828.5	41.0323	19.6735	828.5	53.8554	20.6391
829.0	41.0163	19.6922	829.0	53.8055	20.6639
829.5	41.0494	19.7387	829.5	53.8539	20.6847
830.0	41.0810	19.7089	830.0	53.8341	20.6331
830.5	41.0486	19.7091	830.5	53.8397	20.6558
831.0	41.0605	19.6880	831.0	53.8386	20.6629
831.5	41.0462	19.6645	831.5	53.8351	20.6868
832.0	41.0866	19.6976	832.0	53.7729	20.6181
832.5	41.0713	19.7542	832.5	53.8473	20.6607
833.0	41.0067	19.6974	833.0	53.8165	20.6822
833.5	41.0969	19.7374	833.5	53.7881	20.6649
834.0	41.0303	19.7396	834.0	53.7874	20.6781
834.5	41.0132	19.6820	834.5	53.8214	20.6417
835.0	41.0596	19.6829	835.0	53.8681	20.6536
835.5	41.0163	19.7346	835.5	53.7882	20.6459
836.0	41.0420	19.6883	836.0	53.8386	20.6806
836.5	41.0113	19.6983	836.5	53.8363	20.6399
837.0	41.0310	19.6627	837.0	53.8073	20.6440
837.5	41.0464	19.6724	837.5	53.8384	20.6973
838.0	41.0776	19.6664	838.0	53.7998	20.6987
838.5	41.0625	19.6840	838.5	53.8465	20.6368
839.0	41.0674	19.7366	839.0	53.8698	20.6957
839.5	40.9970	19.6736	839.5	53.7772	20.6628
840.0	41.0452	19.4678	840.0	53.7699	20.6696
840.5	41.1019	19.4507	840.5	53.8259	20.6821
841.0	41.0302	19.4440	841.0	53.7807	20.6508
841.5	41.1025	19.4507	841.5	53.8499	20.6474
842.0	41.0160	19.4404	842.0	53.7813	20.6181
842.5	41.0118	19.4151	842.5	53.8443	20.7092
843.0	41.0015	19.4555	843.0	53.8285	20.6553
843.5	41.0689	19.3802	843.5	53.8149	20.6301
844.0	41.0709	19.3990	844.0	53.7928	20.6248
844.5	41.0486	19.4211	844.5	53.8286	20.7000
845.0	41.1027	19.4667	845.0	53.8122	20.6928
845.5	41.0523	19.4321	845.5	53.7680	20.6797
846.0	41.0485	19.3690	846.0	53.8119	20.6705
846.5	41.0534	19.3746	846.5	53.7851	20.6462
847.0	41.0574	19.3914	847.0	53.8182	20.6248
847.5	41.0187	19.3955	847.5	53.7872	20.6876
848.0	41.0166	19.4061	848.0	53.7956	20.6951
848.5	41.0085	19.4482	848.5	53.7928	20.6447
849.0	41.0702	19.3785	849.0	53.8490	20.6670

1900 MHz Head			1900 MHz Body		
Frequency (MHz)	e'	e''	Frequency (MHz)	e'	e''
1850.0	39.7376	13.3526	1850.0	52.0530	14.5511
1851.2	39.7235	13.3141	1851.2	52.0283	14.4312
1852.4	39.6525	13.2752	1852.4	51.8236	14.5587
1853.6	39.7414	13.3786	1853.6	51.9114	14.4687
1854.8	39.5942	13.4062	1854.8	51.9102	14.5685
1856.0	39.6541	13.4014	1856.0	51.7878	14.4212
1857.2	39.5908	13.2700	1857.2	51.9262	14.5538
1858.4	39.7361	13.2563	1858.4	51.9125	14.4176
1859.6	39.6016	13.3939	1859.6	51.8911	14.5167
1860.8	39.5657	13.3624	1860.8	51.7700	14.5392
1862.0	39.6755	13.3716	1862.0	51.7979	14.4149
1863.2	39.6636	13.3687	1863.2	51.8154	14.5522
1864.4	39.7092	13.2438	1864.4	51.9558	14.4325
1865.6	39.6382	13.3155	1865.6	52.0197	14.5203
1866.8	39.5955	13.2438	1866.8	51.8277	14.5601
1868.0	39.6263	13.3530	1868.0	51.9270	14.4169
1869.2	39.6175	13.2822	1869.2	51.8452	14.5174
1870.4	39.5684	13.2776	1870.4	51.8023	14.5253
1871.6	39.5678	13.3327	1871.6	51.8095	14.5226
1872.8	39.5934	13.3946	1872.8	51.7852	14.4428
1874.0	39.6517	13.2949	1874.0	52.0166	14.5399
1875.2	39.6988	13.2453	1875.2	52.0538	14.4173
1876.4	39.6201	13.3919	1876.4	51.9707	14.4201
1877.6	39.6747	13.3000	1877.6	51.9350	14.4782
1878.8	39.6776	13.3783	1878.8	51.8323	14.4928
1880.0	39.6415	13.4176	1880.0	52.0461	14.4791
1881.2	39.7062	13.4237	1881.2	52.0486	14.5121
1882.4	39.6577	13.3370	1882.4	51.8635	14.5748
1883.6	39.5700	13.3450	1883.6	51.8140	14.5702
1884.8	39.7069	13.3407	1884.8	51.9261	14.5694
1886.0	39.7382	13.4064	1886.0	52.0936	14.4175
1887.2	39.6670	13.2540	1887.2	51.8019	14.4288
1888.4	39.5669	13.2433	1888.4	51.9927	14.4167
1889.6	39.6369	13.4299	1889.6	51.8429	14.5098
1890.8	39.6120	13.2627	1890.8	51.9274	14.4147
1892.0	39.5927	13.3768	1892.0	51.9020	14.5161
1893.2	39.7059	13.2402	1893.2	52.0141	14.4554
1894.4	39.7103	13.4157	1894.4	51.9519	14.4743
1895.6	39.7190	13.2952	1895.6	51.7390	14.5084
1896.8	39.6814	13.3487	1896.8	51.9698	14.5646
1898.0	39.6078	13.3760	1898.0	51.8860	14.5339
1899.2	39.7263	13.2982	1899.2	51.8585	14.4188
1900.4	39.6616	13.3252	1900.4	51.7742	14.5136
1901.6	39.7232	13.3864	1901.6	52.0209	14.5055
1902.8	39.6238	13.2975	1902.8	51.7405	14.4129
1904.0	39.6023	13.3328	1904.0	51.8705	14.5163
1905.2	39.6106	13.3461	1905.2	51.9229	14.5217
1906.4	39.6443	13.3766	1906.4	51.9205	14.5372
1907.6	39.6242	13.4337	1907.6	52.0153	14.5023
1908.8	39.6113	13.2545	1908.8	52.0920	14.5141
1910.0	39.6348	13.3352	1910.0	51.8150	14.5716

System Accuracy Verification

Prior to the assessment, the system validation kit was used to test whether the system was operating within its specifications of $\pm 10\%$. The validation results are tabulated below. And also the corresponding SAR plot is attached as well in the SAR plots files.

System Verification Setup Block Diagram

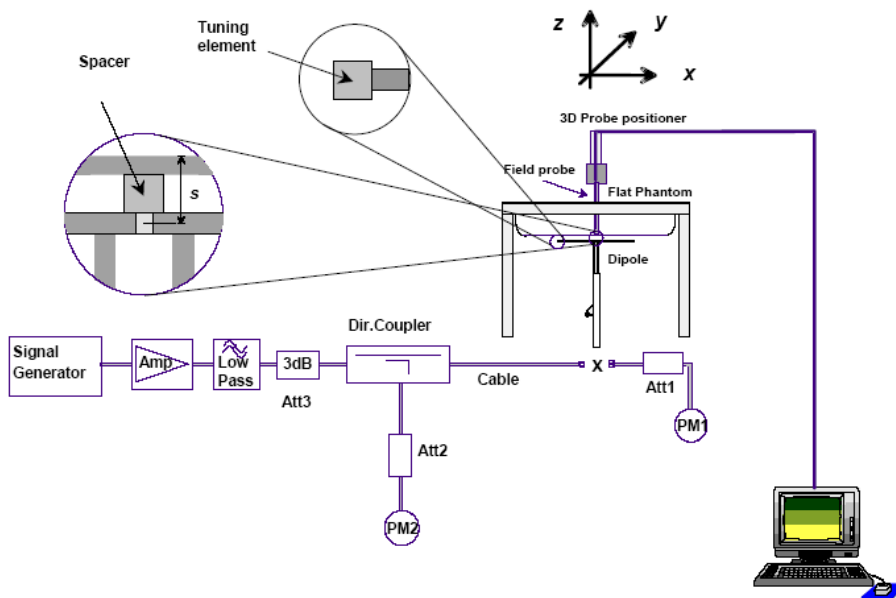

System Accuracy Check Results

Date	Frequency Band	Liquid Type	Measured SAR (W/Kg)		Target Value (W/Kg)	Delta (%)	Tolerance (%)
2015-09-09	835	Head	1g	9.539	9.773	-2.394	± 10
		Body	1g	9.652	9.736	-0.863	± 10
	1900	Head	1g	40.002	39.481	1.320	± 10
		Body	1g	41.018	39.715	3.281	± 10

*All SAR values are normalized to 1 Watt forward power.

SAR SYSTEM VALIDATION DATA

Test Laboratory: Bay Area Compliance Labs Corp.(Dongguan)

System Performance 835MHz Head

DUT: ALS-D-835-S-2; Type: 835 MHz; Serial: 180-00558

Communication System: UID 0, CW (0); Frequency: 835 MHz;Duty Cycle: 1:1
 Medium parameters used: f = 835 MHz; $\sigma = 0.914$ S/m; $\epsilon_r = 41.060$; $\rho = 1000$ kg/m³
 Phantom section: Flat Section

DASY5 Configuration:

- Probe: EX3DV4 - SN7329; ConvF(9.52, 9.52, 9.52); Calibrated: 2015/2/5;
- Sensor-Surface: 4mm (Mechanical Surface Detection)
- Electronics: DAE4 Sn1459; Calibrated: 2015/1/26
- Phantom: SAM (30deg probe tilt) with CRP v5.0_20150321; Type: QD000P40CD; Serial: TP:1874
- Measurement SW: DASY52, Version 52.8 (8);

System Performance 835MHz /Area Scan (71x131x1): Interpolated grid: dx=1.500 mm, dy=1.500 mm
 Maximum value of SAR (interpolated) = 10.3 W/kg

System Performance 835MHz /Zoom Scan (7x7x7)/Cube 0: Measurement grid: dx=5mm, dy=5mm, dz=5mm
 Reference Value = 107.1 V/m; Power Drift = 0.04 dB
 Peak SAR (extrapolated) = 15.8 W/kg
SAR(1 g) = 9.539 W/kg; SAR(10 g) = 6.621 W/kg
 Maximum value of SAR (measured) = 10.6 W/kg

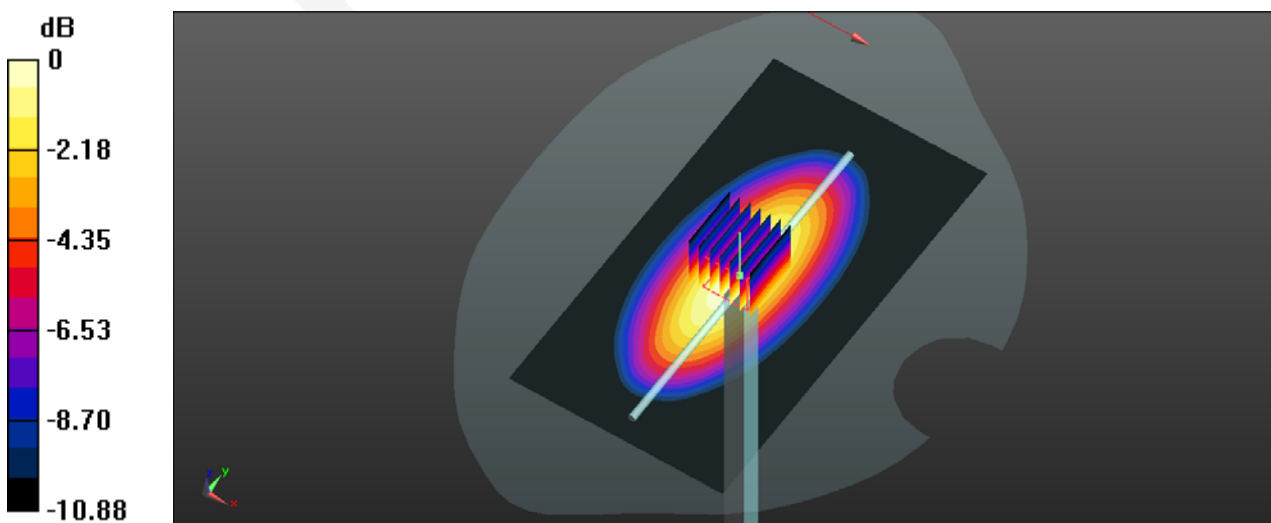

0 dB = 10.5 W/kg = 10.21 dBW/kg

Test Laboratory: Bay Area Compliance Labs Corp.(Dongguan)

System Performance 835MHz Body

DUT: ALS-D-835-S-2; Type: 835 MHz; Serial: 180-00558

Communication System: UID 0, CW (0); Frequency: 835 MHz;Duty Cycle: 1:1
 Medium parameters used: $f = 835 \text{ MHz}$; $\sigma = 0.959 \text{ S/m}$; $\epsilon_r = 53.868$; $\rho = 1000 \text{ kg/m}^3$
 Phantom section: Flat Section

DASY5 Configuration:

- Probe: EX3DV4 - SN7329; ConvF(9.17, 9.17, 9.17); Calibrated: 2015/2/5;
- Sensor-Surface: 4mm (Mechanical Surface Detection)
- Electronics: DAE4 Sn1459; Calibrated: 2015/1/26
- Phantom: SAM (30deg probe tilt) with CRP v5.0_20150321; Type: QD000P40CD; Serial: TP:1874
- Measurement SW: DASY52, Version 52.8 (8);

System Performance 835MHz /Area Scan (71x131x1): Interpolated grid: $dx=1.500 \text{ mm}$, $dy=1.500 \text{ mm}$

Maximum value of SAR (interpolated) = 9.947 W/kg

System Performance 835MHz /Zoom Scan (7x7x7)/Cube 0: Measurement grid: $dx=5\text{mm}$, $dy=5\text{mm}$, $dz=5\text{mm}$

Reference Value = 98.02 V/m; Power Drift = 0.04 dB

Peak SAR (extrapolated) = 14.89 W/kg

SAR(1 g) = 9.652 W/kg; SAR(10 g) = 6.735 W/kg

Maximum value of SAR (measured) = 9.915 W/kg

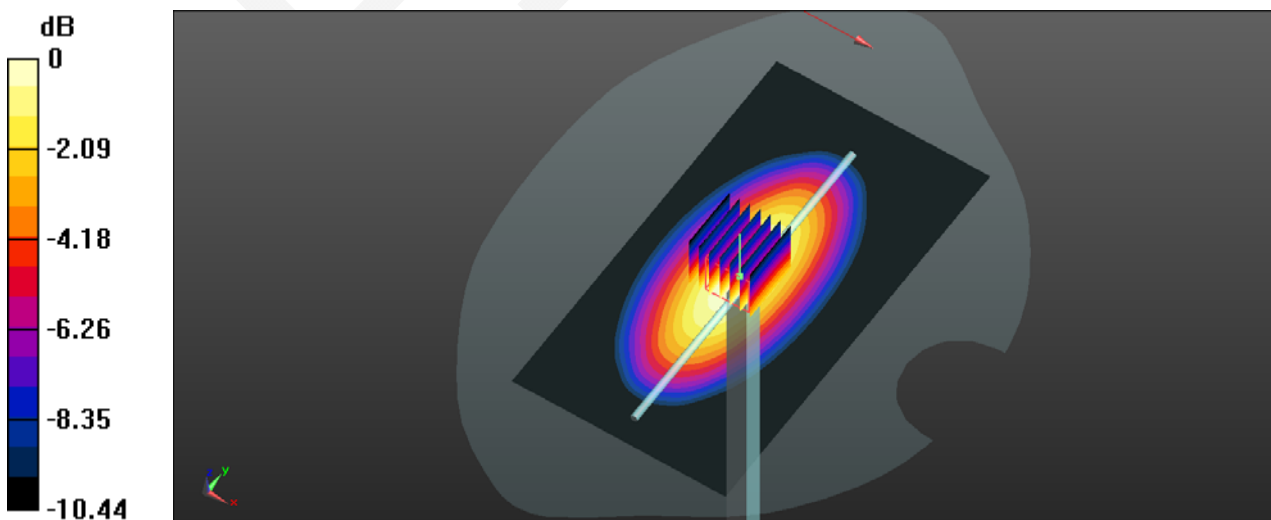

0 dB = 9.92 W/kg = 9.97 dBW/kg

Test Laboratory: Bay Area Compliance Labs Corp.(Dongguan)

System Performance 1900MHz Head

DUT: ALS-D-1900-S-2; Type: 1900 MHz; Serial: 210-00710

Communication System: UID 0, CW (0); Frequency: 1900 MHz; Duty Cycle: 1:1
 Medium parameters used: $f = 1900 \text{ MHz}$; $\sigma = 1.408 \text{ S/m}$; $\epsilon_r = 39.661$; $\rho = 1000 \text{ kg/m}^3$
 Phantom section: Flat Section

DASY5 Configuration:

- Probe: EX3DV4 - SN7329; ConvF(7.88, 7.88, 7.88); Calibrated: 2015/2/5;
- Sensor-Surface: 4mm (Mechanical Surface Detection)
- Electronics: DAE4 Sn1459; Calibrated: 2015/1/26
- Phantom: SAM (30deg probe tilt) with CRP v5.0_20150321; Type: QD000P40CD; Serial: TP:1874
- Measurement SW: DASY52, Version 52.8 (8);

System Performance 1900MHz /Area Scan (61x81x1): Interpolated grid: $dx=1.500 \text{ mm}$, $dy=1.500 \text{ mm}$

Maximum value of SAR (interpolated) = 43.5 W/kg

System Performance 1900MHz /Zoom Scan (7x7x7)/Cube 0: Measurement grid: $dx=5\text{mm}$, $dy=5\text{mm}$, $dz=5\text{mm}$

Reference Value = 168.8 V/m; Power Drift = -0.05 dB

Peak SAR (extrapolated) = 71.5 W/kg

SAR(1 g) = 40.002 W/kg; SAR(10 g) = 21.867 W/kg

Maximum value of SAR (measured) = 42.8 W/kg

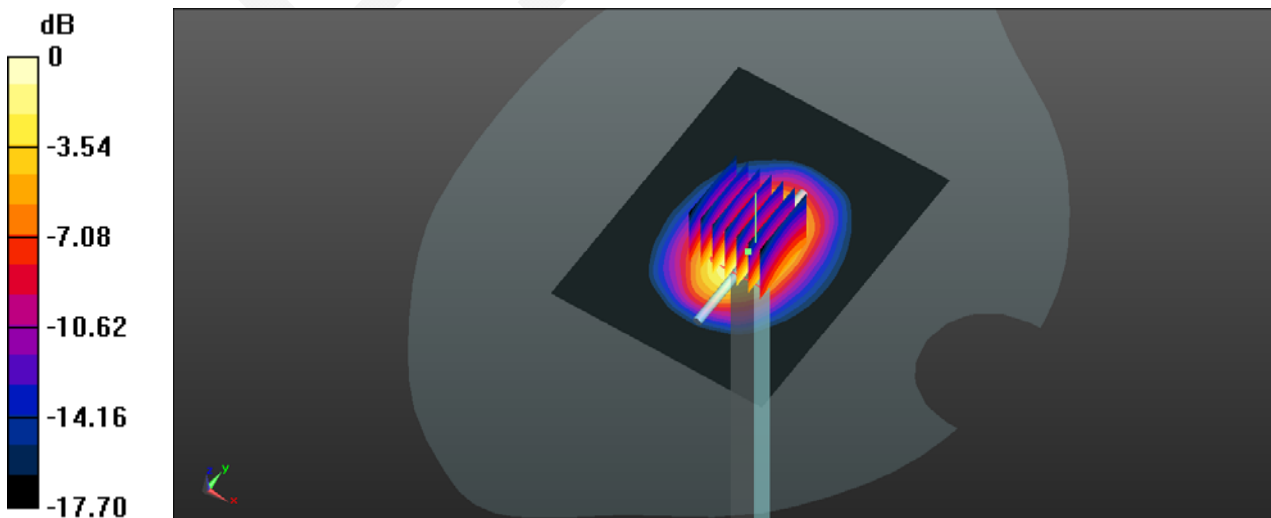

0 dB = 43.0 W/kg = 16.33 dBW/kg

Test Laboratory: Bay Area Compliance Labs Corp.(Dongguan)

System Performance 1900MHz Body

DUT: ALS-D-1900-S-2; Type: 1900 MHz; Serial: 210-00710

Communication System: UID 0, CW (0); Frequency: 1900 MHz; Duty Cycle: 1:1
 Medium parameters used: $f = 1900 \text{ MHz}$; $\sigma = 1.533 \text{ S/m}$; $\epsilon_r = 51.781$; $\rho = 1000 \text{ kg/m}^3$
 Phantom section: Flat Section

DASY5 Configuration:

- Probe: EX3DV4 - SN7329; ConvF(7.56, 7.56, 7.56); Calibrated: 2015/2/5;
- Sensor-Surface: 4mm (Mechanical Surface Detection)
- Electronics: DAE4 Sn1459; Calibrated: 2015/1/26
- Phantom: SAM (30deg probe tilt) with CRP v5.0_20150321; Type: QD000P40CD; Serial: TP:1874
- Measurement SW: DASY52, Version 52.8 (8);

System Performance 1900MHz /Area Scan (61x81x1): Interpolated grid: $dx=1.500 \text{ mm}$, $dy=1.500 \text{ mm}$

Maximum value of SAR (interpolated) = 46.2 W/kg

System Performance 1900MHz /Zoom Scan (7x7x7)/Cube 0: Measurement grid: $dx=5\text{mm}$, $dy=5\text{mm}$, $dz=5\text{mm}$

Reference Value = 169.7 V/m; Power Drift = -0.11 dB

Peak SAR (extrapolated) = 75.1 W/kg

SAR(1 g) = 41.018 W/kg; SAR(10 g) = 20.651 W/kg

Maximum value of SAR (measured) = 44.8 W/kg

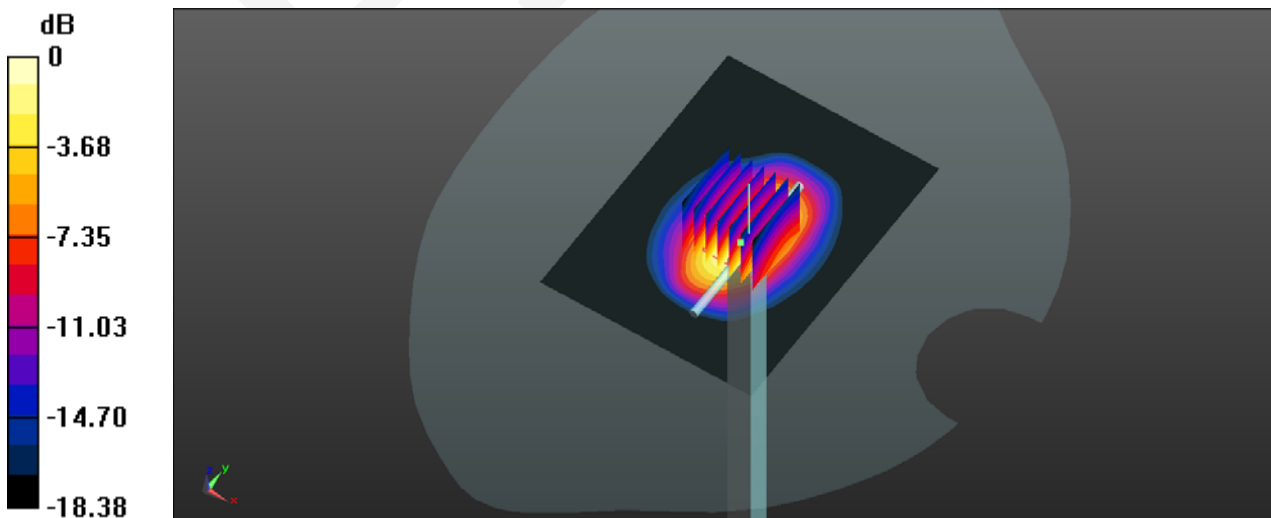

0 dB = 46.5 W/kg = 16.67 dBW/kg

EUT TEST STRATEGY AND METHODOLOGY

Test Positions for Device Operating Next to a Person’s Ear

This category includes most wireless handsets with fixed, retractable or internal antennas located toward the top half of the device, with or without a foldout, sliding or similar keypad cover. The handset should have its earpiece located within the upper ¼ of the device, either along the centerline or off-centered, as perceived by its users. This type of handset should be positioned in a normal operating position with the “test device reference point” located along the “vertical centerline” on the front of the device aligned to the “ear reference point”. The “test device reference point” should be located at the same level as the center of the earpiece region. The “vertical centerline” should bisect the front surface of the handset at its top and bottom edges. A “ear reference point” is located on the outer surface of the head phantom on each ear spacer. It is located 1.5 cm above the center of the ear canal entrance in the “phantom reference plane” defined by the three lines joining the center of each “ear reference point” (left and right) and the tip of the mouth.

A handset should be initially positioned with the earpiece region pressed against the ear spacer of a head phantom. For the SCC-34/SC-2 head phantom, the device should be positioned parallel to the “N-F” line defined along the base of the ear spacer that contains the “ear reference point”. For interim head phantoms, the device should be positioned parallel to the cheek for maximum RF energy coupling. The “test device reference point” is aligned to the “ear reference point” on the head phantom and the “vertical centerline” is aligned to the “phantom reference plane”. This is called the “initial ear position”. While maintaining these three alignments, the body of the handset is gradually adjusted to each of the following positions for evaluating SAR:

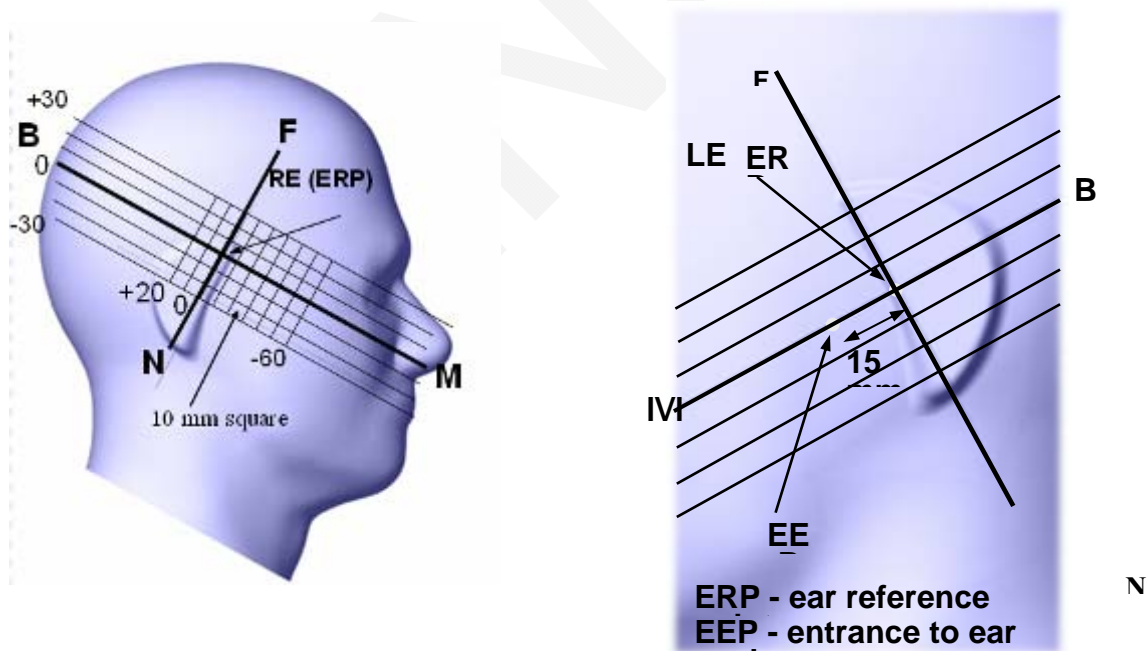

Cheek/Touch Position

The device is brought toward the mouth of the head phantom by pivoting against the “ear reference point” or along the “N-F” line for the SCC-34/SC-2 head phantom.

This test position is established:

- When any point on the display, keypad or mouthpiece portions of the handset is in contact with the phantom.
- (or) When any portion of a foldout, sliding or similar keypad cover opened to its intended self-adjusting normal use position is in contact with the cheek or mouth of the phantom.

For existing head phantoms – when the handset loses contact with the phantom at the pivoting point, rotation should continue until the device touches the cheek of the phantom or breaks its last contact from the ear spacer.

Cheek /Touch Position

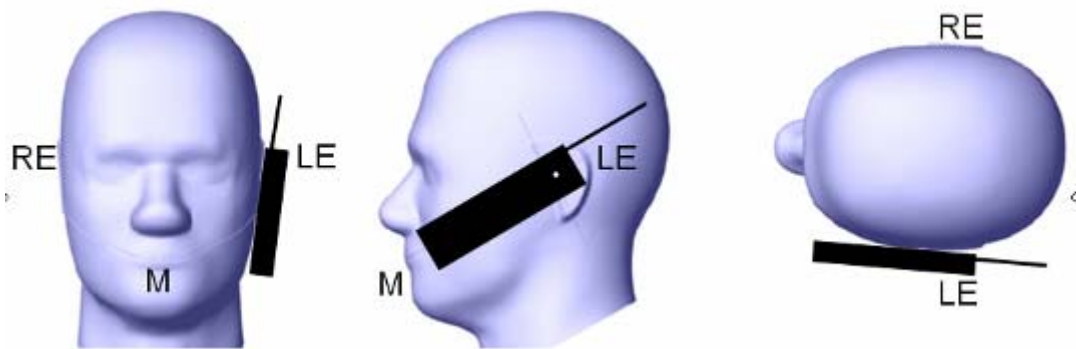

Ear/Tilt Position

With the handset aligned in the “Cheek/Touch Position”:

1) If the earpiece of the handset is not in full contact with the phantom’s ear spacer (in the “Cheek/Touch position”) and the peak SAR location for the “Cheek/Touch” position is located at the ear spacer region or corresponds to the earpiece region of the handset, the device should be returned to the “initial ear position” by rotating it away from the mouth until the earpiece is in full contact with the ear spacer.

2) (otherwise) The handset should be moved (translated) away from the cheek perpendicular to the line passes through both “ear reference points” (note: one of these ear reference points may not physically exist on a split head model) for approximate 2-3 cm. While it is in this position, the device handset is tilted away from the mouth with respect to the “test device reference point” until the inside angle between the vertical centerline on the front surface of the phone and the horizontal line passing through the ear reference point is by 15 80°. After the tilt, it is then moved (translated) back toward the head perpendicular to the line passes through both “ear reference points” until the device touches the phantom or the ear spacer. If the antenna touches the head first, the positioning process should be repeated with a tilt angle less than 15° so that the device and its antenna would touch the phantom simultaneously. This test position may require a device holder or positioner to achieve the translation and tilting with acceptable positioning repeatability.

If a device is also designed to transmit with its keypad cover closed for operating in the head position, such positions should also be considered in the SAR evaluation. The device should be tested on the left and right side of the head phantom in the “Cheek/Touch” and “Ear/Tilt” positions. When applicable, each configuration should be tested with the antenna in its fully extended and fully retracted positions. These test configurations should be tested at the high, middle and low frequency channels of each operating mode; for example, AMPS, CDMA, and TDMA. If the SAR measured at the middle channel for each test configuration (left, right, Cheek/Touch, Tilt/Ear, extended and retracted) is at least 2.0 dB lower than the SAR limit, testing at the high and low channels is optional for such test configuration(s). If the transmission band of the test device is less than 10 MHz, testing at the high and low frequency channels is optional.

Ear /Tilt 15° Position

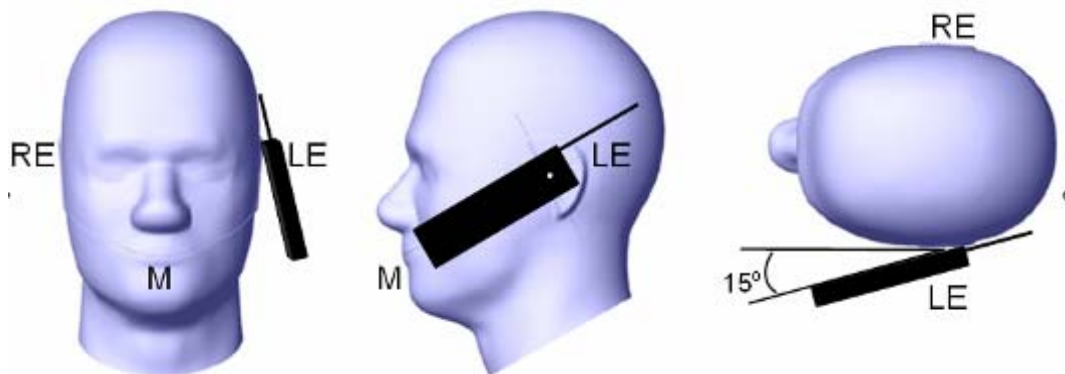

Test positions for body-worn and other configurations

Body-worn operating configurations should be tested with the belt-clips and holsters attached to the device and positioned against a flat phantom in normal use configurations. Devices with a headset output should be tested with a headset connected to the device. When multiple accessories that do not contain metallic components are supplied with the device, the device may be tested with only the accessory that dictates the closest spacing to the body. When multiple accessories that contain metallic components are supplied with the device, the device must be tested with each accessory that contains a unique metallic component. If multiple accessories share an identical metallic component (e.g., the same metallic belt-clip used with different holsters with no other metallic components), only the accessory that dictates the closest spacing to the body must be tested.

Body-worn accessories may not always be supplied or available as options for some devices that are intended to be authorized for body-worn use. A separation distance of 1.5 cm between the back of the device and a flat phantom is recommended for testing body-worn SAR compliance under such circumstances. Other separation distances may be used, but they should not exceed 2.5 cm. In these cases, the device may use body-worn accessories that provide a separation distance greater than that tested for the device provided however that the accessory contains no metallic components.

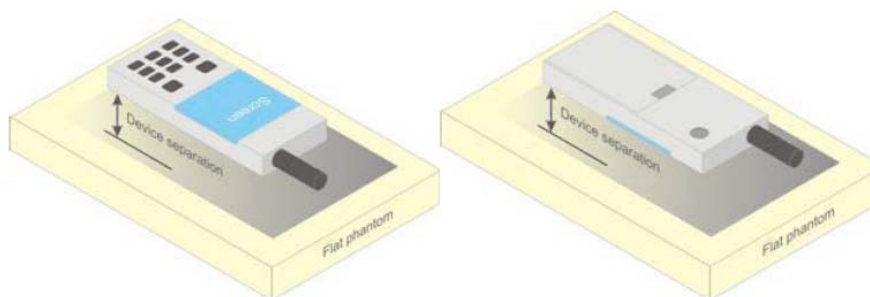

Figure 5 – Test positions for body-worn devices

SAR Evaluation Procedure

The evaluation was performed with the following procedure:

Step 1: Measurement of the SAR value at a fixed location above the ear point or central position was used as a reference value for assessing the power drop. The SAR at this point is measured at the start of the test and then again at the end of the testing.

Step 2: The SAR distribution at the exposed side of the head was measured at a distance of 4 mm from the inner surface of the shell. The area covered the entire dimension of the head or EUT and the horizontal grid spacing was 10 mm x 10 mm. Based on these data, the area of the maximum absorption was determined by spline interpolation. The first Area Scan covers the entire dimension of the EUT to ensure that the hotspot was correctly identified.

Step 3: Around this point, a volume of 30 mm x 30 mm x 30 mm was assessed by measuring 7x 7 x 7 points. On the basis of this data set, the spatial peak SAR value was evaluated under the following procedure:

- 1) The data at the surface were extrapolated, since the center of the dipoles is 1.2 mm away from the tip of the probe and the distance between the surface and the lowest measuring point is 1.3 mm. The extrapolation was based on a least square algorithm. A polynomial of the fourth order was calculated through the points in z-axes. This polynomial was then used to evaluate the points between the surface and the probe tip.
- 2) The maximum interpolated value was searched with a straightforward algorithm. Around this maximum the SAR values averaged over the spatial volumes (1 g or 10 g) were computed by the 3D-Spline interpolation algorithm. The 3D-Spline is composed of three one dimensional splines with the "Not a knot"-condition (in x, y and z-directions). The volume was integrated with the trapezoidal-algorithm. One thousand points (10 x 10 x 10) were interpolated to calculate the averages.

All neighboring volumes were evaluated until no neighboring volume with a higher average value was found.

Step 4: Re-measurement of the SAR value at the same location as in Step 1. If the value changed by more than 5%, the evaluation was repeated.

Test methodology

KDB 447498 D01 General RF Exposure Guidance v05r02.
KDB 648474 D04 Handset SAR v01r02.
KDB 865664 D01 SAR measurement 100 MHz to 6 GHz v01r03
KDB 865664 D02 RF Exposure Reporting v01r01
KDB 941225 D01 3G SAR Procedures v03

CONDUCTED OUTPUT POWER MEASUREMENT

Provision Applicable

The measured peak output power should be greater and within 5% than EMI measurement.

Test Procedure

The RF output of the transmitter was connected to the input of the EMI Test Receiver through sufficient attenuation.

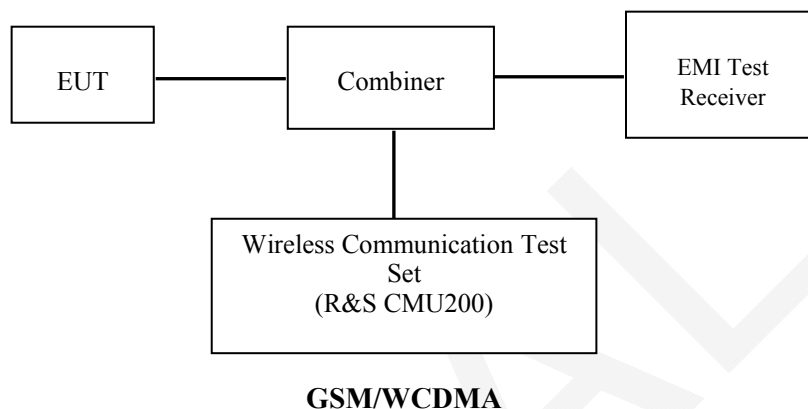

Radio Configuration

The power measurement was configured by the Wireless Communication Test Set CMU200 for all Radio configurations .

GSM

Function: Menu select > GSM Mobile Station > GSM 850/1900

Press Connection control to choose the different menus

Press RESET > choose all the reset all settings

Connection: Press Signal Off to turn off the signal and change settings

Network Support > GSM + only

MS Signal

> 33 dBm for GSM 850

> 30 dBm for GSM 1900

BS Signal: Enter the same channel number for TCH channel (test channel) and BCCH channel

Frequency Offset >+ 0 Hz

Mode > BCCH and TCH

BCCH Level > -85 dBm (May need to adjust if link is not stable)

BCCH Channel > choose desired test channel [Enter the same channel number for TCH channel (test channel) and BCCH channel]

Channel Type > Off

P0 > 4 dB

TCH > choose desired test channel

Hopping > Off

AF/RF: Enter appropriate offsets for Ext. Att. Output and Ext. Att. Input

Connection: Press Signal on to turn on the signal and change settings

GPRS

Function: Menu select > GSM Mobile Station > GSM 850/1900
 Press Connection control to choose the different menus
 Press RESET > choose all the reset all settings
 Connection: Press Signal Off to turn off the signal and change settings
 Network Support > GSM + GPRS or GSM + EGSM
 Main Service > Packet Data

Service selection > Test Mode A – Auto Slot Config. off
 MS Signal: Press Slot Config Bottom on the right twice to select and change the number of time slots and power setting
 > Slot configuration > Uplink/Gamma
 > 33 dBm for GPRS 850
 > 30 dBm for GPRS 1900

BS Signal: Enter the same channel number for TCH channel (test channel) and BCCH channel
 Frequency Offset >+ 0 Hz
 Mode >BCCH and TCH
 BCCH Level >-85 dBm (May need to adjust if link is not stable)
 BCCH Channel > choose desire test channel [Enter the same channel number for TCH channel (test channel) and BCCH channel]

Channel Type > Off
 P0 > 4 dB
 Slot Config > Unchanged (if already set under MS signal)
 TCH > choose desired test channel
 Hopping >Off
 Main Timeslot >3
 Network: Coding Scheme >CS4 (GPRS)
 Bit Stream >2E9-1 PSR Bit Stream
 AF/RF: Enter appropriate offsets for Ext. Att. Output and Ext. Att. Input
 Connection: Press Signal on to turn on the signal and change settings

WCDMA Release 99

The following tests were conducted according to the test requirements outlines in section 5.2 of the 3GPP TS34.121-1 specification. The EUT has a nominal maximum output power of 24dBm (+1.7/-3.7).

WCDMA General Settings	Loopback Mode	Test Mode 1
	Rel99 RMC	12.2kbps RMC
	Power Control Algorithm	Algorithm2
	$\beta c / \beta d$	8/15

HSDPA

The following tests were conducted according to the test requirements outlines in section 5.2 of the 3GPP TS34.121-1 specification.

	Mode Subset	HSDPA 1	HSDPA 2	HSDPA 3	HSDPA 4
WCDMA General Settings	Loopback Mode	Test Mode 1			
	Rel99 RMC	12.2kbps RMC			
	HSDPA FRC	H-Set1			
	Power Control Algorithm	Algorithm2			
	βc	2/15	12/15	15/15	15/15
	βd	15/15	15/15	8/15	4/15
	βd (SF)	64			
	$\beta c / \beta d$	2/15	12/15	15/8	15/4
	βhs	4/15	24/15	30/15	30/15
	MPR(dB)	0	0	0.5	0.5
HSDPA Specific Settings	DACK	8			
	DNAK	8			
	DCQI	8			
	Ack-Nack repetition factor	3			
	CQI Feedback	4ms			
	CQI Repetition Factor	2			
	$Ahs = \beta hs / \beta c$	30/15			

HSUPA

The following tests were conducted according to the test requirements outlines in section 5.2 of the 3GPP TS34.121-1 specification.

	Mode	HSUPA	HSUPA	HSUPA	HSUPA	HSUPA	
	Subset	1	2	3	4	5	
WCDM A General Settings	Loopback Mode	Test Mode 1					
	Rel99 RMC	12.2kbps RMC					
	HSDPA FRC	H-Set1					
	HSUPA Test	HSUPA Loopback					
	Power Control Algorithm	Algorithm2					
	βc	11/15	6/15	15/15	2/15	15/15	
	βd	15/15	15/15	9/15	15/15	0	
	βec	209/225	12/15	30/15	2/15	5/15	
	$\beta c/ \beta d$	11/15	6/15	15/9	2/15	-	
	βhs	22/15	12/15	30/15	4/15	5/15	
	CM(dB)	1.0	3.0	2.0	3.0	1.0	
MPR(dB)	0	2	1	2	0		
HSDPA Specific Settings	DACK	8					
	DNAK	8					
	DCQI	8					
	Ack-Nack repetition factor	3					
	CQI Feedback	4ms					
	CQI Repetition Factor	2					
	$A_{hs} = \beta_{hs} / \beta c$	30/15					
HSUPA Specific Settings	DE-DPCCH	6	8	8	5	7	
	DHARQ	0	0	0	0	0	
	AG Index	20	12	15	17	21	
	ETFCI	75	67	92	71	81	
	Associated Max UL Data Rate kbps	242.1	174.9	482.8	205.8	308.9	
	Reference E_FCIs	E-TFCI 11 E	E-TFCI		E-TFCI 11 E		
		E-TFCI PO 4	E-TFCI		E-TFCI PO 4		
		E-TFCI 67	11		E-TFCI 67		
		E-TFCI PO 18	E-TFCI		E-TFCI PO 18		
		E-TFCI 71	PO4		E-TFCI 71		
		E-TFCI PO23	E-TFCI		E-TFCI PO23		
E-TFCI 75		92		E-TFCI 75			
E-TFCI PO26		E-TFCI		E-TFCI PO26			
E-TFCI 81		PO 18		E-TFCI 81			
E-TFCI PO 27			E-TFCI PO 27				

Maximum Output Power among production units

Max Target Power for Production Unit (dBm)			
Mode/Band	Channel		
	Low	Middle	High
GSM 850	32.70	32.70	32.70
GPRS 1 TX Slot	32.70	32.70	32.70
GPRS 2 TX Slot	31.90	31.90	31.90
GPRS 3 TX Slot	30.20	30.20	30.20
GPRS 4 TX Slot	28.90	28.90	28.90
EDGE 1 TX Slot	26.20	26.20	26.20
EDGE 2 TX Slot	25.00	25.00	25.00
EDGE 3 TX Slot	23.10	23.10	23.10
EDGE 4 TX Slot	21.40	21.40	21.40
GSM 1900	29.70	29.20	28.40
GPRS 1 TX Slot	29.70	29.20	28.40
GPRS 2 TX Slot	29.00	28.50	27.80
GPRS 3 TX Slot	27.20	26.80	26.00
GPRS 4 TX Slot	26.00	26.50	24.80
EDGE 1 TX Slot	26.00	25.40	24.50
EDGE 2 TX Slot	24.70	24.10	23.10
EDGE 3 TX Slot	22.70	22.10	21.10
EDGE 4 TX Slot	21.30	20.60	19.70
WCDMA850	Rel 99	22.20	22.20
	HSDPA	21.30	21.30
	HSUPA	21.30	21.30
WCDMA1900	Rel 99	22.20	22.20
	HSDPA	21.20	21.20
	HSUPA	21.20	21.20
Bluetooth	7.20	7.20	7.20

Test Results:

GSM:

Band	Channel No.	Frequency (MHz)	Time Based Average Power (dBm)
GSM 850	128	824.2	32.63
	190	836.6	32.54
	251	848.8	32.54
PCS 1900	512	1850.2	29.58
	661	1880	29.08
	810	1909.8	28.24

GPRS:

Band	Channel No.	Frequency (MHz)	RF Output Power (dBm)			
			1 slot	2 slots	3 slots	4 slots
GSM 850	128	824.2	32.63	31.89	30.15	28.85
	190	836.6	32.53	31.83	29.96	28.64
	251	848.8	32.54	31.78	29.94	28.66
PCS 1900	512	1850.2	29.58	28.86	27.09	25.84
	661	1880	29.06	28.38	26.61	25.36
	810	1909.8	28.29	27.60	25.83	24.64

EGPRS:

Band	Channel No.	Frequency (MHz)	RF Output Power (dBm)			
			1 slot	2 slots	3 slots	4 slots
GSM 850	128	824.2	26.07	24.88	23.02	21.35
	190	836.6	26.12	24.90	22.95	21.38
	251	848.8	26.10	24.90	22.91	21.37
PCS 1900	512	1850.2	25.88	24.58	22.58	21.15
	661	1880	25.21	23.91	21.91	20.46
	810	1909.8	24.35	22.99	20.95	19.52

For SAR, the time based average power is relevant, the difference in between depends on the duty cycle of the TDMA signal.

Number of Time slot	1	2	3	4
Duty Cycle	1:8	1:4	1:2.66	1:2
Time based Ave. power compared to slotted Ave. power	-9 dB	-6 dB	-4.25 dB	-3 dB
Crest Factor	8	4	2.66	2

The time based average power for GPRS

Band	Channel No.	Frequency (MHz)	Time based average Power (dBm)			
			1 slot	2 slot	3 slots	4 slots
GSM 850	128	824.2	23.63	25.89	25.90	25.85
	190	836.6	23.53	25.83	25.71	25.64
	251	848.8	23.54	25.78	25.69	25.66
PCS 1900	512	1850.2	20.58	22.86	22.84	22.84
	661	1880	20.06	22.38	22.36	22.36
	810	1909.8	19.29	21.60	21.58	21.64

The time based average power for EGPRS

Band	Channel No.	Frequency (MHz)	Time based average Power (dBm)			
			1 slot	2 slot	3 slots	4 slots
GSM 850	128	824.2	17.07	18.88	18.77	18.35
	190	836.6	17.12	18.90	18.70	18.38
	251	848.8	17.10	18.90	18.66	18.37
PCS 1900	512	1850.2	16.88	18.58	18.33	18.15
	661	1880	16.21	17.91	17.66	17.46
	810	1909.8	15.35	16.99	16.70	16.52

Note:

1. Rohde & Schwarz Radio Communication Tester (CMU200) was used for the measurement of GSM peak and average output power for active timeslots.
2. For GSM voice, 1 timeslot has been activated with power level 5 (850 MHz band) and 0 (1900 MHz band).
3. For GPRS, 1, 2, 3 and 4 timeslots has been activated separately with power level 3(850 MHz band) and 3(1900 MHz band).
4. For EGPRS, 1, 2, 3 and 4 timeslots has been activated separately with power level 6(850 MHz band) and 5(1900 MHz band).

WCDMA:**Results (12.2kbps RMC)**

Band	Channel No.	Frequency (MHz)	RF Output Power (dBm)
WCDMA 850	4132	826.4	22.12
	4183	836.6	21.99
	4233	846.6	22.02
WCDMA 1900	9262	1852.4	22.13
	9400	1880	22.09
	9538	1907.6	22.08

Results (HSDPA)

Band	Channel No.	Frequency (MHz)	RF Output Power (dBm)			
			Subset 1	Subset 2	Subset 3	Subset 4
WCDMA 850	4132	826.4	21.1	21.02	21.22	21.05
	4183	836.6	20.99	20.87	21.09	20.89
	4233	846.6	20.96	20.85	21.03	20.84
WCDMA 1900	9262	1852.4	20.93	20.85	20.99	20.89
	9400	1880	20.94	20.85	21.00	20.91
	9538	1907.6	21.00	20.90	21.09	20.88

Results (HSUPA)

Band	Channel No.	Frequency (MHz)	RF Output Power (dBm)				
			Subset 1	Subset 2	Subset 3	Subset 4	Subset 5
WCDMA 850	4132	826.4	21.08	21.00	21.13	21.02	21.18
	4183	836.6	20.96	20.85	21.08	20.9	21.04
	4233	846.6	21.00	20.94	21.03	20.93	21.10
WCDMA 1900	9262	1852.4	21.00	20.87	21.08	20.91	21.07
	9400	1880	21.00	20.87	21.07	20.95	21.07
	9538	1907.6	21.06	20.96	21.10	21.00	21.14

Note:

1. The default test configuration is to measure SAR with an established radio link between the EUT and a communication test set using a 12.2 kbps RMC (reference measurement Channel) Configured in Test Loop Model 1.

Bluetooth

Mode	Channel No.	Channel frequency (MHz)	RF Output Power (dBm)
BDR(GFSK)	0	2402	6.53
	39	2441	6.86
	78	2480	7.14
EDR(4-DQPSK)	0	2402	6.48
	39	2441	6.81
	78	2480	6.55
EDR-8DPSK	0	2402	6.57
	39	2441	6.54
	78	2480	7.00

SAR MEASUREMENT RESULTS

This page summarizes the results of the performed dosimetric evaluation.

SAR Test Data

Environmental Conditions

Temperature:	22.5-24
Relative Humidity:	35 %
ATM Pressure:	1003 mbar

Testing was performed by Wilson Chen on 2015-09-09

GSM 850:

EUT Position	Frequency (MHz)	Test Mode	Power Drift (dB)	Max. Meas. Power (dBm)	Max. Rated Power (dBm)	1g SAR (W/Kg)			
						Scaled Factor	Meas. SAR	Scaled SAR	Plot
Left Head Cheek	824.2	GSM	0.112	32.63	32.70	1.016	0.736	0.748	/
	836.6	GSM	-0.030	32.54	32.70	1.038	0.825	0.856	1#
	848.8	GSM	0.061	32.54	32.70	1.038	0.767	0.796	/
Left Head Tilt	824.2	GSM	/	/	/	/	/	/	/
	836.6	GSM	-0.051	32.54	32.70	1.038	0.552	0.573	/
	848.8	GSM	/	/	/	/	/	/	/
Right Head Cheek	824.2	GSM	/	/	/	/	/	/	/
	836.6	GSM	0.072	32.54	32.70	1.038	0.763	0.792	/
	848.8	GSM	/	/	/	/	/	/	/
Right Head Tilt	824.2	GSM	/	/	/	/	/	/	/
	836.6	GSM	-0.153	32.54	32.70	1.038	0.510	0.529	/
	848.8	GSM	/	/	/	/	/	/	/
Body-Back-Headset (15mm)	824.2	GSM	/	/	/	/	/	/	/
	836.6	GSM	-0.125	32.54	32.70	1.038	0.411	0.426	/
	848.8	GSM	/	/	/	/	/	/	/
Body-Worn (15mm)	824.2	GPRS	-0.050	30.15	30.20	1.012	0.725	0.733	2#
	836.6	GPRS	0.170	29.96	30.20	1.057	0.626	0.662	/
	848.8	GPRS	0.063	29.94	30.20	1.062	0.651	0.691	/

Note:

1. When the 1-g SAR is ≤ 0.8 W/Kg, testing for other channels are optional.
2. The EUT transmit and receive through the same GSM antenna while testing SAR.
3. The EUT is a Capability Class B mobile phone which can be attached to both GPRS and GSM services.
4. The Multi-slot Classes of EUT is Class12 which has maximum 4 Downlink slots and 4 Uplink slots, the maximum active slots is 5, when perform the multiple slots scan, 2DL+3UL is the worst case.

PCS Band:

EUT Position	Frequency (MHz)	Test Mode	Power Drift (dB)	Max. Meas. Power (dBm)	Max. Rated Power (dBm)	1g SAR (W/Kg)			
						Scaled Factor	Meas. SAR	Scaled SAR	Plot
Left Head Cheek	1850.2	GSM	0.110	29.58	29.70	1.028	1.08	1.110	3#
	1880	GSM	-0.029	29.08	29.20	1.028	0.896	0.921	/
	1909.8	GSM	0.099	28.24	28.40	1.038	0.833	0.864	/
Left Head Tilt	1850.2	GSM	/	/	/	/	/	/	/
	1880	GSM	0.031	29.08	29.20	1.028	0.537	0.552	/
	1909.8	GSM	/	/	/	/	/	/	/
Right Head Cheek	1850.2	GSM	0.104	29.58	29.70	1.028	0.937	0.963	/
	1880	GSM	-0.099	29.08	29.20	1.028	0.822	0.845	/
	1909.8	GSM	0.143	28.24	28.40	1.038	0.656	0.681	/
Right Head Tilt	1850.2	GSM	/	/	/	/	/	/	/
	1880	GSM	0.000	29.08	29.20	1.028	0.556	0.572	/
	1909.8	GSM	/	/	/	/	/	/	/
Body-Back-Headset (15mm)	1850.2	GSM	-0.012	29.58	29.70	1.028	0.925	0.951	/
	1880	GSM	-0.054	29.08	29.20	1.028	0.967	0.994	/
	1909.8	GSM	0.163	28.24	28.40	1.038	0.733	0.761	/
Body-Worn (15mm)	1850.2	GPRS	-0.150	28.86	29.00	1.033	1.19	1.23	4#
	1880	GPRS	0.060	28.38	28.50	1.028	0.952	0.979	/
	1909.8	GPRS	-0.153	27.60	27.80	1.047	0.860	0.901	/

Note:

1. When the 1-g SAR is $\leq 0.8W/Kg$, testing for other channels are optional.
2. The EUT transmit and receive through the same GSM antenna while testing SAR.
3. The EUT is a Capability Class B mobile phone which can be attached to both GPRS and GSM services.
4. The Multi-slot Classes of EUT is Class12 which has maximum 4 Downlink slots and 4 Uplink slots, the maximum active slots is 5, when perform the multiple slots scan, 3DL+2UL is the worst case.

WCDMA 850 Band:

EUT Position	Frequency (MHz)	Test Mode	Power Drift (dB)	Max. Meas. Power (dBm)	Max. Rated Power (dBm)	1g SAR (W/Kg)			
						Scaled Factor	Meas. SAR	Scaled SAR	Plot
Left Head Cheek	826.4	WCDMA	0.140	22.12	22.20	1.019	0.578	0.589	5#
	836.6	WCDMA	/	/	/	/	/	/	/
	846.6	WCDMA	/	/	/	/	/	/	/
Left Head Tilt	826.4	WCDMA	-0.177	22.12	22.20	1.019	0.333	0.339	/
	836.6	WCDMA	/	/	/	/	/	/	/
	846.6	WCDMA	/	/	/	/	/	/	/
Right Head Cheek	826.4	WCDMA	-0.006	22.12	22.20	1.019	0.537	0.547	/
	836.6	WCDMA	/	/	/	/	/	/	/
	846.6	WCDMA	/	/	/	/	/	/	/
Right Head Tilt	826.4	WCDMA	0.014	22.12	22.20	1.019	0.269	0.274	/
	836.6	WCDMA	/	/	/	/	/	/	/
	846.6	WCDMA	/	/	/	/	/	/	/
Body-Worn (15mm)	826.4	WCDMA	-0.070	22.12	22.20	1.019	0.562	0.572	6#
	836.6	WCDMA	/	/	/	/	/	/	/
	846.6	WCDMA	/	/	/	/	/	/	/

WCDMA 1900 Band:

EUT Position	Frequency (MHz)	Test Mode	Power Drift (dB)	Max. Meas. Power (dBm)	Max. Rated Power (dBm)	1g SAR (W/Kg)			
						Scaled Factor	Meas. SAR	Scaled SAR	Plot
Left Head Cheek	1852.4	WCDMA	0.060	22.13	22.20	1.016	0.693	0.704	7#
	1880	WCDMA	/	/	/	/	/	/	/
	1907.6	WCDMA	/	/	/	/	/	/	/
Left Head Tilt	1852.4	WCDMA	-0.125	22.13	22.20	1.016	0.355	0.361	/
	1880	WCDMA	/	/	/	/	/	/	/
	1907.6	WCDMA	/	/	/	/	/	/	/
Right Head Cheek	1852.4	WCDMA	-0.194	22.13	22.20	1.016	0.617	0.627	/
	1880	WCDMA	/	/	/	/	/	/	/
	1907.6	WCDMA	/	/	/	/	/	/	/
Right Head Tilt	1852.4	WCDMA	0.213	22.13	22.20	1.016	0.316	0.321	/
	1880	WCDMA	/	/	/	/	/	/	/
	1907.6	WCDMA	/	/	/	/	/	/	/
Body-Worn (15mm)	1852.4	WCDMA	-0.020	22.13	22.20	1.016	0.496	0.504	8#
	1880	WCDMA	/	/	/	/	/	/	/
	1907.6	WCDMA	/	/	/	/	/	/	/

Note:

1. When the 1-g SAR is ≤ 0.8W/Kg, testing for other channels are optional.
2. The EUT transmit and receive through the same antenna while testing SAR.
3. The default test configuration is to measure SAR with an established radio link between the EUT and a communication test set using a 12.2 kbps RMC (reference measurement Channel) Configured in Test Loop Model.

SAR SIMULTANEOUS TRANSMISSION DESCRIPTION

BT and GSM&3G Antennas Location:

Right

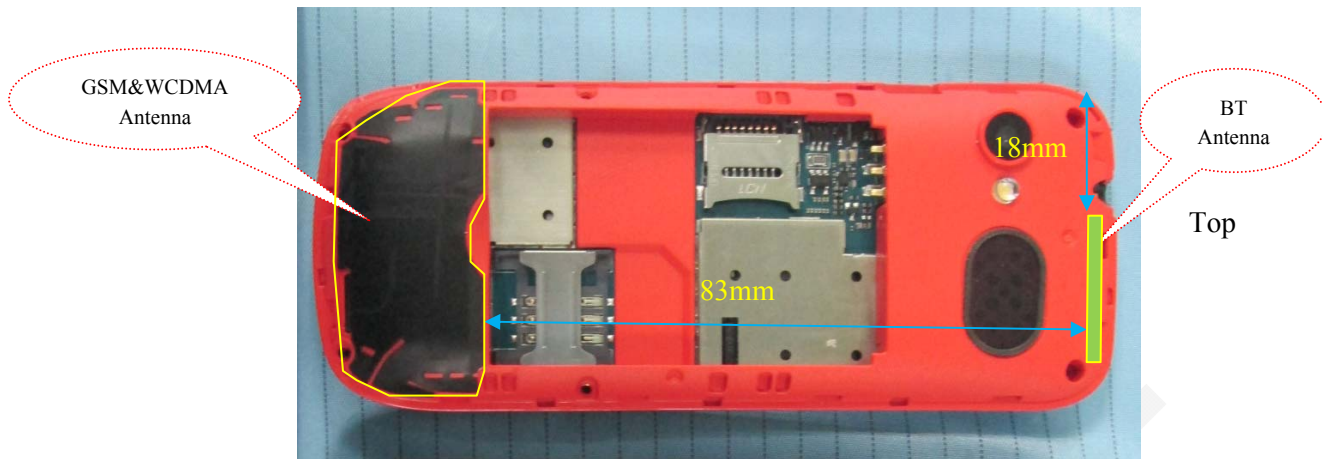

Left

Simultaneous Transmission:

Description of Simultaneous Transmit Capabilities			Antennas Distance (mm)
Transmitter Combination	Simultaneous?	Hotspot?	
GSM + WCDMA	×	×	0
GSM + Bluetooth	√	×	83
WCDMA+Bluetooth	√	×	83

Standalone SAR test exclusion considerations

Mode	Frequency (MHz)	Pavg (dBm)	Pavg (mW)	Distance (mm)	Calculated value	Threshold (1-g)	SAR Test Exclusion
Bluetooth	2480	7.20	5.25	0	1.6	3	YES
Bluetooth	2480	7.20	5.25	15	0.6	3	YES

NOTE:

The 1-g and 10-g SAR test exclusion thresholds for 100 MHz to 6 GHz at test separation distances ≤ 50 mm are determined by:

$$[(\text{max. power of channel, including tune-up tolerance, mW}) / (\text{min. test separation distance, mm})] \cdot [\sqrt{f(\text{GHz})}] \leq 3.0 \text{ for 1-g SAR and } \leq 7.5 \text{ for 10-g extremity SAR, where}$$

1. f(GHz) is the RF channel transmit frequency in GHz.
2. Power and distance are rounded to the nearest mW and mm before calculation.
3. The result is rounded to one decimal place for comparison.
4. When the minimum test separation distance is < 5 mm, a distance of 5 mm is applied to determine SAR test Exclusion.

Standalone SAR estimation:

Mode	Frequency (GHz)	Pavg (dBm)	Pavg (mW)	Distance (mm)	Estimated 1-g (W/kg)
BT Head	2480	7.20	5.25	0	0.219
BT Body	2480	7.20	5.25	15	0.073

When standalone SAR test exclusion applies to an antenna that transmits simultaneously with other antennas, the standalone SAR must be estimated according to following to determine simultaneous transmission SAR test exclusion:

$$[(\text{max. power of channel, including tune-up tolerance, mW}) / (\text{min. test separation distance, mm})] \cdot [\sqrt{f(\text{GHz})/x}]$$

W/kg for test separation distances ≤ 50 mm;

where x = 7.5 for 1-g SAR.

When the minimum test separation distance is < 5 mm, a distance of 5 mm is applied to determine SAR test Exclusion

Simultaneous and Hotspot SAR test exclusion considerations:

GSM with BT:

Mode (SAR1+SAR2)	Position	Reported SAR (W/kg)		Σ SAR < 1.6W/kg
		SAR1	SAR2	
GSM 850+BT	Left Head Cheek	0.856	0.219	1.075
	Left Head Tilt	0.573	0.219	0.792
	Right Head Cheek	0.792	0.219	1.011
	Right Head Tilt	0.529	0.219	0.748
	Body-Back-Headset	0.426	0.073	0.499
	Body-Worn	0.773	0.073	0.846
PCS1900 +BT	Left Head Cheek	1.11	0.219	1.329
	Left Head Tilt	0.552	0.219	0.771
	Right Head Cheek	0.963	0.219	1.182
	Right Head Tilt	0.572	0.219	0.791
	Body-Back-Headset	0.994	0.073	1.067
	Body-Worn	1.23	0.073	1.303

WCDMA with BT:

Mode (SAR1+SAR2)	Position	Reported SAR (W/kg)		Σ SAR < 1.6W/kg
		SAR1	SAR2	
WCDMA 850+BT	Left Head Cheek	0.589	0.219	0.808
	Left Head Tilt	0.339	0.219	0.558
	Right Head Cheek	0.547	0.219	0.766
	Right Head Tilt	0.274	0.219	0.493
	Body-Worn	0.572	0.073	0.645
WCDMA1900 +BT	Left Head Cheek	0.704	0.219	0.923
	Left Head Tilt	0.361	0.219	0.580
	Right Head Cheek	0.627	0.219	0.846
	Right Head Tilt	0.321	0.219	0.540
	Body-Worn	0.504	0.073	0.577

SAR Plots (Summary of the Highest SAR Values)

Test Laboratory: Bay Area Compliance Labs Corp.(Dongguan)

Test Plot 1#:GSM 850-Left Head Check Middle Channel

DUT: Mobile Phone; Type: E245S;

Communication System: UID 0, GSM 850 (0); Frequency: 836.6 MHz;Duty Cycle: 1:8

Medium parameters used: $f = 836.6 \text{ MHz}$; $\sigma = 0.92 \text{ S/m}$; $\epsilon_r = 41.02$; $\rho = 1000 \text{ kg/m}^3$

Phantom section: Left Section

DASY5 Configuration:

- Probe: EX3DV4 - SN7329; ConvF(9.52, 9.52, 9.52); Calibrated: 2015/2/5;
- Sensor-Surface: 4mm (Mechanical Surface Detection)
- Electronics: DAE4 Sn1459; Calibrated: 2015/1/26
- Phantom: SAM (30deg probe tilt) with CRP v5.0_20150321; Type: QD000P40CD; Serial: TP:1874
- Measurement SW: DASY52, Version 52.8 (8);

HEAD/GSM850 Left Cheek/Area Scan (51x71x1): Interpolated grid: $dx=1.500 \text{ mm}$, $dy=1.500 \text{ mm}$

Maximum value of SAR (interpolated) = 0.911 W/kg

HEAD/GSM850 Left Cheek/Zoom Scan (7x7x7)/Cube 0: Measurement grid: $dx=5\text{mm}$, $dy=5\text{mm}$, $dz=5\text{mm}$

Reference Value = 14.18 V/m ; Power Drift = -0.03 dB

Peak SAR (extrapolated) = 1.162 W/kg

SAR(1 g) = 0.825 W/kg ; SAR(10 g) = 0.557 W/kg

Maximum value of SAR (measured) = 0.875 W/kg

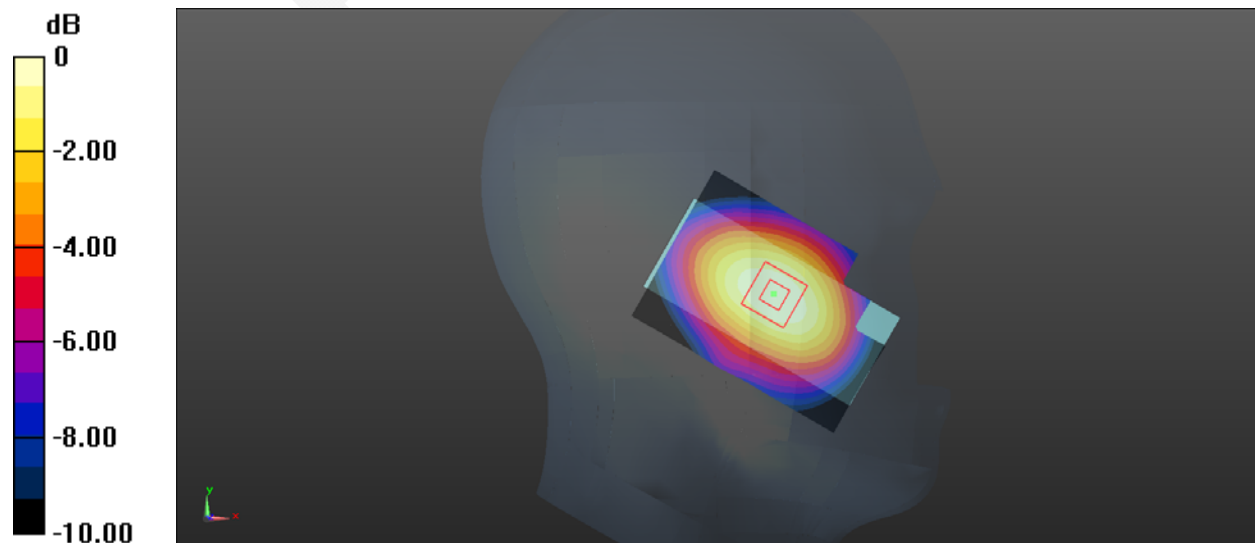

0 dB = $0.875 \text{ W/kg} = -0.58 \text{ dBW/kg}$

Test Laboratory: Bay Area Compliance Labs Corp.(Dongguan)

Test Plot 2#: GSM 850 Back Low Channel

DUT: Mobile Phone; Type: E245S;

Communication System: UID 0, Generic GPRS-3 SLOTS (0); Frequency: 824.2 MHz;Duty Cycle: 1:2.67

Medium parameters used: $f = 824.2 \text{ MHz}$; $\sigma = 0.95 \text{ S/m}$; $\epsilon_r = 53.86$; $\rho = 1000 \text{ kg/m}^3$

Phantom section: Flat Section

DASY5 Configuration:

- Probe: EX3DV4 - SN7329; ConvF(9.17, 9.17, 9.17); Calibrated: 2015/2/5;
- Sensor-Surface: 4mm (Mechanical Surface Detection)
- Electronics: DAE4 Sn1459; Calibrated: 2015/1/26
- Phantom: SAM (30deg probe tilt) with CRP v5.0_20150321; Type: QD000P40CD; Serial: TP:1874
- Measurement SW: DASY52, Version 52.8 (8);

Body/GSM 850 Back/Area Scan (51x81x1): Interpolated grid: $dx=1.500 \text{ mm}$, $dy=1.500 \text{ mm}$

Maximum value of SAR (interpolated) = 0.786 W/kg

Body/GSM 850 Back/Zoom Scan (7x7x7)/Cube 0: Measurement grid: $dx=5\text{mm}$, $dy=5\text{mm}$, $dz=5\text{mm}$

Reference Value = 18.02 V/m; Power Drift = -0.05 dB

Peak SAR (extrapolated) = 1.039 W/kg

SAR(1 g) = 0.725 W/kg; SAR(10 g) = 0.446 W/kg

Maximum value of SAR (measured) = 0.752 W/kg

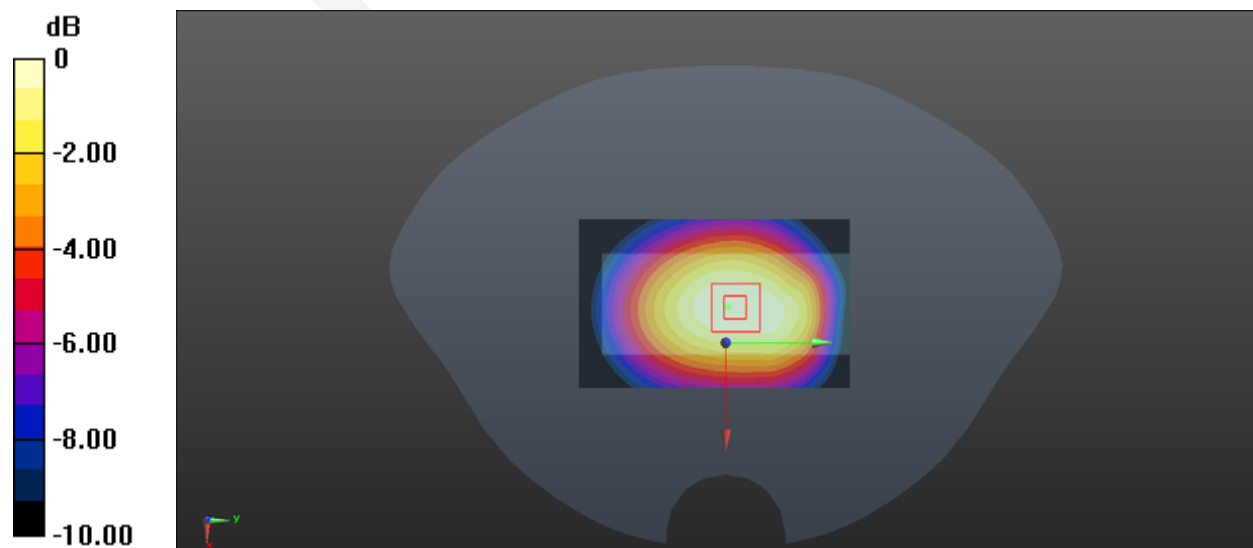

0 dB = 0.752 W/kg = -1.24 dBW/kg

Test Laboratory: Bay Area Compliance Labs Corp.(Dongguan)

Test Plot 3#:GSM 1900 Left Cheek Low Channel

DUT: Mobile Phone; Type: E245S;

Communication System: UID 0, Generic GSM (0); Frequency: 1850.2 MHz;Duty Cycle: 1:8

Medium parameters used: $f = 1850.2 \text{ MHz}$; $\sigma = 1.37 \text{ S/m}$; $\epsilon_r = 39.74$; $\rho = 1000 \text{ kg/m}^3$

Phantom section: Right Section

DASY5 Configuration:

- Probe: EX3DV4 - SN7329; ConvF(7.88, 7.88, 7.88); Calibrated: 2015/2/5;
- Sensor-Surface: 4mm (Mechanical Surface Detection)
- Electronics: DAE4 Sn1459; Calibrated: 2015/1/26
- Phantom: SAM (30deg probe tilt) with CRP v5.0_20150321; Type: QD000P40CD; Serial: TP:1874
- Measurement SW: DASY52, Version 52.8 (8);

Head/PCS 1900-Left Cheek/Area Scan (51x71x1): Interpolated grid: $dx=1.500 \text{ mm}$, $dy=1.500 \text{ mm}$

Maximum value of SAR (interpolated) = 1.20 W/kg

Head/PCS 1900-Left Cheek/Zoom Scan (7x7x7)/Cube 0: Measurement grid: $dx=5\text{mm}$, $dy=5\text{mm}$, $dz=5\text{mm}$

Reference Value = 12.09 V/m; Power Drift = 0.11 dB

Peak SAR (extrapolated) = 1.939 W/kg

SAR(1 g) = 1.08 W/kg; SAR(10 g) = 0.603 W/kg

Maximum value of SAR (measured) = 1.23 W/kg

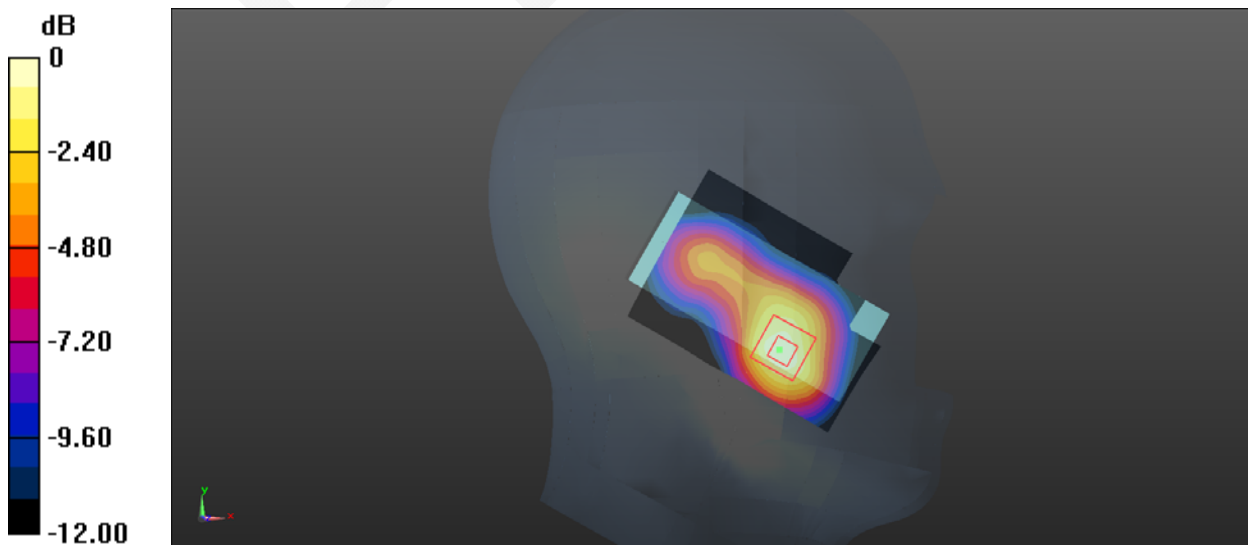

0 dB = 1.23 W/kg = 0.90 dBW/kg

Test Laboratory: Bay Area Compliance Labs Corp.(Dongguan)

Test Plot 4#:PCS 1900 Back Low Channel

DUT: Mobile Phone; Type: E245S;

Communication System: UID 0, Generic GPRS-2 SLOT (0); Frequency: 1850.2 MHz;Duty Cycle: 1:4

Medium parameters used: $f = 1850.2$ MHz; $\sigma = 1.50$ S/m; $\epsilon_r = 52.05$; $\rho = 1000$ kg/m³

Phantom section: Flat Section

DASY5 Configuration:

- Probe: EX3DV4 - SN7329; ConvF(7.56, 7.56, 7.56); Calibrated: 2015/2/5;
- Sensor-Surface: 4mm (Mechanical Surface Detection)
- Electronics: DAE4 Sn1459; Calibrated: 2015/1/26
- Phantom: SAM (30deg probe tilt) with CRP v5.0_20150321; Type: QD000P40CD; Serial: TP:1874
- Measurement SW: DASY52, Version 52.8 (8);

Body/PCS 1900 Back/Area Scan (61x91x1): Interpolated grid: dx=1.500 mm, dy=1.500 mm

Maximum value of SAR (interpolated) = 1.35 W/kg

Body/PCS 1900 Back/Zoom Scan (7x7x7)/Cube 0: Measurement grid: dx=5mm, dy=5mm, dz=5mm

Reference Value = 18.45 V/m; Power Drift = -0.15 dB

Peak SAR (extrapolated) = 1.636 W/kg

SAR(1 g) = 1.19 W/kg; SAR(10 g) = 0.660 W/kg

Maximum value of SAR (measured) = 1.37 W/kg

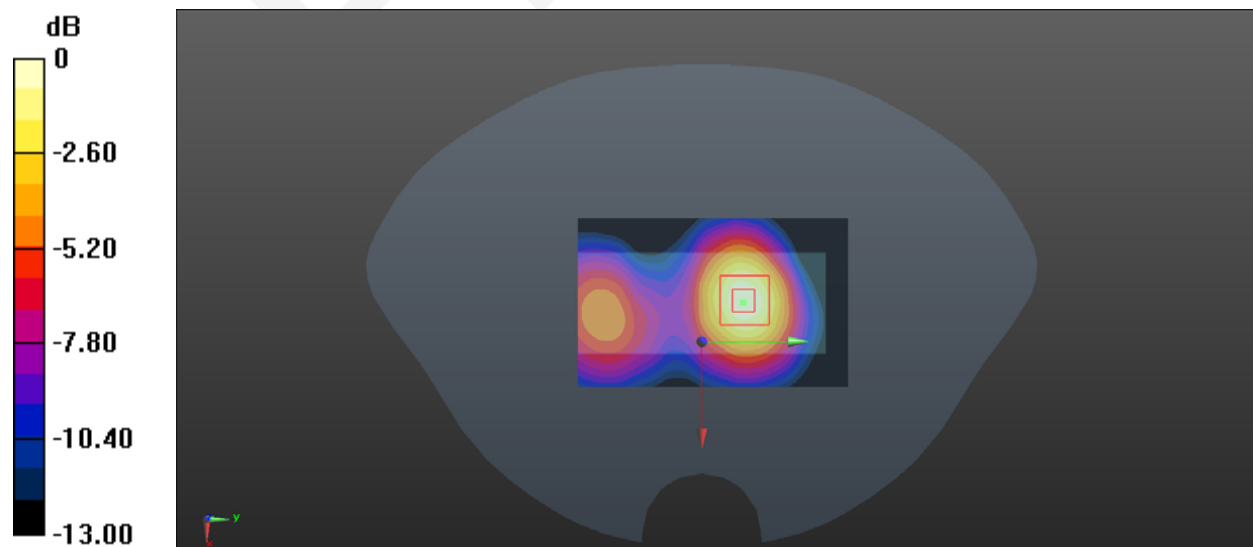

0 dB = 1.37 W/kg = 1.37 dBW/kg

Test Laboratory: Bay Area Compliance Labs Corp.(Dongguan)

Test Plot 5#:WCDMA 850 Left-Cheek Low Channel

DUT: Mobile Phone; Type: E245S;

Communication System: UID 0, BAND V (0); Frequency: 826.4 MHz;Duty Cycle: 1:1

Medium parameters used: $f = 826.4 \text{ MHz}$; $\sigma = 0.91 \text{ S/m}$; $\epsilon_r = 41.06$; $\rho = 1000 \text{ kg/m}^3$

Phantom section: Left Section

DASY5 Configuration:

- Probe: EX3DV4 - SN7329; ConvF(9.52, 9.52, 9.52); Calibrated: 2015/2/5;
- Sensor-Surface: 4mm (Mechanical Surface Detection)
- Electronics: DAE4 Sn1459; Calibrated: 2015/1/26
- Phantom: SAM (30deg probe tilt) with CRP v5.0_20150321; Type: QD000P40CD; Serial: TP:1874
- Measurement SW: DASY52, Version 52.8 (8);

Head/WCDMA 850 Left Cheek/Area Scan (51x81x1): Interpolated grid: $dx=1.500 \text{ mm}$, $dy=1.500 \text{ mm}$

Maximum value of SAR (interpolated) = 0.587 W/kg

Head/WCDMA 850 Left Cheek/Zoom Scan (7x7x7)/Cube 0: Measurement grid: $dx=5\text{mm}$, $dy=5\text{mm}$, $dz=5\text{mm}$

Reference Value = 11.458 V/m; Power Drift = 0.14 dB

Peak SAR (extrapolated) = 0.830 W/kg

SAR(1 g) = 0.578 W/kg; SAR(10 g) = 0.390 W/kg

Maximum value of SAR (measured) = 0.615 W/kg

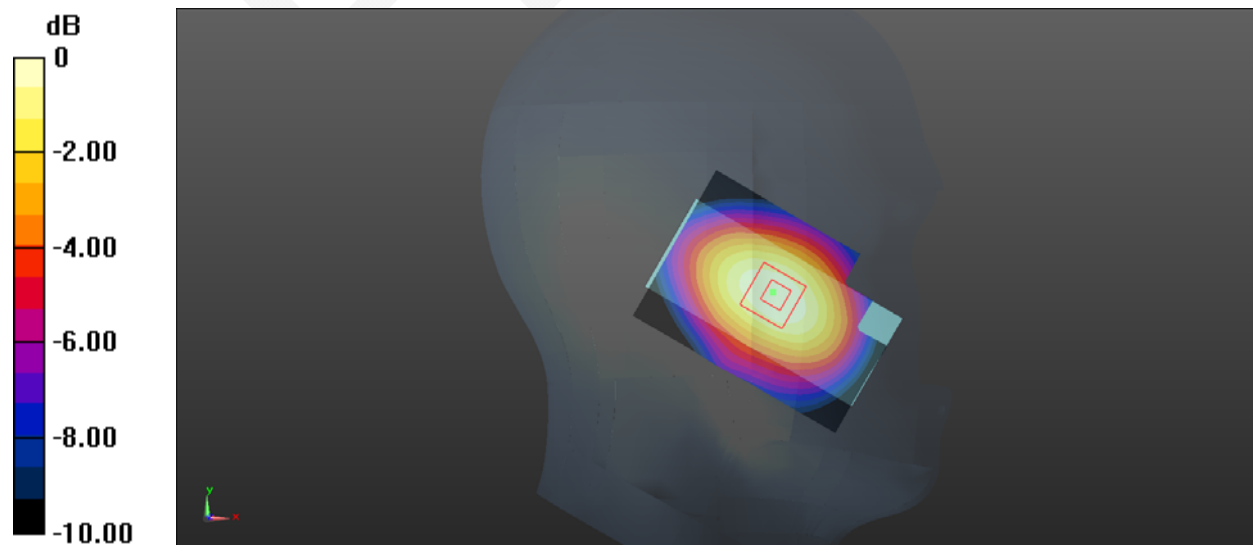

0 dB = 0.615 W/kg = -2.11 dBW/kg

Test Laboratory: Bay Area Compliance Labs Corp.(Dongguan)

Test Plot 6#:WCDMA 850 Back Low Channel

DUT: Mobile Phone; Type: E245S;

Communication System: UID 0, BAND V (0); Frequency: 826.4 MHz;Duty Cycle: 1:1

Medium parameters used: $f = 826.4 \text{ MHz}$; $\sigma = 0.95 \text{ S/m}$; $\epsilon_r = 53.82$; $\rho = 1000 \text{ kg/m}^3$

Phantom section: Flat Section

DASY5 Configuration:

- Probe: EX3DV4 - SN7329; ConvF(9.17, 9.17, 9.17); Calibrated: 2015/2/5;
- Sensor-Surface: 4mm (Mechanical Surface Detection)
- Electronics: DAE4 Sn1459; Calibrated: 2015/1/26
- Phantom: SAM (30deg probe tilt) with CRP v5.0_20150321; Type: QD000P40CD; Serial: TP:1874
- Measurement SW: DASY52, Version 52.8 (8);

Body/WCDMA 850 Back/Area Scan (51x81x1): Interpolated grid: $dx=1.500 \text{ mm}$, $dy=1.500 \text{ mm}$

Maximum value of SAR (interpolated) = 0.613 W/kg

Body/WCDMA 850 Back/Zoom Scan (7x7x7)/Cube 0: Measurement grid: $dx=5\text{mm}$, $dy=5\text{mm}$, $dz=5\text{mm}$

Reference Value = 24.06 V/m; Power Drift = -0.07 dB

Peak SAR (extrapolated) = 0.733 W/kg

SAR(1 g) = 0.562 W/kg; SAR(10 g) = 0.386 W/kg

Maximum value of SAR (measured) = 0.592 W/kg

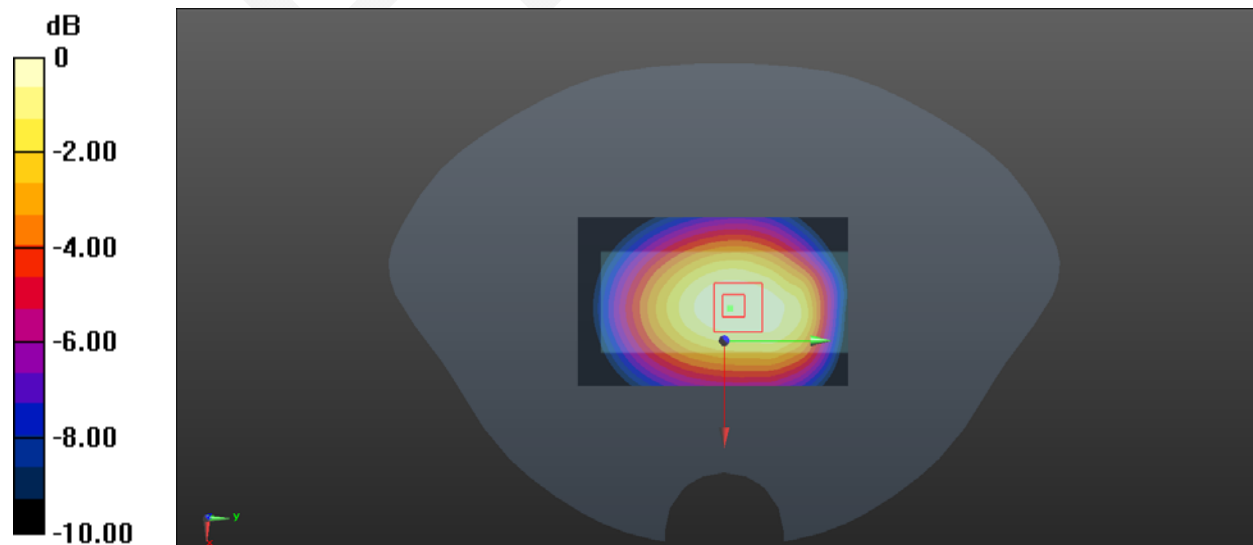

0 dB = 0.592 W/kg = -2.28 dBW/kg

Test Laboratory: Bay Area Compliance Labs Corp.(Dongguan)

Test Plot 7#:WCDMA 1900 Left Cheek Low Channel

DUT: Mobile Phone; Type: E245S;

Communication System: UID 0, BAND II (0); Frequency: 1852.4 MHz;Duty Cycle: 1:1

Medium parameters used: $f = 1852.4 \text{ MHz}$; $\sigma = 1.37 \text{ S/m}$; $\epsilon_r = 39.65$; $\rho = 1000 \text{ kg/m}^3$

Phantom section: Left Section

DASY5 Configuration:

- Probe: EX3DV4 - SN7329; ConvF(7.88, 7.88, 7.88); Calibrated: 2015/2/5;
- Sensor-Surface: 4mm (Mechanical Surface Detection)
- Electronics: DAE4 Sn1459; Calibrated: 2015/1/26
- Phantom: SAM (30deg probe tilt) with CRP v5.0_20150321; Type: QD000P40CD; Serial: TP:1874
- Measurement SW: DASY52, Version 52.8 (8);

Head/WCDMA 1900 Left Cheek /Area Scan (51x71x1): Interpolated grid: $dx=1.500 \text{ mm}$, $dy=1.500 \text{ mm}$

Maximum value of SAR (interpolated) = 0.822 W/kg

Head/WCDMA 1900 Left Cheek /Zoom Scan (7x7x7)/Cube 0: Measurement grid: $dx=5\text{mm}$, $dy=5\text{mm}$, $dz=5\text{mm}$

Reference Value = 12.084 V/m; Power Drift = 0.06 dB

Peak SAR (extrapolated) = 1.026 W/kg

SAR(1 g) = 0.693 W/kg; SAR(10 g) = 0.395 W/kg

Maximum value of SAR (measured) = 0.762 W/kg

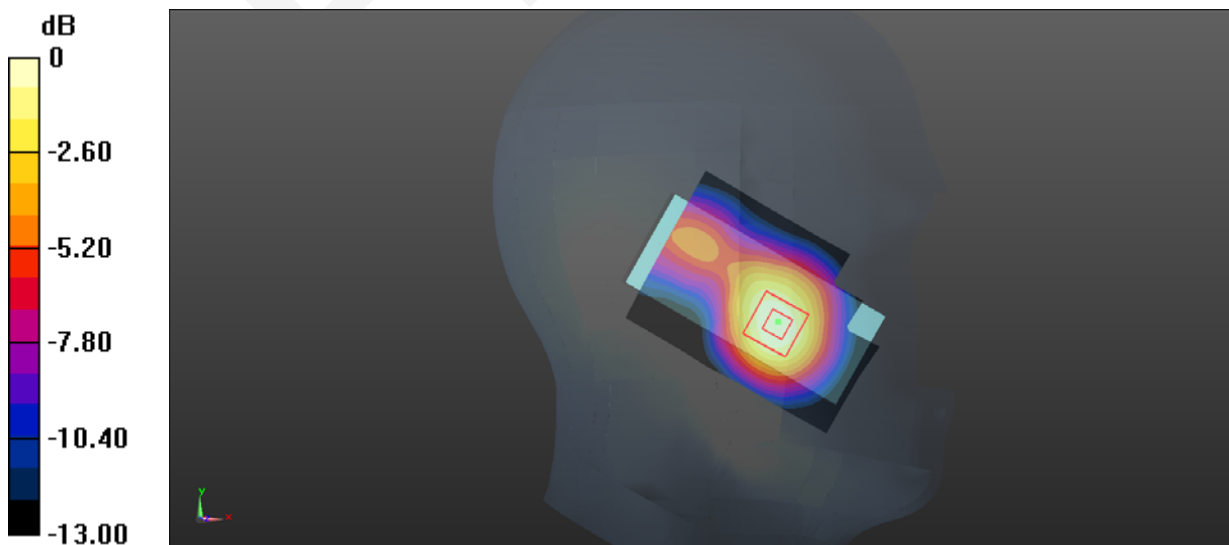

0 dB = 0.762 W/kg = -1.18 dBW/kg

Test Laboratory: Bay Area Compliance Labs Corp.(Dongguan)

Test Plot 8#:WCDMA 1900 Back Low Channel

DUT: Mobile Phone; Type: E245S;

Communication System: UID 0, BAND II (0); Frequency: 1852.4 MHz;Duty Cycle: 1:1

Medium parameters used: $f = 1852.4 \text{ MHz}$; $\sigma = 1.50 \text{ S/m}$; $\epsilon_r = 51.82$; $\rho = 1000 \text{ kg/m}^3$

Phantom section: Flat Section

DASY5 Configuration:

- Probe: EX3DV4 - SN7329; ConvF(7.56, 7.56, 7.56); Calibrated: 2015/2/5;
- Sensor-Surface: 4mm (Mechanical Surface Detection)
- Electronics: DAE4 Sn1459; Calibrated: 2015/1/26
- Phantom: SAM (30deg probe tilt) with CRP v5.0_20150321; Type: QD000P40CD; Serial: TP:1874
- Measurement SW: DASY52, Version 52.8 (8);

Body/WCDMA 1900 Back/Area Scan (51x81x1): Interpolated grid: $dx=1.500 \text{ mm}$, $dy=1.500 \text{ mm}$

Maximum value of SAR (interpolated) = 0.559 W/kg

Body/WCDMA 1900 Back/Zoom Scan (7x7x7)/Cube 0: Measurement grid: $dx=5\text{mm}$, $dy=5\text{mm}$, $dz=5\text{mm}$

Reference Value = 11.57 V/m; Power Drift = -0.02 dB

Peak SAR (extrapolated) = 0.772 W/kg

SAR(1 g) = 0.496 W/kg; SAR(10 g) = 0.274 W/kg

Maximum value of SAR (measured) = 0.569 W/kg

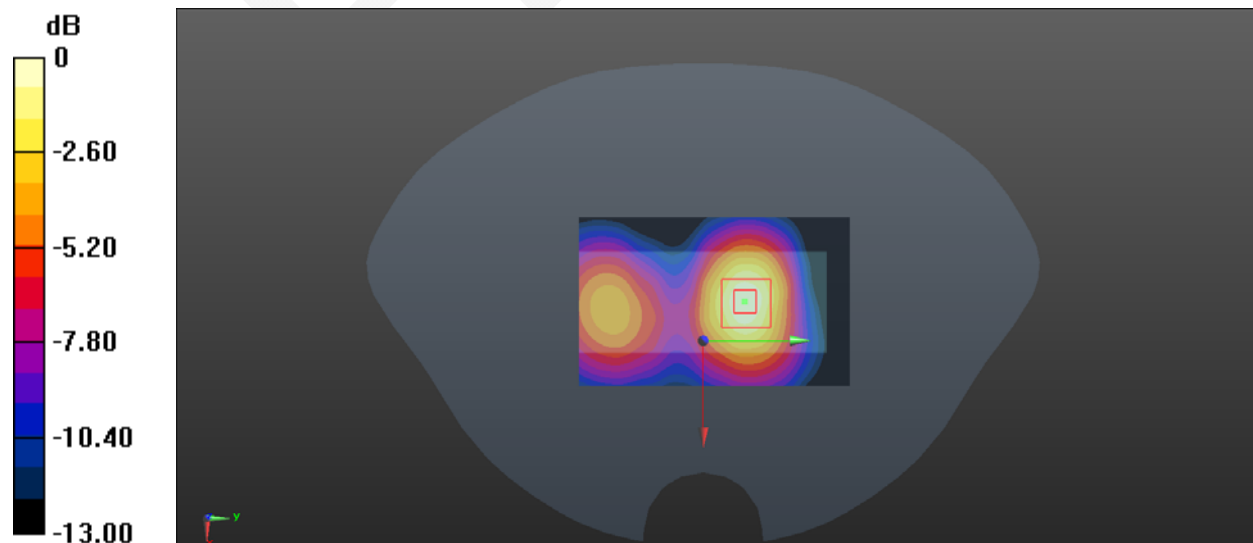

0 dB = 0.569 W/kg = -2.45 dBW/kg

APPENDIX A MEASUREMENT UNCERTAINTY

The uncertainty budget has been determined for the measurement system and is given in the following Table.

Measurement uncertainty evaluation for IEEE1528-2013 SAR test

Source of uncertainty	Tolerance/uncertainty ± %	Probability distribution	Disisor	ci (1 g)	ci (10 g)	Standard uncertainty ± %, (1 g)	Standard uncertainty ± %, (10 g)
Measurement system							
Probe calibration	6.55	N	1	1	1	6.6	6.6
Axial Isotropy	4.7	R	√3	1	1	2.7	2.7
Hemispherical Isotropy	9.6	R	√3	0	0	0.0	0.0
Boundary effect	1.0	R	√3	1	1	0.6	0.6
Linearity	4.7	R	√3	1	1	2.7	2.7
Detection limits	1.0	R	√3	1	1	0.6	0.6
Readout electronics	0.3	N	1	1	1	0.3	0.3
Response time	0.0	R	√3	1	1	0.0	0.0
Integration time	0.0	R	√3	1	1	0.0	0.0
RF ambientconditions – noise	1.0	R	√3	1	1	0.6	0.6
RF ambient conditions–reflections	1.0	R	√3	1	1	0.6	0.6
Probe positioner mech. Restrictions	0.8	R	√3	1	1	0.5	0.5
Probe positioning with respect to phantom shell	6.7	R	√3	1	1	3.9	3.9
Post-processing	2.0	R	√3	1	1	1.2	1.2
Test sample related							
Test sample positioning	2.8	N	1	1	1	2.8	2.8
Device holder uncertainty	6.3	N	1	1	1	6.3	6.3
Drift of output power	5.0	R	√3	1	1	2.9	2.9
Phantom and set-up							
Phantom uncertainty (shape and thickness tolerances)	4.0	R	√3	1	1	2.3	2.3
Liquid conductivity target)	5.0	R	√3	0.64	0.43	1.8	1.2
Liquid conductivity meas.)	2.5	N	1	0.64	0.43	1.6	1.1
Liquid permittivity target)	5.0	R	√3	0.6	0.49	1.7	1.4
Liquid permittivity meas.)	2.5	N	1	0.6	0.49	1.5	1.2
Combined standard uncertainty		RSS				12.2	12.0
Expanded uncertainty 95 % confidence interval)						24.3	23.9

Measurement uncertainty evaluation for IEC62209-2 SAR test

Source of uncertainty	Tolerance/uncertainty ± %	Probability distribution	Disisor	ci (1 g)	ci (10 g)	Standard uncertainty ± %, (1 g)	Standard uncertainty ± %, (10 g)
Measurement system							
Probe calibration	6.55	N	1	1	1	6.6	6.6
Axial Isotropy	4.7	R	√3	1	1	2.7	2.7
Hemispherical Isotropy	9.6	R	√3	0	0	0.0	0.0
Linearity	4.7	R	√3	1	1	2.7	2.7
Modulation Response	0.0	R	√3	1	1	0.0	0.0
Detection limits	1.0	R	√3	1	1	0.6	0.6
Boundary effect	1.0	R	√3	1	1	0.6	0.6
Readout electronics	0.3	N	1	1	1	0.3	0.3
Response time	0.0	R	√3	1	1	0.0	0.0
Integration time	0.0	R	√3	1	1	0.0	0.0
RF ambient conditions – noise	1.0	R	√3	1	1	0.6	0.6
RF ambient conditions–reflections	1.0	R	√3	1	1	0.6	0.6
Probe positioner mech. Restrictions	0.8	R	√3	1	1	0.5	0.5
Probe positioning with respect to phantom shell	6.7	R	√3	1	1	3.9	3.9
Post-processing	2.0	R	√3	1	1	1.2	1.2
Test sample related							
Device holder Uncertainty	6.3	N	1	1	1	6.3	6.3
Test sample positioning	2.8	N	1	1	1	2.8	2.8
Power scaling	4.5	R	√3	1	1	2.6	2.6
Drift of output power	5.0	R	√3	1	1	2.9	2.9
Phantom and set-up							
Phantom uncertainty (shape and thickness tolerances)	4.0	R	√3	1	1	2.3	2.3
Algorithm for correcting SAR for deviations in permittivity and conductivity	1.9	N	1	1	0.84	1.1	0.9
Liquid conductivity (meas.)	2.5	N	1	0.64	0.43	1.6	1.1
Liquid permittivity (meas.)	2.5	N	1	0.6	0.49	1.5	1.2
Temp. unc. - Conductivity	1.7	R	√3	0.78	0.71	0.8	0.7
Temp. unc. - Permittivity	0.3	R	√3	0.23	0.26	0.0	0.0
Combined standard uncertainty		RSS				12.2	12.1
Expanded uncertainty 95 % confidence interval)						24.5	24.2

APPENDIX B – PROBE CALIBRATION CERTIFICATES

**Calibration Laboratory of
Schmid & Partner
Engineering AG**
Zeughausstrasse 43, 8004 Zurich, Switzerland



S Schweizerischer Kalibrierdienst
C Service suisse d'étalonnage
S Servizio svizzero di taratura
S Swiss Calibration Service

Accredited by the Swiss Accreditation Service (SAS)
The Swiss Accreditation Service is one of the signatories to the EA
Multilateral Agreement for the recognition of calibration certificates

Accreditation No.: **SCS 0108**

Client **BACL China (Vitec)**

Certificate No: **EX3-7329_Feb15**

CALIBRATION CERTIFICATE

Object **EX3DV4 - SN:7329**

Calibration procedure(s) **QA CAL-01.v9, QA CAL-23.v5, QA CAL-25.v6
Calibration procedure for dosimetric E-field probes**

Calibration date: **February 5, 2015**

This calibration certificate documents the traceability to national standards, which realize the physical units of measurements (SI).
The measurements and the uncertainties with confidence probability are given on the following pages and are part of the certificate.

All calibrations have been conducted in the closed laboratory facility: environment temperature (22 ± 3)°C and humidity < 70%.

Calibration Equipment used (M&TE critical for calibration)

Primary Standards	ID	Cal Date (Certificate No.)	Scheduled Calibration
Power meter E4419B	GB41293874	03-Apr-14 (No. 217-01911)	Apr-15
Power sensor E4412A	MY41498087	03-Apr-14 (No. 217-01911)	Apr-15
Reference 3 dB Attenuator	SN: S5054 (3c)	03-Apr-14 (No. 217-01915)	Apr-15
Reference 20 dB Attenuator	SN: S5277 (20x)	03-Apr-14 (No. 217-01919)	Apr-15
Reference 30 dB Attenuator	SN: S5129 (30b)	03-Apr-14 (No. 217-01920)	Apr-15
Reference Probe ES3DV2	SN: 3013	30-Dec-14 (No. ES3-3013_Dec14)	Dec-15
DAE4	SN: 660	14-Jan-15 (No. DAE4-660_Jan15)	Jan-16
Secondary Standards	ID	Check Date (in house)	Scheduled Check
RF generator HP 8648C	US3642UD1700	4-Aug-99 (in house check Apr-13)	In house check: Apr-16
Network Analyzer HP 8753E	US37390585	18-Oct-01 (in house check Oct-14)	In house check: Oct-15

	Name	Function	Signature
Calibrated by:	Claudio Leubler	Laboratory Technician	
Approved by:	Katja Pokovic	Technical Manager	

Issued: February 9, 2015

This calibration certificate shall not be reproduced except in full without written approval of the laboratory.

**Calibration Laboratory of
Schmid & Partner
Engineering AG**
Zeughausstrasse 43, 8004 Zurich, Switzerland



S Schweizerischer Kalibrierdienst
C Service suisse d'étalonnage
S Servizio svizzero di taratura
S Swiss Calibration Service

Accredited by the Swiss Accreditation Service (SAS)
The Swiss Accreditation Service is one of the signatories to the EA
Multilateral Agreement for the recognition of calibration certificates

Accreditation No.: **SCS 0108**

Glossary:

TSL	tissue simulating liquid
NORM _{x,y,z}	sensitivity in free space
ConvF	sensitivity in TSL / NORM _{x,y,z}
DCP	diode compression point
CF	crest factor (1/duty_cycle) of the RF signal
A, B, C, D	modulation dependent linearization parameters
Polarization φ	φ rotation around probe axis
Polarization θ	θ rotation around an axis that is in the plane normal to probe axis (at measurement center), i.e., θ = 0 is normal to probe axis
Connector Angle	information used in DASY system to align probe sensor X to the robot coordinate system

Calibration is Performed According to the Following Standards:

- a) IEEE Std 1528-2013, "IEEE Recommended Practice for Determining the Peak Spatial-Averaged Specific Absorption Rate (SAR) in the Human Head from Wireless Communications Devices: Measurement Techniques", June 2013
- b) IEC 62209-1, "Procedure to measure the Specific Absorption Rate (SAR) for hand-held devices used in close proximity to the ear (frequency range of 300 MHz to 3 GHz)", February 2005

Methods Applied and Interpretation of Parameters:

- **NORM_{x,y,z}**: Assessed for E-field polarization θ = 0 (f ≤ 900 MHz in TEM-cell; f > 1800 MHz: R22 waveguide). NORM_{x,y,z} are only intermediate values, i.e., the uncertainties of NORM_{x,y,z} does not affect the E²-field uncertainty inside TSL (see below ConvF).
- **NORM(f)_{x,y,z} = NORM_{x,y,z} * frequency_response** (see Frequency Response Chart). This linearization is implemented in DASY4 software versions later than 4.2. The uncertainty of the frequency response is included in the stated uncertainty of ConvF.
- **DCP_{x,y,z}**: DCP are numerical linearization parameters assessed based on the data of power sweep with CW signal (no uncertainty required). DCP does not depend on frequency nor media.
- **PAR**: PAR is the Peak to Average Ratio that is not calibrated but determined based on the signal characteristics
- **A_{x,y,z}; B_{x,y,z}; C_{x,y,z}; D_{x,y,z}; VR_{x,y,z}**: A, B, C, D are numerical linearization parameters assessed based on the data of power sweep for specific modulation signal. The parameters do not depend on frequency nor media. VR is the maximum calibration range expressed in RMS voltage across the diode.
- **ConvF and Boundary Effect Parameters**: Assessed in flat phantom using E-field (or Temperature Transfer Standard for f ≤ 800 MHz) and inside waveguide using analytical field distributions based on power measurements for f > 800 MHz. The same setups are used for assessment of the parameters applied for boundary compensation (alpha, depth) of which typical uncertainty values are given. These parameters are used in DASY4 software to improve probe accuracy close to the boundary. The sensitivity in TSL corresponds to NORM_{x,y,z} * ConvF whereby the uncertainty corresponds to that given for ConvF. A frequency dependent ConvF is used in DASY version 4.4 and higher which allows extending the validity from ± 50 MHz to ± 100 MHz.
- **Spherical isotropy (3D deviation from isotropy)**: in a field of low gradients realized using a flat phantom exposed by a patch antenna.
- **Sensor Offset**: The sensor offset corresponds to the offset of virtual measurement center from the probe tip (on probe axis). No tolerance required.
- **Connector Angle**: The angle is assessed using the information gained by determining the NORM_x (no uncertainty required).

EX3DV4 – SN:7329

February 5, 2015

Probe EX3DV4

SN:7329

Manufactured: December 11, 2014
Calibrated: February 5, 2015

Calibrated for DASY/EASY Systems
(Note: non-compatible with DASY2 system!)

EX3DV4- SN:7329

February 5, 2015

DASY/EASY - Parameters of Probe: EX3DV4 - SN:7329

Basic Calibration Parameters

	Sensor X	Sensor Y	Sensor Z	Unc (k=2)
Norm ($\mu\text{V}/(\text{V}/\text{m})^2$) ^A	0.48	0.43	0.46	± 10.1 %
DCP (mV) ^B	96.7	97.6	94.2	

Modulation Calibration Parameters

UID	Communication System Name		A dB	B dB $\sqrt{\mu\text{V}}$	C	D dB	VR mV	Unc ^C (k=2)
0	CW	X	0.0	0.0	1.0	0.00	137.9	±3.0 %
		Y	0.0	0.0	1.0		147.0	
		Z	0.0	0.0	1.0		150.5	

The reported uncertainty of measurement is stated as the standard uncertainty of measurement multiplied by the coverage factor k=2, which for a normal distribution corresponds to a coverage probability of approximately 95%.

^A The uncertainties of NormX,Y,Z do not affect the E²-field uncertainty inside TSL (see Pages 5 and 6).

^B Numerical linearization parameter: uncertainty not required.

^C Uncertainty is determined using the max. deviation from linear response applying rectangular distribution and is expressed for the square of the field value.

EX3DV4- SN:7329

February 5, 2015

DASY/EASY - Parameters of Probe: EX3DV4 - SN:7329

Calibration Parameter Determined in Head Tissue Simulating Media

f (MHz) ^c	Relative Permittivity ^f	Conductivity (S/m) ^f	ConvF X	ConvF Y	ConvF Z	Alpha ^g	Depth ^d (mm)	Unct. (k=2)
900	41.5	0.97	9.52	9.52	9.52	0.40	0.86	± 12.0 %
1750	40.1	1.37	8.12	8.12	8.12	0.29	0.90	± 12.0 %
1900	40.0	1.40	7.88	7.88	7.88	0.68	0.61	± 12.0 %
2450	39.2	1.80	7.06	7.06	7.06	0.33	0.84	± 12.0 %

^c Frequency validity above 300 MHz of ± 100 MHz only applies for DASY v4.4 and higher (see Page 2), else it is restricted to ± 50 MHz. The uncertainty is the RSS of the ConvF uncertainty at calibration frequency and the uncertainty for the indicated frequency band. Frequency validity below 300 MHz is ± 10, 25, 40, 50 and 70 MHz for ConvF assessments at 30, 64, 128, 150 and 220 MHz respectively. Above 5 GHz frequency validity can be extended to ± 110 MHz.

^f At frequencies below 3 GHz, the validity of tissue parameters (c and σ) can be relaxed to ± 10% if liquid compensation formula is applied to measured SAR values. At frequencies above 3 GHz, the validity of tissue parameters (c and σ) is restricted to ± 5%. The uncertainty is the RSS of the ConvF uncertainty for indicated target tissue parameters.

^g Alpha/Depth are determined during calibration. SPEAG warrants that the remaining deviation due to the boundary effect after compensation is always less than ± 1% for frequencies below 3 GHz and below ± 2% for frequencies between 3-6 GHz at any distance larger than half the probe tip diameter from the boundary.

EX3DV4- SN:7329

February 5, 2015

DASY/EASY - Parameters of Probe: EX3DV4 - SN:7329

Calibration Parameter Determined in Body Tissue Simulating Media

f (MHz) ^C	Relative Permittivity ^F	Conductivity (S/m) ^F	ConvF X	ConvF Y	ConvF Z	Alpha ^G	Depth ^G (mm)	Unct. (k=2)
900	55.0	1.05	9.17	9.17	9.17	0.41	0.90	± 12.0 %
1750	53.4	1.49	7.85	7.85	7.85	0.70	0.64	± 12.0 %
1900	53.3	1.52	7.56	7.56	7.56	0.56	0.70	± 12.0 %
2450	52.7	1.95	7.20	7.20	7.20	0.78	0.59	± 12.0 %

^C Frequency validity above 300 MHz of ± 100 MHz only applies for DASY v4.4 and higher (see Page 2), else it is restricted to ± 50 MHz. The uncertainty is the RSS of the ConvF uncertainty at calibration frequency and the uncertainty for the indicated frequency band. Frequency validity below 300 MHz is ± 10, 25, 40, 50 and 70 MHz for ConvF assessments at 30, 64, 128, 150 and 220 MHz respectively. Above 5 GHz frequency validity can be extended to ± 110 MHz.

^F At frequencies below 3 GHz, the validity of tissue parameters (ϵ and σ) can be relaxed to ± 10% if liquid compensation formula is applied to measured SAR values. At frequencies above 3 GHz, the validity of tissue parameters (ϵ and σ) is restricted to ± 5%. The uncertainty is the RSS of the ConvF uncertainty for indicated target tissue parameters.

^G Alpha/Depth are determined during calibration. SPEAG warrants that the remaining deviation due to the boundary effect after compensation is always less than ± 1% for frequencies below 3 GHz and below ± 2% for frequencies between 3-6 GHz at any distance larger than half the probe tip diameter from the boundary.

EX3DV4- SN:7329

February 5, 2015

Frequency Response of E-Field (TEM-Cell:ifi110 EXX, Waveguide: R22)

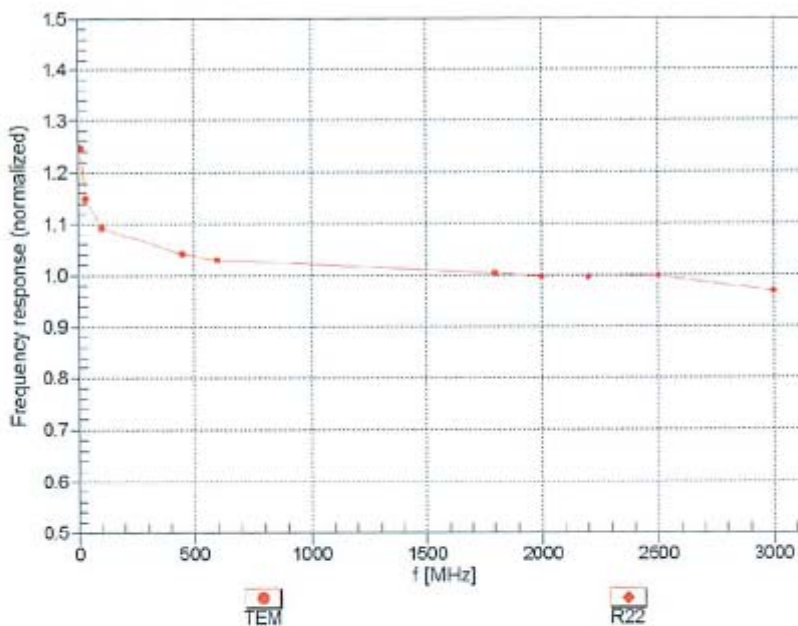

Uncertainty of Frequency Response of E-field: $\pm 6.3\%$ (k=2)

EX3DV4- SN:7329

February 5, 2015

Receiving Pattern (ϕ), $\vartheta = 0^\circ$

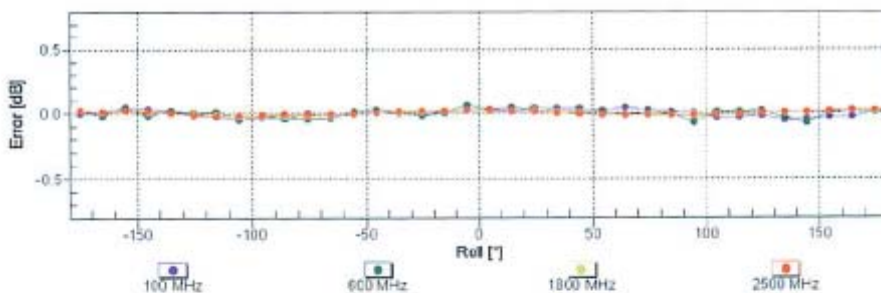
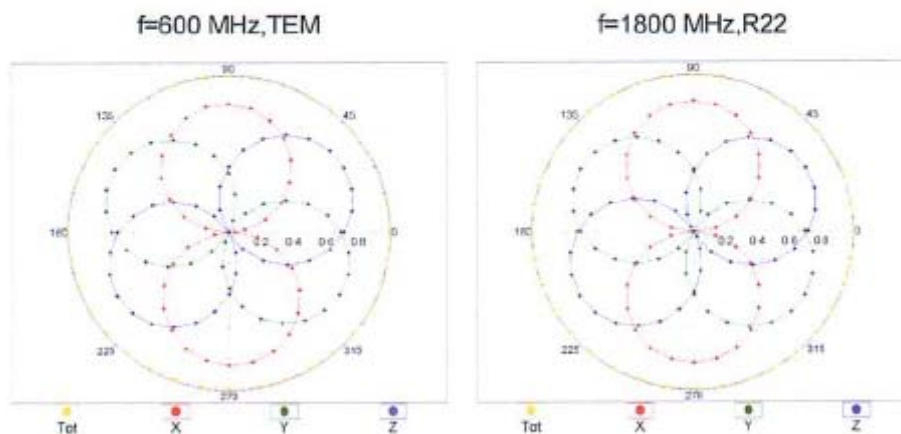

Uncertainty of Axial Isotropy Assessment: $\pm 0.5\%$ ($k=2$)

EX3DV4- SN:7329

February 5, 2015

Dynamic Range $f(SAR_{head})$ (TEM cell, $f_{eval} = 1900$ MHz)

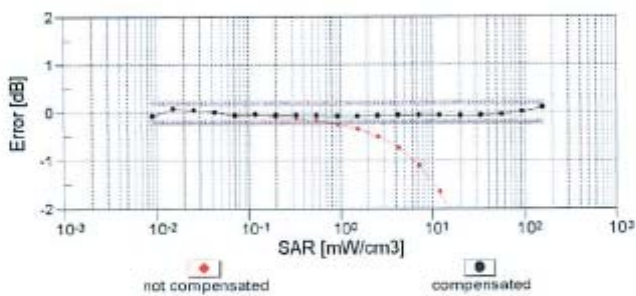
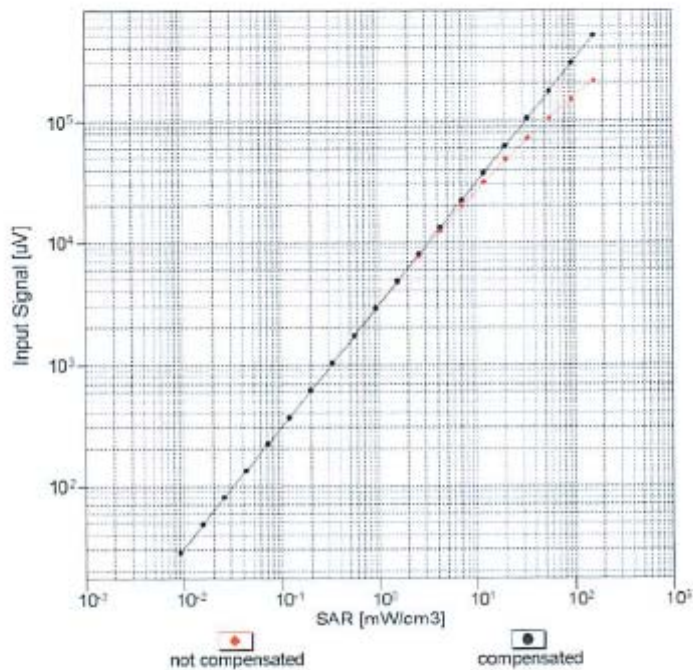

Uncertainty of Linearity Assessment: $\pm 0.6\%$ (k=2)

EX3DV4- SN:7329

February 5, 2015

Conversion Factor Assessment

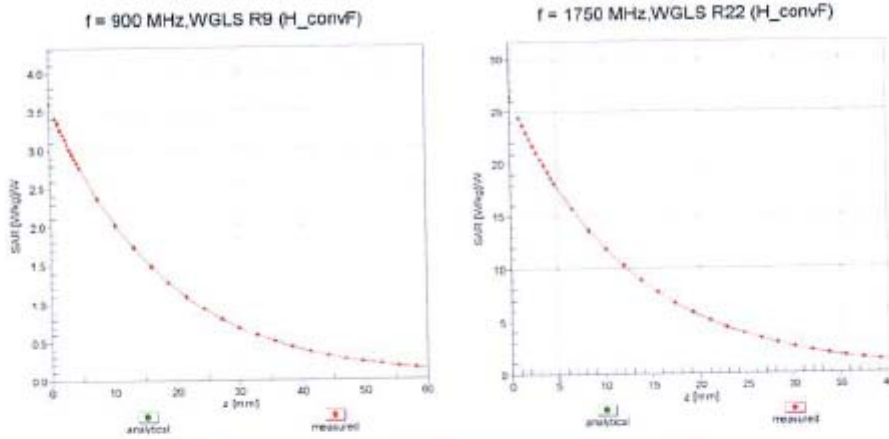

Deviation from Isotropy in Liquid Error (ϕ, θ), f = 900 MHz

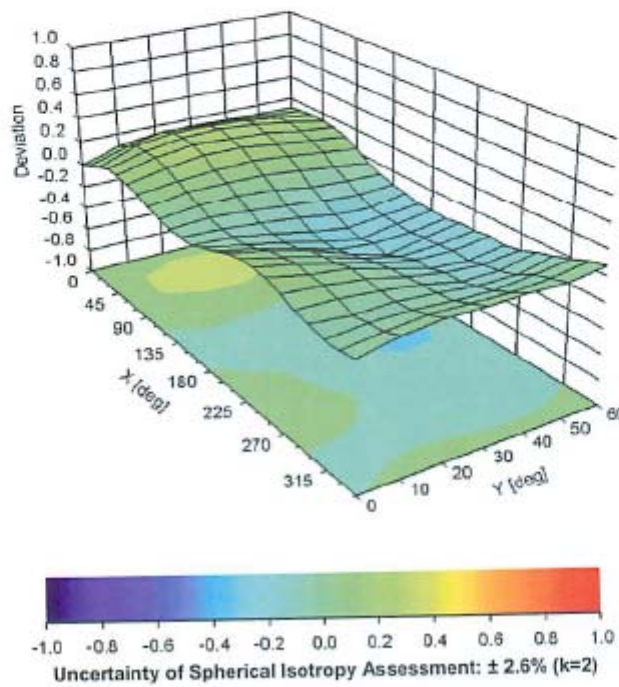

EX3DV4- SN:7329

February 5, 2015

DASY/EASY - Parameters of Probe: EX3DV4 - SN:7329**Other Probe Parameters**

Sensor Arrangement	Triangular
Connector Angle (°)	24.5
Mechanical Surface Detection Mode	enabled
Optical Surface Detection Mode	disabled
Probe Overall Length	337 mm
Probe Body Diameter	10 mm
Tip Length	9 mm
Tip Diameter	2.5 mm
Probe Tip to Sensor X Calibration Point	1 mm
Probe Tip to Sensor Y Calibration Point	1 mm
Probe Tip to Sensor Z Calibration Point	1 mm
Recommended Measurement Distance from Surface	1.4 mm

APPENDIX C DIPOLE CALIBRATION CERTIFICATES

NCL CALIBRATION LABORATORIES

Calibration File No: DC-1599
Project Number: BAC-dipole-cal-5779

CERTIFICATE OF CALIBRATION

It is certified that the equipment identified below has been calibrated in the
NCL CALIBRATION LABORATORIES by qualified personnel following recognized
procedures and using transfer standards traceable to NRC/NIST.

Validation Dipole(Head and Body)

Manufacturer: APREL Laboratories
Part number: ALS-D-835-S-2
Frequency: 835 MHz
Serial No: 180-00558

Customer: Bay Area Compliance Laboratory (China)

Calibrated: 8th October 2014
Released on: 8th October 2014

This Calibration Certificate is Incomplete Unless Accompanied with the Calibration Results Summary

Released By: _____



Art Brennan, Quality Manager

NCL CALIBRATION LABORATORIES

Suite 102, 303 Terry Fox Dr.
Kanata, ONTARIO
CANADA K2K 3J1

Division of APREL Lab.
TEL: (613) 435-8300
FAX: (613)435-8306

NCL Calibration Laboratories

Division of APREL Laboratories.

Conditions

Dipole 180-00558 was received with a damaged connection for a re-calibration.

Ambient Temperature of the Laboratory: 22 °C +/- 0.5°C
Temperature of the Tissue: 21 °C +/- 0.5°C

Attestation

The below named signatories have conducted the calibration and review of the data which is presented in this calibration report.

We the undersigned attest that to the best of our knowledge the calibration of this subject has been accurately conducted and that all information contained within the results pages have been reviewed for accuracy.



Art Brennan, Quality Manager



Maryna Nesterova Calibration Engineer

Primary Measurement Standards

Instrument	Serial Number	Cal due date
Tektronix USB Power Meter	11C940	May 14, 2015
Network Analyzer Anritsu 37347C	002106	Feb. 20, 2015

This page has been reviewed for content and attested to by signature within this document.

NCL Calibration Laboratories

Division of APREL Laboratories.

Calibration Results Summary

The following results relate the Calibrated Dipole and should be used as a quick reference for the user.

Mechanical Dimensions

Length: 162.2 mm
 Height: 89.4 mm

Electrical Specification

Tissue	Frequency	SWR:	Return Loss	Impedance
Head	835 MHz	1.066 U	-30.344 dB	49.001 Ω
Body	835 MHz	1.089 U	-28.118 dB	53.117 Ω

System Validation Results

Tissue	Frequency	1 Gram	10 Gram	Peak
Head	835 MHz	9.773	6.174	14.713
Body	835 MHz	9.736	6.297	14.513

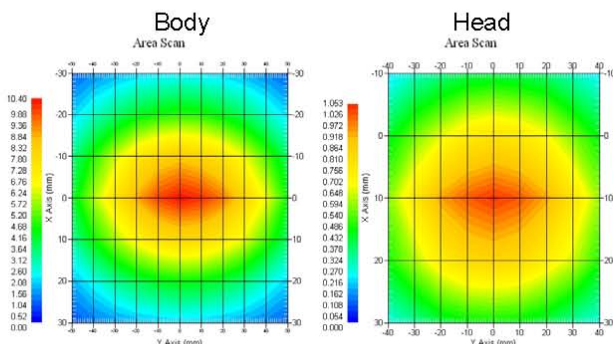

This page has been reviewed for content and attested to by signature within this document.

NCL Calibration Laboratories

Division of APREL Laboratories.

Introduction

This Calibration Report has been produced in line with the SSI Dipole Calibration Procedure SSI-TP-018-ALSAS. The results contained within this report are for Validation Dipole 180-00558. The calibration routine consisted of a three-step process. Step 1 was a mechanical verification of the dipole to ensure that it meets the mechanical specifications. Step 2 was an Electrical Calibration for the Validation Dipole, where the SWR, Impedance, and the Return loss were assessed. Step 3 involved a System Validation using the ALSAS-10U, along with APREL E-020 30 MHz to 6 GHz E-Field Probe Serial Number 225.

References

- IEC-62209 “Human exposure to radio frequency fields from hand-held and body-mounted wireless communication devices – Human models, instrumentation, and procedures”
- Part 2: “Procedure to determine the Specific Absorption Rate (SAR) for hand-held devices used in close proximity of the ear (frequency range of 30 MHz to 6 GHz)”
- TP-D01-032-E020-V2 E-Field probe calibration procedure
- D22-012-Tissue dielectric tissue calibration procedure
- D28-002-Dipole procedure for validation of SAR system using a dipole
- IEEE 1309 Draft Standard for Calibration of Electromagnetic Field Sensors and Probes, Excluding Antennas, from 9kHz to 40GHz

Conditions

Dipole 180-00558 was repaired prior to this calibration. The repair reliability depends upon correct usage of the dipole.

Ambient Temperature of the Laboratory: 22 °C +/- 0.5°C
Temperature of the Tissue: 20 °C +/- 0.5°C

Dipole Calibration uncertainty

The calibration uncertainty for the dipole is made up of various parameters presented below.

Mechanical	1%
Positioning Error	1.22%
Electrical	1.7%
Tissue	2.2%
Dipole Validation	2.2%
TOTAL	8.32% (16.64% K=2)

This page has been reviewed for content and attested to by signature within this document.

NCL Calibration Laboratories

Division of APREL Laboratories.

Dipole Calibration Results

Mechanical Verification

APREL Length	APREL Height	Measured Length	Measured Height
161.0 mm	89.8 mm	162.2 mm	89.4 mm

Electrical Verification

Tissue Type	Return Loss:	SWR:	Impedance:
Head	-30.344 dB	1.066 U	49.001 Ω
Body	-28.118 dB	1.089 U	53.117 Ω □

Tissue Validation

	Dielectric constant, ϵ_r	Conductivity, σ [S/m]
Head Tissue 835MHz	43.42	0.94
Body Tissue 835MHz	55.77	1.01

This page has been reviewed for content and attested to by signature within this document.

NCL Calibration Laboratories

Division of APREL Laboratories.

The Following Graphs are the results as displayed on the Vector Network Analyzer.

S11 Parameter Return Loss

Head Tissue: Frequency Range 0.817 to 0.848 GHz

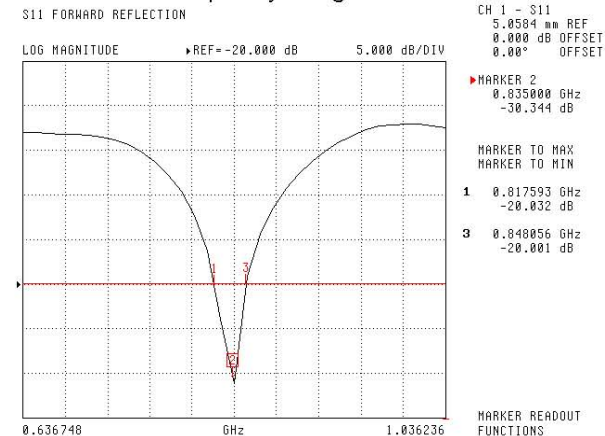

Body Tissue: Frequency Range 0.823 to 0.851 GHz

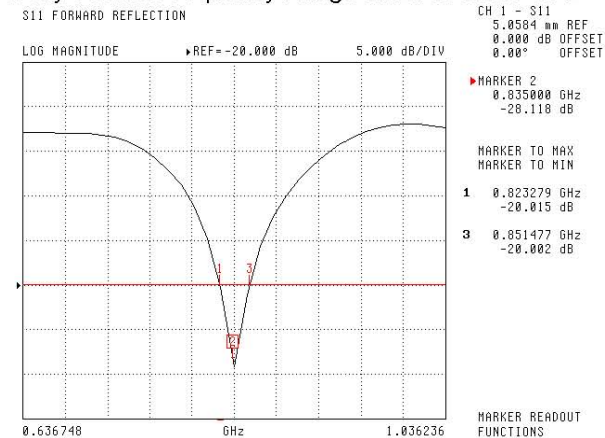

This page has been reviewed for content and attested to by signature within this document.

NCL Calibration Laboratories

Division of APREL Laboratories.

SWR

Head

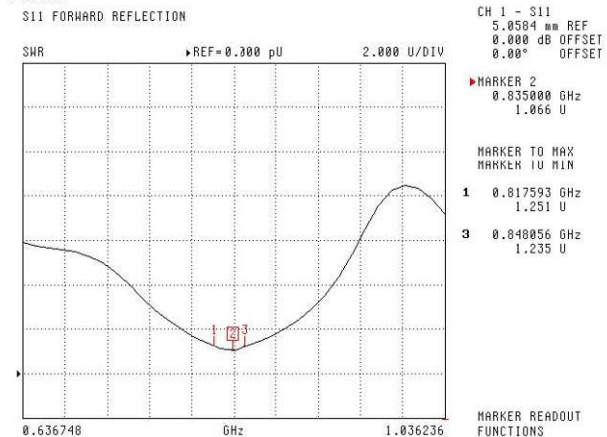

Body

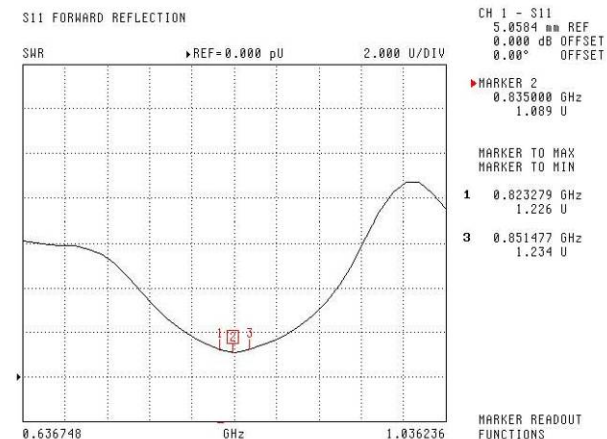

This page has been reviewed for content and attested to by signature within this document.

NCL Calibration Laboratories

Division of APREL Laboratories.

Smith Chart Dipole Impedance

Head

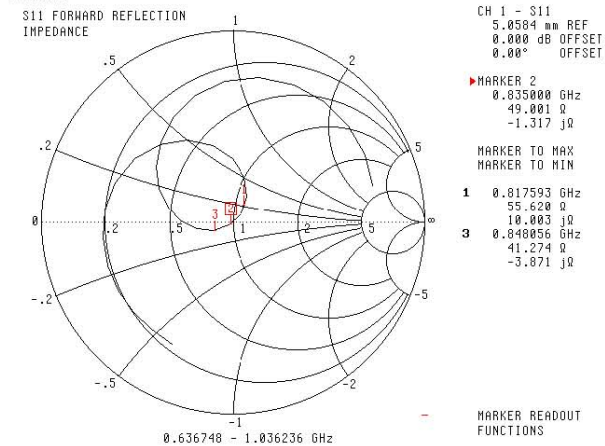

Body

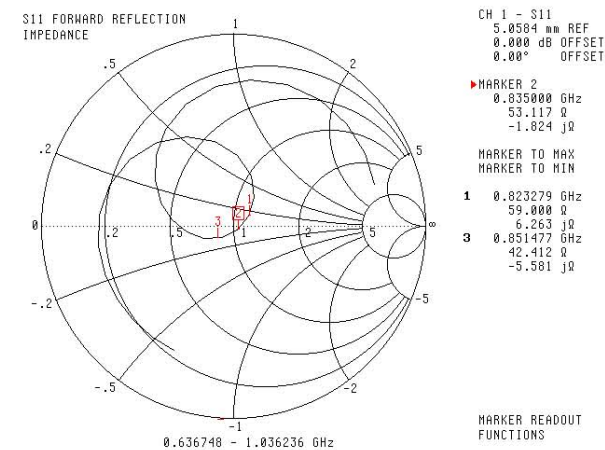

This page has been reviewed for content and attested to by signature within this document.

NCL Calibration Laboratories

Division of APREL Laboratories.

Test Equipment

The test equipment used during Probe Calibration, manufacturer, model number and, current calibration status are listed and located on the main APREL server R:\NCL\Calibration Equipment\Instrument List 2014.

This page has been reviewed for content and attested to by signature within this document.

9

NCL CALIBRATION LABORATORIES

Calibration File No: DC-1601
Project Number: BAC-dipole –cal-5779

CERTIFICATE OF CALIBRATION

It is certified that the equipment identified below has been calibrated in the
NCL CALIBRATION LABORATORIES by qualified personnel following recognized
procedures and using transfer standards traceable to NRC/NIST.

Validation Dipole (Head & Body)

Manufacturer: APREL Laboratories
Part number: ALS-D-1900-S-2
Frequency: 1900 MHz
Serial No: 210-00710

Customer: Bay Area Compliance Laboratory (China)

Calibrated: 9th October, 2014
Released on: 9th October, 2014

This Calibration Certificate is Incomplete Unless Accompanied with the Calibration Results Summary

Released By: 
Art Brennan, Quality Manager

NCL CALIBRATION LABORATORIES

Suite 102, 303 Terry Fox Dr.
Kanata, ONTARIO
CANADA K2K 3J1

Division of APREL Lab.
TEL: (613) 435-8300
FAX: (613)435-8306

NCL Calibration Laboratories

Division of APREL Laboratories.

Conditions

Dipole 210-00710 was received in good condition and was a re-calibration.

Ambient Temperature of the Laboratory: 22 °C +/- 0.5°C
Temperature of the Tissue: 21 °C +/- 0.5°C

Attestation

The below named signatories have conducted the calibration and review of the data which is presented in this calibration report.

We the undersigned attest that to the best of our knowledge the calibration of this subject has been accurately conducted and that all information contained within the results pages have been reviewed for accuracy.



 Art Brennan, Quality Manager



 Maryna Nesterova Calibration Engineer

Primary Measurement Standards

Instrument	Serial Number	Cal due date
Tektronix USB Power Meter	11C940	May 14, 2015
Network Analyzer Anritsu 37347C	002106	Feb. 20, 2015

This page has been reviewed for content and attested to by signature within this document.

NCL Calibration Laboratories

Division of APREL Laboratories.

Calibration Results Summary

The following results relate the Calibrated Dipole and should be used as a quick reference for the user.

Mechanical Dimensions

Length: 67.1 mm
Height: 38.9 mm

Electrical Specification

Tissue	Frequency	SWR:	Return Loss	Impedance
Head	1900MHz	1.084 U	-27.92 dB	52.247 Ω
Body	1900MHz	1.128 U	-24.40 dB	52.618 Ω

System Validation Results

Tissue	Frequency	1 Gram	10 Gram	Peak
Head	1900 MHz	39.481	20.44	73.364
Body	1900 MHz	39.715	20.552	73.565

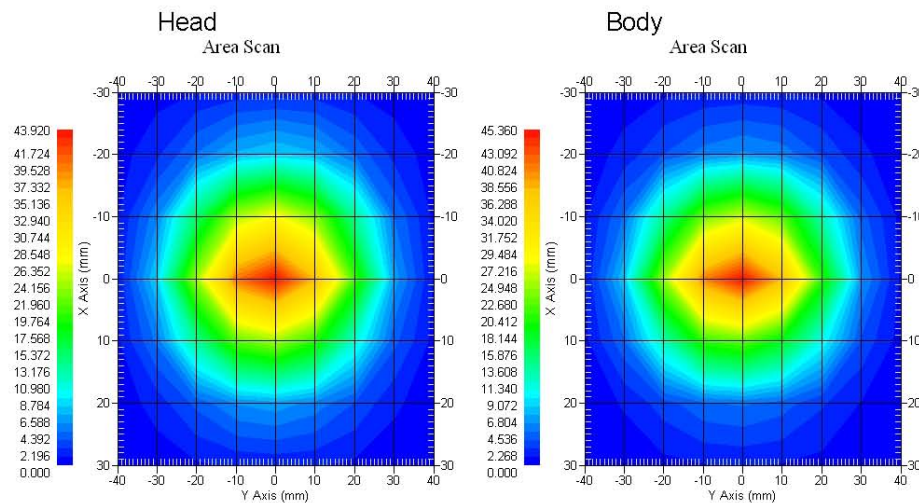

This page has been reviewed for content and attested to by signature within this document.

NCL Calibration Laboratories

Division of APREL Laboratories.

Introduction

This Calibration Report has been produced in line with the SSI Dipole Calibration Procedure SSI-TP-018-ALSAS. The results contained within this report are for Validation Dipole 210-00710. The calibration routine consisted of a three-step process. Step 1 was a mechanical verification of the dipole to ensure that it meets the mechanical specifications. Step 2 was an Electrical Calibration for the Validation Dipole, where the SWR, Impedance, and the Return loss were assessed. Step 3 involved a System Validation using the ALSAS-10U, along with APREL E-020 30 MHz to 6 GHz E-Field Probe Serial Number 225.

References

- IEC-62209 “Human exposure to radio frequency fields from hand-held and body-mounted wireless communication devices – Human models, instrumentation, and procedures”
- Part 2: “Procedure to determine the Specific Absorption Rate (SAR) for hand-held devices used in close proximity of the ear (frequency range of 30 MHz to 6 GHz)”
- TP-D01-032-E020-V2 E-Field probe calibration procedure
- D22-012-Tissue dielectric tissue calibration procedure
- D28-002-Dipole procedure for validation of SAR system using a dipole
- IEEE 1309 Draft Standard for Calibration of Electromagnetic Field Sensors and Probes, Excluding Antennas, from 9kHz to 40GHz

Conditions

Dipole 210-00710 was a recalibration.

Ambient Temperature of the Laboratory: 22 °C +/- 0.5°C
Temperature of the Tissue: 20 °C +/- 0.5°C

Dipole Calibration uncertainty

The calibration uncertainty for the dipole is made up of various parameters presented below.

Mechanical	1%
Positioning Error	1.22%
Electrical	1.7%
Tissue	2.2%
Dipole Validation	2.2%
TOTAL	8.32% (16.64% K=2)

This page has been reviewed for content and attested to by signature within this document.

NCL Calibration Laboratories

Division of APREL Laboratories.

Dipole Calibration Results

Mechanical Verification

APREL Length	APREL Height	Measured Length	Measured Height
68.0 mm	39.5 mm	67.1mm	38.9 mm

Electrical Validation

Tissue	Frequency	SWR:	Return Loss	Impedance
Head	1900MHz	1.084 U	-27.92 dB	52.247 Ω
Body	1900MHz	1.128 U	-24.40 dB	52.618 Ω

Tissue Validation

	Dielectric constant, ϵ_r	Conductivity, σ [S/m]
Head Tissue 1900MHz	40.20	1.38
Body Tissue 1900MHz	52.63	1.46

This page has been reviewed for content and attested to by signature within this document.

NCL Calibration Laboratories

Division of APREL Laboratories.

The Following Graphs are the results as displayed on the Vector Network Analyzer.

S11 Parameter Return Loss

Head: Frequency Range 1.865 to 1.937 GHz

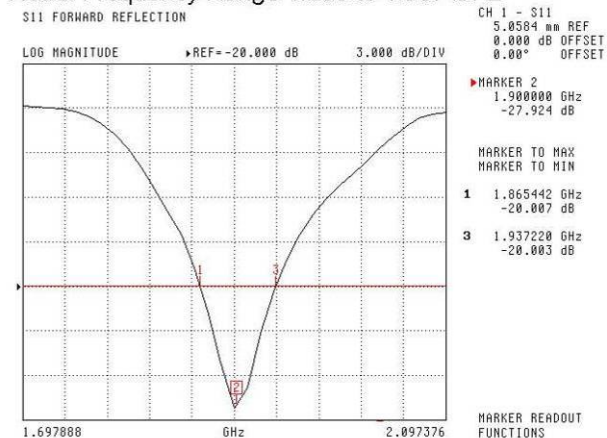

Body: Frequency Range 1.869 to 1.931 MHz

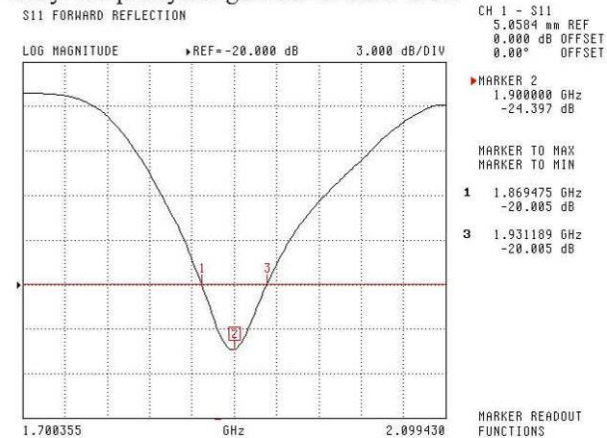

This page has been reviewed for content and attested to by signature within this document.

NCL Calibration Laboratories

Division of APREL Laboratories.

SWR

Head

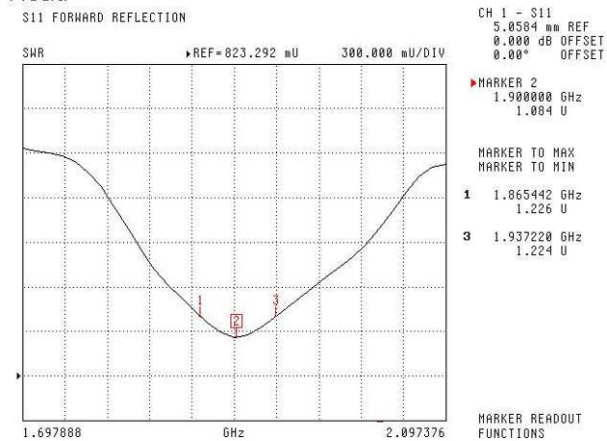

Body

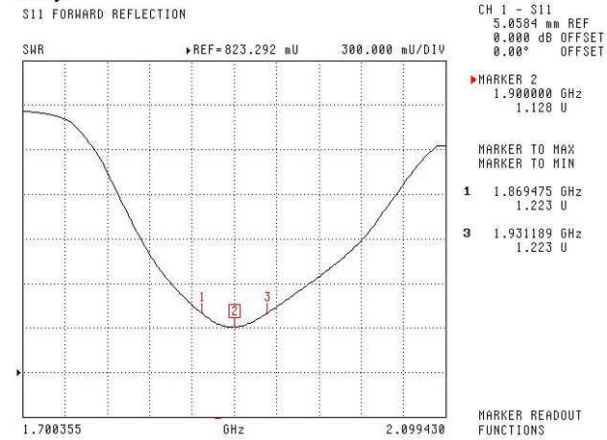

This page has been reviewed for content and attested to by signature within this document.

7

NCL Calibration Laboratories

Division of APREL Laboratories.

Smith Chart Dipole Impedance

Head

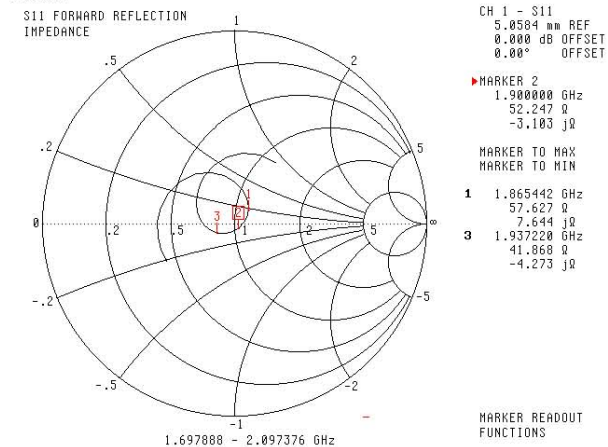

Body

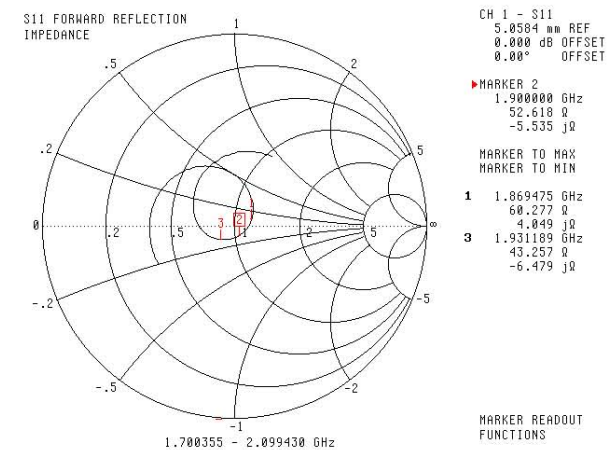

This page has been reviewed for content and attested to by signature within this document.

NCL Calibration Laboratories

Division of APREL Laboratories.

Test Equipment

The test equipment used during Probe Calibration, manufacturer, model number and, current calibration status are listed and located on the main APREL server R:\NCL\Calibration Equipment\Instrument List 2014

This page has been reviewed for content and attested to by signature within this document.

9

APPENDIX D EUT TEST POSITION PHOTOS

Liquid depth $\geq 15\text{cm}$



Left Head Cheek

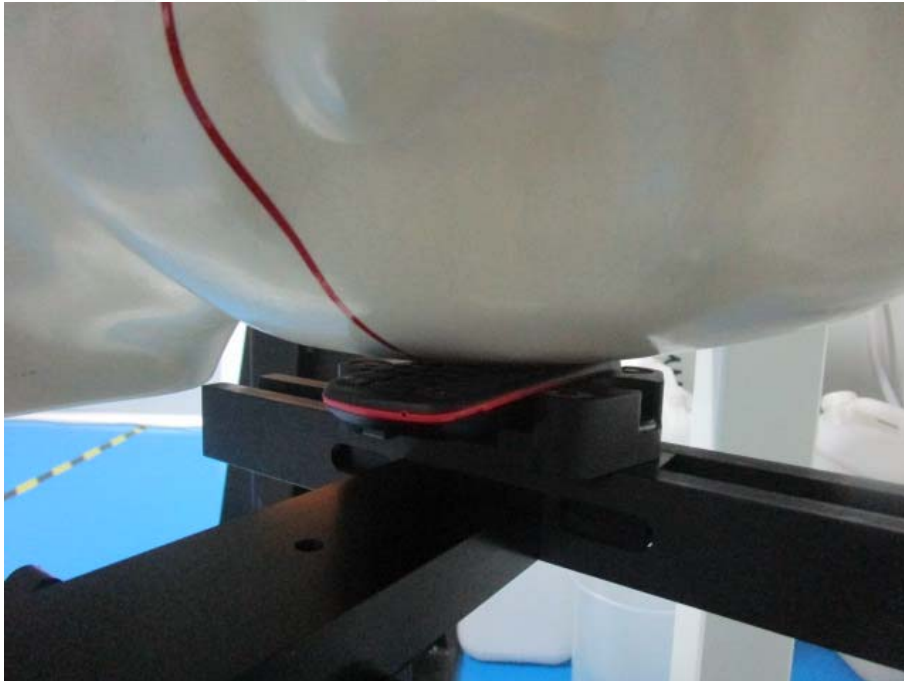

Left Head Tilt

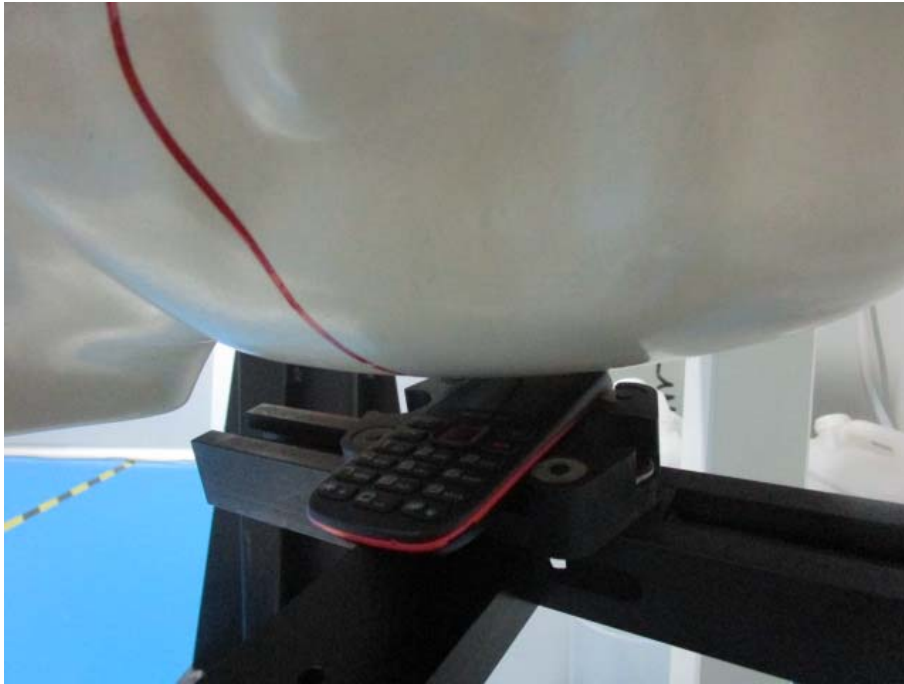

Right Head Check

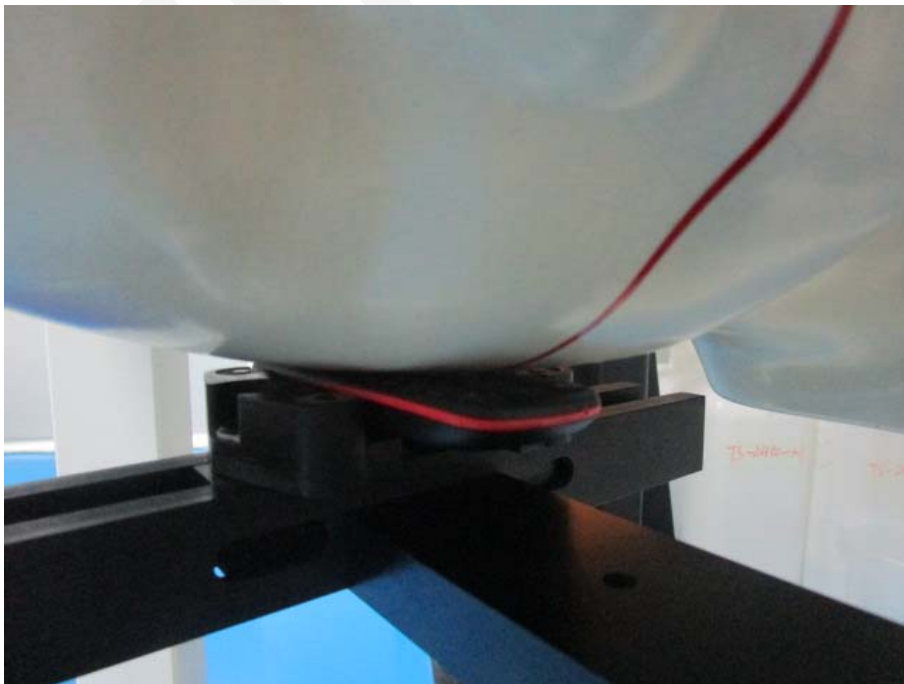

Right Head Tilt

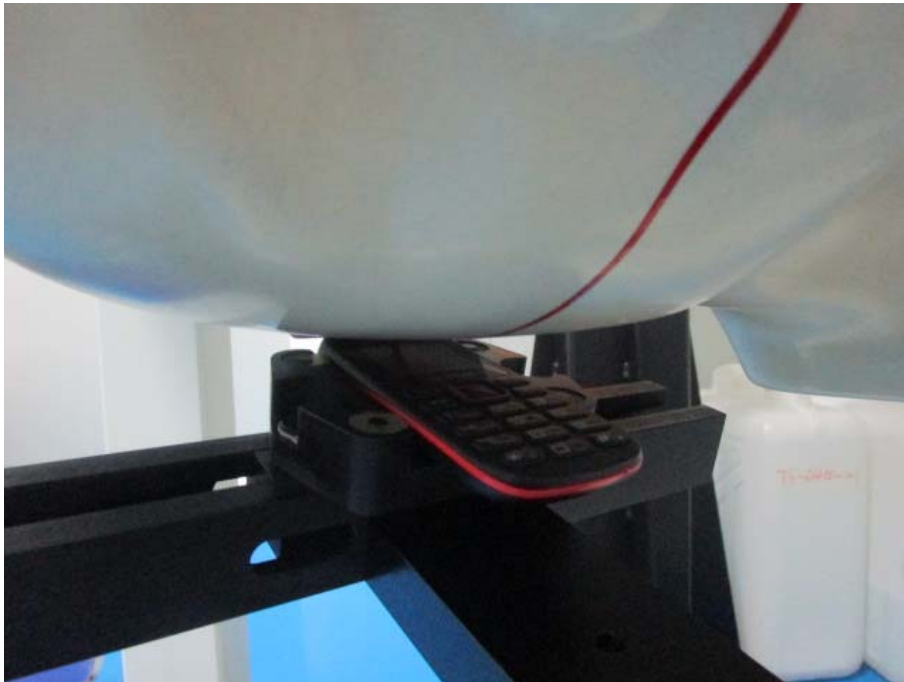

Body -Worn-Back (15mm)



APPENDIX E EUT PHOTOS

EUT – Front View



EUT – Back View



EUT –Left Side View



EUT – Right Side View



EUT – Top View



EUT – Bottom View



EUT – Uncover View



FEM

PRODUCT SIMILARITY DECLARATION LETTER

Hyundai Corporation

Address : 140-2, Kye-dong, Chongro-ku, Seoul, South Korea

Tel : 82-2-746-1395

Fax: 82-2-746-1051

Product Similarity Declaration

August 27, 2015

To Whom It May Concern,

We, Hyundai Corporation, hereby declare that we have a product named as Mobile Phone (Model number: E245S) was tested by BACL, meanwhile, for our marketing purpose, we would like to list a series models (E245SH) on reports and certificate, all the models are identical schematics, only named differently.
No other changes are made to them

We confirm that all information above is true, and we'll be responsible for all the consequences. Please contact me if you have any question.

Sincerely,

Signature

Kyunghee Kim



Sales assistant

***** END OF REPORT *****