

EMC TEST Report

FCC ID: RPW-WLAN800

This report concerns (check one) : Original Grant Class I Change

Issued Date : Nov. 29, 2006

Report No. : 0609066

Equipment : Wireless Volp Phone

Model No. : WLAN 800

Applicant : BCM Communication Co., Ltd.

Address : 5F-1, NO. 2, JIAN 8th RD., JHONGHE
CITY, TAIPEI COUNTY 235, TAIWAN, R.
O. C.(Building C)

Tested by:

Neutron Engineering Inc. EMC Laboratory

Data of Test:

Sep. 14, 2006 ~ Nov. 21, 2006

Testing Engineer : Alan Liu
(Alan Liu)

Technical Manager : Jeff Yang
(Jeff Yang)

Authorized Signatory : Andy Chiu
(Andy Chiu)

NEUTRON ENGINEERING INC.

No. 132-1, Lane 329, Sec. 2, Palain Rd.,
Shijr City, Taipei, Taiwan

TEL : (02) 2646-5426 FAX : (02) 2646-6815



Declaration

Neutron represents to the client that testing is done in accordance with standard procedures as applicable and that test instruments used has been calibrated with the standards traceable to National Measurement Laboratory (**NML**) of **R.O.C.**, or National Institute of Standards and Technology (**NIST**) of **U.S.A.**

Neutron's reports apply only to the specific samples tested under conditions. It is manufacture's responsibility to ensure that additional production units of this model are manufactured with the identical electrical and mechanical components. **Neutron** shall have no liability for any declarations, inferences or generalizations drawn by the client or others from **Neutron** issued reports.

Neutron's reports must not be used by the client to claim product endorsement by the authorities or any agency of the Government.

This report is the confidential property of the client. As a mutual protection to the clients, the public and **Neutron-self**, extracts from the test report shall not be reproduced except in full with **Neutron's** authorized written approval.

Neutron's laboratory quality assurance procedures are in compliance with the **ISO Guide 17025** requirements, and accredited by the conformity assessment authorities listed in this test report.

Limitation

For the use of the authority's logo is limited unless the Test Standard(s)/Scope(s)/Item(s) mentioned in this test report is (are) included in the conformity assessment authorities acceptance respective.

Table of Contents	Page
1 . CERTIFICATION	5
2 . SUMMARY OF TEST RESULTS	6
2.1 TEST FACILITY	7
2.2 MEASUREMENT UNCERTAINTY	7
3 . GENERAL INFORMATION	8
3.1 GENERAL DESCRIPTION OF EUT	8
3.2 DESCRIPTION OF TEST MODES	9
3.3 BLOCK DIGRAM SHOWING THE CONFIGURATION OF SYSTEM TESTED	10
3.4 DESCRIPTION OF SUPPORT UNITS	11
4 . EMC EMISSION TEST	12
4.1 CONDUCTED EMISSION MEASUREMENT	12
4.1.1 POWER LINE CONDUCTED EMISSION LIMITS	12
4.1.2 MEASUREMENT INSTRUMENTS LIST	12
4.1.3 TEST PROCEDURE	13
4.1.4 DEVIATION FROM TEST STANDARD	13
4.1.5 TEST SETUP	13
4.1.6 EUT OPERATING CONDITIONS	14
4.1.7 TEST RESULTS	15
4.2 RADIATED EMISSION MEASUREMENT	27
4.2.1 RADIATED EMISSION LIMITS	27
4.2.2 MEASUREMENT INSTRUMENTS LIST	28
4.2.3 TEST PROCEDURE	28
4.2.4 DEVIATION FROM TEST STANDARD	28
4.2.5 TEST SETUP	29
4.2.6 EUT OPERATING CONDITIONS	29
4.2.7 TEST RESULTS (Between 30 – 1000 MHz)	30
4.2.8 TEST RESULTS (Above 1000 MHz)	42
4.2.9 TEST RESULTS (Restricted Bands Requirements)	150
5 . BANDWIDTH TEST	158
5.1 APPLIED PROCEDURES / LIMIT	158
5.1.1 MEASUREMENT INSTRUMENTS LIST	158
5.1.2 TEST PROCEDURE	158
5.1.3 DEVIATION FROM STANDARD	158
5.1.4 TEST SETUP	158
5.1.5 EUT OPERATION CONDITIONS	158
5.1.6 TEST RESULTS	159

Table of Contents	Page
6 . PEAK OUTPUT POWER TEST	163
6.1 APPLIED PROCEDURES / LIMIT	163
6.1.1 MEASUREMENT INSTRUMENTS LIST	163
6.1.2 TEST PROCEDURE	163
6.1.3 DEVIATION FROM STANDARD	163
6.1.4 TEST SETUP	163
6.1.5 EUT OPERATION CONDITIONS	163
6.1.6 TEST RESULTS	164
7 . ANTENNA CONDUCTED SPURIOUS EMISSION	168
7.1 APPLIED PROCEDURES / LIMIT	168
7.1.1 MEASUREMENT INSTRUMENTS LIST	168
7.1.2 TEST PROCEDURE	168
7.1.3 DEVIATION FROM STANDARD	168
7.1.4 TEST SETUP	168
7.1.5 EUT OPERATION CONDITIONS	168
7.1.6 TEST RESULTS	169
8 . POWER SPECTRAL DENSITY TEST	171
8.1 APPLIED PROCEDURES / LIMIT	171
8.1.1 MEASUREMENT INSTRUMENTS LIST	171
8.1.2 TEST PROCEDURE	171
8.1.3 DEVIATION FROM STANDARD	171
8.1.4 TEST SETUP	171
8.1.5 EUT OPERATION CONDITIONS	171
8.1.6 TEST RESULTS	172
9 . RF EXPOSURE TEST	176
9.1 APPLIED PROCEDURES / LIMIT	176
9.1.1 MEASUREMENT INSTRUMENTS LIST	176
9.1.2 TEST RESULTS	177
10 . BAND EDGES REQUIREMENTS TEST	178
10.1 APPLIED PROCEDURES / LIMIT	178
10.1.1 MEASUREMENT INSTRUMENTS LIST	178
10.1.2 TEST RESULTS	179
11 . EUT TEST PHOTO	180

1. CERTIFICATION

Equipment : Wireless Volp Phone
Trade Name : BCM
Model No. : WLAN 800
Applicant : BCM Communication Co., Ltd.
Data of Test : Sep. 14, 2006 ~ Nov. 21, 2006
Test Item : ENGINEERING SAMPLE
Standards : FCC Part15, Subpart C / RSS-210: 2004/ ANCI C63.4 : 2003

The above equipment has been tested and found compliance with the requirement of the relative standards by Neutron Engineering Inc. EMC Laboratory.

The test data, data evaluation, and equipment configuration contained in our test report (Ref No. NEI-FCCP-1-0609066) were obtained utilizing the test procedures, test instruments, test sites that has been accredited by the Authority of NVLAP and CNLA according to the ISO-17025 quality assessment standard and technical standard(s).

2. SUMMARY OF TEST RESULTS

Test procedures according to the technical standards:

FCC Part15, Subpart C			
Standard Section	Test Item	Judgment	Remark
15.207	Conducted Emission	PASS	
15.247 (c)	Antenna conducted Spurious Emission	PASS	
15.247 (a)(2)	6dB Bandwidth	PASS	
15.247 (b)	Peak Output Power	PASS	
15.247 (c)	Radiated Spurious Emission	PASS	
15.247 (d)	Power Spectral Density	PASS	
15.203	Antenna Requirement	PASS	
1.1307 1.1310 2.1091 2.1093	RF Exposure Compliance	PASS	

NOTE:

(1) "N/A" denotes test is not applicable in this Test Report

2.1 TEST FACILITY

The test facilities used to collect the test data in this report is **C01/OS02** at the location of No.132-1, Lane 329, Sec. 2, Palain Road, Shijr City, Taipei, Taiwan.

2.2 MEASUREMENT UNCERTAINTY

The reported uncertainty of measurement $y \pm U$, where expended uncertainty **U** is based on a standard uncertainty multiplied by a coverage factor of **k=2**, providing a level of confidence of approximately **95 %**.

A. Conducted Measurement :

Test Site	Method	Measurement Frequency Range	U , (dB)	NOTE
C01	ANSI	150 KHz ~ 30MHz	1.94	

B. Radiated Measurement :

Test Site	Method	Measurement Frequency Range	Ant. H / V	U , (dB)	NOTE
OS-01	ANSI	30MHz ~ 200MHz	V	3.82	
		30MHz ~ 200MHz	H	3.60	
		200MHz ~ 1,000MHz	V	3.86	
		200MHz ~ 1,000MHz	H	3.94	
OS-02	ANSI	30MHz ~ 200MHz	V	2.48	
		30MHz ~ 200MHz	H	2.16	
		200MHz ~ 1,000MHz	V	2.50	
		200MHz ~ 1,000MHz	H	2.66	

3. GENERAL INFORMATION

3.1 GENERAL DESCRIPTION OF EUT

Equipment	Wireless Volp Phone
Trade Name	BCM
Model No.	WLAN 800
OEM Brand/Model No.	N/A
Model Difference	N/A
Product Description	The EUT is a Wireless Volp Phone.
	Operation Frequency: 2400~2483.5 MHz
	Product Class: Class 1
	Receiver Class: Class 3
	Modulation Type: DSSS
	Bit Rate of Transmitter 802.11b:11/5.5/2/1Mbps 802.11g: 54/48/36/24/18/12/9/6 Mbps
	Number Of Channel 11 CH
	Antenna Designation: Integra
	Antenna Gain(Peak) -2.93 dBi
	Output Power: 15.25 dBm (Max.)
Based on the application, features, or specification exhibited in User's Manual, the EUT is considered as an ITE/Computing Device. More details of EUT technical specification, please refer to the User's Manual.	
Channel List	Please refer to the Note 2.
Power Source	Battery supplied or DC Voltage supplied from AC/DC adapter.
Power Rating	Battery: 3.7V, 1250mAh Adapter: AC I/P 100-240Vac~ 50/60Hz, 0.15A/ DC O/P 5V, 1.0A
Connecting I/O Port(s)	Please refer to the User's Manual
Products Covered	Battery(Model No.: 7508000705) Adapter(Model No.: KSAFB0500100W1US)

Note:

1. For a more detailed features description, please refer to the manufacturer's specifications or the User's Manual.
- 2.

Channel List							
Channel	Frequency (MHz)	Channel	Frequency (MHz)	Channel	Frequency (MHz)	Channel	Frequency (MHz)
01	2412	05	2432	09	2452		
02	2417	06	2437	10	2457		
03	2422	07	2442	11	2462		
04	2427	08	2447				

3.2 DESCRIPTION OF TEST MODES

To investigate the maximum EMI emission characteristics generates from EUT, the test system was pre-scanning tested base on the consideration of following EUT operation mode or test configuration mode which possible have effect on EMI emission level. Each of these EUT operation mode(s) or test configuration mode(s) mentioned above was evaluated respectively.

Pretest Test Mode	Description
Mode 1	CH01
Mode 2	CH06
Mode 3	CH11

For Conducted / Radiated Test	
Final Test Mode	Description
Mode 1	CH01
Mode 2	CH06
Mode 3	CH11

3.3 BLOCK DIGRAM SHOWING THE CONFIGURATION OF SYSTEM TESTED

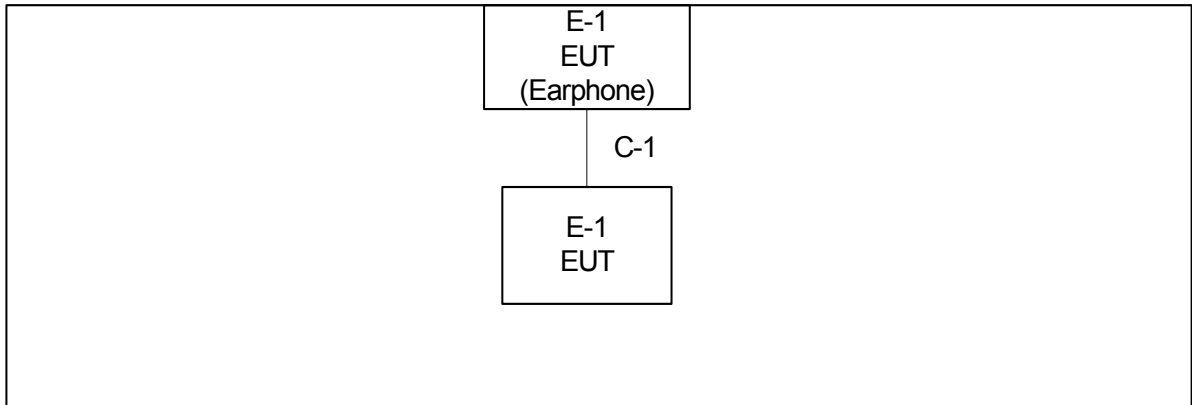

C-1 Audio Cable

3.4 DESCRIPTION OF SUPPORT UNITS

The EUT has been tested as an independent unit together with other necessary accessories or support units. The following support units or accessories were used to form a representative test configuration during the tests.

Item	Equipment	Mfr/Brand	Model/Type No.	FCC ID	Series No.	Note
E-1	Wireless Volp Phone	BCM	WLAN 800	RPW-WLAN800	N/A	EUT

Item	Shielded Type	Ferrite Core	Length	Note
C-1	NO	NO	1.5M	

Note:

- (1) The support equipment was authorized by Declaration of Confirmation.
- (2) For detachable type I/O cable should be specified the length in cm in 『Length』 column.

4. EMC EMISSION TEST

4.1 CONDUCTED EMISSION MEASUREMENT

4.1.1 POWER LINE CONDUCTED EMISSION LIMITS (Frequency Range 150KHz-30MHz)

FREQUENCY (MHz)	Class A (dBuV)		Class B (dBuV)		Standard
	Quasi-peak	Average	Quasi-peak	Average	
0.15 -0.5	79.00	66.00	66 - 56 *	56 - 46 *	CISPR
0.50 -5.0	73.00	60.00	56.00	46.00	CISPR
5.0 -30.0	73.00	60.00	60.00	50.00	CISPR

0.15 -0.5	79.00	66.00	66 - 56 *	56 - 46 *	FCC
0.50 -5.0	73.00	60.00	56.00	46.00	FCC
5.0 -30.0	73.00	60.00	60.00	50.00	FCC

Note:

- (1) The tighter limit applies at the band edges.
- (2) The limit of " * " marked band means the limitation decreases linearly with the logarithm of the frequency in the range.

4.1.2 MEASUREMENT INSTRUMENTS LIST

Item	Kind of Equipment	Manufacturer	Type No.	Serial No.	Calibrated until
1	LISN	Rolf Heine	NNB-2/16Z	98053	Dec. 19, 2006
2	Pulse Limiter	Electro-Metrics	EM-7600	112644	Nov. 29, 2006
3	Test Cable	N/A	C01	N/A	Nov. 29, 2006
4	EMI Test Receiver	R&S	ESCI	100082	Feb. 01, 2007

Remark: " N/A" denotes No Model No. , Serial No. or No Calibration specified.

4.1.3 TEST PROCEDURE

- a. The EUT was placed 0.4 meters from the horizontal ground plane with EUT being connected to the power mains through a line impedance stabilization network (LISN). All other support equipments powered from additional LISN(s). The LISN provide 50 Ohm/ 50uH of coupling impedance for the measuring instrument.
- b. Interconnecting cables that hang closer than 40 cm to the ground plane shall be folded back and forth in the center forming a bundle 30 to 40 cm long.
- c. I/O cables that are not connected to a peripheral shall be bundled in the center. The end of the cable may be terminated, if required, using the correct terminating impedance. The overall length shall not exceed 1 m.
- d. LISN at least 80 cm from nearest part of EUT chassis.
- e. For the actual test configuration, please refer to the related Item –EUT Test Photos.

4.1.4 DEVIATION FROM TEST STANDARD

No deviation

4.1.5 TEST SETUP

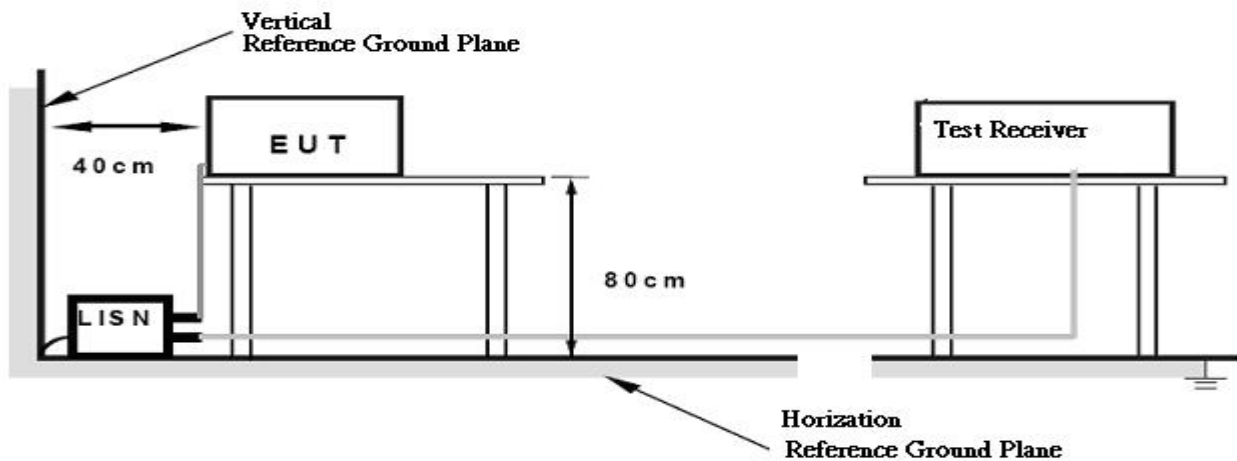

4.1.6 EUT OPERATING CONDITIONS

The EUT was configured for testing in a typical fashion (as a customer would normally use it). The EUT has been programmed to continuously transmit during test. This operating condition was tested and used to collect the included data.

4.1.7 TEST RESULTS

EUT :	Wireless Volp Phone	Model No. :	WLAN 800
Temperature :	26 °C	Relative Humidity :	58 %
Pressure :	1004 hPa	Test Power :	AC 120V/60Hz
Test Mode :	802.11b/CH01		

Freq. (MHz)	Terminal L/N	Measured(dBuV)		Limits(dBuV)		Margin (dB)	Note
		QP-Mode	AV-Mode	QP-Mode	AV-Mode		
0.18	Line	56.68	40.88	64.44	54.44	-7.76	(QP)
0.24	Line	50.68	36.40	62.13	52.13	-11.45	(QP)
0.58	Line	44.13	30.13	56.00	46.00	-11.87	(QP)
1.35	Line	43.86	*	56.00	46.00	-12.14	(QP)
2.38	Line	43.74	*	56.00	46.00	-12.26	(QP)
12.00	Line	45.12	*	60.00	50.00	-14.88	(QP)

Remark

- (1) Reading in which marked as QP means measurements by using are Quasi-Peak Mode with Detector BW=9KHz; SPA setting in RBW=10KHz,VBW =10KHz, Swp. Time = 0.3 sec./MHz ◦ Reading in which marked as AV means measurements by using are Average Mode with instrument setting in RBW=1MHz,VBW=10Hz, Swp. Time =0.3 sec./MHz ◦
- (2) All readings are QP Mode value unless otherwise stated AVG in column of 'Note'. If the QP Mode Measured value compliance with the QP Limits and lower than AVG Limits, the EUT shall be deemed to meet both QP & AVG Limits and then only QP Mode was measured, but AVG Mode didn't perform ◦ In this case, a " * " marked in AVG Mode column of Interference Voltage Measured ◦
- (3) Measuring frequency range from 150KHz to 30MHz ◦

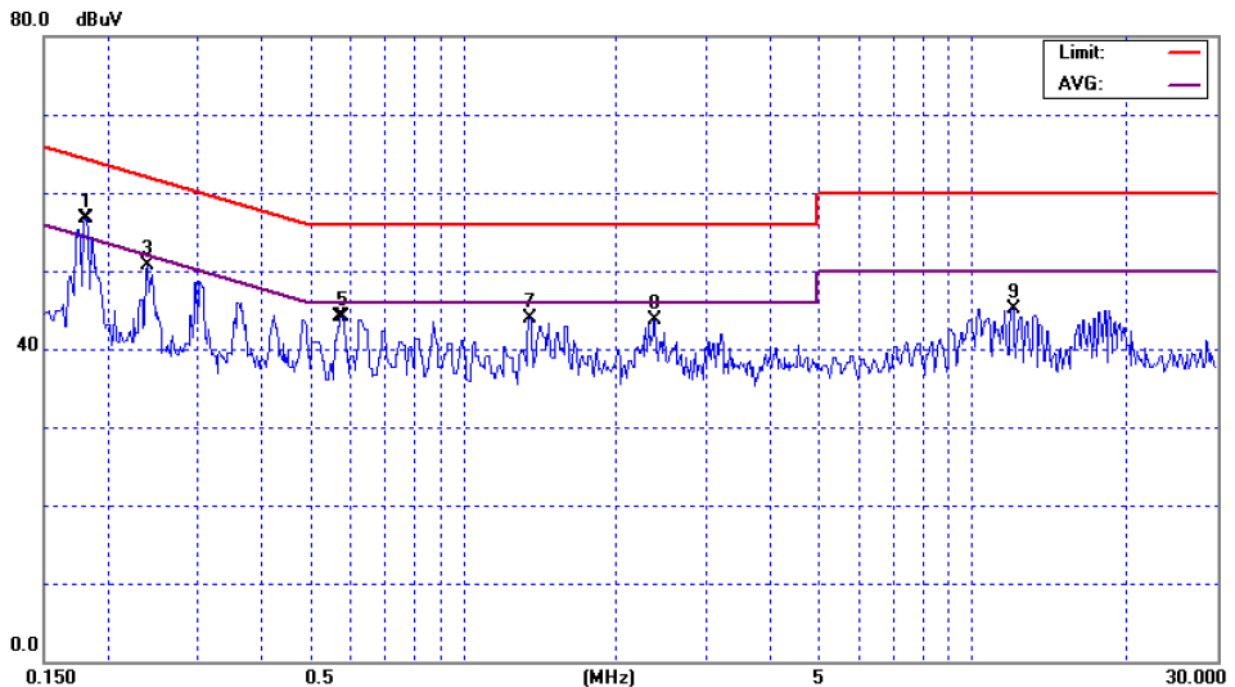

EUT :	Wireless Volp Phone	Model No. :	WLAN 800
Temperature :	26 °C	Relative Humidity :	58 %
Pressure :	1004 hPa	Test Power :	AC 120V/60Hz
Test Mode :	802.11b/CH01		

Freq. (MHz)	Terminal L/N	Measured(dBuV)		Limits(dBuV)		Margin (dB)	Note
		QP-Mode	AV-Mode	QP-Mode	AV-Mode		
0.18	Neutral	53.87	39.97	64.35	54.35	-10.48	(QP)
0.24	Neutral	46.47	*	61.99	51.99	-15.52	(QP)
0.63	Neutral	41.34	*	56.00	46.00	-14.66	(QP)
2.44	Neutral	42.33	*	56.00	46.00	-13.67	(QP)
3.42	Neutral	42.98	*	56.00	46.00	-13.02	(QP)
12.14	Neutral	45.93	*	60.00	50.00	-14.07	(QP)

Remark

- (1) Reading in which marked as QP means measurements by using are Quasi-Peak Mode with Detector BW=9KHz; SPA setting in RBW=10KHz,VBW =10KHz, Swp. Time = 0.3 sec./MHz ◦ Reading in which marked as AV means measurements by using are Average Mode with instrument setting in RBW=1MHz,VBW=10Hz, Swp. Time =0.3 sec./MHz ◦
- (2) All readings are QP Mode value unless otherwise stated AVG in column of『Note』. If the QP Mode Measured value compliance with the QP Limits and lower than AVG Limits, the EUT shall be deemed to meet both QP & AVG Limits and then only QP Mode was measured, but AVG Mode didn't perform ◦ In this case, a “ * ” marked in AVG Mode column of Interference Voltage Measured ◦
- (3) Measuring frequency range from 150KHz to 30MHz ◦

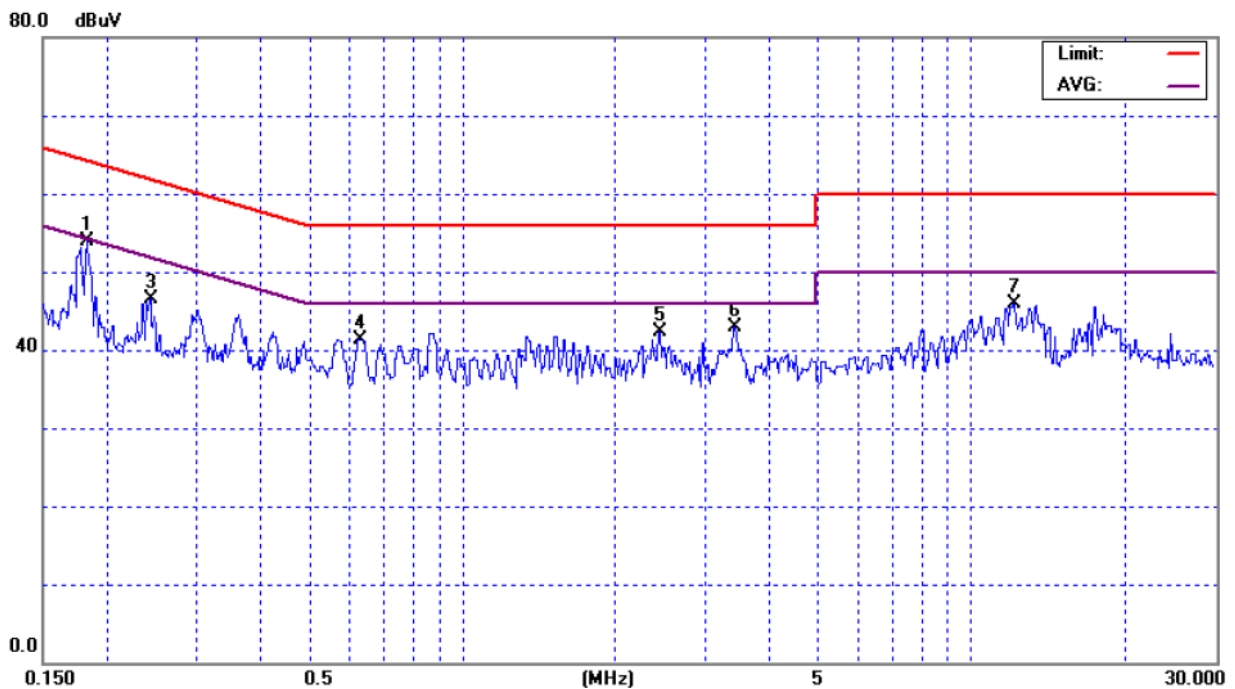

EUT :	Wireless Volp Phone	Model No. :	WLAN 800
Temperature :	26 °C	Relative Humidity :	58 %
Pressure :	1004 hPa	Test Power :	AC 120V/60Hz
Test Mode :	802.11b/CH06		

Freq. (MHz)	Terminal L/N	Measured(dBuV)		Limits(dBuV)		Margin (dB)	Note
		QP-Mode	AV-Mode	QP-Mode	AV-Mode		
0.18	Line	53.28	40.08	64.56	54.56	-11.28	(QP)
0.24	Line	47.28	*	62.27	52.27	-14.99	(QP)
0.30	Line	45.69	*	60.20	50.20	-14.51	(QP)
0.64	Line	42.94	*	56.00	46.00	-13.06	(QP)
2.44	Line	41.74	*	56.00	46.00	-14.26	(QP)
11.46	Line	44.70	*	60.00	50.00	-15.30	(QP)

Remark

- (1) Reading in which marked as QP means measurements by using are Quasi-Peak Mode with Detector BW=9KHz; SPA setting in RBW=10KHz,VBW =10KHz, Swp. Time = 0.3 sec./MHz ◦ Reading in which marked as AV means measurements by using are Average Mode with instrument setting in RBW=1MHz,VBW=10Hz, Swp. Time =0.3 sec./MHz ◦
- (2) All readings are QP Mode value unless otherwise stated AVG in column of『Note』. If the QP Mode Measured value compliance with the QP Limits and lower than AVG Limits, the EUT shall be deemed to meet both QP & AVG Limits and then only QP Mode was measured, but AVG Mode didn't perform ◦ In this case, a “ * ” marked in AVG Mode column of Interference Voltage Measured ◦
- (3) Measuring frequency range from 150KHz to 30MHz ◦

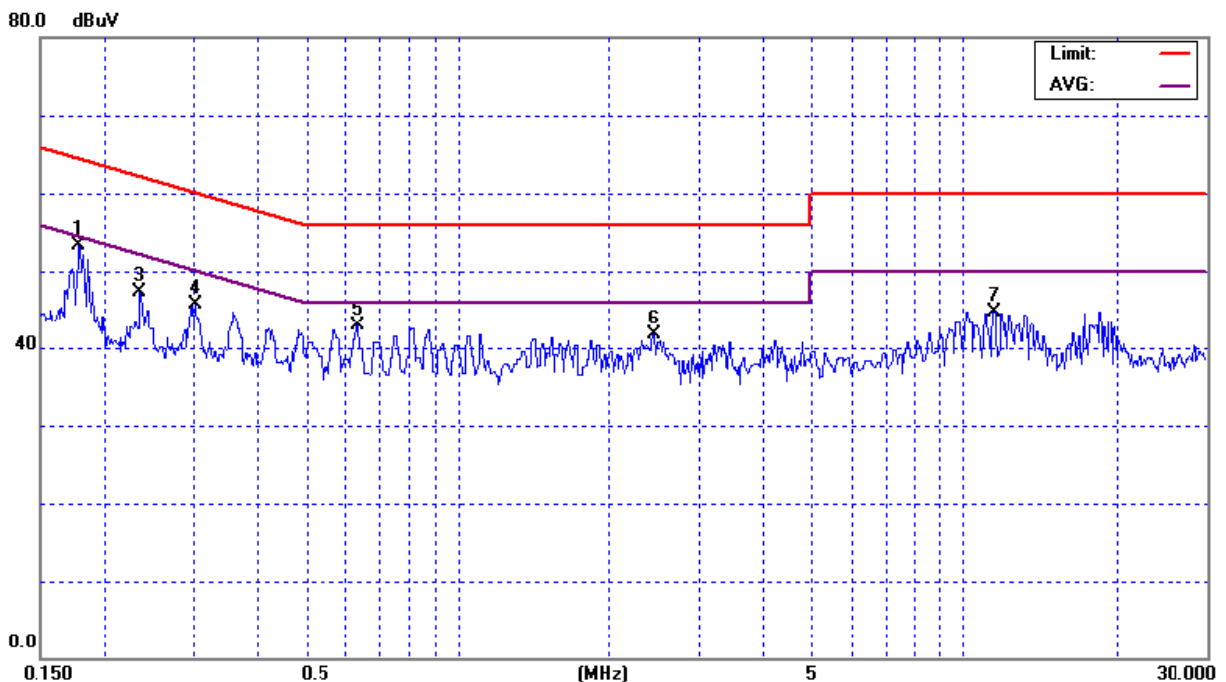

EUT :	Wireless Volp Phone	Model No. :	WLAN 800
Temperature :	26 °C	Relative Humidity :	58 %
Pressure :	1004 hPa	Test Power :	AC 120V/60Hz
Test Mode :	802.11b/CH06		

Freq. (MHz)	Terminal L/N	Measured(dBuV)		Limits(dBuV)		Margin (dB)	Note
		QP-Mode	AV-Mode	QP-Mode	AV-Mode		
0.18	Neutral	52.47	*	64.60	54.60	-12.13	(QP)
0.36	Neutral	45.70	*	58.75	48.75	-13.05	(QP)
0.57	Neutral	42.12	*	56.00	46.00	-13.88	(QP)
2.42	Neutral	40.93	*	56.00	46.00	-15.07	(QP)
10.32	Neutral	44.69	*	60.00	50.00	-15.31	(QP)
19.43	Neutral	45.03	*	60.00	50.00	-14.97	(QP)

Remark

- (1) Reading in which marked as QP means measurements by using are Quasi-Peak Mode with Detector BW=9KHz; SPA setting in RBW=10KHz,VBW =10KHz, Swp. Time = 0.3 sec./MHz ◦ Reading in which marked as AV means measurements by using are Average Mode with instrument setting in RBW=1MHz,VBW=10Hz, Swp. Time =0.3 sec./MHz ◦
- (2) All readings are QP Mode value unless otherwise stated AVG in column of 'Note'. If the QP Mode Measured value compliance with the QP Limits and lower than AVG Limits, the EUT shall be deemed to meet both QP & AVG Limits and then only QP Mode was measured, but AVG Mode didn't perform ◦ In this case, a " * " marked in AVG Mode column of Interference Voltage Measured ◦
- (3) Measuring frequency range from 150KHz to 30MHz ◦

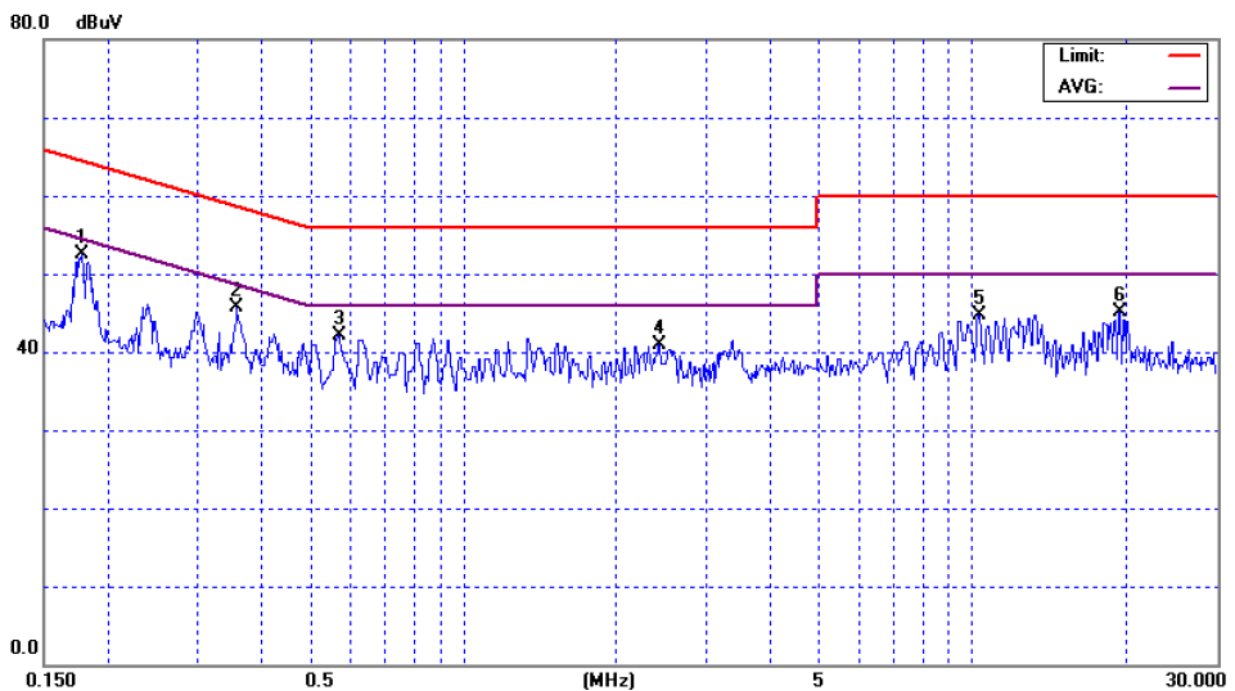

EUT :	Wireless Volp Phone	Model No. :	WLAN 800
Temperature :	26 °C	Relative Humidity :	58 %
Pressure :	1004 hPa	Test Power :	AC 120V/60Hz
Test Mode :	802.11b/CH11		

Freq. (MHz)	Terminal L/N	Measured(dBuV)		Limits(dBuV)		Margin (dB)	Note
		QP-Mode	AV-Mode	QP-Mode	AV-Mode		
0.18	Line	52.28	*	64.53	54.53	-12.25	(QP)
0.24	Line	47.48	*	62.03	52.03	-14.55	(QP)
0.36	Line	45.31	*	58.71	48.71	-13.40	(QP)
1.00	Line	42.83	*	56.00	46.00	-13.17	(QP)
1.52	Line	43.28	*	56.00	46.00	-12.72	(QP)
13.00	Line	45.74	*	60.00	50.00	-14.26	(QP)

Remark

- (1) Reading in which marked as QP means measurements by using are Quasi-Peak Mode with Detector BW=9KHz; SPA setting in RBW=10KHz,VBW =10KHz, Swp. Time = 0.3 sec./MHz ◦ Reading in which marked as AV means measurements by using are Average Mode with instrument setting in RBW=1MHz,VBW=10Hz, Swp. Time =0.3 sec./MHz ◦
- (2) All readings are QP Mode value unless otherwise stated AVG in column of『Note』. If the QP Mode Measured value compliance with the QP Limits and lower than AVG Limits, the EUT shall be deemed to meet both QP & AVG Limits and then only QP Mode was measured, but AVG Mode didn't perform ◦ In this case, a “ * ” marked in AVG Mode column of Interference Voltage Measured ◦
- (3) Measuring frequency range from 150KHz to 30MHz ◦

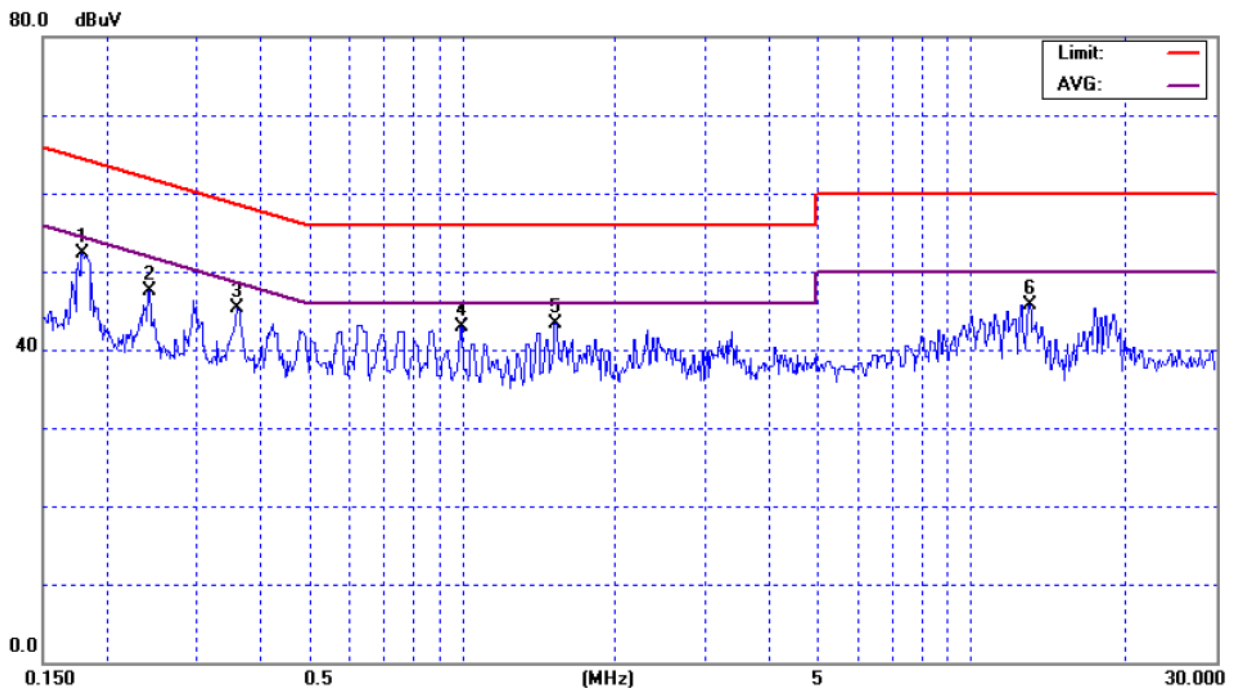

EUT :	Wireless Volp Phone	Model No. :	WLAN 800
Temperature :	26 °C	Relative Humidity :	58 %
Pressure :	1004 hPa	Test Power :	AC 120V/60Hz
Test Mode :	802.11b/ CH11		

Freq. (MHz)	Terminal L/N	Measured(dBuV)		Limits(dBuV)		Margin (dB)	Note
		QP-Mode	AV-Mode	QP-Mode	AV-Mode		
0.18	Neutral	51.87	*	64.42	54.42	-12.55	(QP)
0.36	Neutral	44.50	*	58.71	48.71	-14.21	(QP)
0.63	Neutral	42.34	*	56.00	46.00	-13.66	(QP)
0.81	Neutral	41.38	*	56.00	46.00	-14.62	(QP)
1.35	Neutral	41.45	*	56.00	46.00	-14.55	(QP)
12.07	Neutral	45.33	*	60.00	50.00	-14.67	(QP)

Remark

- (1) Reading in which marked as QP means measurements by using are Quasi-Peak Mode with Detector BW=9KHz; SPA setting in RBW=10KHz,VBW =10KHz, Swp. Time = 0.3 sec./MHz ◦ Reading in which marked as AV means measurements by using are Average Mode with instrument setting in RBW=1MHz,VBW=10Hz, Swp. Time =0.3 sec./MHz ◦
- (2) All readings are QP Mode value unless otherwise stated AVG in column of『Note』. If the QP Mode Measured value compliance with the QP Limits and lower than AVG Limits, the EUT shall be deemed to meet both QP & AVG Limits and then only QP Mode was measured, but AVG Mode didn't perform ◦ In this case, a “ * ” marked in AVG Mode column of Interference Voltage Measured ◦
- (3) Measuring frequency range from 150KHz to 30MHz ◦

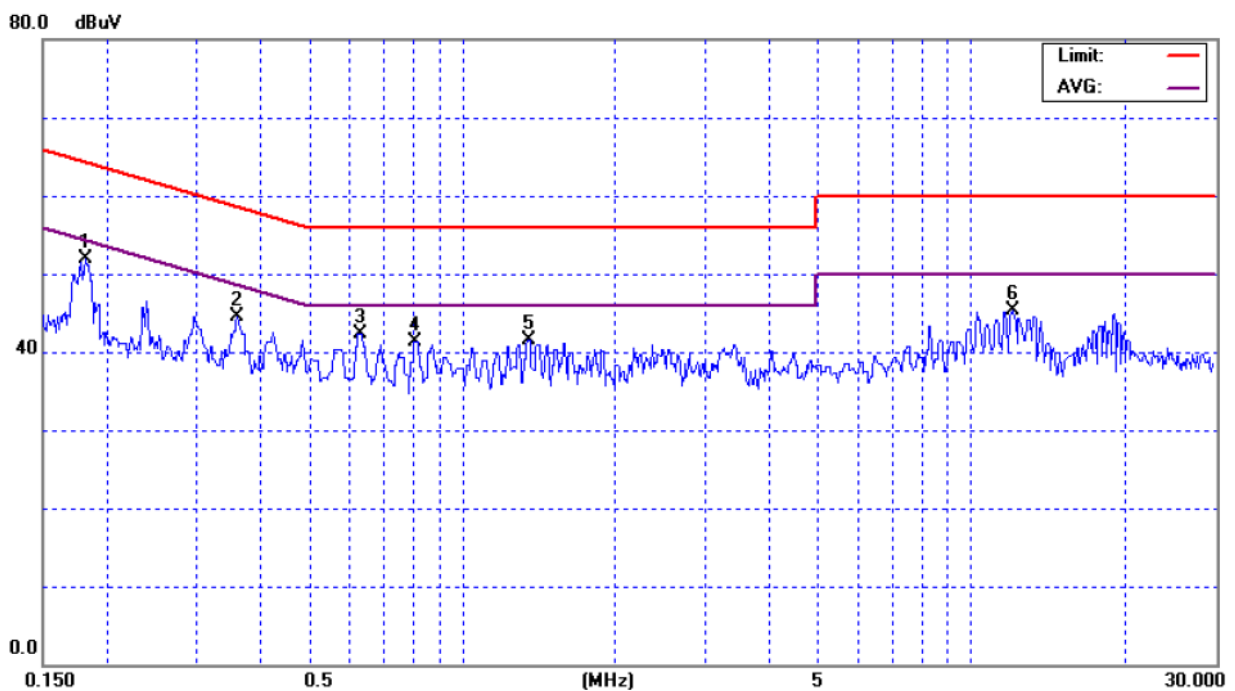

EUT :	Wireless Volp Phone	Model No. :	WLAN 800
Temperature :	26 °C	Relative Humidity :	58 %
Pressure :	1004 hPa	Test Power :	AC 120V/60Hz
Test Mode :	802.11g/CH01		

Freq. (MHz)	Terminal L/N	Measured(dBuV)		Limits(dBuV)		Margin (dB)	Note
		QP-Mode	AV-Mode	QP-Mode	AV-Mode		
0.18	Line	52.88	40.08	64.39	54.39	-11.51	(QP)
0.24	Line	47.08	*	62.13	52.13	-15.05	(QP)
0.30	Line	46.49	*	60.22	50.22	-13.73	(QP)
0.82	Line	42.58	*	56.00	46.00	-13.42	(QP)
2.48	Line	42.74	*	56.00	46.00	-13.26	(QP)
12.14	Line	46.92	*	60.00	50.00	-13.08	(QP)

Remark

- (1) Reading in which marked as QP means measurements by using are Quasi-Peak Mode with Detector BW=9KHz; SPA setting in RBW=10KHz,VBW =10KHz, Swp. Time = 0.3 sec./MHz ◦ Reading in which marked as AV means measurements by using are Average Mode with instrument setting in RBW=1MHz,VBW=10Hz, Swp. Time =0.3 sec./MHz ◦
- (2) All readings are QP Mode value unless otherwise stated AVG in column of『Note』. If the QP Mode Measured value compliance with the QP Limits and lower than AVG Limits, the EUT shall be deemed to meet both QP & AVG Limits and then only QP Mode was measured, but AVG Mode didn't perform ◦ In this case, a “ * ” marked in AVG Mode column of Interference Voltage Measured ◦
- (3) Measuring frequency range from 150KHz to 30MHz ◦

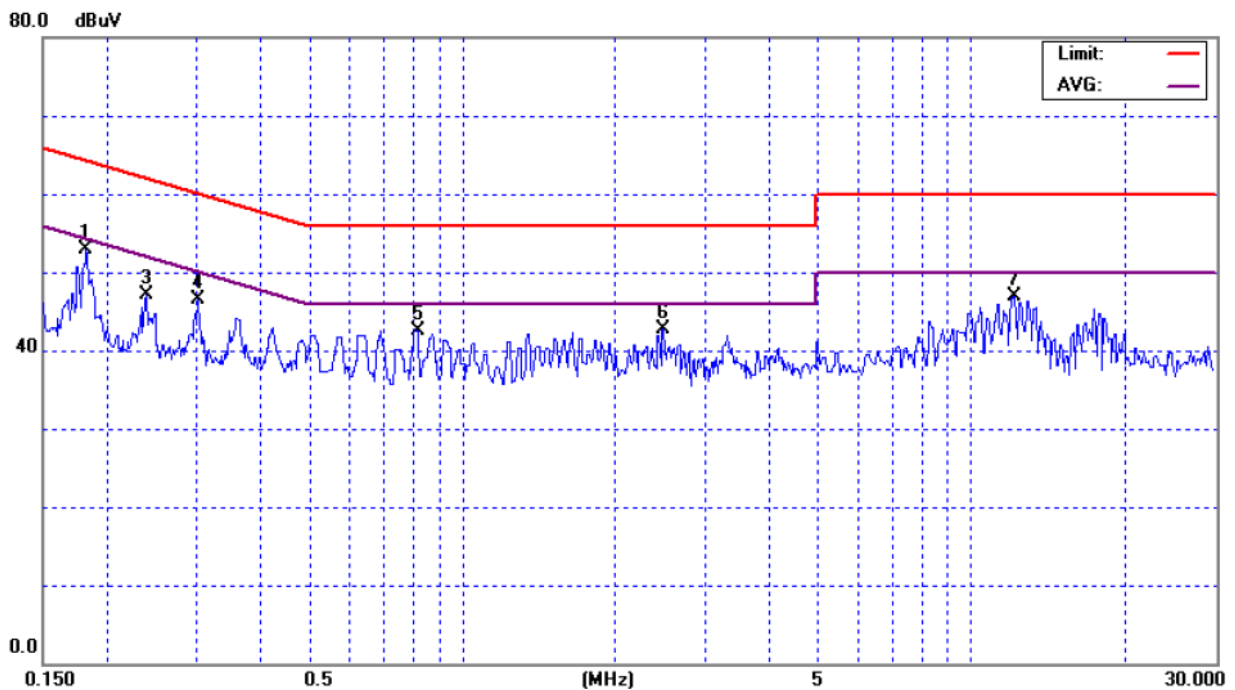

EUT :	Wireless Volp Phone	Model No. :	WLAN 800
Temperature :	26 °C	Relative Humidity :	58 %
Pressure :	1004 hPa	Test Power :	AC 120V/60Hz
Test Mode :	802.11g/CH01		

Freq. (MHz)	Terminal L/N	Measured(dBuV)		Limits(dBuV)		Margin (dB)	Note
		QP-Mode	AV-Mode	QP-Mode	AV-Mode		
0.18	Neutral	51.47	*	64.58	54.58	-13.11	(QP)
0.36	Neutral	44.71	*	58.69	48.69	-13.98	(QP)
0.94	Neutral	42.01	*	56.00	46.00	-13.99	(QP)
1.83	Neutral	41.10	*	56.00	46.00	-14.90	(QP)
3.27	Neutral	42.17	*	56.00	46.00	-13.83	(QP)
13.00	Neutral	45.75	*	60.00	50.00	-14.25	(QP)

Remark

- (1) Reading in which marked as QP means measurements by using are Quasi-Peak Mode with Detector BW=9KHz; SPA setting in RBW=10KHz,VBW =10KHz, Swp. Time = 0.3 sec./MHz ◦ Reading in which marked as AV means measurements by using are Average Mode with instrument setting in RBW=1MHz,VBW=10Hz, Swp. Time =0.3 sec./MHz ◦
- (2) All readings are QP Mode value unless otherwise stated AVG in column of『Note』. If the QP Mode Measured value compliance with the QP Limits and lower than AVG Limits, the EUT shall be deemed to meet both QP & AVG Limits and then only QP Mode was measured, but AVG Mode didn't perform ◦ In this case, a “ * ” marked in AVG Mode column of Interference Voltage Measured ◦
- (3) Measuring frequency range from 150KHz to 30MHz ◦

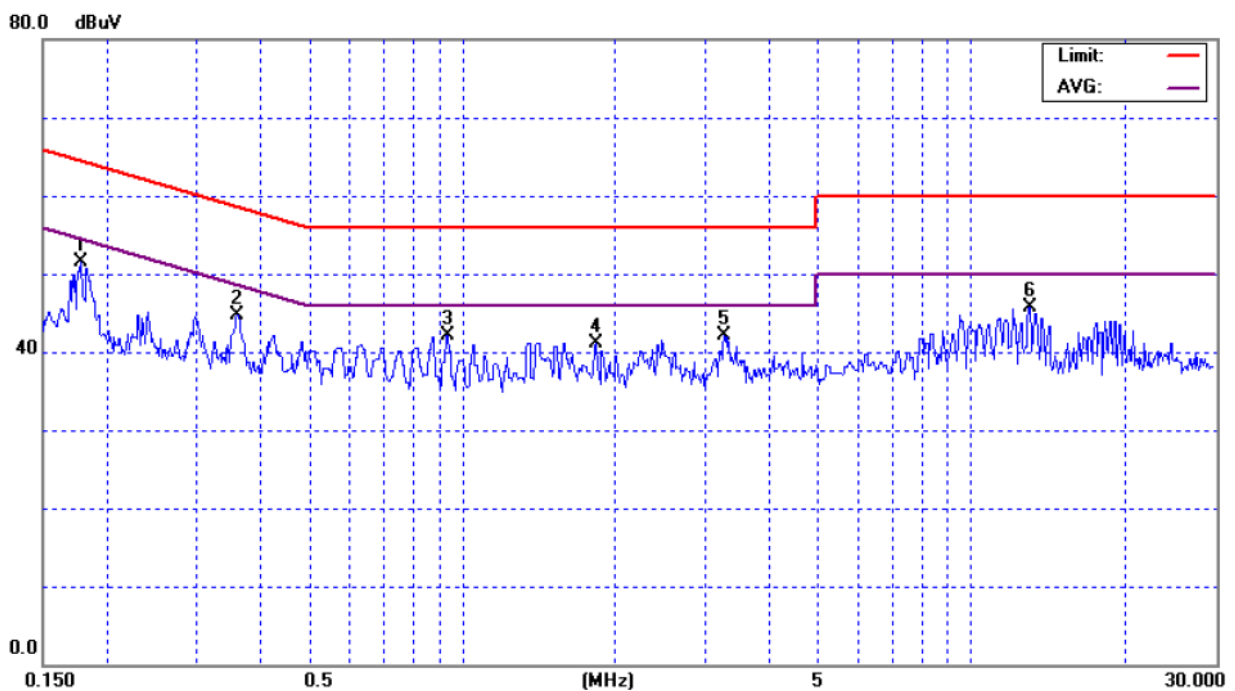

EUT :	Wireless Volp Phone	Model No. :	WLAN 800
Temperature :	26 °C	Relative Humidity :	58 %
Pressure :	1004 hPa	Test Power :	AC 120V/60Hz
Test Mode :	802.11g/CH06		

Freq. (MHz)	Terminal L/N	Measured(dBuV)		Limits(dBuV)		Margin (dB)	Note
		QP-Mode	AV-Mode	QP-Mode	AV-Mode		
0.18	Line	51.68	*	64.70	54.70	-13.02	(QP)
0.24	Line	45.68	*	62.08	52.08	-16.40	(QP)
0.36	Line	44.72	*	58.65	48.65	-13.93	(QP)
0.64	Line	43.34	*	56.00	46.00	-12.66	(QP)
2.18	Line	43.13	*	56.00	46.00	-12.87	(QP)
12.46	Line	46.93	*	60.00	50.00	-13.07	(QP)

Remark

- (1) Reading in which marked as QP means measurements by using are Quasi-Peak Mode with Detector BW=9KHz; SPA setting in RBW=10KHz,VBW =10KHz, Swp. Time = 0.3 sec./MHz ◦ Reading in which marked as AV means measurements by using are Average Mode with instrument setting in RBW=1MHz,VBW=10Hz, Swp. Time =0.3 sec./MHz ◦
- (2) All readings are QP Mode value unless otherwise stated AVG in column of『Note』. If the QP Mode Measured value compliance with the QP Limits and lower than AVG Limits, the EUT shall be deemed to meet both QP & AVG Limits and then only QP Mode was measured, but AVG Mode didn't perform ◦ In this case, a “ * ” marked in AVG Mode column of Interference Voltage Measured ◦
- (3) Measuring frequency range from 150KHz to 30MHz ◦

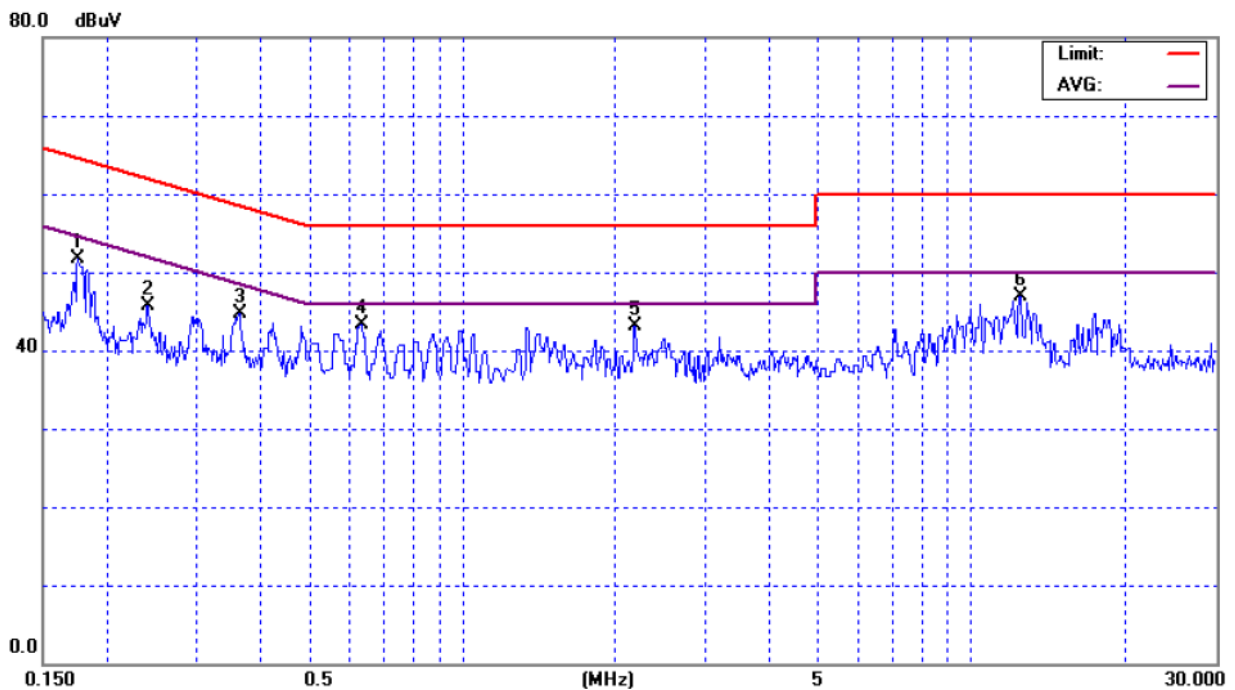

EUT :	Wireless Volp Phone	Model No. :	WLAN 800
Temperature :	26 °C	Relative Humidity :	58 %
Pressure :	1004 hPa	Test Power :	AC 120V/60Hz
Test Mode :	802.11g/CH06		

Freq. (MHz)	Terminal L/N	Measured(dBuV)		Limits(dBuV)		Margin (dB)	Note
		QP-Mode	AV-Mode	QP-Mode	AV-Mode		
0.18	Neutral	51.07	*	64.42	54.42	-13.35	(QP)
0.36	Neutral	44.31	*	58.68	48.68	-14.37	(QP)
0.64	Neutral	42.94	*	56.00	46.00	-13.06	(QP)
1.41	Neutral	41.46	*	56.00	46.00	-14.54	(QP)
3.21	Neutral	42.37	*	56.00	46.00	-13.63	(QP)
13.21	Neutral	47.56	*	60.00	50.00	-12.44	(QP)

Remark

- (1) Reading in which marked as QP means measurements by using are Quasi-Peak Mode with Detector BW=9KHz; SPA setting in RBW=10KHz,VBW =10KHz, Swp. Time = 0.3 sec./MHz ◦ Reading in which marked as AV means measurements by using are Average Mode with instrument setting in RBW=1MHz,VBW=10Hz, Swp. Time =0.3 sec./MHz ◦
- (2) All readings are QP Mode value unless otherwise stated AVG in column of『Note』. If the QP Mode Measured value compliance with the QP Limits and lower than AVG Limits, the EUT shall be deemed to meet both QP & AVG Limits and then only QP Mode was measured, but AVG Mode didn't perform ◦ In this case, a “ * ” marked in AVG Mode column of Interference Voltage Measured ◦
- (3) Measuring frequency range from 150KHz to 30MHz ◦

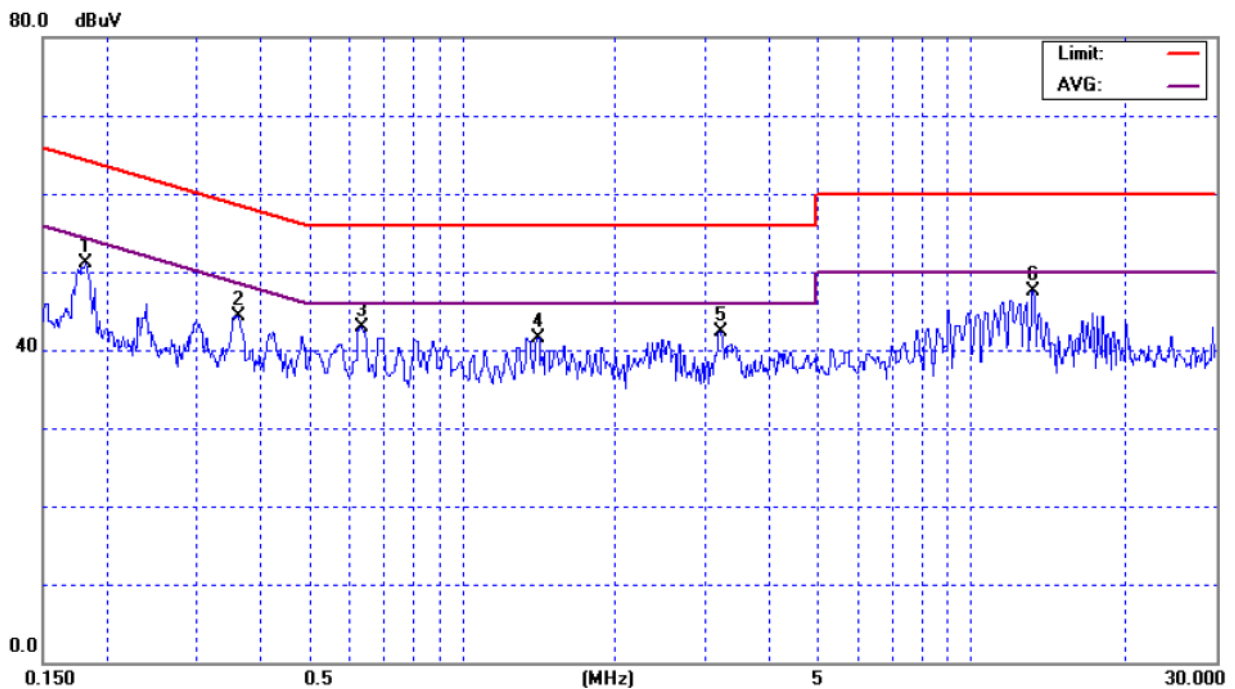

EUT :	Wireless Volp Phone	Model No. :	WLAN 800
Temperature :	26 °C	Relative Humidity :	58 %
Pressure :	1004 hPa	Test Power :	AC 120V/60Hz
Test Mode :	802.11g/CH11		

Freq. (MHz)	Terminal L/N	Measured(dBuV)		Limits(dBuV)		Margin (dB)	Note
		QP-Mode	AV-Mode	QP-Mode	AV-Mode		
0.18	Line	52.28	*	64.63	54.63	-12.35	(QP)
0.30	Line	45.29	*	60.35	50.35	-15.06	(QP)
0.87	Line	43.19	*	56.00	46.00	-12.81	(QP)
1.40	Line	42.67	*	56.00	46.00	-13.33	(QP)
11.96	Line	45.91	*	60.00	50.00	-14.09	(QP)
18.57	Line	44.55	*	60.00	50.00	-15.45	(QP)

Remark

- (1) Reading in which marked as QP means measurements by using are Quasi-Peak Mode with Detector BW=9KHz; SPA setting in RBW=10KHz,VBW =10KHz, Swp. Time = 0.3 sec./MHz ◦ Reading in which marked as AV means measurements by using are Average Mode with instrument setting in RBW=1MHz,VBW=10Hz, Swp. Time =0.3 sec./MHz ◦
- (2) All readings are QP Mode value unless otherwise stated AVG in column of『Note』. If the QP Mode Measured value compliance with the QP Limits and lower than AVG Limits, the EUT shall be deemed to meet both QP & AVG Limits and then only QP Mode was measured, but AVG Mode didn't perform ◦ In this case, a “ * ” marked in AVG Mode column of Interference Voltage Measured ◦
- (3) Measuring frequency range from 150KHz to 30MHz ◦

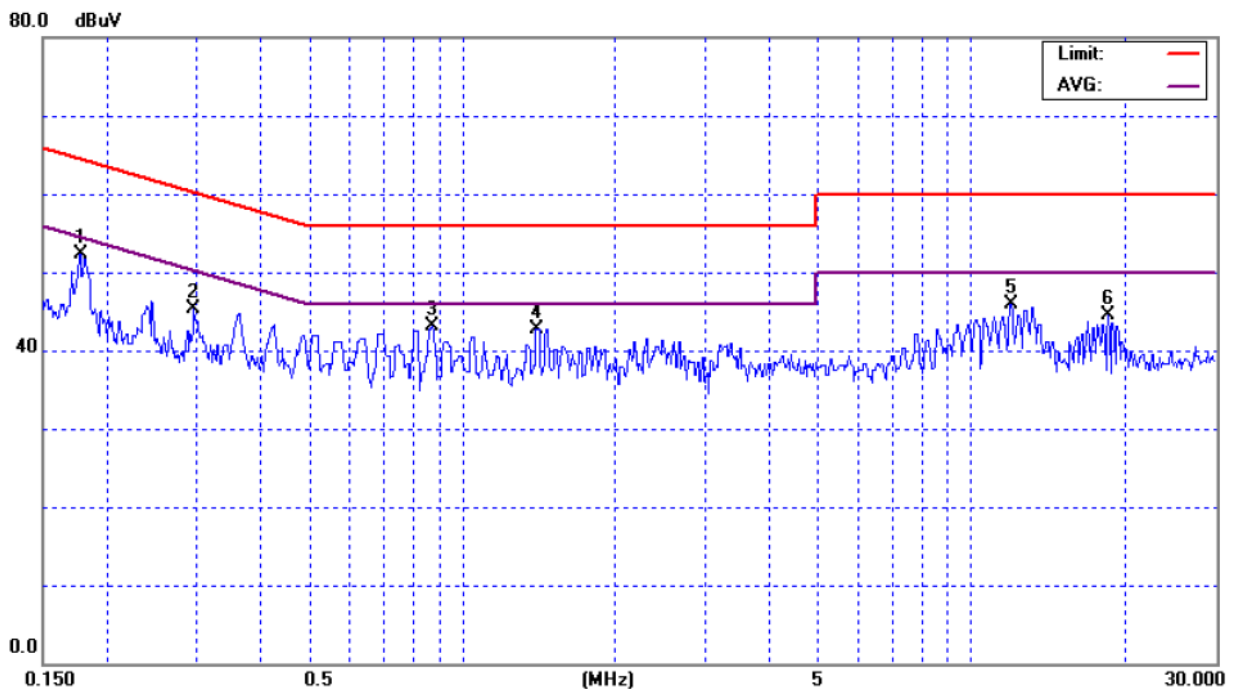

EUT :	Wireless Volp Phone	Model No. :	WLAN 800
Temperature :	26 °C	Relative Humidity :	58 %
Pressure :	1004 hPa	Test Power :	AC 120V/60Hz
Test Mode :	802.11g/CH11		

Freq. (MHz)	Terminal L/N	Measured(dBuV)		Limits(dBuV)		Margin (dB)	Note
		QP-Mode	AV-Mode	QP-Mode	AV-Mode		
0.18	Neutral	51.87	*	64.53	54.53	-12.66	(QP)
0.24	Neutral	46.67	*	62.04	52.04	-15.37	(QP)
0.36	Neutral	45.30	*	58.74	48.74	-13.44	(QP)
1.46	Neutral	42.06	*	56.00	46.00	-13.94	(QP)
2.42	Neutral	41.73	*	56.00	46.00	-14.27	(QP)
13.14	Neutral	46.36	*	60.00	50.00	-13.64	(QP)

Remark

- (1) Reading in which marked as QP means measurements by using are Quasi-Peak Mode with Detector BW=9KHz; SPA setting in RBW=10KHz,VBW =10KHz, Swp. Time = 0.3 sec./MHz ◦ Reading in which marked as AV means measurements by using are Average Mode with instrument setting in RBW=1MHz,VBW=10Hz, Swp. Time =0.3 sec./MHz ◦
- (2) All readings are QP Mode value unless otherwise stated AVG in column of『Note』. If the QP Mode Measured value compliance with the QP Limits and lower than AVG Limits, the EUT shall be deemed to meet both QP & AVG Limits and then only QP Mode was measured, but AVG Mode didn't perform ◦ In this case, a “ * ” marked in AVG Mode column of Interference Voltage Measured ◦
- (3) Measuring frequency range from 150KHz to 30MHz ◦

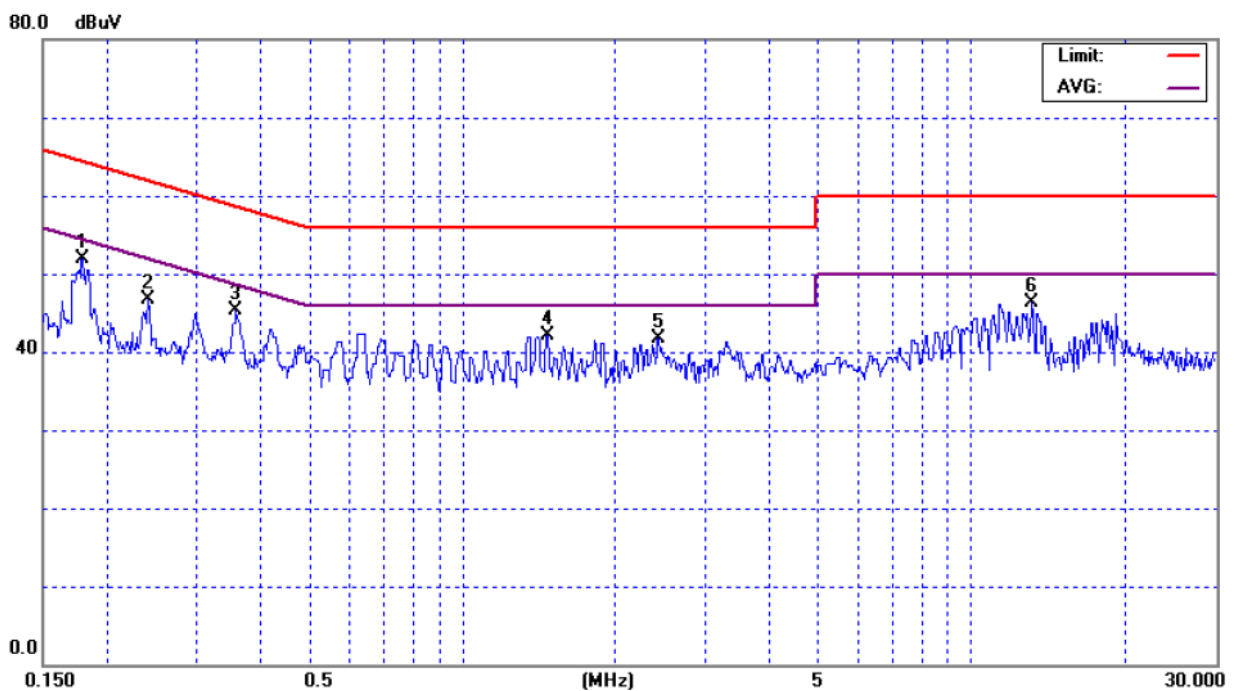

4.2 RADIATED EMISSION MEASUREMENT

4.2.1 RADIATED EMISSION LIMITS (Frequency Range 30MHz-1000MHz)

FREQUENCY (MHz)	Class A (dBuV)		Class B (dBuV)		Standard
	10m	30m	10m	3m	
30.00 -230.00	40.00	30.00	30.00	40.00	CISPR
230.0 -1000.0	47.00	37.00	37.00	47.00	CISPR

30.00 - 88.00	39.00	N/A	30.00	40.00	FCC
88.00 - 216.0	43.50	N/A	33.50	43.50	FCC
216.0 -960.0	46.00	N/A	36.00	46.00	FCC
above 960.0	49.50	N/A	46.00	54.00	FCC

Note:

- (1) The tighter limit applies at the band edges.
- (2) Emission level (dBuV/m)=20log Emission level (uV/m).
- (3) A measuring distance of 10m is a primary used. However, either 3m or 10m (instead of 10m) distance may be allowed. If the distance is 3m, add 10dB to the QP-limit above. If the distance is 10m, subtract 10dB from the QP-limit above.

LIMITS OF RADIATED EMISSION MEASUREMENT (Above 1000MHz)

FREQUENCY (MHz)	Class A (dBuV/m) (at 3m)		Class B (dBuV/m) (at 3m)	
	PEAK	AVERAGE	PEAK	AVERAGE
Above 1000	80	60	74	54

Notes:

- (1) The limit for radiated test was performed according to FCC PART 15B.
- (2) The tighter limit applies at the band edges.
- (3) Emission level (dBuV/m)=20log Emission level (uV/m).

FREQUENCY RANGE OF RADIATED MEASUREMENT (For unintentional radiators)

Highest frequency generated or Upper frequency of measurement used in the device or on which the device operates or tunes (MHz)	Range (MHz)
Below 1.705	30
1.705 – 108	1000
108 – 500	2000
500 – 1000	5000
Above 1000	5 th harmonic of the highest frequency or 40 GHz, whichever is lower

4.2.2 MEASUREMENT INSTRUMENTS LIST

Item	Kind of Equipment	Manufacturer	Type No.	Serial No.	Calibrated until
1	Log-Bicon Antenna	MESS-ELEKTRONIK	VULB 9160	3058	Nov. 29, 2006
2	Test Cable	N/A	10M_OS02	N/A	Nov. 29, 2006
3	Test Cable	N/A	OS02-1/-2/-3	N/A	Nov. 29, 2006
4	Pre-Amplifier	Anritsu	MH648A	M09961	Nov. 29, 2006
5	EMI Test Receiver	R&S	ESCI	100082	Feb. 01, 2007
6	Antenna Mast	Chance Most	CMTB-1.5	N/A	N/A
7	Turn Table	Chance Most	CMTB-1.5	N/A	N/A

Remark: " N/A" denotes No Model No. / Serial No. and No Calibration specified.

4.2.3 TEST PROCEDURE

- a. The measuring distance of at 10 m shall be used for measurements at frequency up to 1GHz. For frequencies above 1GHz, any suitable measuring distance may be used.
- b. The EUT was placed on the top of a rotating table 0.8 meters above the ground at a 3m or 10 meter open area test site. The table was rotated 360 degrees to determine the position of the highest radiation.
- c. The height of the equipment or of the substitution antenna shall be 0.8 m; the height of the test antenna shall vary between 1 m to 4 m. Both horizontal and vertical polarizations of the antenna are set to make the measurement.
- d. The initial step in collecting conducted emission data is a spectrum analyzer peak detector mode pre-scanning the measurement frequency range. Significant peaks are then marked and then Quasi Peak detector mode re-measured.
- e. If the Peak Mode measured value compliance with and lower than Quasi Peak Mode Limit, the EUT shall be deemed to meet QP Limits and then no additional QP Mode measurement performed.
- f. For the actual test configuration, please refer to the related Item –EUT Test Photos.

4.2.4 DEVIATION FROM TEST STANDARD

No deviation

4.2.5 TEST SETUP

(A) Radiated Emission Test Set-Up, Frequency Below 1000MHz

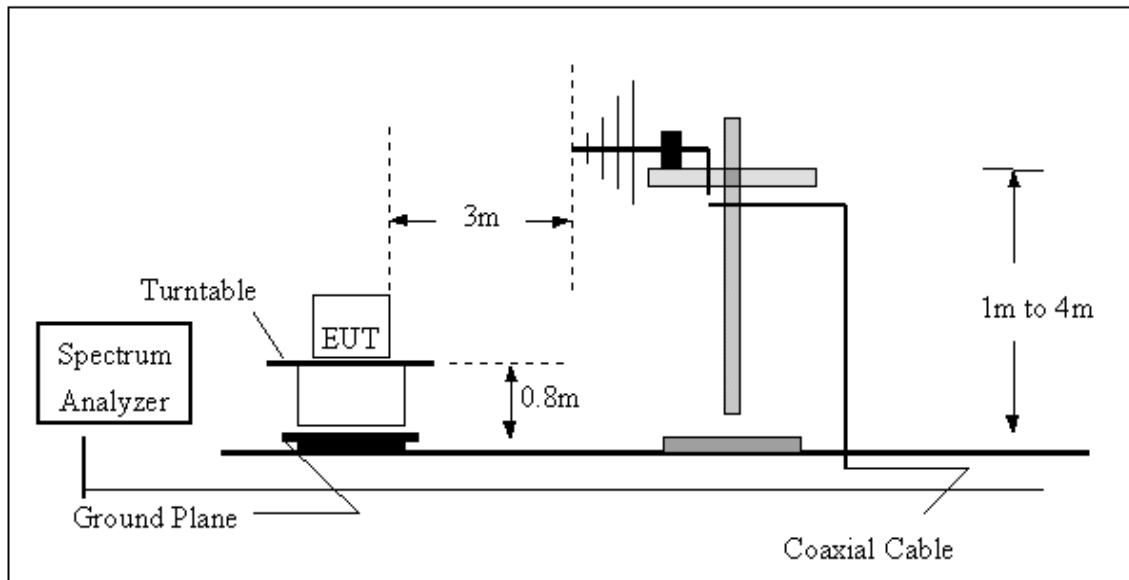

(B) Radiated Emission Test Set-UP Frequency Over 1 GHz

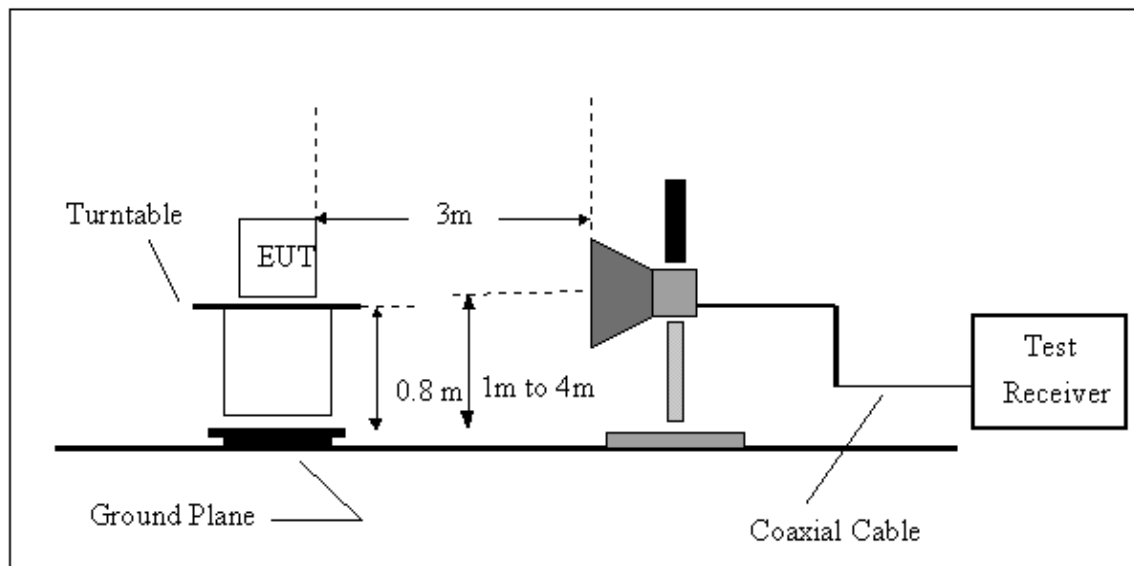

4.2.6 EUT OPERATING CONDITIONS

The EUT tested system was configured as the statements of 4.1.6 Unless otherwise a special operating condition is specified in the follows during the testing.

4.2.7 TEST RESULTS (Between 30 – 1000 MHz)

EUT :	Wireless Volp Phone	Model No. :	WLAN 800
Temperature :	25 °C	Relative Humidity :	62 %
Pressure :	1018 hPa	Test Power :	AC 120V/60Hz
Test Mode :	802.11b/CH01		

Freq. (MHz)	Ant. H/V	Reading(RA) (dBuV)	Corr.Factor(CF) (dB)	Measured(FS) (dBuV/m)	Limits(QP) (dBuV/m)	Margin (dB)	Note
109.53	V	37.60	-7.43	30.17	43.50	- 13.33	
147.91	V	32.04	-5.53	26.51	43.50	- 16.99	
159.86	V	31.43	-5.55	25.88	43.50	- 17.62	
214.20	V	38.09	-8.65	29.44	43.50	- 14.06	
331.50	V	39.12	-4.22	34.90	46.00	- 11.10	
565.62	V	32.87	1.22	34.09	46.00	- 11.91	

Remark :

- (1) Spectrum Setting : 30MHz – 1000MHz , RBW= 100KHz, VBW=100KHz, Sweep time = 200 ms. 1GHz- 25GHz, RBW= 1MHz, VBW= 1MHz, Sweep time = 200 ms
- (2) All readings are Peak unless otherwise stated QP in column of 『Note』 . Peak denotes that the Peak reading compliance with the QP Limits and then QP Mode measurement didn't perform ◦
- (3) Measuring frequency range from 30MHz to 1000MHz or the 10th harmonic of highest fundamental frequency ◦ “F” denotes fundamental frequency; “ H” denotes spurious frequency. “E” denotes band edge frequency.
- (4) Radiated emissions measured in frequency range from 30 MHz to 1000 MHz were made with an instrument using Peak detector mode or QP detector mode of the emission ◦
- (5) Data of measurement within this frequency range shown “ - ” in the table above means the reading of emissions are attenuated more than 20dB below the permissible limits or the field strength is too small to be measured.

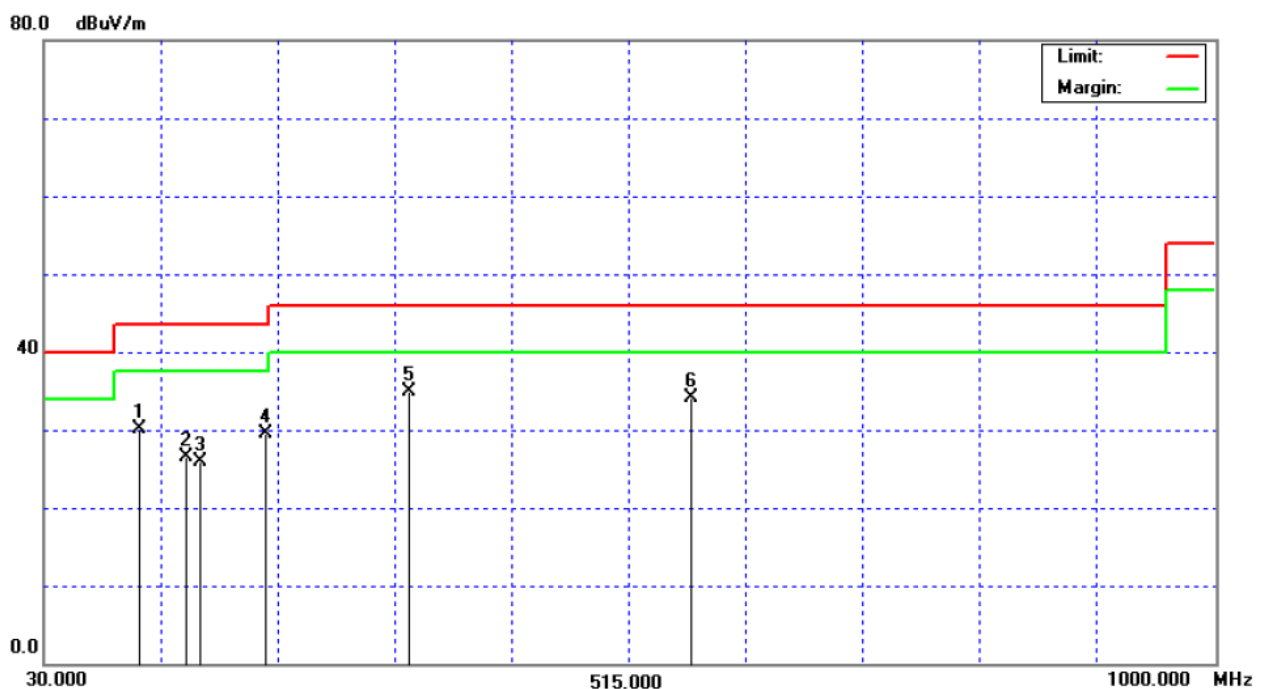

EUT :	Wireless Volp Phone	Model No. :	WLAN 800
Temperature :	25 °C	Relative Humidity :	62 %
Pressure :	1018 hPa	Test Power :	AC 120V/60Hz
Test Mode :	802.11b/CH01		

Freq. (MHz)	Ant. H/V	Reading(RA) (dBuV)	Corr.Factor(CF) (dB)	Measured(FS) (dBuV/m)	Limits(QP) (dBuV/m)	Margin (dB)	Note
233.40	H	36.14	-6.96	29.18	46.00	- 16.82	
282.44	H	39.88	-5.52	34.36	46.00	- 11.64	
334.27	H	37.20	-4.16	33.04	46.00	- 12.96	
345.11	H	38.96	-3.91	35.05	46.00	- 10.95	
409.60	H	36.16	-2.51	33.65	46.00	- 12.35	
449.37	H	35.00	-1.14	33.86	46.00	- 12.14	

Remark :

- (1) Spectrum Setting : 30MHz – 1000MHz , RBW= 100KHz, VBW=100KHz, Sweep time = 200 ms. 1GHz- 25GHz, RBW= 1MHz, VBW= 1MHz, Sweep time = 200 ms
- (2) All readings are Peak unless otherwise stated QP in column of 『Note』 . Peak denotes that the Peak reading compliance with the QP Limits and then QP Mode measurement didn't perform ◦
- (3) Measuring frequency range from 30MHz to 1000MHz or the 10th harmonic of highest fundamental frequency ◦ “F” denotes fundamental frequency; “ H” denotes spurious frequency. “E” denotes band edge frequency.
- (4) Radiated emissions measured in frequency range from 30 MHz to 1000 MHz were made with an instrument using Peak detector mode or QP detector mode of the emission ◦
- (5) Data of measurement within this frequency range shown “ - ” in the table above means the reading of emissions are attenuated more than 20dB below the permissible limits or the field strength is too small to be measured.

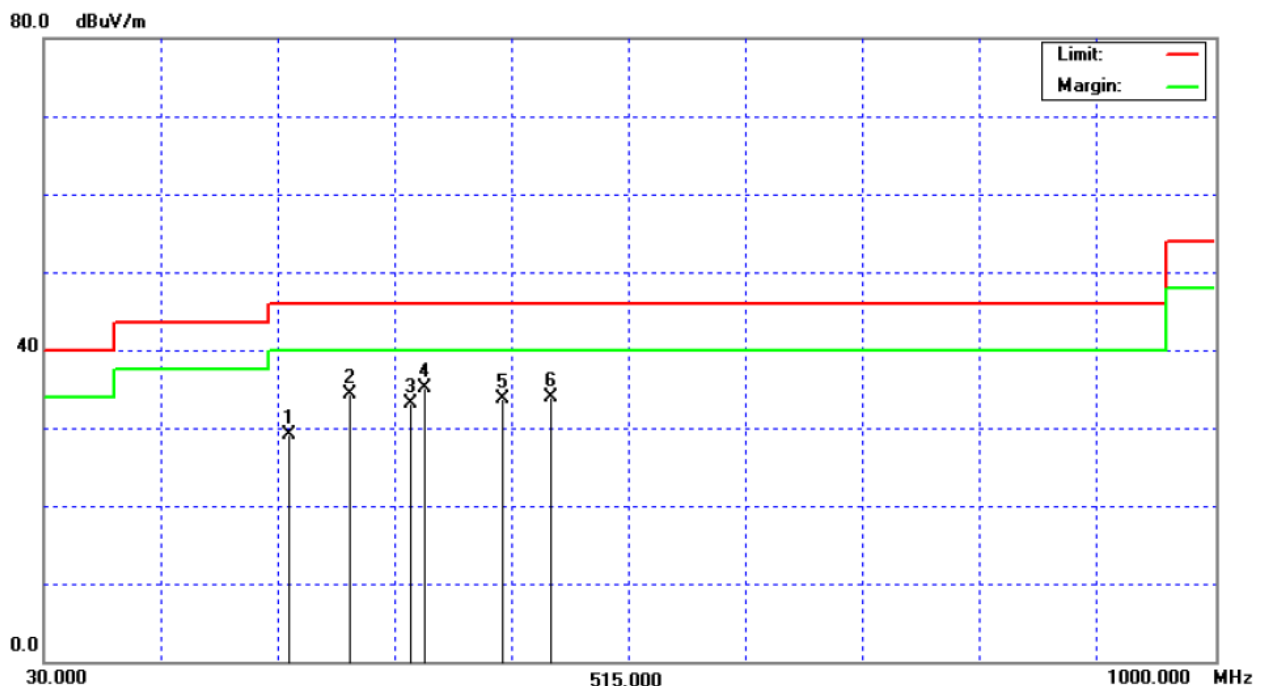

EUT :	Wireless Volp Phone	Model No. :	WLAN 800
Temperature :	25 °C	Relative Humidity :	62 %
Pressure :	1018 hPa	Test Power :	AC 120V/60Hz
Test Mode :	802.11b/CH06		

Freq. (MHz)	Ant. H/V	Reading(RA) (dBuV)	Corr.Factor(CF) (dB)	Measured(FS) (dBuV/m)	Limits(QP) (dBuV/m)	Margin (dB)	Note
108.93	V	36.11	-7.57	28.54	43.50	- 14.96	
148.03	V	31.84	-5.52	26.32	43.50	- 17.18	
159.90	V	30.81	-5.55	25.26	43.50	- 18.24	
214.43	V	37.54	-8.62	28.92	43.50	- 14.58	
331.70	V	38.66	-4.22	34.44	46.00	- 11.56	
565.14	V	32.90	1.21	34.11	46.00	- 11.89	

Remark :

- (1) Spectrum Setting : 30MHz – 1000MHz , RBW= 100KHz, VBW=100KHz, Sweep time = 200 ms. 1GHz- 25GHz, RBW= 1MHz, VBW= 1MHz, Sweep time = 200 ms
- (2) All readings are Peak unless otherwise stated QP in column of 『Note』 . Peak denotes that the Peak reading compliance with the QP Limits and then QP Mode measurement didn't perform ◦
- (3) Measuring frequency range from 30MHz to 1000MHz or the 10th harmonic of highest fundamental frequency ◦ “F” denotes fundamental frequency; “ H” denotes spurious frequency. “E” denotes band edge frequency.
- (4) Radiated emissions measured in frequency range from 30 MHz to 1000 MHz were made with an instrument using Peak detector mode or QP detector mode of the emission ◦
- (5) Data of measurement within this frequency range shown “ - ” in the table above means the reading of emissions are attenuated more than 20dB below the permissible limits or the field strength is too small to be measured.

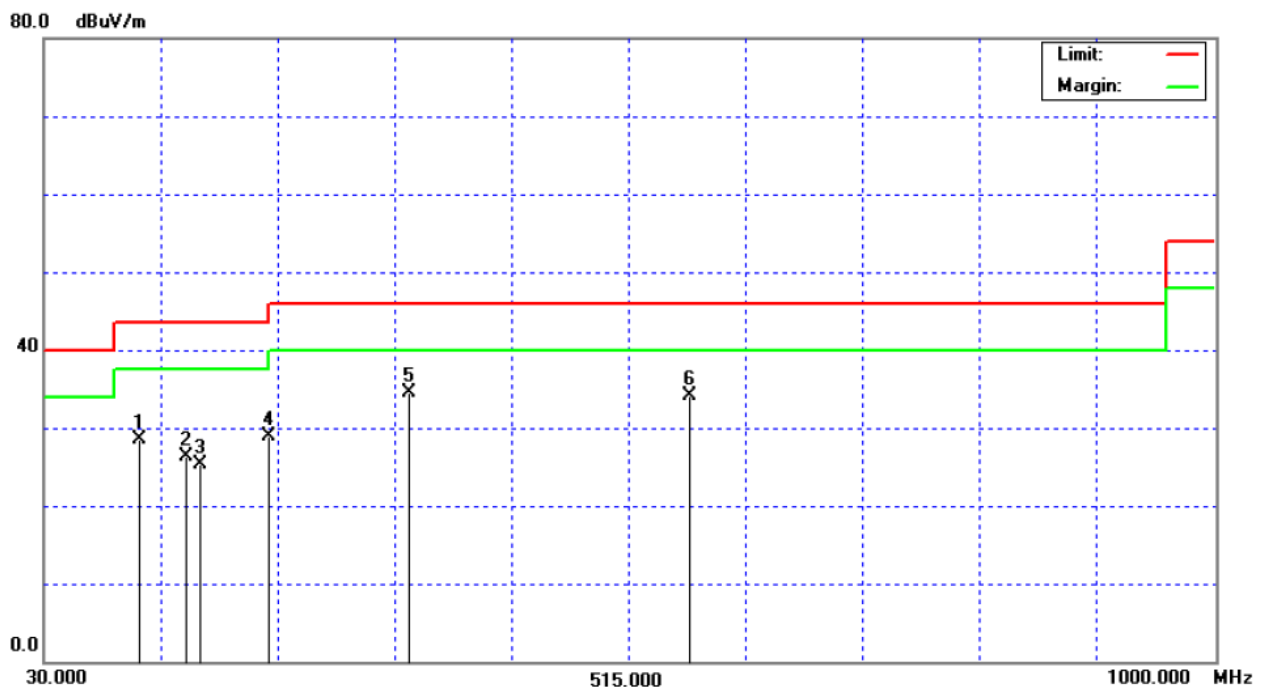

EUT :	Wireless Volp Phone	Model No. :	WLAN 800
Temperature :	25 °C	Relative Humidity :	62 %
Pressure :	1018 hPa	Test Power :	AC 120V/60Hz
Test Mode :	802.11b/CH06		

Freq. (MHz)	Ant. H/V	Reading(RA) (dBuV)	Corr.Factor(CF) (dB)	Measured(FS) (dBuV/m)	Limits(QP) (dBuV/m)	Margin (dB)	Note
233.29	H	35.99	-6.97	29.02	46.00	- 16.98	
282.14	H	39.65	-5.53	34.12	46.00	- 11.88	
333.87	H	36.40	-4.17	32.23	46.00	- 13.77	
345.09	H	36.50	-3.91	32.59	46.00	- 13.41	
409.14	H	34.82	-2.53	32.29	46.00	- 13.71	
449.74	H	33.79	-1.13	32.66	46.00	- 13.34	

Remark :

- (1) Spectrum Setting : 30MHz – 1000MHz , RBW= 100KHz, VBW=100KHz, Sweep time = 200 ms. 1GHz- 25GHz, RBW= 1MHz, VBW= 1MHz, Sweep time = 200 ms
- (2) All readings are Peak unless otherwise stated QP in column of 『Note』 . Peak denotes that the Peak reading compliance with the QP Limits and then QP Mode measurement didn't perform ◦
- (3) Measuring frequency range from 30MHz to 1000MHz or the 10th harmonic of highest fundamental frequency ◦ “F” denotes fundamental frequency; “ H” denotes spurious frequency. “E” denotes band edge frequency.
- (4) Radiated emissions measured in frequency range from 30 MHz to 1000 MHz were made with an instrument using Peak detector mode or QP detector mode of the emission ◦
- (5) Data of measurement within this frequency range shown “ - ” in the table above means the reading of emissions are attenuated more than 20dB below the permissible limits or the field strength is too small to be measured.

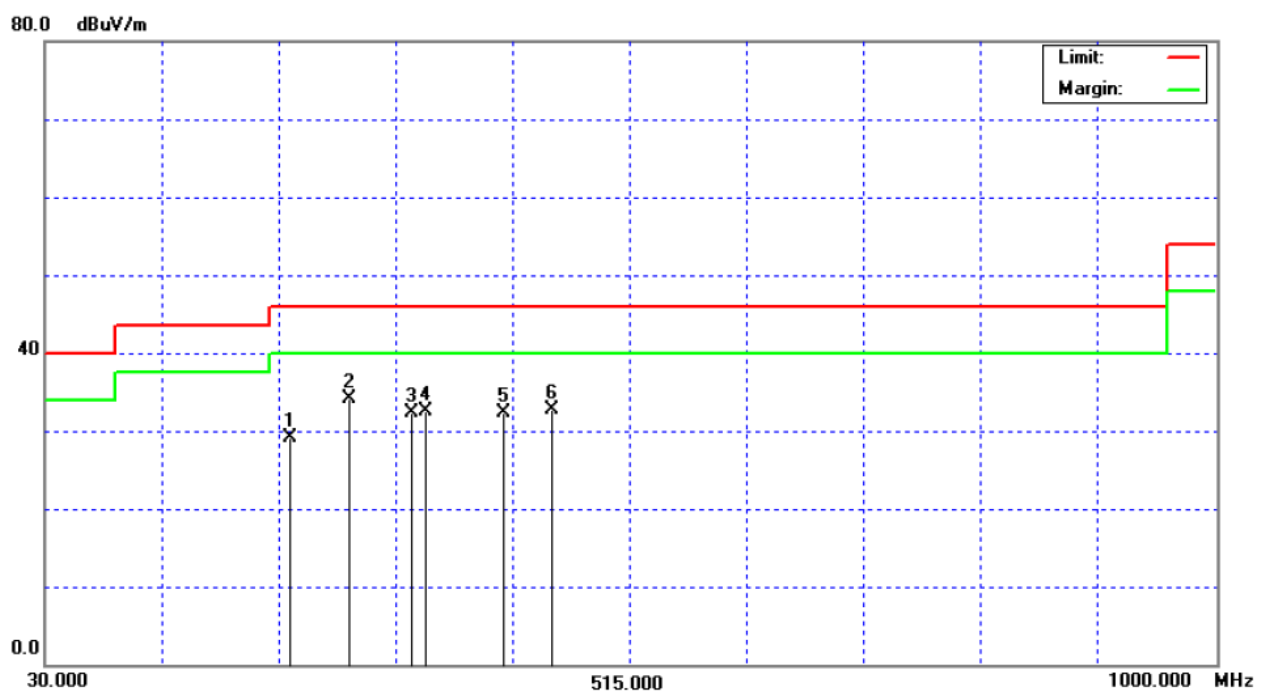

EUT :	Wireless Volp Phone	Model No. :	WLAN 800
Temperature :	25 °C	Relative Humidity :	62 %
Pressure :	1018 hPa	Test Power :	AC 120V/60Hz
Test Mode :	802.11b/CH11		

Freq. (MHz)	Ant. H/V	Reading(RA) (dBuV)	Corr.Factor(CF) (dB)	Measured(FS) (dBuV/m)	Limits(QP) (dBuV/m)	Margin (dB)	Note
109.63	V	35.79	-7.42	28.37	43.50	- 15.13	
147.56	V	31.99	-5.54	26.45	43.50	- 17.05	
159.68	V	32.77	-5.55	27.22	43.50	- 16.28	
214.10	V	37.43	-8.67	28.76	43.50	- 14.74	
330.98	V	37.72	-4.23	33.49	46.00	- 12.51	
565.34	V	32.98	1.22	34.20	46.00	- 11.80	

Remark :

- (1) Spectrum Setting : 30MHz – 1000MHz , RBW= 100KHz, VBW=100KHz, Sweep time = 200 ms. 1GHz- 25GHz, RBW= 1MHz, VBW= 1MHz, Sweep time = 200 ms
- (2) All readings are Peak unless otherwise stated QP in column of 『Note』 . Peak denotes that the Peak reading compliance with the QP Limits and then QP Mode measurement didn't perform ◦
- (3) Measuring frequency range from 30MHz to 1000MHz or the 10th harmonic of highest fundamental frequency ◦ “F” denotes fundamental frequency; “ H” denotes spurious frequency. “E” denotes band edge frequency.
- (4) Radiated emissions measured in frequency range from 30 MHz to 1000 MHz were made with an instrument using Peak detector mode or QP detector mode of the emission ◦
- (5) Data of measurement within this frequency range shown “ - ” in the table above means the reading of emissions are attenuated more than 20dB below the permissible limits or the field strength is too small to be measured.

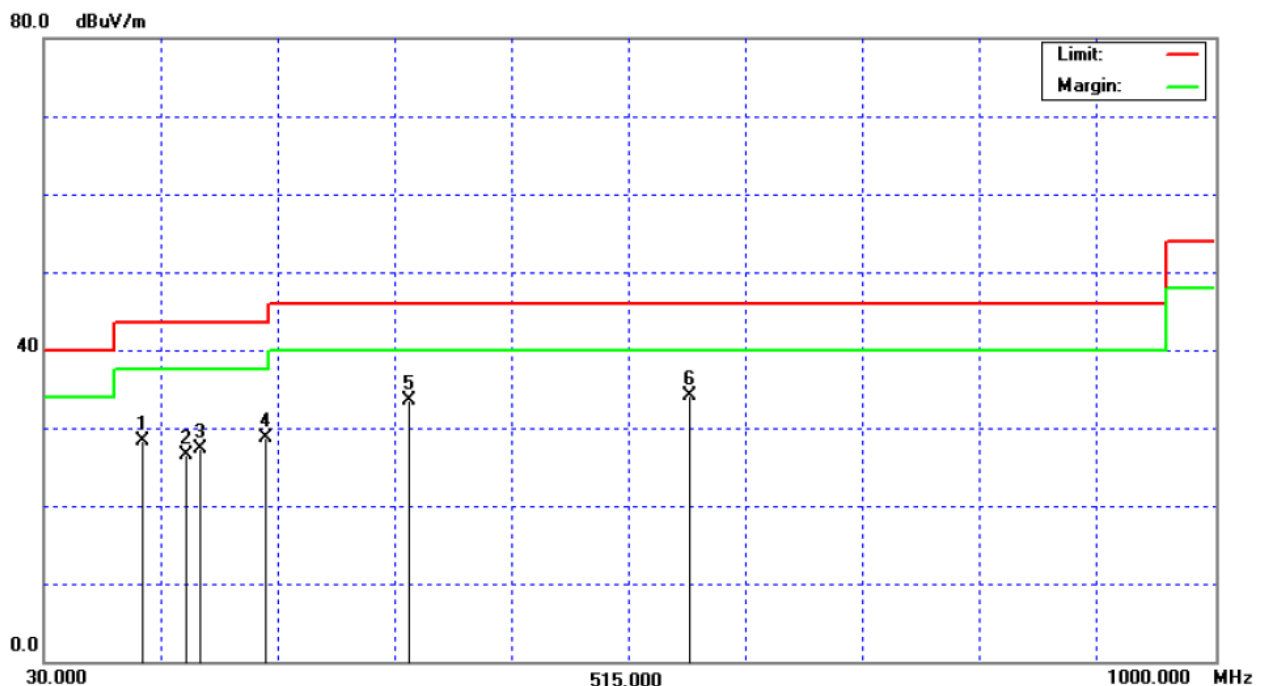

EUT :	Wireless Volp Phone	Model No. :	WLAN 800
Temperature :	25 °C	Relative Humidity :	62 %
Pressure :	1018 hPa	Test Power :	AC 120V/60Hz
Test Mode :	802.11b/CH11		

Freq. (MHz)	Ant. H/V	Reading(RA) (dBuV)	Corr.Factor(CF) (dB)	Measured(FS) (dBuV/m)	Limits(QP) (dBuV/m)	Margin (dB)	Note
233.75	H	34.88	-6.94	27.94	46.00	- 18.06	
282.43	H	37.64	-5.52	32.12	46.00	- 13.88	
334.09	H	35.58	-4.16	31.42	46.00	- 14.58	
345.71	H	36.80	-3.90	32.90	46.00	- 13.10	
409.35	H	35.00	-2.52	32.48	46.00	- 13.52	
449.72	H	36.88	-1.13	35.75	46.00	- 10.25	

Remark :

- (1) Spectrum Setting : 30MHz – 1000MHz , RBW= 100KHz, VBW=100KHz, Sweep time = 200 ms. 1GHz- 25GHz, RBW= 1MHz, VBW= 1MHz, Sweep time = 200 ms
- (2) All readings are Peak unless otherwise stated QP in column of 『Note』 . Peak denotes that the Peak reading compliance with the QP Limits and then QP Mode measurement didn't perform ◦
- (3) Measuring frequency range from 30MHz to 1000MHz or the 10th harmonic of highest fundamental frequency ◦ “F” denotes fundamental frequency; “ H” denotes spurious frequency. “E” denotes band edge frequency.
- (4) Radiated emissions measured in frequency range from 30 MHz to 1000 MHz were made with an instrument using Peak detector mode or QP detector mode of the emission ◦
- (5) Data of measurement within this frequency range shown “ - ” in the table above means the reading of emissions are attenuated more than 20dB below the permissible limits or the field strength is too small to be measured.

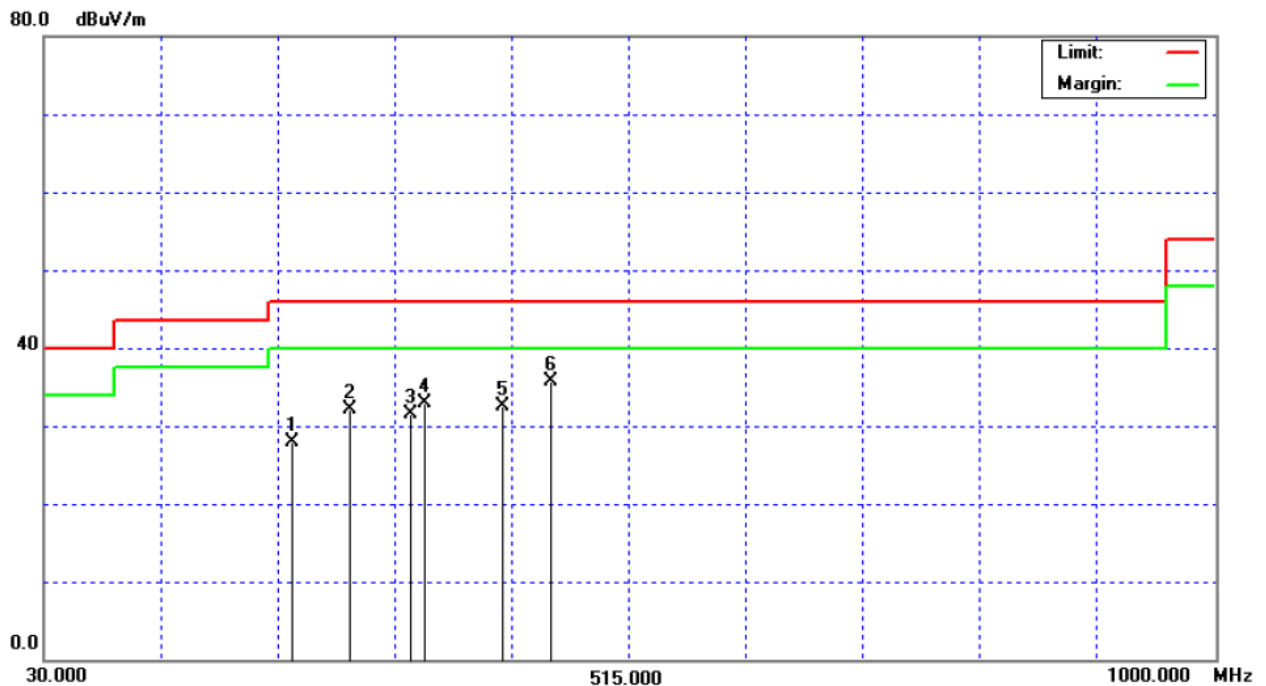

EUT :	Wireless Volp Phone	Model No. :	WLAN 800
Temperature :	25 °C	Relative Humidity :	62 %
Pressure :	1018 hPa	Test Power :	AC 120V/60Hz
Test Mode :	802.11g/CH01		

Freq. (MHz)	Ant. H/V	Reading(RA) (dBuV)	Corr.Factor(CF) (dB)	Measured(FS) (dBuV/m)	Limits(QP) (dBuV/m)	Margin (dB)	Note
108.79	V	35.96	-7.60	28.36	43.50	- 15.14	
147.99	V	33.24	-5.52	27.72	43.50	- 15.78	
159.65	V	30.81	-5.55	25.26	43.50	- 18.24	
214.53	V	37.34	-8.61	28.73	43.50	- 14.77	
331.70	V	36.40	-4.22	32.18	46.00	- 13.82	
565.55	V	31.82	1.22	33.04	46.00	- 12.96	

Remark :

- (1) Spectrum Setting : 30MHz – 1000MHz , RBW= 100KHz, VBW=100KHz, Sweep time = 200 ms. 1GHz- 25GHz, RBW= 1MHz, VBW= 1MHz, Sweep time = 200 ms
- (2) All readings are Peak unless otherwise stated QP in column of 『Note』 . Peak denotes that the Peak reading compliance with the QP Limits and then QP Mode measurement didn't perform ◦
- (3) Measuring frequency range from 30MHz to 1000MHz or the 10th harmonic of highest fundamental frequency ◦ “F” denotes fundamental frequency; “ H” denotes spurious frequency. “E” denotes band edge frequency.
- (4) Radiated emissions measured in frequency range from 30 MHz to 1000 MHz were made with an instrument using Peak detector mode or QP detector mode of the emission ◦
- (5) Data of measurement within this frequency range shown “ - ” in the table above means the reading of emissions are attenuated more than 20dB below the permissible limits or the field strength is too small to be measured.

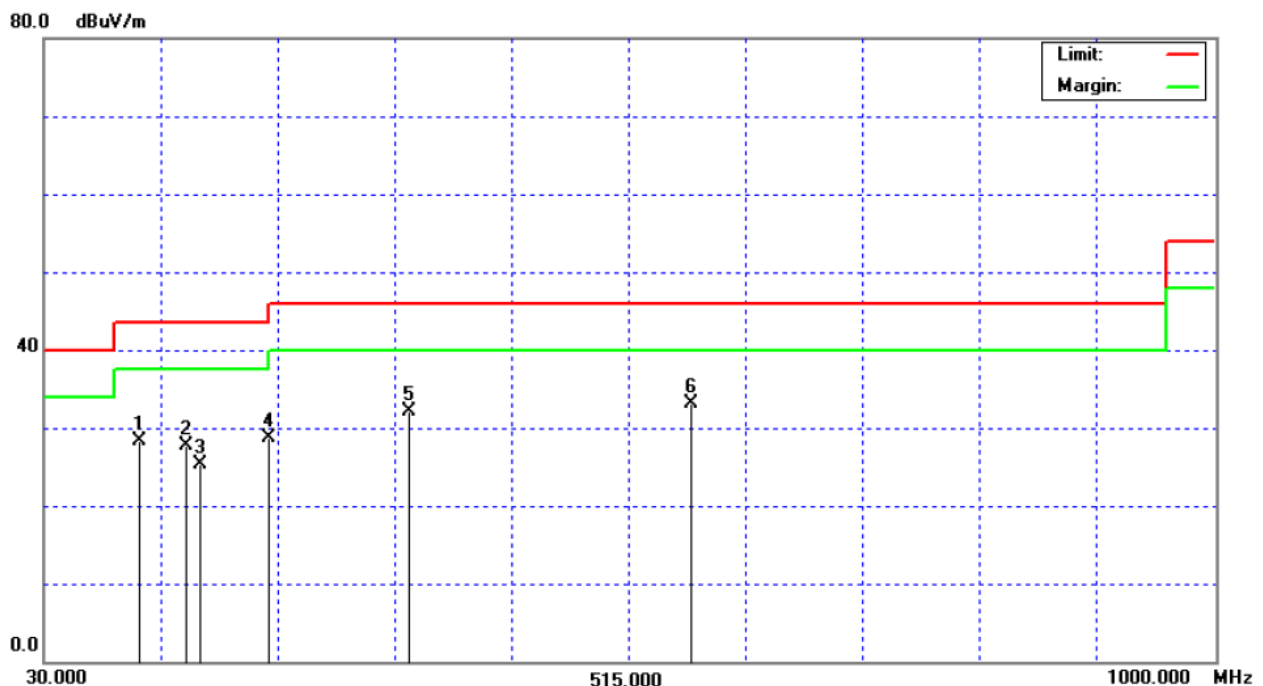

EUT :	Wireless Volp Phone	Model No. :	WLAN 800
Temperature :	25 °C	Relative Humidity :	62 %
Pressure :	1018 hPa	Test Power :	AC 120V/60Hz
Test Mode :	802.11g/CH01		

Freq. (MHz)	Ant. H/V	Reading(RA) (dBuV)	Corr.Factor(CF) (dB)	Measured(FS) (dBuV/m)	Limits(QP) (dBuV/m)	Margin (dB)	Note
233.09	H	37.05	-6.98	30.07	46.00	- 15.93	
282.51	H	38.65	-5.52	33.13	46.00	- 12.87	
334.65	H	37.03	-4.15	32.88	46.00	- 13.12	
345.28	H	38.05	-3.91	34.14	46.00	- 11.86	
409.35	H	35.70	-2.52	33.18	46.00	- 12.82	
449.45	H	35.09	-1.14	33.95	46.00	- 12.05	

Remark :

- (1) Spectrum Setting : 30MHz – 1000MHz , RBW= 100KHz, VBW=100KHz, Sweep time = 200 ms. 1GHz- 25GHz, RBW= 1MHz, VBW= 1MHz, Sweep time = 200 ms
- (2) All readings are Peak unless otherwise stated QP in column of 『Note』 . Peak denotes that the Peak reading compliance with the QP Limits and then QP Mode measurement didn't perform ◦
- (3) Measuring frequency range from 30MHz to 1000MHz or the 10th harmonic of highest fundamental frequency ◦ “F” denotes fundamental frequency; “ H” denotes spurious frequency. “E” denotes band edge frequency.
- (4) Radiated emissions measured in frequency range from 30 MHz to 1000 MHz were made with an instrument using Peak detector mode or QP detector mode of the emission ◦
- (5) Data of measurement within this frequency range shown “ - ” in the table above means the reading of emissions are attenuated more than 20dB below the permissible limits or the field strength is too small to be measured.

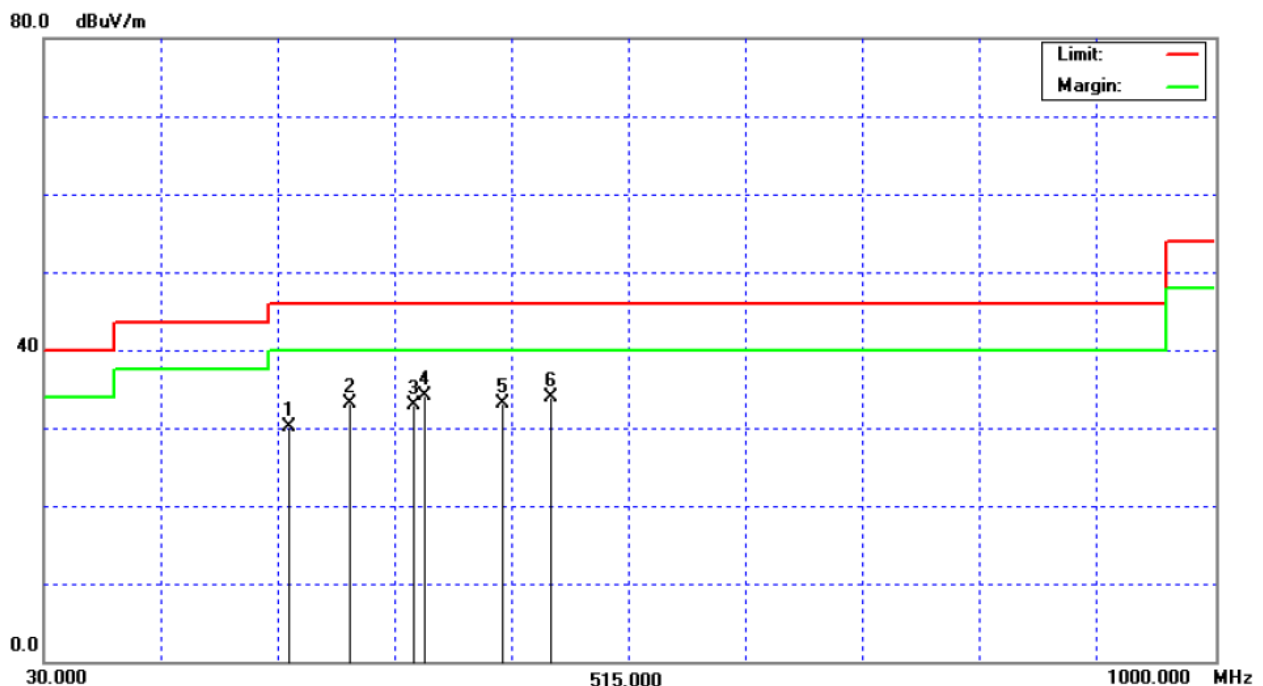

EUT :	Wireless Volp Phone	Model No. :	WLAN 800
Temperature :	25 °C	Relative Humidity :	62 %
Pressure :	1018 hPa	Test Power :	AC 120V/60Hz
Test Mode :	802.11g/CH06		

Freq. (MHz)	Ant. H/V	Reading(RA) (dBuV)	Corr.Factor(CF) (dB)	Measured(FS) (dBuV/m)	Limits(QP) (dBuV/m)	Margin (dB)	Note
109.42	V	36.06	-7.46	28.60	43.50	- 14.90	
147.64	V	31.70	-5.54	26.16	43.50	- 17.34	
159.94	V	32.00	-5.55	26.45	43.50	- 17.05	
214.31	V	37.40	-8.64	28.76	43.50	- 14.74	
331.33	V	35.29	-4.23	31.06	46.00	- 14.94	
565.77	V	32.61	1.23	33.84	46.00	- 12.16	

Remark :

- (1) Spectrum Setting : 30MHz – 1000MHz , RBW= 100KHz, VBW=100KHz, Sweep time = 200 ms. 1GHz- 25GHz, RBW= 1MHz, VBW= 1MHz, Sweep time = 200 ms
- (2) All readings are Peak unless otherwise stated QP in column of 『Note』 . Peak denotes that the Peak reading compliance with the QP Limits and then QP Mode measurement didn't perform ◦
- (3) Measuring frequency range from 30MHz to 1000MHz or the 10th harmonic of highest fundamental frequency ◦ “F” denotes fundamental frequency; “ H” denotes spurious frequency. “E” denotes band edge frequency.
- (4) Radiated emissions measured in frequency range from 30 MHz to 1000 MHz were made with an instrument using Peak detector mode or QP detector mode of the emission ◦
- (5) Data of measurement within this frequency range shown “ - ” in the table above means the reading of emissions are attenuated more than 20dB below the permissible limits or the field strength is too small to be measured.

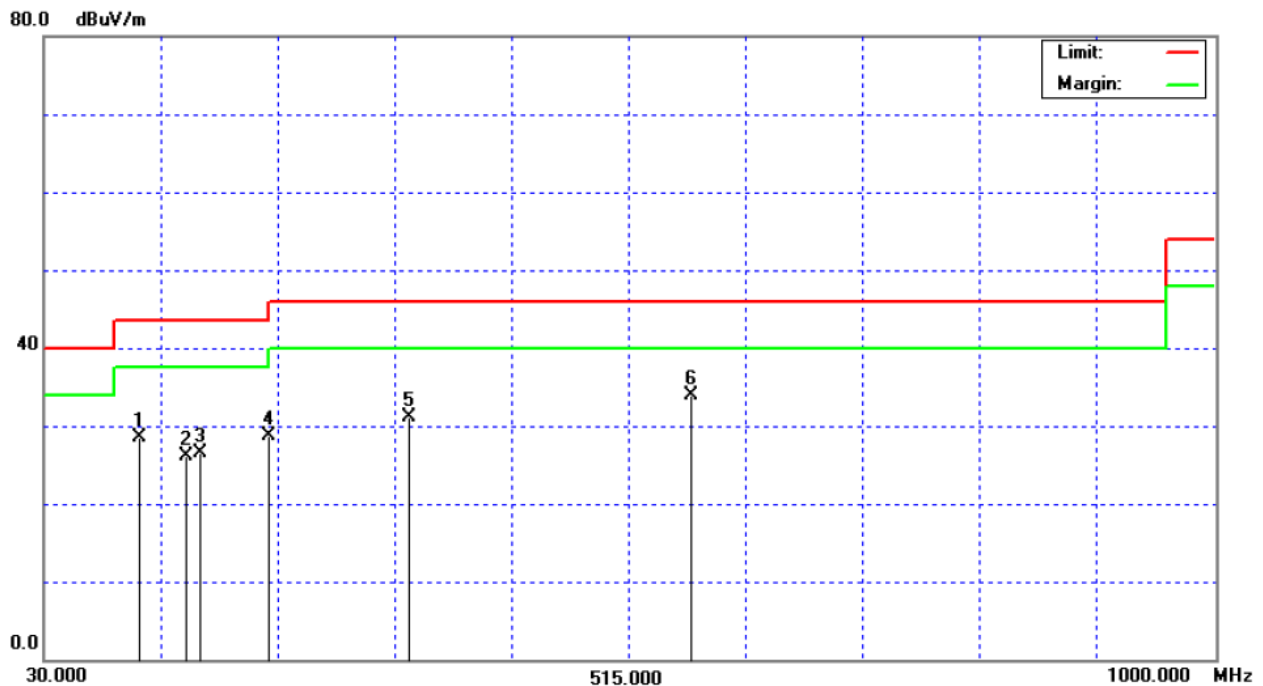

EUT :	Wireless Volp Phone	Model No. :	WLAN 800
Temperature :	25 °C	Relative Humidity :	62 %
Pressure :	1018 hPa	Test Power :	AC 120V/60Hz
Test Mode :	802.11g/CH06		

Freq. (MHz)	Ant. H/V	Reading(RA) (dBuV)	Corr.Factor(CF) (dB)	Measured(FS) (dBuV/m)	Limits(QP) (dBuV/m)	Margin (dB)	Note
233.42	H	35.51	-6.96	28.55	46.00	- 17.45	
282.19	H	37.86	-5.53	32.33	46.00	- 13.67	
334.54	H	34.40	-4.15	30.25	46.00	- 15.75	
345.23	H	37.41	-3.91	33.50	46.00	- 12.50	
409.38	H	35.18	-2.52	32.66	46.00	- 13.34	
449.24	H	33.79	-1.14	32.65	46.00	- 13.35	

Remark :

- (1) Spectrum Setting : 30MHz – 1000MHz , RBW= 100KHz, VBW=100KHz, Sweep time = 200 ms. 1GHz- 25GHz, RBW= 1MHz, VBW= 1MHz, Sweep time = 200 ms
- (2) All readings are Peak unless otherwise stated QP in column of 『Note』 . Peak denotes that the Peak reading compliance with the QP Limits and then QP Mode measurement didn't perform ◦
- (3) Measuring frequency range from 30MHz to 1000MHz or the 10th harmonic of highest fundamental frequency ◦ “F” denotes fundamental frequency; “ H” denotes spurious frequency. “E” denotes band edge frequency.
- (4) Radiated emissions measured in frequency range from 30 MHz to 1000 MHz were made with an instrument using Peak detector mode or QP detector mode of the emission ◦
- (5) Data of measurement within this frequency range shown “ - ” in the table above means the reading of emissions are attenuated more than 20dB below the permissible limits or the field strength is too small to be measured.

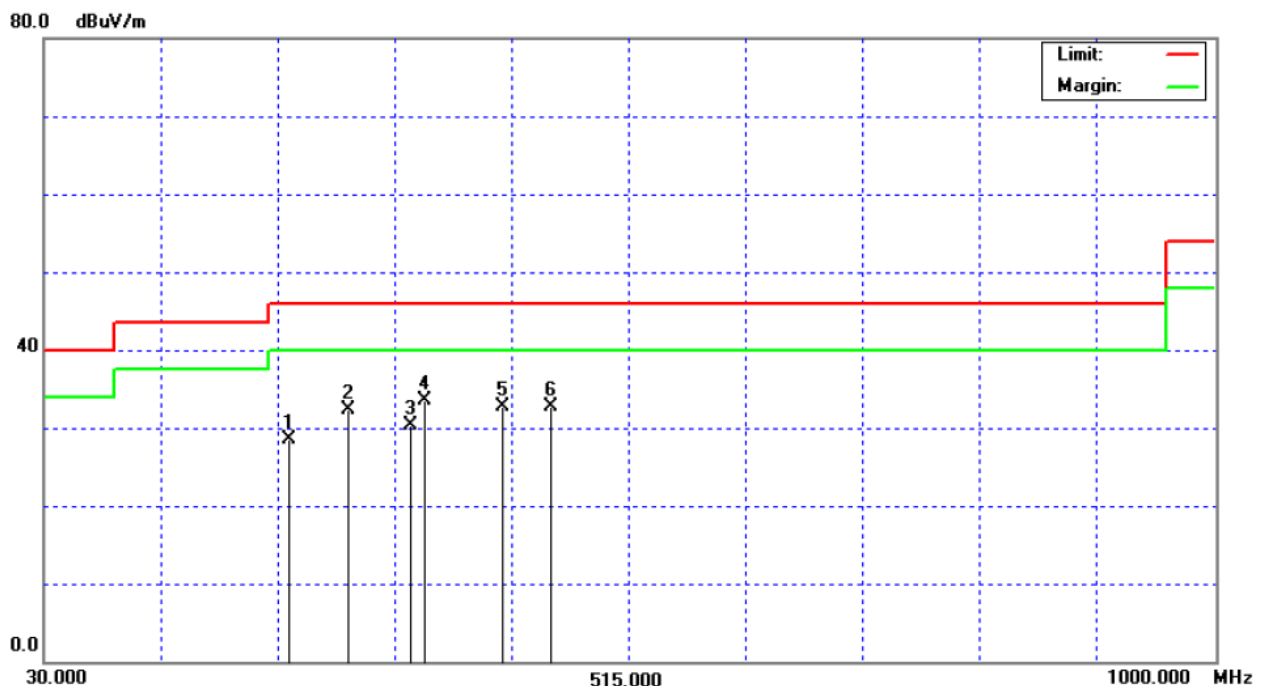

EUT :	Wireless Volp Phone	Model No. :	WLAN 800
Temperature :	25 °C	Relative Humidity :	62 %
Pressure :	1018 hPa	Test Power :	AC 120V/60Hz
Test Mode :	802.11g/CH11		

Freq. (MHz)	Ant. H/V	Reading(RA) (dBuV)	Corr.Factor(CF) (dB)	Measured(FS) (dBuV/m)	Limits(QP) (dBuV/m)	Margin (dB)	Note
108.96	V	36.62	-7.56	29.06	43.50	- 14.44	
147.58	V	30.90	-5.54	25.36	43.50	- 18.14	
159.37	V	30.88	-5.54	25.34	43.50	- 18.16	
214.18	V	37.44	-8.66	28.78	43.50	- 14.72	
330.50	V	36.66	-4.25	32.41	46.00	- 13.59	
565.52	V	33.30	1.22	34.52	46.00	- 11.48	

Remark :

- (1) Spectrum Setting : 30MHz – 1000MHz , RBW= 100KHz, VBW=100KHz, Sweep time = 200 ms. 1GHz- 25GHz, RBW= 1MHz, VBW= 1MHz, Sweep time = 200 ms
- (2) All readings are Peak unless otherwise stated QP in column of 『Note』 . Peak denotes that the Peak reading compliance with the QP Limits and then QP Mode measurement didn't perform ◦
- (3) Measuring frequency range from 30MHz to 1000MHz or the 10th harmonic of highest fundamental frequency ◦ “F” denotes fundamental frequency; “ H” denotes spurious frequency. “E” denotes band edge frequency.
- (4) Radiated emissions measured in frequency range from 30 MHz to 1000 MHz were made with an instrument using Peak detector mode or QP detector mode of the emission ◦
- (5) Data of measurement within this frequency range shown “ - ” in the table above means the reading of emissions are attenuated more than 20dB below the permissible limits or the field strength is too small to be measured.

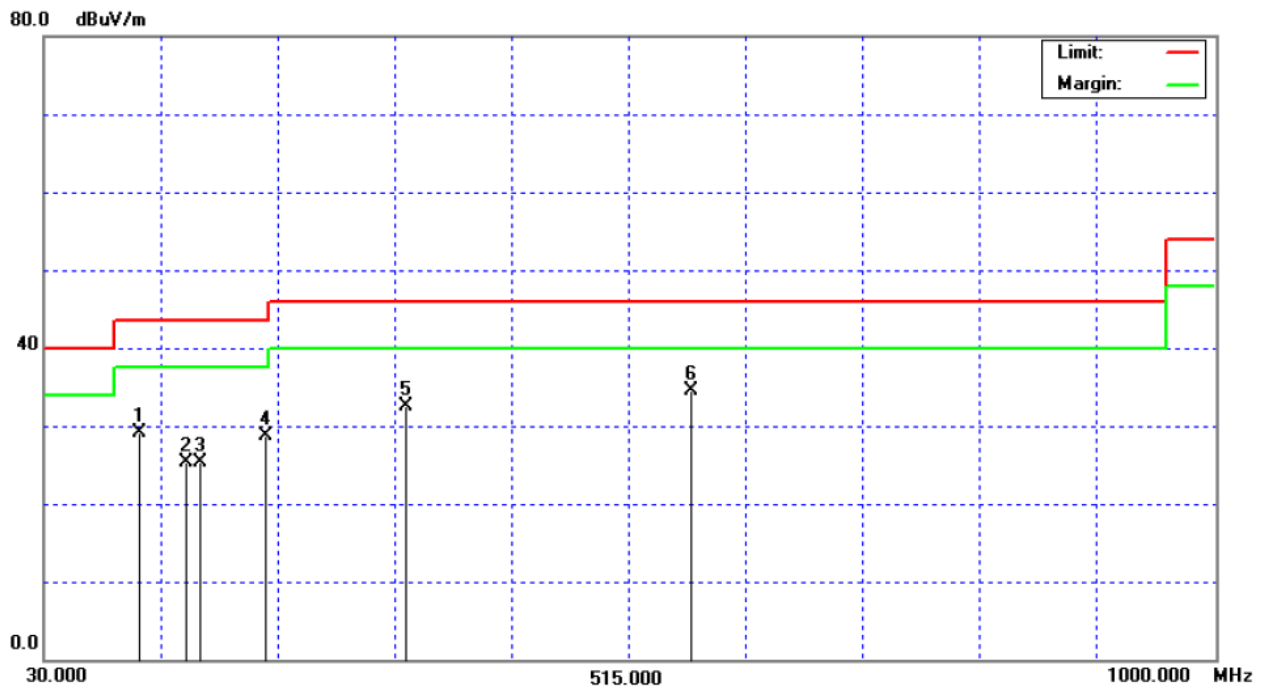

EUT :	Wireless Volp Phone	Model No. :	WLAN 800
Temperature :	25 °C	Relative Humidity :	62 %
Pressure :	1018 hPa	Test Power :	AC 120V/60Hz
Test Mode :	802.11g/CH11		

Freq. (MHz)	Ant. H/V	Reading(RA) (dBuV)	Corr.Factor(CF) (dB)	Measured(FS) (dBuV/m)	Limits(QP) (dBuV/m)	Margin (dB)	Note
233.00	H	35.12	-6.99	28.13	46.00	- 17.87	
282.27	H	37.22	-5.53	31.69	46.00	- 14.31	
334.65	H	36.04	-4.15	31.89	46.00	- 14.11	
345.35	H	35.61	-3.91	31.70	46.00	- 14.30	
409.78	H	35.80	-2.51	33.29	46.00	- 12.71	
449.13	H	34.60	-1.15	33.45	46.00	- 12.55	

Remark :

- (1) Spectrum Setting : 30MHz – 1000MHz , RBW= 100KHz, VBW=100KHz, Sweep time = 200 ms. 1GHz- 25GHz, RBW= 1MHz, VBW= 1MHz, Sweep time = 200 ms
- (2) All readings are Peak unless otherwise stated QP in column of 『Note』 . Peak denotes that the Peak reading compliance with the QP Limits and then QP Mode measurement didn't perform ◦
- (3) Measuring frequency range from 30MHz to 1000MHz or the 10th harmonic of highest fundamental frequency ◦ “F” denotes fundamental frequency; “ H” denotes spurious frequency. “E” denotes band edge frequency.
- (4) Radiated emissions measured in frequency range from 30 MHz to 1000 MHz were made with an instrument using Peak detector mode or QP detector mode of the emission ◦
- (5) Data of measurement within this frequency range shown “ - ” in the table above means the reading of emissions are attenuated more than 20dB below the permissible limits or the field strength is too small to be measured.

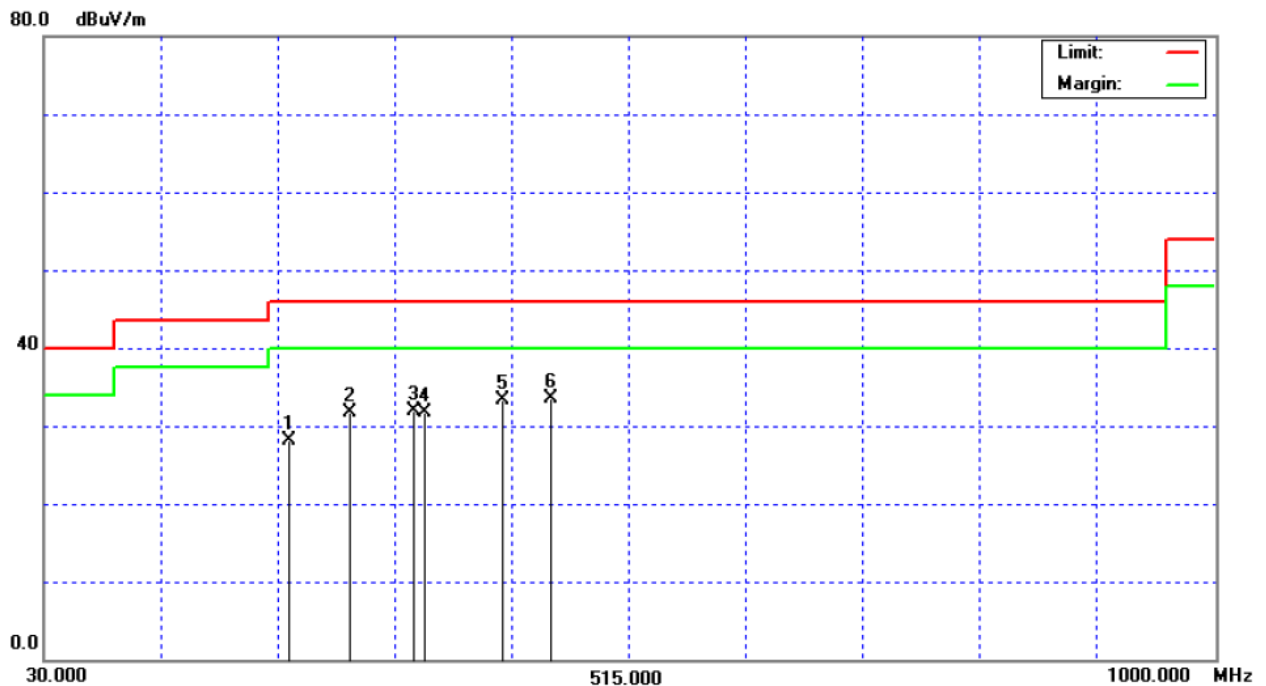

4.2.8 TEST RESULTS (Above 1000 MHz)

EUT :	Wireless Volp Phone	Model No. :	WLAN 800
Temperature :	25 °C	Relative Humidity :	60 %
Pressure :	1009 hPa	Test Power :	AC 120V/60Hz
Test Mode :	802.11b/CH01		

Freq. (MHz)	Ant.Pol. H/V	Reading		Ant./CF CF(dB)	Act.		Limit		Note
		Peak (dBuV)	AV (dBuV)		Peak (dBuV/m)	AV (dBuV/m)	Peak (dBuV/m)	AV (dBuV/m)	
1125.00	V	48.01	*	-8.47	39.54	*	74.00	54.00	X/H
1260.00	V	47.70	*	-7.85	39.85	*	74.00	54.00	X/H
1455.00	V	47.86	*	-6.97	40.89	*	74.00	54.00	X/H
1820.00	V	48.44	*	-4.98	43.46	*	74.00	54.00	X/H
2185.00	V	48.29	*	-3.51	44.78	*	74.00	54.00	X/H
2875.00	V	47.73	*	-1.24	46.49	*	74.00	54.00	X/H
4813.00	V	46.24	40.75	3.09	49.33	43.84	74.00	54.00	X/H
7236.00	V	42.33	*	7.47	49.80	*	74.00	54.00	X/H
9648.00	V	41.71	*	9.97	51.68	*	74.00	54.00	X/H

Remark :

- (1) Spectrum Setting : 30MHz – 1000MHz , RBW= 100KHz, VBW=100KHz, Sweep time = 200 ms. 1GHz- 25GHz, RBW= 1MHz, VBW= 1MHz, Sweep time = 200 ms
- (2) All readings are Peak unless otherwise stated QP in column of 『Note』 . Peak denotes that the Peak reading compliance with the QP Limits and then QP Mode measurement didn't perform ◦
- (3) Measuring frequency range from 30MHz to 1000MHz or the 10th harmonic of highest fundamental frequency ◦ "F" denotes fundamental frequency; "H" denotes spurious frequency. "E" denotes band edge frequency. (This judgment method includes the Band Edge Requirement.)
- (4) Radiated emissions measured in frequency range above 1000MHz were made with an instrument using Peak detector mode and AV detector mode of the emission ◦
- (5) Data of measurement within this frequency range shown " * " in the table above means the reading of emissions are attenuated more than 20dB below the permissible limits or the field strength is too small to be measured.
- (6) A preamp and high pass filter were used for this test in order to provide sufficient measurement sensitivity.
- (7) EUT Orthogonal Axes :
"X" - denotes Laid on Table ; "Y" - denotes Vertical Stand ; "Z" - denotes Side Stand

Orthogonal Axes : X
802.11b/CH01(Above 1000 MHz, Vertical)

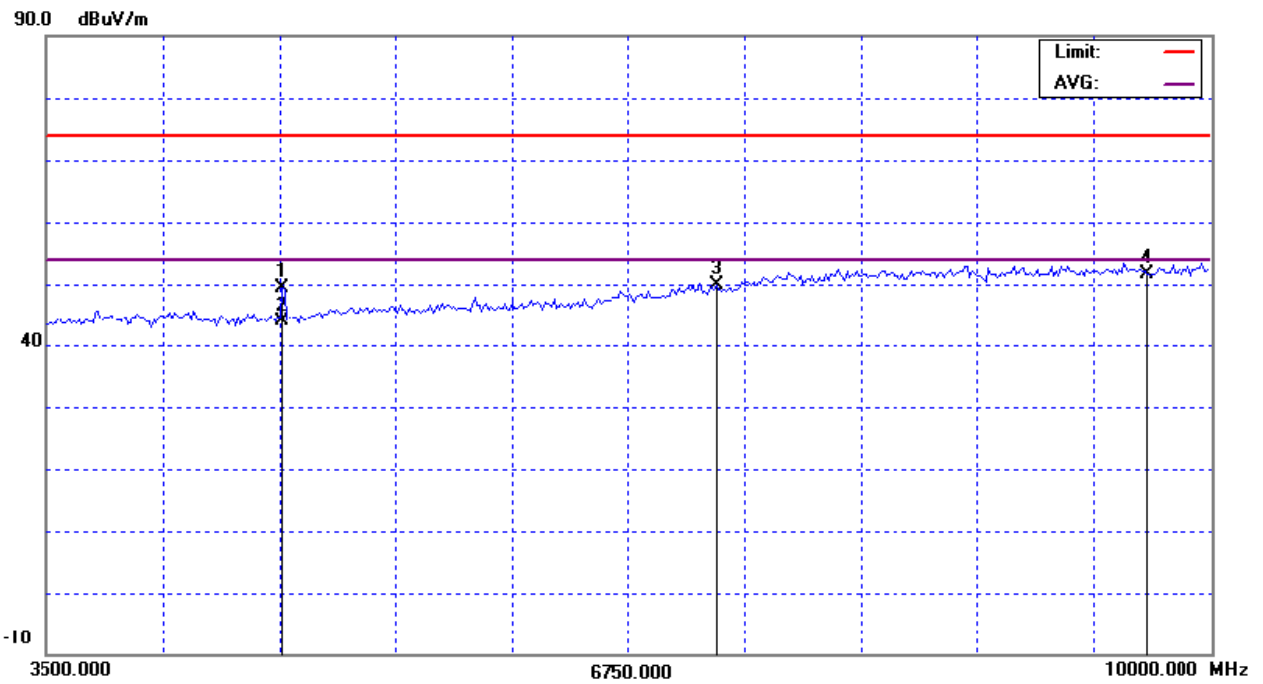
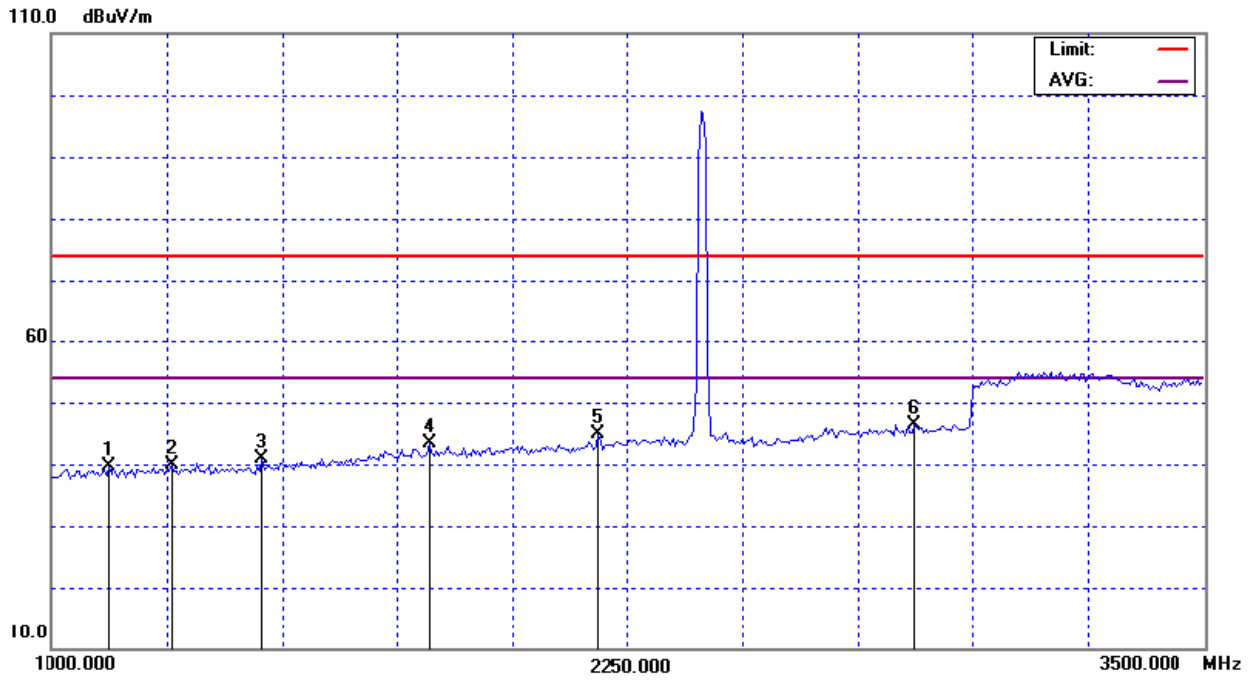

Orthogonal Axes : X
802.11b/CH01(Above 1000 MHz, Vertical)

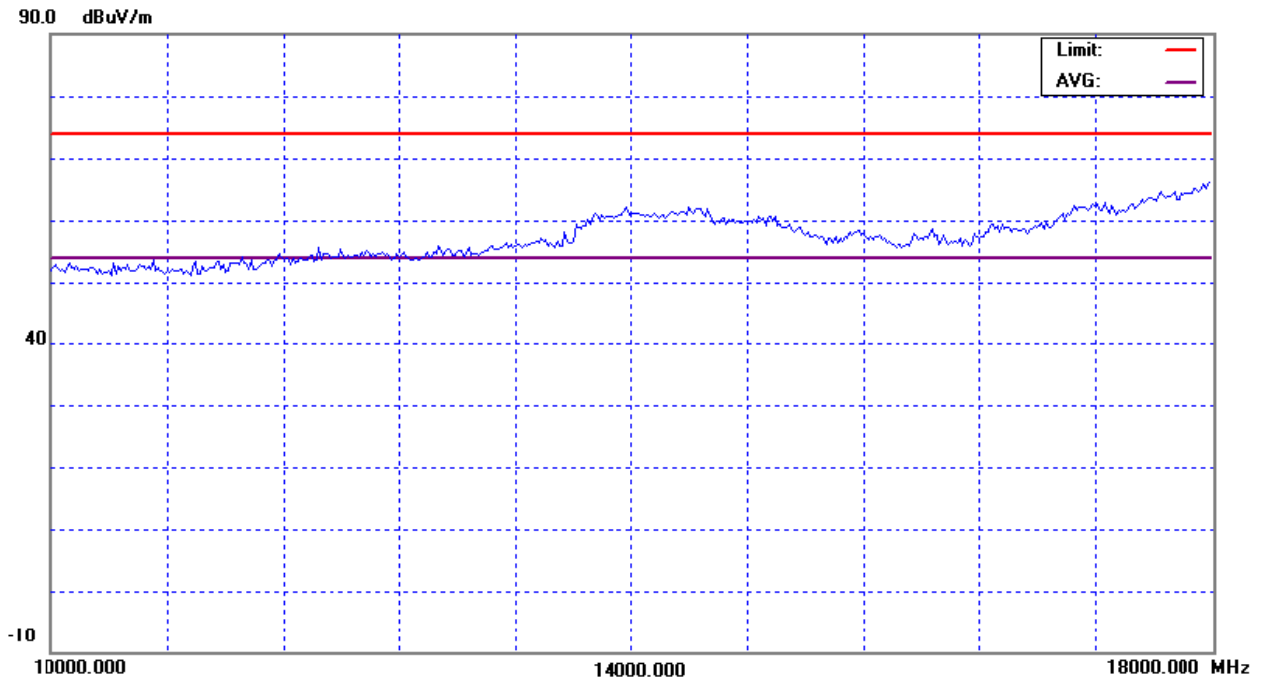

EUT :	Wireless Volp Phone	Model No. :	WLAN 800
Temperature :	25 °C	Relative Humidity :	60 %
Pressure :	1009 hPa	Test Power :	AC 120V/60Hz
Test Mode :	802.11b/CH01		

Freq. (MHz)	Ant.Pol. H/V	Reading		Ant./CF CF(dB)	Act.		Limit		Note
		Peak (dBuV)	AV (dBuV)		Peak (dBuV/m)	AV (dBuV/m)	Peak (dBuV/m)	AV (dBuV/m)	
1070.00	H	48.13	*	-8.72	39.41	*	74.00	54.00	X/H
1190.00	H	48.12	*	-8.17	39.95	*	74.00	54.00	X/H
1630.00	H	48.07	*	-6.04	42.03	*	74.00	54.00	X/H
2170.00	H	47.63	*	-3.55	44.08	*	74.00	54.00	X/H
2310.00	H	47.77	*	-3.19	44.58	*	74.00	54.00	X/H
2585.00	H	47.33	*	-2.35	44.98	*	74.00	54.00	X/H
4813.00	H	44.25	39.27	3.09	47.34	42.36	74.00	54.00	X/H
7236.00	H	42.16	*	7.47	49.63	*	74.00	54.00	X/H
9648.00	H	41.22	*	9.97	51.19	*	74.00	54.00	X/H

Remark :

- (1) Spectrum Setting : 30MHz – 1000MHz , RBW= 100KHz, VBW=100KHz, Sweep time = 200 ms. 1GHz- 25GHz, RBW= 1MHz, VBW= 1MHz, Sweep time = 200 ms
- (2) All readings are Peak unless otherwise stated QP in column of 『Note』 . Peak denotes that the Peak reading compliance with the QP Limits and then QP Mode measurement didn't perform ◦
- (3) Measuring frequency range from 30MHz to 1000MHz or the 10th harmonic of highest fundamental frequency ◦ "F" denotes fundamental frequency; "H" denotes spurious frequency. "E" denotes band edge frequency. (This judgment method includes the Band Edge Requirement.)
- (4) Radiated emissions measured in frequency range above 1000MHz were made with an instrument using Peak detector mode and AV detector mode of the emission ◦
- (5) Data of measurement within this frequency range shown " * " in the table above means the reading of emissions are attenuated more than 20dB below the permissible limits or the field strength is too small to be measured.
- (6) A preamp and high pass filter were used for this test in order to provide sufficient measurement sensitivity.
- (7) EUT Orthogonal Axes :
 "X" - denotes Laid on Table ; "Y" - denotes Vertical Stand ; "Z" - denotes Side Stand

Orthogonal Axes : X
802.11b/CH01(Above 1000 MHz, Horizontal)

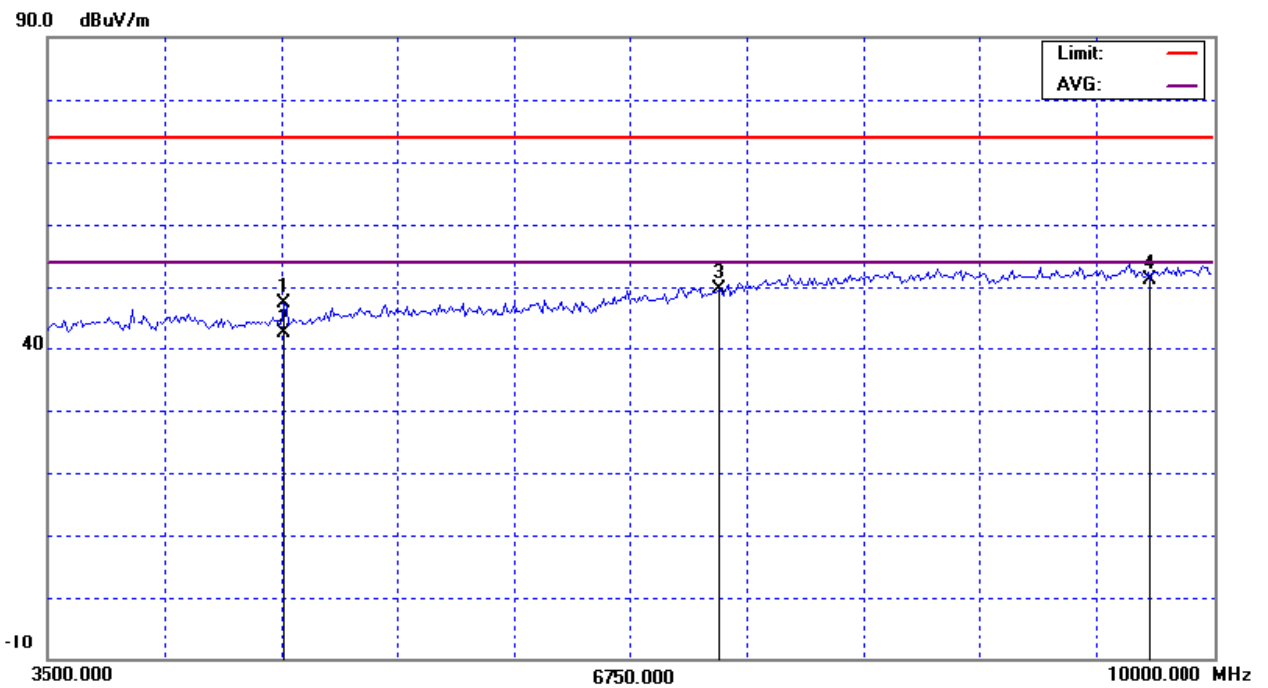
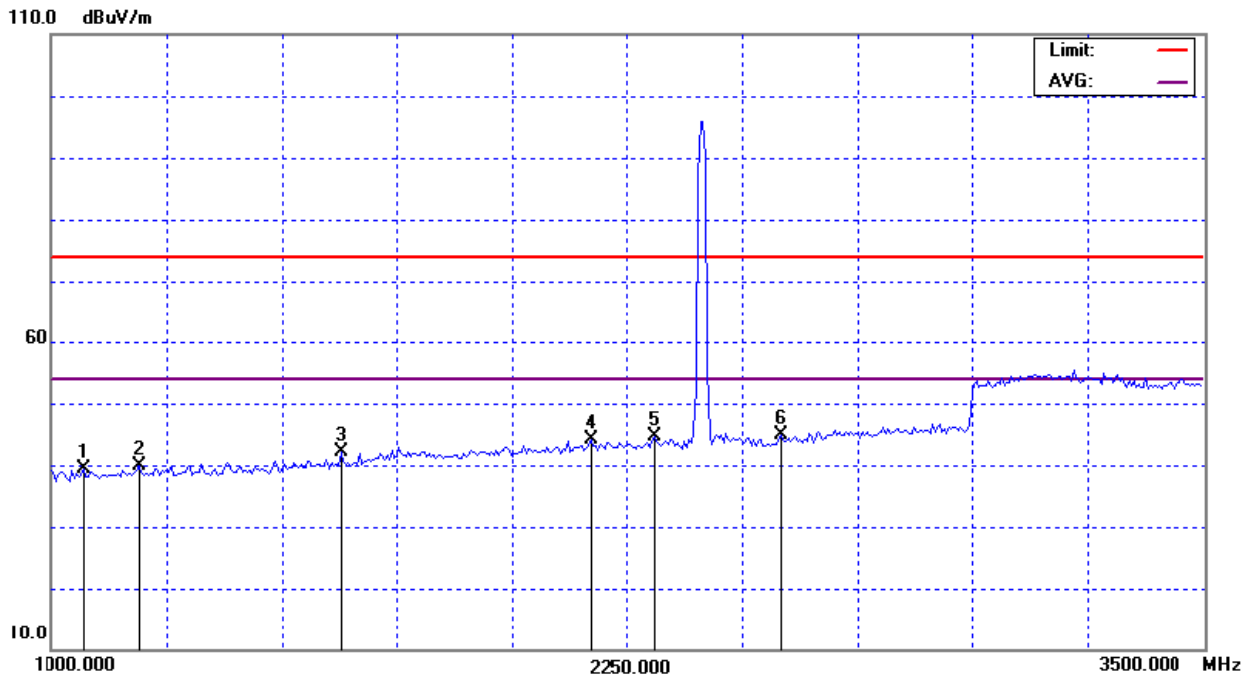

Orthogonal Axes : X
802.11b/CH01(Above 1000 MHz, Horizontal)

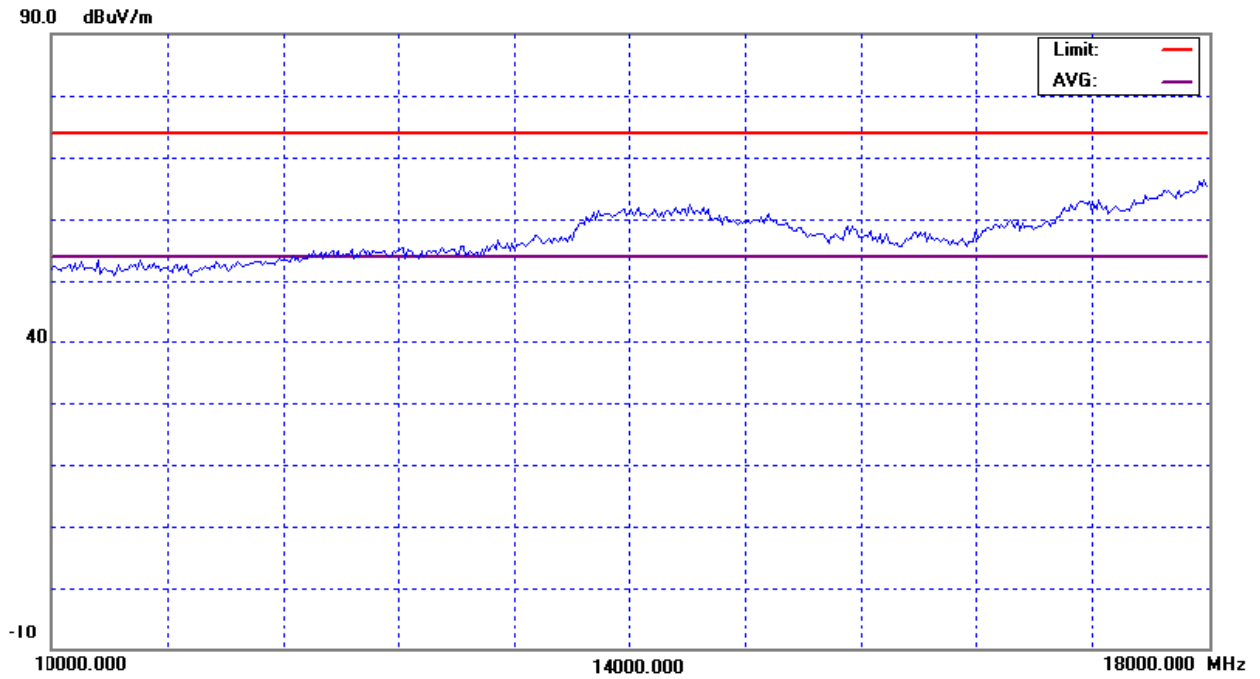

EUT :	Wireless Volp Phone	Model No. :	WLAN 800
Temperature :	25 °C	Relative Humidity :	60 %
Pressure :	1009 hPa	Test Power :	AC 120V/60Hz
Test Mode :	802.11b/CH01		

Freq. (MHz)	Ant.Pol. H/V	Reading		Ant./CF CF(dB)	Act.		Limit		Note
		Peak (dBuV)	AV (dBuV)		Peak (dBuV/m)	AV (dBuV/m)	Peak (dBuV/m)	AV (dBuV/m)	
1155.00	V	48.43	*	-8.33	40.10	*	74.00	54.00	Y/H
1425.00	V	47.47	*	-7.10	40.37	*	74.00	54.00	Y/H
1770.00	V	47.73	*	-5.26	42.47	*	74.00	54.00	Y/H
2075.00	V	46.78	*	-3.79	42.99	*	74.00	54.00	Y/H
2665.00	V	47.38	*	-2.06	45.32	*	74.00	54.00	Y/H
2755.00	V	47.67	*	-1.71	45.96	*	74.00	54.00	Y/H
4826.00	V	44.62	39.55	3.13	47.75	42.68	74.00	54.00	Y/H
7235.00	V	41.52	*	7.47	48.99	*	74.00	54.00	Y/H
9648.00	V	42.65	30.06	9.97	52.62	40.03	74.00	54.00	Y/H

Remark :

- (1) Spectrum Setting : 30MHz – 1000MHz , RBW= 100KHz, VBW=100KHz, Sweep time = 200 ms. 1GHz- 25GHz, RBW= 1MHz, VBW= 1MHz, Sweep time = 200 ms
- (2) All readings are Peak unless otherwise stated QP in column of 『Note』 . Peak denotes that the Peak reading compliance with the QP Limits and then QP Mode measurement didn't perform ◦
- (3) Measuring frequency range from 30MHz to 1000MHz or the 10th harmonic of highest fundamental frequency ◦ "F" denotes fundamental frequency; "H" denotes spurious frequency. "E" denotes band edge frequency. (This judgment method includes the Band Edge Requirement.)
- (4) Radiated emissions measured in frequency range above 1000MHz were made with an instrument using Peak detector mode and AV detector mode of the emission ◦
- (5) Data of measurement within this frequency range shown " * " in the table above means the reading of emissions are attenuated more than 20dB below the permissible limits or the field strength is too small to be measured.
- (6) A preamp and high pass filter were used for this test in order to provide sufficient measurement sensitivity.
- (7) EUT Orthogonal Axes :
"X" - denotes Laid on Table ; "Y" - denotes Vertical Stand ; "Z" - denotes Side Stand

Orthogonal Axes : Y
802.11b/CH01(Above 1000 MHz, Vertical)

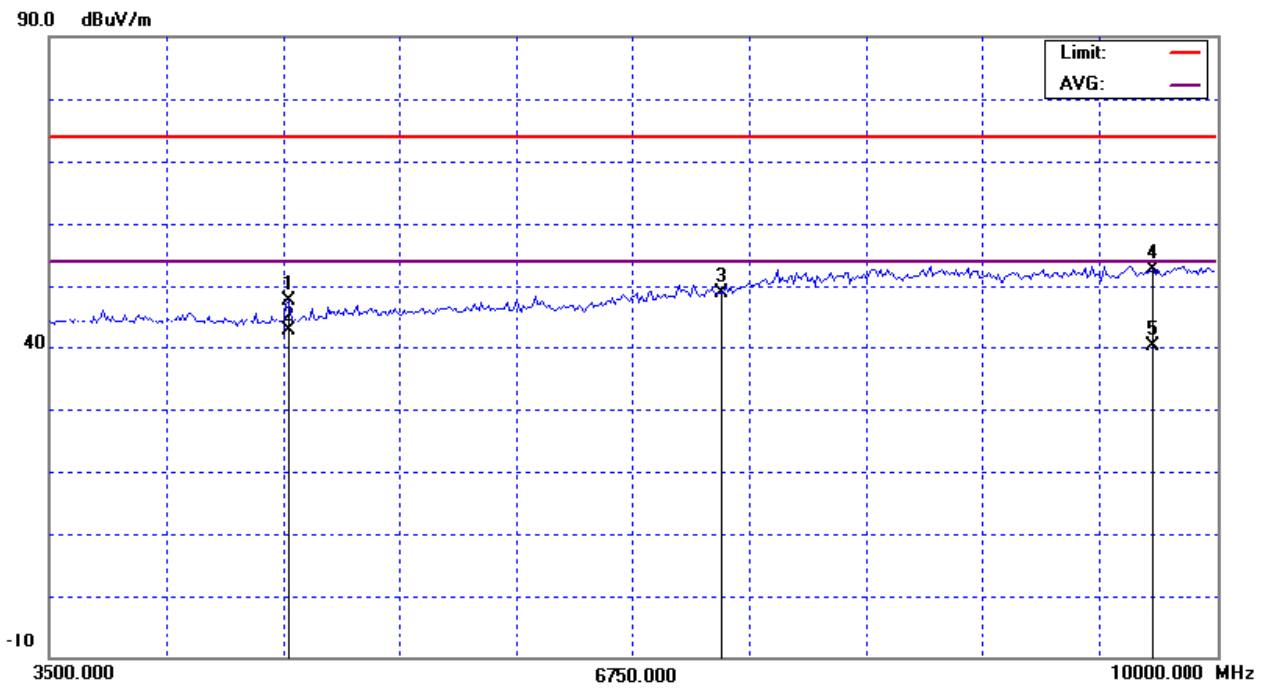
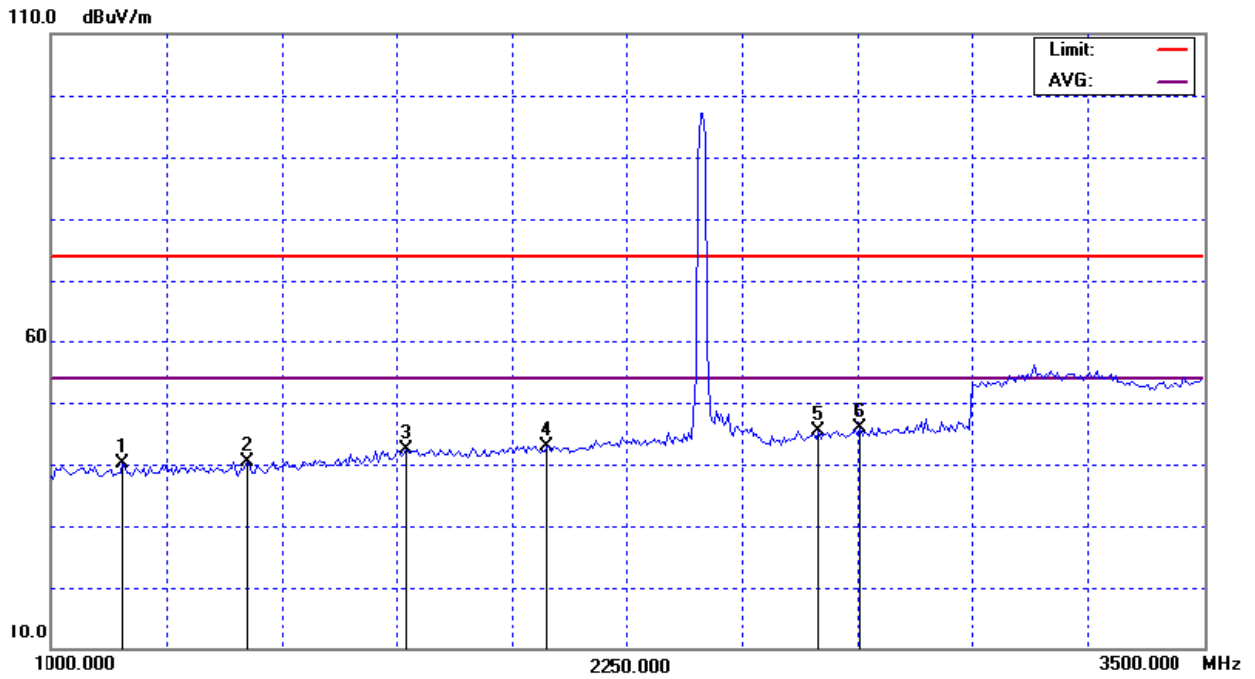

Orthogonal Axes : Y
802.11b/CH01(Above 1000 MHz, Vertical)

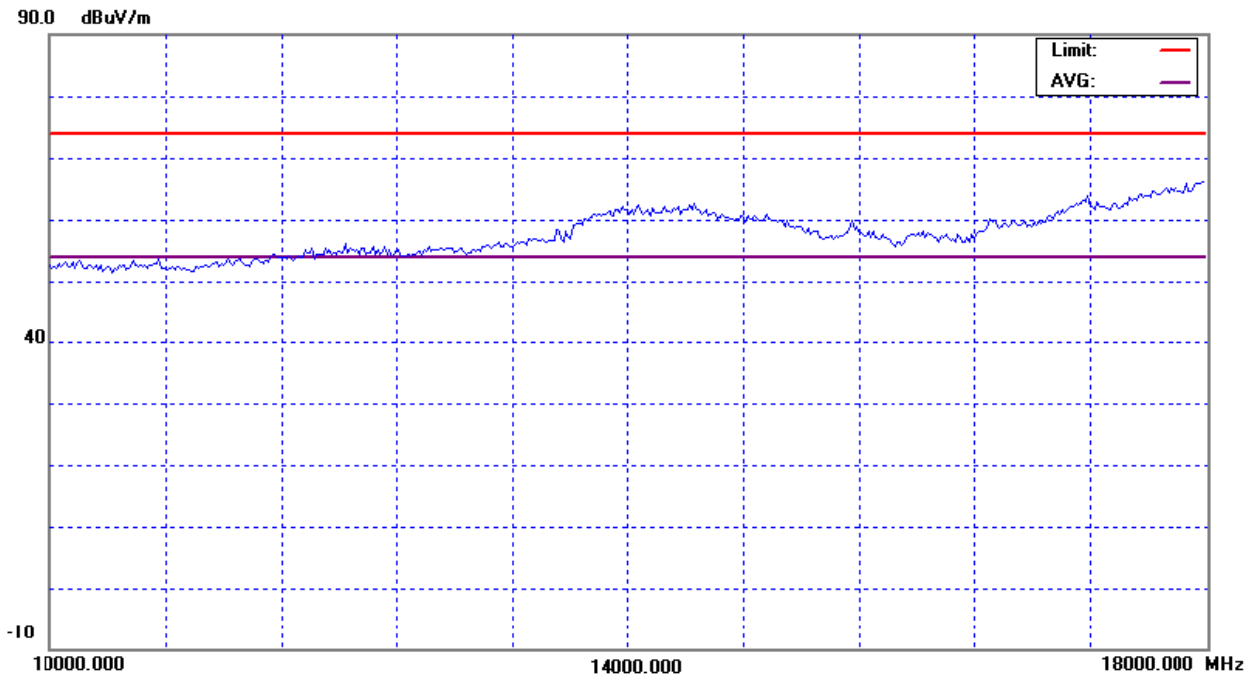

EUT :	Wireless Volp Phone	Model No. :	WLAN 800
Temperature :	25 °C	Relative Humidity :	60 %
Pressure :	1009 hPa	Test Power :	AC 120V/60Hz
Test Mode :	802.11b/CH01		

Freq. (MHz)	Ant.Pol. H/V	Reading		Ant./CF CF(dB)	Act.		Limit		Note
		Peak (dBuV)	AV (dBuV)		Peak (dBuV/m)	AV (dBuV/m)	Peak (dBuV/m)	AV (dBuV/m)	
1015.00	H	48.09	*	-8.97	39.12	*	74.00	54.00	Y/H
1240.00	H	47.42	*	-7.95	39.47	*	74.00	54.00	Y/H
1420.00	H	47.68	*	-7.12	40.56	*	74.00	54.00	Y/H
1730.00	H	47.42	*	-5.48	41.94	*	74.00	54.00	Y/H
1860.00	H	47.72	*	-4.76	42.96	*	74.00	54.00	Y/H
2240.00	H	47.54	*	-3.37	44.17	*	74.00	54.00	Y/H
4826.00	H	53.97	48.68	3.13	57.10	51.81	74.00	54.00	Y/H
7236.00	H	41.38	*	7.47	48.85	*	74.00	54.00	Y/H
9648.00	H	41.94	*	9.97	51.91	*	74.00	54.00	Y/H

Remark :

- (1) Spectrum Setting : 30MHz – 1000MHz , RBW= 100KHz, VBW=100KHz, Sweep time = 200 ms. 1GHz- 25GHz, RBW= 1MHz, VBW= 1MHz, Sweep time = 200 ms
- (2) All readings are Peak unless otherwise stated QP in column of 『Note』 . Peak denotes that the Peak reading compliance with the QP Limits and then QP Mode measurement didn't perform ◦
- (3) Measuring frequency range from 30MHz to 1000MHz or the 10th harmonic of highest fundamental frequency ◦ "F" denotes fundamental frequency; "H" denotes spurious frequency. "E" denotes band edge frequency. (This judgment method includes the Band Edge Requirement.)
- (4) Radiated emissions measured in frequency range above 1000MHz were made with an instrument using Peak detector mode and AV detector mode of the emission ◦
- (5) Data of measurement within this frequency range shown " * " in the table above means the reading of emissions are attenuated more than 20dB below the permissible limits or the field strength is too small to be measured.
- (6) A preamp and high pass filter were used for this test in order to provide sufficient measurement sensitivity.
- (7) EUT Orthogonal Axes :
 "X" - denotes Laid on Table ; "Y" - denotes Vertical Stand ; "Z" - denotes Side Stand

Orthogonal Axes : Y
802.11b/CH01(Above 1000 MHz, Horizontal)

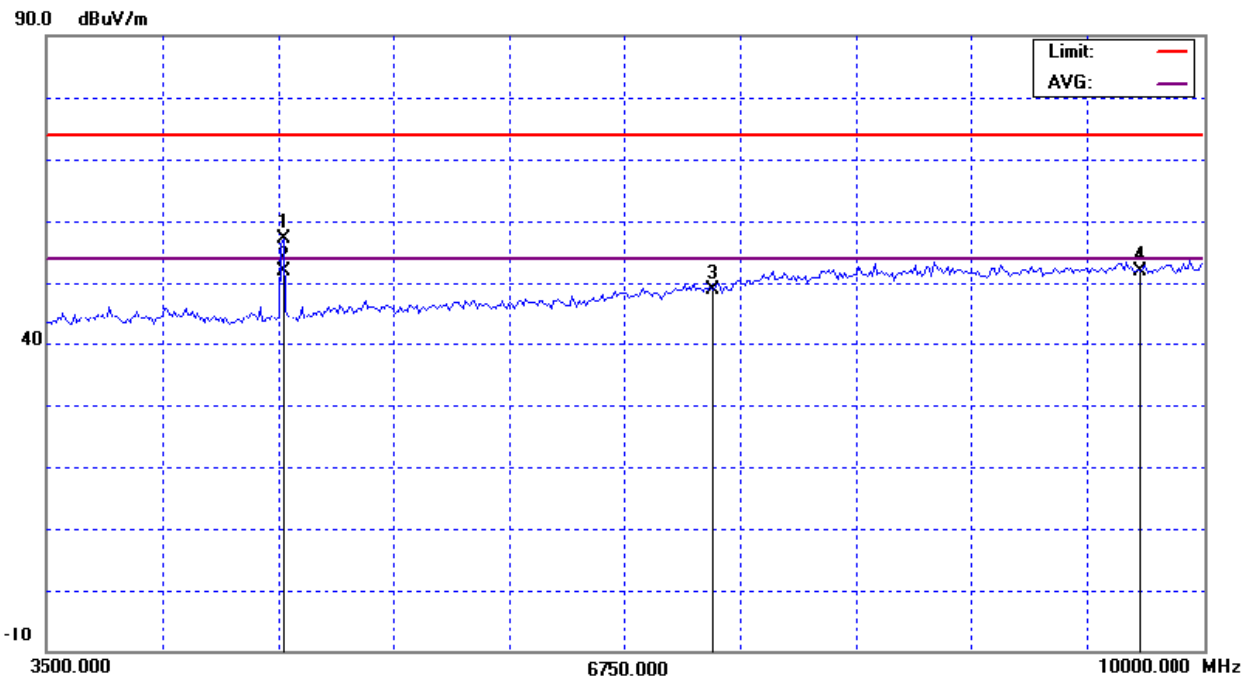
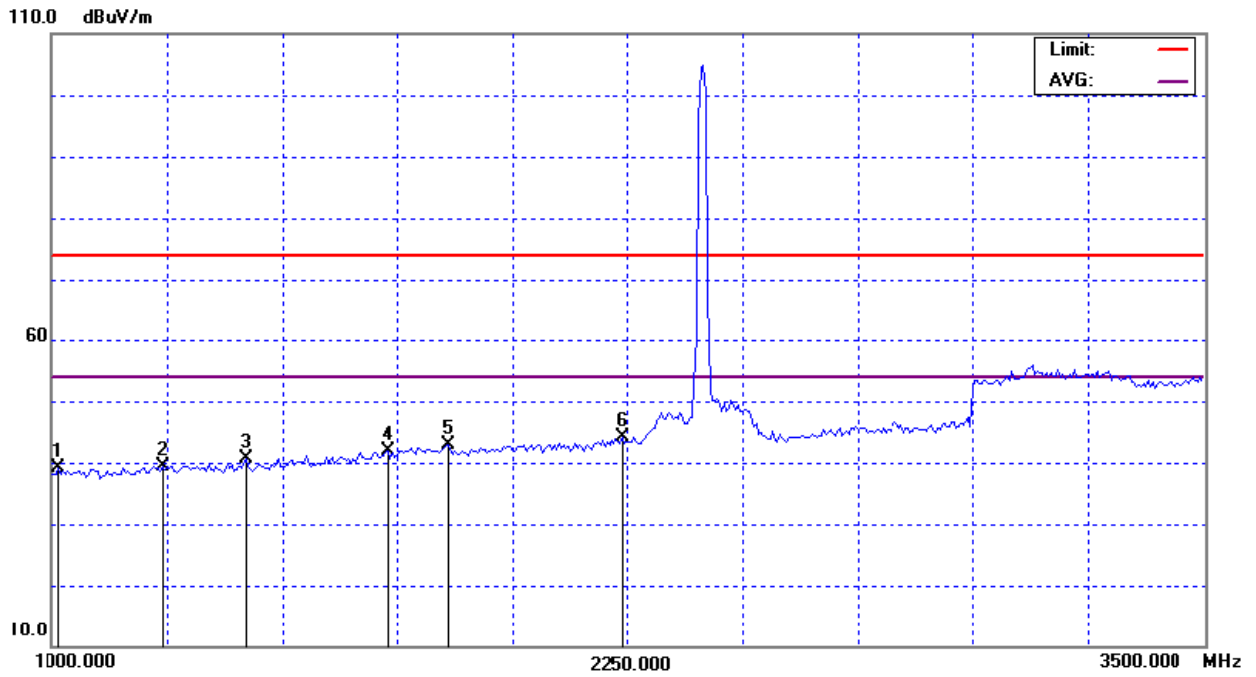

Orthogonal Axes : Y
802.11b/CH01(Above 1000 MHz, Horizontal)

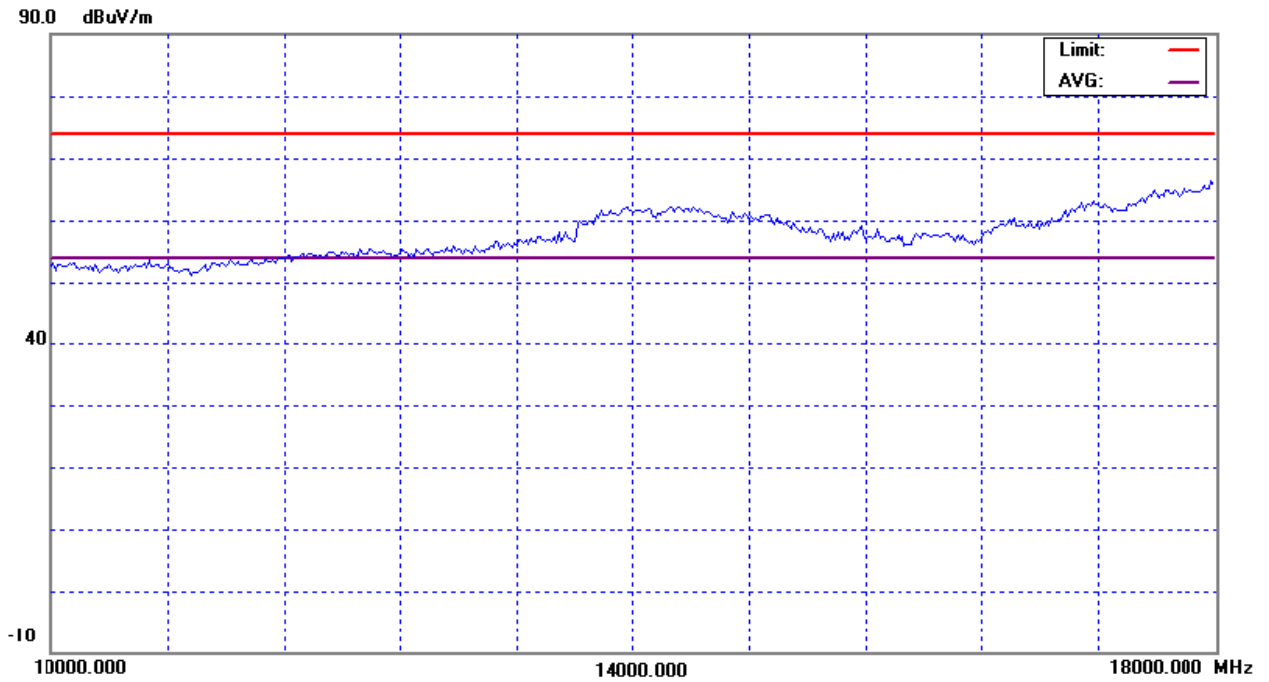

EUT :	Wireless Volp Phone	Model No. :	WLAN 800
Temperature :	25 °C	Relative Humidity :	60 %
Pressure :	1009 hPa	Test Power :	AC 120V/60Hz
Test Mode :	802.11b/CH01		

Freq. (MHz)	Ant.Pol. H/V	Reading		Ant./CF CF(dB)	Act.		Limit		Note
		Peak (dBuV)	AV (dBuV)		Peak (dBuV/m)	AV (dBuV/m)	Peak (dBuV/m)	AV (dBuV/m)	
1105.00	V	47.74	*	-8.56	39.18	*	74.00	54.00	Z/H
1325.00	V	50.00	*	-7.56	42.44	*	74.00	54.00	Z/H
1535.00	V	47.42	*	-6.57	40.85	*	74.00	54.00	Z/H
1725.00	V	48.20	*	-5.51	42.69	*	74.00	54.00	Z/H
2125.00	V	48.05	*	-3.66	44.39	*	74.00	54.00	Z/H
2955.00	V	48.07	*	-0.92	47.15	*	74.00	54.00	Z/H
4826.00	V	47.06	41.35	3.13	50.19	44.48	74.00	54.00	Z/H
7236.00	V	41.71	*	7.47	49.18	*	74.00	54.00	Z/H
9648.00	V	42.26	29.31	9.97	52.23	39.28	74.00	54.00	Z/H

Remark :

- (1) Spectrum Setting : 30MHz – 1000MHz , RBW= 100KHz, VBW=100KHz, Sweep time = 200 ms. 1GHz- 25GHz, RBW= 1MHz, VBW= 1MHz, Sweep time = 200 ms
- (2) All readings are Peak unless otherwise stated QP in column of 『Note』 . Peak denotes that the Peak reading compliance with the QP Limits and then QP Mode measurement didn't perform ◦
- (3) Measuring frequency range from 30MHz to 1000MHz or the 10th harmonic of highest fundamental frequency ◦ "F" denotes fundamental frequency; "H" denotes spurious frequency. "E" denotes band edge frequency. (This judgment method includes the Band Edge Requirement.)
- (4) Radiated emissions measured in frequency range above 1000MHz were made with an instrument using Peak detector mode and AV detector mode of the emission ◦
- (5) Data of measurement within this frequency range shown " * " in the table above means the reading of emissions are attenuated more than 20dB below the permissible limits or the field strength is too small to be measured.
- (6) A preamp and high pass filter were used for this test in order to provide sufficient measurement sensitivity.
- (7) EUT Orthogonal Axes :
"X" - denotes Laid on Table ; "Y" - denotes Vertical Stand ; "Z" - denotes Side Stand

Orthogonal Axes : Z
802.11b/CH01(Above 1000 MHz, Vertical)

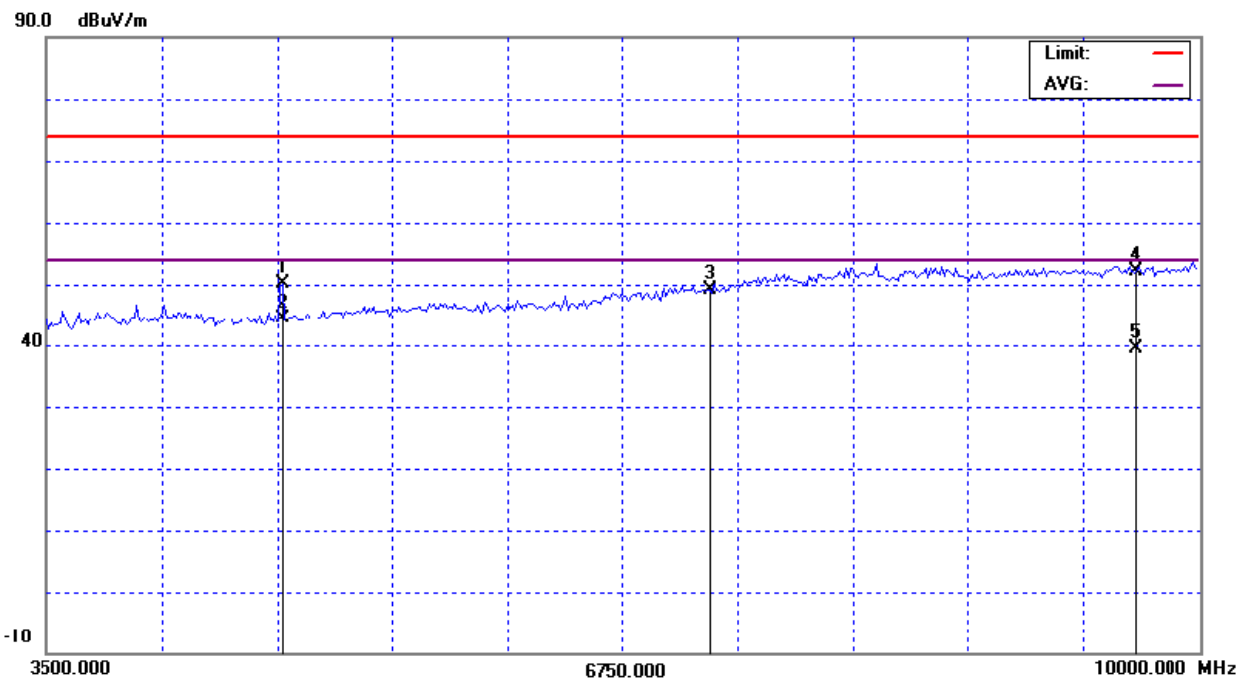
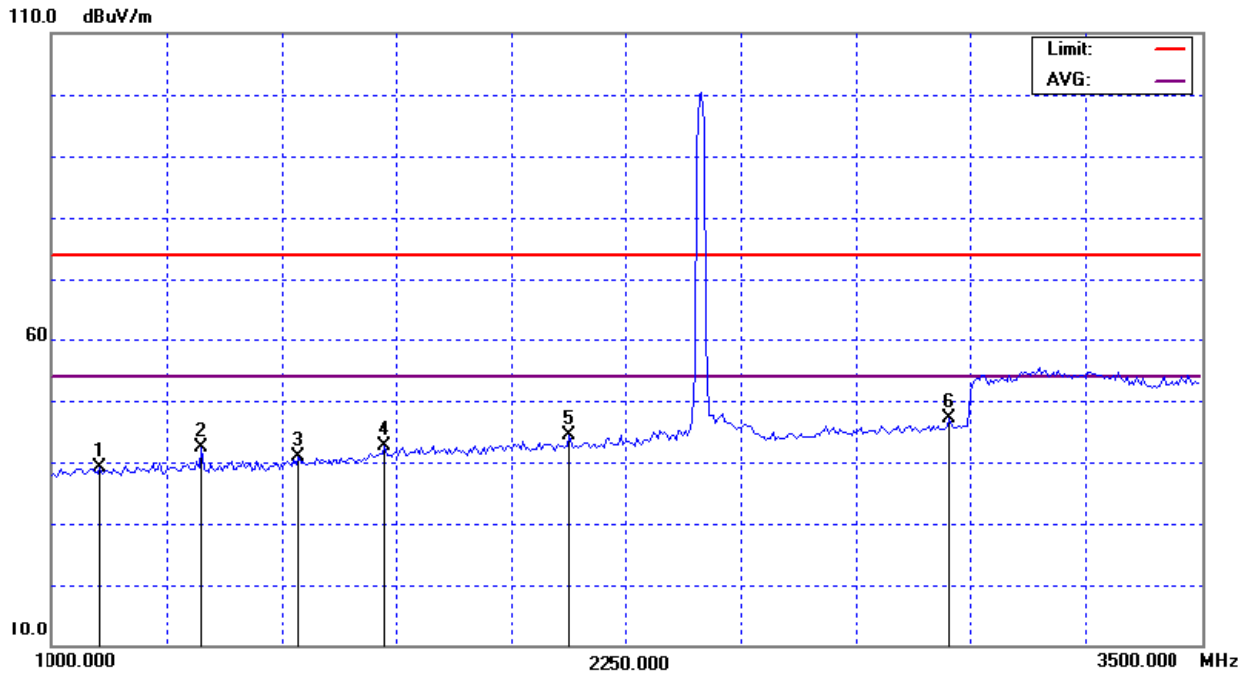

Orthogonal Axes : Z
802.11b/CH01(Above 1000 MHz, Vertical)

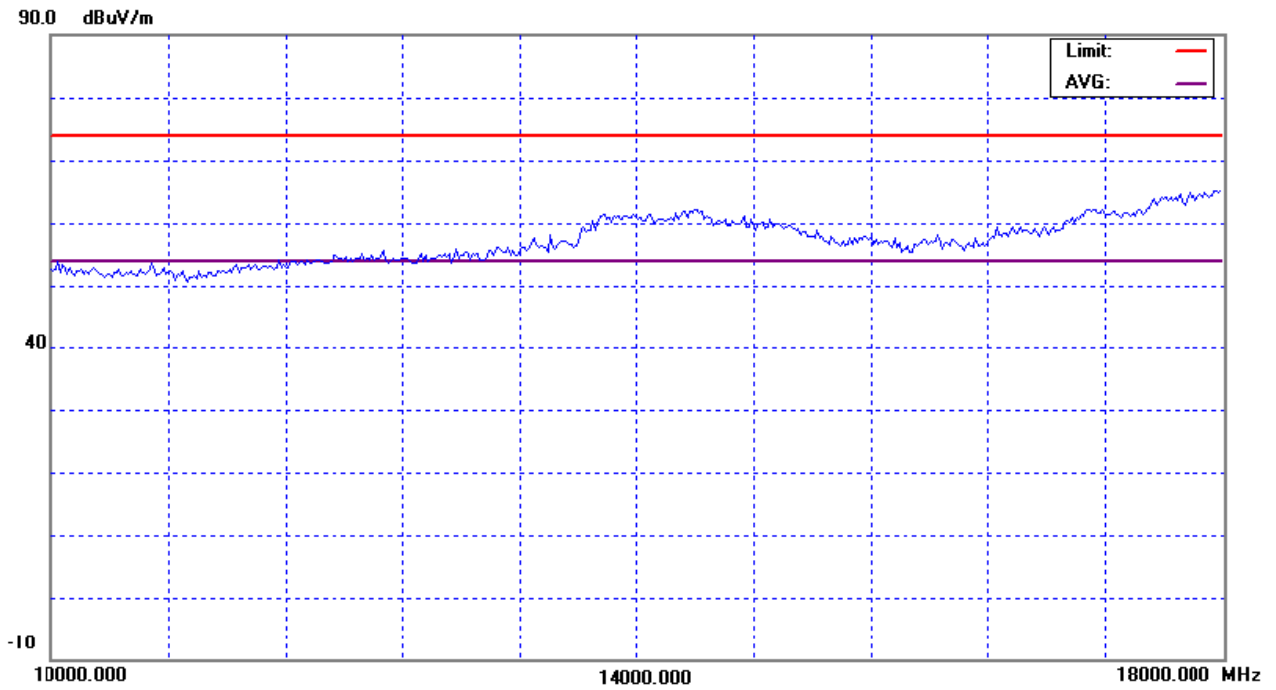

EUT :	Wireless Volp Phone	Model No. :	WLAN 800
Temperature :	25 °C	Relative Humidity :	60 %
Pressure :	1009 hPa	Test Power :	AC 120V/60Hz
Test Mode :	802.11b/CH01		

Freq. (MHz)	Ant.Pol. H/V	Reading		Ant./CF CF(dB)	Act.		Limit		Note
		Peak (dBuV)	AV (dBuV)		Peak (dBuV/m)	AV (dBuV/m)	Peak (dBuV/m)	AV (dBuV/m)	
1000.00	H	48.27	*	-9.04	39.23	*	74.00	54.00	Z/H
1180.00	H	47.30	*	-8.22	39.08	*	74.00	54.00	Z/H
1500.00	H	47.10	*	-6.76	40.34	*	74.00	54.00	Z/H
1820.00	H	47.83	*	4.98	52.81	*	74.00	54.00	Z/H
2185.00	H	47.30	*	-3.51	43.79	*	74.00	54.00	Z/H
2895.00	H	47.76	*	-1.16	46.60	*	74.00	54.00	Z/H
4813.00	H	43.72	37.15	3.09	46.81	40.24	74.00	54.00	Z/H
7236.00	H	41.43	*	7.47	48.90	*	74.00	54.00	Z/H
9648.00	H	43.12	29.29	9.97	53.09	39.26	74.00	54.00	Z/H

Remark :

- (1) Spectrum Setting : 30MHz – 1000MHz , RBW= 100KHz, VBW=100KHz, Sweep time = 200 ms. 1GHz- 25GHz, RBW= 1MHz, VBW= 1MHz, Sweep time = 200 ms
- (2) All readings are Peak unless otherwise stated QP in column of 『Note』 . Peak denotes that the Peak reading compliance with the QP Limits and then QP Mode measurement didn't perform ◦
- (3) Measuring frequency range from 30MHz to 1000MHz or the 10th harmonic of highest fundamental frequency ◦ "F" denotes fundamental frequency; "H" denotes spurious frequency. "E" denotes band edge frequency. (This judgment method includes the Band Edge Requirement.)
- (4) Radiated emissions measured in frequency range above 1000MHz were made with an instrument using Peak detector mode and AV detector mode of the emission ◦
- (5) Data of measurement within this frequency range shown " * " in the table above means the reading of emissions are attenuated more than 20dB below the permissible limits or the field strength is too small to be measured.
- (6) A preamp and high pass filter were used for this test in order to provide sufficient measurement sensitivity.
- (7) EUT Orthogonal Axes :
 "X" - denotes Laid on Table ; "Y" - denotes Vertical Stand ; "Z" - denotes Side Stand

Orthogonal Axes : Z
802.11b/CH01(Above 1000 MHz, Horizontal)

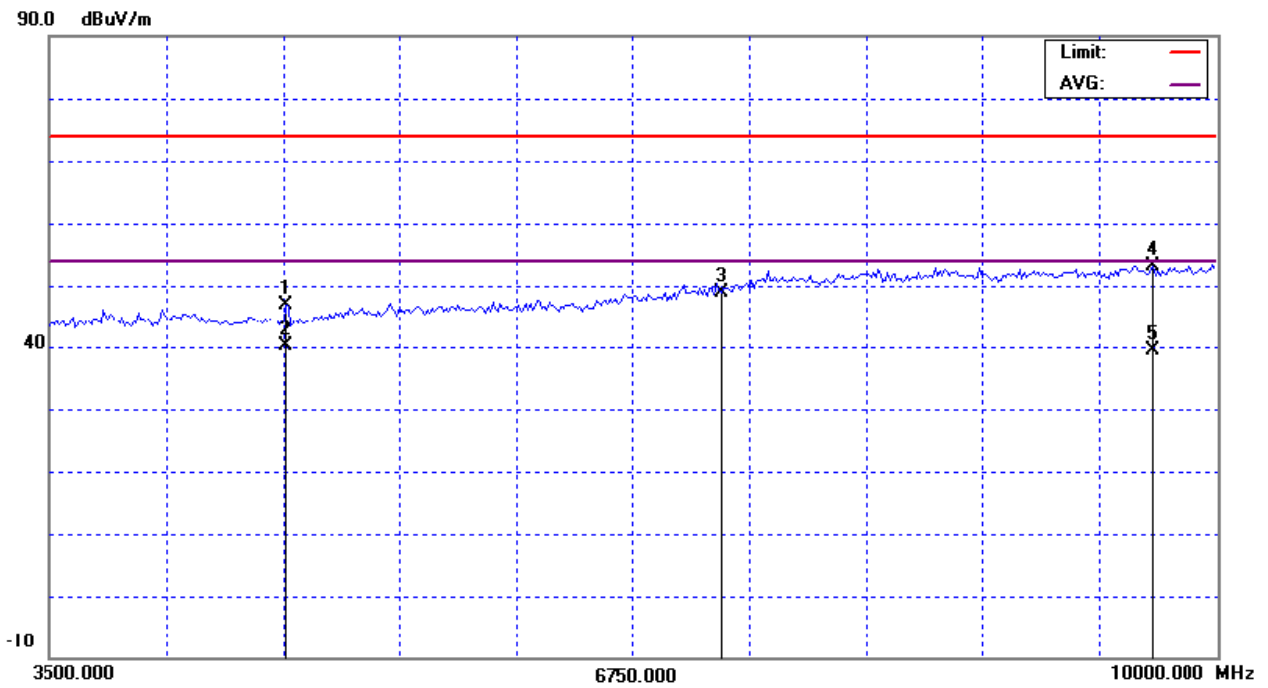
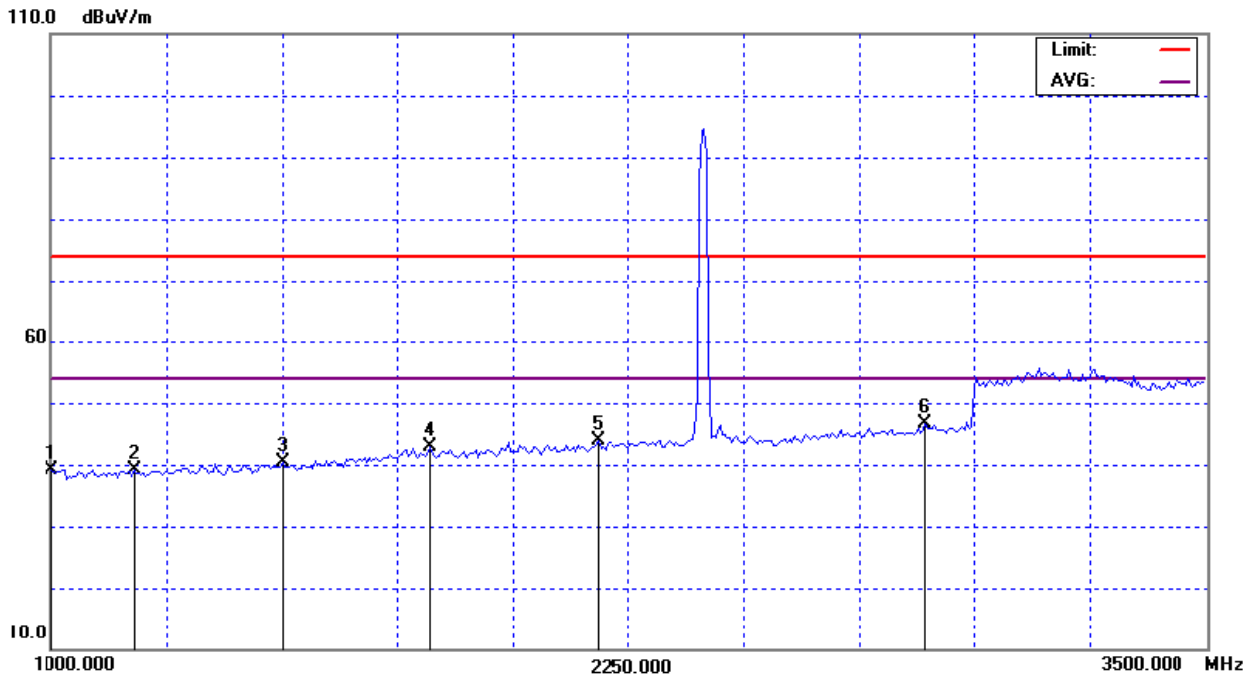

Orthogonal Axes : Z
802.11b/CH01 (Above 1000 MHz, Horizontal)

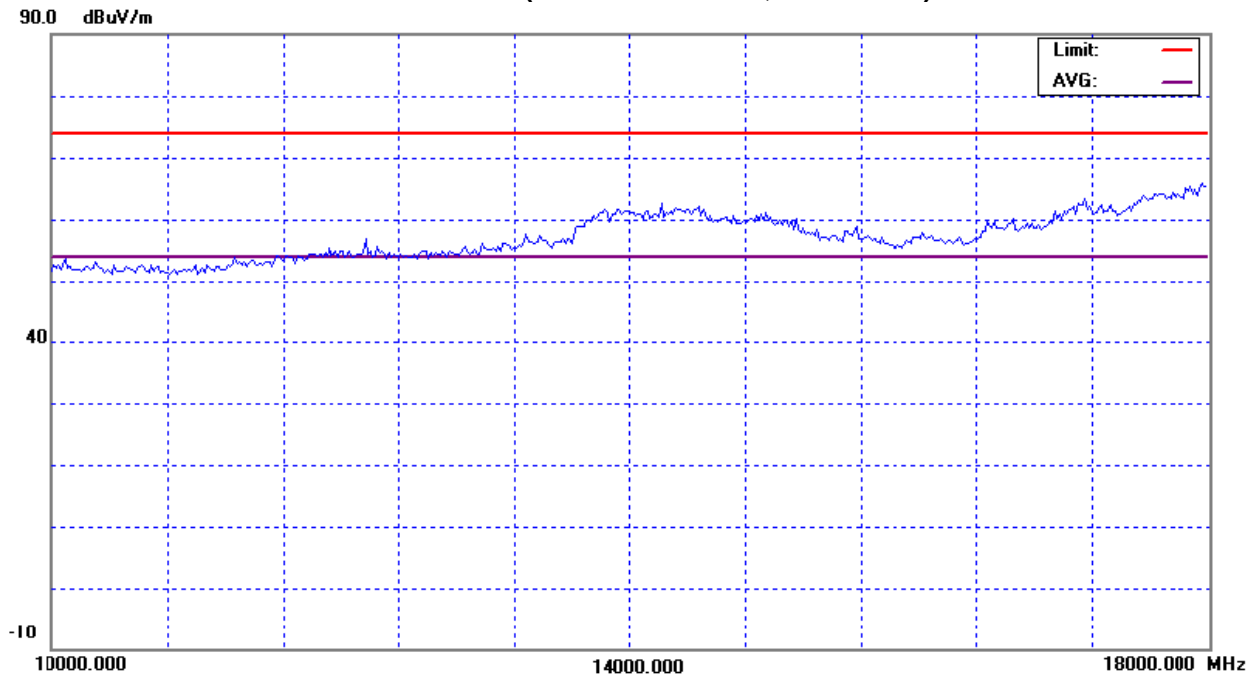

EUT :	Wireless Volp Phone	Model No. :	WLAN 800
Temperature :	25 °C	Relative Humidity :	60 %
Pressure :	1009 hPa	Test Power :	AC 120V/60Hz
Test Mode :	802.11b/CH06		

Freq. (MHz)	Ant.Pol. H/V	Reading		Ant./CF CF(dB)	Act.		Limit		Note
		Peak (dBuV)	AV (dBuV)		Peak (dBuV/m)	AV (dBuV/m)	Peak (dBuV/m)	AV (dBuV/m)	
1125.00	V	47.51	*	-8.47	39.04	*	74.00	54.00	X/H
1255.00	V	48.67	*	-7.88	40.79	*	74.00	54.00	X/H
150.00	V	47.50	*	-6.76	40.74	*	63.50	43.50	X/H
1845.00	V	47.41	*	-4.84	42.57	*	74.00	54.00	X/H
2135.00	V	48.34	*	-3.64	44.70	*	74.00	54.00	X/H
2710.00	V	47.90	*	-1.89	46.01	*	74.00	54.00	X/H
4878.00	V	47.76	41.38	3.25	51.01	44.63	74.00	54.00	X/H
7311.00	V	41.65	*	7.80	49.45	*	74.00	54.00	X/H
9748.00	V	42.73	31.80	10.05	52.78	41.85	74.00	54.00	X/H

Remark :

- (1) Spectrum Setting : 30MHz – 1000MHz , RBW= 100KHz, VBW=100KHz, Sweep time = 200 ms. 1GHz- 25GHz, RBW= 1MHz, VBW= 1MHz, Sweep time = 200 ms
- (2) All readings are Peak unless otherwise stated QP in column of 『Note』 . Peak denotes that the Peak reading compliance with the QP Limits and then QP Mode measurement didn't perform ◦
- (3) Measuring frequency range from 30MHz to 1000MHz or the 10th harmonic of highest fundamental frequency ◦“F” denotes fundamental frequency; “H” denotes spurious frequency. “E” denotes band edge frequency. (This judgment method includes the Band Edge Requirement.)
- (4) Radiated emissions measured in frequency range above 1000MHz were made with an instrument using Peak detector mode and AV detector mode of the emission ◦
- (5) Data of measurement within this frequency range shown “ * ” in the table above means the reading of emissions are attenuated more than 20dB below the permissible limits or the field strength is too small to be measured.
- (6) A preamp and high pass filter were used for this test in order to provide sufficient measurement sensitivity.
- (7) EUT Orthogonal Axes :
“X” - denotes Laid on Table ; “Y” - denotes Vertical Stand ; “Z” - denotes Side Stand

Orthogonal Axes : X
802.11b/CH06(Above 1000 MHz, Vertical)

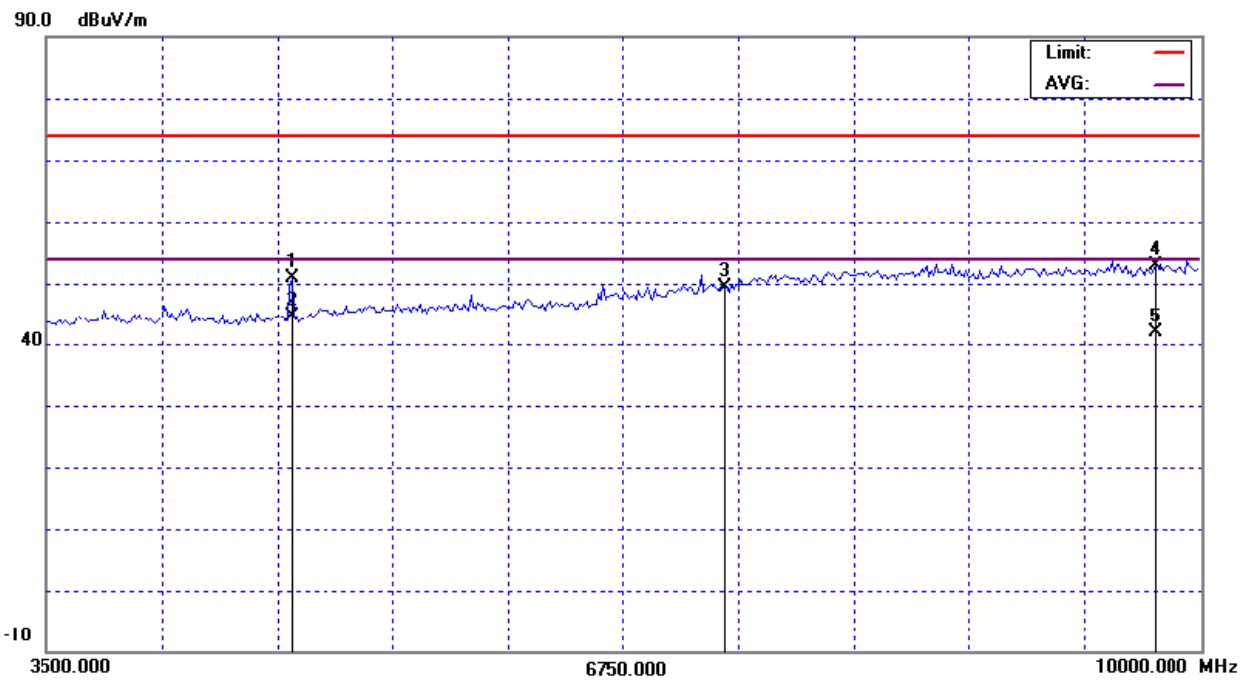
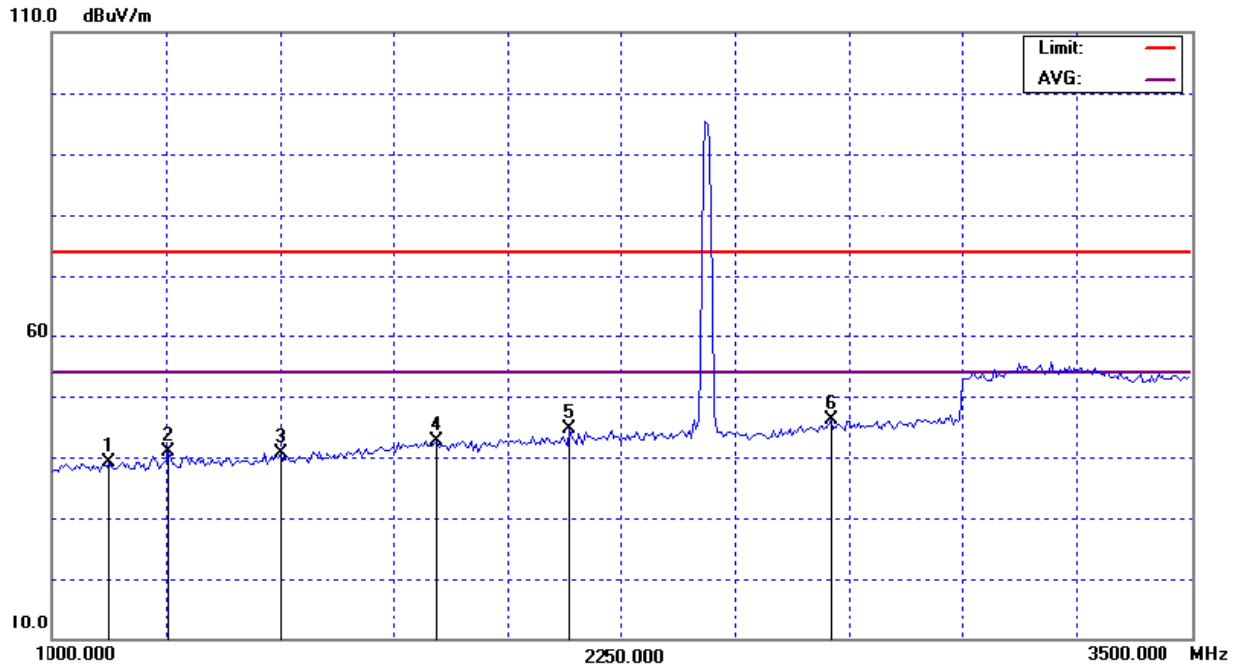

Orthogonal Axes : X
802.11b/CH06(Above 1000 MHz, Vertical)

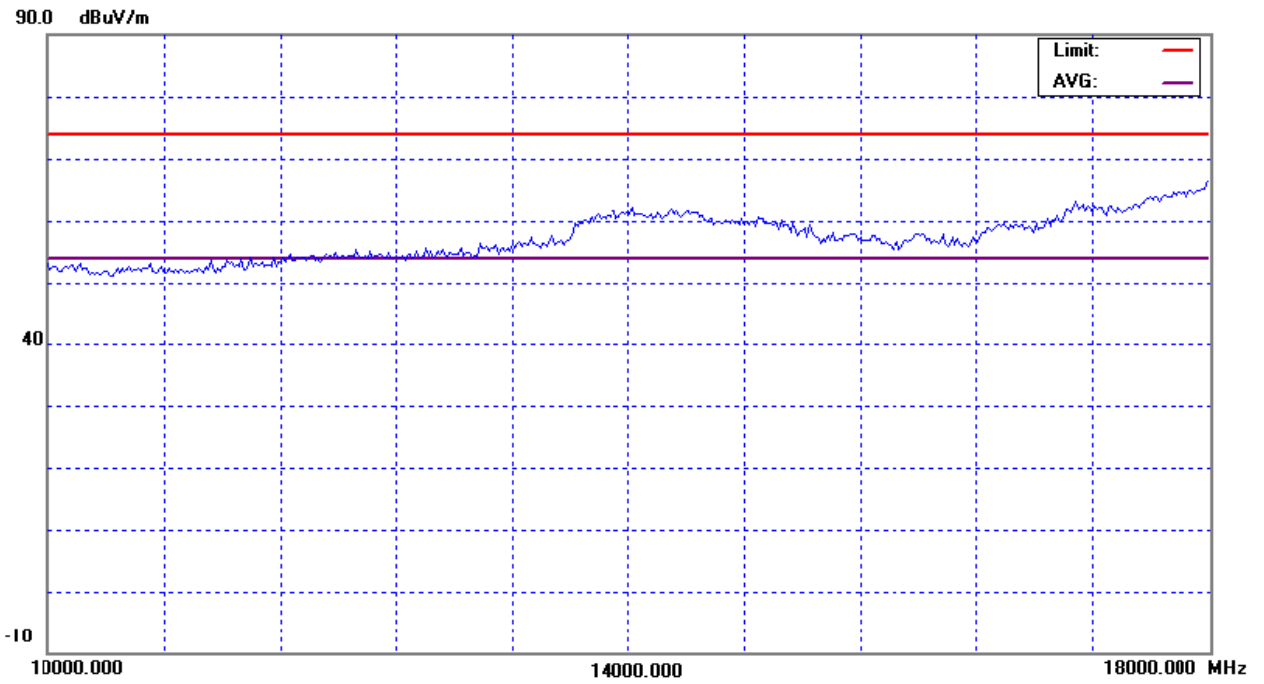

EUT :	Wireless Volp Phone	Model No. :	WLAN 800
Temperature :	25 °C	Relative Humidity :	60 %
Pressure :	1009 hPa	Test Power :	AC 120V/60Hz
Test Mode :	802.11b/CH06		

Freq. (MHz)	Ant.Pol. H/V	Reading		Ant./CF CF(dB)	Act.		Limit		Note
		Peak (dBuV)	AV (dBuV)		Peak (dBuV/m)	AV (dBuV/m)	Peak (dBuV/m)	AV (dBuV/m)	
1030.00	H	49.34	*	-8.90	40.44	*	74.00	54.00	X/H
1385.00	H	47.91	*	-7.28	40.63	*	74.00	54.00	X/H
1760.00	H	47.39	*	-5.31	42.08	*	74.00	54.00	X/H
1815.00	H	47.79	*	-5.01	42.78	*	74.00	54.00	X/H
2115.00	H	47.09	*	-3.69	43.40	*	74.00	54.00	X/H
2845.00	H	48.35	*	-1.35	47.00	*	74.00	54.00	X/H
4878.00	H	45.33	40.27	3.25	48.58	43.52	74.00	54.00	X/H
7311.00	H	42.89	*	7.80	50.69	*	74.00	54.00	X/H
9748.00	H	41.39	*	10.05	51.44	*	74.00	54.00	X/H

Remark :

- (1) Spectrum Setting : 30MHz – 1000MHz , RBW= 100KHz, VBW=100KHz, Sweep time = 200 ms. 1GHz- 25GHz, RBW= 1MHz, VBW= 1MHz, Sweep time = 200 ms
- (2) All readings are Peak unless otherwise stated QP in column of 『Note』 . Peak denotes that the Peak reading compliance with the QP Limits and then QP Mode measurement didn't perform ◦
- (3) Measuring frequency range from 30MHz to 1000MHz or the 10th harmonic of highest fundamental frequency ◦ "F" denotes fundamental frequency; "H" denotes spurious frequency. "E" denotes band edge frequency. (This judgment method includes the Band Edge Requirement.)
- (4) Radiated emissions measured in frequency range above 1000MHz were made with an instrument using Peak detector mode and AV detector mode of the emission ◦
- (5) Data of measurement within this frequency range shown " * " in the table above means the reading of emissions are attenuated more than 20dB below the permissible limits or the field strength is too small to be measured.
- (6) A preamp and high pass filter were used for this test in order to provide sufficient measurement sensitivity.
- (7) EUT Orthogonal Axes :
 "X" - denotes Laid on Table ; "Y" - denotes Vertical Stand ; "Z" - denotes Side Stand

Orthogonal Axes : X
802.11b/CH06(Above 1000 MHz, Horizontal)

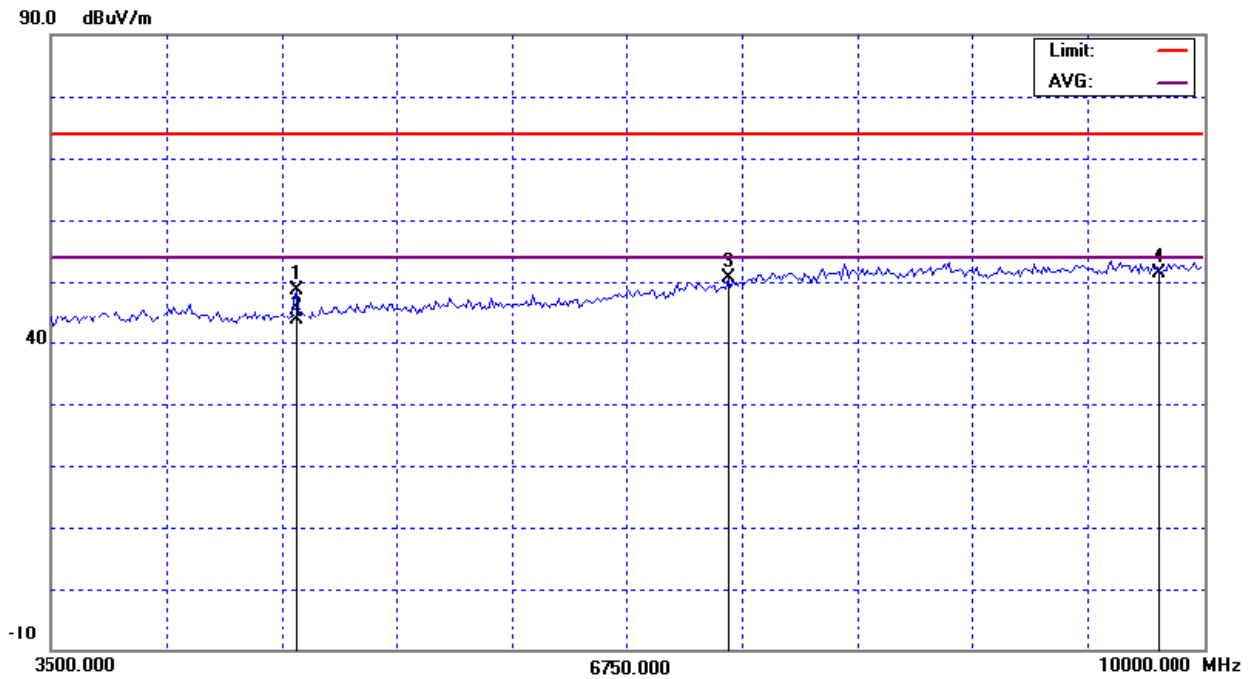
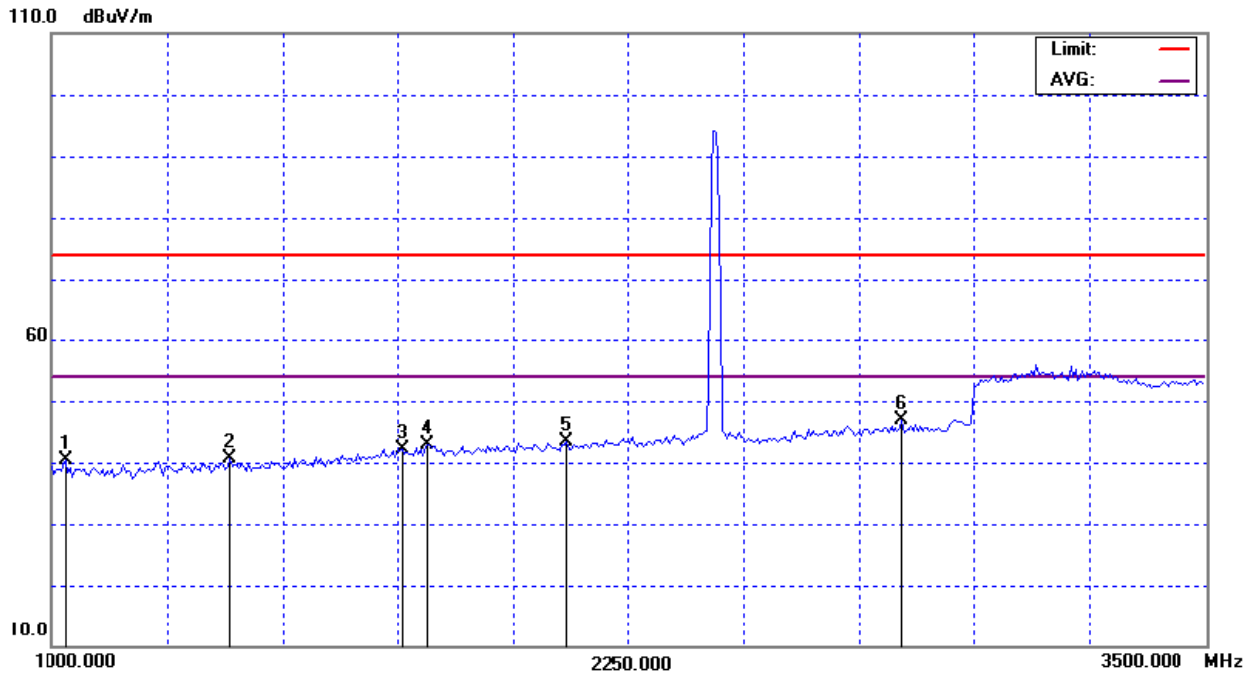

Orthogonal Axes : X
802.11b/CH06(Above 1000 MHz, Horizontal)

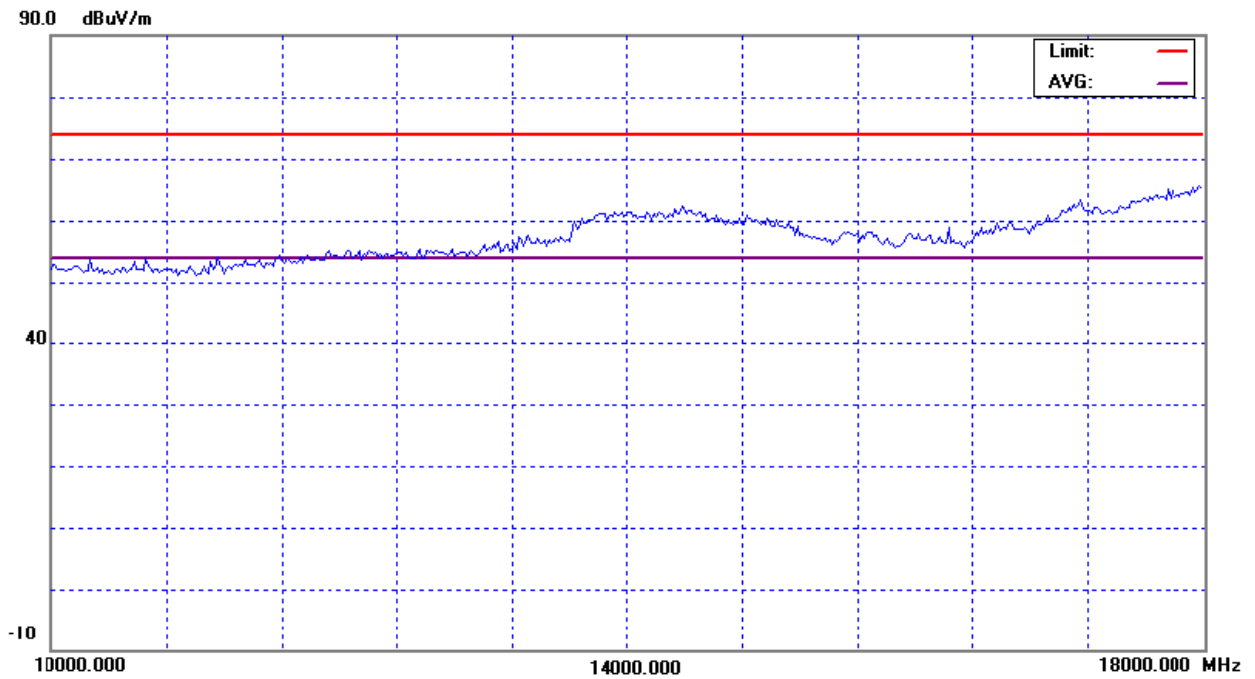

EUT :	Wireless Volp Phone	Model No. :	WLAN 800
Temperature :	25 °C	Relative Humidity :	60 %
Pressure :	1009 hPa	Test Power :	AC 120V/60Hz
Test Mode :	802.11b/CH06		

Freq. (MHz)	Ant.Pol. H/V	Reading		Ant./CF CF(dB)	Act.		Limit		Note
		Peak (dBuV)	AV (dBuV)		Peak (dBuV/m)	AV (dBuV/m)	Peak (dBuV/m)	AV (dBuV/m)	
1090.00	V	48.64	*	-8.63	40.01	*	74.00	54.00	Y/H
1355.00	V	47.68	*	-7.42	40.26	*	74.00	54.00	Y/H
1510.00	V	48.07	*	-6.70	41.37	*	74.00	54.00	Y/H
1985.00	V	47.25	*	-4.06	43.19	*	74.00	54.00	Y/H
2250.00	V	47.63	*	-3.35	44.28	*	74.00	54.00	Y/H
2765.00	V	47.99	*	-1.67	46.32	*	74.00	54.00	Y/H
4878.00	V	46.09	40.85	3.25	49.34	44.10	74.00	54.00	Y/H
7311.00	V	41.80	*	7.80	49.60	*	74.00	54.00	Y/H
9748.00	V	42.30	30.14	10.05	52.35	40.19	74.00	54.00	Y/H

Remark :

- (1) Spectrum Setting : 30MHz – 1000MHz , RBW= 100KHz, VBW=100KHz, Sweep time = 200 ms. 1GHz- 25GHz, RBW= 1MHz, VBW= 1MHz, Sweep time = 200 ms
- (2) All readings are Peak unless otherwise stated QP in column of 『Note』 . Peak denotes that the Peak reading compliance with the QP Limits and then QP Mode measurement didn't perform ◦
- (3) Measuring frequency range from 30MHz to 1000MHz or the 10th harmonic of highest fundamental frequency ◦“F” denotes fundamental frequency; “H” denotes spurious frequency. “E” denotes band edge frequency. (This judgment method includes the Band Edge Requirement.)
- (4) Radiated emissions measured in frequency range above 1000MHz were made with an instrument using Peak detector mode and AV detector mode of the emission ◦
- (5) Data of measurement within this frequency range shown “ * ” in the table above means the reading of emissions are attenuated more than 20dB below the permissible limits or the field strength is too small to be measured.
- (6) A preamp and high pass filter were used for this test in order to provide sufficient measurement sensitivity.
- (7) EUT Orthogonal Axes :
“X” - denotes Laid on Table ; ”Y” - denotes Vertical Stand ; ”Z” - denotes Side Stand

Orthogonal Axes : Y
802.11b/CH06(Above 1000 MHz, Vertical)

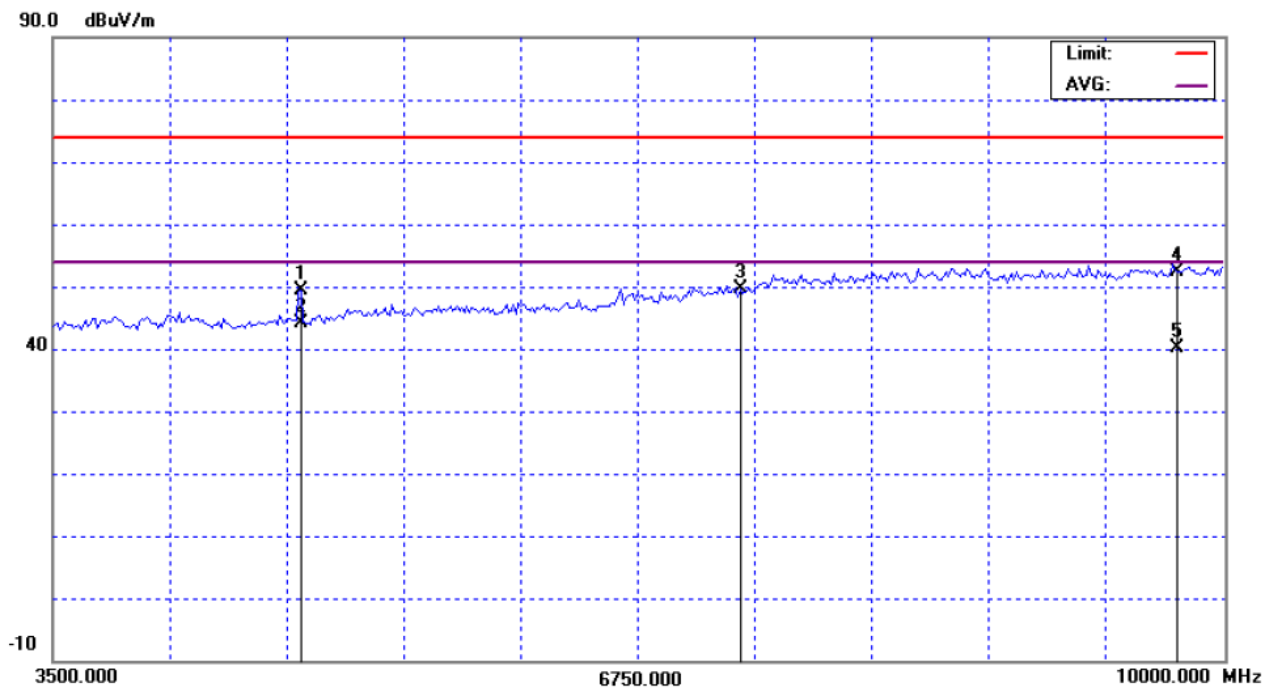
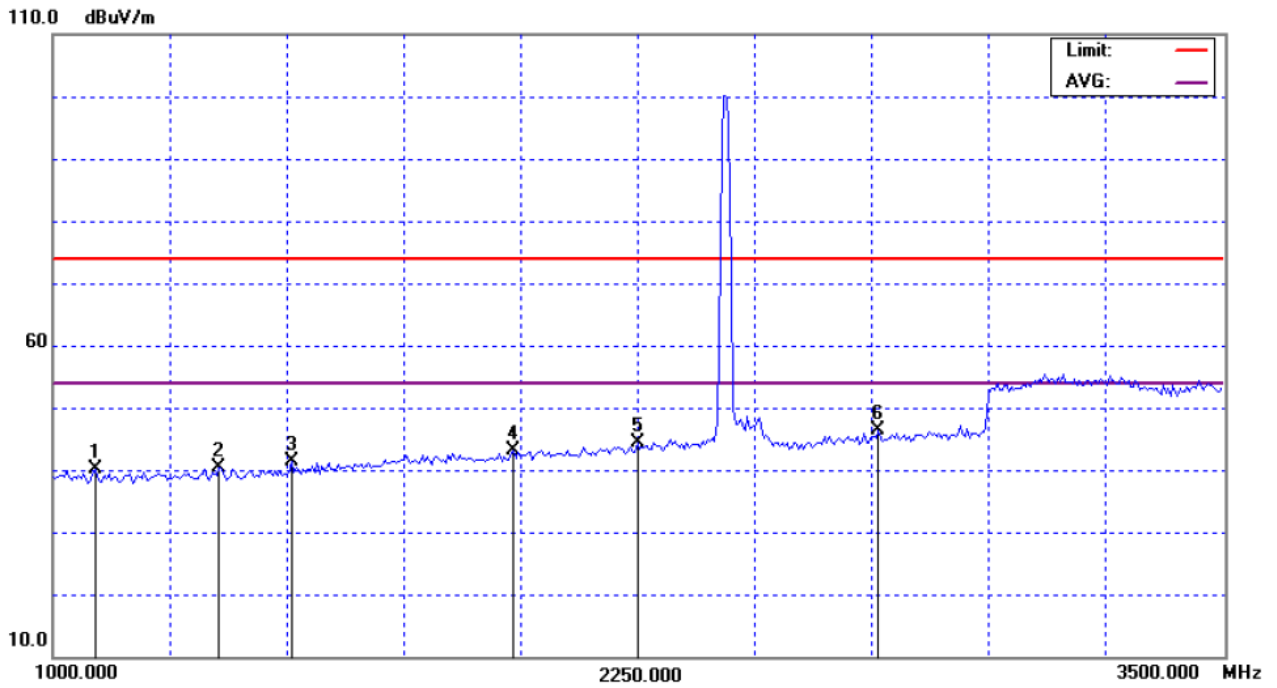

Orthogonal Axes : Y
802.11b/CH06(Above 1000 MHz, Vertical)

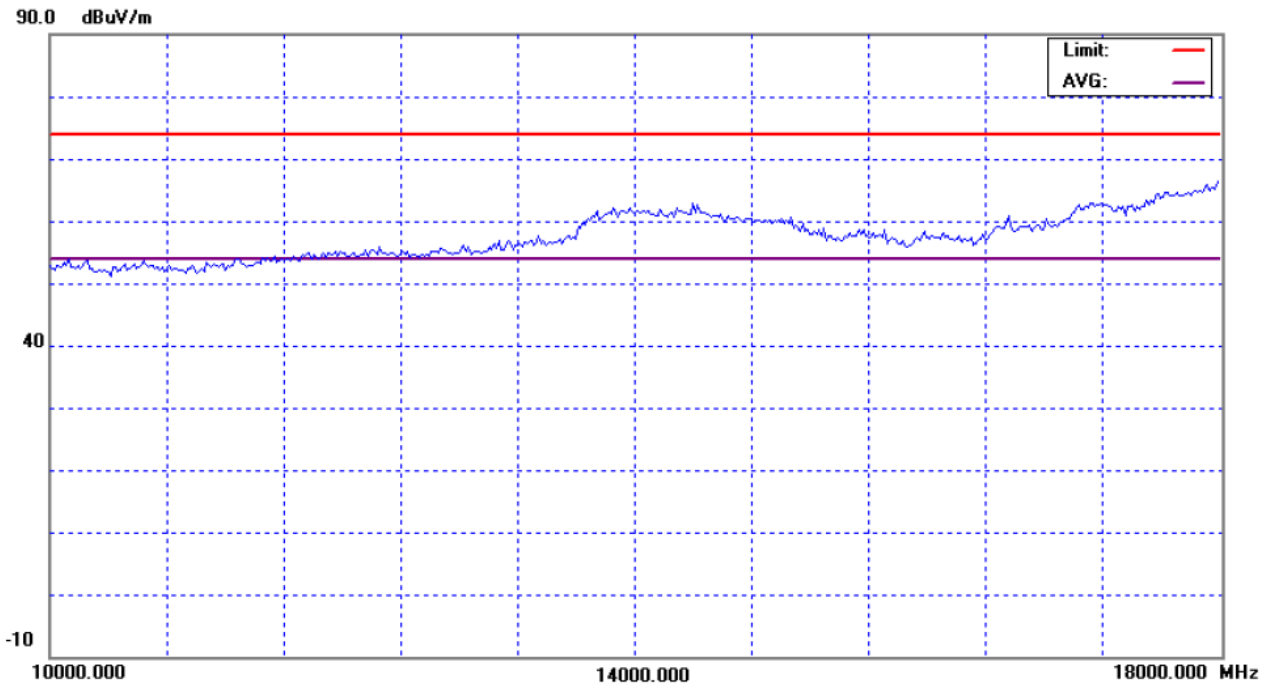

EUT :	Wireless Volp Phone	Model No. :	WLAN 800
Temperature :	25 °C	Relative Humidity :	60 %
Pressure :	1009 hPa	Test Power :	AC 120V/60Hz
Test Mode :	802.11b/CH06		

Freq. (MHz)	Ant.Pol. H/V	Reading		Ant./CF CF(dB)	Act.		Limit		Note
		Peak (dBuV)	AV (dBuV)		Peak (dBuV/m)	AV (dBuV/m)	Peak (dBuV/m)	AV (dBuV/m)	
1230.00	H	47.47	*	-7.99	39.48	*	74.00	54.00	Y/H
1475.00	H	47.58	*	-6.87	40.71	*	74.00	54.00	Y/H
1880.00	H	47.48	*	-4.65	42.83	*	74.00	54.00	Y/H
2150.00	H	47.42	*	-3.60	43.82	*	74.00	54.00	Y/H
2610.00	H	48.06	*	-2.28	45.78	*	74.00	54.00	Y/H
2840.00	H	47.22	*	-1.37	45.85	*	74.00	54.00	Y/H
4865.00	H	53.65	48.35	3.22	56.87	51.57	74.00	54.00	Y/H
7311.00	H	41.70	*	7.80	49.50	*	74.00	54.00	Y/H
9748.00	H	42.70	29.79	10.05	52.75	39.84	74.00	54.00	Y/H

Remark :

- (1) Spectrum Setting : 30MHz – 1000MHz , RBW= 100KHz, VBW=100KHz, Sweep time = 200 ms. 1GHz- 25GHz, RBW= 1MHz, VBW= 1MHz, Sweep time = 200 ms
- (2) All readings are Peak unless otherwise stated QP in column of 『Note』 . Peak denotes that the Peak reading compliance with the QP Limits and then QP Mode measurement didn't perform ◦
- (3) Measuring frequency range from 30MHz to 1000MHz or the 10th harmonic of highest fundamental frequency ◦ "F" denotes fundamental frequency; "H" denotes spurious frequency. "E" denotes band edge frequency. (This judgment method includes the Band Edge Requirement.)
- (4) Radiated emissions measured in frequency range above 1000MHz were made with an instrument using Peak detector mode and AV detector mode of the emission ◦
- (5) Data of measurement within this frequency range shown " * " in the table above means the reading of emissions are attenuated more than 20dB below the permissible limits or the field strength is too small to be measured.
- (6) A preamp and high pass filter were used for this test in order to provide sufficient measurement sensitivity.
- (7) EUT Orthogonal Axes :
 "X" - denotes Laid on Table ; "Y" - denotes Vertical Stand ; "Z" - denotes Side Stand

Orthogonal Axes : Y
802.11b/CH06(Above 1000 MHz, Horizontal)

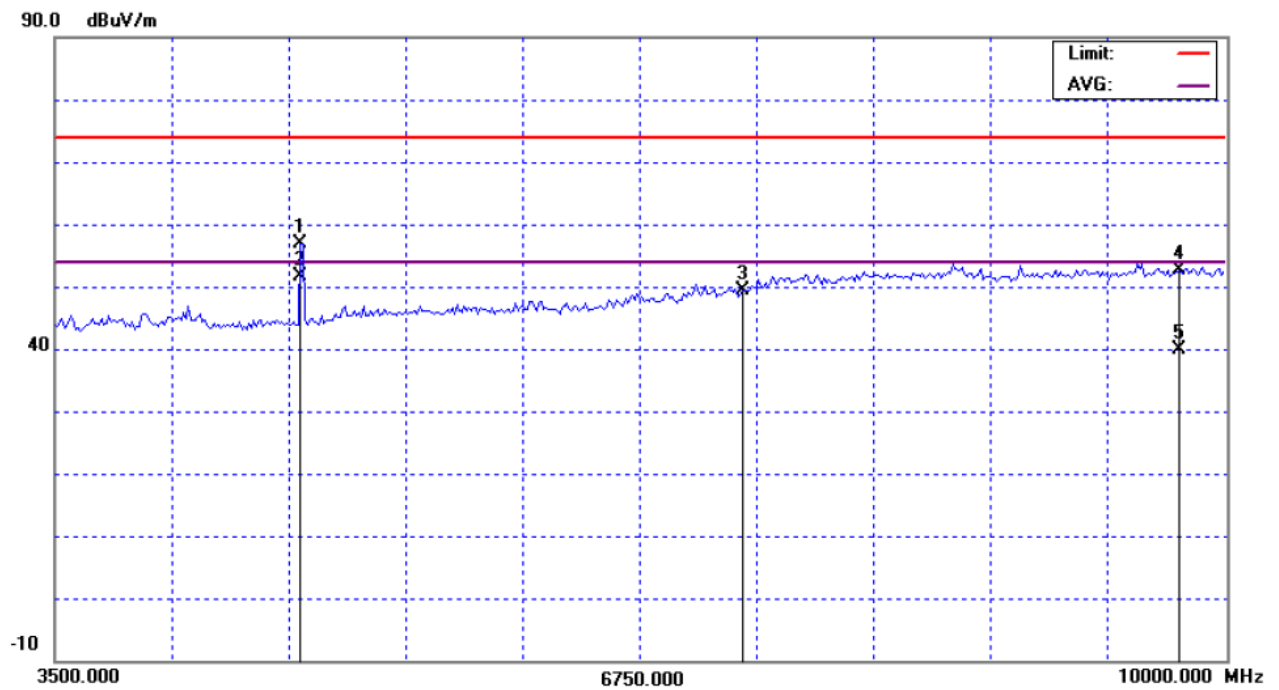
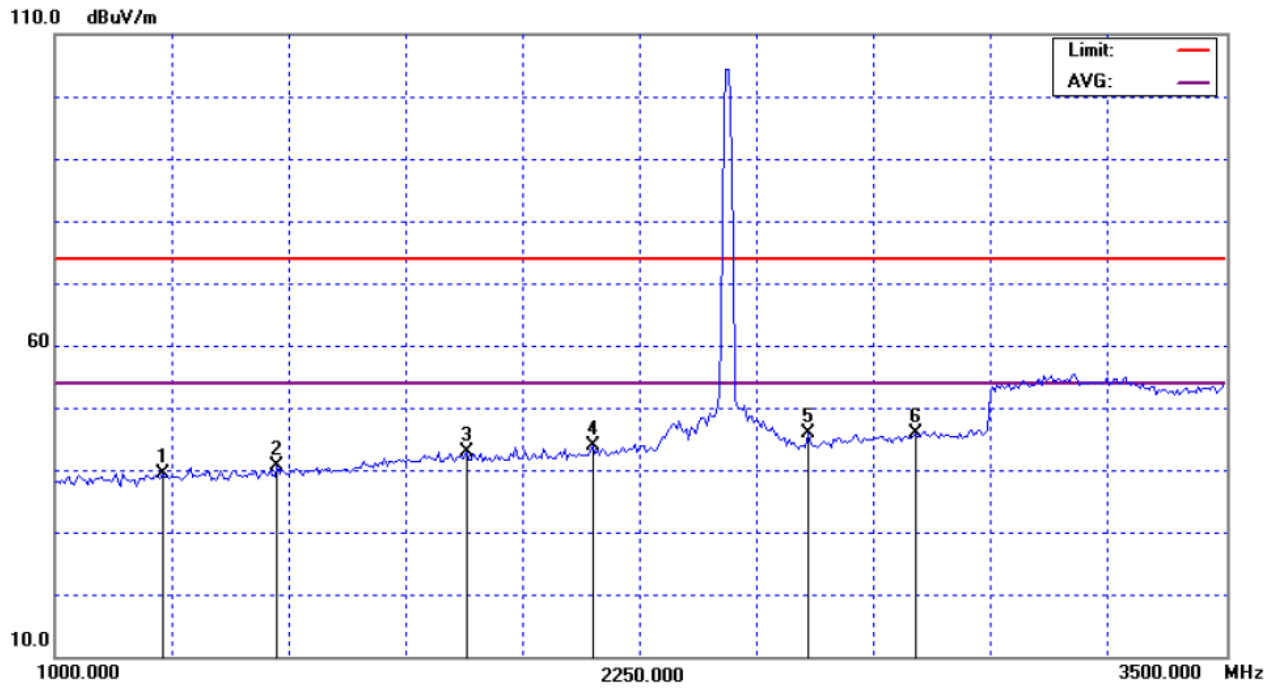

Orthogonal Axes : Y
802.11b/CH06(Above 1000 MHz, Horizontal)

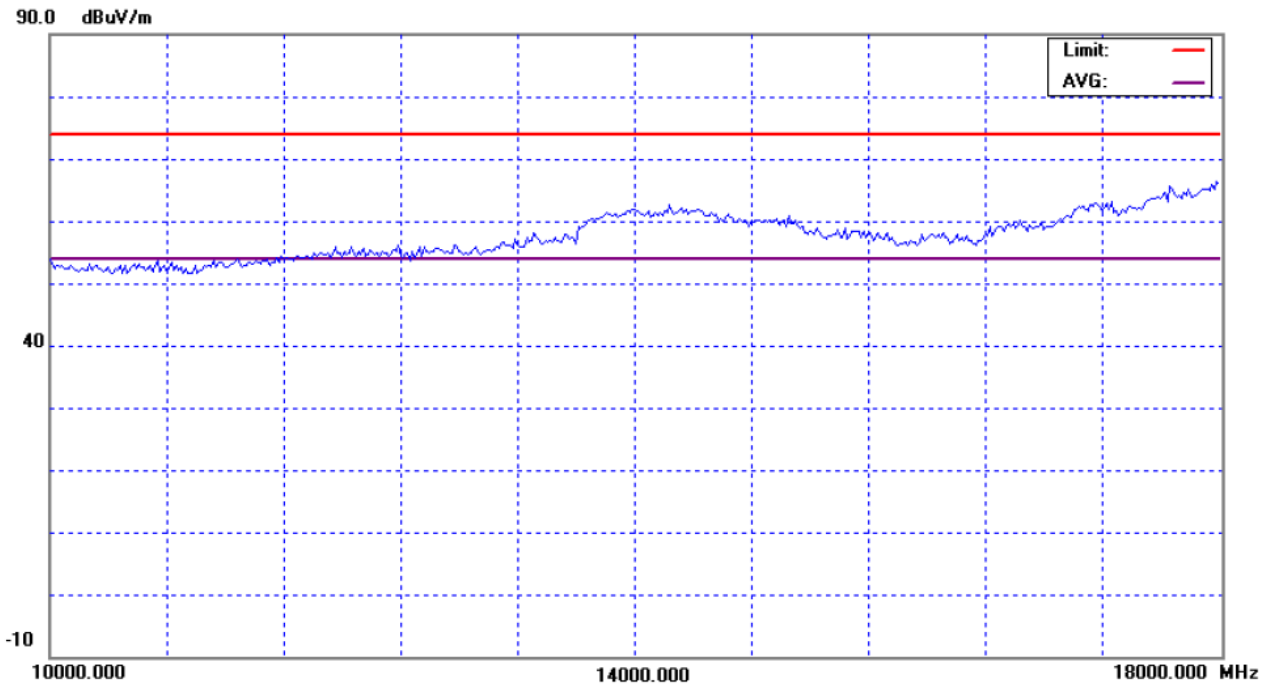

EUT :	Wireless Volp Phone	Model No. :	WLAN 800
Temperature :	25 °C	Relative Humidity :	60 %
Pressure :	1009 hPa	Test Power :	AC 120V/60Hz
Test Mode :	802.11b/CH06		

Freq. (MHz)	Ant.Pol. H/V	Reading		Ant./CF CF(dB)	Act.		Limit		Note
		Peak (dBuV)	AV (dBuV)		Peak (dBuV/m)	AV (dBuV/m)	Peak (dBuV/m)	AV (dBuV/m)	
1090.00	V	48.13	*	-8.63	39.50	*	74.00	54.00	Z/H
1325.00	V	48.22	*	-7.56	40.66	*	74.00	54.00	Z/H
1525.00	V	47.62	*	-6.62	41.00	*	74.00	54.00	Z/H
2035.00	V	47.35	*	-3.89	43.46	*	74.00	54.00	Z/H
2185.00	V	48.00	*	-3.51	44.49	*	74.00	54.00	Z/H
2910.00	V	48.10	*	-1.10	47.00	*	74.00	54.00	Z/H
4878.00	V	47.53	41.37	3.25	50.78	44.62	74.00	54.00	Z/H
7311.00	V	41.05	*	7.80	48.85	*	74.00	54.00	Z/H
9748.00	V	42.25	29.76	10.05	52.30	39.81	74.00	54.00	Z/H

Remark :

- (1) Spectrum Setting : 30MHz – 1000MHz , RBW= 100KHz, VBW=100KHz, Sweep time = 200 ms. 1GHz- 25GHz, RBW= 1MHz, VBW= 1MHz, Sweep time = 200 ms
- (2) All readings are Peak unless otherwise stated QP in column of 『Note』 . Peak denotes that the Peak reading compliance with the QP Limits and then QP Mode measurement didn't perform ◦
- (3) Measuring frequency range from 30MHz to 1000MHz or the 10th harmonic of highest fundamental frequency ◦ "F" denotes fundamental frequency; "H" denotes spurious frequency. "E" denotes band edge frequency. (This judgment method includes the Band Edge Requirement.)
- (4) Radiated emissions measured in frequency range above 1000MHz were made with an instrument using Peak detector mode and AV detector mode of the emission ◦
- (5) Data of measurement within this frequency range shown " * " in the table above means the reading of emissions are attenuated more than 20dB below the permissible limits or the field strength is too small to be measured.
- (6) A preamp and high pass filter were used for this test in order to provide sufficient measurement sensitivity.
- (7) EUT Orthogonal Axes :
"X" - denotes Laid on Table ; "Y" - denotes Vertical Stand ; "Z" - denotes Side Stand

Orthogonal Axes : Z
802.11b/CH06(Above 1000 MHz, Vertical)

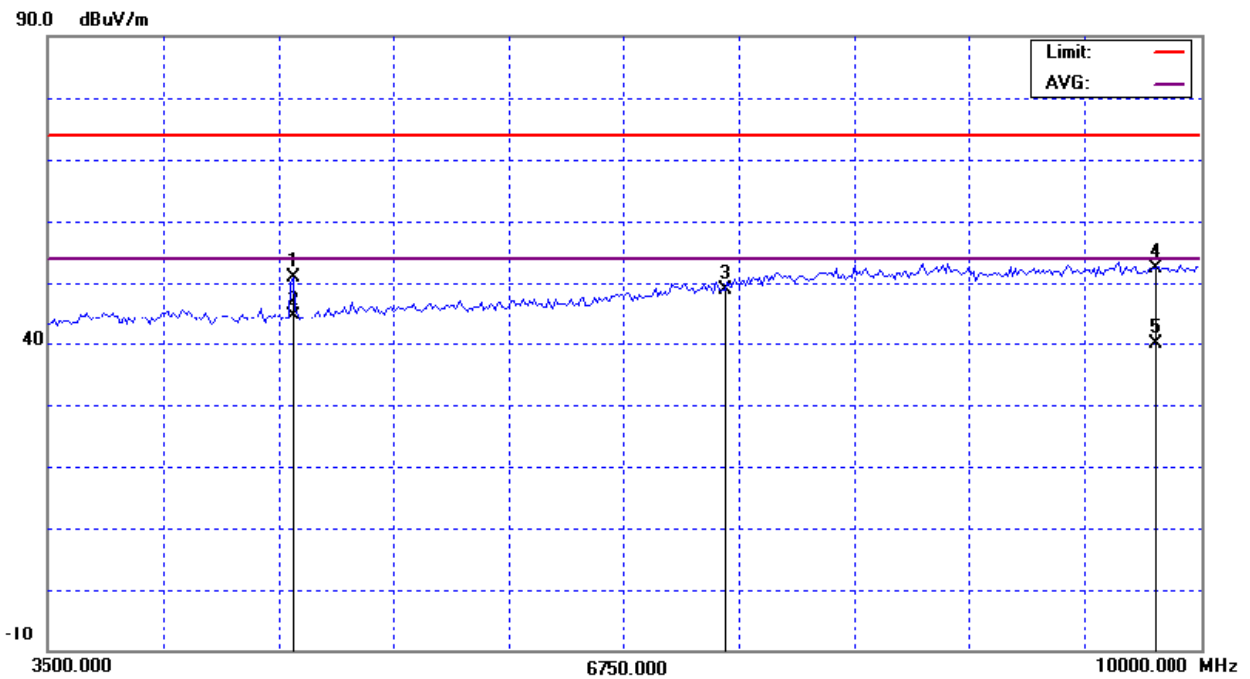
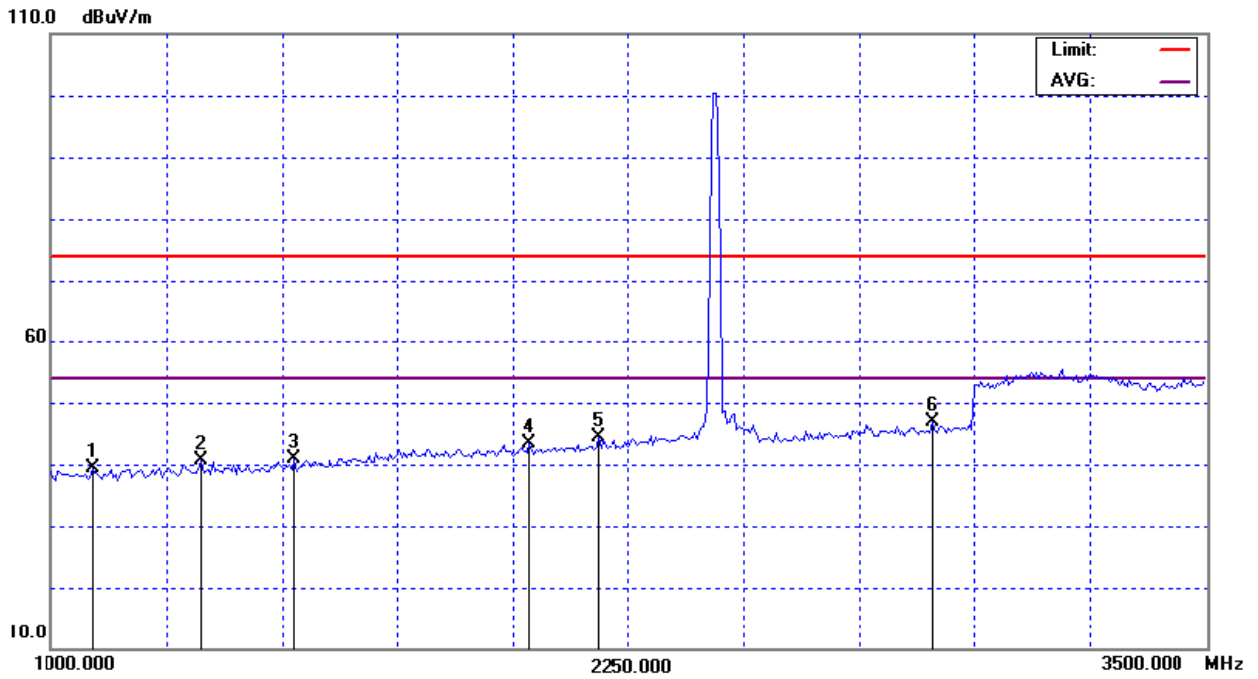

Orthogonal Axes : Z
802.11b/CH06(Above 1000 MHz, Vertical)

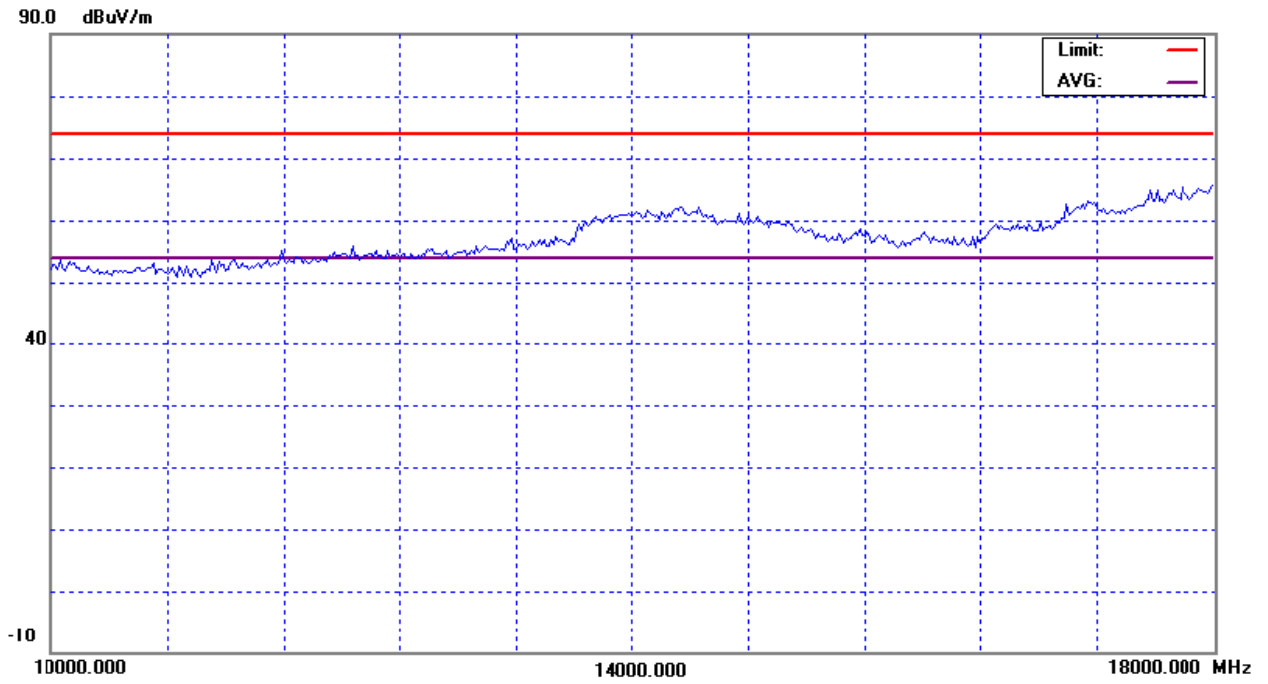

EUT :	Wireless Volp Phone	Model No. :	WLAN 800
Temperature :	25 °C	Relative Humidity :	60 %
Pressure :	1009 hPa	Test Power :	AC 120V/60Hz
Test Mode :	802.11b/CH06		

Freq. (MHz)	Ant.Pol. H/V	Reading		Ant./CF CF(dB)	Act.		Limit		Note
		Peak (dBuV)	AV (dBuV)		Peak (dBuV/m)	AV (dBuV/m)	Peak (dBuV/m)	AV (dBuV/m)	
1030.00	H	48.43	*	-8.90	39.53	*	74.00	54.00	Z/H
1320.00	H	48.38	*	-7.58	40.80	*	74.00	54.00	Z/H
1530.00	H	47.65	*	-6.59	41.06	*	74.00	54.00	Z/H
1775.00	H	48.38	*	-5.23	43.15	*	74.00	54.00	Z/H
2060.00	H	47.31	*	-3.83	43.48	*	74.00	54.00	Z/H
2810.00	H	47.70	*	-1.49	46.21	*	74.00	54.00	Z/H
4878.00	H	45.94	40.20	3.25	49.19	43.45	74.00	54.00	Z/H
7311.00	H	42.10	*	7.80	49.90	*	74.00	54.00	Z/H
9748.00	H	41.48	*	10.05	51.53	*	74.00	54.00	Z/H

Remark :

- (1) Spectrum Setting : 30MHz – 1000MHz , RBW= 100KHz, VBW=100KHz, Sweep time = 200 ms. 1GHz- 25GHz, RBW= 1MHz, VBW= 1MHz, Sweep time = 200 ms
- (2) All readings are Peak unless otherwise stated QP in column of 『Note』 . Peak denotes that the Peak reading compliance with the QP Limits and then QP Mode measurement didn't perform ◦
- (3) Measuring frequency range from 30MHz to 1000MHz or the 10th harmonic of highest fundamental frequency ◦ "F" denotes fundamental frequency; "H" denotes spurious frequency. "E" denotes band edge frequency. (This judgment method includes the Band Edge Requirement.)
- (4) Radiated emissions measured in frequency range above 1000MHz were made with an instrument using Peak detector mode and AV detector mode of the emission ◦
- (5) Data of measurement within this frequency range shown " * " in the table above means the reading of emissions are attenuated more than 20dB below the permissible limits or the field strength is too small to be measured.
- (6) A preamp and high pass filter were used for this test in order to provide sufficient measurement sensitivity.
- (7) EUT Orthogonal Axes :
 "X" - denotes Laid on Table ; "Y" - denotes Vertical Stand ; "Z" - denotes Side Stand

Orthogonal Axes : Z
802.11b/CH06(Above 1000 MHz, Horizontal)

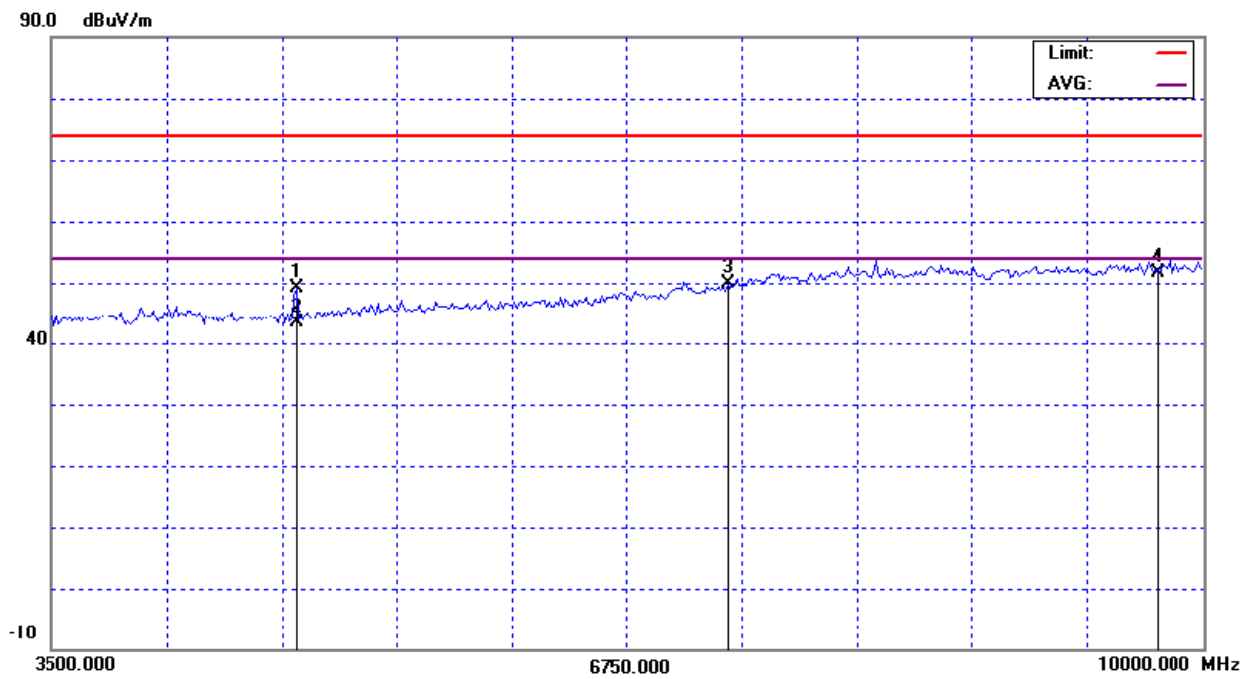
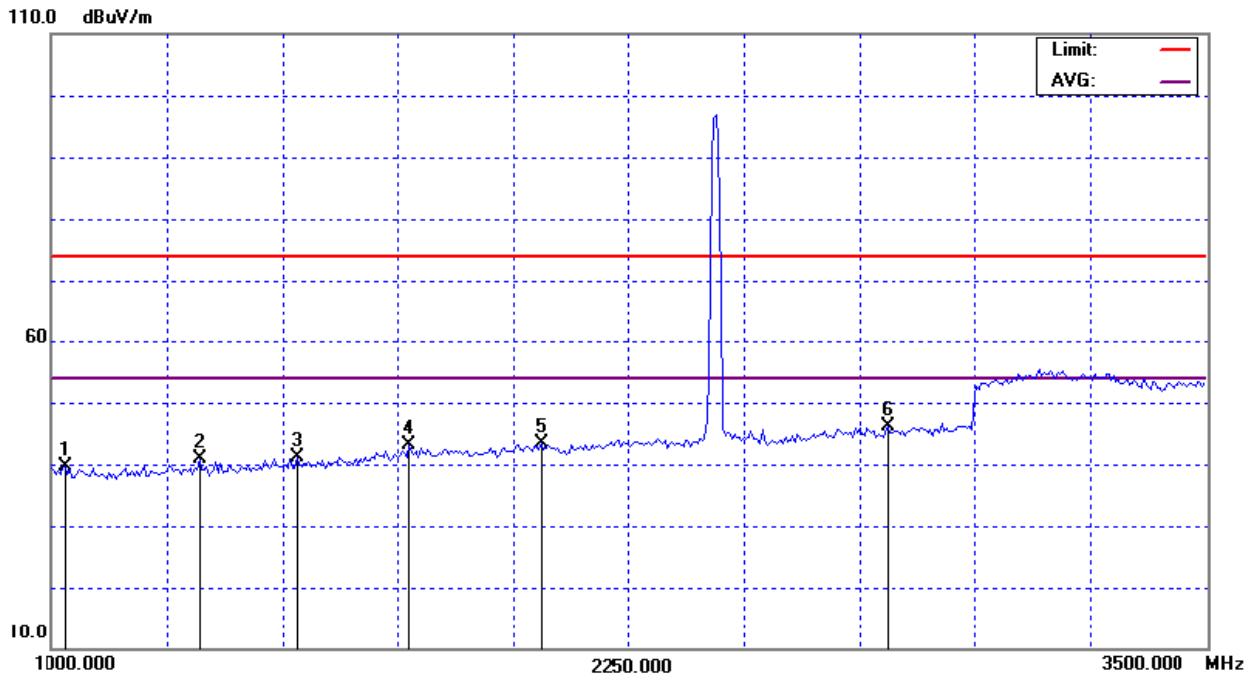

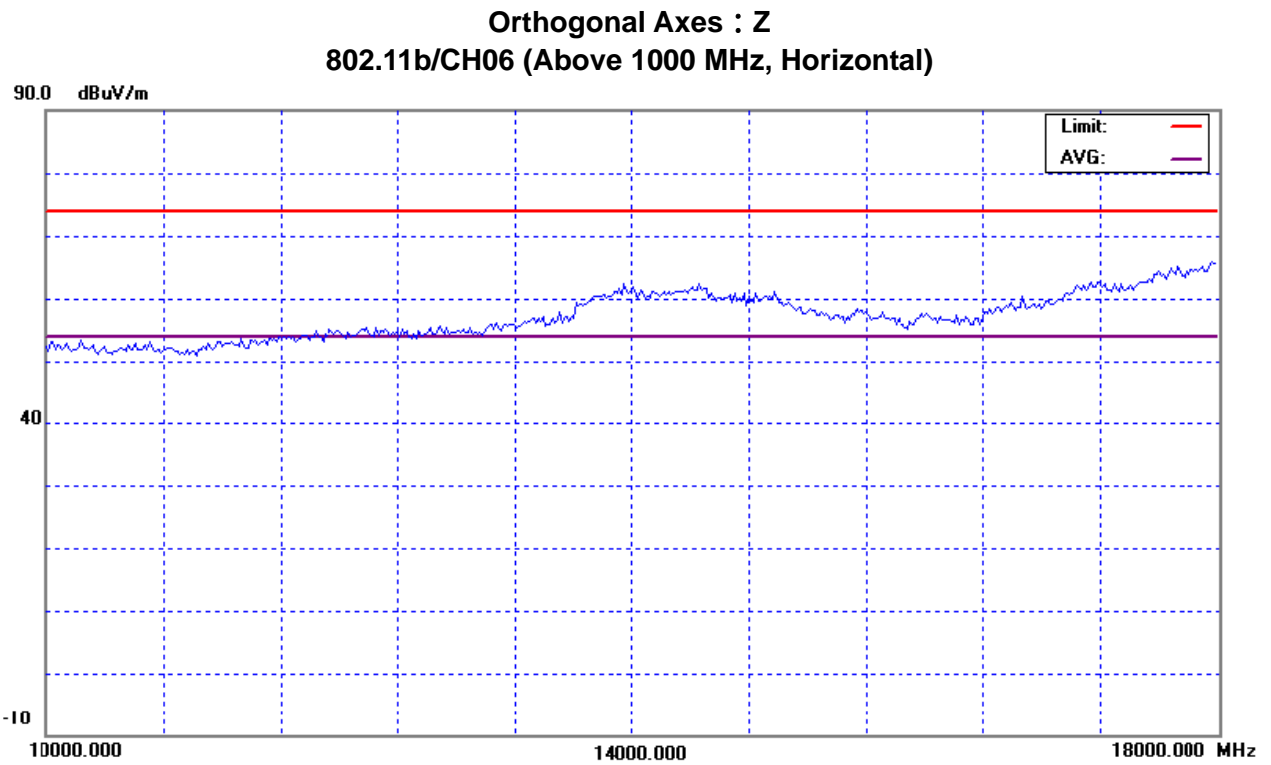

EUT :	Wireless Volp Phone	Model No. :	WLAN 800
Temperature :	25 °C	Relative Humidity :	60 %
Pressure :	1009 hPa	Test Power :	AC 120V/60Hz
Test Mode :	802.11b/CH11		

Freq. (MHz)	Ant.Pol. H/V	Reading		Ant./CF CF(dB)	Act.		Limit		Note
		Peak (dBuV)	AV (dBuV)		Peak (dBuV/m)	AV (dBuV/m)	Peak (dBuV/m)	AV (dBuV/m)	
1085.00	V	48.27	*	-8.65	39.62	*	74.00	54.00	X/H
1160.00	V	47.91	*	-8.31	39.60	*	74.00	54.00	X/H
1380.00	V	48.16	*	-7.31	40.85	*	74.00	54.00	X/H
1555.00	V	48.44	*	-6.45	41.99	*	74.00	54.00	X/H
1860.00	V	47.77	*	-4.76	43.01	*	74.00	54.00	X/H
2260.00	V	47.64	*	-3.32	44.32	*	74.00	54.00	X/H
4930.00	V	46.76	40.55	3.38	50.14	43.93	74.00	54.00	X/H
7386.00	V	41.08	*	8.13	49.21	*	74.00	54.00	X/H
9848.00	V	41.78	*	10.13	51.91	*	74.00	54.00	X/H

Remark :

- (1) Spectrum Setting : 30MHz – 1000MHz , RBW= 100KHz, VBW=100KHz, Sweep time = 200 ms. 1GHz- 25GHz, RBW= 1MHz, VBW= 1MHz, Sweep time = 200 ms
- (2) All readings are Peak unless otherwise stated QP in column of 『Note』 . Peak denotes that the Peak reading compliance with the QP Limits and then QP Mode measurement didn't perform ◦
- (3) Measuring frequency range from 30MHz to 1000MHz or the 10th harmonic of highest fundamental frequency ◦ "F" denotes fundamental frequency; "H" denotes spurious frequency. "E" denotes band edge frequency. (This judgment method includes the Band Edge Requirement.)
- (4) Radiated emissions measured in frequency range above 1000MHz were made with an instrument using Peak detector mode and AV detector mode of the emission ◦
- (5) Data of measurement within this frequency range shown " * " in the table above means the reading of emissions are attenuated more than 20dB below the permissible limits or the field strength is too small to be measured.
- (6) A preamp and high pass filter were used for this test in order to provide sufficient measurement sensitivity.
- (7) EUT Orthogonal Axes :
"X" - denotes Laid on Table ; "Y" - denotes Vertical Stand ; "Z" - denotes Side Stand

Orthogonal Axes : X
802.11b/CH11(Above 1000 MHz, Vertical)

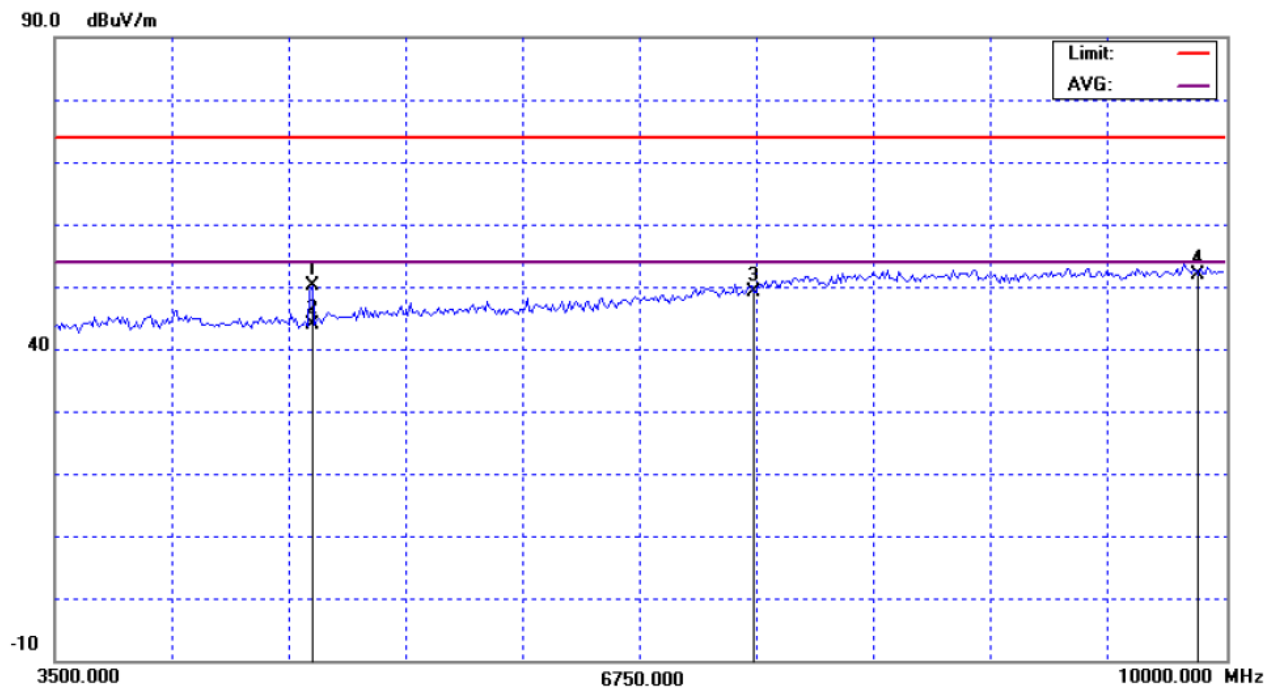
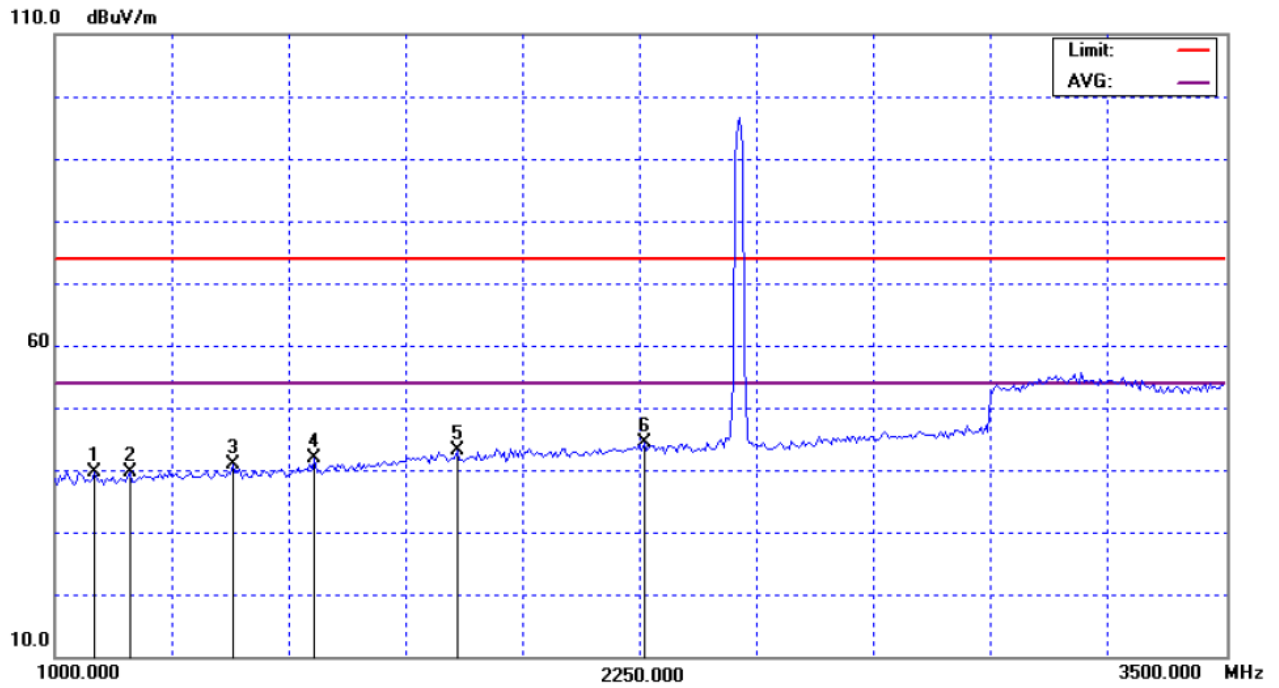

Orthogonal Axes : X
802.11b/CH11(Above 1000 MHz, Vertical)

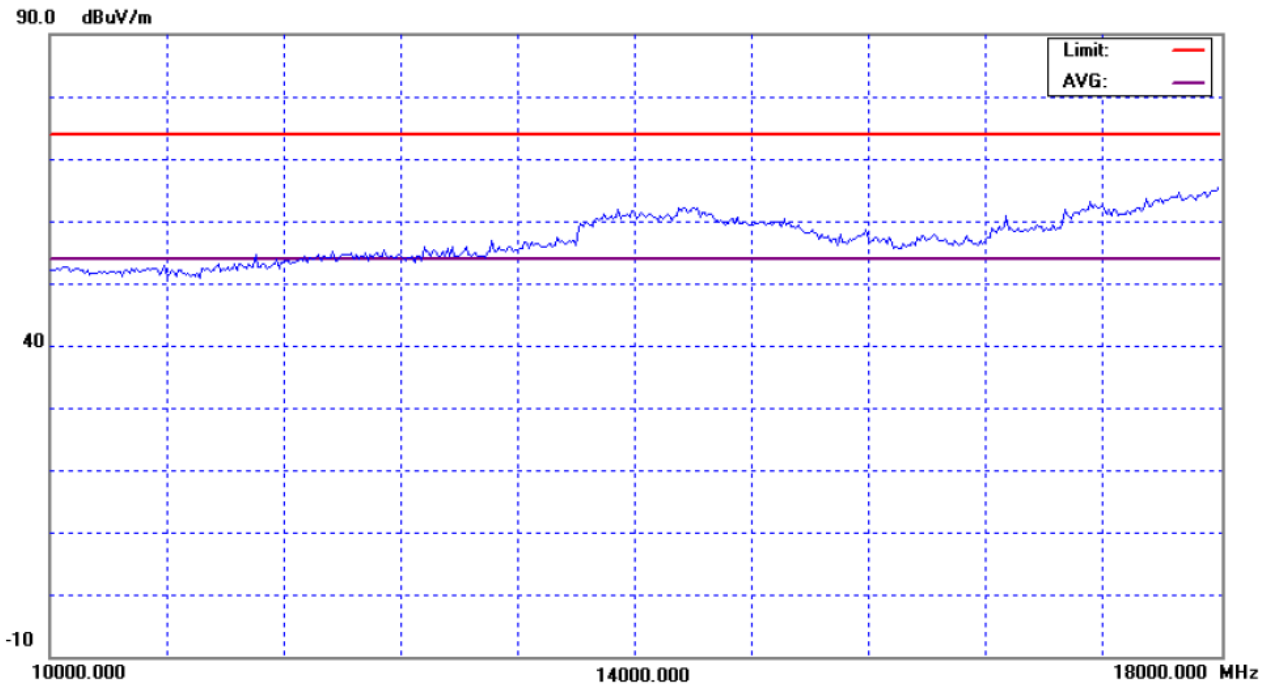

EUT :	Wireless Volp Phone	Model No. :	WLAN 800
Temperature :	25 °C	Relative Humidity :	60 %
Pressure :	1009 hPa	Test Power :	AC 120V/60Hz
Test Mode :	802.11b/CH11		

Freq. (MHz)	Ant.Pol. H/V	Reading		Ant./CF CF(dB)	Act.		Limit		Note
		Peak (dBuV)	AV (dBuV)		Peak (dBuV/m)	AV (dBuV/m)	Peak (dBuV/m)	AV (dBuV/m)	
1070.00	H	48.02	*	-8.72	39.30	*	74.00	54.00	X/H
1160.00	H	48.13	*	-8.31	39.82	*	74.00	54.00	X/H
1455.00	H	46.95	*	-6.97	39.98	*	74.00	54.00	X/H
1820.00	H	48.58	*	-4.98	43.60	*	74.00	54.00	X/H
2090.00	H	47.36	*	-3.75	43.61	*	74.00	54.00	X/H
2695.00	H	47.50	*	-1.95	45.55	*	74.00	54.00	X/H
4930.00	H	43.47	38.12	3.38	46.85	41.50	74.00	54.00	X/H
7386.00	H	42.17	*	8.13	50.30	*	74.00	54.00	X/H
9848.00	H	41.73	*	10.13	51.86	*	74.00	54.00	X/H

Remark :

- (1) Spectrum Setting : 30MHz – 1000MHz , RBW= 100KHz, VBW=100KHz, Sweep time = 200 ms. 1GHz- 25GHz, RBW= 1MHz, VBW= 1MHz, Sweep time = 200 ms
- (2) All readings are Peak unless otherwise stated QP in column of 『Note』 . Peak denotes that the Peak reading compliance with the QP Limits and then QP Mode measurement didn't perform ◦
- (3) Measuring frequency range from 30MHz to 1000MHz or the 10th harmonic of highest fundamental frequency ◦ "F" denotes fundamental frequency; "H" denotes spurious frequency. "E" denotes band edge frequency. (This judgment method includes the Band Edge Requirement.)
- (4) Radiated emissions measured in frequency range above 1000MHz were made with an instrument using Peak detector mode and AV detector mode of the emission ◦
- (5) Data of measurement within this frequency range shown " * " in the table above means the reading of emissions are attenuated more than 20dB below the permissible limits or the field strength is too small to be measured.
- (6) A preamp and high pass filter were used for this test in order to provide sufficient measurement sensitivity.
- (7) EUT Orthogonal Axes :
"X" - denotes Laid on Table ; "Y" - denotes Vertical Stand ; "Z" - denotes Side Stand

Orthogonal Axes : X
802.11b/CH11(Above 1000 MHz, Horizontal)

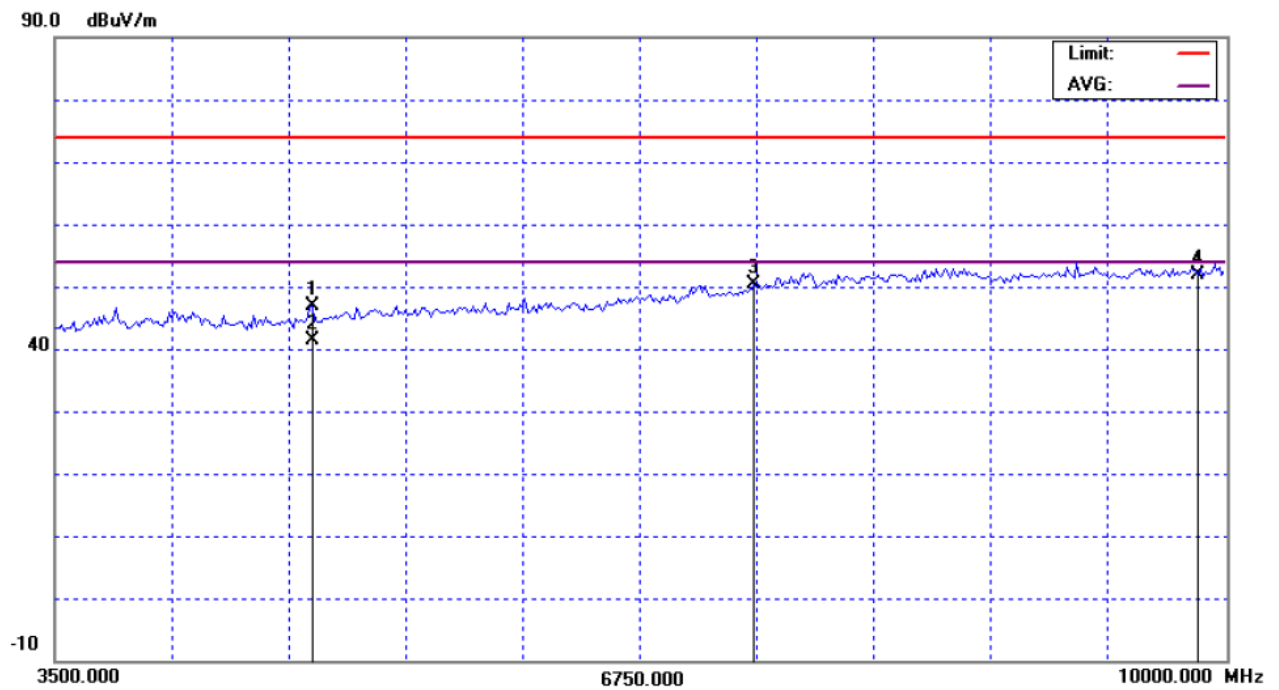
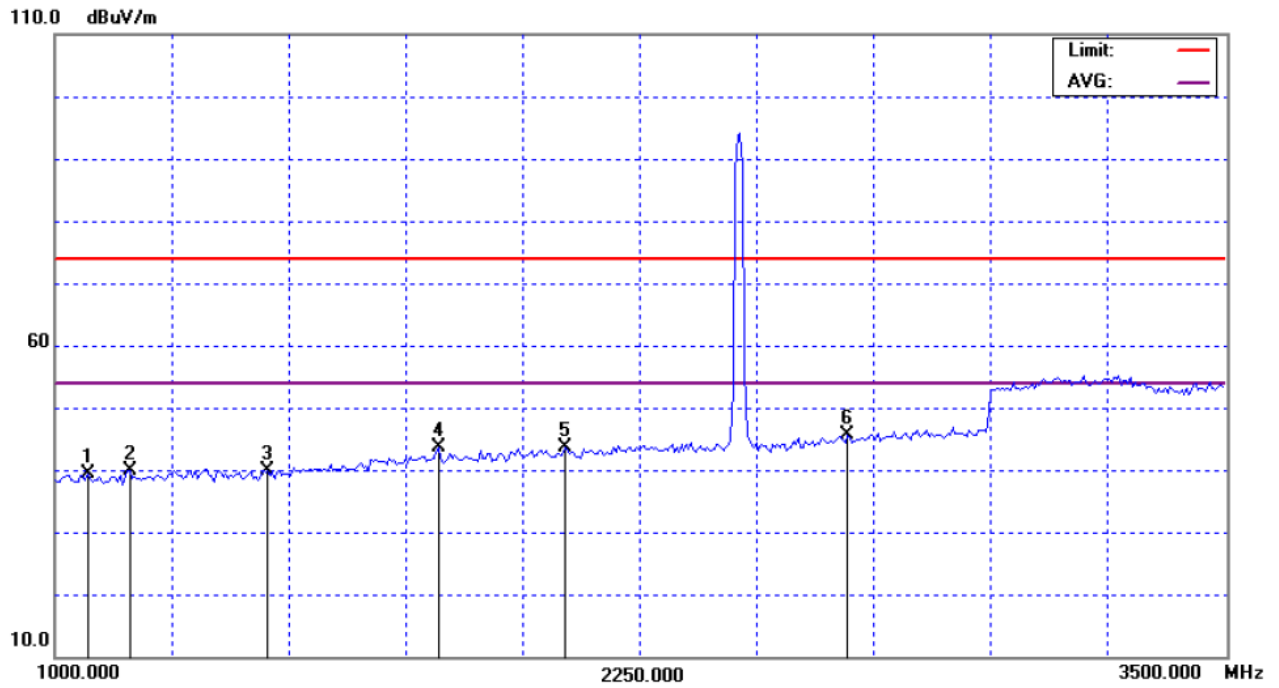

Orthogonal Axes : X
802.11b/CH11(Above 1000 MHz, Horizontal)

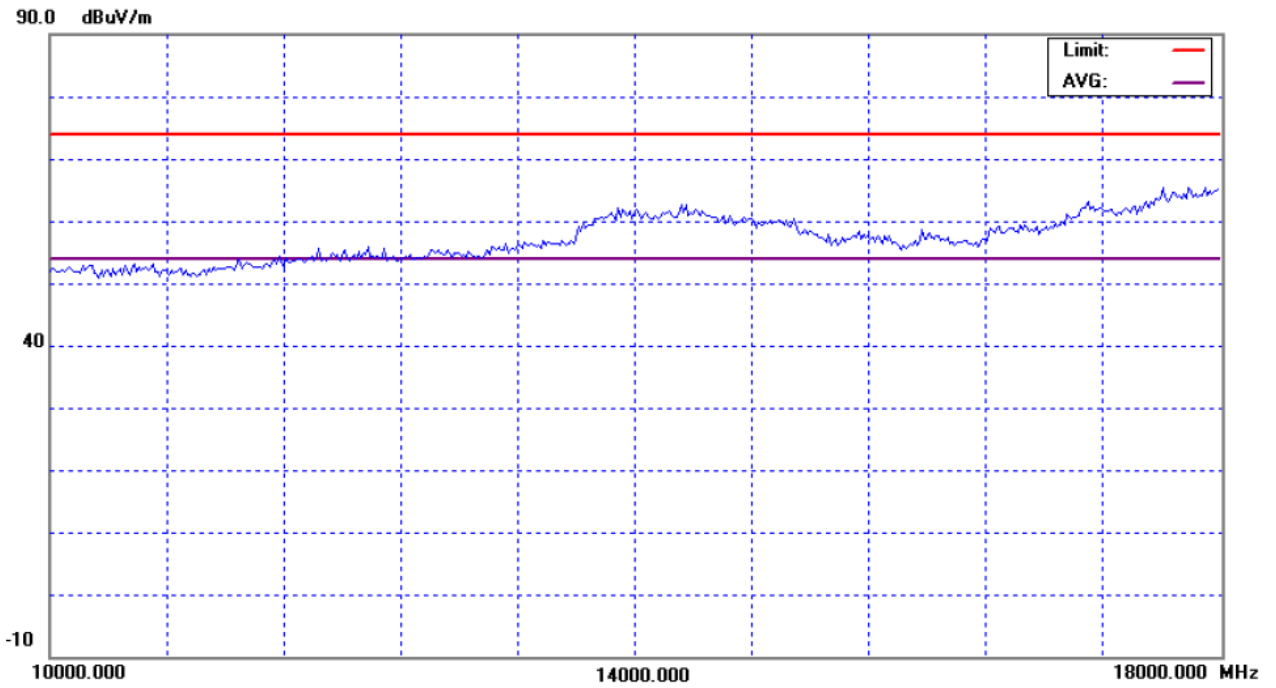

EUT :	Wireless Volp Phone	Model No. :	WLAN 800
Temperature :	25 °C	Relative Humidity :	60 %
Pressure :	1009 hPa	Test Power :	AC 120V/60Hz
Test Mode :	802.11b/CH11		

Freq. (MHz)	Ant.Pol. H/V	Reading		Ant./CF CF(dB)	Act.		Limit		Note
		Peak (dBuV)	AV (dBuV)		Peak (dBuV/m)	AV (dBuV/m)	Peak (dBuV/m)	AV (dBuV/m)	
1095.00	V	48.87	*	-8.61	40.26	*	74.00	54.00	Y/H
1275.00	V	48.18	*	-7.79	40.39	*	74.00	54.00	Y/H
1395.00	V	47.91	*	-7.24	40.67	*	74.00	54.00	Y/H
1650.00	V	47.49	*	-5.93	41.56	*	74.00	54.00	Y/H
1770.00	V	48.24	*	-5.26	42.98	*	74.00	54.00	Y/H
2225.00	V	48.14	*	-3.41	44.73	*	74.00	54.00	Y/H
4930.00	V	49.16	44.00	3.38	52.54	47.38	74.00	54.00	Y/H
7386.00	V	41.23	*	8.13	49.36	*	74.00	54.00	Y/H
9848.00	V	42.53	29.80	10.13	52.66	39.93	74.00	54.00	Y/H

Remark :

- (1) Spectrum Setting : 30MHz – 1000MHz , RBW= 100KHz, VBW=100KHz, Sweep time = 200 ms. 1GHz- 25GHz, RBW= 1MHz, VBW= 1MHz, Sweep time = 200 ms
- (2) All readings are Peak unless otherwise stated QP in column of 『Note』 . Peak denotes that the Peak reading compliance with the QP Limits and then QP Mode measurement didn't perform ◦
- (3) Measuring frequency range from 30MHz to 1000MHz or the 10th harmonic of highest fundamental frequency ◦ "F" denotes fundamental frequency; "H" denotes spurious frequency. "E" denotes band edge frequency. (This judgment method includes the Band Edge Requirement.)
- (4) Radiated emissions measured in frequency range above 1000MHz were made with an instrument using Peak detector mode and AV detector mode of the emission ◦
- (5) Data of measurement within this frequency range shown " * " in the table above means the reading of emissions are attenuated more than 20dB below the permissible limits or the field strength is too small to be measured.
- (6) A preamp and high pass filter were used for this test in order to provide sufficient measurement sensitivity.
- (7) EUT Orthogonal Axes :
"X" - denotes Laid on Table ; "Y" - denotes Vertical Stand ; "Z" - denotes Side Stand

Orthogonal Axes : Y
802.11b/CH11(Above 1000 MHz, Vertical)

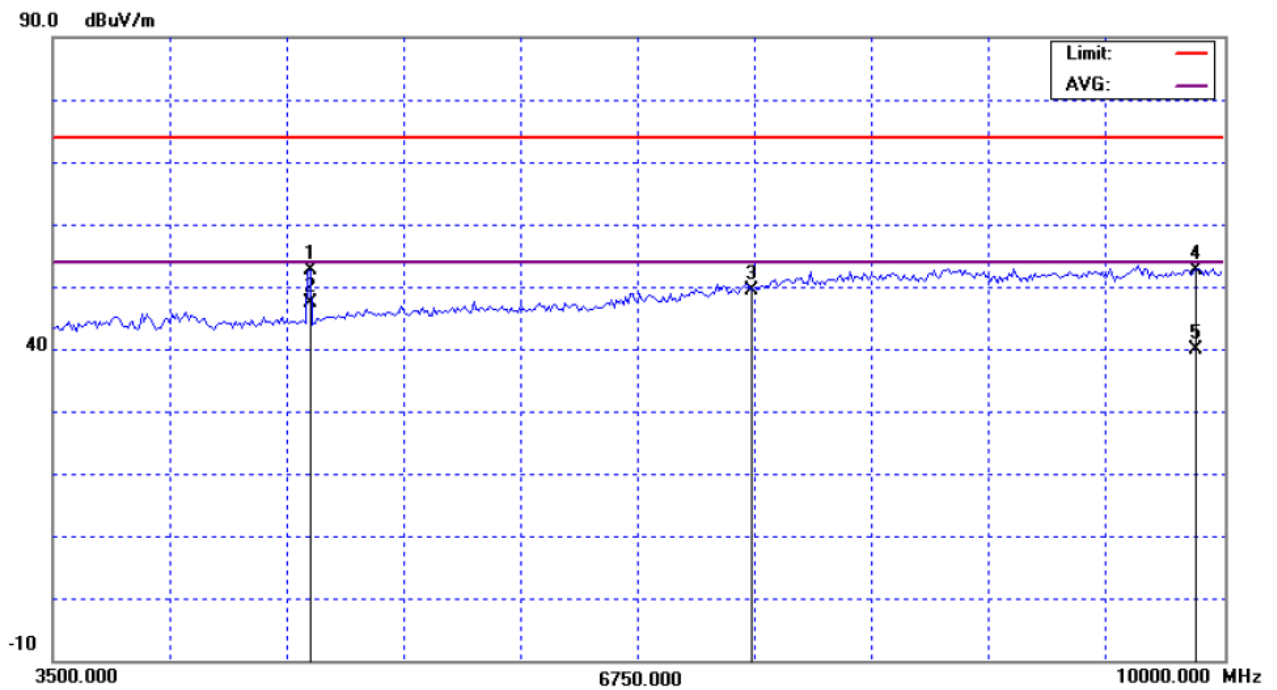
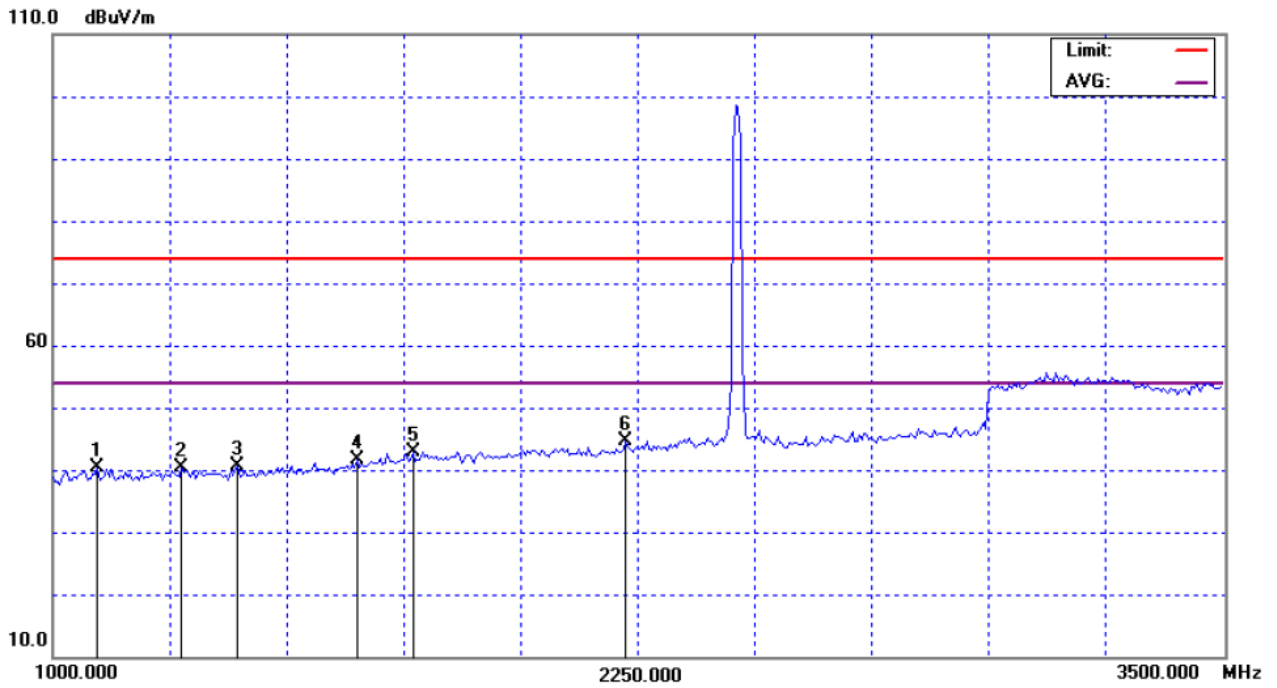

Orthogonal Axes : Y
802.11b/CH11(Above 1000 MHz, Vertical)

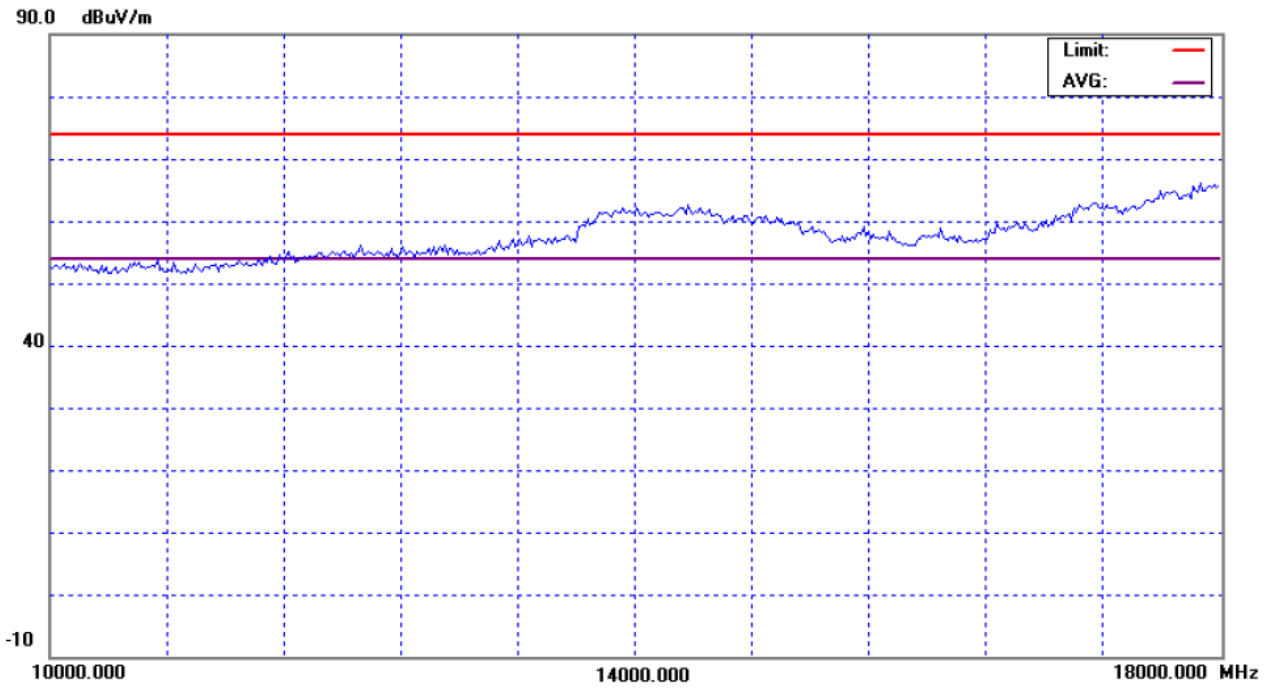

EUT :	Wireless Volp Phone	Model No. :	WLAN 800
Temperature :	25 °C	Relative Humidity :	60 %
Pressure :	1009 hPa	Test Power :	AC 120V/60Hz
Test Mode :	802.11b/CH11		

Freq. (MHz)	Ant.Pol. H/V	Reading		Ant./CF CF(dB)	Act.		Limit		Note
		Peak (dBuV)	AV (dBuV)		Peak (dBuV/m)	AV (dBuV/m)	Peak (dBuV/m)	AV (dBuV/m)	
1020.00	H	48.61	*	-8.95	39.66	*	74.00	54.00	Y/H
1215.00	H	47.74	*	-8.06	39.68	*	74.00	54.00	Y/H
1385.00	H	47.68	*	-7.28	40.40	*	74.00	54.00	Y/H
1575.00	H	47.86	*	-6.34	41.52	*	74.00	54.00	Y/H
1875.00	H	47.62	*	-4.67	42.95	*	74.00	54.00	Y/H
2030.00	H	47.36	*	-3.90	43.46	*	74.00	54.00	Y/H
4930.00	H	52.93	47.36	3.38	56.31	50.74	74.00	54.00	Y/H
7386.00	H	40.94	*	8.13	49.07	*	74.00	54.00	Y/H
9848.00	H	42.34	29.45	10.13	52.47	39.58	74.00	54.00	Y/H

Remark :

- (1) Spectrum Setting : 30MHz – 1000MHz , RBW= 100KHz, VBW=100KHz, Sweep time = 200 ms. 1GHz- 25GHz, RBW= 1MHz, VBW= 1MHz, Sweep time = 200 ms
- (2) All readings are Peak unless otherwise stated QP in column of 『Note』 . Peak denotes that the Peak reading compliance with the QP Limits and then QP Mode measurement didn't perform ◦
- (3) Measuring frequency range from 30MHz to 1000MHz or the 10th harmonic of highest fundamental frequency ◦ "F" denotes fundamental frequency; "H" denotes spurious frequency. "E" denotes band edge frequency. (This judgment method includes the Band Edge Requirement.)
- (4) Radiated emissions measured in frequency range above 1000MHz were made with an instrument using Peak detector mode and AV detector mode of the emission ◦
- (5) Data of measurement within this frequency range shown " * " in the table above means the reading of emissions are attenuated more than 20dB below the permissible limits or the field strength is too small to be measured.
- (6) A preamp and high pass filter were used for this test in order to provide sufficient measurement sensitivity.
- (7) EUT Orthogonal Axes :
 "X" - denotes Laid on Table ; "Y" - denotes Vertical Stand ; "Z" - denotes Side Stand

Orthogonal Axes : Y
802.11b/CH11(Above 1000 MHz, Horizontal)

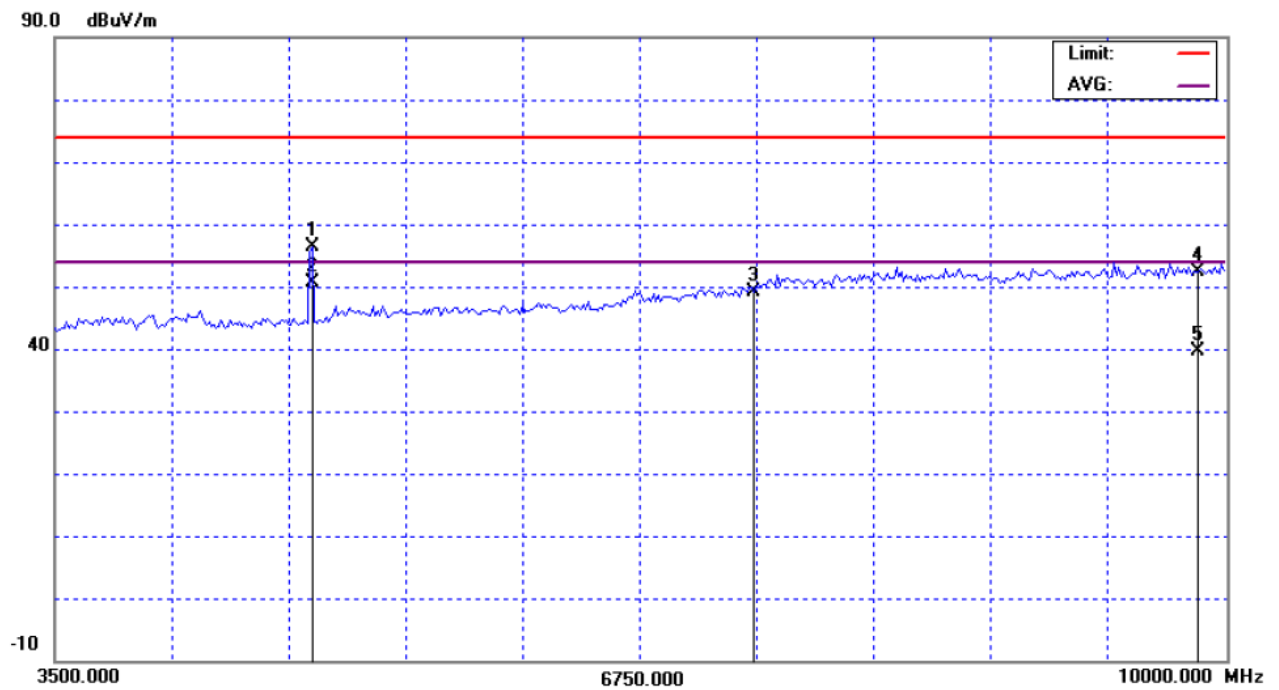
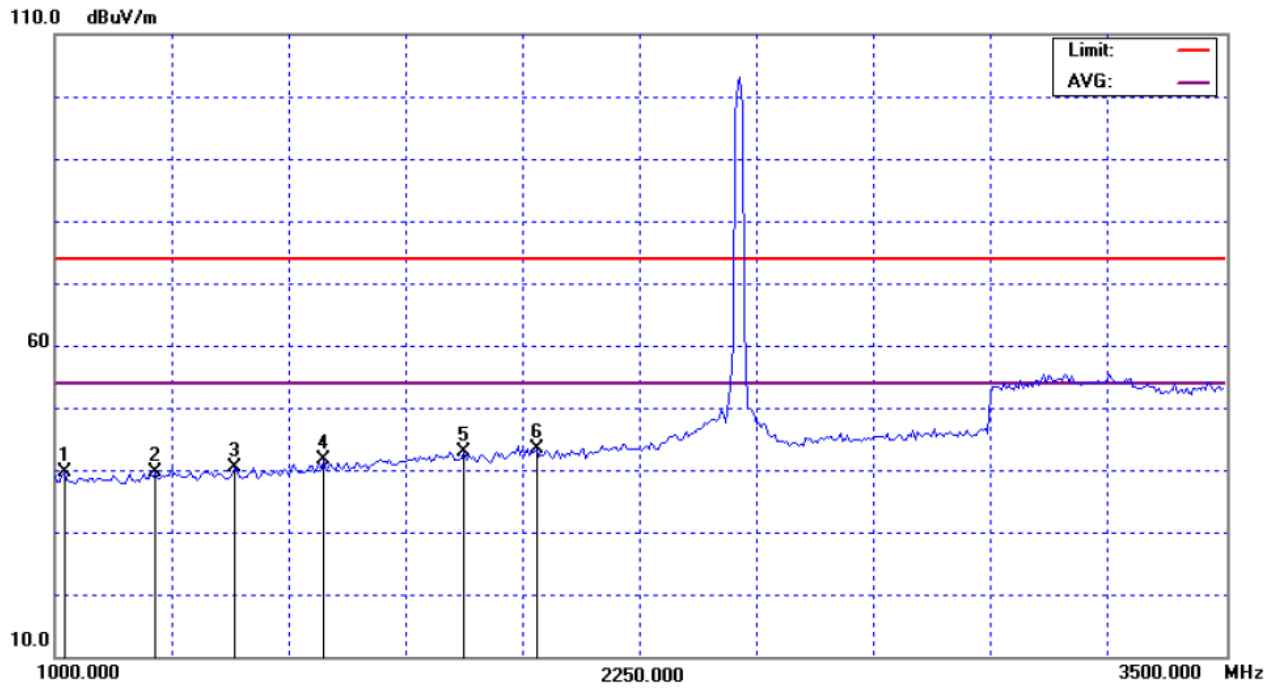

Orthogonal Axes : Y
802.11b/CH11(Above 1000 MHz, Horizontal)

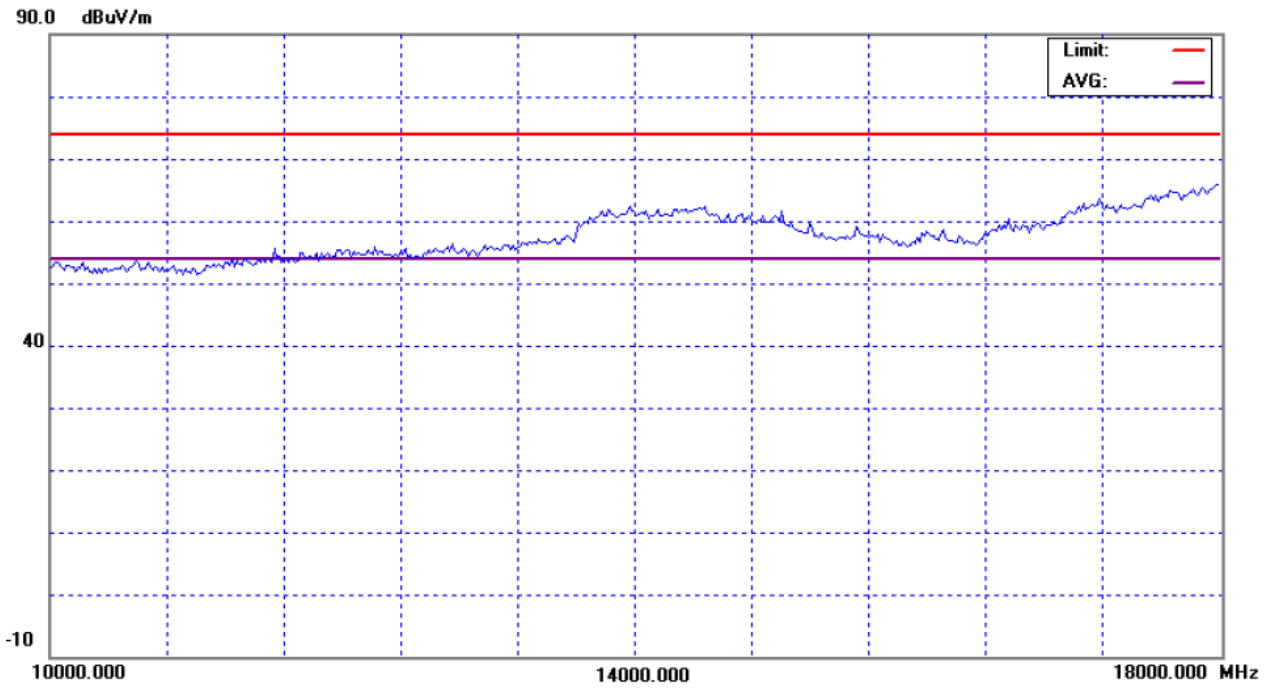

EUT :	Wireless Volp Phone	Model No. :	WLAN 800
Temperature :	25 °C	Relative Humidity :	60 %
Pressure :	1009 hPa	Test Power :	AC 120V/60Hz
Test Mode :	802.11b/CH11		

Freq. (MHz)	Ant.Pol. H/V	Reading		Ant./CF CF(dB)	Act.		Limit		Note
		Peak (dBuV)	AV (dBuV)		Peak (dBuV/m)	AV (dBuV/m)	Peak (dBuV/m)	AV (dBuV/m)	
1000.00	V	48.52	*	-9.04	39.48	*	74.00	54.00	Z/H
1265.00	V	47.95	*	-7.83	40.12	*	74.00	54.00	Z/H
1645.00	V	47.26	*	-5.95	41.31	*	74.00	54.00	Z/H
1770.00	V	48.18	*	-5.26	42.92	*	74.00	54.00	Z/H
2075.00	V	47.66	*	-3.79	43.87	*	74.00	54.00	Z/H
2720.00	V	47.68	*	-1.85	45.83	*	74.00	54.00	Z/H
4930.00	V	48.15	43.25	3.38	51.53	46.63	74.00	54.00	Z/H
7386.00	V	41.48	*	8.13	49.61	*	74.00	54.00	Z/H
9848.00	V	41.88	29.44	10.13	52.01	39.57	74.00	54.00	Z/H

Remark :

- (1) Spectrum Setting : 30MHz – 1000MHz , RBW= 100KHz, VBW=100KHz, Sweep time = 200 ms. 1GHz- 25GHz, RBW= 1MHz, VBW= 1MHz, Sweep time = 200 ms
- (2) All readings are Peak unless otherwise stated QP in column of 『Note』 . Peak denotes that the Peak reading compliance with the QP Limits and then QP Mode measurement didn't perform ◦
- (3) Measuring frequency range from 30MHz to 1000MHz or the 10th harmonic of highest fundamental frequency ◦ "F" denotes fundamental frequency; "H" denotes spurious frequency. "E" denotes band edge frequency. (This judgment method includes the Band Edge Requirement.)
- (4) Radiated emissions measured in frequency range above 1000MHz were made with an instrument using Peak detector mode and AV detector mode of the emission ◦
- (5) Data of measurement within this frequency range shown " * " in the table above means the reading of emissions are attenuated more than 20dB below the permissible limits or the field strength is too small to be measured.
- (6) A preamp and high pass filter were used for this test in order to provide sufficient measurement sensitivity.
- (7) EUT Orthogonal Axes :
"X" - denotes Laid on Table ; "Y" - denotes Vertical Stand ; "Z" - denotes Side Stand