



# FCC TEST REPORT

**REPORT NO.:** RF950508H06

**MODEL NO.:** SW1001-WgN1, SW2001-WgN1, SW5001-WgN1

**RECEIVED:** May 09, 2006

**TESTED:** May 26 to 30, 2006

**ISSUED:** June 05, 2006

**APPLICANT:** ATOP TECHNOLOGIES, INC.

**ADDRESS:** 2F, No.146, Sec 1, Tung-Hsing Rd., Jubei City,  
Hsinchu 302, Taiwan, R.O.C.

**ISSUED BY:** Advance Data Technology Corporation

**LAB LOCATION:** No. 81-1, Lu Liao Keng, 9 Ling, Wu Lung Tsuen,  
Chiung Lin Hsiang, Hsin Chu Hsien,  
Taiwan, R.O.C.

This test report consists of 72 pages in total. It may be duplicated completely for legal use with the approval of the applicant. It should not be reproduced except in full, without the written approval of our laboratory. The client should not use it to claim product endorsement by CNLA, A2LA or any government agencies. The test results in the report only apply to the tested sample. The test results in this report are traceable to the national or international standards.





## Table of Contents

1	CERTIFICATION.....	4
2	SUMMARY OF TEST RESULTS.....	5
3	GENERAL INFORMATION .....	6
3.1	GENERAL DESCRIPTION OF EUT.....	6
3.2	DESCRIPTION OF TEST MODES.....	7
3.3	TEST MODE APPLICABILITY AND TESTED CHANNEL DETAIL:.....	8
3.4	GENERAL DESCRIPTION OF APPLIED STANDARDS .....	10
3.5	DESCRIPTION OF SUPPORT UNITS.....	11
3.6	CONFIGURATION OF SYSTEM UNDER TEST .....	12
4	TEST TYPES AND RESULTS.....	14
4.1	CONDUCTED EMISSION MEASUREMENT .....	14
4.1.1	LIMITS OF CONDUCTED EMISSION MEASUREMENT .....	14
4.1.2	TEST INSTRUMENTS .....	14
4.1.3	TEST PROCEDURES.....	15
4.1.4	TEST SETUP .....	15
4.1.5	EUT OPERATING CONDITIONS.....	16
4.1.6	TEST RESULTS.....	17
4.2	RADIATED EMISSION MEASUREMENT .....	19
4.2.1	LIMITS OF RADIATED EMISSION MEASUREMENT .....	19
4.2.2	TEST INSTRUMENTS .....	20
4.2.3	TEST PROCEDURES.....	21
4.2.4	TEST SETUP.....	22
4.2.5	EUT OPERATING CONDITIONS.....	22
4.2.6	TEST RESULTS.....	23
4.2.7	TEST RESULTS - DSSS.....	26
4.2.8	TEST RESULTS - OFDM .....	33
4.3	6dB BANDWIDTH MEASUREMENT .....	40
4.3.1	LIMITS OF 6dB BANDWIDTH MEASUREMENT .....	40
4.3.2	TEST INSTRUMENTS .....	40
4.3.3	TEST PROCEDURE .....	41
4.3.4	TEST SETUP .....	41
4.3.5	EUT OPERATING CONDITIONS.....	41
4.3.6	TEST RESULTS –DSSS .....	42
4.3.7	TEST RESULTS-OFDM .....	45
4.4	MAXIMUM PEAK OUTPUT POWER .....	48
4.4.1	LIMITS OF MAXIMUM PEAK OUTPUT POWER MEASUREMENT.....	48
4.4.2	TEST INSTRUMENTS .....	48
4.4.3	TEST PROCEDURES.....	49
4.4.4	TEST SETUP.....	49



4.4.5	EUT OPERATING CONDITIONS.....	49
4.4.6	TEST RESULTS – DSSS .....	50
4.4.7	TEST RESULTS –OFDM .....	51
4.5	POWER SPECTRAL DENSITY MEASUREMENT.....	52
4.5.1	LIMITS OF POWER SPECTRAL DENSITY MEASUREMENT .....	52
4.5.2	TEST INSTRUMENTS .....	52
4.5.3	TEST PROCEDURE .....	53
4.5.4	TEST SETUP .....	53
4.5.5	EUT OPERATING CONDITIONS.....	53
4.5.6	TEST RESULTS –DSSS .....	54
4.5.7	TEST RESULTS –OFDM .....	57
4.6	CONDUCTED EMISSION AND BAND EDGES MEASUREMENT .....	60
4.6.1	LIMITS OF condctcted emission and BAND EDGES MEASUREMENT .....	60
4.6.2	TEST INSTRUMENTS .....	60
4.6.3	TEST PROCEDURE .....	60
4.6.4	DEVIATION FROM TEST STANDARD .....	60
4.6.5	EUT OPERATING CONDITION .....	60
4.6.6	TEST RESULTS.....	61
4.7	ANTENNA REQUIREMENT .....	66
4.7.1	STANDARD APPLICABLE .....	66
4.7.2	ANTENNA CONNECTED CONSTRUCTION.....	66
5	PHOTOGRAPHS OF THE TEST CONFIGURATION.....	67
6	INFORMATION ON THE TESTING LABORATORIES .....	71
	APPENDIX-A .....	A-1



## 1 CERTIFICATION

**PRODUCT :** Wireless Serial Server  
**BRAND NAME :** ATOP  
**MODEL NO. :** SW1001-WgN1, SW2001-WgN1, SW5001-WgN1  
**TESTED:** May 26 to 30, 2006  
**APPLICANT :** ATOP TECHNOLOGIES, INC.  
**TEST ITEM:** R&D SAMPLE  
**STANDARDS :** 47 CFR Part 15, Subpart C (Section 15.247)  
ANSI C63.4-2003

The above equipment (Model: SW1001-WgN1, SW2001-WgN1, SW5001-WgN1) has been tested by **Advance Data Technology Corporation**, and found compliance with the requirement of the above standards. The test record, data evaluation & Equipment Under Test (EUT) configurations represented herein are true and accurate accounts of the measurements of the sample's EMC characteristics under the conditions specified in this report.

**PREPARED BY :**  , **DATE:** June 05, 2006  
( Midoli Peng )

**TECHNICAL ACCEPTANCE :**  , **DATE:** June 05, 2006  
Responsible for RF ( Hank Chung )

**APPROVED BY :**  , **DATE:** June 05, 2006  
( May Chen, Deputy Manager )

## 2 SUMMARY OF TEST RESULTS

The EUT has been tested according to the following specifications:

<b>APPLIED STANDARD: 47 CFR Part 15, Subpart C</b>			
<b>Standard Section</b>	<b>Test Type and Limit</b>	<b>Result</b>	<b>REMARK</b>
15.207	AC Power Conducted Emission	PASS	Meet the requirement of limit Minimum passing margin is -18.31 dB at 17.695 MHz
15.247(a)(2)	Spectrum Bandwidth of a Direct Sequence Spread Spectrum System Limit: min. 500kHz	PASS	Meet the requirement of limit
15.247(b)	Maximum Peak Output Power Limit: max. 30dBm	PASS	Meet the requirement of limit
15.247(c)	Transmitter Radiated Emissions Limit: Table 15.209	PASS	Meet the requirement of limit Minimum passing margin is -1.0 dB at 4874.00 MHz
15.247(d)	Power Spectral Density Limit: max. 8dBm	PASS	Meet the requirement of limit
15.247(c)	Band Edge Measurement Limit: 20 dB less than the peak value of fundamental frequency	PASS	Meet the requirement of limit



### 3 GENERAL INFORMATION

#### 3.1 GENERAL DESCRIPTION OF EUT

<b>PRODUCT</b>	Wireless Serial Server
<b>MODEL NO.</b>	SW1001-WgN1, SW2001-WgN1, SW5001-WgN1
<b>FCC ID</b>	RPV-SW2001-WgN1
<b>POWER SUPPLY</b>	DC 22-27V from power adapter
<b>MODULATION TYPE</b>	CCK, DQPSK, DBPSK for DSSS 64QAM, 16QAM, QPSK, BPSK for OFDM
<b>RADIO TECHNOLOGY</b>	DSSS, OFDM
<b>TRANSFER RATE</b>	802.11b: 11/5.5/2/1Mbps 802.11g: 54/48/36/24/18/12/9/6Mbps
<b>FREQUENCY RANGE</b>	2412MHz ~ 2462MHz
<b>NUMBER OF CHANNEL</b>	11
<b>CHANNEL SPACING</b>	5MHz
<b>OUTPUT POWER</b>	802.11b: 41.687mW 802.11g: 177.828mW
<b>ANTENNA TYPE</b>	Dipole Antenna
<b>DATA CABLE</b>	8P MinDin cable(0.15m) RJ-45 cable (unshielded, 1.8m)
<b>I/O PORT</b>	LAN Port x 1 RS-232 Port x 1 ComPorts(RS232/485/422) x 1
<b>ASSOCIATED DEVICES</b>	NA

#### NOTE:

1. The EUT have three models which are identical to each other in all aspects except for the followings:

Model	Difference
SW1001-WgN1	without enclosure
SW2001-WgN1	with plastic enclosure
SW5001-WgN1	with iron enclosure

Above samples were pre-tested in chamber, Model: SW1001-WgN1, worst case one, was chosen for final test and its data was recorded in this report. <Except for Conducted Emission Test and Radiated Emission Test (Below 1GHz)>

- ◆ The FCC ID: RPV-SW2001-WgN1 of this application, is only applied for Model: SW1001-WgN1 & Model: SW2001-WgN1.

2. The EUT must be supplied with a power adapter and as following: <Only for test not for sale>

Brand:	DEER
Model No.:	AD1524C
Input power :	AC100-240V, 0.5A,
Output power :	DC22-27V, 0.6A, 15Wmax DC Output Cable: 1.8m/nonshielded/without core

3. The power input of EUT is DC type so no conducted emission test was executed.
4. The EUT operates in the 2.4GHz frequency spectrum with throughput of up to 54Mbps.
5. The EUT complies with IEEE 802.11g standards, and backwards compatible with IEEE 802.11b products.
6. The above EUT information was declared by the manufacturer and for more detailed features description, please refer to the manufacturer's specifications or User's Manual.

### 3.2 DESCRIPTION OF TEST MODES

Operated in 2400 ~ 2483.5MHz band:

For 802.11b/g normal mode: Eleven channels are provided to this EUT.

Channel	Frequency	Channel	Frequency
1	2412 MHz	7	2442 MHz
2	2417 MHz	8	2447 MHz
3	2422 MHz	9	2452 MHz
4	2427 MHz	10	2457 MHz
5	2432 MHz	11	2462 MHz
6	2437 MHz		

For Conducted Emission test, the EUT was tested as the following test mode:

Test Mode	Model
Mode 1	SW2001-WgN1

For Radiated Emission test (30MHz ~ 1GHz), the EUT was tested as the following test modes:

Test Mode	Model
Mode 1	SW1001-WgN1
Mode 2	SW2001-WgN1
Mode 3	SW5001-WgN1

### 3.3 TEST MODE APPLICABILITY AND TESTED CHANNEL DETAIL:

EUT configure mode	Applicable to				Description
	PLC	RE<1G	RE≥1G	APCM	
-	√	√	√	√	NA

Where PLC: Power Line Conducted Emission RE<1G RE: Radiated Emission below 1GHz  
 RE≥1G: Radiated Emission above 1GHz APCM: Antenna Port Conducted Measurement

#### **Power Line Conducted Emission Test:**

- Pre-Scan has been conducted to determine the worst-case mode from all possible combinations between available modulations, data rates and antenna ports (if EUT with antenna diversity architecture).
- Following channel(s) was (were) selected for the final test as listed below.

Mode	Available Channel	Tested Channel	Modulation Technology	Modulation Type	Data Rate (Mbps)
802.11b	1 to 11	11	DSSS	CCK	6

#### **Radiated Emission Test (Below 1 GHz):**

- Pre-Scan has been conducted to determine the worst-case mode from all possible combinations between available modulations, data rates and antenna ports (if EUT with antenna diversity architecture).
- Following channel(s) was (were) selected for the final test as listed below.

Mode	Available Channel	Tested Channel	Modulation Technology	Modulation Type	Data Rate (Mbps)
802.11b	1 to 11	11	DSSS	CCK	11

#### **Radiated Emission Test (Above 1 GHz):**

- Pre-Scan has been conducted to determine the worst-case mode from all possible combinations between available modulations, data rates and antenna ports (if EUT with antenna diversity architecture).
- Following channel(s) was (were) selected for the final test as listed below.

Mode	Available Channel	Tested Channel	Modulation Technology	Modulation Type	Data Rate (Mbps)
802.11b	1 to 11	1, 6, 11	DSSS	CCK	11
802.11g	1 to 11	1, 6, 11	OFDM	BPSK	6



**Bandedge Measurement:**

- Pre-Scan has been conducted to determine the worst-case mode from all possible combinations between available modulations, data rates and antenna ports (if EUT with antenna diversity architecture).
- Following channel(s) was (were) selected for the final test as listed below.

Mode	Available Channel	Tested Channel	Modulation Technology	Modulation Type	Data Rate (Mbps)
802.11b	1 to 11	1, 11	DSSS	CCK	11
802.11g	1 to 11	1, 11	OFDM	BPSK	6

**Antenna Port Conducted Measurement:**

- Pre-Scan has been conducted to determine the worst-case mode from all possible combinations between available modulations, data rates and antenna ports (if EUT with antenna diversity architecture).
- Following channel(s) was (were) selected for the final test as listed below.

Mode	Available Channel	Tested Channel	Modulation Technology	Modulation Type	Data Rate (Mbps)
802.11b	1 to 11	1, 6, 11	DSSS	CCK	11
802.11g	1 to 11	1, 6, 11	OFDM	BPSK	6



### **3.4 GENERAL DESCRIPTION OF APPLIED STANDARDS**

The EUT is a Wireless Serial Server. According to the specifications of the manufacturer, it must comply with the requirements of the following standards:

**47 CFR Part 15, Subpart C. (15.247)**  
**ANSI C63.4 : 2003**

All tests have been performed and recorded as per the above standards.



### 3.5 DESCRIPTION OF SUPPORT UNITS

The EUT has been tested as an independent unit together with other necessary accessories or support units. The following support units or accessories were used to form a representative test configuration during the tests.

For Conduction test					
NO.	PRODUCT	BRAND	MODEL NO.	SERIAL NO.	FCC ID
1	Notebook Computer	Dell	PP01L	TW-09c748-12800-165-3171	DoC
2	DC POWER SUPPLY	GOOD WILL INSTRUMENT CO., LTD.	GPC-3030D	7700087	NA

NO.	SIGNAL CABLE DESCRIPTION OF THE ABOVE SUPPORT UNITS
1	NA
2	NA

**NOTE:** All power cords of the above support units are non-shielded (1.8m).

For Radiation test					
NO.	PRODUCT	BRAND	MODEL NO.	SERIAL NO.	FCC ID
1	Notebook Computer	Dell	PP01L	TW-0791UH-12800-0CK-3735	DoC

NO.	SIGNAL CABLE DESCRIPTION OF THE ABOVE SUPPORT UNITS
1	NA

**NOTE:** All power cords of the above support units are non-shielded (1.8m).

### 3.6 CONFIGURATION OF SYSTEM UNDER TEST

For Conduction test

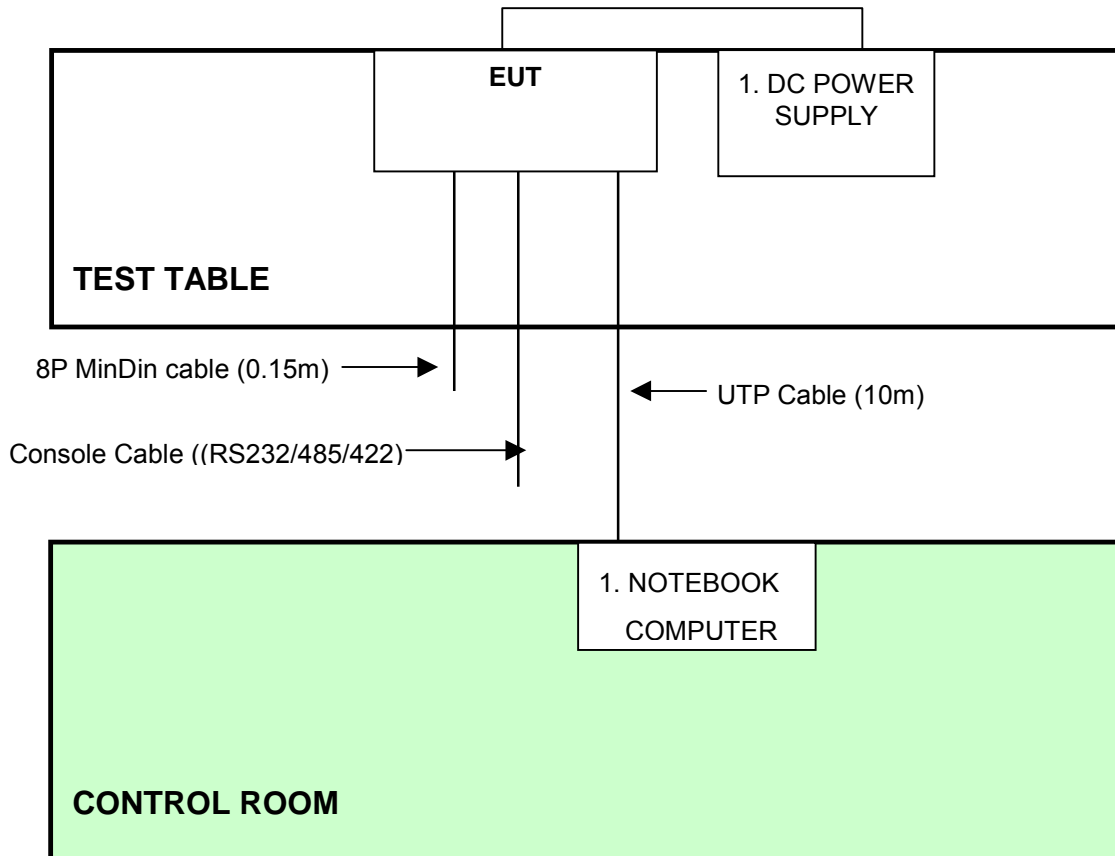

- NOTE:**
1. Support units 1 was kept in the control room during the test.
  2. Please refer to the photos of test configuration in Item 5 also.

**For Radiation test**

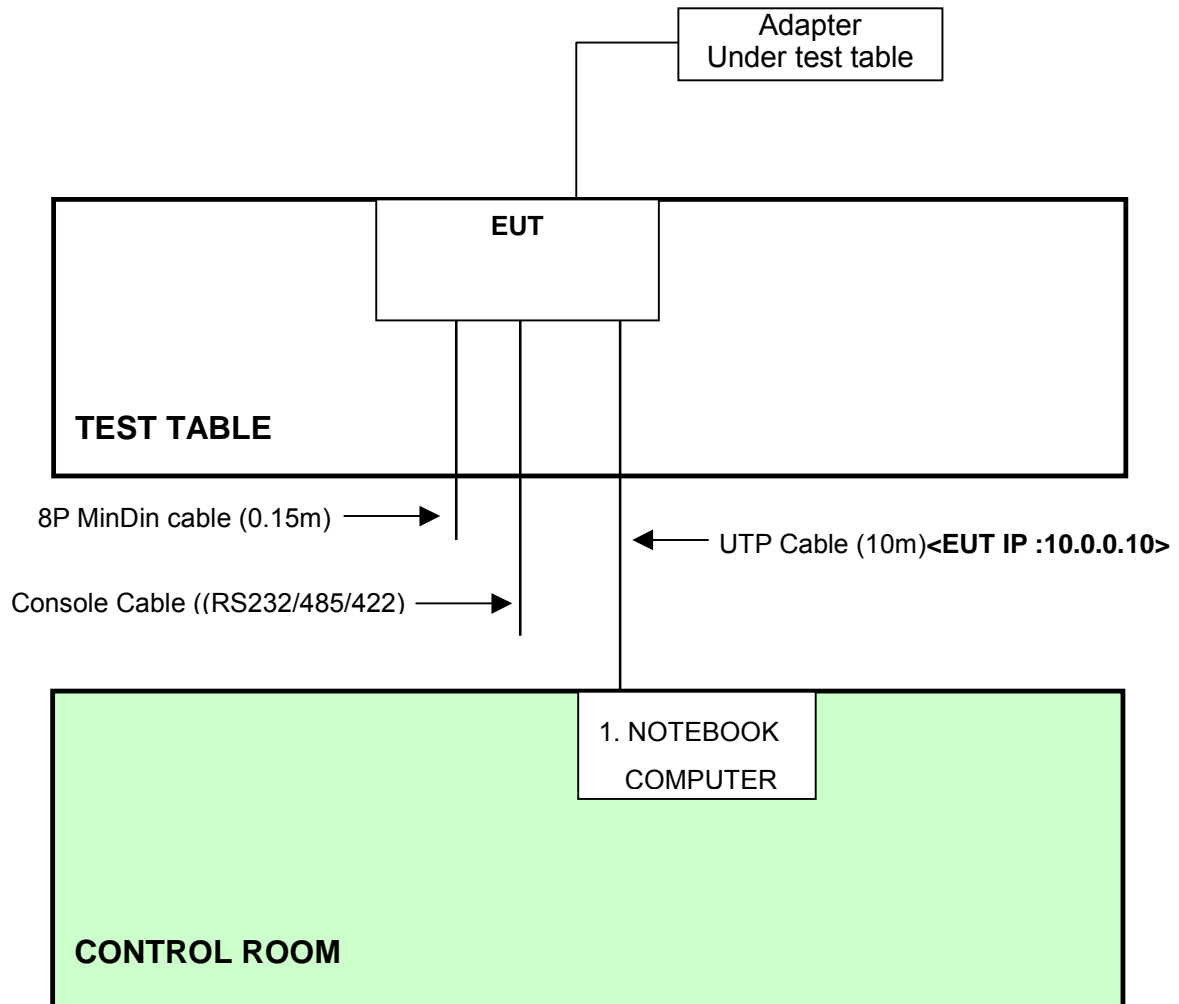

- NOTE:**
1. Support units 1 was kept in the control room during the test.
  2. Please refer to the photos of test configuration in Item 5 also.



## 4 TEST TYPES AND RESULTS

### 4.1 CONDUCTED EMISSION MEASUREMENT

#### 4.1.1 LIMITS OF CONDUCTED EMISSION MEASUREMENT

FREQUENCY OF EMISSION (MHz)	CONDUCTED LIMIT (dB $\mu$ V)	
	Quasi-peak	Average
0.15-0.5	66 to 56	56 to 46
0.5-5	56	46
5-30	60	50

**NOTE:**

1. The lower limit shall apply at the transition frequencies.
2. All emanations from a class B digital device or system, including any network of conductors and apparatus connected thereto, shall not exceed the level of field strengths specified above.

#### 4.1.2 TEST INSTRUMENTS

DESCRIPTION & MANUFACTURER	MODEL NO.	SERIAL NO.	CALIBRATED UNTIL
Test Receiver	ESCS 30	847124/029	Dec. 15, 2006
Line-Impedance Stabilization Network(for EUT)	ENV-216	100071	Nov. 10, 2006
Line-Impedance Stabilization Network(for Peripheral)	KNW-407	8/1395/12	Jul. 19, 2006
RF Cable (JETBAO)	RG233/U	Cable_CB_01	Dec. 09, 2006
Terminator	50	2	Oct. 08, 2006
Software	ADT_Cond_V7.3.2	NA	NA

- NOTE: 1. The calibration interval of the above test instruments is 12 months and the calibrations are traceable to NML/ROC and NIST/USA.  
2. The test was performed in ADT Shielded Room No. B.  
3. The VCCI Con B Registration No. is C-2193.

#### 4.1.3 TEST PROCEDURES

- a. The EUT/HOST was placed 0.4 meters from the conducting wall of the shielded room with EUT/HOST being connected to the power mains through a line impedance stabilization network (LISN). Other support units were connected to the power mains through another LISN. The two LISNs provide 50 ohm/ 50uH of coupling impedance for the measuring instrument.
- b. Both lines of the power mains connected to the EUT/HOST were checked for maximum conducted interference.
- c. The frequency range from 150 kHz to 30 MHz was searched. Emission levels over 10dB under the prescribed limits could not be reported

#### 4.1.4 TEST SETUP

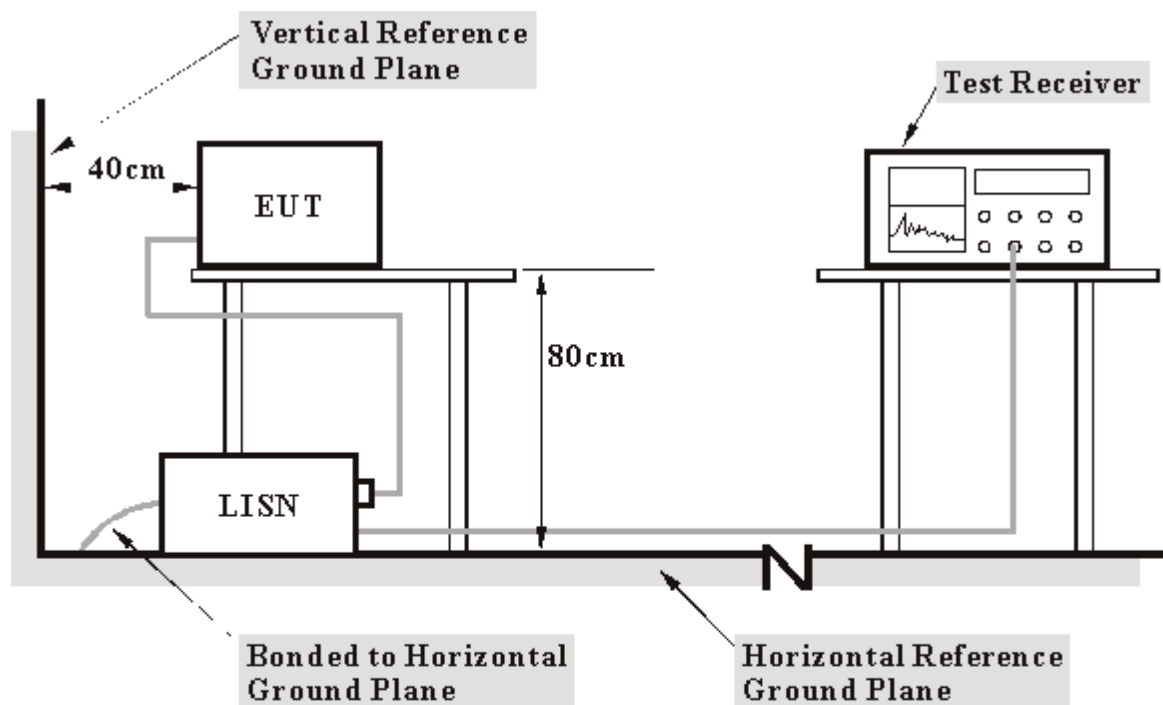

- Note:**
1. Support units were connected to second LISN.
  2. Both of LISNs (AMN) 80 cm from EUT and at the least 80 cm from other units and other metal planes support units.

For the actual test configuration, please refer to the related item – Photographs of the Test Configuration.

#### 4.1.5 EUT OPERATING CONDITIONS

- a. Placed the EUT on the testing table.
- b. Prepared other computer systems (support unit 1) to act as communication partners and placed them outside of testing area.
- c. The communication partner run the test program "HyperTerminal 115200 " to enable EUT under transmission/receiving condition continuously via one UTP cable and wireless transmission.



#### 4.1.6 TEST RESULTS

<b>MODULATION TYPE</b>	DSSS	<b>CHANNEL</b>	Channel 1
<b>INPUT POWER (SYSTEM)</b>	120Vac, 60 Hz	<b>6dB BANDWIDTH</b>	9 kHz
<b>PHASE</b>	Line (L)	<b>TRANSFER RATE</b>	1Mbps
<b>ENVIRONMENTAL CONDITIONS</b>	27deg. C, 59%RH, 972hPa	<b>TESTED BY</b>	Tony Chen

No	Freq. [MHz]	Corr. Factor (dB)	Reading Value		Emission Level		Limit		Margin	
			[dB (uV)]		[dB (uV)]		[dB (uV)]		(dB)	
			Q.P.	AV.	Q.P.	AV.	Q.P.	AV.	Q.P.	AV.
1	0.150	9.60	22.35	-	31.95	-	66.00	56.00	-34.05	-
2	0.548	9.60	20.67	-	30.27	-	56.00	46.00	-25.73	-
3	2.763	9.70	14.47	-	24.17	-	56.00	46.00	-31.83	-
4	2.944	9.70	17.12	-	26.82	-	56.00	46.00	-29.18	-
5	16.230	10.10	31.28	-	41.38	-	60.00	50.00	-18.62	-
6	17.695	10.10	31.59	-	41.69	-	60.00	50.00	-18.31	-

- REMARKS:**
1. Q.P. and AV. are abbreviations of quasi-peak and average individually.
  2. "-": The Quasi-peak reading value also meets average limit and measurement with the average detector is unnecessary.
  3. The emission levels of other frequencies were very low against the limit.
  4. Margin value = Emission level - Limit value
  5. Correction factor = Insertion loss + Cable loss
  6. Emission Level = Correction Factor + Reading Value.

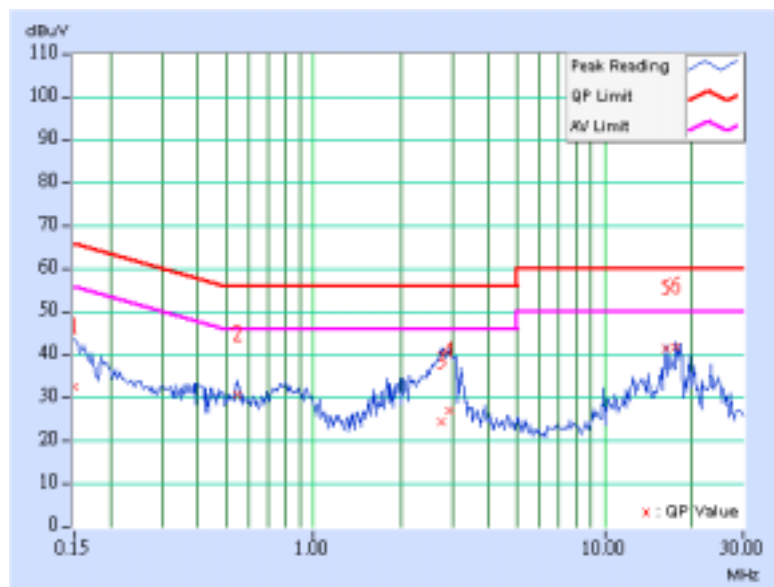

<b>MODULATION TYPE</b>	DSSS	<b>CHANNEL</b>	Channel 1
<b>INPUT POWER (SYSTEM)</b>	120Vac, 60 Hz	<b>6dB BANDWIDTH</b>	9 kHz
<b>PHASE</b>	Neutral (N)	<b>TRANSFER RATE</b>	1Mbps
<b>ENVIRONMENTAL CONDITIONS</b>	27deg. C, 59%RH, 972hPa	<b>TESTED BY</b>	Tony Chen

No	Freq. [MHz]	Corr. Factor (dB)	Reading Value		Emission Level		Limit		Margin	
			[dB (uV)]		[dB (uV)]		[dB (uV)]		(dB)	
			Q.P.	AV.	Q.P.	AV.	Q.P.	AV.	Q.P.	AV.
1	0.166	9.60	22.11	-	31.71	-	65.18	55.18	-33.47	-
2	0.798	9.60	16.74	-	26.34	-	56.00	46.00	-29.66	-
3	2.142	9.70	23.64	-	33.34	-	56.00	46.00	-22.66	-
4	16.230	10.02	31.13	-	41.15	-	60.00	50.00	-18.85	-
5	17.695	10.05	31.35	-	41.40	-	60.00	50.00	-18.60	-
6	23.129	10.10	27.18	-	37.28	-	60.00	50.00	-22.72	-

- REMARKS:**
1. Q.P. and AV. are abbreviations of quasi-peak and average individually.
  2. "-": The Quasi-peak reading value also meets average limit and measurement with the average detector is unnecessary.
  3. The emission levels of other frequencies were very low against the limit.
  4. Margin value = Emission level - Limit value
  5. Correction factor = Insertion loss + Cable loss
  6. Emission Level = Correction Factor + Reading Value.

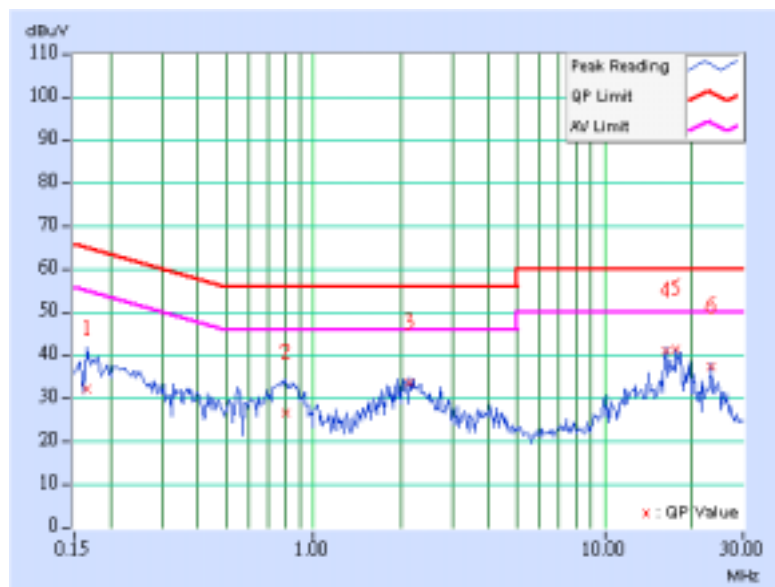



## 4.2 RADIATED EMISSION MEASUREMENT

### 4.2.1 LIMITS OF RADIATED EMISSION MEASUREMENT

Emissions radiated outside of the specified bands, shall be according to the general radiated limits in 15.209 as following:

Frequencies (MHz)	Field strength (microvolts/meter)	Measurement distance (meters)
0.009-0.490	2400/F(kHz)	300
0.490-1.705	24000/F(kHz)	30
1.705-30.0	30	30
30-88	100	3
88-216	150	3
216-960	200	3
Above 960	500	3

**NOTE:**

1. The lower limit shall apply at the transition frequencies.
2. Emission level (dBuV/m) = 20 log Emission level (uV/m).
3. As shown in 15.35(b), for frequencies above 1000MHz, the field strength limits are based on average detector, however, the peak field strength of any emission shall not exceed the maximum permitted average limits, specified above by more than 20dB under any condition of modulation.



## 4.2.2 TEST INSTRUMENTS

DESCRIPTION & MANUFACTURER	MODEL NO.	SERIAL NO.	CALIBRATED UNTIL
ADVANTEST Spectrum Analyzer	R3271A	85060311	July 07, 2006
HP Pre_Amplifier	8449B	3008A01922	Oct. 02, 2006
ROHDE & SCHWARZ Test Receiver	ESCS30	100287	Dec. 08, 2006
CHASE Broadband Antenna	VULB9168	138	Dec. 21, 2006
Schwarzbeck Horn_Antenna	BBHA9120	D124	Dec. 11, 2006
Schwarzbeck Horn_Antenna	BBHA 9170	BBHA9170153	Jan. 05, 2007
SCHWARZBECK Biconical Antenna	VHBA9123	459	Jun. 26, 2006
SCHWARZBECK Periodic Antenna	UPA6108	1148	Jun. 26, 2006
RF Switches (ARNITSU)	CS-201	1565157	NA
RF CABLE (Chaintek) 1GHz-20GHz	SF102	22054-2	Nov. 16. 2006
RF Cable(RICHTEC)	9913-30M	STCCAB-30M- 1GHz-021	Jul. 16, 2006
Software	ADT_Radiated_V 5.14	NA	NA
CHANCE MOST Antenna Tower	AT-100	0203	NA
CHANCE MOST Turn Table	TT-100	0203	NA

Note: 1. The calibration interval of the above test instruments is 12 months (36 months for Periodic Antenna) and the calibrations are traceable to NML/ROC and NIST/USA.

2. The horn antenna and HP preamplifier (model: 8449B) are used only for the measurement of emission frequency above 1GHz if tested.
3. The test was performed in ADT Open Site No. C.
4. The FCC Site Registration No. is 656396.
5. The VCCI Site Registration No. is R-1626.
6. The CANADA Site Registration No. is IC 4824-3.
7. The following table is for the measurement uncertainty, which is calculated as per the document CISPR 16-4. This uncertainty represents an expanded uncertainty expressed at approximately the 95% confidence level using a coverage factor of k=2.

Measurement	Value
Radiated emissions (30MHz-1GHz)	2.98 dB
Radiated emissions (1GHz ~18GHz)	2.21 dB
Radiated emissions (18GHz ~20GHz)	1.88 dB

#### 4.2.3 TEST PROCEDURES

- a. The EUT was placed on the top of a rotating table 0.8 meters above the ground at a 10 meter open area test site. The table was rotated 360 degrees to determine the position of the highest radiation.
- b. The EUT was set 3 meters away from the interference-receiving antenna, which was mounted on the top of a variable-height antenna tower.
- c. The antenna is a broadband antenna, and its height is varied from one meter to four meters above the ground to determine the maximum value of the field strength. Both horizontal and vertical polarizations of the antenna are set to make the measurement.
- d. For each suspected emission, the EUT was arranged to its worst case and then the antenna was tuned to heights from 1 meter to 4 meters and the rotatable table was turned from 0 degrees to 360 degrees to find the maximum reading.
- e. The test-receiver system was set to Peak Detect Function and Specified Bandwidth with Maximum Hold Mode.
- f. If the emission level of the EUT in peak mode was 10 dB lower than the limit specified, then testing could be stopped and the peak values of the EUT would be reported. Otherwise the emissions that did not have 10 dB margin would be re-tested one by one using peak, quasi-peak or average method as specified and then reported in a data sheet.

**NOTE:**

1. The resolution bandwidth and video bandwidth of test receiver/spectrum analyzer is 120kHz for Peak detection (PK) and Quasi-peak detection (QP) at frequency below 1GHz.
2. The resolution bandwidth and video bandwidth of test receiver/spectrum analyzer is 1 MHz for Peak detection at frequency above 1GHz.
3. The resolution bandwidth of test receiver/spectrum analyzer is 1 MHz and the video bandwidth is 10 Hz for Average detection (AV) at frequency above 1GHz.

#### 4.2.4 TEST SETUP

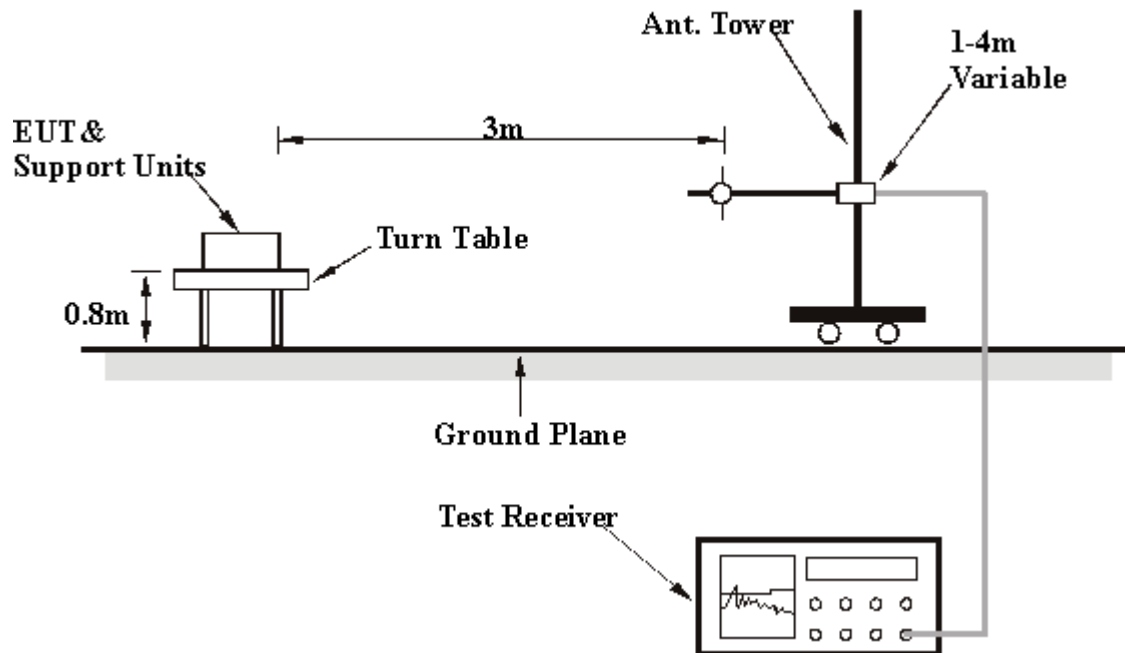

For the actual test configuration, please refer to the related item – Photographs of the Test Configuration.

#### 4.2.5 EUT OPERATING CONDITIONS

Same as 4.1.5



#### 4.2.6 TEST RESULTS

##### Below 1GHz Worst-Case Data

<b>TEST MODE</b>	Mode 1		
<b>MODULATION TYPE</b>	DSSS	<b>CHANNEL</b>	Channel 11
<b>INPUT POWER (SYSTEM)</b>	120Vac, 60 Hz	<b>FREQUENCY RANGE</b>	30-1000 MHz
<b>ENVIRONMENTAL CONDITIONS</b>	27deg. C, 60%RH, 972hPa	<b>TRANSFER RATE</b>	11Mbps
<b>TESTED BY</b>	Tony Chen	<b>DETECTOR FUNCTION</b>	Quasi-Peak, 120kHz

ANTENNA POLARITY & TEST DISTANCE: HORIZONTAL AT 3 M								
No.	Freq. (MHz)	Emission Level (dBuV/m)	Limit (dBuV/m)	Margin (dB)	Antenna Height (m)	Table Angle (Degree)	Raw Value (dBuV)	Correction Factor (dB/m)
1	225.00	41.10 QP	46.00	-4.90	1.39 H	3	28.40	12.70
2	374.99	37.30 QP	46.00	-8.70	1.00 H	199	19.10	18.20
3	450.02	25.70 QP	46.00	-20.30	1.66 H	1	5.20	20.50
4	525.00	30.50 QP	46.00	-15.50	1.34 H	21	8.00	22.50
5	600.04	28.50 QP	46.00	-17.50	1.22 H	284	4.00	24.50
6	674.99	31.60 QP	46.00	-14.40	1.23 H	195	6.10	25.40
7	724.99	31.70 QP	46.00	-14.30	1.31 H	43	5.10	26.60
8	824.99	34.10 QP	46.00	-11.90	1.33 H	159	6.10	28.00
9	974.99	32.30 QP	54.00	-21.70	1.24 H	41	2.40	29.90

ANTENNA POLARITY & TEST DISTANCE: VERTICAL AT 3 M								
No.	Freq. (MHz)	Emission Level (dBuV/m)	Limit (dBuV/m)	Margin (dB)	Antenna Height (m)	Table Angle (Degree)	Raw Value (dBuV)	Correction Factor (dB/m)
1	225.00	31.70 QP	46.00	-14.30	1.00 V	318	19.00	12.70
2	375.00	34.60 QP	46.00	-11.40	1.00 V	292	16.40	18.20
3	450.00	31.50 QP	46.00	-14.50	1.14 V	349	11.00	20.50
4	525.00	35.70 QP	46.00	-10.30	1.00 V	18	13.30	22.50
5	600.00	31.20 QP	46.00	-14.80	1.00 V	201	6.80	24.50
6	675.00	30.60 QP	46.00	-15.40	1.00 V	115	5.20	25.40
7	824.99	33.30 QP	46.00	-12.70	1.00 V	1	5.30	28.00
8	974.99	33.80 QP	54.00	-20.20	1.00 V	21	3.90	29.90

- REMARKS:**
1. Emission level(dBuV/m)=Raw Value(dBuV) + Correction Factor(dB/m)
  2. Correction Factor(dB/m) = Antenna Factor (dB/m) + Cable Factor (dB)
  3. The other emission levels were very low against the limit.
  4. Margin value = Emission level – Limit value.



<b>TEST MODE</b>	Mode 2		
<b>MODULATION TYPE</b>	DSSS	<b>CHANNEL</b>	Channel 11
<b>INPUT POWER (SYSTEM)</b>	120Vac, 60 Hz	<b>FREQUENCY RANGE</b>	30-1000 MHz
<b>ENVIRONMENTAL CONDITIONS</b>	27deg. C, 60%RH, 972hPa	<b>TRANSFER RATE</b>	11Mbps
<b>TESTED BY</b>	Tony Chen	<b>DETECTOR FUNCTION</b>	Quasi-Peak, 120kHz

<b>ANTENNA POLARITY &amp; TEST DISTANCE: HORIZONTAL AT 3 M</b>								
No.	Freq. (MHz)	Emission Level (dBuV/m)	Limit (dBuV/m)	Margin (dB)	Antenna Height (m)	Table Angle (Degree)	Raw Value (dBuV)	Correction Factor (dB/m)
1	225.00	41.00 QP	46.00	-5.00	1.35 H	16	28.30	12.70
2	375.00	37.20 QP	46.00	-8.80	1.00 H	225	19.00	18.20
3	450.01	25.90 QP	46.00	-20.10	1.31 H	42	5.40	20.50
4	525.00	30.80 QP	46.00	-15.20	1.42 H	42	8.30	22.50
5	600.00	29.20 QP	46.00	-16.80	1.18 H	242	4.70	24.50
6	675.00	32.00 QP	46.00	-14.00	1.35 H	172	6.60	25.40
7	725.00	31.50 QP	46.00	-14.50	1.34 H	28	4.90	26.60
8	825.00	34.60 QP	46.00	-11.40	1.36 H	142	6.60	28.00
9	975.00	32.40 QP	54.00	-21.60	1.22 H	18	2.50	29.90

<b>ANTENNA POLARITY &amp; TEST DISTANCE: VERTICAL AT 3 M</b>								
No.	Freq. (MHz)	Emission Level (dBuV/m)	Limit (dBuV/m)	Margin (dB)	Antenna Height (m)	Table Angle (Degree)	Raw Value (dBuV)	Correction Factor (dB/m)
1	225.00	31.90 QP	46.00	-14.10	1.00 V	320	19.20	12.70
2	375.00	34.40 QP	46.00	-11.60	1.00 V	285	16.20	18.20
3	450.00	31.60 QP	46.00	-14.40	1.00 V	2	11.10	20.50
4	525.00	35.50 QP	46.00	-10.50	1.00 V	22	13.00	22.50
5	600.00	32.50 QP	46.00	-13.50	1.00 V	185	8.00	24.50
6	675.00	30.40 QP	46.00	-15.60	1.00 V	112	5.00	25.40
7	825.00	33.90 QP	46.00	-12.10	1.00 V	6	5.90	28.00
8	975.00	34.20 QP	54.00	-19.80	1.00 V	26	4.30	29.90

- REMARKS:**
1. Emission level(dBuV/m)=Raw Value(dBuV) + Correction Factor(dB/m)
  2. Correction Factor(dB/m) = Antenna Factor (dB/m) + Cable Factor (dB)
  3. The other emission levels were very low against the limit.
  4. Margin value = Emission level – Limit value.





<b>TEST MODE</b>	Mode 3		
<b>MODULATION TYPE</b>	DSSS	<b>CHANNEL</b>	Channel 11
<b>INPUT POWER (SYSTEM)</b>	120Vac, 60 Hz	<b>FREQUENCY RANGE</b>	30-1000 MHz
<b>ENVIRONMENTAL CONDITIONS</b>	27deg. C, 60%RH, 972hPa	<b>TRANSFER RATE</b>	11Mbps
<b>TESTED BY</b>	Tony Chen	<b>DETECTOR FUNCTION</b>	Quasi-Peak, 120kHz

### ANTENNA POLARITY & TEST DISTANCE: HORIZONTAL AT 3 M

No.	Freq. (MHz)	Emission Level (dBuV/m)	Limit (dBuV/m)	Margin (dB)	Antenna Height (m)	Table Angle (Degree)	Raw Value (dBuV)	Correction Factor (dB/m)
1	225.01	26.10 QP	46.00	-19.90	1.45 H	351	13.40	12.70
2	375.02	24.10 QP	46.00	-21.90	1.00 H	16	5.90	18.20
3	450.03	27.90 QP	46.00	-18.10	1.00 H	184	7.40	20.50
4	525.00	33.20 QP	46.00	-12.80	1.21 H	311	10.70	22.50
5	600.05	30.00 QP	46.00	-16.00	1.15 H	21	5.50	24.50
6	675.00	30.90 QP	46.00	-15.10	1.29 H	220	5.50	25.40
7	724.99	30.50 QP	46.00	-15.50	1.33 H	350	3.90	26.60
8	825.05	30.20 QP	46.00	-15.80	1.01 H	307	2.20	28.00
9	975.02	28.70 QP	54.00	-25.30	1.12 H	95	-1.20	29.90

### ANTENNA POLARITY & TEST DISTANCE: VERTICAL AT 3 M

No.	Freq. (MHz)	Emission Level (dBuV/m)	Limit (dBuV/m)	Margin (dB)	Antenna Height (m)	Table Angle (Degree)	Raw Value (dBuV)	Correction Factor (dB/m)
1	225.00	23.40 QP	46.00	-22.60	1.00 V	254	10.70	12.70
2	375.00	27.80 QP	46.00	-18.20	1.23 V	251	9.60	18.20
3	450.00	28.30 QP	46.00	-17.70	1.00 V	42	7.80	20.50
4	525.00	34.90 QP	46.00	-11.10	1.00 V	12	12.40	22.50
5	600.00	27.50 QP	46.00	-18.50	1.00 V	78	3.00	24.50
6	675.00	32.20 QP	46.00	-13.80	1.00 V	216	6.80	25.40
7	825.00	28.90 QP	46.00	-17.10	1.05 V	307	0.90	28.00
8	975.00	28.90 QP	54.00	-25.10	1.05 V	358	-1.00	29.90

- REMARKS:**
1. Emission level(dBuV/m)=Raw Value(dBuV) + Correction Factor(dB/m)
  2. Correction Factor(dB/m) = Antenna Factor (dB/m) + Cable Factor (dB)
  3. The other emission levels were very low against the limit.
  4. Margin value = Emission level – Limit value.



4.2.7 TEST RESULTS - DSSS  
802.11b DSSS modulation

<b>MODE</b>	Channel 1	<b>FREQUENCY RANGE</b>	1000~25000MHz
<b>INPUT POWER (SYSTEM)</b>	120Vac, 60 Hz	<b>DETECTOR FUNCTION &amp; BANDWIDTH</b>	Peak (PK) Average (AV) 1 MHz
<b>ENVIRONMENTAL CONDITIONS</b>	27 deg. C, 59%RH, 972hPa	<b>TESTED BY</b>	Tony Chen

ANTENNA POLARITY & TEST DISTANCE: HORIZONTAL AT 3 M								
No.	Freq. (MHz)	Emission Level (dBuV/m)	Limit (dBuV/m)	Margin (dB)	Antenna Height (m)	Table Angle (Degree)	Raw Value (dBuV)	Correction Factor (dB/m)
1	2387.00	55.60 PK	74.00	-18.40	1.16 H	149	25.90	29.70
1	2387.00	44.50 AV	54.00	-9.50	1.16 H	149	14.70	29.70
2	*2412.00	98.30 PK			1.25 H	120	68.40	29.90
2	*2412.00	94.30 AV			1.25 H	120	64.40	29.90
3	3216.00	43.70 PK	74.00	-30.30	1.58 H	0	11.80	32.00
3	3216.00	32.70 AV	54.00	-21.30	1.58 H	0	0.70	32.00
4	4824.00	51.20 PK	74.00	-22.80	1.26 H	341	16.20	35.00
4	4824.00	44.30 AV	54.00	-9.70	1.26 H	341	9.30	35.00
5	7236.00	51.40 PK	74.00	-22.60	1.14 H	2	10.30	41.10
5	7236.00	38.90 AV	54.00	-15.10	1.14 H	2	-2.20	41.10

ANTENNA POLARITY & TEST DISTANCE: VERTICAL AT 3 M								
No.	Freq. (MHz)	Emission Level (dBuV/m)	Limit (dBuV/m)	Margin (dB)	Antenna Height (m)	Table Angle (Degree)	Raw Value (dBuV)	Correction Factor (dB/m)
1	2386.00	61.00 PK	74.00	-13.00	1.16 V	149	31.20	29.70
1	2386.00	51.40 AV	54.00	-2.60	1.16 V	149	21.70	29.70
2	*2412.00	107.30 PK			1.20 V	111	77.50	29.90
2	*2412.00	103.40 AV			1.20 V	111	73.50	29.90
3	3216.00	44.70 PK	74.00	-29.30	1.41 V	149	12.70	32.00
3	3216.00	35.70 AV	54.00	-18.30	1.41 V	149	3.80	32.00
4	4824.00	57.00 PK	74.00	-17.00	1.61 V	140	22.00	35.00
4	4824.00	52.40 AV	54.00	-1.60	1.61 V	140	17.30	35.00
5	7236.00	51.70 PK	74.00	-22.30	1.31 V	220	10.50	41.10
5	7236.00	39.10 AV	54.00	-14.90	1.31 V	220	-2.10	41.10

- REMARKS:**
1. Emission level(dBuV/m)=Raw Value(dBuV) + Correction Factor(dB/m)
  2. Correction Factor(dB/m) = Antenna Factor (dB/m) + Cable Factor (dB)
  3. The other emission levels were very low against the limit.
  4. Margin value = Emission level – Limit value.
  5. The limit value is defined as per 15.247
  6. " \* " : Fundamental frequency



<b>MODE</b>	Channel 6	<b>FREQUENCY RANGE</b>	1000~25000MHz
<b>INPUT POWER (SYSTEM)</b>	120Vac, 60 Hz	<b>DETECTOR FUNCTION &amp; BANDWIDTH</b>	Peak (PK) Average (AV) 1 MHz
<b>ENVIRONMENTAL CONDITIONS</b>	27 deg. C, 59%RH, 972hPa	<b>TESTED BY</b>	Tony Chen

**ANTENNA POLARITY & TEST DISTANCE: HORIZONTAL AT 3 M**

No.	Freq. (MHz)	Emission Level (dBuV/m)	Limit (dBuV/m)	Margin (dB)	Antenna Height (m)	Table Angle (Degree)	Raw Value (dBuV)	Correction Factor (dB/m)
1	*2437.00	97.10 PK			1.50 H	117	67.10	30.00
1	*2437.00	93.00 AV			1.50 H	117	63.00	30.00
2	3249.00	44.60 PK	74.00	-29.40	1.12 H	188	12.50	32.00
2	3249.00	34.90 AV	54.00	-19.10	1.12 H	188	2.90	32.00
3	4874.00	52.90 PK	74.00	-21.10	1.03 H	138	17.70	35.20
3	4874.00	47.50 AV	54.00	-6.50	1.03 H	138	12.30	35.20
4	7311.00	50.40 PK	74.00	-23.60	1.08 H	161	9.00	41.40
4	7311.00	36.80 AV	54.00	-17.20	1.08 H	161	-4.60	41.40

**ANTENNA POLARITY & TEST DISTANCE: VERTICAL AT 3 M**

No.	Freq. (MHz)	Emission Level (dBuV/m)	Limit (dBuV/m)	Margin (dB)	Antenna Height (m)	Table Angle (Degree)	Raw Value (dBuV)	Correction Factor (dB/m)
1	*2437.00	108.20 PK			1.18 V	3	78.20	30.00
1	*2437.00	104.30 AV			1.18 V	3	74.30	30.00
2	3249.00	45.60 PK	74.00	-28.40	1.31 V	111	13.60	32.00
2	3249.00	37.40 AV	54.00	-16.60	1.31 V	111	5.40	32.00
3	4874.00	57.20 PK	74.00	-16.80	1.33 V	312	22.00	35.20
<b>3</b>	<b>4874.00</b>	<b>53.00 AV</b>	<b>54.00</b>	<b>-1.00</b>	<b>1.33 V</b>	<b>312</b>	<b>17.80</b>	<b>35.20</b>
4	7311.00	50.70 PK	74.00	-23.30	1.21 V	221	9.30	41.40
4	7311.00	38.10 AV	54.00	-15.90	1.21 V	221	-3.30	41.40

- REMARKS:**
1. Emission level(dBuV/m)=Raw Value(dBuV) + Correction Factor(dB/m)
  2. Correction Factor(dB/m) = Antenna Factor (dB/m) + Cable Factor (dB)
  3. The other emission levels were very low against the limit.
  4. Margin value = Emission level – Limit value.
  5. The limit value is defined as per 15.247
  6. “ \* “ : Fundamental frequency



<b>MODE</b>	Channel 11	<b>FREQUENCY RANGE</b>	1000~25000MHz
<b>INPUT POWER (SYSTEM)</b>	120Vac, 60 Hz	<b>DETECTOR FUNCTION &amp; BANDWIDTH</b>	Peak (PK) Average (AV) 1 MHz
<b>ENVIRONMENTAL CONDITIONS</b>	27 deg. C, 59%RH, 972hPa	<b>TESTED BY</b>	Tony Chen

**ANTENNA POLARITY & TEST DISTANCE: HORIZONTAL AT 3 M**

No.	Freq. (MHz)	Emission Level (dBuV/m)	Limit (dBuV/m)	Margin (dB)	Antenna Height (m)	Table Angle (Degree)	Raw Value (dBuV)	Correction Factor (dB/m)
1	*2462.00	97.90 PK			1.55 H	134	67.80	30.10
1	*2462.00	94.20 AV			1.55 H	134	64.00	30.10
2	2488.00	56.60 PK	74.00	-17.40	1.55 H	134	26.40	30.20
2	2488.00	43.70 AV	54.00	-10.30	1.55 H	134	13.40	30.20
3	3282.00	45.40 PK	74.00	-28.60	1.20 H	184	13.20	32.10
3	3282.00	37.30 AV	54.00	-16.70	1.20 H	184	5.20	32.10
4	4924.00	51.30 PK	74.00	-22.70	1.04 H	339	16.00	35.40
4	4924.00	45.30 AV	54.00	-8.70	1.04 H	339	9.90	35.40
5	7386.00	51.00 PK	74.00	-23.00	1.22 H	281	9.40	41.60
5	7386.00	37.40 AV	54.00	-16.60	1.22 H	281	-4.20	41.60

**ANTENNA POLARITY & TEST DISTANCE: VERTICAL AT 3 M**

No.	Freq. (MHz)	Emission Level (dBuV/m)	Limit (dBuV/m)	Margin (dB)	Antenna Height (m)	Table Angle (Degree)	Raw Value (dBuV)	Correction Factor (dB/m)
1	*2462.00	107.30 PK			1.05 V	102	77.20	30.10
1	*2462.00	103.80 AV			1.05 V	102	73.70	30.10
2	2488.00	63.00 PK	74.00	-11.00	1.05 V	102	32.80	30.20
2	2488.00	52.30 AV	54.00	-1.70	1.05 V	102	22.10	30.20
3	3282.00	45.60 PK	74.00	-28.40	1.54 V	191	13.40	32.10
3	3282.00	37.30 AV	54.00	-16.70	1.54 V	191	5.10	32.10
4	4924.00	56.60 PK	74.00	-17.40	1.15 V	67	21.30	35.40
4	4924.00	52.80 AV	54.00	-1.20	1.15 V	67	17.40	35.40
5	7386.00	50.80 PK	74.00	-23.20	1.12 V	276	9.20	41.60
5	7386.00	38.20 AV	54.00	-15.80	1.12 V	276	-3.40	41.60

- REMARKS:**
1. Emission level(dBuV/m)=Raw Value(dBuV) + Correction Factor(dB/m)
  2. Correction Factor(dB/m) = Antenna Factor (dB/m) + Cable Factor (dB)
  3. The other emission levels were very low against the limit.
  4. Margin value = Emission level – Limit value.
  5. The limit value is defined as per 15.247
  6. “ \* “ : Fundamental frequency

RESTRICTED BANDEDGE (802.11b MODE,CH1, HORIZONTAL )

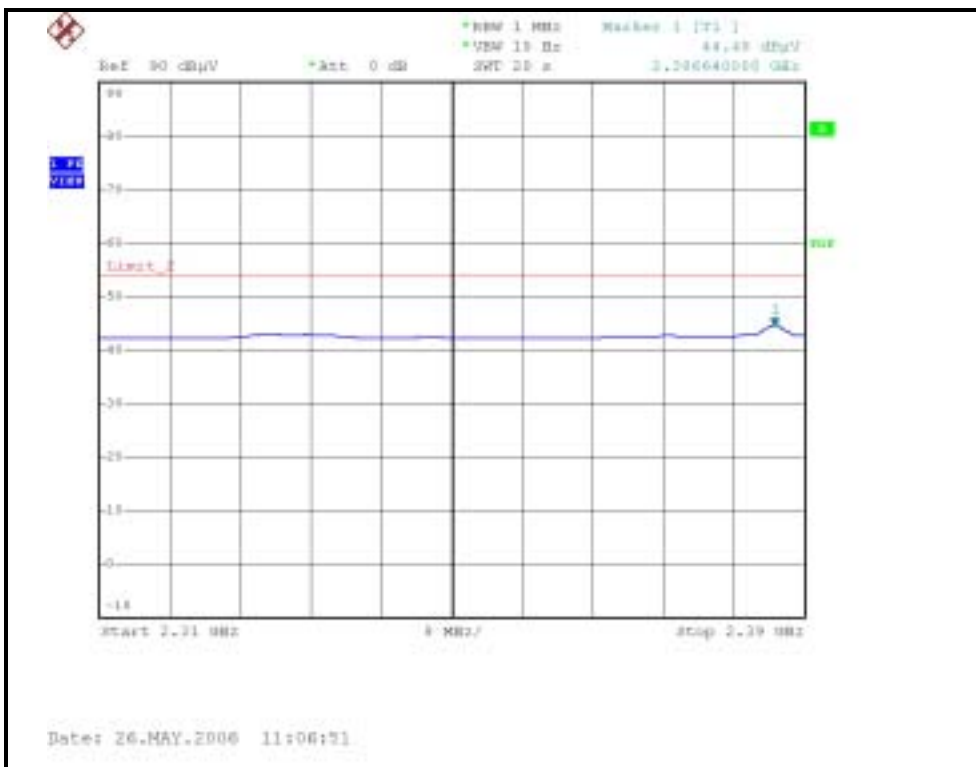
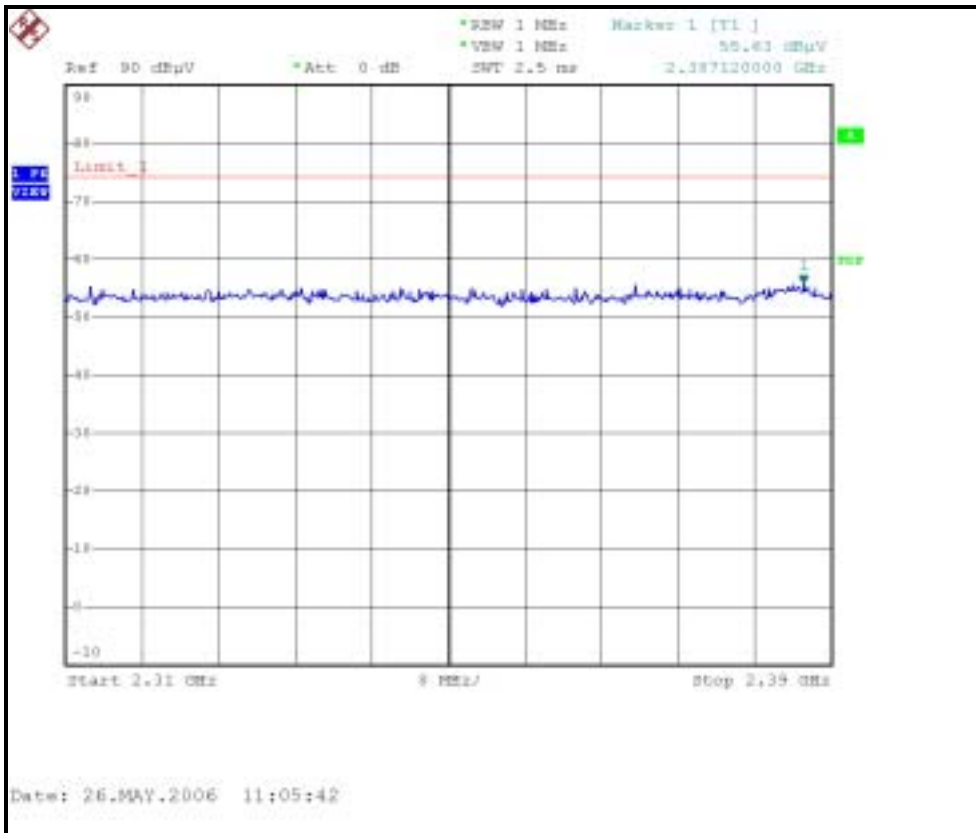

RESTRICTED BANDEDGE (802.11b MODE, CH1, VERTICAL )

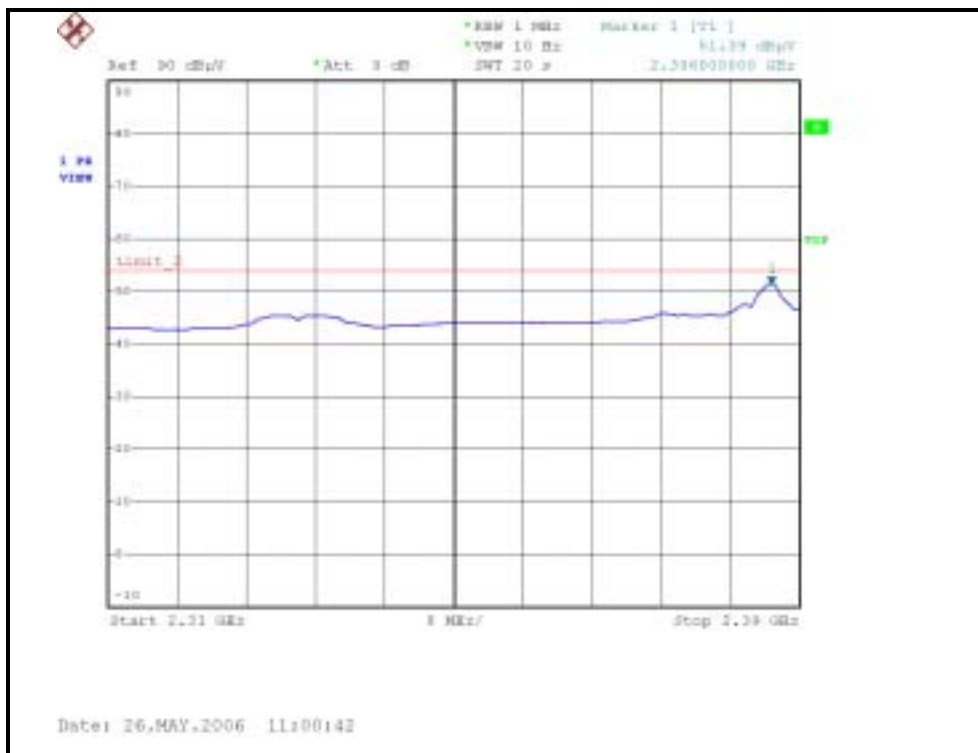
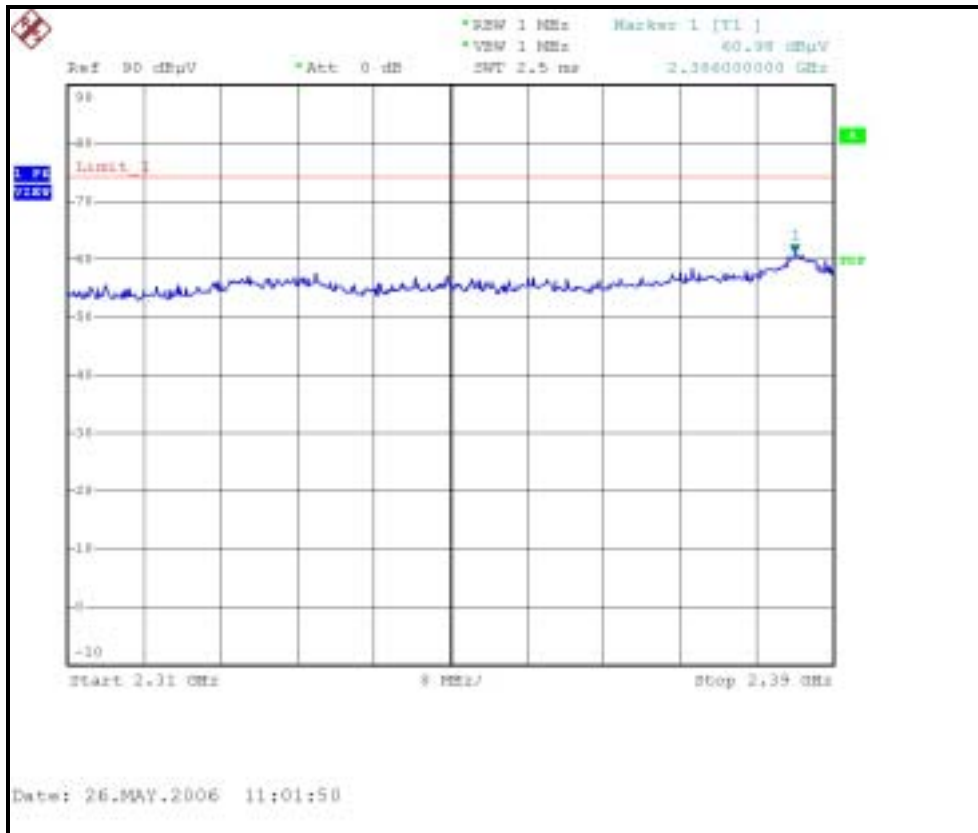

RESTRICTED BANDEDGE (802.11b MODE, CH11, HORIZONTAL )

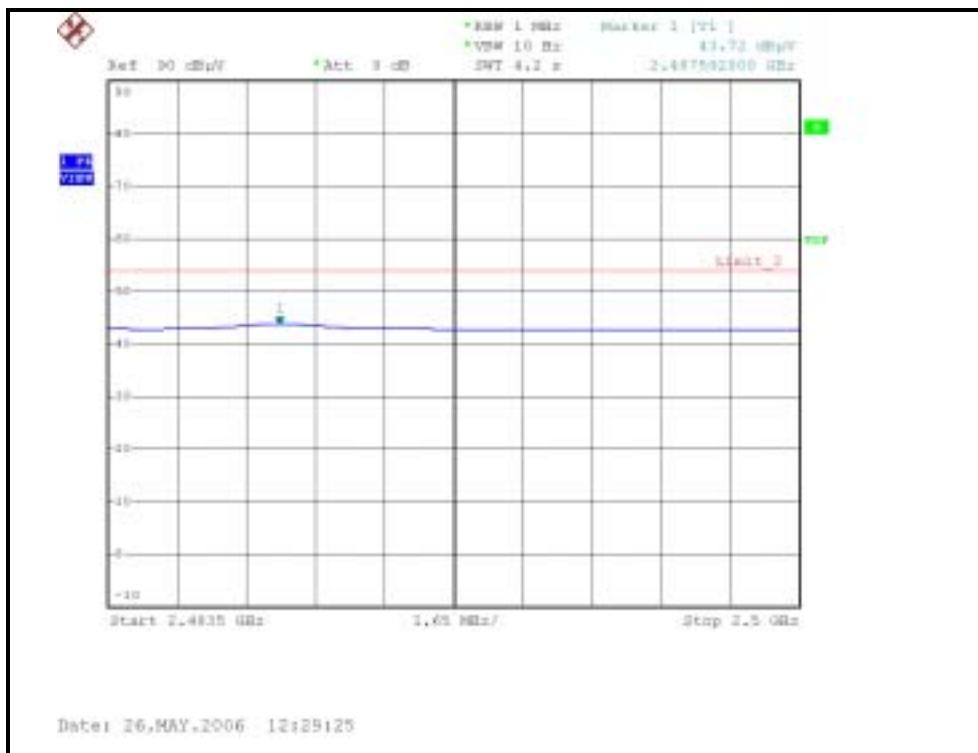
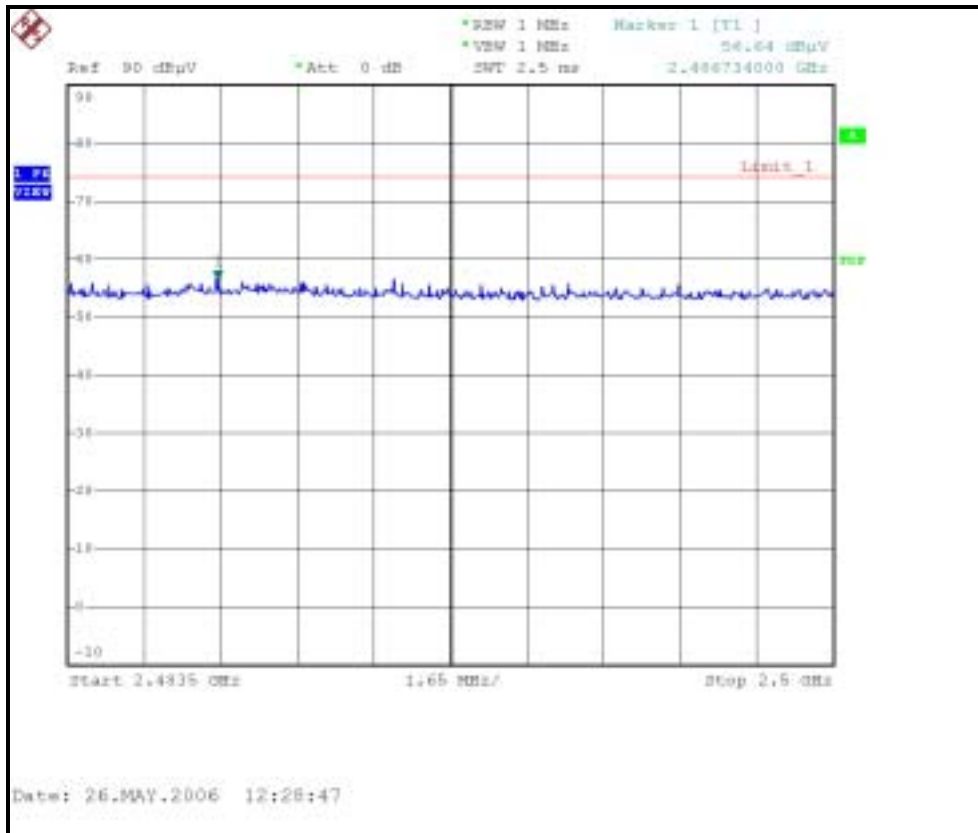

RESTRICTED BANDEDGE (802.11b MODE, CH11, VERTICAL )

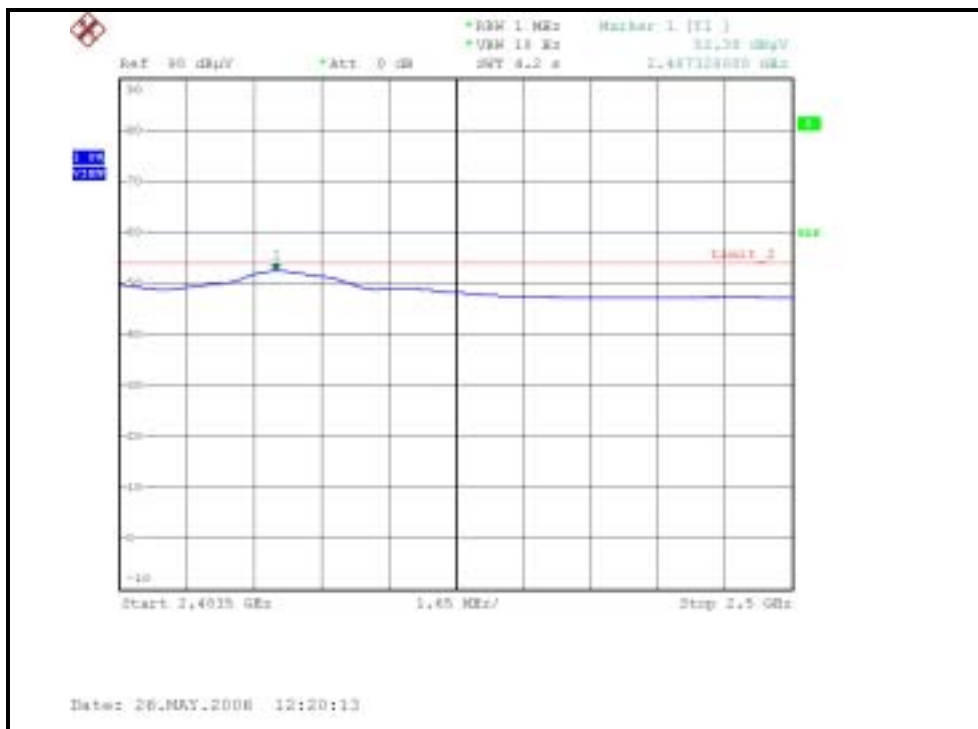
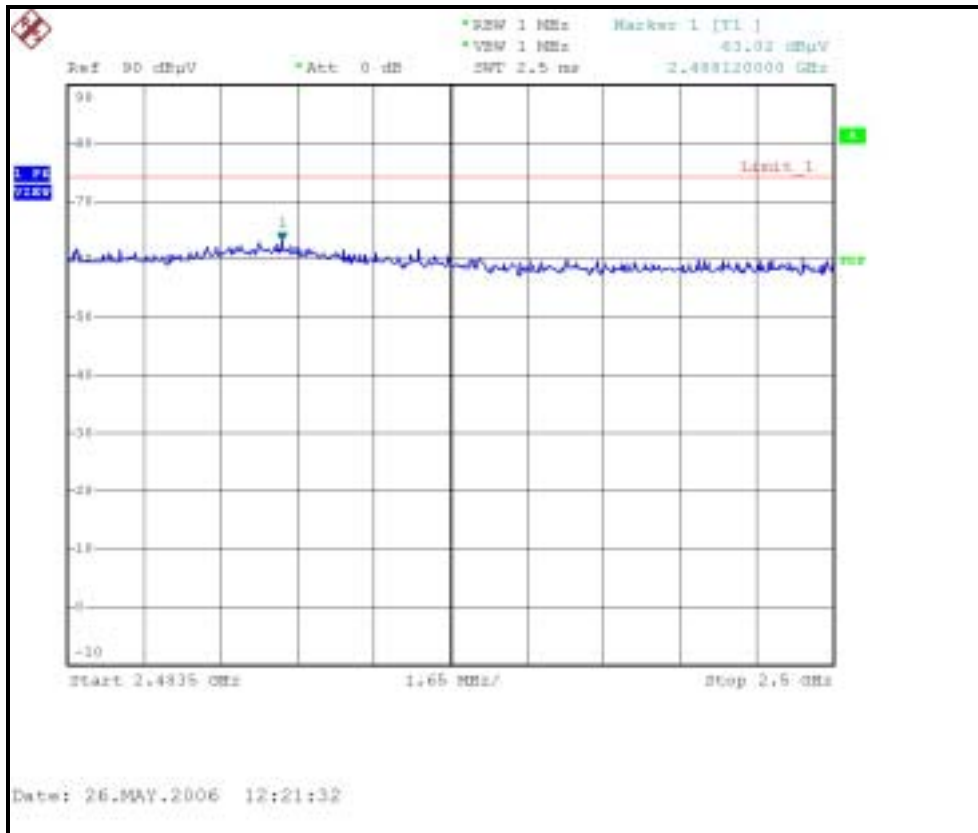





4.2.8 TEST RESULTS - OFDM  
**802.11g Normal OFDM modulation**

<b>MODE</b>	Channel 1	<b>FREQUENCY RANGE</b>	1000~25000MHz
<b>INPUT POWER (SYSTEM)</b>	120Vac, 60 Hz	<b>DETECTOR FUNCTION &amp; BANDWIDTH</b>	Peak (PK) Average (AV) 1 MHz
<b>ENVIRONMENTAL CONDITIONS</b>	27 deg. C, 60%RH, 972hPa	<b>TESTED BY</b>	Tony Chen

**ANTENNA POLARITY & TEST DISTANCE: HORIZONTAL AT 3 M**

No.	Freq. (MHz)	Emission Level (dBuV/m)	Limit (dBuV/m)	Margin (dB)	Antenna Height (m)	Table Angle (Degree)	Raw Value (dBuV)	Correction Factor (dB/m)
1	2390.00	58.80 PK	74.00	-15.20	1.22 H	96	29.00	29.80
1	2390.00	44.40 AV	54.00	-9.60	1.22 H	96	14.70	29.80
2	*2412.00	102.20 PK			1.25 H	121	72.30	29.90
2	*2412.00	91.20 AV			1.25 H	121	61.30	29.90
3	3216.00	44.90 PK	74.00	-29.10	1.18 H	200	13.00	32.00
3	3216.00	35.70 AV	54.00	-18.30	1.18 H	200	3.80	32.00
4	4824.00	50.40 PK	74.00	-23.60	1.20 H	343	15.40	35.00
4	4824.00	36.80 AV	54.00	-17.20	1.20 H	343	1.80	35.00
5	7236.00	51.20 PK	74.00	-22.80	1.12 H	325	10.00	41.10
5	7236.00	38.40 AV	54.00	-15.60	1.12 H	325	-2.80	41.10

**ANTENNA POLARITY & TEST DISTANCE: VERTICAL AT 3 M**

No.	Freq. (MHz)	Emission Level (dBuV/m)	Limit (dBuV/m)	Margin (dB)	Antenna Height (m)	Table Angle (Degree)	Raw Value (dBuV)	Correction Factor (dB/m)
1	2390.00	66.80 PK	74.00	-7.20	1.00 V	356	37.00	29.80
1	2390.00	52.30 AV	54.00	-1.70	1.00 V	356	22.50	29.80
2	*2412.00	111.30 PK			1.39 V	360	81.40	29.90
2	*2412.00	100.60 AV			1.39 V	360	70.70	29.90
3	3216.00	45.50 PK	74.00	-28.50	1.38 V	152	13.60	32.00
3	3216.00	36.80 AV	54.00	-17.20	1.38 V	152	4.90	32.00
4	4824.00	54.80 PK	74.00	-19.20	1.25 V	34	19.80	35.00
4	4824.00	42.30 AV	54.00	-11.70	1.25 V	34	7.30	35.00
5	7236.00	51.90 PK	74.00	-22.10	1.15 V	52	10.70	41.10
5	7236.00	39.20 AV	54.00	-14.80	1.15 V	52	-2.00	41.10

- REMARKS:**
1. Emission level(dBuV/m)=Raw Value(dBuV) + Correction Factor(dB/m)
  2. Correction Factor(dB/m) = Antenna Factor (dB/m) + Cable Factor (dB)
  3. The other emission levels were very low against the limit.
  4. Margin value = Emission level – Limit value.
  5. The limit value is defined as per 15.247
  6. “ \* “ : Fundamental frequency



<b>MODE</b>	Channel 6	<b>FREQUENCY RANGE</b>	1000~25000MHz
<b>INPUT POWER (SYSTEM)</b>	120Vac, 60 Hz	<b>DETECTOR FUNCTION &amp; BANDWIDTH</b>	Peak (PK) Average (AV) 1 MHz
<b>ENVIRONMENTAL CONDITIONS</b>	27 deg. C, 60%RH, 972hPa	<b>TESTED BY</b>	Tony Chen

**ANTENNA POLARITY & TEST DISTANCE: HORIZONTAL AT 3 M**

No.	Freq. (MHz)	Emission Level (dBuV/m)	Limit (dBuV/m)	Margin (dB)	Antenna Height (m)	Table Angle (Degree)	Raw Value (dBuV)	Correction Factor (dB/m)
1	*2437.00	103.30 PK			1.70 H	143	73.30	30.00
1	*2437.00	93.00 AV			1.70 H	143	63.00	30.00
2	3249.00	44.90 PK	74.00	-29.10	1.35 H	180	12.90	32.00
2	3249.00	36.10 AV	54.00	-17.90	1.35 H	180	4.10	32.00
3	4874.00	51.80 PK	74.00	-22.20	1.35 H	335	16.60	35.20
3	4874.00	39.40 AV	54.00	-14.60	1.35 H	335	4.20	35.20
4	7311.00	49.70 PK	74.00	-24.30	1.30 H	328	8.30	41.40
4	7311.00	37.20 AV	54.00	-16.80	1.30 H	328	-4.20	41.40

**ANTENNA POLARITY & TEST DISTANCE: VERTICAL AT 3 M**

No.	Freq. (MHz)	Emission Level (dBuV/m)	Limit (dBuV/m)	Margin (dB)	Antenna Height (m)	Table Angle (Degree)	Raw Value (dBuV)	Correction Factor (dB/m)
1	*2437.00	115.20 PK			1.18 V	1	85.20	30.00
1	*2437.00	104.30 AV			1.18 V	1	74.30	30.00
2	3249.00	45.10 PK	74.00	-28.90	1.00 V	323	13.10	32.00
2	3249.00	35.60 AV	54.00	-18.40	1.00 V	323	3.60	32.00
3	4874.00	58.70 PK	74.00	-15.30	1.00 V	325	23.50	35.20
3	4874.00	46.90 AV	54.00	-7.10	1.00 V	325	11.70	35.20
4	7311.00	49.50 PK	74.00	-24.50	1.05 V	302	8.10	41.40
4	7311.00	36.70 AV	54.00	-17.30	1.05 V	302	-4.70	41.40

- REMARKS:**
1. Emission level(dBuV/m)=Raw Value(dBuV) + Correction Factor(dB/m)
  2. Correction Factor(dB/m) = Antenna Factor (dB/m) + Cable Factor (dB)
  3. The other emission levels were very low against the limit.
  4. Margin value = Emission level – Limit value.
  5. The limit value is defined as per 15.247
  6. “ \* “ : Fundamental frequency



<b>MODE</b>	Channel 11	<b>FREQUENCY RANGE</b>	1000~25000MHz
<b>INPUT POWER (SYSTEM)</b>	120Vac, 60 Hz	<b>DETECTOR FUNCTION &amp; BANDWIDTH</b>	Peak (PK) Average (AV) 1 MHz
<b>ENVIRONMENTAL CONDITIONS</b>	27 deg. C, 60%RH, 972hPa	<b>TESTED BY</b>	Tony Chen

#### ANTENNA POLARITY & TEST DISTANCE: HORIZONTAL AT 3 M

No.	Freq. (MHz)	Emission Level (dBuV/m)	Limit (dBuV/m)	Margin (dB)	Antenna Height (m)	Table Angle (Degree)	Raw Value (dBuV)	Correction Factor (dB/m)
1	*2462.00	100.80 PK			1.00 H	308	70.70	30.10
1	*2462.00	90.50 AV			1.00 H	308	60.40	30.10
2	2483.50	56.00 PK	74.00	-18.00	1.01 H	308	25.80	30.20
2	2483.50	44.10 AV	54.00	-9.90	1.01 H	308	13.90	30.20
3	3282.00	45.90 PK	74.00	-28.10	1.20 H	177	13.80	32.10
3	3282.00	36.60 AV	54.00	-17.40	1.20 H	177	4.50	32.10
4	4924.00	50.20 PK	74.00	-23.80	1.20 H	313	14.80	35.40
4	4924.00	36.90 AV	54.00	-17.10	1.20 H	313	1.50	35.40
5	7386.00	51.30 PK	74.00	-22.70	1.28 H	350	9.70	41.60
5	7386.00	38.40 AV	54.00	-15.60	1.28 H	350	-3.20	41.60

#### ANTENNA POLARITY & TEST DISTANCE: VERTICAL AT 3 M

No.	Freq. (MHz)	Emission Level (dBuV/m)	Limit (dBuV/m)	Margin (dB)	Antenna Height (m)	Table Angle (Degree)	Raw Value (dBuV)	Correction Factor (dB/m)
1	*2462.00	112.30 PK			1.00 V	60	82.20	30.10
1	*2462.00	101.20 AV			1.00 V	60	71.10	30.10
2	2483.50	61.70 PK	74.00	-12.30	1.14 V	1	31.50	30.20
2	2483.50	52.50 AV	54.00	-1.50	1.14 V	1	22.30	30.20
3	3282.00	46.60 PK	74.00	-27.40	1.30 V	250	14.50	32.10
3	3282.00	37.80 AV	54.00	-16.20	1.30 V	250	5.70	32.10
4	4924.00	56.80 PK	74.00	-17.20	1.20 V	16	21.40	35.40
4	4924.00	44.20 AV	54.00	-9.80	1.20 V	16	8.80	35.40
5	7386.00	51.30 PK	74.00	-22.70	1.16 V	42	9.70	41.60
5	7386.00	38.50 AV	54.00	-15.50	1.16 V	42	-3.10	41.60

- REMARKS:**
1. Emission level(dBuV/m)=Raw Value(dBuV) + Correction Factor(dB/m)
  2. Correction Factor(dB/m) = Antenna Factor (dB/m) + Cable Factor (dB)
  3. The other emission levels were very low against the limit.
  4. Margin value = Emission level – Limit value.
  5. The limit value is defined as per 15.247
  6. " \* " : Fundamental frequency

RESTRICTED BANDEDGE (802.11g MODE, CH1, HORIZONTAL )

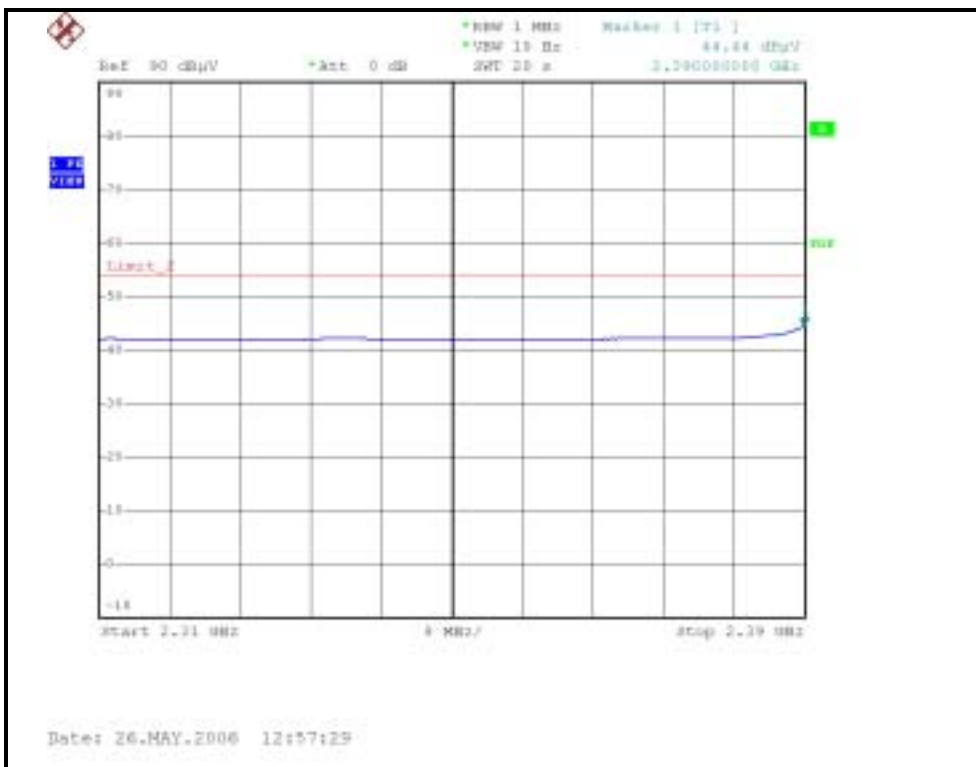
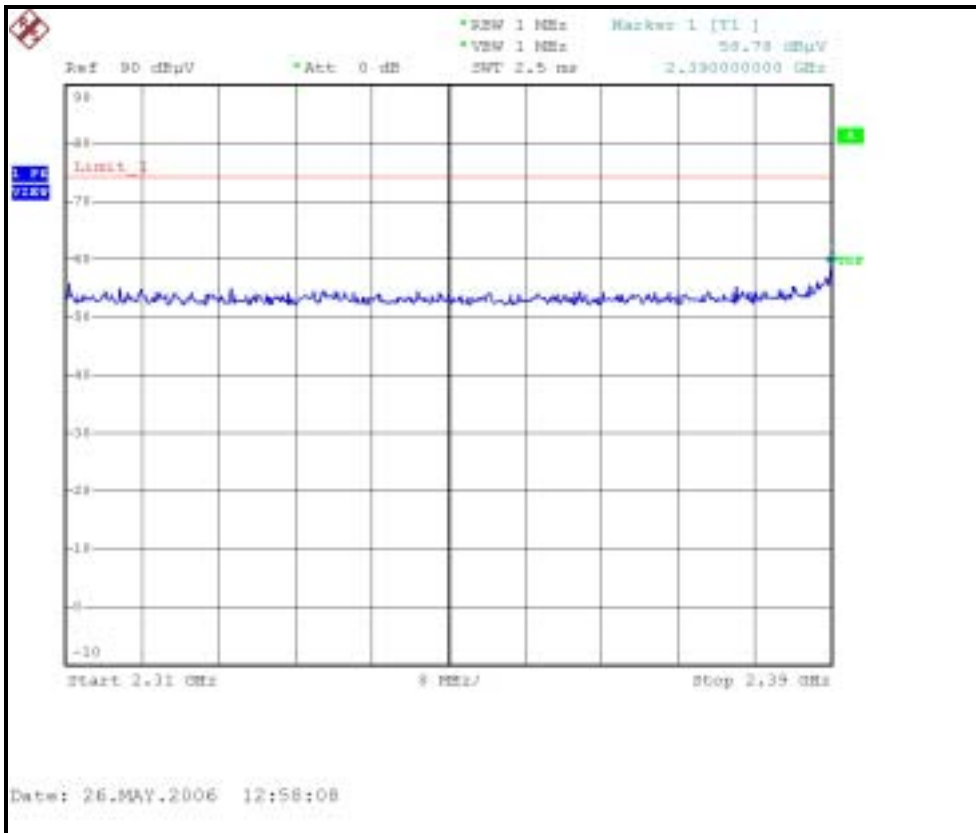

RESTRICTED BANDEDGE (802.11g MODE, CH1, VERTICAL )

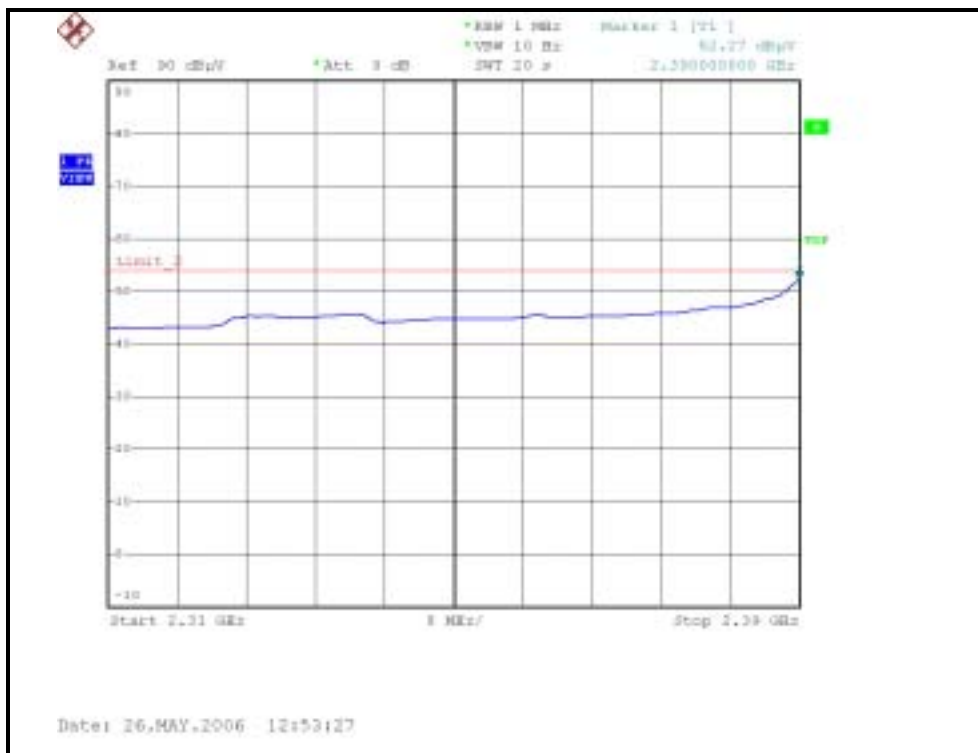
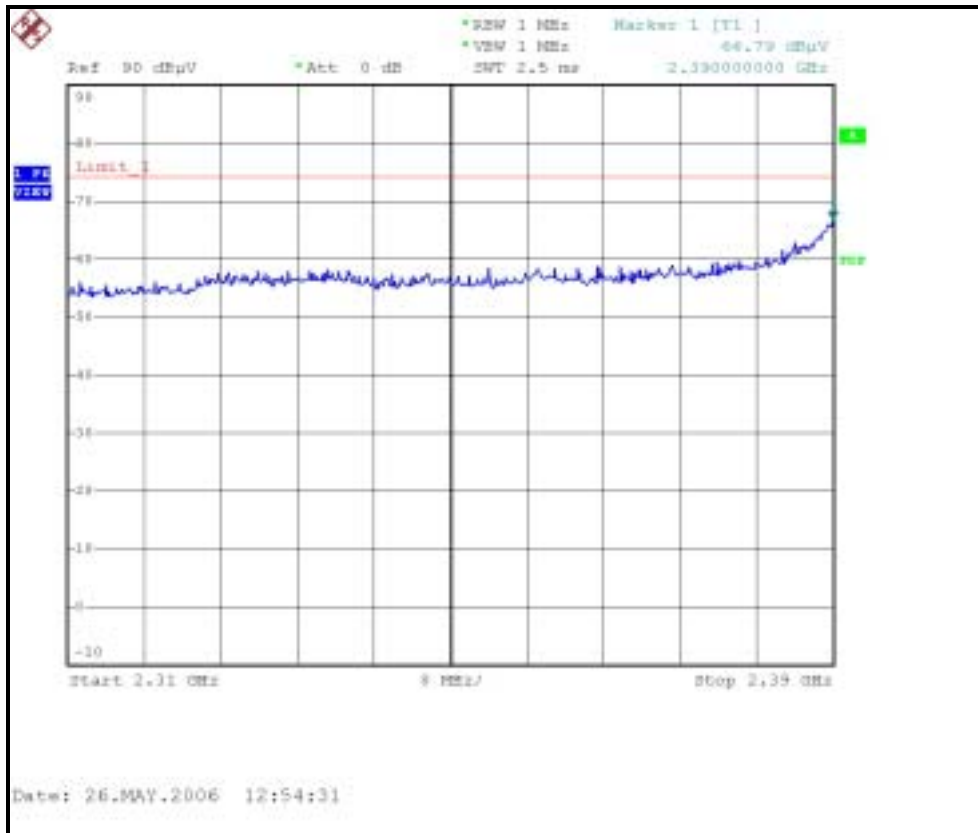

RESTRICTED BANDEDGE (802.11g MODE, CH11, HORIZONTAL )

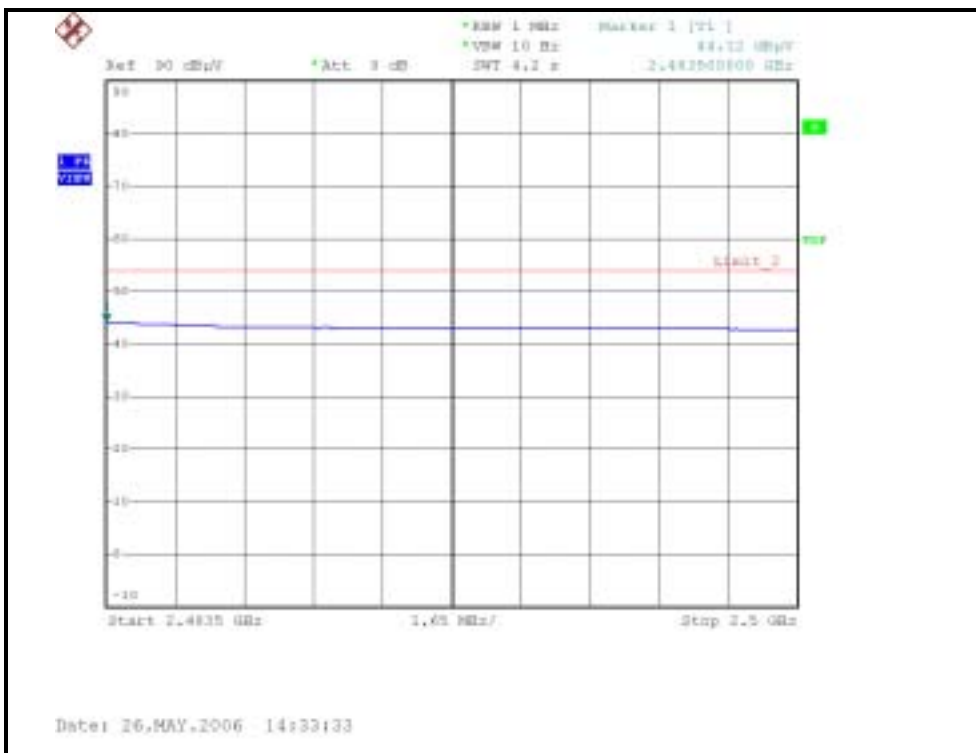
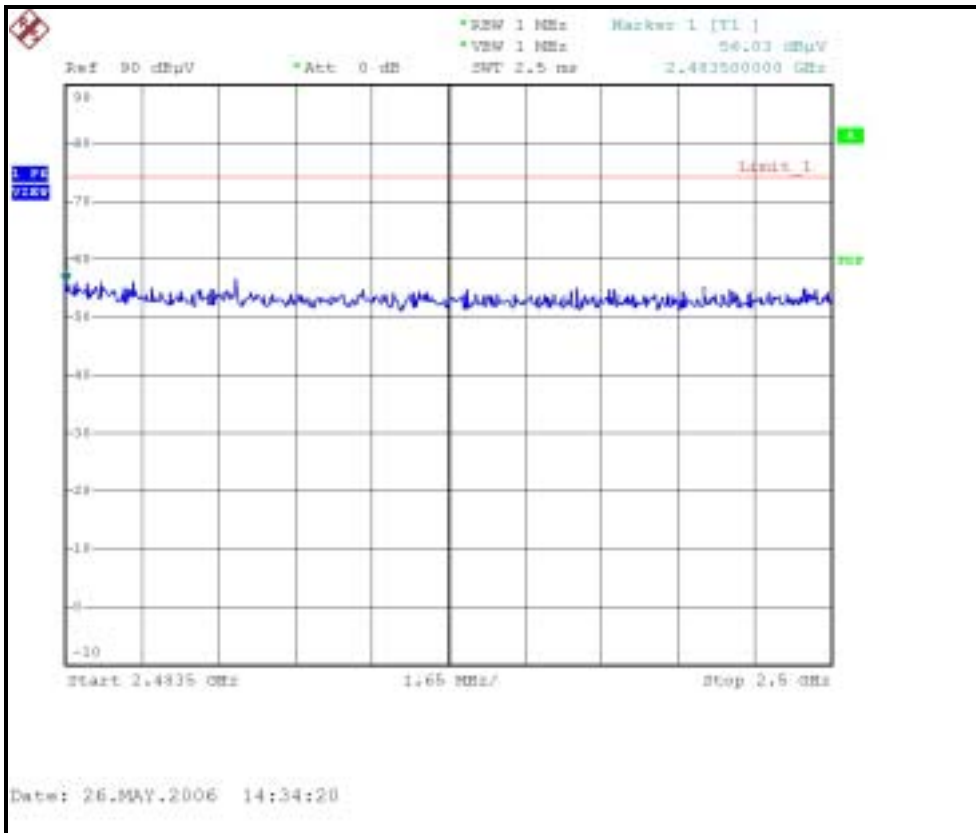

RESTRICTED BANDEDGE (802.11g MODE, CH11, VERTICAL )

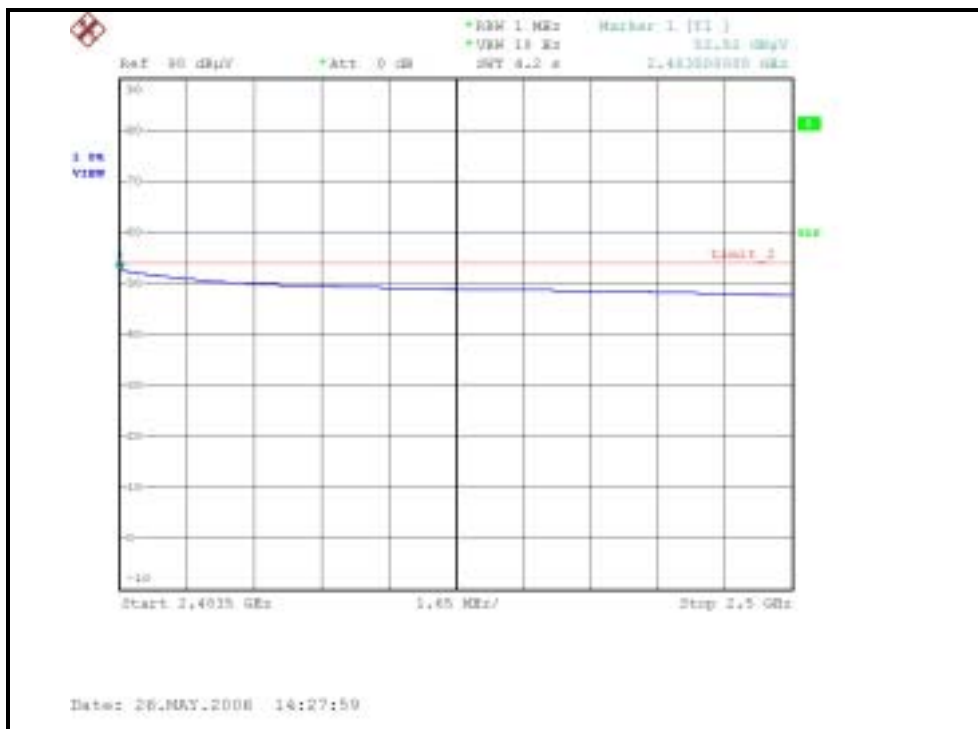
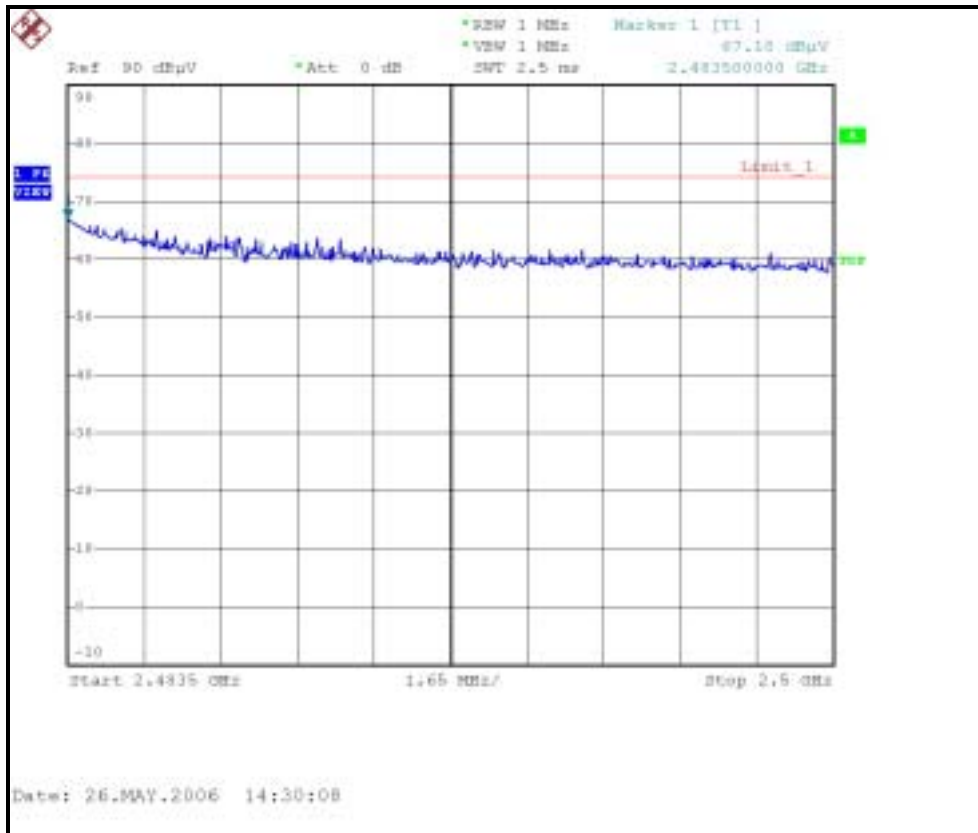



### 4.3 6dB BANDWIDTH MEASUREMENT

#### 4.3.1 LIMITS OF 6dB BANDWIDTH MEASUREMENT

The minimum of 6dB Bandwidth Measurement is 0.5 MHz.

#### 4.3.2 TEST INSTRUMENTS

Description & Manufacturer	Model No.	Serial No.	Calibrated Until
R&S SPECTRUM ANALYZER	FSP40	100036	Nov. 23, 2006

**NOTE:**

- 1.The measurement uncertainty is less than +/- 2.6dB, which is calculated as per the NAMAS document NIS81.
- 2.The calibration interval of the above test instruments is 12 months and the calibrations are traceable to NML/ROC and NIST/USA.



#### 4.3.3 TEST PROCEDURE

The transmitter output was connected to the spectrum analyzer through an attenuator. The bandwidth of the fundamental frequency was measured by spectrum analyzer with 100 kHz RBW and 100 kHz VBW. The 6 dB bandwidth is defined as the total spectrum the power of which is higher than peak power minus 6 dB.

#### 4.3.4 TEST SETUP



For the actual test configuration, please refer to the related Item – Photographs of the Test Configuration.

#### 4.3.5 EUT OPERATING CONDITIONS

The software provided by client to enable the EUT under transmission condition continuously at lowest, middle and highest channel frequencies individually.



#### 4.3.6 TEST RESULTS –DSSS

##### 802.11b DSSS modulation

<b>MODULATION TYPE</b>	CCK	<b>TRANSFER RATE</b>	11Mbps
<b>INPUT POWER (SYSTEM)</b>	120Vac, 60 Hz	<b>ENVIRONMENTAL CONDITIONS</b>	27deg. C, 66%RH, 972hPa
<b>TESTED BY</b>	Sky Liao		

<b>CHANNEL</b>	<b>CHANNEL FREQUENCY (MHz)</b>	<b>6 dB BANDWIDTH (MHz)</b>	<b>MINIMUM LIMIT (MHz)</b>	<b>PASS/FAIL</b>
1	2412	12.85	0.5	PASS
6	2437	12.80	0.5	PASS
11	2462	12.85	0.5	PASS

# CH1

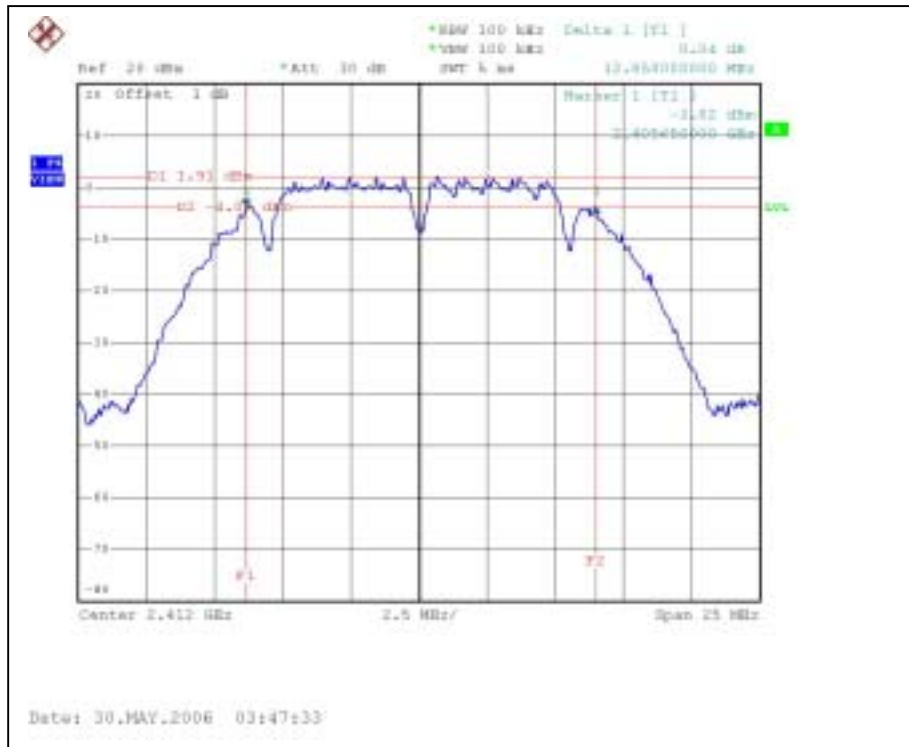

# CH6

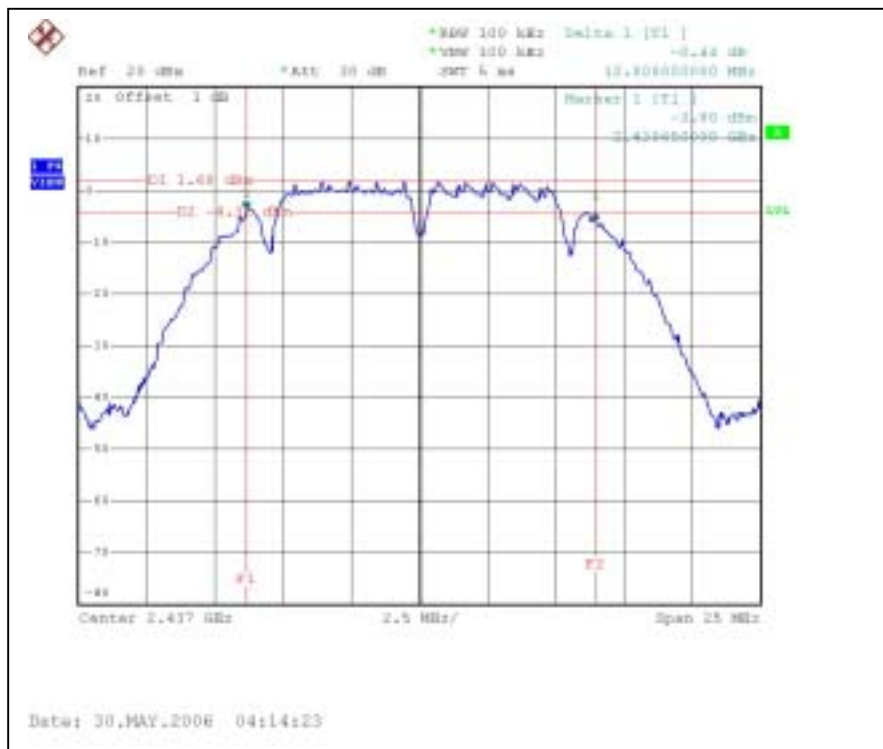

CH11

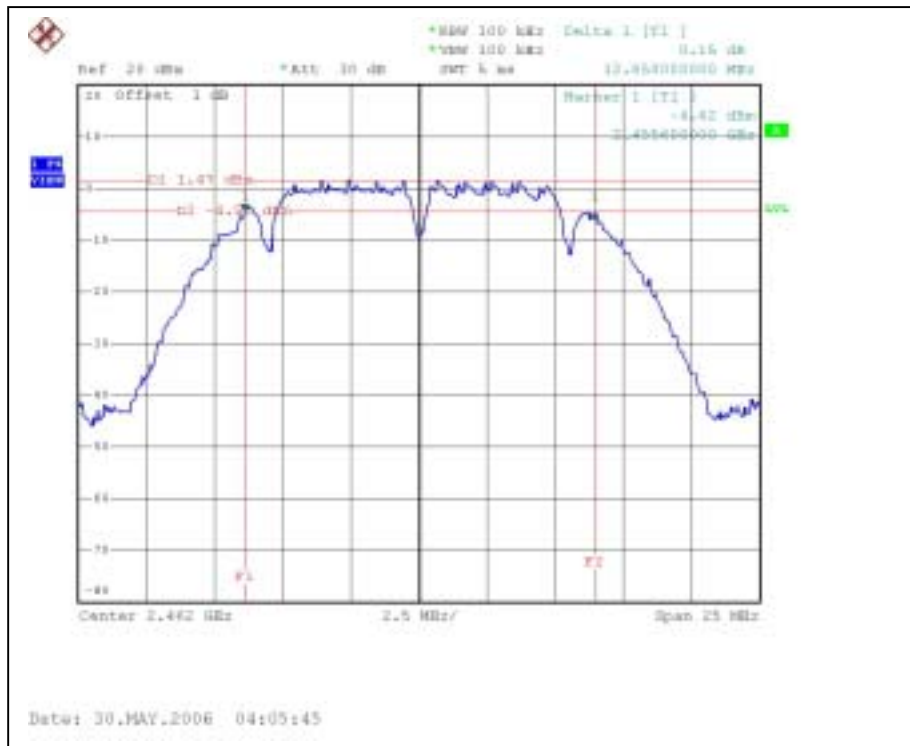



#### 4.3.7 TEST RESULTS-OFDM

##### 802.11g OFDM modulation

<b>MODULATION TYPE</b>	BPSK	<b>TRANSFER RATE</b>	6Mbps
<b>INPUT POWER (SYSTEM)</b>	120Vac, 60 Hz	<b>ENVIRONMENTAL CONDITIONS</b>	27deg. C, 66%RH, 972hPa
<b>TESTED BY</b>	Sky Liao		

<b>CHANNEL</b>	<b>CHANNEL FREQUENCY (MHz)</b>	<b>6 dB BANDWIDTH (MHz)</b>	<b>MINIMUM LIMIT (MHz)</b>	<b>PASS/FAIL</b>
1	2412	16.45	0.5	PASS
6	2437	16.45	0.5	PASS
11	2462	16.40	0.5	PASS

CH1

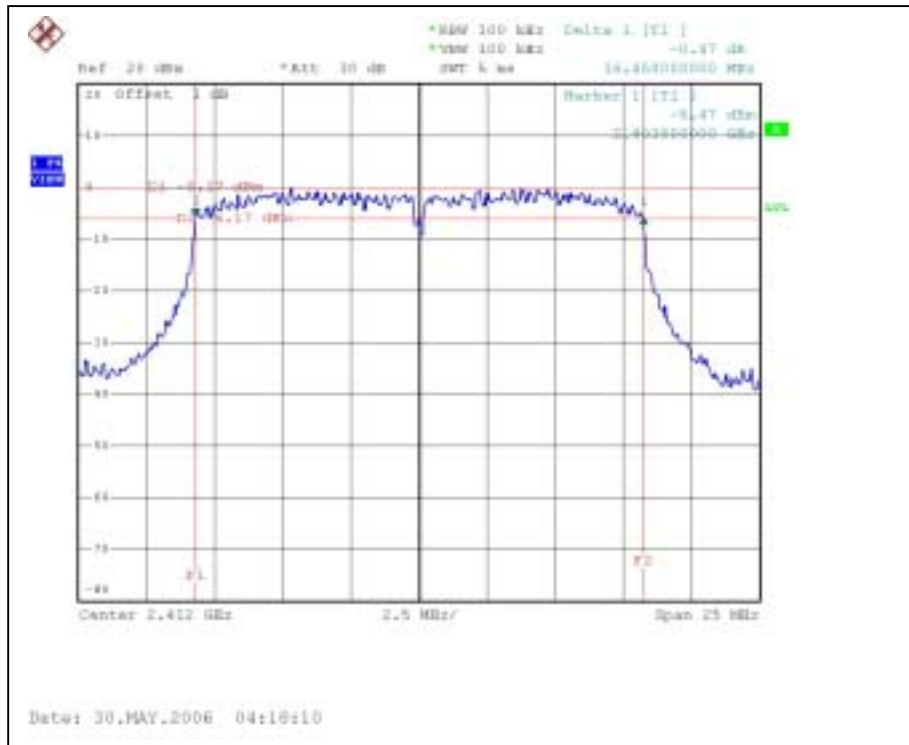

CH6

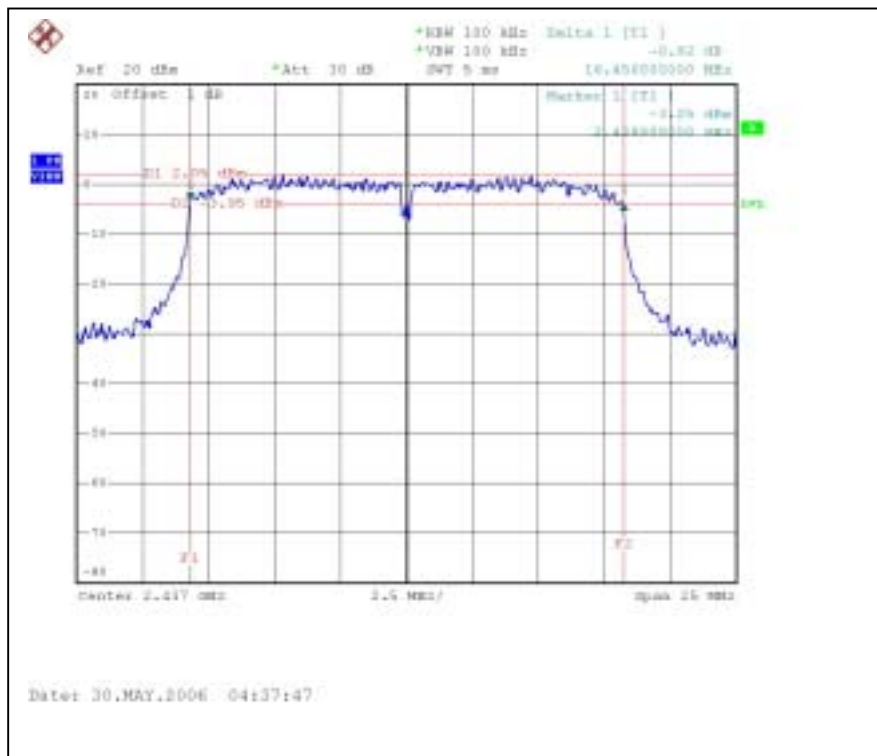

CH11

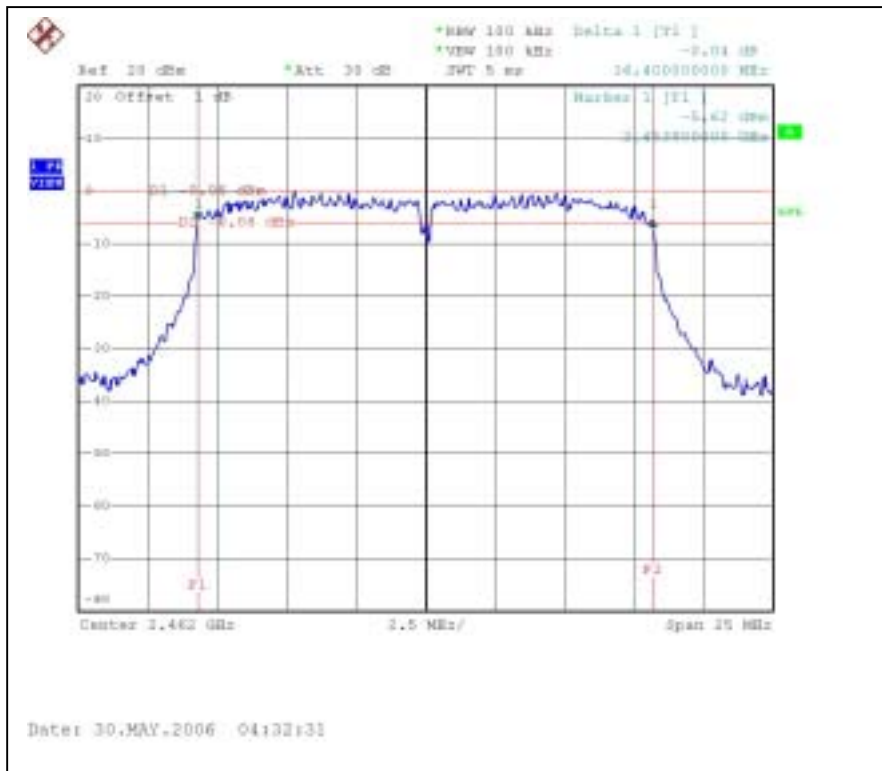



#### 4.4 MAXIMUM PEAK OUTPUT POWER

##### 4.4.1 LIMITS OF MAXIMUM PEAK OUTPUT POWER MEASUREMENT

The Maximum Peak Output Power Measurement is 30dBm.

##### 4.4.2 TEST INSTRUMENTS

Description & Manufacturer	Model No.	Serial No.	Calibrated Until
R&S SPECTRUM ANALYZER	FSP40	100036	Nov. 23, 2006
Agilent SIGNAL GENERATOR	E8257C	MY43320668	Dec. 07, 2006
TEKTRONIX OSCILLOSCOPE	TDS380	B016335	Jun. 22, 2006
NARDA DETECTOR	4503A	FSCM99899	NA

**NOTE:**

The calibration interval of the above test instruments is 12 months and the calibrations are traceable to NML/ROC and NIST/USA.



#### 4.4.3 TEST PROCEDURES

1. A detector was used on the output port of the EUT. An oscilloscope was used to read the peak response of the detector.
2. Replaced the EUT by the signal generator. The center frequency of the S.G was adjusted to the center frequency of the measured channel.
3. Adjusted the power to have the same peak reading on oscilloscope. Record the power level.

#### 4.4.4 TEST SETUP

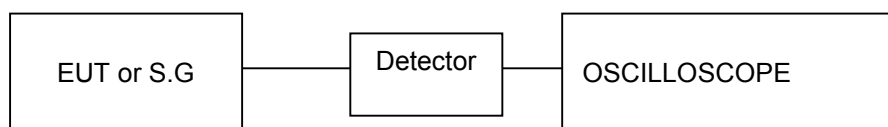

#### 4.4.5 EUT OPERATING CONDITIONS

Same as Item 4.3.5



#### 4.4.6 TEST RESULTS – DSSS

##### 802.11b DSSS modulation

<b>MODULATION TYPE</b>	CCK	<b>TRANSFER RATE</b>	11Mbps
<b>INPUT POWER (SYSTEM)</b>	120Vac, 60Hz	<b>ENVIRONMENTAL CONDITIONS</b>	27deg. C, 66%RH, 972hPa
<b>TESTED BY</b>	Sky Liao		

<b>CHANNEL</b>	<b>CHANNEL FREQUENCY (MHz)</b>	<b>PEAK POWER OUTPUT (mW)</b>	<b>PEAK POWER OUTPUT (dBm)</b>	<b>PEAK POWER LIMIT (dBm)</b>	<b>PASS/FAIL</b>
1	2412	39.811	16.00	30	PASS
6	2437	38.019	15.80	30	PASS
11	2462	41.687	16.20	30	PASS



#### 4.4.7 TEST RESULTS –OFDM

##### 802.11g OFDM modulation

<b>MODULATION TYPE</b>	BPSK	<b>TRANSFER RATE</b>	6Mbps
<b>INPUT POWER (SYSTEM)</b>	120Vac, 60Hz	<b>ENVIRONMENTAL CONDITIONS</b>	27deg. C, 66%RH, 972hPa
<b>TESTED BY</b>	Sky Liao		

<b>CHANNEL</b>	<b>CHANNEL FREQUENCY (MHz)</b>	<b>PEAK POWER OUTPUT (mW)</b>	<b>PEAK POWER OUTPUT (dBm)</b>	<b>PEAK POWER LIMIT (dBm)</b>	<b>PASS/FAIL</b>
1	2412	107.152	20.30	30	PASS
6	2437	177.828	22.50	30	PASS
11	2462	112.202	20.50	30	PASS



## 4.5 POWER SPECTRAL DENSITY MEASUREMENT

### 4.5.1 LIMITS OF POWER SPECTRAL DENSITY MEASUREMENT

The Maximum of Power Spectral Density Measurement is 8dBm.

### 4.5.2 TEST INSTRUMENTS

Description & Manufacturer	Model No.	Serial No.	Calibrated Until
R&S SPECTRUM ANALYZER	FSP40	100036	Nov. 23, 2006

**NOTE:**

- 1.The measurement uncertainty is less than +/- 2.6dB, which is calculated as per the NAMAS document NIS81.
- 2.The calibration interval of the above test instruments is 12 months and the calibrations are traceable to NML/ROC and NIST/USA.

#### 4.5.3 TEST PROCEDURE

The transmitter output was connected to the spectrum analyzer through an attenuator, the bandwidth of the fundamental frequency was measured with the spectrum analyzer using 3 kHz RBW and 30 kHz VBW, set sweep time=span/3kHz. The power spectral density was measured and recorded. The sweep time is allowed to be longer than span/3KHz for a full response of the mixer in the spectrum analyzer.

#### 4.5.4 TEST SETUP

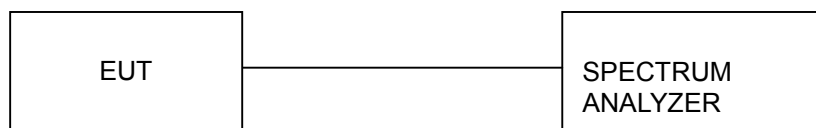

#### 4.5.5 EUT OPERATING CONDITIONS

Same as 4.3.5



#### 4.5.6 TEST RESULTS –DSSS

##### 802.11b DSSS modulation

<b>MODULATION TYPE</b>	CCK	<b>TRANSFER RATE</b>	11Mbps
<b>INPUT POWER (SYSTEM)</b>	120Vac, 60Hz	<b>ENVIRONMENTAL CONDITIONS</b>	27deg. C, 66%RH, 972hPa
<b>TESTED BY</b>	Sky Liao		

<b>CHANNEL NUMBER</b>	<b>CHANNEL FREQUENCY (MHz )</b>	<b>RF POWER LEVEL IN 3 KHz BW (dBm)</b>	<b>MAXIMUM LIMIT (dBm)</b>	<b>PASS/FAIL</b>
1	2412	-9.27	8	PASS
6	2437	-9.22	8	PASS
11	2462	-9.54	8	PASS

### CH1

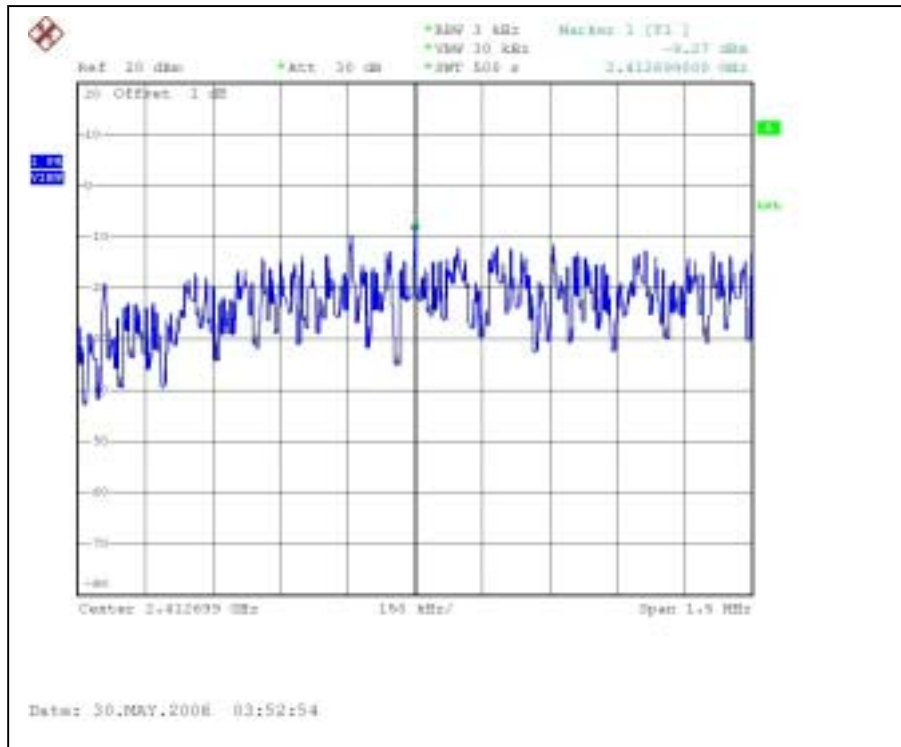

### CH6

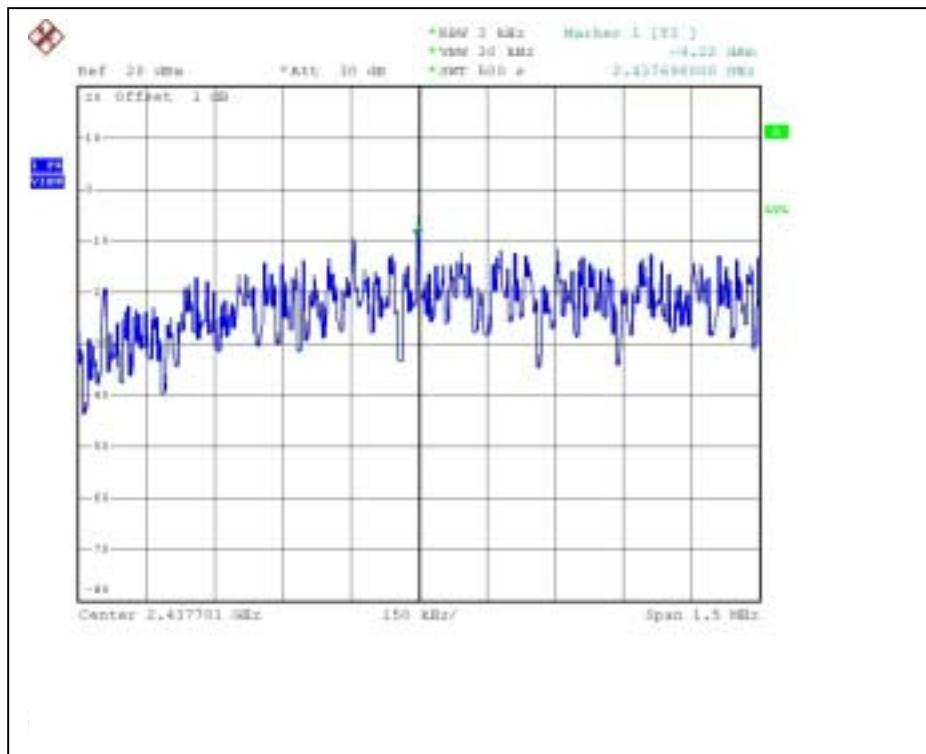

CH11

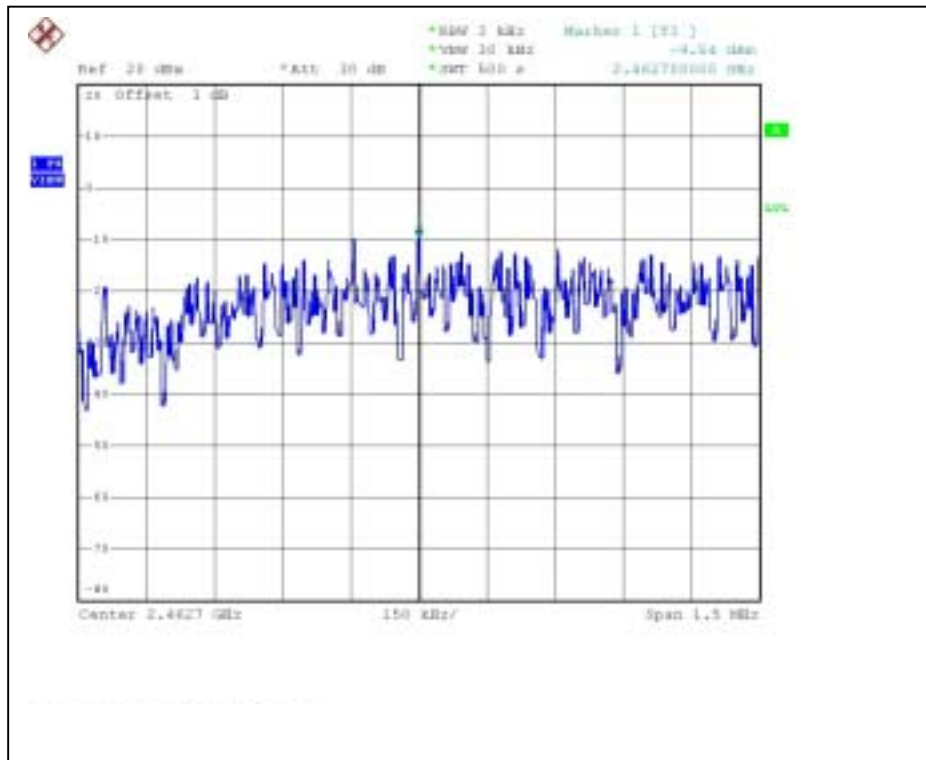





#### 4.5.7 TEST RESULTS –OFDM

##### 802.11g OFDM modulation

<b>MODULATION TYPE</b>	BPSK	<b>TRANSFER RATE</b>	6Mbps
<b>INPUT POWER (SYSTEM)</b>	120Vac, 60Hz	<b>ENVIRONMENTAL CONDITIONS</b>	27deg. C, 66%RH, 972hPa
<b>TESTED BY</b>	Sky Liao		

<b>CHANNEL NUMBER</b>	<b>CHANNEL FREQUENCY (MHz )</b>	<b>RF POWER LEVEL IN 3 KHz BW (dBm)</b>	<b>MAXIMUM LIMIT (dBm)</b>	<b>PASS/FAIL</b>
1	2412	-12.86	8	PASS
6	2437	-11.22	8	PASS
11	2462	-13.03	8	PASS

CH1

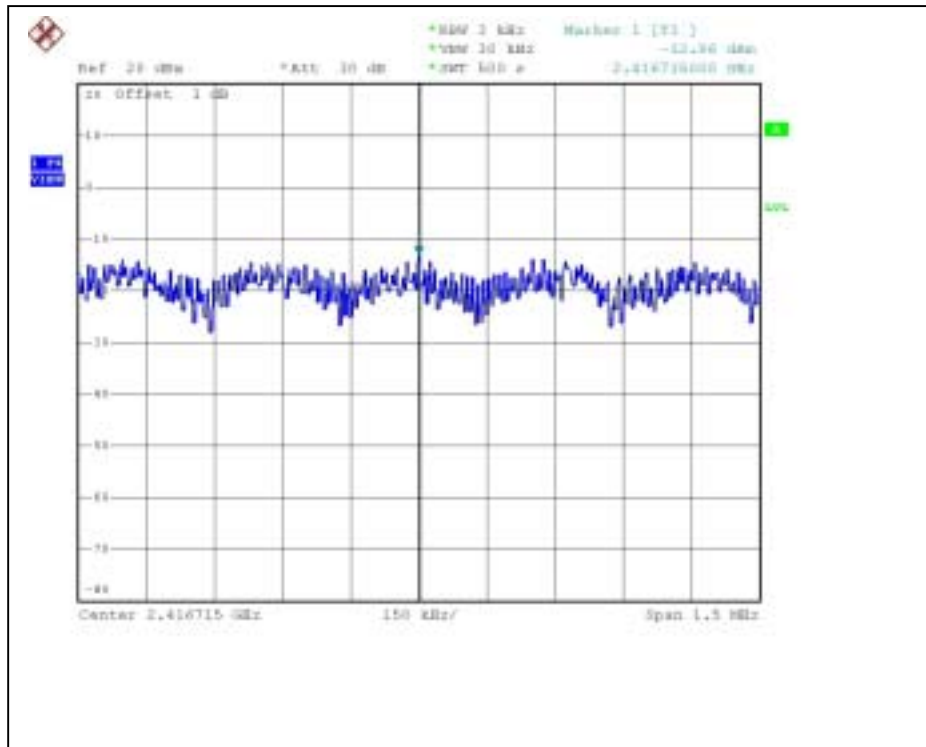

CH6

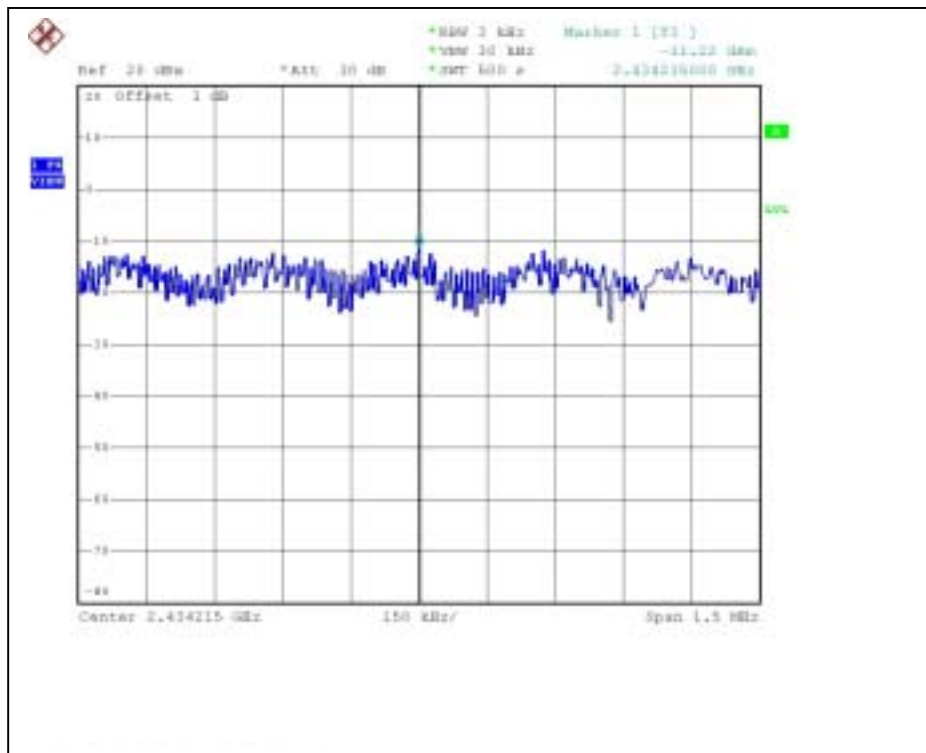

CH11

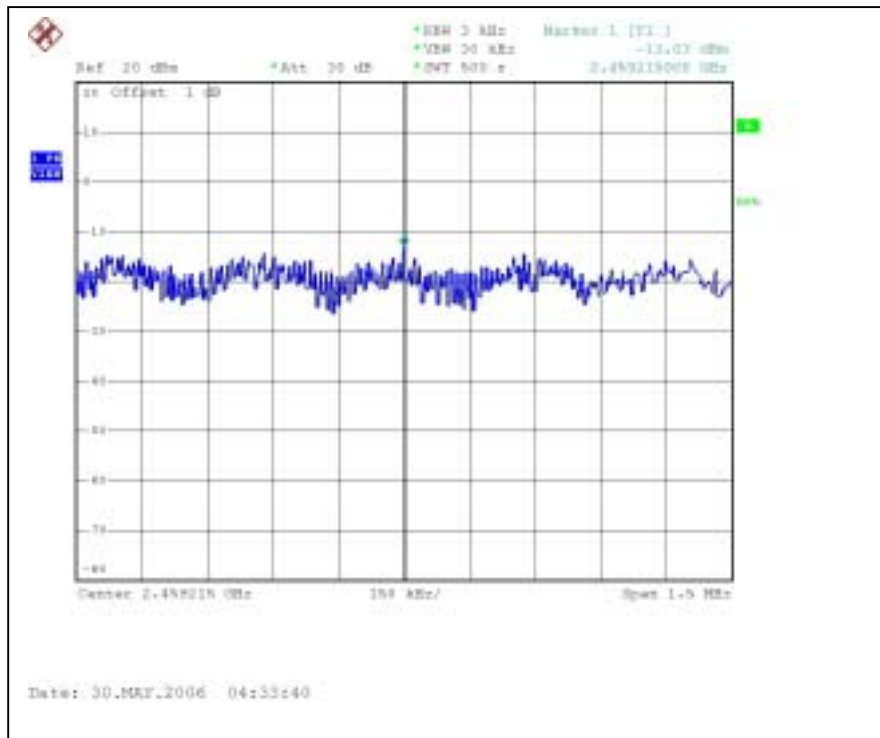



## 4.6 CONDUCTED EMISSION AND BAND EDGES MEASUREMENT

### 4.6.1 LIMITS OF CONDUCTED EMISSION AND BAND EDGES MEASUREMENT

Below -20dB of the highest emission level of operating band (in 100KHz Resolution Bandwidth).

### 4.6.2 TEST INSTRUMENTS

Description & Manufacturer	Model No.	Serial No.	Calibrated Until
R&S SPECTRUM ANALYZER	FSP40	100036	Nov. 23, 2006

**NOTE:**

- 1.The measurement uncertainty is less than +/- 2.6dB, which is calculated as per the NAMAS document NIS81.
- 2.The calibration interval of the above test instruments is 12 months and the calibrations are traceable to NML/ROC and NIST/USA.

### 4.6.3 TEST PROCEDURE

The transmitter output was connected to the spectrum analyzer via a low lose cable. Set both RBW and VBW of spectrum analyzer to 100kHz with suitable frequency span including 100 MHz bandwidth from band edge. The band edges was measured and recorded.

The spectrum plots (RBW = VBW = 100kHz) are attached on the following pages.

### 4.6.4 DEVIATION FROM TEST STANDARD

No deviation

### 4.6.5 EUT OPERATING CONDITION

Same as Item 4.3.6



#### 4.6.6 TEST RESULTS

The spectrum plots are attached on the following 12 images. D1 line indicates the highest level, and D2 line indicates the 20dB offset below D1. It shows compliance with the requirement in part 15.247(d).

**802.11b DSSS MODULATION:  
CH1**

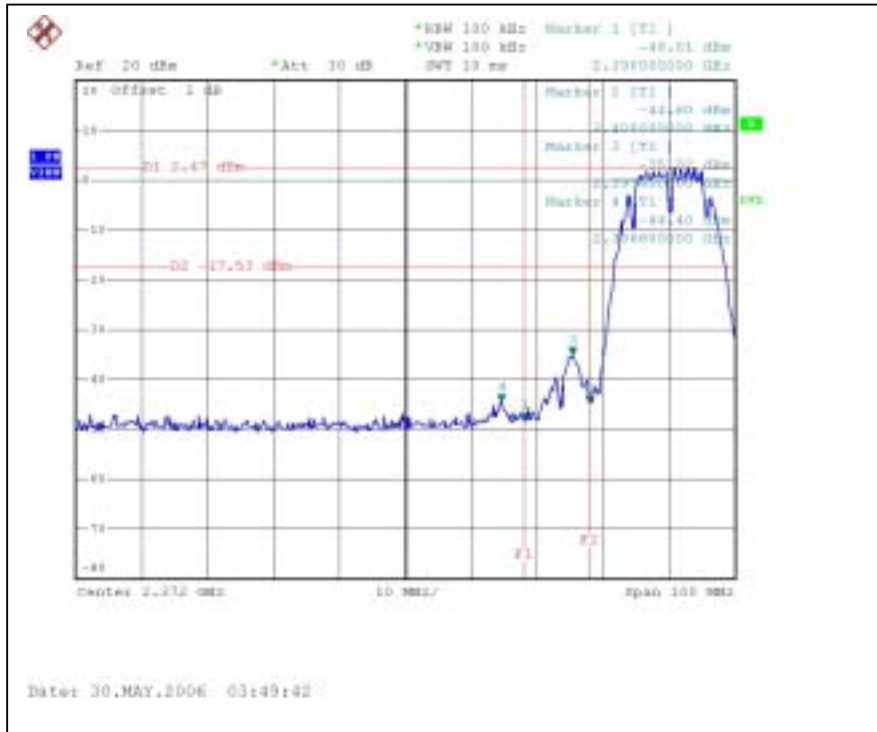

**CH11**

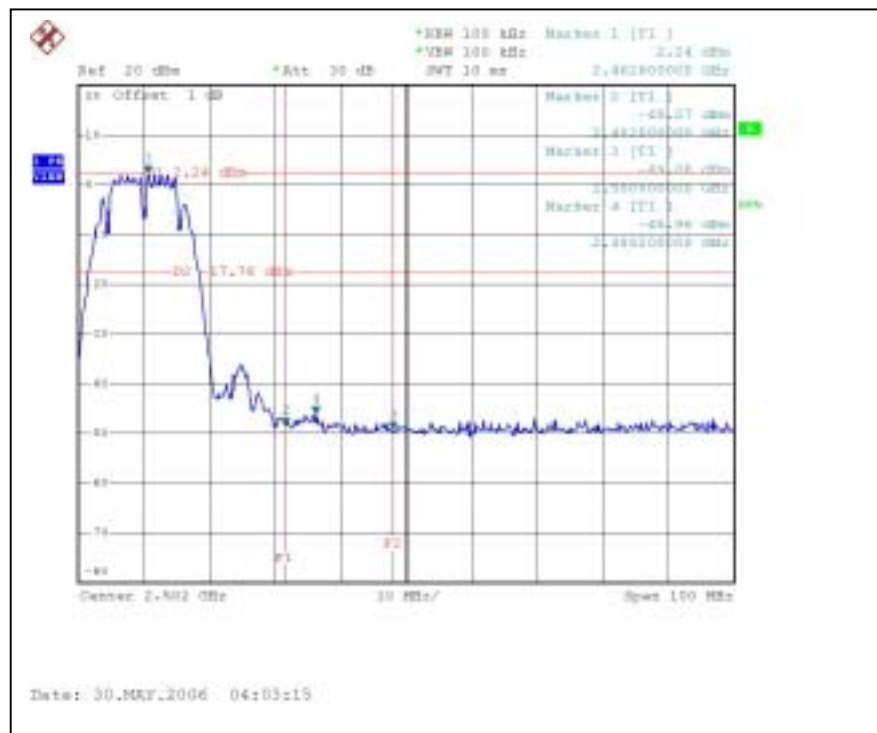

CH1

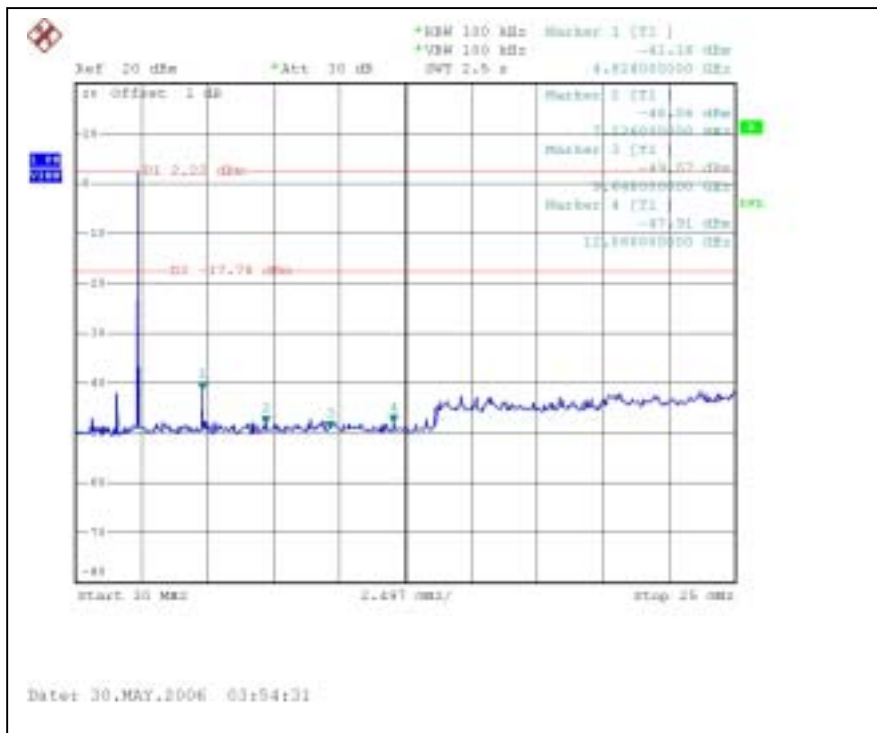

CH11

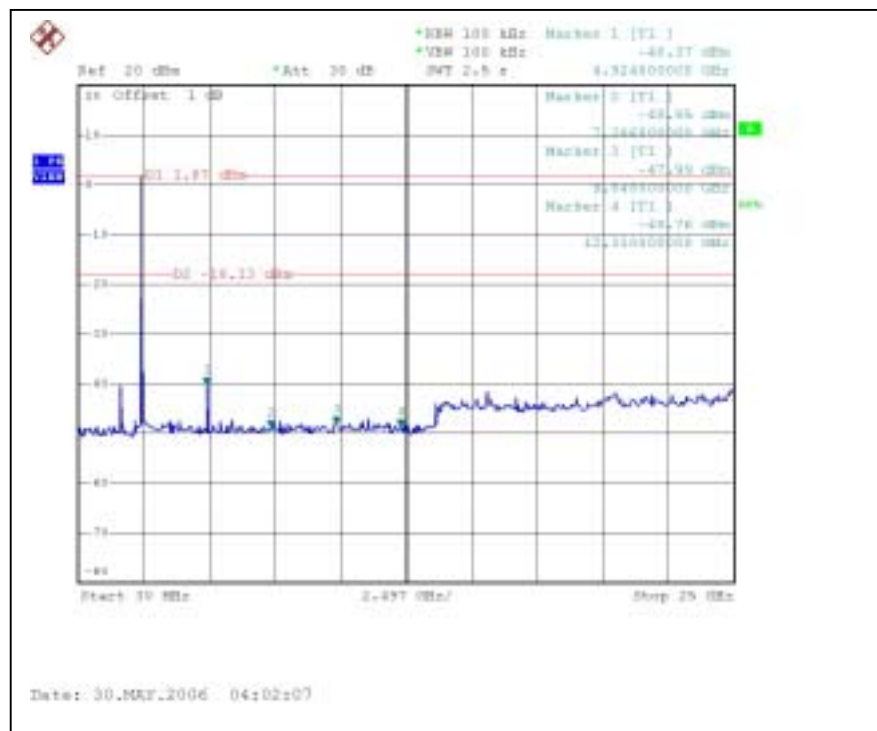

### 802.11g OFDM MODULATION: CH1

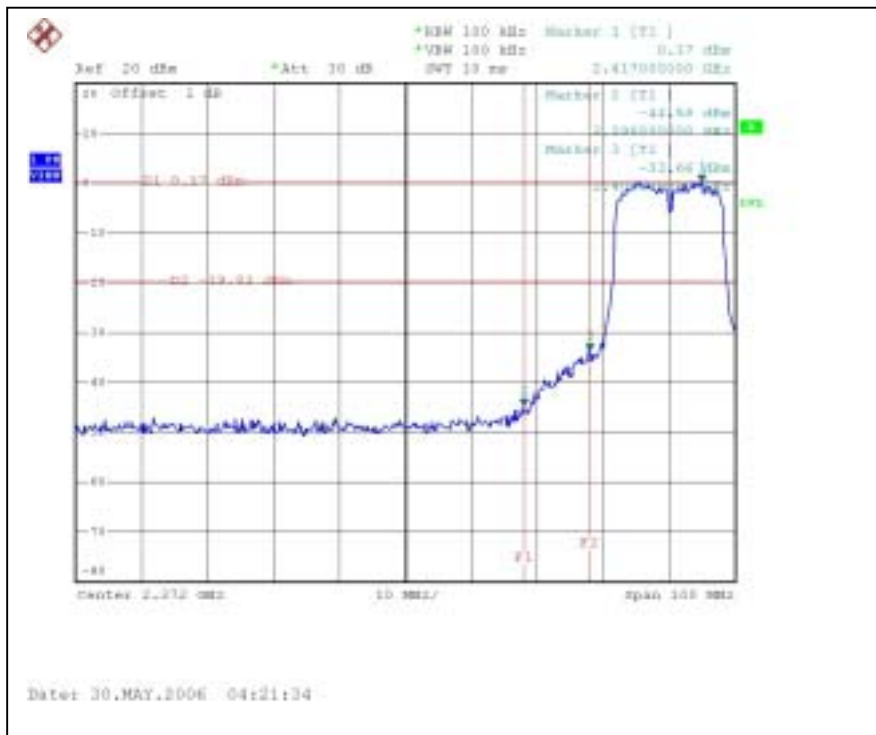

CH11

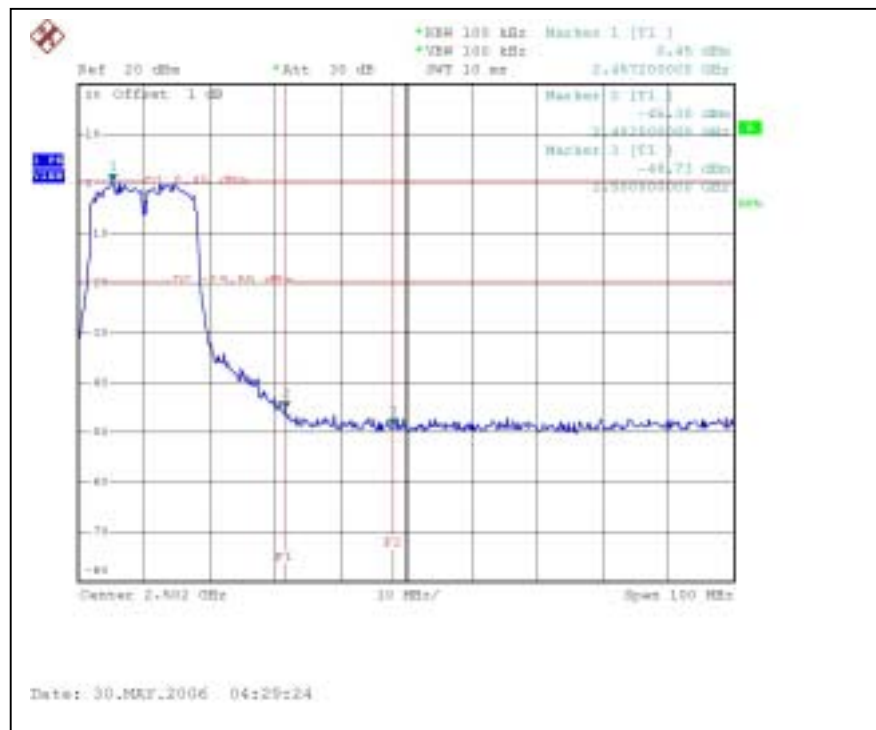



CH1

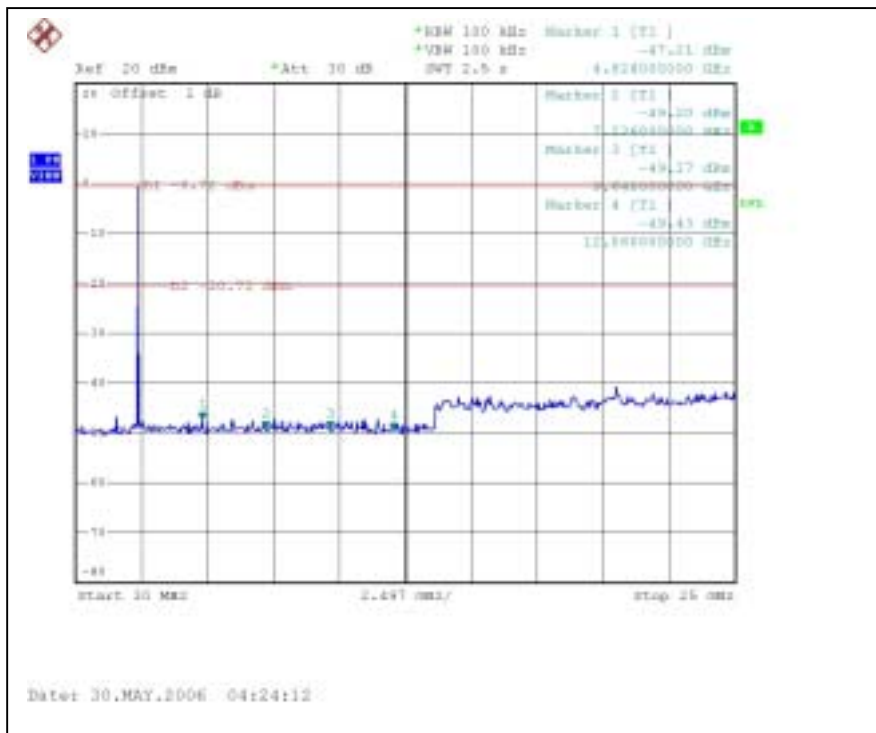

CH11

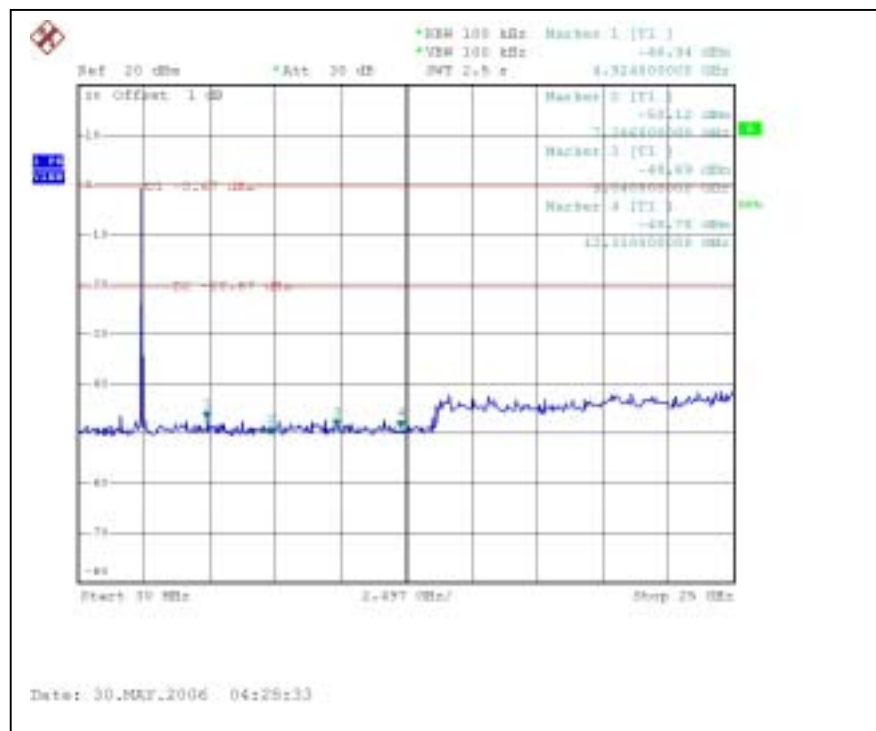



## **4.7 ANTENNA REQUIREMENT**

### **4.7.1 STANDARD APPLICABLE**

For intentional device, according to FCC 47 CFR Section 15.203, an intentional radiator shall be designed to ensure that no antenna other than that furnished by the responsible party shall be used with the device.

And according to FCC 47 CFR Section 15.247 (b), if transmitting antennas of directional gain greater than 6dBi are used, the power shall be reduced by the amount in dB that the directional gain of the antenna exceeds 6dBi.

### **4.7.2 ANTENNA CONNECTED CONSTRUCTION**

The antenna used in this product is Dipole antenna with Reverse SMA connector. The maximum Gain of the antenna is 4dBi.

## 5 PHOTOGRAPHS OF THE TEST CONFIGURATION CONDUCTED EMISSION TEST



### RADIATED EMISSION TEST (Model : SW1001-WgN1)



### RADIATED EMISSION TEST (Model : SW2001-WgN1)



**RADIATED EMISSION TEST (Model : SW5001-WgN1)**





## 6 INFORMATION ON THE TESTING LABORATORIES

We, ADT Corp., were founded in 1988 to provide our best service in EMC, Radio, Telecom and Safety consultation. Our laboratories are accredited and approved by the following approval agencies according to ISO/IEC 17025:

<b>USA</b>	FCC, UL, A2LA
<b>Germany</b>	TUV Rheinland
<b>Japan</b>	VCCI
<b>Norway</b>	NEMKO
<b>Canada</b>	INDUSTRY CANADA, CSA
<b>R.O.C.</b>	CNLA, BSMI, DGT
<b>Netherlands</b>	Telefication
<b>Singapore</b>	PSB, GOST-ASIA (MOU)
<b>Russia</b>	CERTIS (MOU)

Copies of accreditation certificates of our laboratories obtained from approval agencies can be downloaded from our web site: [www.adt.com.tw/index.5/phtml](http://www.adt.com.tw/index.5/phtml).

If you have any comments, please feel free to contact us at the following:

**Linko EMC/RF Lab:**

Tel: 886-2-26052180

Fax: 886-2-26052943

**Hsin Chu EMC/RF Lab:**

Tel: 886-3-5935343

Fax: 886-3-5935342

**Hwa Ya EMC/RF/Safety/Telecom Lab:**

Tel: 886-3-3183232

Fax: 886-3-3185050

**Email:** [service@adt.com.tw](mailto:service@adt.com.tw)

**Web Site:** [www.adt.com.tw](http://www.adt.com.tw)

The address and road map of all our labs can be found in our web site also.



## **APPENDIX-A**

### **MODIFICATIONS RECORDERS FOR ENGINEERING CHANGES TO THE EUT BY THE LAB**

No any modifications are made to the EUT by the lab during the test.