



RADIO TEST REPORT

FCC ID : RPV-AWR5805P
Equipment : Industrial Wireless Router
Brand Name : Atop
Model Name : AWR5805P/AWR5805
Applicant : Atop Technologies, Inc.
1F, No. 30 R&D Rd. II, Science-Based Industrial
Park, Hsinchu 30076, Tawian , R.O.C
Manufacturer : Atop Technologies, Inc.
1F, No. 30 R&D Rd. II, Science-Based Industrial
Park, Hsinchu 30076, Tawian , R.O.C
Standard : 47 CFR FCC Part 15.407

The product was received on Oct. 29, 2021, and testing was started from Dec. 16, 2021 and completed on Nov. 02, 2022. We, Sporton International Inc. Hsinchu Laboratory, would like to declare that the tested sample has been evaluated in accordance with the procedures given in ANSI C63.10-2013 and shown compliance with the applicable technical standards.

The test results in this report apply exclusively to the tested model / sample. Without written approval of Sporton International Inc. Hsinchu Laboratory, the test report shall not be reproduced except in full.



Approved by: Sam Chen

Sporton International Inc. Hsinchu Laboratory
No.8, Ln. 724, Bo'ai St., Zhubei City, Hsinchu County 302010, Taiwan (R.O.C.)



Table of Contents

History of this test report.....3

Summary of Test Result.....4

1 General Description5

1.1 Information.....5

1.2 Applicable Standards8

1.3 Testing Location Information8

1.4 Measurement Uncertainty8

2 Test Configuration of EUT9

2.1 Test Channel Mode9

2.2 The Worst Case Measurement Configuration10

2.3 EUT Operation during Test12

2.4 Accessories12

2.5 Support Equipment.....12

2.6 Test Setup Diagram13

3 Transmitter Test Result16

3.1 AC Power-line Conducted Emissions16

3.2 Emission Bandwidth18

3.3 Maximum Output Power19

3.4 Power Spectral Density21

3.5 Unwanted Emissions.....24

4 Test Equipment and Calibration Data28

Appendix A. Test Results of AC Power-line Conducted Emissions

Appendix B. Test Results of Emission Bandwidth

Appendix C. Test Results of Maximum Output Power

Appendix D. Test Results of Power Spectral Density

Appendix E. Test Results of Unwanted Emissions

Appendix F. Test Results of Radiated Emission Co-location

Appendix G. Test Photos

Photographs of EUT v01



Summary of Test Result

Report Clause	Ref Std. Clause	Test Items	Result (PASS/FAIL)	Remark
1.1.2	15.203	Antenna Requirement	PASS	-
3.1	15.207	AC Power-line Conducted Emissions	PASS	-
3.2	15.407(a)	Emission Bandwidth	PASS	-
3.3	15.407(a)	Maximum Output Power	PASS	-
3.4	15.407(a)	Power Spectral Density	PASS	-
3.5	15.407(b)	Unwanted Emissions	PASS	-

Note: Reference to Sporton Project No.: 192332.

Declaration of Conformity:

1. The test results with all measurement uncertainty excluded are presented in accordance with the regulation limits or requirements declared by manufacturers. It's means measurement values may risk exceeding the limit of regulation standards, if measurement uncertainty is include in test results.
2. The measurement uncertainty please refer to report "Measurement Uncertainty".

Comments and Explanations:

The declared of product specification for EUT presented in the report are provided by the manufacturer, and the manufacturer takes all the responsibilities for the accuracy of product specification.

Reviewed by: Sam Chen

Report Producer: Sophia Shiung



1 General Description

1.1 Information

1.1.1 RF General Information

Frequency Range (MHz)	IEEE Std. 802.11	Ch. Frequency (MHz)	Channel Number
5150-5250	a, n (HT20), ac (VHT20)	5180-5240	36-48 [4]
5725-5850		5745-5825	149-165 [5]
5150-5250	n (HT40), ac (VHT40)	5190-5230	38-46 [2]
5725-5850		5755-5795	151-159 [2]
5150-5250	ac (VHT80)	5210	42 [1]
5725-5850		5775	155 [1]

Band	Mode	BWch (MHz)	Nant
5.15-5.25GHz	802.11a	20	2TX
5.15-5.25GHz	802.11n HT20	20	2TX
5.15-5.25GHz	802.11ac VHT20	20	2TX
5.15-5.25GHz	802.11n HT40	40	2TX
5.15-5.25GHz	802.11ac VHT40	40	2TX
5.15-5.25GHz	802.11ac VHT80	80	2TX
5.725-5.85GHz	802.11a	20	2TX
5.725-5.85GHz	802.11n HT20	20	2TX
5.725-5.85GHz	802.11ac VHT20	20	2TX
5.725-5.85GHz	802.11n HT40	40	2TX
5.725-5.85GHz	802.11ac VHT40	40	2TX
5.725-5.85GHz	802.11ac VHT80	80	2TX

Note:

- ♦ 11a, HT20 and HT40 use a combination of OFDM-BPSK, QPSK, 16QAM, 64QAM modulation.
- ♦ VHT20, VHT40, VHT80 use a combination of OFDM-BPSK, QPSK, 16QAM, 64QAM, 256QAM, modulation.
- ♦ BWch is the nominal channel bandwidth.



1.1.2 Antenna Information

Ant.	Port		Brand	Model Name	Antenna Type	Connector	Gain (dBi)	
	2.4GHz	5GHz					2.4GHz	5GHz
1	1	1	PSA	RFDPA141300SBLB301	Dipole	Reversed-SMA	4.35	6.59
2	2	2	PSA	RFDPA141300SBLB301	Dipole	Reversed-SMA	4.35	6.59

Note 1: The above information was declared by manufacturer.

Note 2: Directional gain information

Type	Maximum Output Power	Power Spectral Density
Non-BF	Directional gain = Max.gain + array gain. For power measurements on IEEE 802.11 devices Array Gain = 0 dB (i.e., no array gain) for N ANT ≤ 4	$DirectionalGain = 10 \cdot \log \left[\frac{\sum_{j=1}^{N_{SS}} \left\{ \sum_{k=1}^{N_{ANT}} g_{j,k} \right\}^2}{N_{ANT}} \right]$

Ex.

Directional Gain (NSS1) formula :

$$DirectionalGain = 10 \cdot \log \left[\frac{\sum_{j=1}^{N_{SS}} \left\{ \sum_{k=1}^{N_{ANT}} g_{j,k} \right\}^2}{N_{ANT}} \right]$$

$$N_{SS1}(g1,1) = 10^{G1/20} ; N_{SS1}(g1,2) = 10^{G2/20} \quad g_{j,k} = (N_{SS1}(g1,1) + N_{SS1}(g1,2))$$

$$DG = 10 \log[(N_{SS1}(g1,1) + N_{SS1}(g1,2) / N_{ANT}] => 10 \log[(10^{G1/20} + 10^{G2/20})^2 / N_{ANT}]$$

Where ;

G1 = Ant 1 Gain ; G2 = Ant 2 Gain

2.4GHz DG = 7.36 dBi

5 GHz U-NII-1 DG = 9.60 dBi

5 GHz U-NII-3 DG = 9.60 dBi

Note 3: For 2.4GHz function:

For IEEE 802.11 b/g/n (2TX/2RX):

Port 1 and Port 2 can be used as transmitting/receiving antenna.

Port 1 and Port 2 could transmit/receive simultaneously.

For 5GHz function:

For IEEE 802.11a/n/ac (2TX/2RX):

Port 1 and Port 2 can be used as transmitting/receiving antenna.

Port 1 and Port 2 could transmit/receive simultaneously.



1.1.3 Mode Test Duty Cycle

Mode		DC	T(s)	VBW(Hz) ≥ 1/T
802.11a	0.968	0.14	2.06m	1k
802.11ac VHT20	0.988	0.05	n/a (DC>=0.98)	n/a (DC>=0.98)
802.11ac VHT40	0.976	0.11	2.44m	1k
802.11ac VHT80	0.946	0.24	1.15m	1k

Note:

- ◆ DC is Duty Cycle.
- ◆ DCF is Duty Cycle Factor.

1.1.4 EUT Operational Condition

EUT Power Type	For EUT 1 (AWR5805P): From DC internal power supply or PoE			
	For EUT 2 (AWR5805): From DC internal power supply			
Beamforming Function	<input type="checkbox"/>	With beamforming	<input checked="" type="checkbox"/>	Without beamforming
Function	<input type="checkbox"/>	Outdoor P2M	<input checked="" type="checkbox"/>	Indoor P2M
	<input type="checkbox"/>	Fixed P2P	<input type="checkbox"/>	Client
	<input checked="" type="checkbox"/>	Point-to-multipoint	<input type="checkbox"/>	Point-to-point
	Test Software Version QSPR(version 5.0-00188)			

Note: The above information was declared by manufacturer.

1.1.5 Table for Multiple Listing

The difference for each model is show as below:

EUT	Model Name	PoE Function
1	AWR5805P	V
2	AWR5805	X

Note 1: EUT 1 had been selected to test AC power-line conducted emissions, Unwanted Emissions (below 1GHz) and Radiated Emission Co-location.

Note 2: EUT 2 had been selected to test Emission Bandwidth, Maximum Output Power, Power Spectral Density and Unwanted Emissions (above 1GHz).

Note 3: The above information was declared by manufacturer.



1.2 Applicable Standards

According to the specifications of the manufacturer, the EUT must comply with the requirements of the following standards:

- ♦ 47 CFR FCC Part 15
- ♦ ANSI C63.10-2013
- ♦ FCC KDB 789033 D02 v02r01

The following reference test guidance is not within the scope of accreditation of TAF.

- ♦ FCC KDB 662911 D01 v02r01
- ♦ FCC KDB 412172 D01 v01r01
- ♦ FCC KDB 414788 D01 v01r01

1.3 Testing Location Information

Testing Location Information	
Test Lab. : Sporton International Inc. Hsinchu Laboratory	
Hsinchu (TAF: 3787)	ADD: No.8, Ln. 724, Bo'ai St., Zhubei City, Hsinchu County 302010, Taiwan (R.O.C.) TEL: 886-3-656-9065 FAX: 886-3-656-9085 Test site Designation No. TW3787 with FCC. Conformity Assessment Body Identifier (CABID) TW3787 with ISED.

Test Condition	Test Site No.	Test Engineer	Test Environment (°C / %)	Test Date
RF Conducted	TH01-CB	Lucas Huang	19.2~20.4 / 52~55	Dec. 20, 2021
Radiated below 1GHz	03CH05-CB	Wendy Hsu	22.8~23.8 / 57~60	Oct. 31, 2022
Radiated above 1GHz	03CH02-CB	Stim Sung	24.2-26.1 / 55-58	Dec. 16, 2021~ Jan. 07, 2022
Radiated Co-location	03CH05-CB	Wendy Hsu	22.8~23.8 / 57~60	Oct. 31, 2022
AC Conduction	CO01-CB	Tim Chen	21~22 / 51~53	Nov. 02, 2022

1.4 Measurement Uncertainty

ISO/IEC 17025 requires that an estimate of the measurement uncertainties associated with the emissions test results be included in the report. The measurement uncertainties given below are based on a 95% confidence level (based on a coverage factor (k=2))

Test Items	Uncertainty	Remark
Conducted Emission (150kHz ~ 30MHz)	3.4 dB	Confidence levels of 95%
Radiated Emission (9kHz ~ 30MHz)	3.4 dB	Confidence levels of 95%
Radiated Emission (30MHz ~ 1,000MHz)	5.6 dB	Confidence levels of 95%
Radiated Emission (1GHz ~ 18GHz)	4.7 dB	Confidence levels of 95%_before Jan. 01, 2022
Radiated Emission (1GHz ~ 18GHz)	5.2 dB	Confidence levels of 95%_After Jan. 01, 2022
Radiated Emission (18GHz ~ 40GHz)	4.2 dB	Confidence levels of 95%_before Jan. 01, 2022
Radiated Emission (18GHz ~ 40GHz)	4.7 dB	Confidence levels of 95%_After Jan. 01, 2022
Conducted Emission	2.5 dB	Confidence levels of 95%
Output Power Measurement	1.3 dB	Confidence levels of 95%
Power Density Measurement	2.5 dB	Confidence levels of 95%
Bandwidth Measurement	0.9%	Confidence levels of 95%



2 Test Configuration of EUT

2.1 Test Channel Mode

Mode	Power Setting
802.11a_Nss1,(6Mbps)_2TX	-
5180MHz	21
5200MHz	24
5240MHz	24
5745MHz	22
5785MHz	22.5
5825MHz	22.5
802.11ac VHT20_Nss1,(MCS0)_2TX	-
5180MHz	21
5200MHz	24
5240MHz	23.5
5745MHz	22.5
5785MHz	22.5
5825MHz	23
802.11ac VHT40_Nss1,(MCS0)_2TX	-
5190MHz	19.5
5230MHz	23
5755MHz	23
5795MHz	25
802.11ac VHT80_Nss1,(MCS0)_2TX	-
5210MHz	16.5
5775MHz	21.5

Note:

- ♦ Evaluated VHT20/VHT40/VHT80 mode only due to the similar modulation.
The power setting of HT20/HT40 mode are the same or lower than VHT20/VHT40.



2.2 The Worst Case Measurement Configuration

The Worst Case Mode for Following Conformance Tests	
Tests Item	AC power-line conducted emissions
Condition	AC power-line conducted measurement for line and neutral Test Voltage: 120Vac / 60Hz
Operating Mode	CTX
1	EUT 1_WLAN 2.4GHz + DC internal power supply
2	EUT 1_WLAN 5GHz + DC internal power supply
Mode 1 has been evaluated to be the worst case among Mode 1~2, thus measurement for Mode 3 will follow this same test mode.	
3	EUT 1_WLAN 2.4GHz + PoE
Mode 1 generated the worst test result, so it was recorded in this report.	

The Worst Case Mode for Following Conformance Tests	
Tests Item	Emission Bandwidth Maximum Output Power Power Spectral Density
Test Condition	Conducted measurement at transmit chains
Operating Mode	CTX
1	EUT 2



The Worst Case Mode for Following Conformance Tests	
Tests Item	Unwanted Emissions
Test Condition	Radiated measurement If EUT consist of multiple antenna assembly (multiple antenna are used in EUT regardless of spatial multiplexing MIMO configuration), the radiated test should be performed with highest antenna gain of each antenna type.
Operating Mode < 1GHz	CTX
	The EUT was performed at X axis, Y axis and Z axis position for Unwanted Emissions (above 1GHz) test. The worst case was found at "Y axis in WLAN 2.4GHz" and "Z axis in WLAN 5GHz." So the measurements will follow these same test configurations.
1	EUT 1 in Y axis_WLAN 2.4GHz + DC internal power supply
2	EUT 1 in Z axis_WLAN 5GHz + DC internal power supply
Mode 1 has been evaluated to be the worst case among Mode 1~2, thus measurement for Mode 3 will follow this same test mode.	
3	EUT 1 in Y axis_WLAN 2.4GHz + PoE
For operating, mode 3 is the worst case and it was recorded in this test report.	
Operating Mode > 1GHz	CTX
	After evaluation, EUT in Z axis was the worst case at Unwanted Emissions test, and it was tested and recorded in this report.
1	EUT 2 in Z axis_WLAN 5GHz + DC internal power supply

The Worst Case Mode for Following Conformance Tests	
Tests Item	Simultaneous Transmission Analysis - Radiated Emission Co-location
Test Condition	Radiated measurement
Operating Mode	Normal Link
1	EUT 1_WLAN 2.4GHz + WLAN 5GHz
Refer to Appendix F for Radiated Emission Co-location.	

The Worst Case Mode for Following Conformance Tests	
Tests Item	Simultaneous Transmission Analysis - Co-location RF Exposure Evaluation
Operating Mode	
1	EUT 2_WLAN 2.4GHz + WLAN 5GHz
Refer to Sporton Test Report No.: FA282309 for Co-location RF Exposure Evaluation.	



2.3 EUT Operation during Test

For CTX Mode:

The EUT was programmed to be in continuously transmitting mode.

For Normal Link Mode:

During the test, the EUT operation to normal function.

2.4 Accessories

DC jack*1

2.5 Support Equipment

For AC Conduction:

Support Equipment				
No.	Equipment	Brand Name	Model Name	FCC ID
A	Power Supply	Advanced	LPS-305	N/A
B	NB	DELL	E6430	N/A

For Radiated (above 1GHz) and RF Conducted:

Support Equipment				
No.	Equipment	Brand Name	Model Name	FCC ID
A	NB	DELL	E4300	N/A
B	Power Supply	Advanced	LPS-305	N/A

For Radiated (other tests):

Support Equipment				
No.	Equipment	Brand Name	Model Name	FCC ID
A	PoE	Atop	IJG7001	N/A
B	NB	DELL	E4300	N/A

2.6 Test Setup Diagram

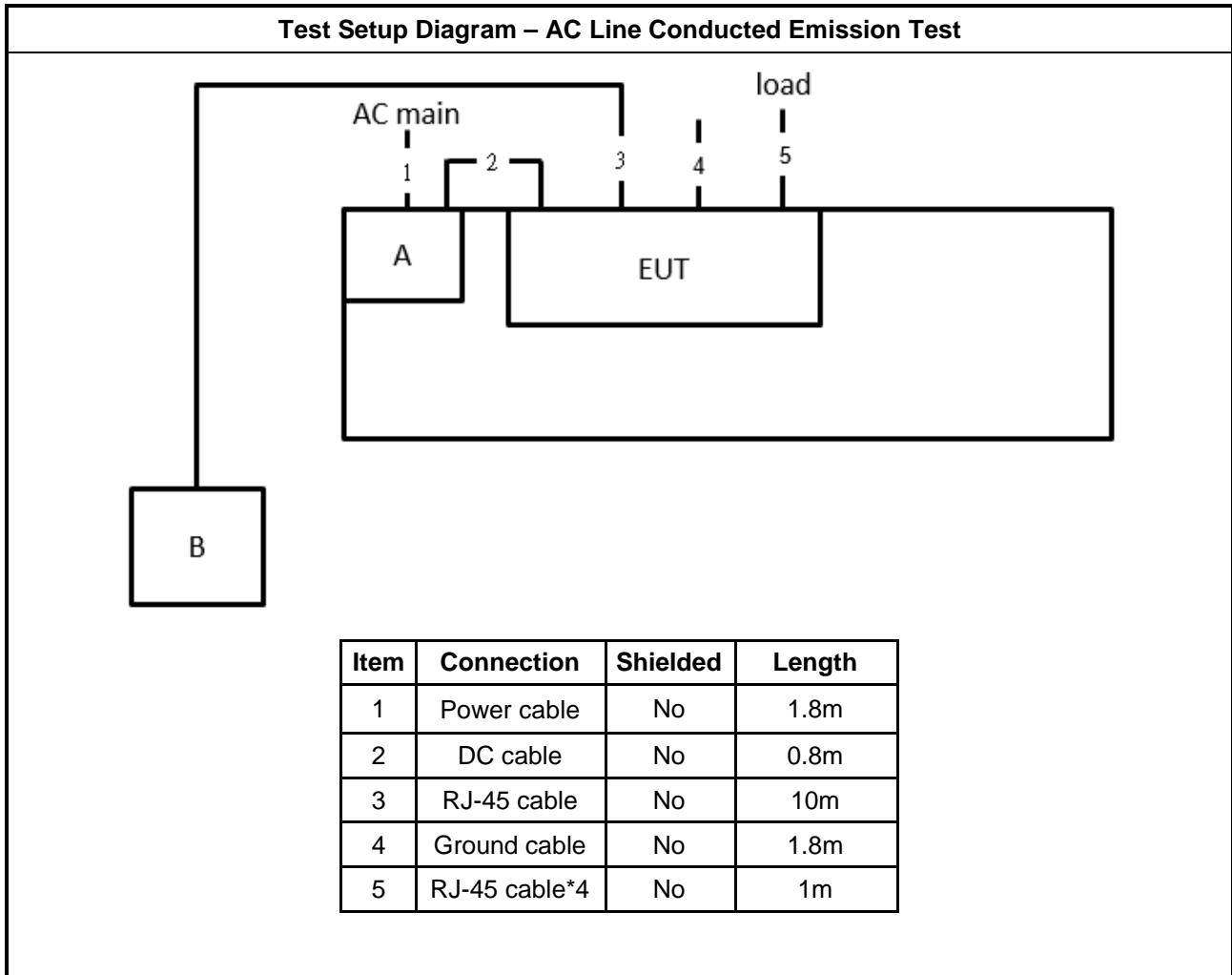

Test Setup Diagram - Radiated Test < 1GHz

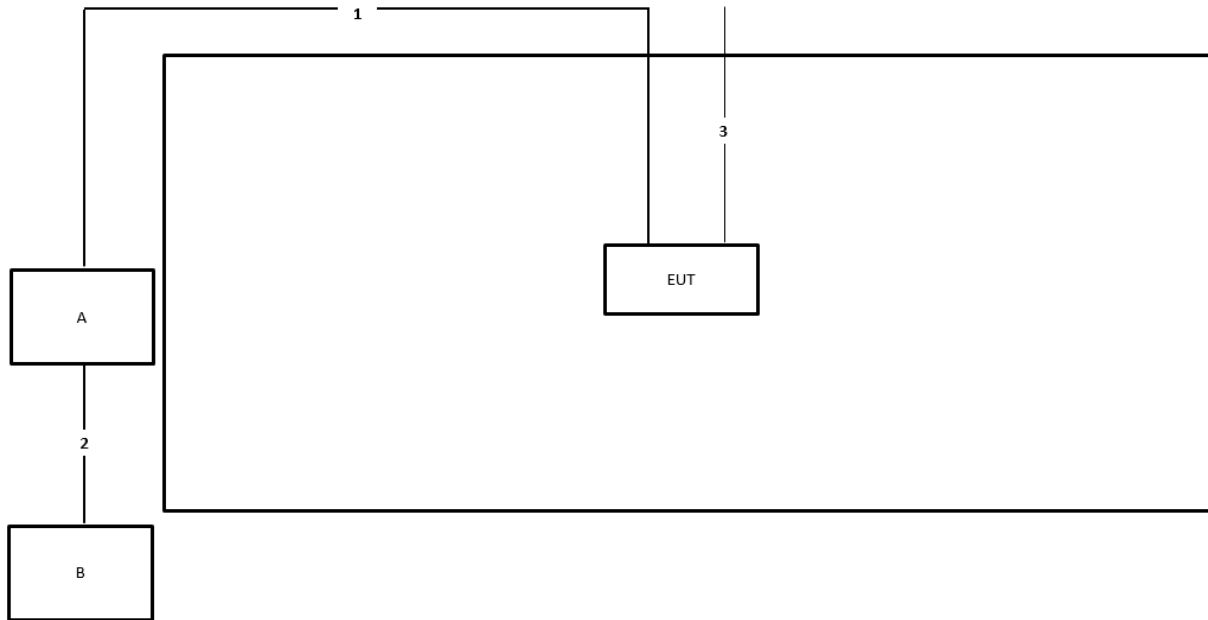

Item	Connection	Shielded	Length
1	RJ-45 cable	No	10m
2	RJ-45 cable	No	1.5m
3	Crocodile clip cable	No	1.5m

Test Setup Diagram - Radiated Test > 1GHz

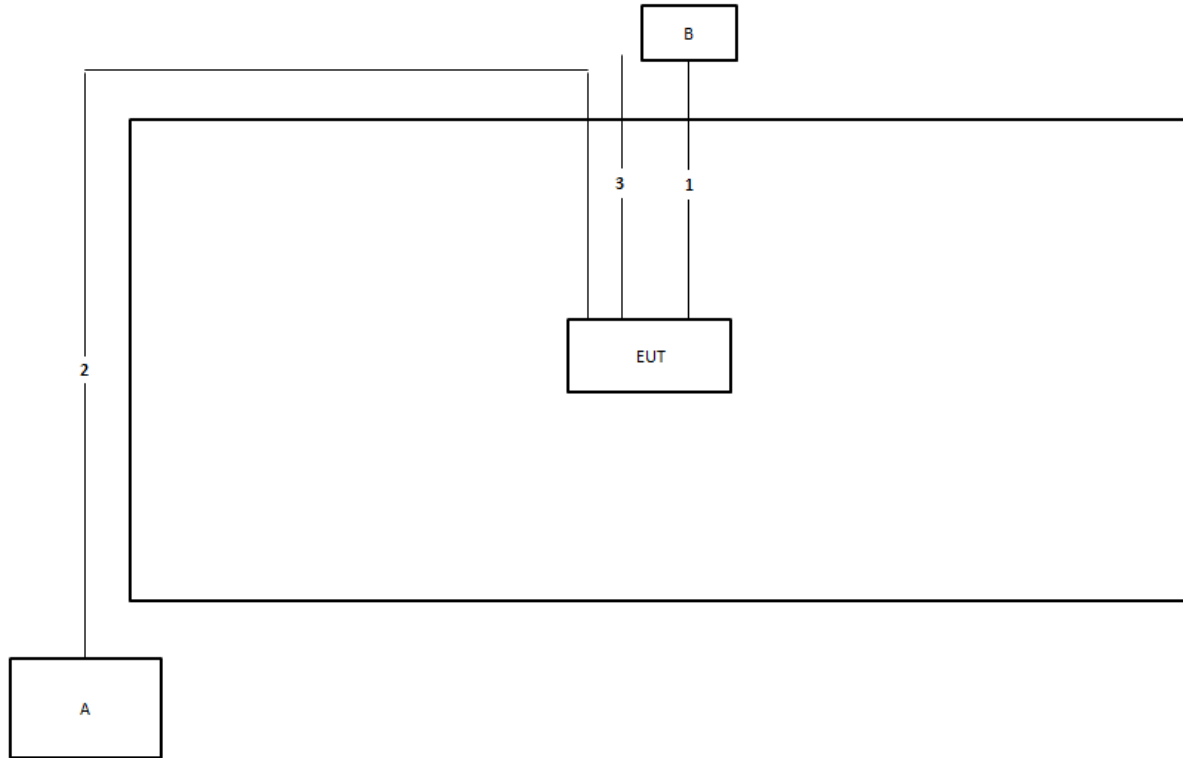

Item	Connection	Shielded	Length
1	Crocodile cable	No	1.1m
2	RJ-45 cable	No	10m
3	GND cable	No	2.5m



3 Transmitter Test Result

3.1 AC Power-line Conducted Emissions

3.1.1 AC Power-line Conducted Emissions Limit

AC Power-line Conducted Emissions Limit		
Frequency Emission (MHz)	Quasi-Peak	Average
0.15-0.5	66 - 56 *	56 - 46 *
0.5-5	56	46
5-30	60	50

Note 1: * Decreases with the logarithm of the frequency.

3.1.2 Measuring Instruments

Refer a test equipment and calibration data table in this test report.

3.1.3 Test Procedures

Test Method
<input checked="" type="checkbox"/> Refer as ANSI C63.10-2013, clause 6.2 for AC power-line conducted emissions.

3.1.4 Test Setup

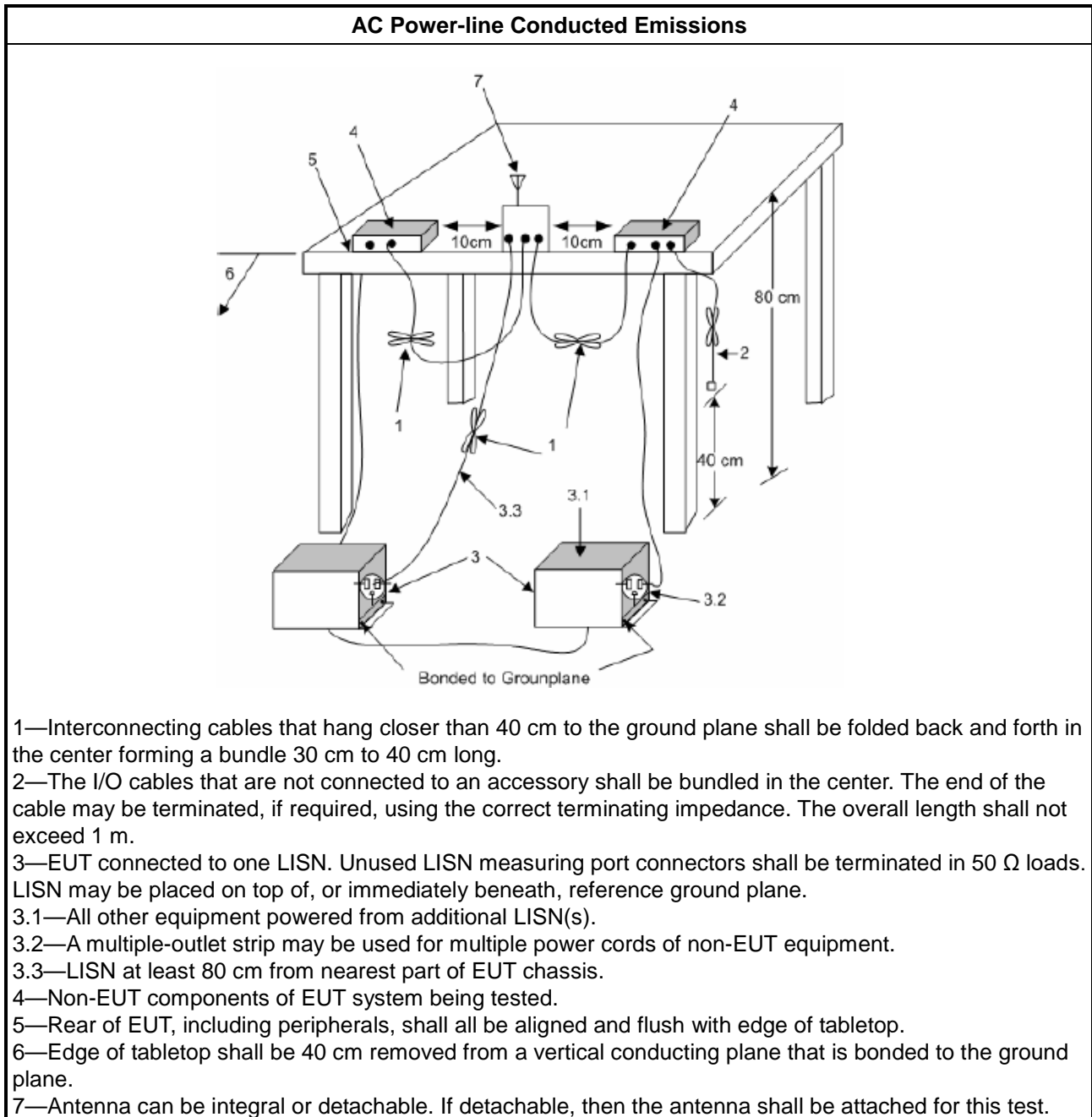

3.1.5 Measurement Results Calculation

The measured Level is calculated using:

- a. Corrected Reading: LISN Factor (LISN) + Attenuator (AT/AUX) + Cable Loss (CL) + Read Level (Raw) = Level
- b. Margin = -Limit + Level

3.1.6 Test Result of AC Power-line Conducted Emissions

Refer as Appendix A

3.2 Emission Bandwidth

3.2.1 Emission Bandwidth Limit

Emission Bandwidth Limit	
UNII Devices	
<input checked="" type="checkbox"/>	For the 5.15-5.25 GHz band, N/A
<input type="checkbox"/>	For the 5.25-5.35 GHz band, the maximum conducted output power shall not exceed the lesser of 250 mW or $11 \text{ dBm} + 10 \log B$, where B is the 26 dB emission bandwidth in MHz.
<input type="checkbox"/>	For the 5.47-5.725 GHz band, the maximum conducted output power shall not exceed the lesser of 250 mW or $11 \text{ dBm} + 10 \log B$, where B is the 26 dB emission bandwidth in MHz.
<input checked="" type="checkbox"/>	For the 5.725-5.85 GHz band, 26 dB emission bandwidth ,N/A. 6 dB emission bandwidth $\geq 500\text{kHz}$.
LE-LAN Devices	
<input type="checkbox"/>	For the band 5.15-5.25 GHz, the maximum e.i.r.p. shall not exceed 200 mW or $10 + 10 \log B$, dBm, whichever power is less. B is the 99% emission bandwidth in MHz.
<input type="checkbox"/>	For the 5.25-5.35 GHz band, the maximum e.i.r.p. shall not exceed 1.0 W or $17 + 10 \log B$, dBm, whichever power is less. B is the 99% emission bandwidth in MHz
<input type="checkbox"/>	For the 5.47-5.6 GHz band and 5.65-5.725 GHz band, the maximum e.i.r.p. shall not exceed 1.0 W or $17 + 10 \log B$, dBm, whichever power is less. B is the 99% emission bandwidth in MHz
<input type="checkbox"/>	For the 5.725-5.85 GHz band, 6 dB emission bandwidth $\geq 500\text{kHz}$.

3.2.2 Measuring Instruments

Refer a test equipment and calibration data table in this test report.

3.2.3 Test Procedures

Test Method							
<ul style="list-style-type: none"> ▪ For the emission bandwidth shall be measured using one of the options below: <table border="1" style="width: 100%; border-collapse: collapse;"> <tr> <td style="width: 30px;"><input checked="" type="checkbox"/></td> <td>Refer as FCC KDB 789033 D02, clause C for EBW and clause D for OBW measurement.</td> </tr> <tr> <td><input type="checkbox"/></td> <td>Refer as ANSI C63.10, clause 6.9.1 for occupied bandwidth testing.</td> </tr> <tr> <td><input type="checkbox"/></td> <td>Refer as IC RSS-Gen, clause 4.6 for bandwidth testing.</td> </tr> </table> 		<input checked="" type="checkbox"/>	Refer as FCC KDB 789033 D02, clause C for EBW and clause D for OBW measurement.	<input type="checkbox"/>	Refer as ANSI C63.10, clause 6.9.1 for occupied bandwidth testing.	<input type="checkbox"/>	Refer as IC RSS-Gen, clause 4.6 for bandwidth testing.
<input checked="" type="checkbox"/>	Refer as FCC KDB 789033 D02, clause C for EBW and clause D for OBW measurement.						
<input type="checkbox"/>	Refer as ANSI C63.10, clause 6.9.1 for occupied bandwidth testing.						
<input type="checkbox"/>	Refer as IC RSS-Gen, clause 4.6 for bandwidth testing.						

3.2.4 Test Setup

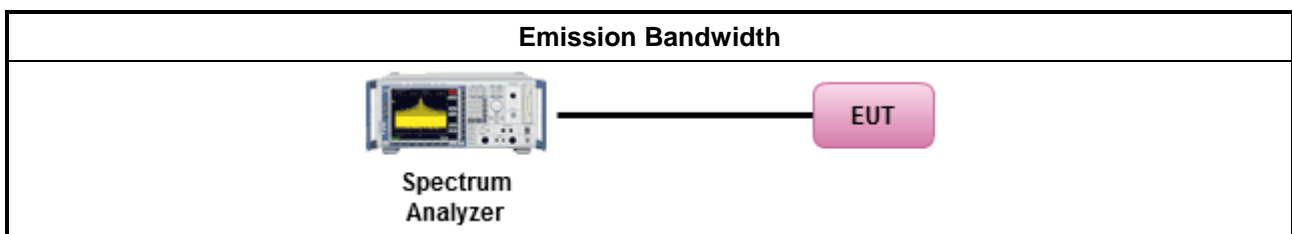

3.2.5 Test Result of Emission Bandwidth

Refer as Appendix B



3.3 Maximum Output Power

3.3.1 Limit

Maximum Output Power Limit	
UNII Devices	
<input checked="" type="checkbox"/> For the 5.15-5.25 GHz band:	
	<ul style="list-style-type: none"> ▪ Outdoor AP: the maximum conducted output power (P_{Out}) shall not exceed the lesser of 1 W. If $G_{TX} > 6$ dBi, then $P_{Out} = 30 - (G_{TX} - 6)$. e.i.r.p. at any elevation angle above 30 degrees $\leq 125mW$ [21dBm] ▪ Indoor AP: the maximum conducted output power (P_{Out}) shall not exceed the lesser of 1 W. If $G_{TX} > 6$ dBi, then $P_{Out} = 30 - (G_{TX} - 6)$ ▪ Point-to-point AP: the maximum conducted output power (P_{Out}) shall not exceed the lesser of 1 W. If $G_{TX} > 23$ dBi, then $P_{Out} = 30 - (G_{TX} - 23)$. ▪ Mobile or Portable Client: the maximum conducted output power (P_{Out}) shall not exceed the lesser of 250 mW. If $G_{TX} > 6$ dBi, then $P_{Out} = 24 - (G_{TX} - 6)$.
<input type="checkbox"/> For the 5.25-5.35 GHz band, the maximum conducted output power (P_{Out}) shall not exceed the lesser of 250 mW or $11 \text{ dBm} + 10 \log B$, where B is the 26 dB emission bandwidth in MHz. If $G_{TX} > 6$ dBi, then $P_{Out} = 24 - (G_{TX} - 6)$.	
<input type="checkbox"/> For the 5.47-5.725 GHz band, the maximum conducted output power (P_{Out}) shall not exceed the lesser of 250 mW or $11 \text{ dBm} + 10 \log B$, where B is the 26 dB emission bandwidth in MHz. If $G_{TX} > 6$ dBi, then $P_{Out} = 24 - (G_{TX} - 6)$.	
<input checked="" type="checkbox"/> For the 5.725-5.85 GHz band:	
	<ul style="list-style-type: none"> ▪ Point-to-multipoint systems (P2M): the maximum conducted output power (P_{Out}) shall not exceed the lesser of 1 W. If $G_{TX} > 6$ dBi, then $P_{Out} = 30 - (G_{TX} - 6)$. ▪ Point-to-point systems (P2P): the maximum conducted output power (P_{Out}) shall not exceed the lesser of 1 W.
LE-LAN Devices	
<input type="checkbox"/> For the 5.15-5.25 GHz band, the maximum e.i.r.p. shall not exceed 200 mW or $10 + 10 \log B$, dBm, whichever power is less. B is the 99% emission bandwidth in MHz.	
<input type="checkbox"/> For the 5.25-5.35 GHz band, the maximum e.i.r.p. shall not exceed 1.0 W or $17 + 10 \log B$, dBm, whichever power is less. B is the 99% emission bandwidth in MHz	
<input type="checkbox"/> For the 5.47-5.6 GHz band and 5.65-5.725 GHz band, the maximum e.i.r.p. shall not exceed 1.0 W or $17 + 10 \log B$, dBm, whichever power is less. B is the 99% emission bandwidth in MHz	
<input type="checkbox"/> For the 5.725-5.85 GHz band:	
	<ul style="list-style-type: none"> ▪ Point-to-multipoint systems (P2M): the maximum conducted output power (P_{Out}) shall not exceed the lesser of 1 W. If $G_{TX} > 6$ dBi, then $P_{Out} = 30 - (G_{TX} - 6)$. ▪ Point-to-point systems (P2P): the maximum conducted output power (P_{Out}) shall not exceed the lesser of 1 W.
P_{Out} = maximum conducted output power in dBm, G_{TX} = the maximum transmitting antenna directional gain in dBi.	

3.3.2 Measuring Instruments

Refer a test equipment and calibration data table in this test report.

3.3.3 Test Procedures

Test Method	
	Average over on/off periods with duty factor
<input type="checkbox"/>	Refer as FCC KDB 789033 D02, clause E Method SA-2 (spectral trace averaging).
<input type="checkbox"/>	Refer as FCC KDB 789033 D02, clause E Method SA-2 Alt. (RMS detection with slow sweep speed)
	Wideband RF power meter and average over on/off periods with duty factor
<input checked="" type="checkbox"/>	Refer as FCC KDB 789033 D02, clause E Method PM-G (using an RF average power meter).
<input checked="" type="checkbox"/>	For conducted measurement.
	<ul style="list-style-type: none"> If the EUT supports multiple transmit chains using options given below: Refer as FCC KDB 662911, In-band power measurements. Using the measure-and-sum approach, measured all transmit ports individually. Sum the power (in linear power units e.g., mW) of all ports for each individual sample and save them.
	<ul style="list-style-type: none"> If multiple transmit chains, EIRP calculation could be following as methods: $P_{total} = P_1 + P_2 + \dots + P_n$ (calculated in linear unit [mW] and transfer to log unit [dBm]) $EIRP_{total} = P_{total} + DG$
<input type="checkbox"/>	For radiated measurement.
	<ul style="list-style-type: none"> Refer as FCC KDB 789033 D02 clause II A.1.F "Antenna-port Conducted versus Radiated Testing" Refer as ANSI C63.10, clause 6.6 for radiated emissions above 1GHz. Refer as FCC KDB 412172 D01 clause 2.2 for EIRP calculation.

3.3.4 Test Setup

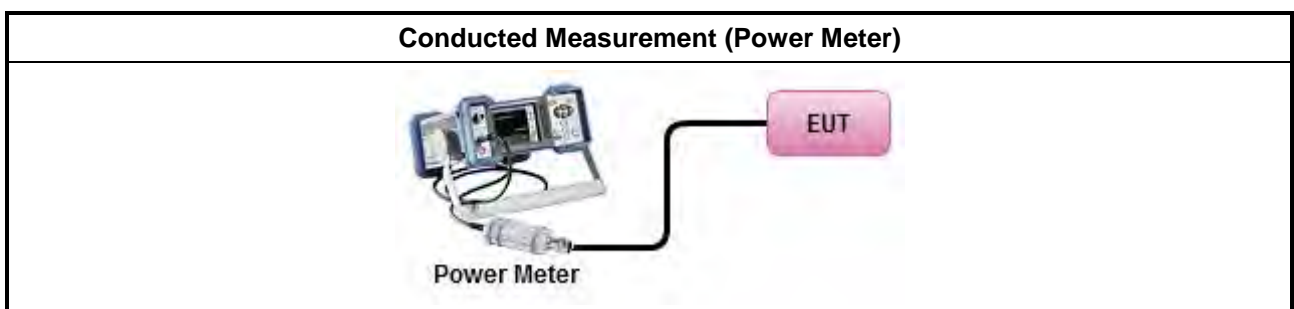

3.3.5 Test Result of Maximum Output Power

Refer as Appendix C



3.4 Power Spectral Density

3.4.1 Limit

Peak Power Spectral Density Limit	
UNII Devices	
<input checked="" type="checkbox"/> For the 5.15-5.25 GHz band:	
	<ul style="list-style-type: none"> ▪ Outdoor AP: the peak power spectral density (PPSD) shall not exceed the lesser of 17dBm/MHz. If $G_{TX} > 6$ dBi, then $P_{Out} = 17 - (G_{TX} - 6)$. ▪ Indoor AP: the peak power spectral density (PPSD) shall not exceed the lesser of 17dBm/MHz. If $G_{TX} > 6$ dBi, then $P_{Out} = 17 - (G_{TX} - 6)$. ▪ Point-to-point AP: the peak power spectral density (PPSD) shall not exceed the lesser of 17dBm/MHz. If $G_{TX} > 23$ dBi, then $P_{Out} = 17 - (G_{TX} - 23)$. ▪ Mobile or Portable Client: the peak power spectral density (PPSD) ≤ 11 dBm/MHz. If $G_{TX} > 6$ dBi, then $PPSD = 11 - (G_{TX} - 6)$.
<input type="checkbox"/> For the 5.25-5.35 GHz band, the peak power spectral density (PPSD) ≤ 11 dBm/MHz. If $G_{TX} > 6$ dBi, then $PPSD = 11 - (G_{TX} - 6)$.	
<input type="checkbox"/> For the 5.47-5.725 GHz band, the peak power spectral density (PPSD) ≤ 11 dBm/MHz. If $G_{TX} > 6$ dBi, then $PPSD = 11 - (G_{TX} - 6)$.	
<input checked="" type="checkbox"/> For the 5.725-5.85 GHz band:	
	<ul style="list-style-type: none"> ▪ Point-to-multipoint systems (P2M): the peak power spectral density (PPSD) ≤ 30 dBm/500kHz. If $G_{TX} > 6$ dBi, then $PPSD = 30 - (G_{TX} - 6)$. ▪ Point-to-point systems (P2P): the peak power spectral density (PPSD) ≤ 30 dBm/500kHz.
LE-LAN Devices	
<input type="checkbox"/> For the 5.15-5.25 GHz band, the e.i.r.p. peak power spectral density (PPSD) ≤ 10 dBm/MHz.	
<input type="checkbox"/> For the 5.25-5.35 GHz band, the peak power spectral density (PPSD) ≤ 11 dBm/MHz.	
	<ul style="list-style-type: none"> ▪ e.i.r.p. greater than 200 mW shall comply with the following e.i.r.p. at different elevations, where θ is the angle above the local horizontal plane (of the Earth) as shown below: -13 dBW/MHz for $0^\circ \leq \theta < 8^\circ$; -13 - 0.716 ($\theta-8$) dBW/MHz for $8^\circ \leq \theta < 40^\circ$ -35.9 - 1.22 ($\theta-40$) dBW/MHz for $40^\circ \leq \theta \leq 45^\circ$; -42 dBW/MHz for $\theta > 45^\circ$
<input type="checkbox"/> For the 5.47-5.6 GHz band and 5.65-5.725 GHz band, the peak power spectral density (PPSD) ≤ 11 dBm/MHz.	
<input type="checkbox"/> For the 5.725-5.85 GHz band:	
	<ul style="list-style-type: none"> ▪ Point-to-multipoint systems (P2M): the peak power spectral density (PPSD) ≤ 30 dBm/500kHz. If $G_{TX} > 6$ dBi, then $PPSD = 30 - (G_{TX} - 6)$. ▪ Point-to-point systems (P2P): the peak power spectral density (PPSD) ≤ 30 dBm/500kHz.
<p>PPSD = peak power spectral density that he same method as used to determine the conducted output power shall be used to determine the power spectral density. And power spectral density in dBm/MHz G_{TX} = the maximum transmitting antenna directional gain in dBi.</p>	

3.4.2 Measuring Instruments

Refer a test equipment and calibration data table in this test report.



3.4.3 Test Procedures

Test Method	
<ul style="list-style-type: none"> ▪ Peak power spectral density procedures that the same method as used to determine the conducted output power shall be used to determine the peak power spectral density and use the peak search function on the spectrum analyzer to find the peak of the spectrum. For the peak power spectral density shall be measured using below options: 	
<input type="checkbox"/>	Refer as FCC KDB 789033 D02, F5) power spectral density can be measured using resolution bandwidths < 1 MHz provided that the results are integrated over 1 MHz bandwidth
[duty cycle ≥ 98% or external video / power trigger]	
<input checked="" type="checkbox"/>	Refer as FCC KDB 789033 D02, clause E Method SA-1 (spectral trace averaging).
<input type="checkbox"/>	Refer as FCC KDB 789033 D02, clause E Method SA-1 Alt. (RMS detection with slow sweep speed)
duty cycle < 98% and average over on/off periods with duty factor	
<input checked="" type="checkbox"/>	Refer as FCC KDB 789033 D02, clause E Method SA-2 (spectral trace averaging).
<input type="checkbox"/>	Refer as FCC KDB 789033 D02, clause E Method SA-2 Alt. (RMS detection with slow sweep speed)
<input checked="" type="checkbox"/> For conducted measurement.	
<ul style="list-style-type: none"> ▪ If the EUT supports multiple transmit chains using options given below: 	
<input checked="" type="checkbox"/>	Option 1: Measure and sum the spectra across the outputs. Refer as FCC KDB 662911, In-band power spectral density (PSD). Sample all transmit ports simultaneously using a spectrum analyzer for each transmit port. Where the trace bin-by-bin of each transmit port summing can be performed. (i.e., in the first spectral bin of output 1 is summed with that in the first spectral bin of output 2 and that from the first spectral bin of output 3, and so on up to the NTX output to obtain the value for the first frequency bin of the summed spectrum.). Add up the amplitude (power) values for the different transmit chains and use this as the new data trace.
<input type="checkbox"/>	Option 2: Measure and sum spectral maxima across the outputs. With this technique, spectra are measured at each output of the device at the required resolution bandwidth. The maximum value (peak) of each spectrum is determined. These maximum values are then summed mathematically in linear power units across the outputs. These operations shall be performed separately over frequency spans that have different out-of-band or spurious emission limits,
<input type="checkbox"/>	Option 3: Measure and add 10 log(N) dB, where N is the number of transmit chains. Refer as FCC KDB 662911, In-band power spectral density (PSD). Performed at each transmit chains and each transmit chains shall be compared with the limit have been reduced with 10 log(N). Or each transmit chains shall be add 10 log(N) to compared with the limit.
<ul style="list-style-type: none"> ▪ If multiple transmit chains, EIRP PPSD calculation could be following as methods: $PPSD_{total} = PPSD_1 + PPSD_2 + \dots + PPSD_n$ (calculated in linear unit [mW] and transfer to log unit [dBm]) $EIRP_{total} = PPSD_{total} + DG$ 	
<input type="checkbox"/> For radiated measurement.	
<ul style="list-style-type: none"> ▪ Refer as FCC KDB 789033 D02 clause II A.1.F "Antenna-port Conducted versus Radiated Testing" ▪ Refer as ANSI C63.10, clause 6.6 for radiated emissions above 1GHz. 	

Test Method

- Refer as FCC KDB 412172 D01 clause 2.2 for EIRP calculation.

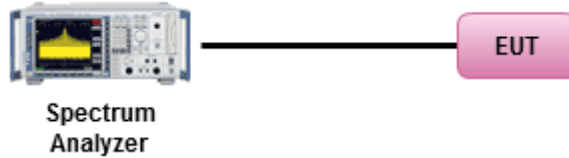
3.4.4 Test Setup**Conducted Measurement****3.4.5 Test Result of Power Spectral Density**

Refer as Appendix D



3.5 Unwanted Emissions

3.5.1 Transmitter Unwanted Emissions Limit

Unwanted emissions below 1 GHz and restricted band emissions above 1GHz limit			
Frequency Range (MHz)	Field Strength (uV/m)	Field Strength (dBuV/m)	Measure Distance (m)
0.009~0.490	2400/F(kHz)	48.5 - 13.8	300
0.490~1.705	24000/F(kHz)	33.8 - 23	30
1.705~30.0	30	29	30
30~88	100	40	3
88~216	150	43.5	3
216~960	200	46	3
Above 960	500	54	3

Note 1: Test distance for frequencies at or above 30 MHz, measurements may be performed at a distance other than the limit distance provided they are not performed in the near field and the emissions to be measured can be detected by the measurement equipment. When performing measurements at a distance other than that specified, the results shall be extrapolated to the specified distance using an extrapolation factor of 20 dB/decade (inverse of linear distance for field-strength measurements, inverse of linear distance-squared for power-density measurements).

Note 2: Test distance for frequencies at below 30 MHz, measurements may be performed at a distance closer than the EUT limit distance; however, an attempt should be made to avoid making measurements in the near field. When performing measurements below 30 MHz at a closer distance than the limit distance, the results shall be extrapolated to the specified distance by either making measurements at a minimum of two or more distances on at least one radial to determine the proper extrapolation factor or by using the square of an inverse linear distance extrapolation factor (40 dB/decade). The test report shall specify the extrapolation method used to determine compliance of the EUT.

Note 3: Using the distance of 1m during the test for above 18 GHz, and the test value to correct for the distance factor at 3m.

Un-restricted band emissions above 1GHz Limit	
Operating Band	Limit
<input checked="" type="checkbox"/> 5.15 - 5.25 GHz	e.i.r.p. -27 dBm [68.2 dBuV/m @3m]
<input type="checkbox"/> 5.25 - 5.35 GHz	e.i.r.p. -27 dBm [68.2 dBuV/m @3m]
<input type="checkbox"/> 5.47 - 5.725 GHz	e.i.r.p. -27 dBm [68.2 dBuV/m @3m]
<input checked="" type="checkbox"/> 5.725 - 5.85 GHz	all emissions shall be limited to a level of -27 dBm/MHz at 75 MHz or more above or below the band edge increasing linearly to 10 dBm/MHz at 25 MHz above or below the band edge, and from 25 MHz above or below the band edge increasing linearly to a level of 15.6 dBm/MHz at 5 MHz above or below the band edge, and from 5 MHz above or below the band edge increasing linearly to a level of 27 dBm/MHz at the band edge.

Note 1: Measurements may be performed at a distance other than the limit distance provided they are not performed in the near field and the emissions to be measured can be detected by the measurement equipment. When performing measurements at a distance other than that specified, the results shall be extrapolated to the specified distance using an extrapolation factor of 20 dB/decade (inverse of



linear distance for field-strength measurements, inverse of linear distance-squared for power-density measurements).

3.5.2 Measuring Instruments

Refer a test equipment and calibration data table in this test report.

3.5.3 Test Procedures

Test Method	
	<ul style="list-style-type: none"> ▪ Measurements may be performed at a distance other than the limit distance provided they are not performed in the near field and the emissions to be measured can be detected by the measurement equipment. Measurements shall not be performed at a distance greater than 30 m for frequencies above 30 MHz, unless it can be further demonstrated that measurements at a distance of 30 m or less are impractical. When performing measurements at a distance other than that specified, the results shall be extrapolated to the specified distance using an extrapolation factor of 20 dB/decade (inverse of linear distance for field-strength measurements, inverse of linear distance-squared for power-density measurements).
	<ul style="list-style-type: none"> ▪ The average emission levels shall be measured in [duty cycle ≥ 98 or duty factor].
	<ul style="list-style-type: none"> ▪ For the transmitter unwanted emissions shall be measured using following options below:
	<ul style="list-style-type: none"> ▪ Refer as FCC KDB 789033 D02, clause G)2) for unwanted emissions into non-restricted bands.
	<ul style="list-style-type: none"> ▪ Refer as FCC KDB 789033 D02, clause G)1) for unwanted emissions into restricted bands.
	<input type="checkbox"/> Refer as FCC KDB 789033 D02, G)6) Method AD (Trace Averaging).
	<input checked="" type="checkbox"/> Refer as FCC KDB 789033 D02, G)6) Method VB (Reduced VBW).
	<input type="checkbox"/> Refer as ANSI C63.10, clause 11.12.2.5.3 (Reduced VBW). VBW ≥ 1/T, where T is pulse time.
	<input type="checkbox"/> Refer as ANSI C63.10, clause 7.5 average value of pulsed emissions.
	<input checked="" type="checkbox"/> Refer as FCC KDB 789033 D02, clause G)5) measurement procedure peak limit.
	<input type="checkbox"/> Refer as ANSI C63.10, clause 4.1.4.2.2 measurement procedure peak limit.
	<ul style="list-style-type: none"> ▪ For radiated measurement.
	<ul style="list-style-type: none"> ▪ Refer as ANSI C63.10, clause 6.4 for radiated emissions below 30 MHz and test distance is 3m.
	<ul style="list-style-type: none"> ▪ Refer as ANSI C63.10, clause 6.5 for radiated emissions 30 MHz to 1 GHz and test distance is 3m.
	<ul style="list-style-type: none"> ▪ Refer as ANSI C63.10, clause 6.6 for radiated emissions above 1GHz.
	<ul style="list-style-type: none"> ▪ The any unwanted emissions level shall not exceed the fundamental emission level.
	<ul style="list-style-type: none"> ▪ All amplitude of spurious emissions that are attenuated by more than 20 dB below the permissible value has no need to be reported.

3.5.4 Test Setup

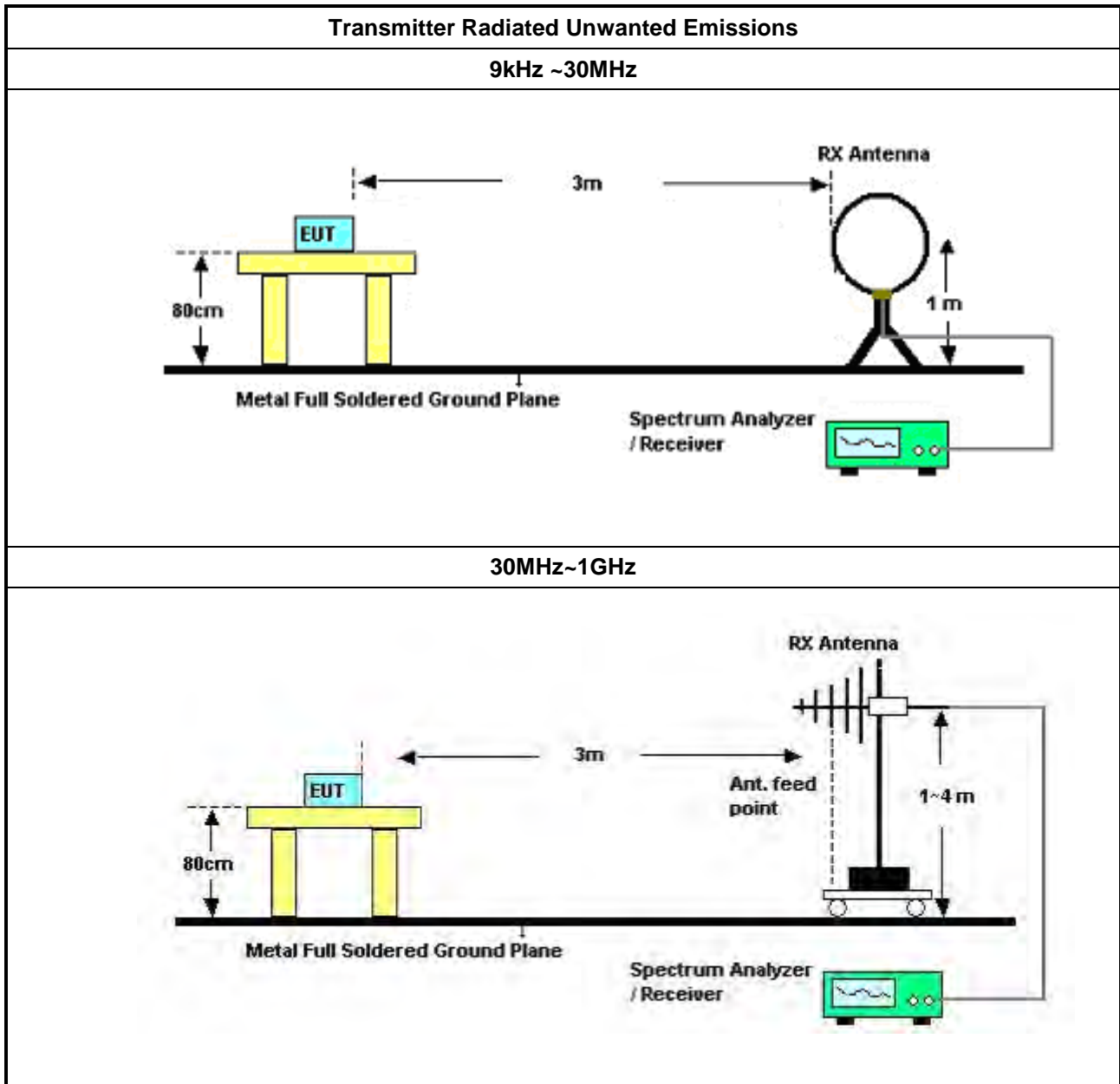

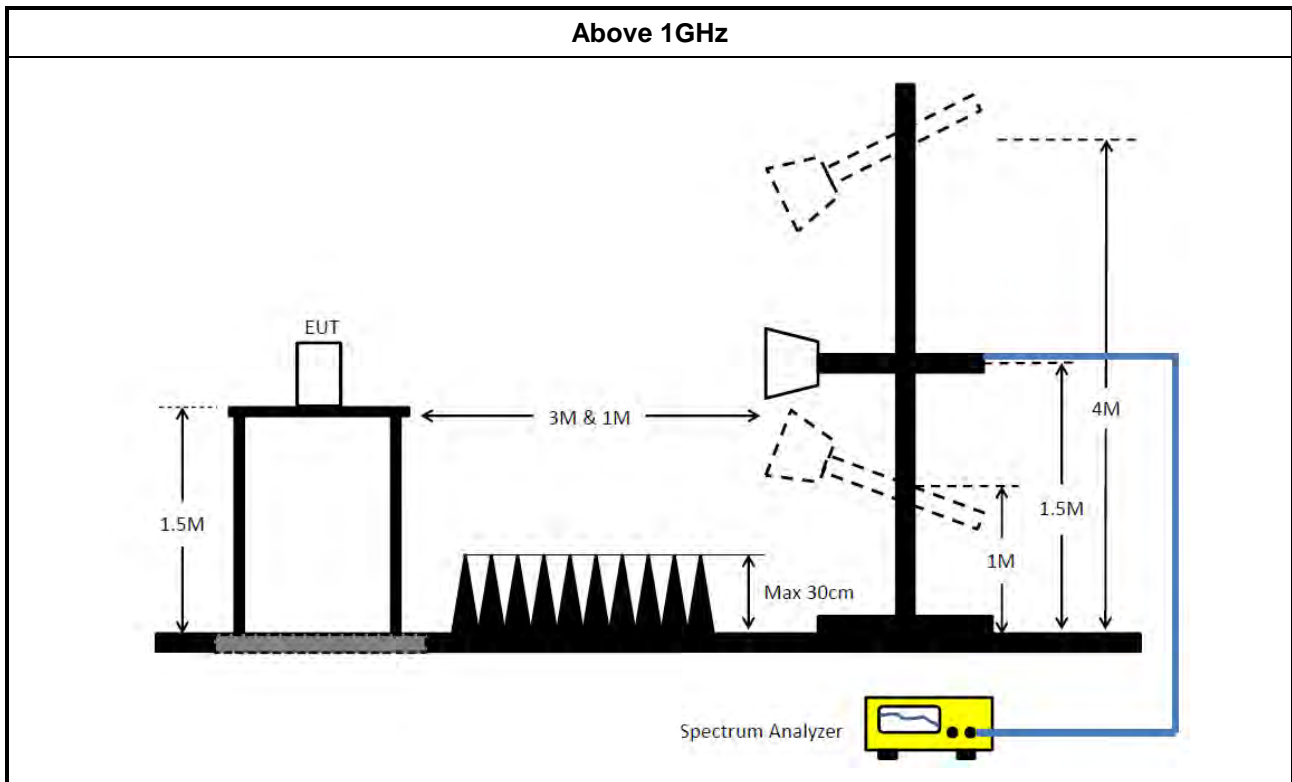

3.5.5 Measurement Results Calculation

The measured Level is calculated using:

Corrected Reading: Antenna factor (AF) + Cable loss (CL) + Read level (Raw) - Preamp factor (PA)(if applicable) = Level.

Transmitter Unwanted Emissions (Below 30MHz)

There is a comparison data of both open-field test site and alternative test site - semi-Anechoic chamber according to KDB414788 Radiated Test Site, and the result came out very similar.

All amplitude of spurious emissions that are attenuated by more than 20 dB below the permissible value has no need to be reported.

The radiated emissions were investigated from 9 kHz or the lowest frequency generated within the device, up to the 10th harmonic or 40 GHz, whichever is appropriate.

3.5.6 Test Result of Transmitter Unwanted Emissions

Refer as Appendix E



4 Test Equipment and Calibration Data

Instrument	Brand	Model No.	Serial No.	Characteristics	Calibration Date	Calibration Due Date	Remark
EMI Receiver	Agilent	N9038A	My52260123	9kHz ~ 8.4GHz	Feb. 22, 2022	Feb. 21, 2023	Conduction (CO01-CB)
LISN	F.C.C.	FCC-LISN-50-16-2	04083	150kHz ~ 100MHz	Feb. 09, 2022	Feb. 08, 2023	Conduction (CO01-CB)
LISN	Schwarzbeck	NSLK 8127	8127647	9kHz ~ 30MHz	Apr. 12, 2022	Apr. 11, 2023	Conduction (CO01-CB)
Pulse Limiter	Rohde&Schwarz	ESH3-Z2	100430	9kHz ~ 30MHz	Feb. 10, 2022	Feb. 09, 2023	Conduction (CO01-CB)
COND Cable	Woken	Cable	Low cable-CO01	9kHz ~ 30MHz	Oct. 18, 2022	Oct. 17, 2023	Conduction (CO01-CB)
Software	SPORTON	SENSE	V5.10	-	N.C.R.	N.C.R.	Conduction (CO01-CB)
Loop Antenna	Teseq	HLA 6120	24155	9kHz - 30 MHz	May 14, 2022	May 13, 2023	Radiation (03CH05-CB)
3m Semi Anechoic Chamber NSA	TDK	SAC-3M	03CH05-CB	30 MHz ~ 1 GHz	Aug. 03, 2022	Aug. 02, 2023	Radiation (03CH05-CB)
3m Semi Anechoic Chamber VSWR	TDK	SAC-3M	03CH05-CB	1GHz ~18GHz 3m	Nov. 07, 2021	Nov. 06, 2022	Radiation (03CH05-CB)
Bilog Antenna with 6dB Attenuator	TESEQ & EMCI	CBL 6112D & N-6-06	35236 & AT-N0610	30MHz ~ 2GHz	Mar. 25, 2022	Mar. 24, 2023	Radiation (03CH05-CB)
Horn Antenna	SCHWARZBECK	BBHA9120D	BBHA 9120 D-1291	1GHz~18GHz	Jun. 23, 2022	Jun. 22, 2023	Radiation (03CH05-CB)
Horn Antenna	Schwarzbeck	BBHA 9170	BBHA9170252	15GHz ~ 40GHz	Aug. 22, 2022	Aug. 21, 2023	Radiation (03CH05-CB)
Pre-Amplifier	EMCI	EMC330N	980331	20MHz ~ 3GHz	Apr. 26, 2022	Apr. 25, 2023	Radiation (03CH05-CB)
Pre-Amplifier	EMCI	EMC12630SE	980287	1GHz – 26.5GHz	Jul. 01, 2022	Jun. 30, 2023	Radiation (03CH05-CB)
Pre-Amplifier	MITEQ	TTA1840-35-HG	1864479	18GHz ~ 40GHz	Jul. 20, 2022	Jul. 19, 2023	Radiation (03CH05-CB)
Spectrum Analyzer	R&S	FSP40	100304	9kHz ~ 40GHz	Mar. 14, 2022	Mar. 13, 2023	Radiation (03CH05-CB)
EMI Test Receiver	R&S	ESCS	826547/017	9kHz ~ 2.75GHz	Jun. 17, 2022	Jun. 16, 2023	Radiation (03CH05-CB)
RF Cable-low	Woken	RG402	Low Cable-04+23	30MHz~1GHz	Oct. 03, 2022	Oct. 02, 2023	Radiation (03CH05-CB)
RF Cable-high	Woken	RG402	High Cable-28	1GHz~18GHz	Oct. 03, 2022	Oct. 02, 2023	Radiation (03CH05-CB)
RF Cable-high	Woken	RG402	High Cable-04+28	1GHz~18GHz	Oct. 03, 2022	Oct. 02, 2023	Radiation (03CH05-CB)
High Cable	Woken	WCA0929M	40G#5+7	1GHz ~ 40 GHz	Dec. 14, 2021	Dec. 13, 2022	Radiation (03CH05-CB)



Instrument	Brand	Model No.	Serial No.	Characteristics	Calibration Date	Calibration Due Date	Remark
High Cable	Woken	WCA0929M	40G#5	1GHz ~ 40 GHz	Dec. 08, 2021	Dec. 07, 2022	Radiation (03CH05-CB)
High Cable	Woken	WCA0929M	40G#7	1GHz ~ 40 GHz	Dec. 14, 2021	Dec. 13, 2022	Radiation (03CH05-CB)
Test Software	SPORTON	SENSE	V5.10	-	N.C.R.	N.C.R.	Radiation (03CH05-CB)
3m Semi Anechoic chamber VSWR	RIKEN	SAC-3M	03CH02-CB	1GHz ~18GHz 3m	Mar. 27, 2021	Mar. 26, 2022	Radiation (03CH02-CB)
Horn Antenna	EMCO	3115	9610-4976	1GHz ~ 18GHz	May 04, 2021	May 03, 2022	Radiation (03CH02-CB)
Horn Antenna	Schwarzbeck	BBHA 9170	BBHA9170252	15GHz ~ 40GHz	Aug. 05, 2021	Aug. 04, 2022	Radiation (03CH02-CB)
Pre-Amplifier	Agilent	83017A	MY39501305	1GHz ~ 26.5GHz	Jul. 12, 2021	Jul. 11, 2022	Radiation (03CH02-CB)
Pre-Amplifier	MITEQ	TTA1840-35-H G	1864479	18GHz ~ 40GHz	Jul. 13, 2021	Jul. 12, 2022	Radiation (03CH02-CB)
Spectrum analyzer	R&S	FSU	100015	9kHz~26GHz	Oct. 25, 2021	Oct. 24, 2022	Radiation (03CH02-CB)
RF Cable-high	Woken	RG402	High Cable-18	1GHz ~ 18GHz	Oct. 04, 2021	Oct. 03, 2022	Radiation (03CH02-CB)
RF Cable-high	Woken	RG402	High Cable-18+19	1GHz ~ 18GHz	Oct. 04, 2021	Oct. 03, 2022	Radiation (03CH02-CB)
RF Cable-high	Woken	RG402	High Cable-40G#1	18GHz ~ 40 GHz	Jul. 15, 2021	Jul. 14, 2022	Radiation (03CH02-CB)
RF Cable-high	Woken	RG402	High Cable-40G#2	18GHz ~ 40 GHz	Jul. 15, 2021	Jul. 14, 2022	Radiation (03CH02-CB)
Test Software	SPORTON	SENSE	V5.10	-	N.C.R.	N.C.R.	Radiation (03CH02-CB)
Spectrum analyzer	R&S	FSV40	100979	9kHz~40GHz	May 21, 2021	May 20, 2022	Conducted (TH01-CB)
RF Cable-high	Woken	RG402	High Cable-06	1 GHz ~ 26.5 GHz	Oct. 04, 2021	Oct. 03, 2022	Conducted (TH01-CB)
RF Cable-high	Woken	RG402	High Cable-07	1 GHz ~ 26.5 GHz	Oct. 04, 2021	Oct. 03, 2022	Conducted (TH01-CB)
RF Cable-high	Woken	RG402	High Cable-08	1 GHz ~ 26.5 GHz	Oct. 04, 2021	Oct. 03, 2022	Conducted (TH01-CB)
RF Cable-high	Woken	RG402	High Cable-09	1 GHz ~ 26.5 GHz	Oct. 04, 2021	Oct. 03, 2022	Conducted (TH01-CB)
RF Cable-high	Woken	RG402	High Cable-10	1 GHz ~ 26.5 GHz	Oct. 04, 2021	Oct. 03, 2022	Conducted (TH01-CB)
RF Cable-high	Woken	RG402	High Cable-30	1 GHz ~ 26.5 GHz	Oct. 04, 2021	Oct. 03, 2022	Conducted (TH01-CB)
Switch	SPTCB	SP-SWI	SWI-01	1 GHz ~ 26.5 GHz	Dec. 13, 2021	Dec. 12, 2022	Conducted (TH01-CB)
RF Cable-high	Woken	RG402	SWI-01-P1	1 GHz ~ 26.5 GHz	Dec. 13, 2021	Dec. 12, 2022	Conducted (TH01-CB)
RF Cable-high	Woken	RG402	SWI-01-P2	1 GHz ~ 26.5 GHz	Dec. 13, 2021	Dec. 12, 2022	Conducted (TH01-CB)



Instrument	Brand	Model No.	Serial No.	Characteristics	Calibration Date	Calibration Due Date	Remark
RF Cable-high	Woken	RG402	SWI-01-P3	1 GHz ~26.5 GHz	Dec. 13, 2021	Dec. 12, 2022	Conducted (TH01-CB)
RF Cable-high	Woken	RG402	SWI-01-P4	1 GHz ~26.5 GHz	Dec. 13, 2021	Dec. 12, 2022	Conducted (TH01-CB)
RF Cable-high	Woken	RG402	SWI-01-P5	1 GHz ~26.5 GHz	Dec. 13, 2021	Dec. 12, 2022	Conducted (TH01-CB)
Power Sensor	Agilent	E9327A	US40442088	50MHz~18GHz	Feb. 23, 2021	Feb. 22, 2022	Conducted (TH01-CB)
Power Meter	Agilent	E4416A	GB41291199	50MHz~18GHz	Feb. 23, 2021	Feb. 22, 2022	Conducted (TH01-CB)
Test Software	SPORTON	SENSE	V5.10	-	N.C.R.	N.C.R.	Conducted (TH01-CB)

Note: Calibration Interval of instruments listed above is one year.

NCR means Non-Calibration required.



Summary

Mode	Result	Type	Freq (Hz)	Level (dBuV)	Limit (dBuV)	Margin (dB)	Condition
Mode 1	Pass	AV	22.119M	40.74	50.00	-9.26	Line

Mode 1

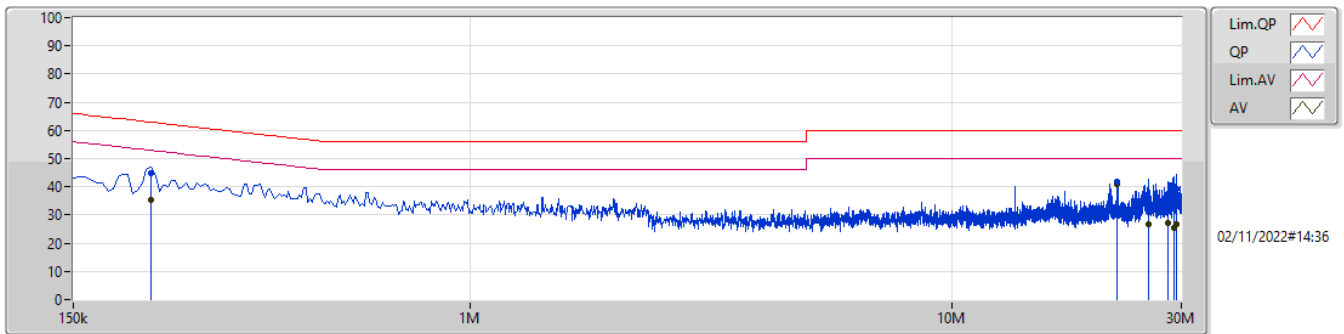

Type	Freq (Hz)	Level (dBuV)	Limit (dBuV)	Margin (dB)	Factor (dB)	Condition	Comment	Raw (dBuV)	LISN (dB)	CL (dB)	AT (dB)
QP	217.5k	45.00	62.92	-17.92	9.99	Line	-	35.01	0.06	0.04	9.89
AV	217.5k	35.43	52.92	-17.49	9.99	Line	-	25.44	0.06	0.04	9.89
QP	22.119M	42.00	60.00	-18.00	10.53	Line	-	31.47	0.32	0.25	9.96
AV	22.119M	40.74	50.00	-9.26	10.53	Line	"Worst"	30.21	0.32	0.25	9.96
QP	25.607M	35.96	60.00	-24.04	10.63	Line	-	25.33	0.36	0.29	9.98
AV	25.607M	26.84	50.00	-23.16	10.63	Line	-	16.21	0.36	0.29	9.98
QP	28.136M	37.33	60.00	-22.67	10.70	Line	-	26.63	0.38	0.32	10.00
AV	28.136M	27.29	50.00	-22.71	10.70	Line	-	16.59	0.38	0.32	10.00
QP	29M	36.13	60.00	-23.87	10.73	Line	-	25.40	0.39	0.33	10.01
AV	29M	25.35	50.00	-24.65	10.73	Line	-	14.62	0.39	0.33	10.01
QP	29.378M	39.14	60.00	-20.86	10.73	Line	-	28.41	0.39	0.33	10.01
AV	29.378M	26.67	50.00	-23.33	10.73	Line	-	15.94	0.39	0.33	10.01

Mode 1

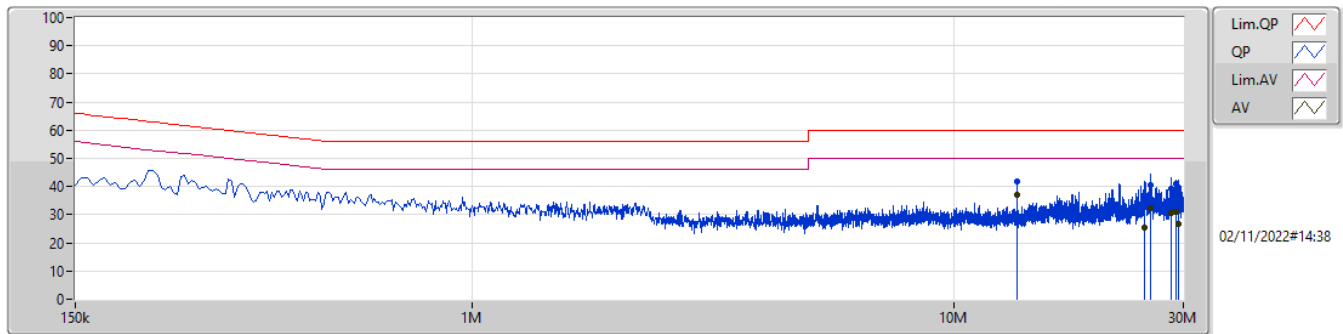

Type	Freq (Hz)	Level (dBuV)	Limit (dBuV)	Margin (dB)	Factor (dB)	Condition	Comment	Raw (dBuV)	LISN (dB)	CL (dB)	AT (dB)
QP	13.56M	41.81	60.00	-18.19	10.37	Neutral	-	31.44	0.27	0.17	9.93
AV	13.56M	36.93	50.00	-13.07	10.37	Neutral	"Worst"	26.56	0.27	0.17	9.93
QP	24.986M	36.68	60.00	-23.32	10.56	Neutral	-	26.12	0.31	0.28	9.97
AV	24.986M	25.25	50.00	-24.75	10.56	Neutral	-	14.69	0.31	0.28	9.97
QP	25.602M	40.60	60.00	-19.40	10.58	Neutral	-	30.02	0.31	0.29	9.98
AV	25.602M	32.20	50.00	-17.80	10.58	Neutral	-	21.62	0.31	0.29	9.98
QP	28.374M	39.14	60.00	-20.86	10.63	Neutral	-	28.51	0.31	0.32	10.00
AV	28.374M	30.78	50.00	-19.22	10.63	Neutral	-	20.15	0.31	0.32	10.00
QP	28.995M	40.74	60.00	-19.26	10.65	Neutral	-	30.09	0.31	0.33	10.01
AV	28.995M	31.23	50.00	-18.77	10.65	Neutral	-	20.58	0.31	0.33	10.01
QP	29.373M	39.60	60.00	-20.40	10.65	Neutral	-	28.95	0.31	0.33	10.01
AV	29.373M	26.90	50.00	-23.10	10.65	Neutral	-	16.25	0.31	0.33	10.01

Summary

Mode	Max-N dB (Hz)	Max-OBW (Hz)	ITU-Code	Min-N dB (Hz)	Min-OBW (Hz)
5.15-5.25GHz	-	-	-	-	-
802.11a_Nss1,(6Mbps)_2TX	39.39M	22.429M	22M4D1D	19.5M	16.432M
802.11ac VHT20_Nss1,(MCS0)_2TX	43.02M	23.748M	23M7D1D	20.19M	17.541M
802.11ac VHT40_Nss1,(MCS0)_2TX	80.58M	42.699M	42M7D1D	39.18M	35.982M
802.11ac VHT80_Nss1,(MCS0)_2TX	83.64M	76.282M	76M3D1D	82.32M	75.682M
5.725-5.85GHz	-	-	-	-	-
802.11a_Nss1,(6Mbps)_2TX	16.32M	22.129M	22M1D1D	15.24M	16.582M
802.11ac VHT20_Nss1,(MCS0)_2TX	17.58M	25.997M	26M0D1D	15.9M	17.781M
802.11ac VHT40_Nss1,(MCS0)_2TX	35.64M	71.664M	71M7D1D	33.12M	37.361M
802.11ac VHT80_Nss1,(MCS0)_2TX	75.72M	79.4M	79M4D1D	75.36M	76.522M

Max-N dB = Maximum 6dB down bandwidth for 5.725-5.85GHz band / Maximum 26dB down bandwidth for other band;
 Max-OBW = Maximum 99% occupied bandwidth;
 Min-N dB = Minimum 6dB down bandwidth for 5.725-5.85GHz band / Maximum 26dB down bandwidth for other band;
 Min-OBW = Minimum 99% occupied bandwidth

Result

Mode	Result	Limit (Hz)	Port 1-N dB (Hz)	Port 1-OBW (Hz)	Port 2-N dB (Hz)	Port 2-OBW (Hz)
802.11a_Nss1,(6Mbps)_2TX	-	-	-	-	-	-
5180MHz	Pass	Inf	19.5M	16.432M	20.22M	16.552M
5200MHz	Pass	Inf	30.9M	16.642M	39.39M	22.429M
5240MHz	Pass	Inf	24.09M	16.612M	37.53M	21.049M
5745MHz	Pass	500k	16.29M	16.582M	16.26M	17.481M
5785MHz	Pass	500k	16.32M	16.702M	15.33M	21.139M
5825MHz	Pass	500k	16.32M	16.732M	15.24M	22.129M
802.11ac_VHT20_Nss1,(MCS0)_2TX	-	-	-	-	-	-
5180MHz	Pass	Inf	20.19M	17.541M	21.45M	17.751M
5200MHz	Pass	Inf	27.78M	17.751M	43.02M	23.748M
5240MHz	Pass	Inf	22.44M	17.661M	39.87M	19.04M
5745MHz	Pass	500k	17.55M	17.781M	17.55M	19.58M
5785MHz	Pass	500k	17.58M	17.841M	15.9M	21.739M
5825MHz	Pass	500k	17.55M	17.991M	17.55M	25.997M
802.11ac_VHT40_Nss1,(MCS0)_2TX	-	-	-	-	-	-
5190MHz	Pass	Inf	39.6M	36.342M	39.18M	35.982M
5230MHz	Pass	Inf	50.7M	36.582M	80.58M	42.699M
5755MHz	Pass	500k	33.78M	37.361M	33.12M	55.052M
5795MHz	Pass	500k	35.64M	53.133M	35.04M	71.664M
802.11ac_VHT80_Nss1,(MCS0)_2TX	-	-	-	-	-	-
5210MHz	Pass	Inf	83.64M	76.282M	82.32M	75.682M
5775MHz	Pass	500k	75.72M	76.522M	75.36M	79.4M

Port X-N dB = Port X 6dB down bandwidth for 5.725-5.85GHz band / 26dB down bandwidth for other band
 Port X-OBW = Port X 99% occupied bandwidth

802.11a_Nss1,(6Mbps)_2TX

EBW

5180MHz

20/12/2021

CF: 5.18GHz
 Span: 60MHz
 RBW: 300kHz
 VBW: 1MHz
 Sweep Time: 100ms
 Detector Type: Peak

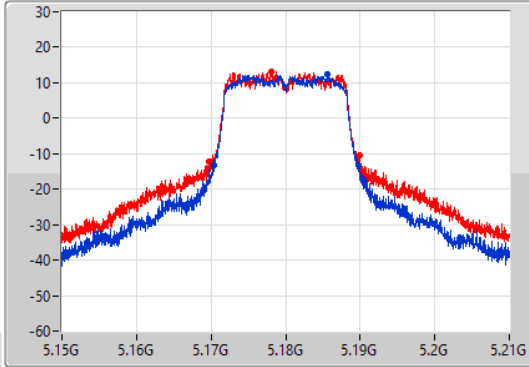

CF: 5.18GHz
 Span: 60MHz
 RBW: 300kHz
 VBW: 1MHz
 Sweep Time: 100ms
 Detector Type: Peak

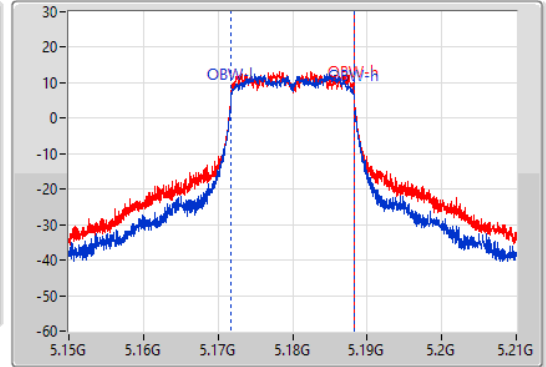

26dB(Hz)	Fl-26dB(Hz)	Fh-26dB(Hz)	OBW(Hz)	Fl-OBW(Hz)	Fh-OBW(Hz)	Limit(Hz)	Port
19.5M	5.17034G	5.18984G	16.432M	5.171784G	5.188216G	Inf	1
20.22M	5.16974G	5.18996G	16.552M	5.171724G	5.188276G	Inf	2

802.11a_Nss1,(6Mbps)_2TX

EBW

5200MHz

20/12/2021

CF: 5.2GHz
 Span: 60MHz
 RBW: 300kHz
 VBW: 1MHz
 Sweep Time: 100ms
 Detector Type: Peak

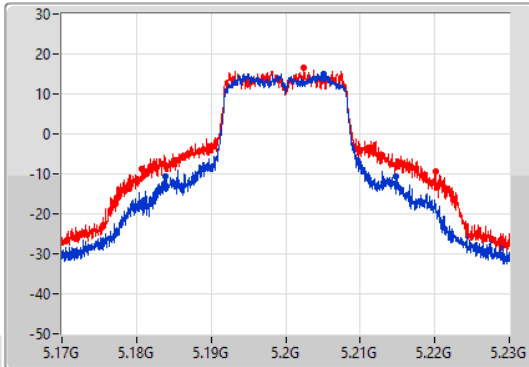

CF: 5.2GHz
 Span: 60MHz
 RBW: 300kHz
 VBW: 1MHz
 Sweep Time: 100ms
 Detector Type: Peak

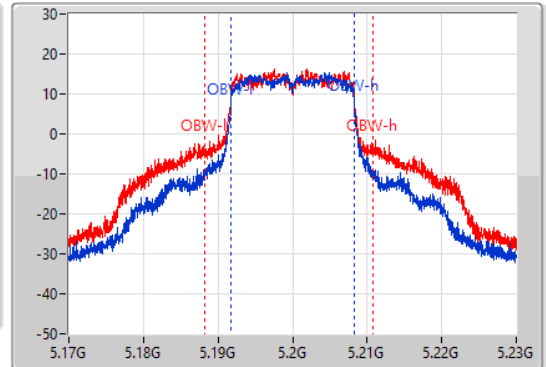

26dB(Hz)	Fl-26dB(Hz)	Fh-26dB(Hz)	OBW(Hz)	Fl-OBW(Hz)	Fh-OBW(Hz)	Limit(Hz)	Port
30.9M	5.18395G	5.21485G	16.642M	5.191664G	5.208306G	Inf	1
39.39M	5.18068G	5.22007G	22.429M	5.188276G	5.210705G	Inf	2

802.11a_Nss1,(6Mbps)_2TX

EBW

5240MHz

20/12/2021

CF
5.24GHz
Span
60MHz
RBW
300kHz
VBW
1MHz
Sweep Time
100ms
Detector Type
Peak

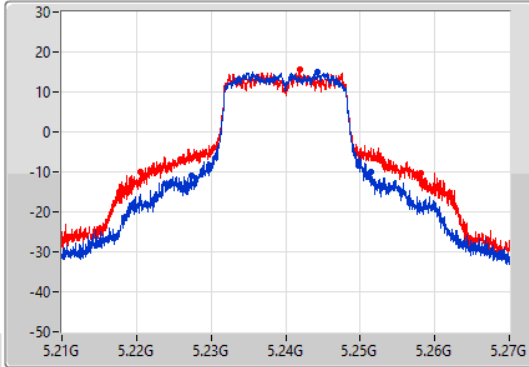

CF
5.24GHz
Span
60MHz
RBW
300kHz
VBW
1MHz
Sweep Time
100ms
Detector Type
Peak

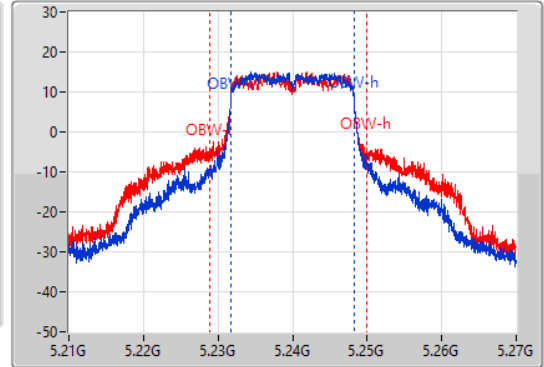

26dB(Hz)	Fl-26dB(Hz)	Fh-26dB(Hz)	OBW(Hz)	Fl-OBW(Hz)	Fh-OBW(Hz)	Limit(Hz)	Port
24.09M	5.2274G	5.25149G	16.612M	5.231664G	5.248276G	Inf	1
37.53M	5.22056G	5.25809G	21.049M	5.228846G	5.249895G	Inf	2

802.11a_Nss1,(6Mbps)_2TX

EBW

5745MHz

20/12/2021

CF
5.745GHz
Span
60MHz
RBW
100kHz
VBW
300kHz
Sweep Time
100ms
Detector Type
Peak

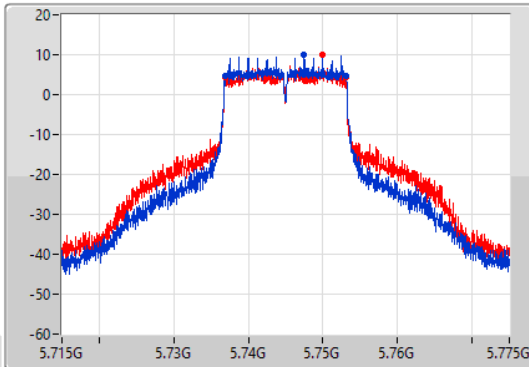

CF
5.745GHz
Span
60MHz
RBW
300kHz
VBW
1MHz
Sweep Time
100ms
Detector Type
Peak

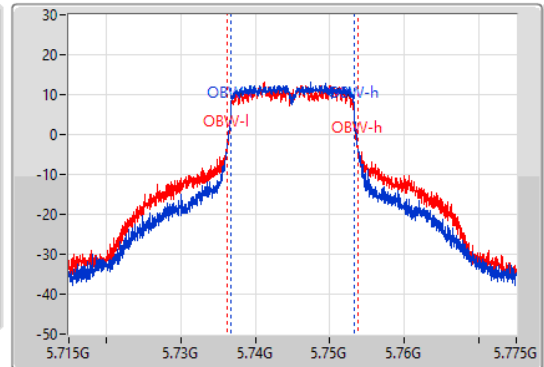

6dB(Hz)	Fl-6dB(Hz)	Fh-6dB(Hz)	OBW(Hz)	Fl-OBW(Hz)	Fh-OBW(Hz)	Limit(Hz)	Port
16.29M	5.73684G	5.75313G	16.582M	5.736694G	5.753276G	500k	1
16.26M	5.73684G	5.7531G	17.481M	5.736244G	5.753726G	500k	2

802.11a_Nss1,(6Mbps)_2TX

EBW

5785MHz

20/12/2021

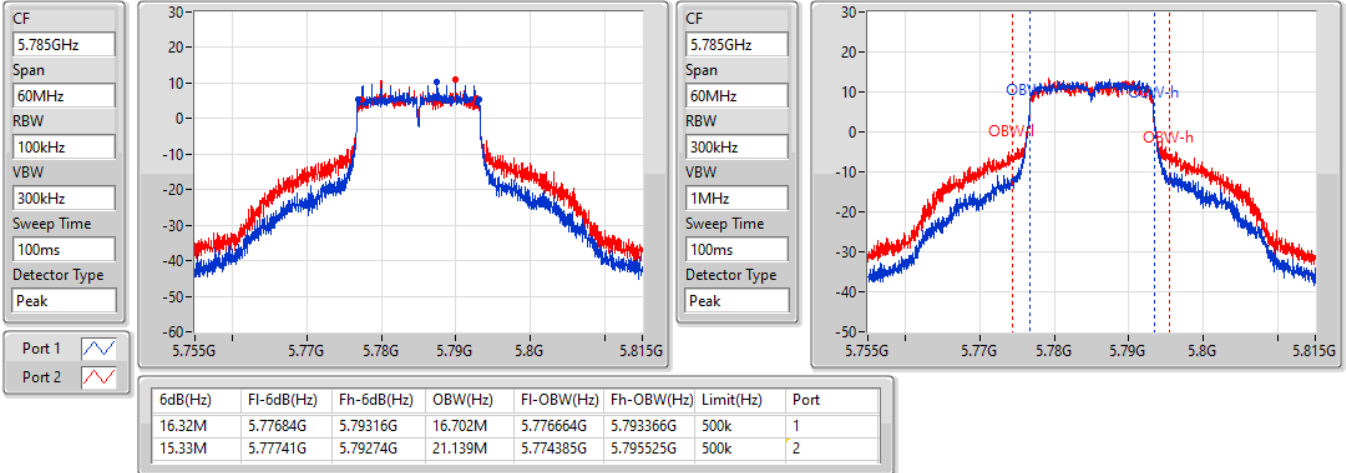

802.11a_Nss1,(6Mbps)_2TX

EBW

5825MHz

20/12/2021

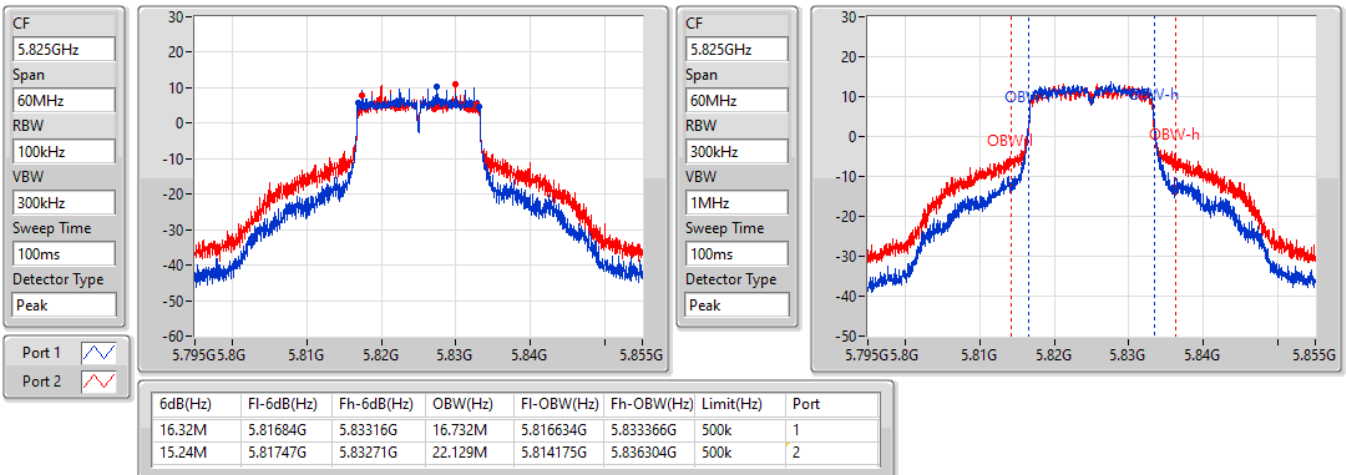

802.11ac VHT20_Nss1,(MCS0)_2TX

EBW

5180MHz

20/12/2021

CF
5.18GHz
Span
60MHz
RBW
300kHz
VBW
1MHz
Sweep Time
100ms
Detector Type
Peak

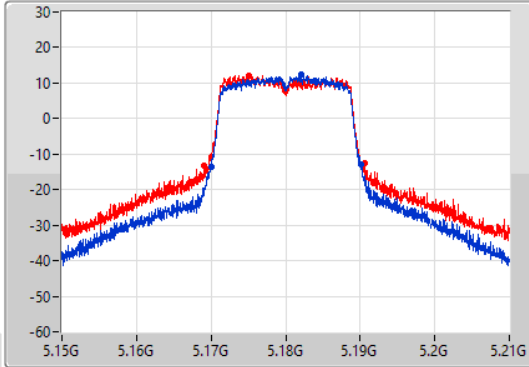

CF
5.18GHz
Span
60MHz
RBW
300kHz
VBW
1MHz
Sweep Time
100ms
Detector Type
Peak

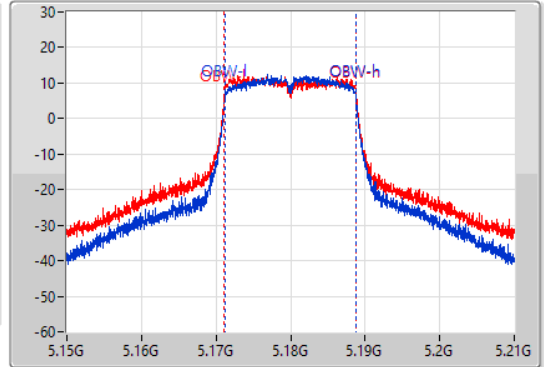

26dB(Hz)	Fl-26dB(Hz)	Fh-26dB(Hz)	OBW(Hz)	Fl-OBW(Hz)	Fh-OBW(Hz)	Limit(Hz)	Port
20.19M	5.16998G	5.19017G	17.541M	5.171214G	5.188756G	Inf	1
21.45M	5.16908G	5.19053G	17.751M	5.171094G	5.188846G	Inf	2

802.11ac VHT20_Nss1,(MCS0)_2TX

EBW

5200MHz

20/12/2021

CF
5.2GHz
Span
60MHz
RBW
300kHz
VBW
1MHz
Sweep Time
100ms
Detector Type
Peak

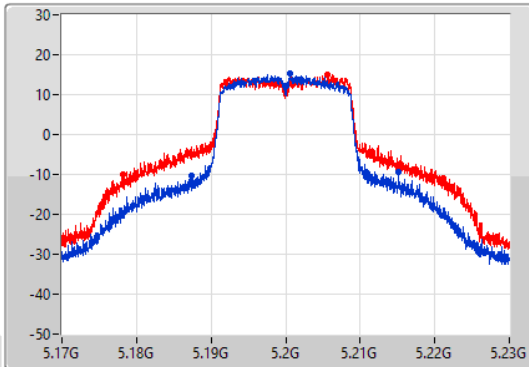

CF
5.2GHz
Span
60MHz
RBW
300kHz
VBW
1MHz
Sweep Time
100ms
Detector Type
Peak

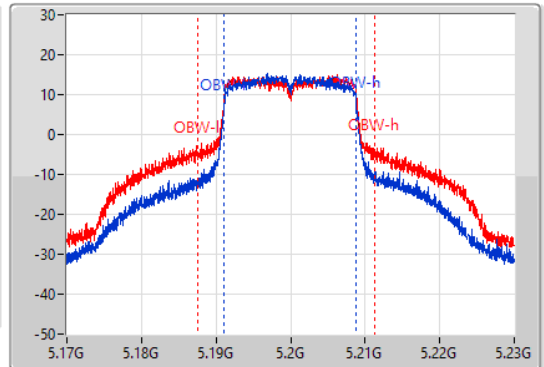

26dB(Hz)	Fl-26dB(Hz)	Fh-26dB(Hz)	OBW(Hz)	Fl-OBW(Hz)	Fh-OBW(Hz)	Limit(Hz)	Port
27.78M	5.18731G	5.21509G	17.751M	5.191094G	5.208846G	Inf	1
43.02M	5.17819G	5.22121G	23.748M	5.187466G	5.211214G	Inf	2

802.11ac VHT20_Nss1,(MCS0)_2TX

EBW

5240MHz

20/12/2021

CF
5.24GHz
Span
60MHz
RBW
300kHz
VBW
1MHz
Sweep Time
100ms
Detector Type
Peak

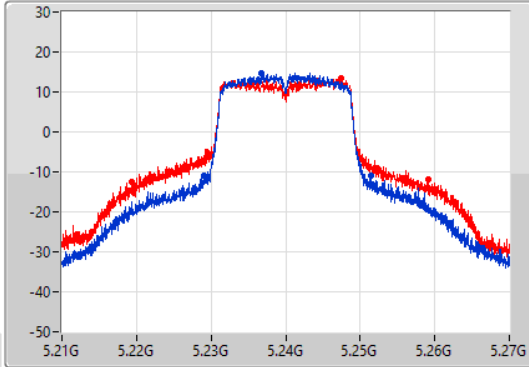

CF
5.24GHz
Span
60MHz
RBW
300kHz
VBW
1MHz
Sweep Time
100ms
Detector Type
Peak

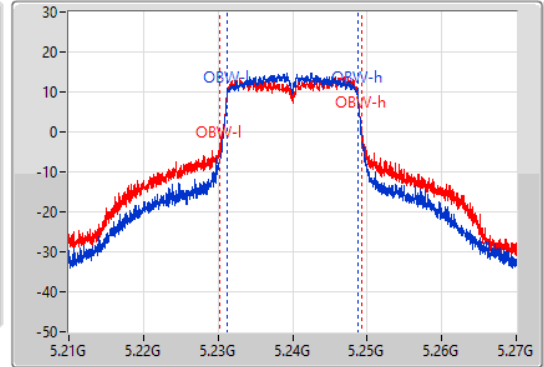

26dB(Hz)	Fl-26dB(Hz)	Fh-26dB(Hz)	OBW(Hz)	Fl-OBW(Hz)	Fh-OBW(Hz)	Limit(Hz)	Port
22.44M	5.22899G	5.25143G	17.661M	5.231154G	5.248816G	Inf	1
39.87M	5.2193G	5.25917G	19.04M	5.230165G	5.249205G	Inf	2

802.11ac VHT20_Nss1,(MCS0)_2TX

EBW

5745MHz

20/12/2021

CF
5.745GHz
Span
60MHz
RBW
100kHz
VBW
300kHz
Sweep Time
100ms
Detector Type
Peak

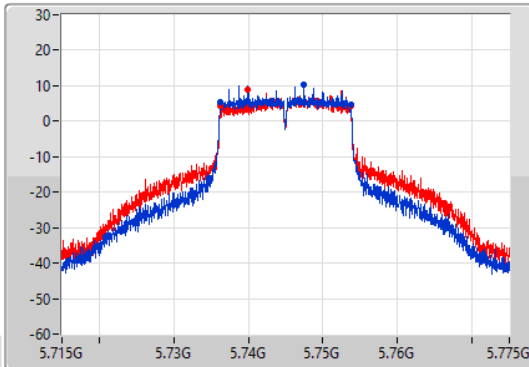

CF
5.745GHz
Span
60MHz
RBW
300kHz
VBW
1MHz
Sweep Time
100ms
Detector Type
Peak

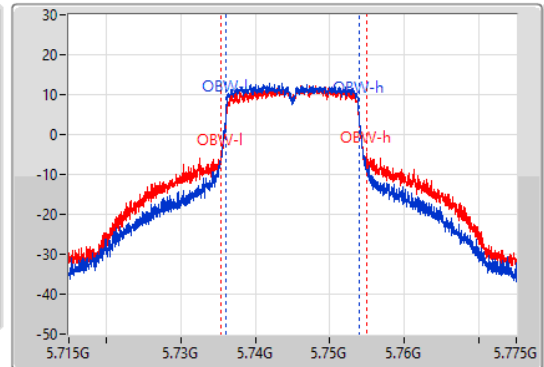

6dB(Hz)	Fl-6dB(Hz)	Fh-6dB(Hz)	OBW(Hz)	Fl-OBW(Hz)	Fh-OBW(Hz)	Limit(Hz)	Port
17.55M	5.73621G	5.75376G	17.781M	5.736094G	5.753876G	500k	1
17.55M	5.73621G	5.75376G	19.58M	5.735345G	5.754925G	500k	2

802.11ac VHT20_Nss1,(MCS0)_2TX

EBW

5785MHz

20/12/2021

CF
5.785GHz
Span
60MHz
RBW
100kHz
VBW
300kHz
Sweep Time
100ms
Detector Type
Peak

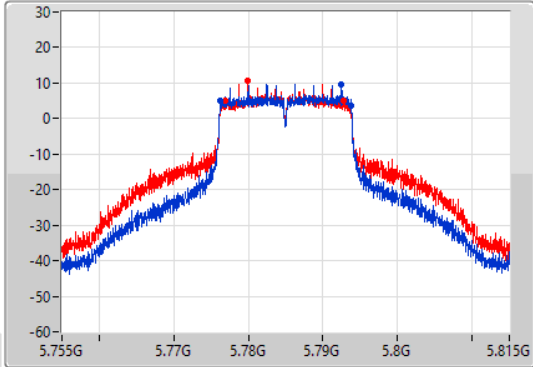

CF
5.785GHz
Span
60MHz
RBW
300kHz
VBW
1MHz
Sweep Time
100ms
Detector Type
Peak

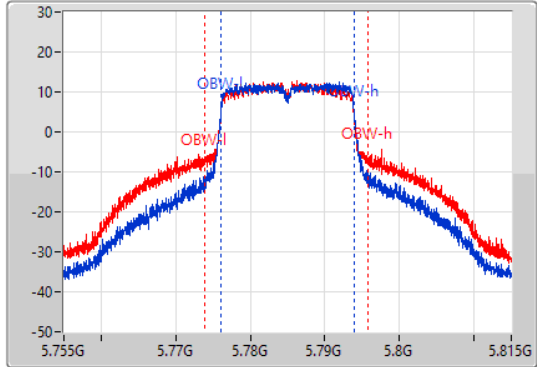

6dB(Hz)	Fl-6dB(Hz)	Fh-6dB(Hz)	OBW(Hz)	Fl-OBW(Hz)	Fh-OBW(Hz)	Limit(Hz)	Port
17.58M	5.77621G	5.79379G	17.841M	5.776094G	5.793936G	500k	1
15.9M	5.77684G	5.79274G	21.739M	5.773966G	5.795705G	500k	2

802.11ac VHT20_Nss1,(MCS0)_2TX

EBW

5825MHz

20/12/2021

CF
5.825GHz
Span
60MHz
RBW
100kHz
VBW
300kHz
Sweep Time
100ms
Detector Type
Peak

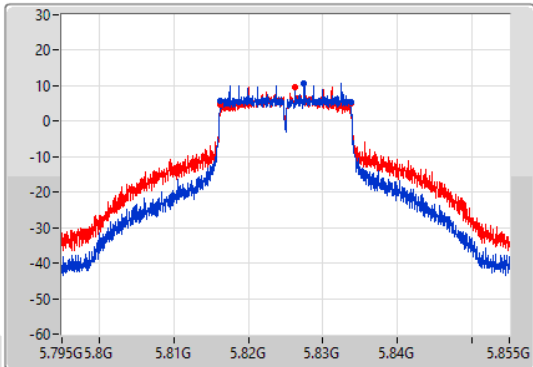

CF
5.825GHz
Span
60MHz
RBW
300kHz
VBW
1MHz
Sweep Time
100ms
Detector Type
Peak

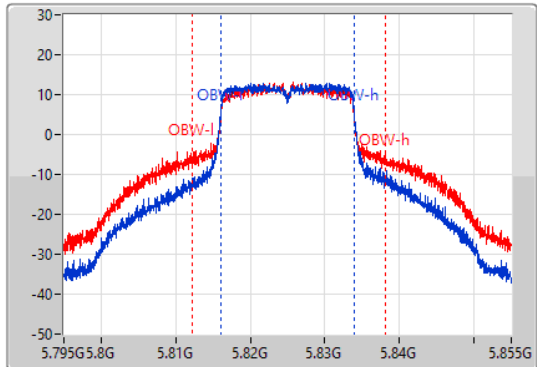

6dB(Hz)	Fl-6dB(Hz)	Fh-6dB(Hz)	OBW(Hz)	Fl-OBW(Hz)	Fh-OBW(Hz)	Limit(Hz)	Port
17.55M	5.81621G	5.83376G	17.991M	5.816004G	5.833996G	500k	1
17.55M	5.81621G	5.83376G	25.997M	5.812136G	5.838133G	500k	2

802.11ac VHT40_Nss1,(MCS0)_2TX

EBW

5190MHz

20/12/2021

CF
5.19GHz
Span
120MHz
RBW
500kHz
VBW
2MHz
Sweep Time
100ms
Detector Type
Peak

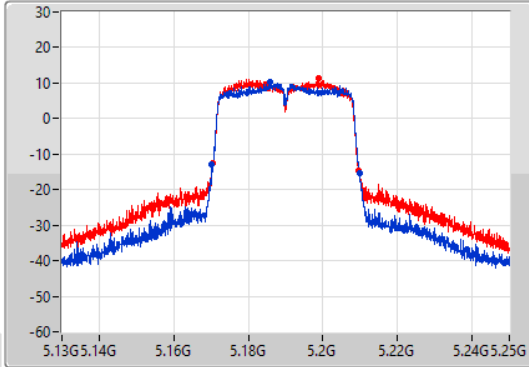

CF
5.19GHz
Span
120MHz
RBW
1MHz
VBW
3MHz
Sweep Time
100ms
Detector Type
Peak

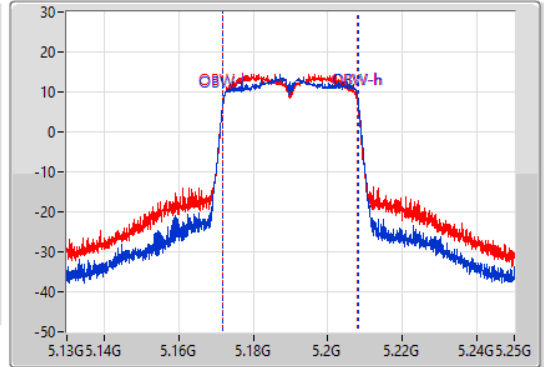

26dB(Hz)	Fl-26dB(Hz)	Fh-26dB(Hz)	OBW(Hz)	Fl-OBW(Hz)	Fh-OBW(Hz)	Limit(Hz)	Port
39.6M	5.1702G	5.2098G	36.342M	5.171829G	5.208171G	Inf	1
39.18M	5.17038G	5.20956G	35.982M	5.171949G	5.207931G	Inf	2

802.11ac VHT40_Nss1,(MCS0)_2TX

EBW

5230MHz

20/12/2021

CF
5.23GHz
Span
120MHz
RBW
500kHz
VBW
2MHz
Sweep Time
100ms
Detector Type
Peak

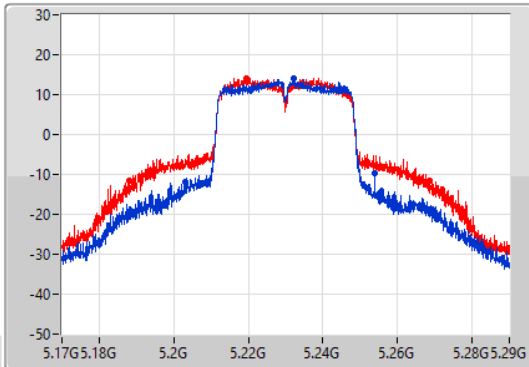

CF
5.23GHz
Span
120MHz
RBW
1MHz
VBW
3MHz
Sweep Time
100ms
Detector Type
Peak

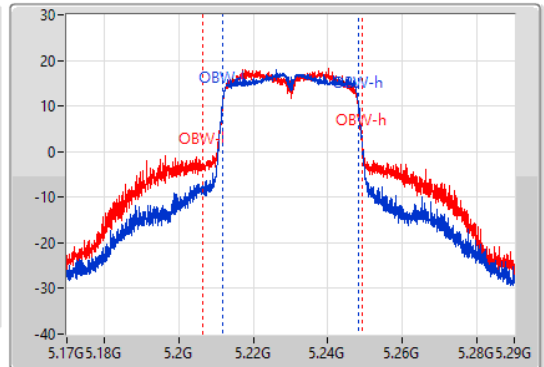

26dB(Hz)	Fl-26dB(Hz)	Fh-26dB(Hz)	OBW(Hz)	Fl-OBW(Hz)	Fh-OBW(Hz)	Limit(Hz)	Port
50.7M	5.20312G	5.25382G	36.582M	5.211649G	5.248231G	Inf	1
80.58M	5.18794G	5.26852G	42.699M	5.206492G	5.24919G	Inf	2

802.11ac VHT40_Nss1,(MCS0)_2TX

EBW

5755MHz

20/12/2021

CF
5.755GHz
Span
120MHz
RBW
100kHz
VBW
300kHz
Sweep Time
100ms
Detector Type
Peak

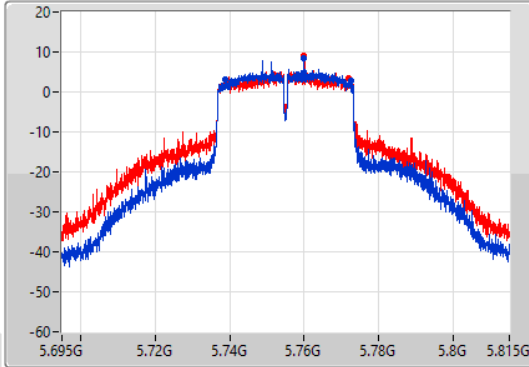

CF
5.755GHz
Span
120MHz
RBW
1MHz
VBW
3MHz
Sweep Time
100ms
Detector Type
Peak

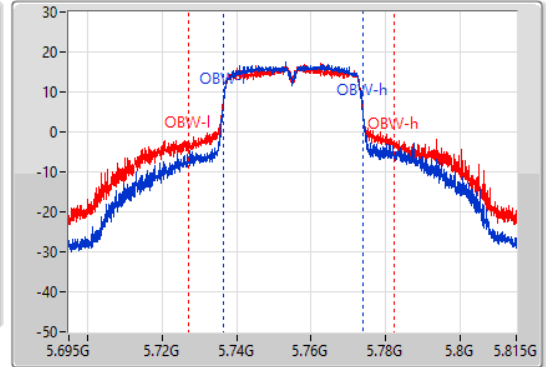

6dB(Hz)	Fl-6dB(Hz)	Fh-6dB(Hz)	OBW(Hz)	Fl-OBW(Hz)	Fh-OBW(Hz)	Limit(Hz)	Port
33.78M	5.73868G	5.77246G	37.361M	5.736529G	5.773891G	500k	1
33.12M	5.73874G	5.77186G	55.052M	5.727174G	5.782226G	500k	2

802.11ac VHT40_Nss1,(MCS0)_2TX

EBW

5795MHz

20/12/2021

CF
5.795GHz
Span
120MHz
RBW
100kHz
VBW
300kHz
Sweep Time
100ms
Detector Type
Peak

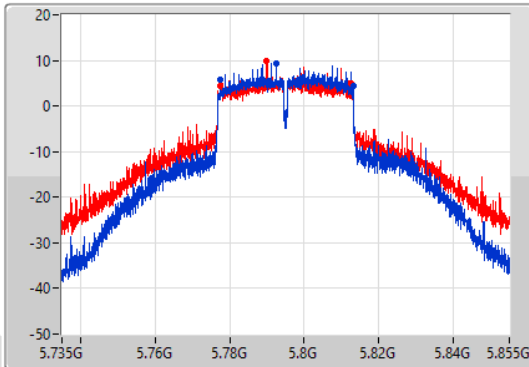

CF
5.795GHz
Span
120MHz
RBW
1MHz
VBW
3MHz
Sweep Time
100ms
Detector Type
Peak

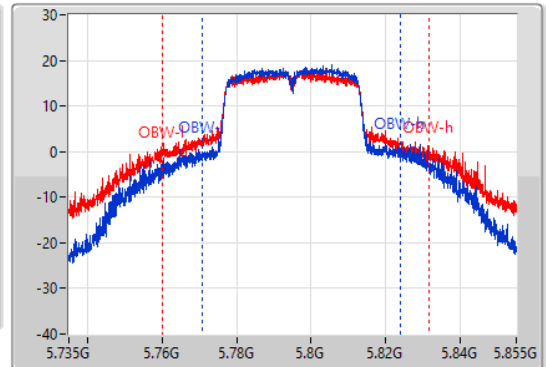

6dB(Hz)	Fl-6dB(Hz)	Fh-6dB(Hz)	OBW(Hz)	Fl-OBW(Hz)	Fh-OBW(Hz)	Limit(Hz)	Port
35.64M	5.77748G	5.81312G	53.133M	5.770712G	5.823846G	500k	1
35.04M	5.77742G	5.81246G	71.664M	5.759918G	5.831582G	500k	2

802.11ac VHT80_Nss1,(MCS0)_2TX

EBW

5210MHz

20/12/2021

CF
5.21GHz
Span
240MHz
RBW
1MHz
VBW
3MHz
Sweep Time
100ms
Detector Type
Peak

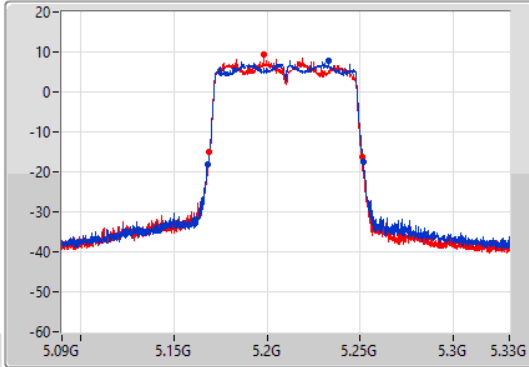

CF
5.21GHz
Span
240MHz
RBW
2MHz
VBW
10MHz
Sweep Time
100ms
Detector Type
Peak

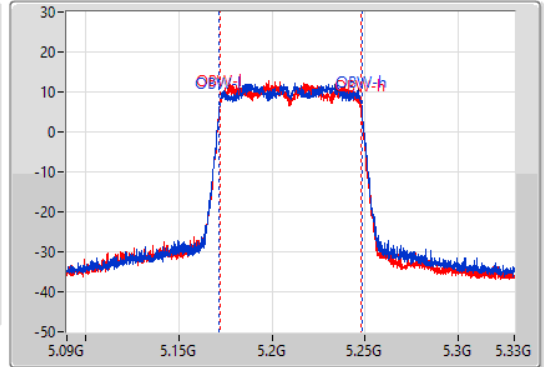

26dB(Hz)	Fl-26dB(Hz)	Fh-26dB(Hz)	OBW(Hz)	Fl-OBW(Hz)	Fh-OBW(Hz)	Limit(Hz)	Port
83.64M	5.16812G	5.25176G	76.282M	5.171859G	5.248141G	Inf	1
82.32M	5.16872G	5.25104G	75.682M	5.171979G	5.247661G	Inf	2

802.11ac VHT80_Nss1,(MCS0)_2TX

EBW

5775MHz

20/12/2021

CF
5.775GHz
Span
240MHz
RBW
100kHz
VBW
300kHz
Sweep Time
100ms
Detector Type
Peak

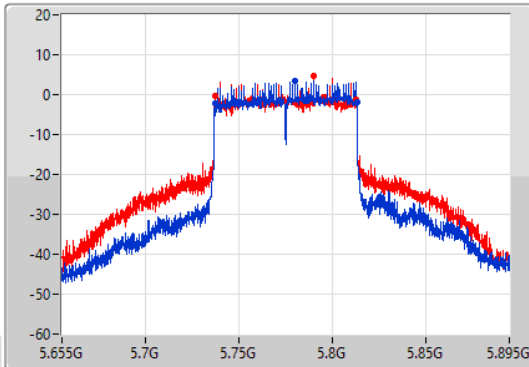

CF
5.775GHz
Span
240MHz
RBW
2MHz
VBW
10MHz
Sweep Time
100ms
Detector Type
Peak

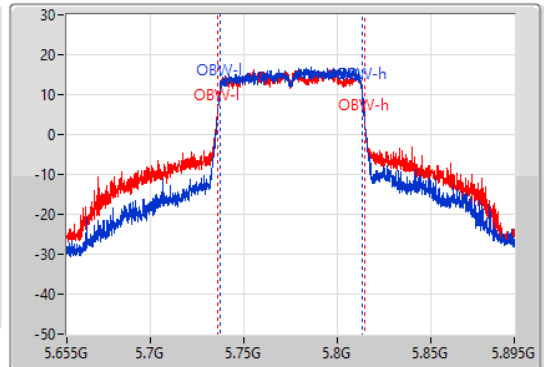

6dB(Hz)	Fl-6dB(Hz)	Fh-6dB(Hz)	OBW(Hz)	Fl-OBW(Hz)	Fh-OBW(Hz)	Limit(Hz)	Port
75.72M	5.73744G	5.81316G	76.522M	5.736979G	5.813501G	500k	1
75.36M	5.73744G	5.8128G	79.4M	5.73566G	5.81506G	500k	2



Summary

Mode	Total Power (dBm)	Total Power (W)
5.15-5.25GHz	-	-
802.11a_Nss1,(6Mbps)_2TX	26.10	0.40738
802.11ac VHT20_Nss1,(MCS0)_2TX	25.69	0.37068
802.11ac VHT40_Nss1,(MCS0)_2TX	25.60	0.36308
802.11ac VHT80_Nss1,(MCS0)_2TX	18.71	0.07430
5.725-5.85GHz	-	-
802.11a_Nss1,(6Mbps)_2TX	24.64	0.29107
802.11ac VHT20_Nss1,(MCS0)_2TX	25.12	0.32509
802.11ac VHT40_Nss1,(MCS0)_2TX	27.06	0.50816
802.11ac VHT80_Nss1,(MCS0)_2TX	23.90	0.24547



Result

Mode	Result	DG (dBi)	Port 1 (dBm)	Port 2 (dBm)	Total Power (dBm)	Power Limit (dBm)
802.11a_Nss1,(6Mbps)_2TX	-	-	-	-	-	-
5180MHz	Pass	6.59	20.26	20.39	23.34	29.41
5200MHz	Pass	6.59	22.99	23.18	26.10	29.41
5240MHz	Pass	6.59	23.19	22.57	25.90	29.41
5745MHz	Pass	6.59	21.42	20.46	23.98	29.41
5785MHz	Pass	6.59	21.88	21.37	24.64	29.41
5825MHz	Pass	6.59	21.92	21.28	24.62	29.41
802.11ac VHT20_Nss1,(MCS0)_2TX	-	-	-	-	-	-
5180MHz	Pass	6.59	20.45	20.27	23.37	29.41
5200MHz	Pass	6.59	22.29	23.03	25.69	29.41
5240MHz	Pass	6.59	22.87	21.98	25.46	29.41
5745MHz	Pass	6.59	21.82	20.93	24.41	29.41
5785MHz	Pass	6.59	21.84	21.45	24.66	29.41
5825MHz	Pass	6.59	22.42	21.77	25.12	29.41
802.11ac VHT40_Nss1,(MCS0)_2TX	-	-	-	-	-	-
5190MHz	Pass	6.59	18.68	19.23	21.97	29.41
5230MHz	Pass	6.59	22.53	22.64	25.60	29.41
5755MHz	Pass	6.59	22.87	22.02	25.48	29.41
5795MHz	Pass	6.59	24.55	23.48	27.06	29.41
802.11ac VHT80_Nss1,(MCS0)_2TX	-	-	-	-	-	-
5210MHz	Pass	6.59	15.78	15.62	18.71	29.41
5775MHz	Pass	6.59	21.11	20.65	23.90	29.41

DG = Directional Gain; Port X = Port X output power

Summary

Mode	PD (dBm/RBW)
5.15-5.25GHz	-
802.11a_Nss1,(6Mbps)_2TX	13.37
802.11ac VHT20_Nss1,(MCS0)_2TX	13.02
802.11ac VHT40_Nss1,(MCS0)_2TX	9.78
802.11ac VHT80_Nss1,(MCS0)_2TX	-0.33
5.725-5.85GHz	-
802.11a_Nss1,(6Mbps)_2TX	9.66
802.11ac VHT20_Nss1,(MCS0)_2TX	9.69
802.11ac VHT40_Nss1,(MCS0)_2TX	8.80
802.11ac VHT80_Nss1,(MCS0)_2TX	2.70

RBW = 500kHz for 5.725-5.85GHz band / 1MHz for other band;

Result

Mode	Result	DG (dBi)	Port 1 (dBm/RBW)	Port 2 (dBm/RBW)	PD (dBm/RBW)	PD Limit (dBm/RBW)
802.11a_Nss1,(6Mbps)_2TX	-	-	-	-	-	-
5180MHz	Pass	9.60	8.06	8.29	10.57	13.40
5200MHz	Pass	9.60	10.89	11.05	13.37	13.40
5240MHz	Pass	9.60	10.87	10.29	13.06	13.40
5745MHz	Pass	9.60	6.78	6.10	9.29	26.40
5785MHz	Pass	9.60	7.16	6.71	9.55	26.40
5825MHz	Pass	9.60	7.37	6.71	9.66	26.40
802.11ac_VHT20_Nss1,(MCS0)_2TX	-	-	-	-	-	-
5180MHz	Pass	9.60	7.88	7.49	10.22	13.40
5200MHz	Pass	9.60	10.68	10.11	13.02	13.40
5240MHz	Pass	9.60	10.22	8.95	12.30	13.40
5745MHz	Pass	9.60	6.63	6.36	9.42	26.40
5785MHz	Pass	9.60	6.44	6.45	9.32	26.40
5825MHz	Pass	9.60	6.87	6.75	9.69	26.40
802.11ac_VHT40_Nss1,(MCS0)_2TX	-	-	-	-	-	-
5190MHz	Pass	9.60	3.63	3.87	6.11	13.40
5230MHz	Pass	9.60	7.37	7.17	9.78	13.40
5755MHz	Pass	9.60	5.04	4.61	7.70	26.40
5795MHz	Pass	9.60	6.52	5.47	8.80	26.40
802.11ac_VHT80_Nss1,(MCS0)_2TX	-	-	-	-	-	-
5210MHz	Pass	9.60	-2.94	-2.64	-0.33	13.40
5775MHz	Pass	9.60	0.18	-0.17	2.70	26.40

DG = Directional Gain; RBW = 500kHz for 5.725-5.85GHz band / 1MHz for other band;
 PD = trace bin-by-bin of each transmits port summing can be performed maximum power density; Port X = Port X Power Density;

802.11a_Nss1,(6Mbps)_2TX

PSD

5180MHz

20/12/2021

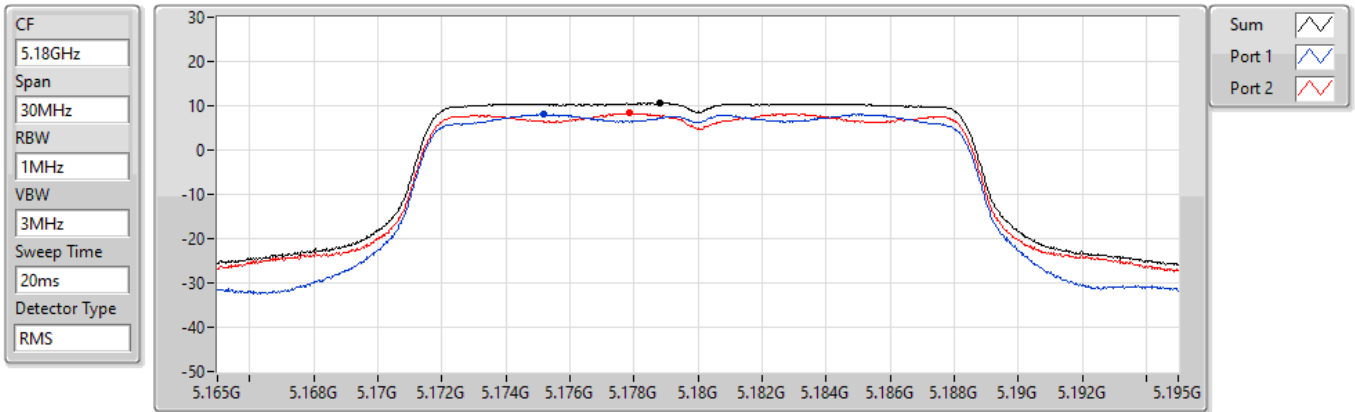

Sum	PD	Port 1	Port 2
(dBm/RBW)	(dBm/RBW)	(dBm/RBW)	(dBm/RBW)
10.57	10.57	8.06	8.29

802.11a_Nss1,(6Mbps)_2TX

PSD

5200MHz

20/12/2021

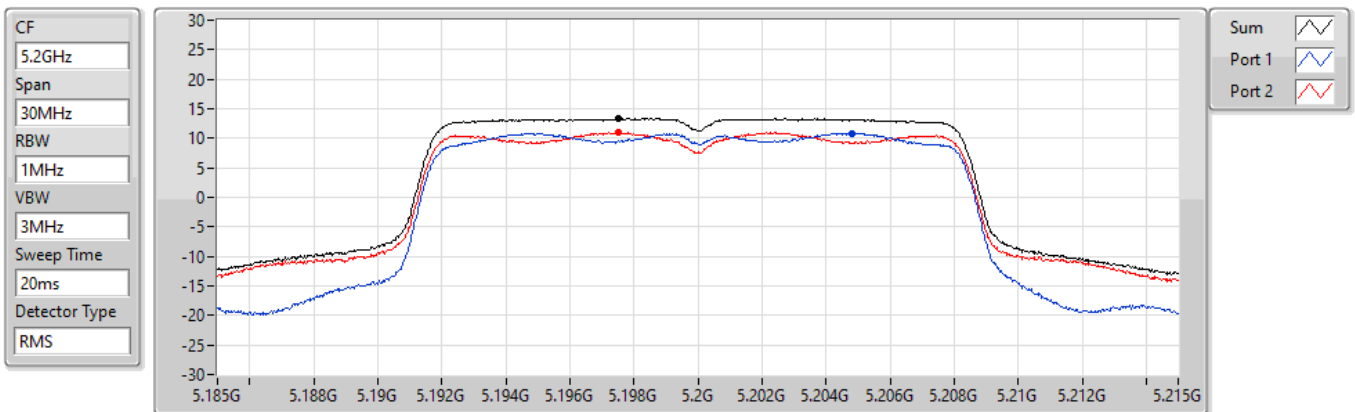

Sum	PD	Port 1	Port 2
(dBm/RBW)	(dBm/RBW)	(dBm/RBW)	(dBm/RBW)
13.37	13.37	10.89	11.05

802.11a_Nss1,(6Mbps)_2TX

PSD

5240MHz

20/12/2021

CF
5.24GHz

Span
30MHz

RBW
1MHz

VBW
3MHz

Sweep Time
20ms

Detector Type
RMS

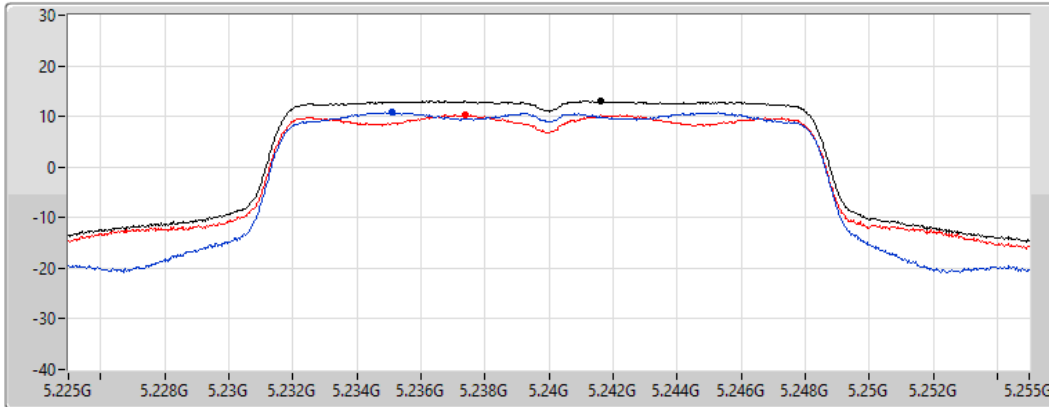

Sum 

Port 1 

Port 2 

Sum	PD	Port 1	Port 2
(dBm/RBW)	(dBm/RBW)	(dBm/RBW)	(dBm/RBW)
13.06	13.06	10.87	10.29

802.11a_Nss1,(6Mbps)_2TX

PSD

5745MHz

20/12/2021

CF
5.745GHz

Span
30MHz

RBW
500kHz

VBW
3MHz

Sweep Time
20ms

Detector Type
RMS

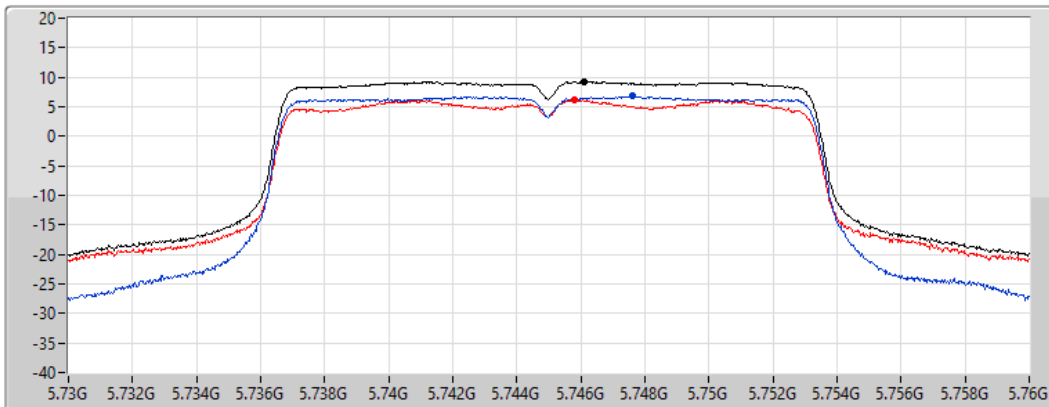

Sum 

Port 1 

Port 2 

Sum	PD	Port 1	Port 2
(dBm/RBW)	(dBm/RBW)	(dBm/RBW)	(dBm/RBW)
9.29	9.29	6.78	6.10

802.11a_Nss1,(6Mbps)_2TX

PSD

5785MHz

20/12/2021

CF
5.785GHz

Span
30MHz

RBW
500kHz

VBW
3MHz

Sweep Time
20ms

Detector Type
RMS

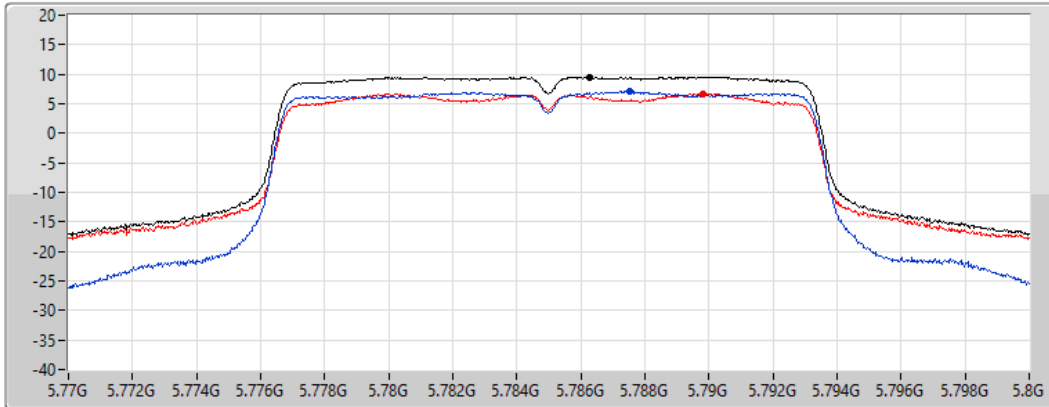

Sum

Port 1

Port 2

Sum	PD	Port 1	Port 2
(dBm/RBW)	(dBm/RBW)	(dBm/RBW)	(dBm/RBW)
9.55	9.55	7.16	6.71

802.11a_Nss1,(6Mbps)_2TX

PSD

5825MHz

20/12/2021

CF
5.825GHz

Span
30MHz

RBW
500kHz

VBW
3MHz

Sweep Time
20ms

Detector Type
RMS

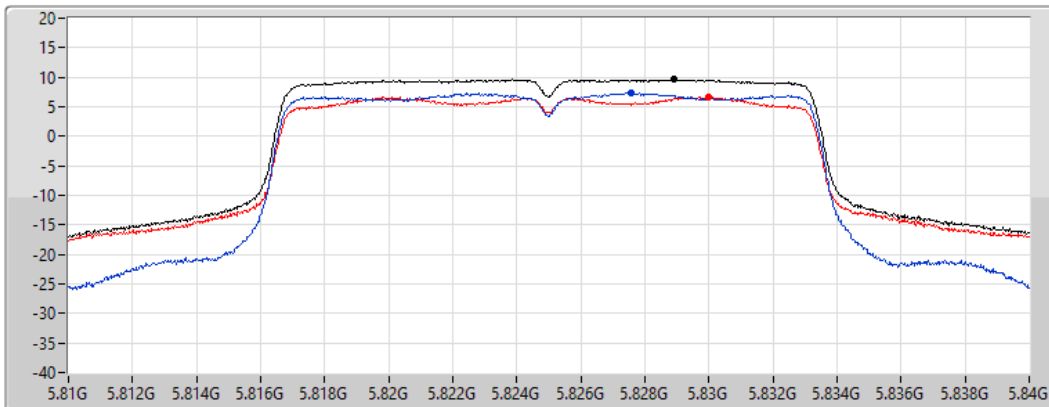

Sum

Port 1

Port 2

Sum	PD	Port 1	Port 2
(dBm/RBW)	(dBm/RBW)	(dBm/RBW)	(dBm/RBW)
9.66	9.66	7.37	6.71

802.11ac VHT20_Nss1,(MCS0)_2TX

PSD

5180MHz

20/12/2021

CF
5.18GHz
Span
30MHz
RBW
1MHz
VBW
3MHz
Sweep Time
20ms
Detector Type
RMS

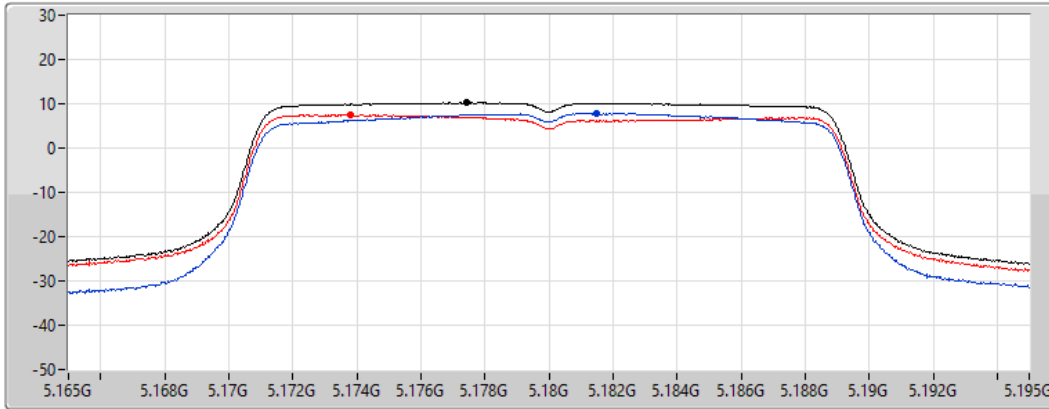

Sum
Port 1
Port 2

Sum	PD	Port 1	Port 2
(dBm/RBW)	(dBm/RBW)	(dBm/RBW)	(dBm/RBW)
10.22	10.22	7.88	7.49

802.11ac VHT20_Nss1,(MCS0)_2TX

PSD

5200MHz

20/12/2021

CF
5.2GHz
Span
30MHz
RBW
1MHz
VBW
3MHz
Sweep Time
20ms
Detector Type
RMS

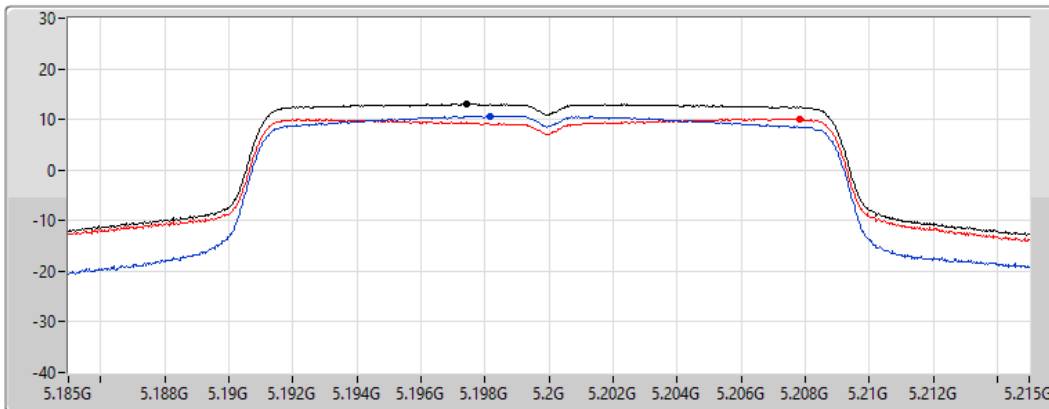

Sum
Port 1
Port 2

Sum	PD	Port 1	Port 2
(dBm/RBW)	(dBm/RBW)	(dBm/RBW)	(dBm/RBW)
13.02	13.02	10.68	10.11

802.11ac VHT20_Nss1,(MCS0)_2TX

PSD

5240MHz

20/12/2021

CF
5.24GHz

Span
30MHz

RBW
1MHz

VBW
3MHz

Sweep Time
20ms

Detector Type
RMS

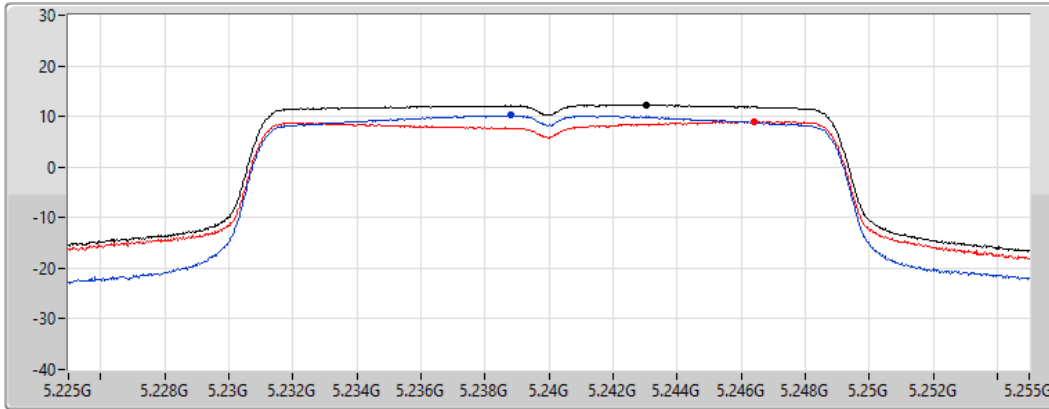

Sum

Port 1

Port 2

Sum	PD	Port 1	Port 2
(dBm/RBW)	(dBm/RBW)	(dBm/RBW)	(dBm/RBW)
12.30	12.30	10.22	8.95

802.11ac VHT20_Nss1,(MCS0)_2TX

PSD

5745MHz

20/12/2021

CF
5.745GHz

Span
30MHz

RBW
500kHz

VBW
3MHz

Sweep Time
20ms

Detector Type
RMS

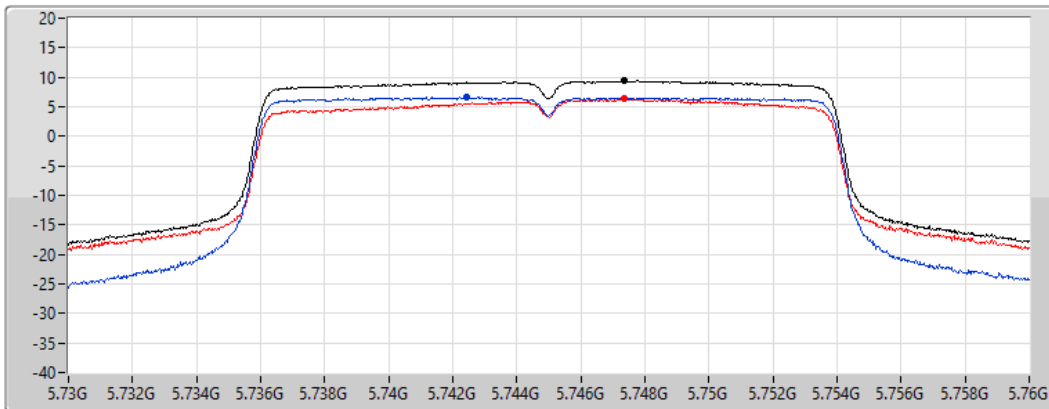

Sum

Port 1

Port 2

Sum	PD	Port 1	Port 2
(dBm/RBW)	(dBm/RBW)	(dBm/RBW)	(dBm/RBW)
9.42	9.42	6.63	6.36

802.11ac VHT20_Nss1,(MCS0)_2TX

PSD

5785MHz

20/12/2021

CF
5.785GHz

Span
30MHz

RBW
500kHz

VBW
3MHz

Sweep Time
20ms

Detector Type
RMS

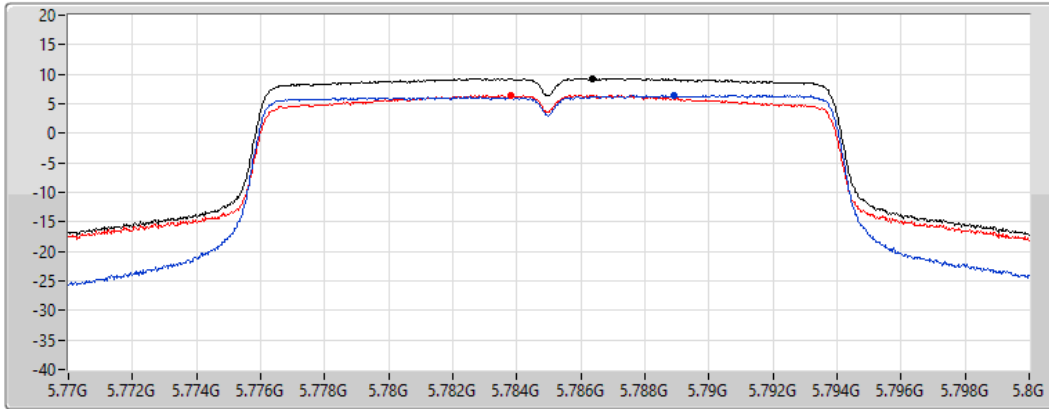

Sum

Port 1

Port 2

Sum	PD	Port 1	Port 2
(dBm/RBW)	(dBm/RBW)	(dBm/RBW)	(dBm/RBW)
9.32	9.32	6.44	6.45

802.11ac VHT20_Nss1,(MCS0)_2TX

PSD

5825MHz

20/12/2021

CF
5.825GHz

Span
30MHz

RBW
500kHz

VBW
3MHz

Sweep Time
20ms

Detector Type
RMS

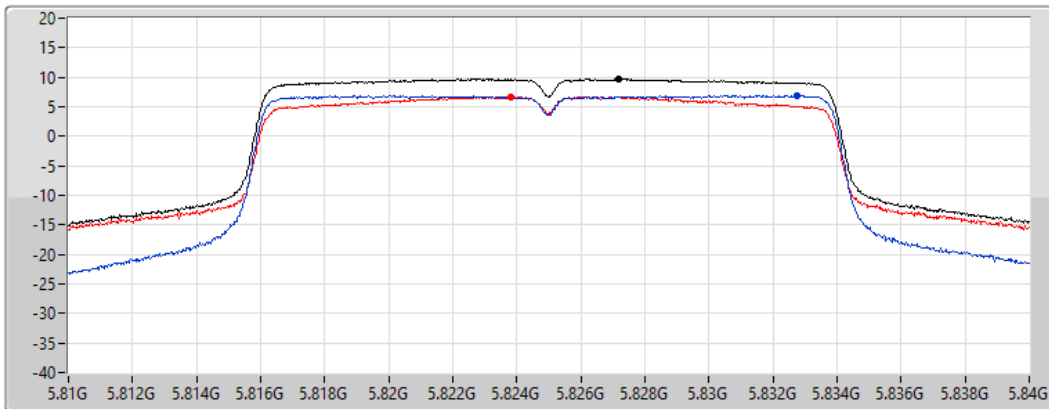

Sum

Port 1

Port 2

Sum	PD	Port 1	Port 2
(dBm/RBW)	(dBm/RBW)	(dBm/RBW)	(dBm/RBW)
9.69	9.69	6.87	6.75

802.11ac VHT40_Nss1,(MCS0)_2TX

PSD

5190MHz

20/12/2021

CF
5.19GHz

Span
60MHz

RBW
1MHz

VBW
3MHz

Sweep Time
20ms

Detector Type
RMS

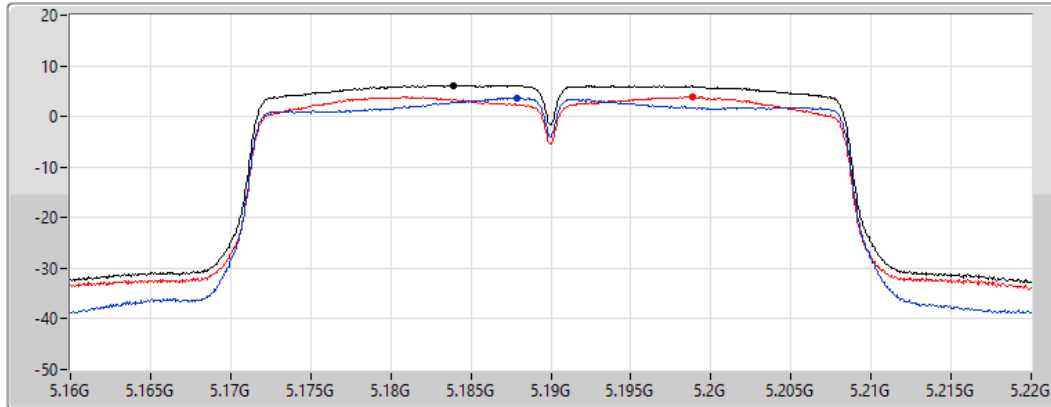

Sum

Port 1

Port 2

Sum	PD	Port 1	Port 2
(dBm/RBW)	(dBm/RBW)	(dBm/RBW)	(dBm/RBW)
6.11	6.11	3.63	3.87

802.11ac VHT40_Nss1,(MCS0)_2TX

PSD

5230MHz

20/12/2021

CF
5.23GHz

Span
60MHz

RBW
1MHz

VBW
3MHz

Sweep Time
20ms

Detector Type
RMS

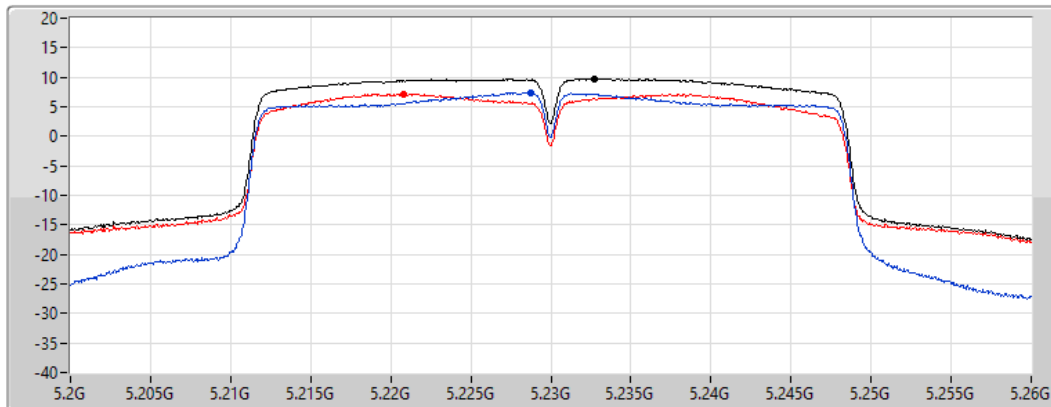

Sum

Port 1

Port 2

Sum	PD	Port 1	Port 2
(dBm/RBW)	(dBm/RBW)	(dBm/RBW)	(dBm/RBW)
9.78	9.78	7.37	7.17

802.11ac VHT40_Nss1,(MCS0)_2TX

PSD

5755MHz

20/12/2021

CF
5.755GHz

Span
60MHz

RBW
500kHz

VBW
3MHz

Sweep Time
20ms

Detector Type
RMS

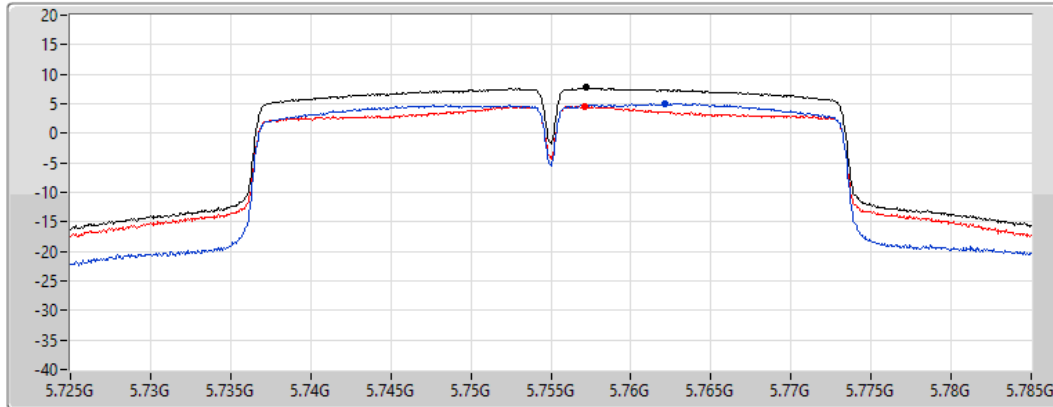

Sum 

Port 1 

Port 2 

Sum	PD	Port 1	Port 2
(dBm/RBW)	(dBm/RBW)	(dBm/RBW)	(dBm/RBW)
7.70	7.70	5.04	4.61

802.11ac VHT40_Nss1,(MCS0)_2TX

PSD

5795MHz

20/12/2021

CF
5.795GHz

Span
60MHz

RBW
500kHz

VBW
3MHz

Sweep Time
20ms

Detector Type
RMS

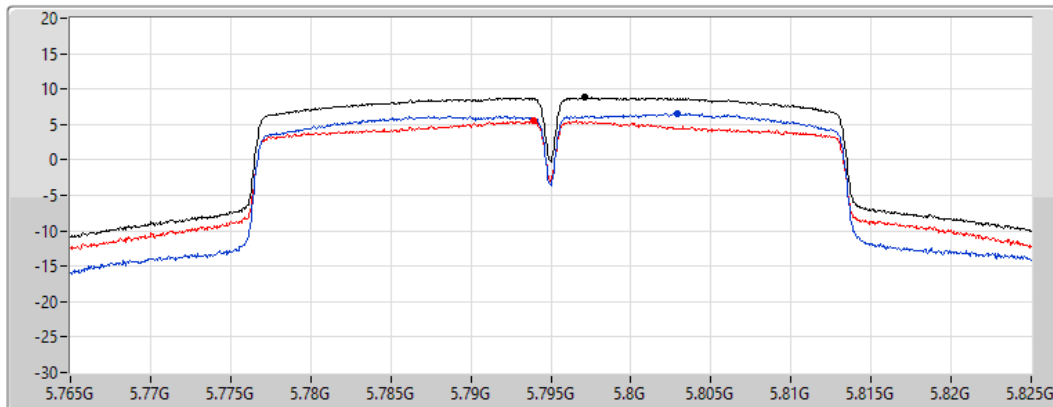

Sum 

Port 1 

Port 2 

Sum	PD	Port 1	Port 2
(dBm/RBW)	(dBm/RBW)	(dBm/RBW)	(dBm/RBW)
8.80	8.80	6.52	5.47

802.11ac VHT80_Nss1,(MCS0)_2TX

PSD

5210MHz

20/12/2021

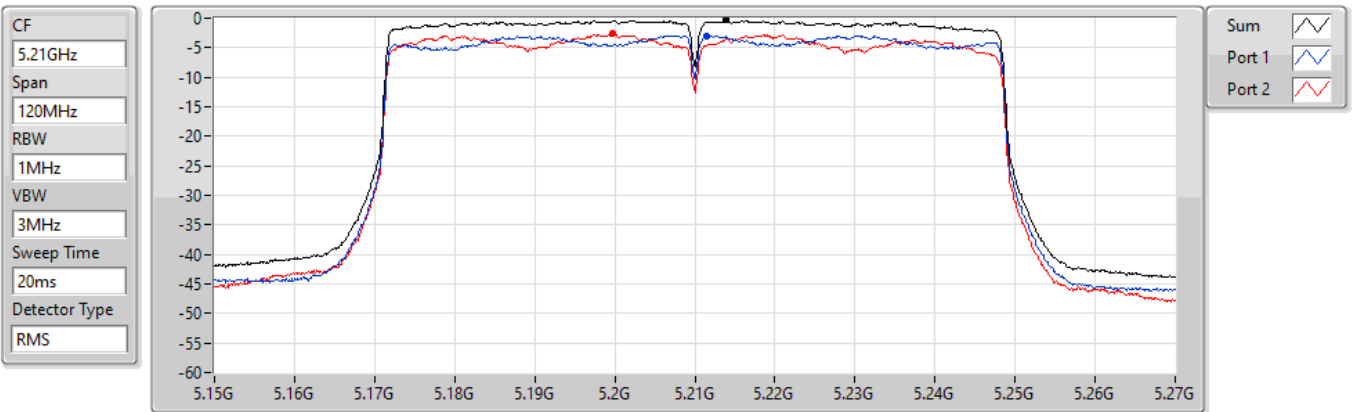

Sum	PD	Port 1	Port 2
(dBm/RBW)	(dBm/RBW)	(dBm/RBW)	(dBm/RBW)
-0.33	-0.33	-2.94	-2.64

802.11ac VHT80_Nss1,(MCS0)_2TX

PSD

5775MHz

20/12/2021

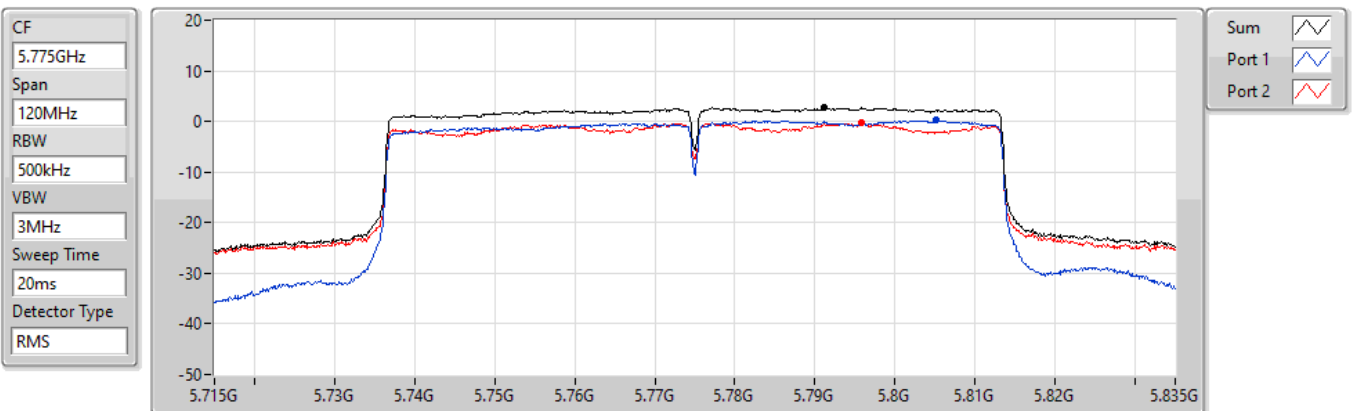

Sum	PD	Port 1	Port 2
(dBm/RBW)	(dBm/RBW)	(dBm/RBW)	(dBm/RBW)
2.70	2.70	0.18	-0.17



Summary

Mode	Result	Type	Freq (Hz)	Level (dBuV/m)	Limit (dBuV/m)	Margin (dB)	Condition
Mode 3	Pass	QP	35.82M	36.84	40.00	-3.16	Vertical

Mode 3

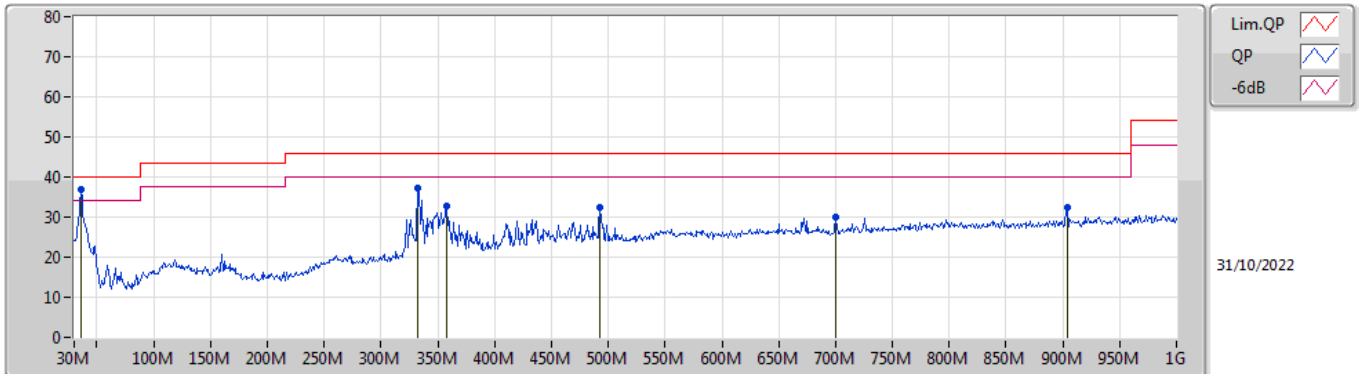

Type	Freq (Hz)	Level (dBuV/m)	Limit (dBuV/m)	Margin (dB)	Factor (dB/m)	Dist (m)	Condition	Azimuth (°)	Height (m)	Comment	Raw (dBuV/m)	AF (dB/m)	CL (dB)	PA (dB)
QP	35.82M	36.84	40.00	-3.16	-10.26	3	Vertical	298	1.00	"Worst"	47.10	20.92	0.52	31.70
PK	332.64M	37.25	46.00	-8.75	-10.02	3	Vertical	357	1.50	-	47.27	19.74	2.40	32.16
PK	357.86M	32.60	46.00	-13.40	-9.07	3	Vertical	66	1.25	-	41.67	20.60	2.51	32.18
PK	492.69M	32.32	46.00	-13.68	-6.30	3	Vertical	356	2.00	-	38.62	23.14	2.94	32.38
PK	700.27M	30.14	46.00	-15.86	-4.49	3	Vertical	4	1.00	-	34.63	24.47	3.60	32.56
PK	903.97M	32.33	46.00	-13.67	-2.12	3	Vertical	175	1.00	-	34.45	26.20	4.17	32.49

Mode 3

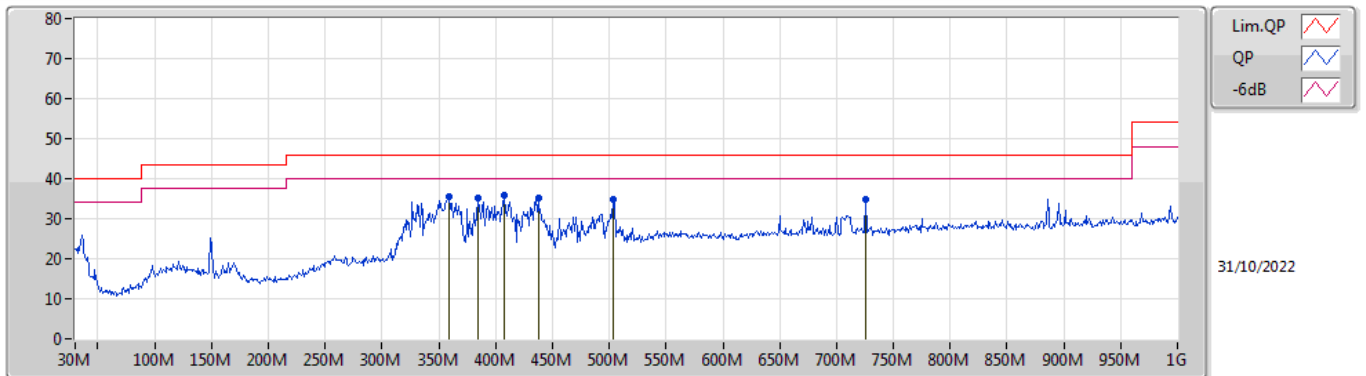

Type	Freq (Hz)	Level (dBuV/m)	Limit (dBuV/m)	Margin (dB)	Factor (dB/m)	Dist (m)	Condition	Azimuth (°)	Height (m)	Comment	Raw (dBuV/m)	AF (dB/m)	CL (dB)	PA (dB)
PK	358.83M	35.44	46.00	-10.56	-9.03	3	Horizontal	249	1.00	-	44.47	20.63	2.52	32.18
PK	384.05M	35.11	46.00	-10.89	-8.59	3	Horizontal	205	1.00	-	43.70	20.95	2.63	32.17
PK	407.33M	35.90	46.00	-10.10	-7.59	3	Horizontal	13	1.00	"Worst"	43.49	21.86	2.72	32.17
PK	437.4M	35.30	46.00	-10.70	-7.09	3	Horizontal	40	2.00	-	42.39	22.35	2.79	32.23
PK	503.36M	34.79	46.00	-11.21	-6.22	3	Horizontal	0	1.00	-	41.01	23.21	2.97	32.40
PK	725.49M	34.79	46.00	-11.21	-4.07	3	Horizontal	360	1.25	-	38.86	24.83	3.69	32.59



Summary

Mode	Result	Type	Freq (Hz)	Level (dBuV/m)	Limit (dBuV/m)	Margin (dB)	Dist (m)	Condition	Azimuth (°)	Height (m)	Comments
5.725-5.85GHz	-	-	-	-	-	-	-	-	-	-	-
802.11ac VHT20_Nss1,(MCS0)_2TX	Pass	PK	17.22652G	68.19	68.20	-0.01	3	Vertical	93	1.93	-

802.11a_Nss1,(6Mbps)_2TX

5180MHz_TnomVnom

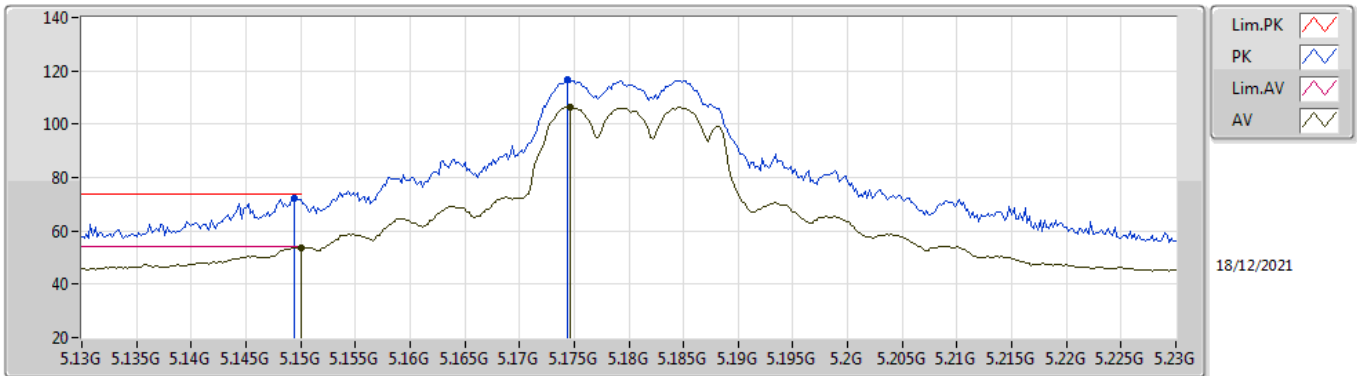

EUT_Z_2TX
Setting 21
02-B-S-5-10

Type	Freq (Hz)	Level (dBuV/m)	Limit (dBuV/m)	Margin (dB)	Raw (dBuV)	Dist (m)	Condition	Azimuth (°)	Height (m)	Comment	AF (dB)	CL (dB)	PA (dB)
PK	5.1494G	72.35	74.00	-1.65	65.75	3	Vertical	343	1.77	-	33.50	5.25	32.15
AV	5.15G	53.76	54.00	-0.24	47.16	3	Vertical	343	1.77	-	33.50	5.25	32.15
PK	5.1744G	116.50	Inf	-Inf	109.88	3	Vertical	343	1.77	-	33.50	5.27	32.15
AV	5.1746G	106.41	Inf	-Inf	99.79	3	Vertical	343	1.77	-	33.50	5.27	32.15

802.11a_Nss1,(6Mbps)_2TX

5180MHz_TnomVnom

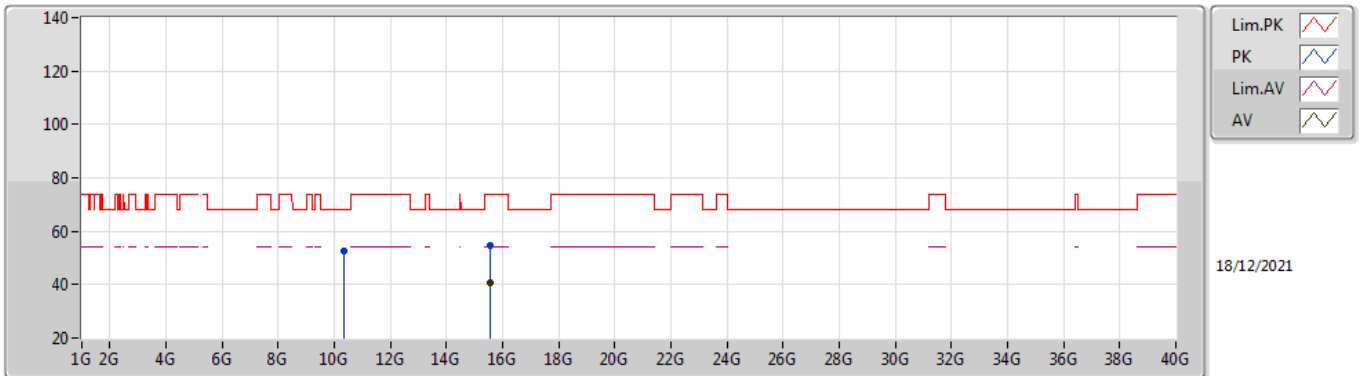

EUT_Z_2TX
Setting 21
02-B-S-5

Type	Freq (Hz)	Level (dBuV/m)	Limit (dBuV/m)	Margin (dB)	Raw (dBuV)	Dist (m)	Condition	Azimuth (°)	Height (m)	Comment	AF (dB)	CL (dB)	PA (dB)
PK	10.3632G	52.67	68.20	-15.53	39.74	3	Vertical	348	1.87	-	38.44	7.45	32.96
PK	15.53848G	54.70	74.00	-19.30	40.33	3	Vertical	114	1.91	-	37.78	9.79	33.20
AV	15.546G	40.60	54.00	-13.40	26.24	3	Vertical	114	1.91	-	37.76	9.80	33.20

802.11a_Nss1,(6Mbps)_2TX

5180MHz_TnomVnom

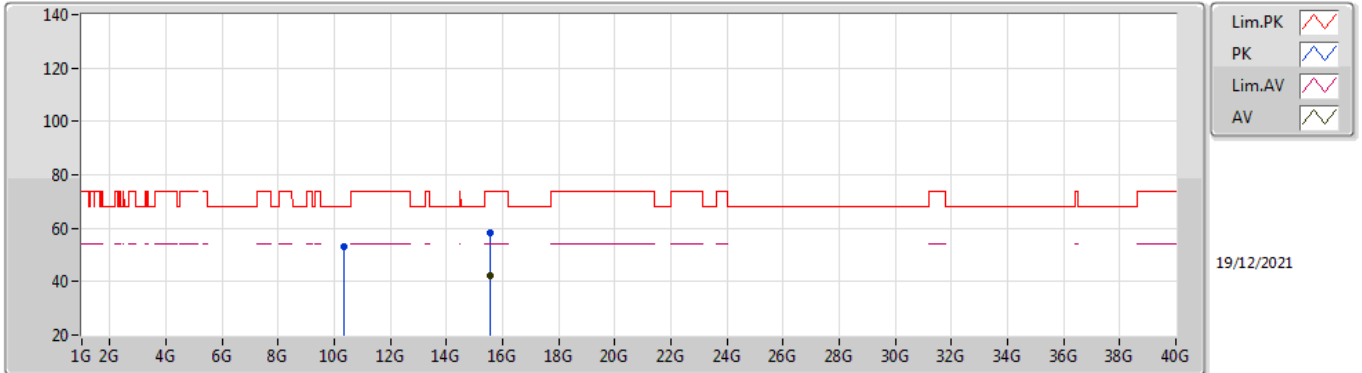

EUT_Z_2TX
Setting 21
02-B-S-5

Type	Freq (Hz)	Level (dBuV/m)	Limit (dBuV/m)	Margin (dB)	Raw (dBuV)	Dist (m)	Condition	Azimuth (°)	Height (m)	Comment	AF (dB)	CL (dB)	PA (dB)
PK	10.35536G	53.35	68.20	-14.85	40.42	3	Horizontal	0	2.34	-	38.44	7.44	32.95
PK	15.5344G	58.09	74.00	-15.91	43.69	3	Horizontal	37	1.99	-	37.80	9.79	33.19
AV	15.539G	42.10	54.00	-11.90	27.73	3	Horizontal	37	1.99	-	37.78	9.79	33.20

802.11a_Nss1,(6Mbps)_2TX

5200MHz_TnomVnom

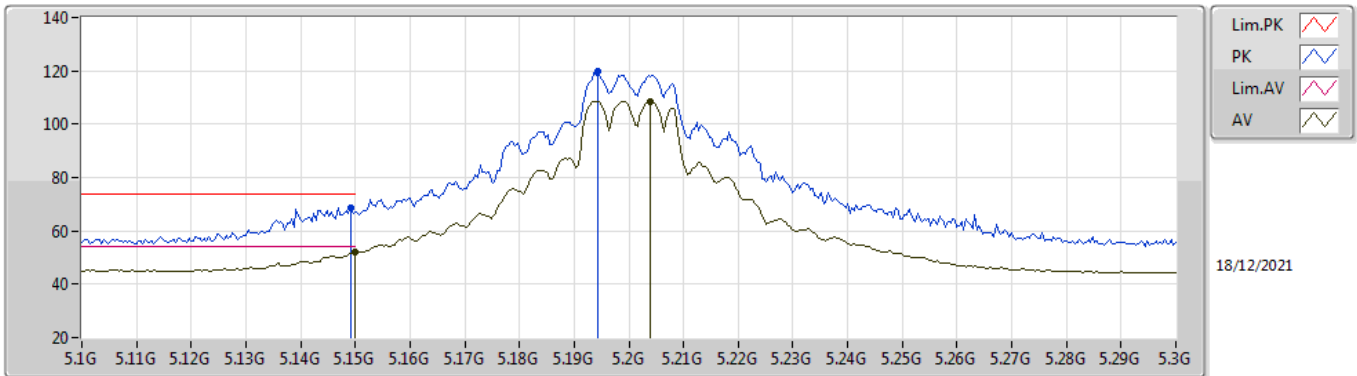

EUT_Z_2TX
Setting 24.5
02-B-S-5-10

Type	Freq (Hz)	Level (dBuV/m)	Limit (dBuV/m)	Margin (dB)	Raw (dBuV)	Dist (m)	Condition	Azimuth (°)	Height (m)	Comment	AF (dB)	CL (dB)	PA (dB)
PK	5.1492G	68.84	74.00	-5.16	62.24	3	Vertical	309	2.27	-	33.50	5.25	32.15
AV	5.15G	52.26	54.00	-1.74	45.66	3	Vertical	309	2.27	-	33.50	5.25	32.15
PK	5.1944G	119.62	Inf	-Inf	112.98	3	Vertical	309	2.27	-	33.50	5.29	32.15
AV	5.204G	108.62	Inf	-Inf	101.96	3	Vertical	309	2.27	-	33.51	5.30	32.15

802.11a_Nss1,(6Mbps)_2TX

5200MHz_TnomVnom

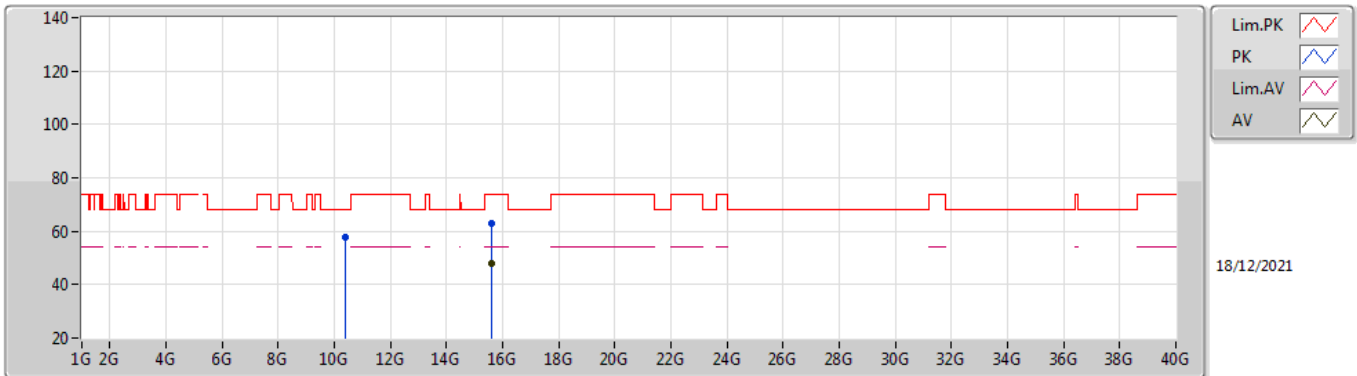

EUT_Z_2TX
Setting 24.5
02-B-S-5

Type	Freq (Hz)	Level (dBuV/m)	Limit (dBuV/m)	Margin (dB)	Raw (dBuV)	Dist (m)	Condition	Azimuth (°)	Height (m)	Comment	AF (dB)	CL (dB)	PA (dB)
PK	10.401G	57.70	68.20	-10.50	44.82	3	Vertical	17	2.96	-	38.40	7.46	32.98
PK	15.59828G	63.14	74.00	-10.86	48.98	3	Vertical	3	2.02	-	37.61	9.82	33.27
AV	15.59732G	47.94	54.00	-6.06	33.77	3	Vertical	3	2.02	-	37.61	9.82	33.26

802.11a_Nss1,(6Mbps)_2TX

5200MHz_TnomVnom

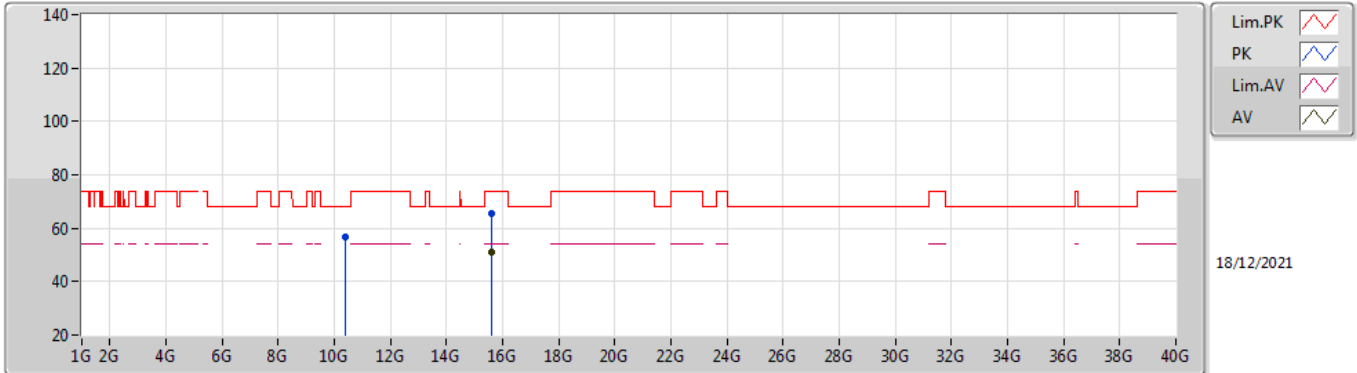

EUT_Z_2TX
Setting 24.5
02-B-S-5

Type	Freq (Hz)	Level (dBuV/m)	Limit (dBuV/m)	Margin (dB)	Raw (dBuV)	Dist (m)	Condition	Azimuth (°)	Height (m)	Comment	AF (dB)	CL (dB)	PA (dB)
PK	10.39616G	56.85	68.20	-11.35	43.97	3	Horizontal	22	2.42	-	38.40	7.46	32.98
PK	15.59812G	65.40	74.00	-8.60	51.24	3	Horizontal	37	2.03	-	37.61	9.82	33.27
AV	15.59772G	50.99	54.00	-3.01	36.83	3	Horizontal	37	2.03	-	37.61	9.82	33.27

802.11a_Nss1,(6Mbps)_2TX

5240MHz_TnomVnom

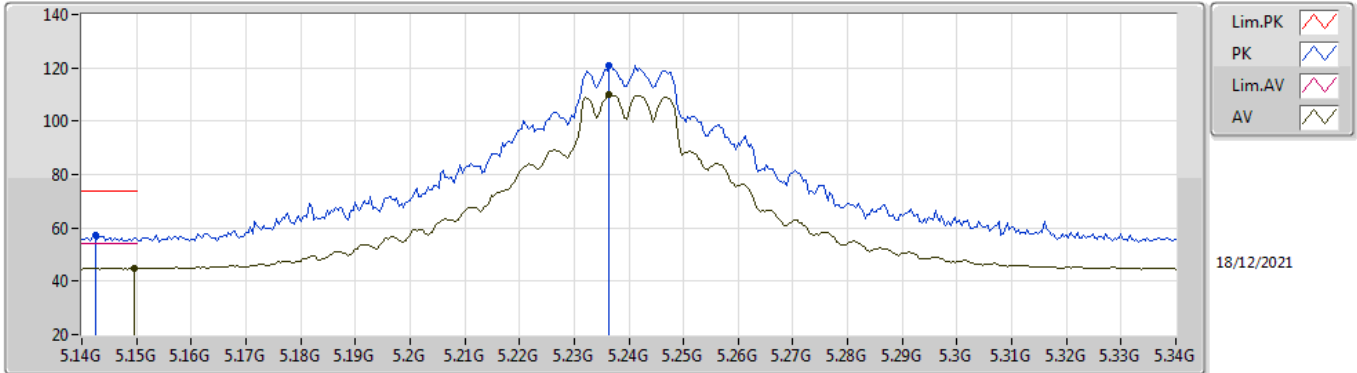

EUT_Z_2TX
Setting 25.5
02-B-S-5-10

Type	Freq (Hz)	Level (dBuV/m)	Limit (dBuV/m)	Margin (dB)	Raw (dBuV)	Dist (m)	Condition	Azimuth (°)	Height (m)	Comment	AF (dB)	CL (dB)	PA (dB)
PK	5.1424G	57.31	74.00	-16.69	50.72	3	Vertical	277	2.88	-	33.50	5.24	32.15
AV	5.1496G	44.92	54.00	-9.08	38.32	3	Vertical	277	2.88	-	33.50	5.25	32.15
PK	5.2364G	121.03	Inf	-Inf	114.29	3	Vertical	277	2.88	-	33.57	5.32	32.15
AV	5.2364G	110.23	Inf	-Inf	103.49	3	Vertical	277	2.88	-	33.57	5.32	32.15

802.11a_Nss1,(6Mbps)_2TX

5240MHz_TnomVnom

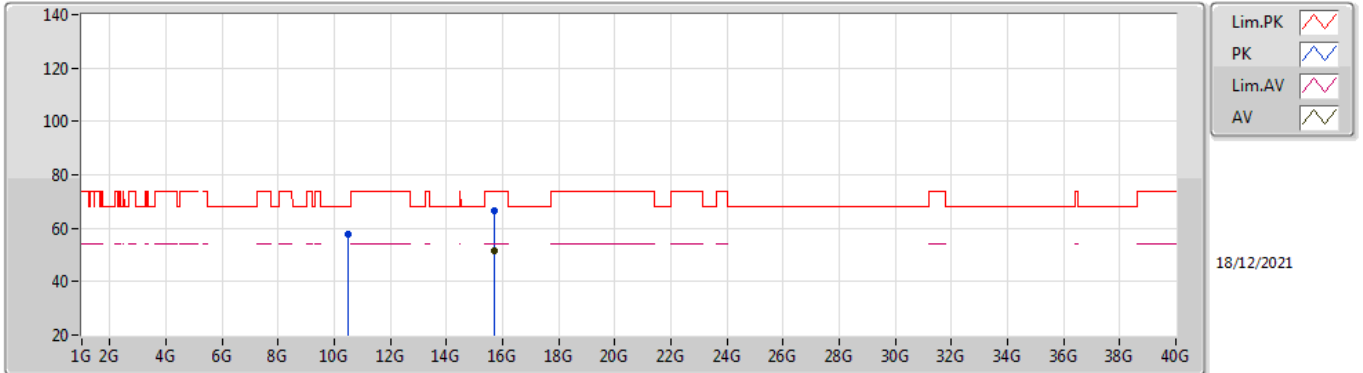

EUT_Z_2TX
Setting 25.5
02-B-S-5

Type	Freq (Hz)	Level (dBuV/m)	Limit (dBuV/m)	Margin (dB)	Raw (dBuV)	Dist (m)	Condition	Azimuth (°)	Height (m)	Comment	AF (dB)	CL (dB)	PA (dB)
PK	10.48168G	57.70	68.20	-10.50	44.85	3	Vertical	13	2.78	-	38.40	7.49	33.04
PK	15.71784G	66.77	74.00	-7.23	52.91	3	Vertical	357	2.08	-	37.40	9.87	33.41
AV	15.72364G	51.38	54.00	-2.62	37.51	3	Vertical	357	2.08	-	37.40	9.88	33.41

802.11a_Nss1,(6Mbps)_2TX

5240MHz_TnomVnom

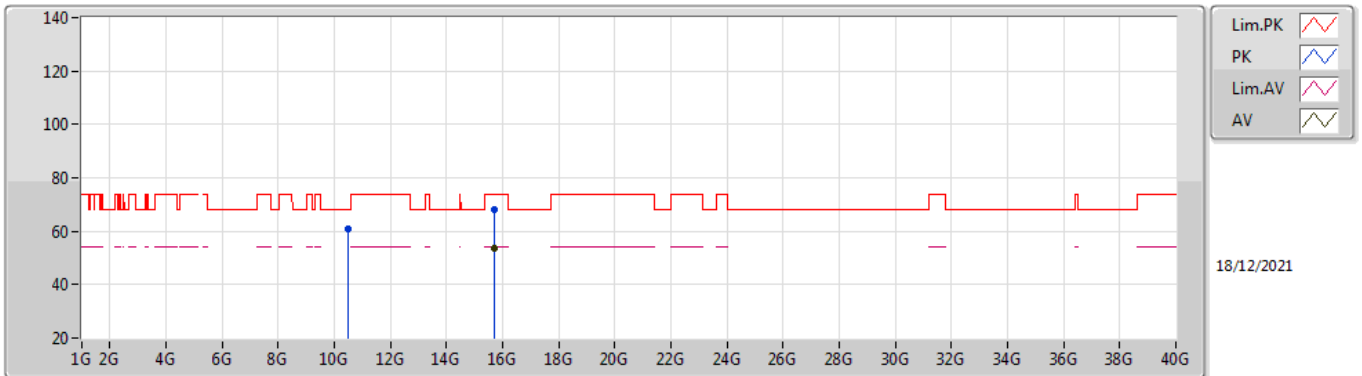

EUT_Z_2TX
Setting 25.5
02-B-S-5

Type	Freq (Hz)	Level (dBuV/m)	Limit (dBuV/m)	Margin (dB)	Raw (dBuV)	Dist (m)	Condition	Azimuth (°)	Height (m)	Comment	AF (dB)	CL (dB)	PA (dB)
PK	10.48012G	60.61	68.20	-7.59	47.76	3	Horizontal	331	2.01	-	38.40	7.49	33.04
PK	15.71796G	68.29	74.00	-5.71	54.43	3	Horizontal	32	2.01	-	37.40	9.87	33.41
AV	15.72276G	53.79	54.00	-0.21	39.92	3	Horizontal	32	2.01	-	37.40	9.88	33.41

802.11a_Nss1,(6Mbps)_2TX

5745MHz_TnomVnom

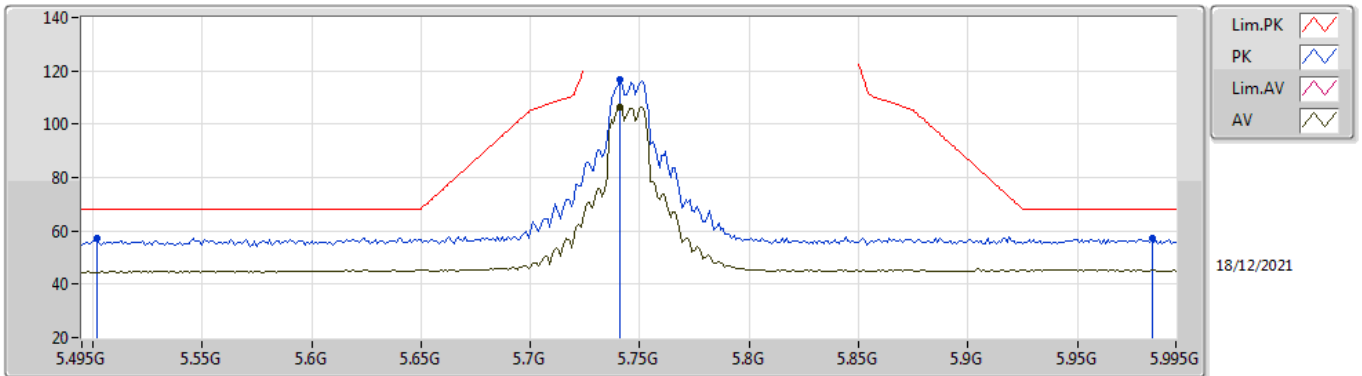

EUT_Z_2TX
Setting 22
02-B-S-5-10

Type	Freq (Hz)	Level (dBuV/m)	Limit (dBuV/m)	Margin (dB)	Raw (dBuV)	Dist (m)	Condition	Azimuth (°)	Height (m)	Comment	AF (dB)	CL (dB)	PA (dB)
PK	5.502G	57.48	68.20	-10.72	50.21	3	Vertical	313	1.88	-	33.90	5.50	32.13
PK	5.741G	116.72	Inf	-Inf	109.48	3	Vertical	313	1.88	-	33.78	5.60	32.14
AV	5.741G	106.49	Inf	-Inf	99.25	3	Vertical	313	1.88	-	33.78	5.60	32.14
PK	5.984G	57.11	68.20	-11.09	49.39	3	Vertical	313	1.88	-	34.10	5.78	32.16

802.11a_Nss1,(6Mbps)_2TX

5745MHz_TnomVnom

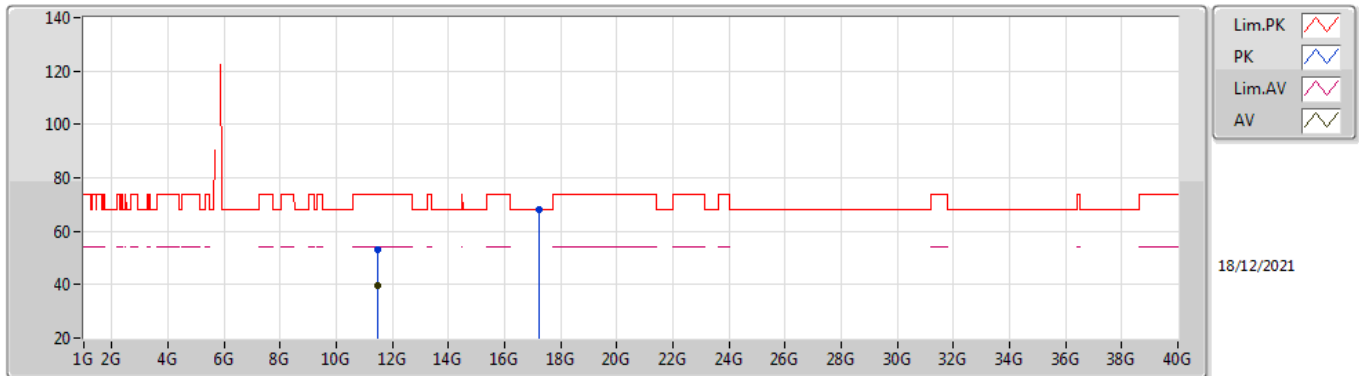

EUT_Z_2TX
Setting 22
02-B-S-5

Type	Freq (Hz)	Level (dBuV/m)	Limit (dBuV/m)	Margin (dB)	Raw (dBuV)	Dist (m)	Condition	Azimuth (°)	Height (m)	Comment	AF (dB)	CL (dB)	PA (dB)
PK	11.49248G	53.28	74.00	-20.72	39.62	3	Vertical	63	3.00	-	38.98	7.90	33.22
AV	11.49244G	39.61	54.00	-14.39	25.95	3	Vertical	63	3.00	-	38.98	7.90	33.22
PK	17.23884G	67.96	68.20	-0.24	48.49	3	Vertical	93	1.91	-	42.12	10.62	33.27

802.11a_Nss1,(6Mbps)_2TX

5745MHz_TnomVnom

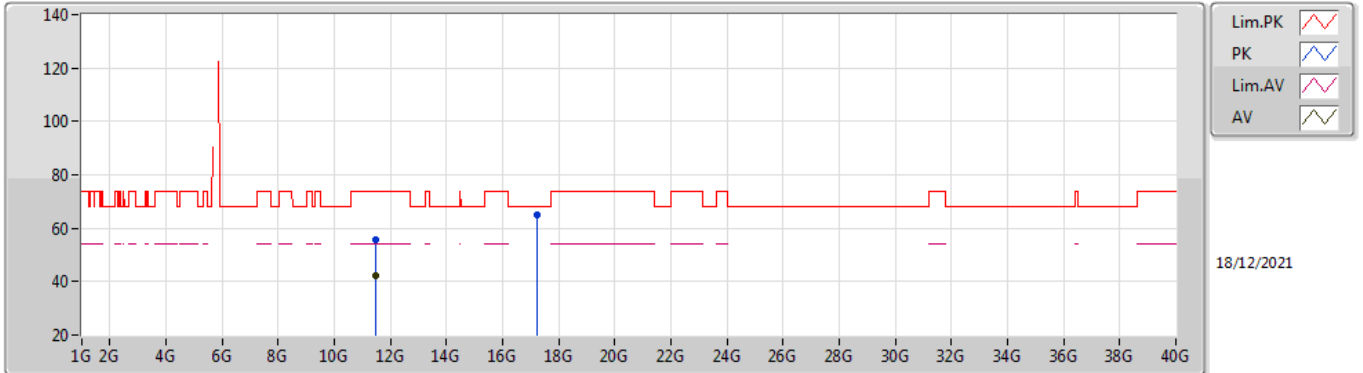

EUT_Z_2TX
Setting 22
02-B-S-5

Type	Freq (Hz)	Level (dBuV/m)	Limit (dBuV/m)	Margin (dB)	Raw (dBuV)	Dist (m)	Condition	Azimuth (°)	Height (m)	Comment	AF (dB)	CL (dB)	PA (dB)
PK	11.49164G	55.45	74.00	-18.55	41.79	3	Horizontal	334	1.00	-	38.98	7.90	33.22
AV	11.49208G	42.27	54.00	-11.73	28.61	3	Horizontal	334	1.00	-	38.98	7.90	33.22
PK	17.24036G	65.20	68.20	-3.00	45.73	3	Horizontal	80	1.86	-	42.12	10.62	33.27

802.11a_Nss1,(6Mbps)_2TX

5785MHz_TnomVnom

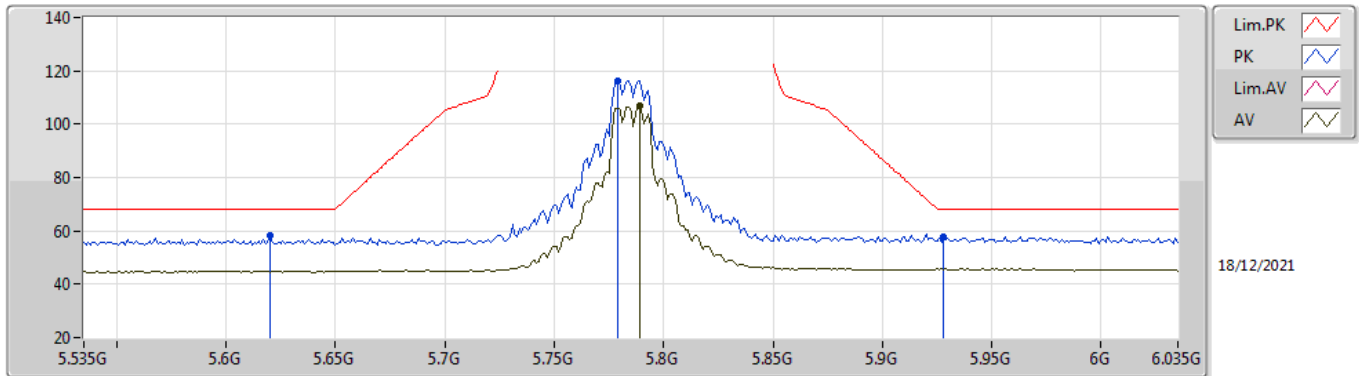

EUT Z_2TX
Setting 22.5
02-B-S-5-10

Type	Freq (Hz)	Level (dBuV/m)	Limit (dBuV/m)	Margin (dB)	Raw (dBuV)	Dist (m)	Condition	Azimuth (°)	Height (m)	Comment	AF (dB)	CL (dB)	PA (dB)
PK	5.62G	58.33	68.20	-9.87	51.01	3	Vertical	227	1.79	-	33.86	5.60	32.14
PK	5.779G	116.44	Inf	-Inf	109.25	3	Vertical	227	1.79	-	33.74	5.60	32.15
AV	5.789G	106.65	Inf	-Inf	99.48	3	Vertical	227	1.79	-	33.72	5.60	32.15
PK	5.928G	57.99	68.20	-10.21	50.36	3	Vertical	227	1.79	-	34.06	5.73	32.16

802.11a_Nss1,(6Mbps)_2TX

5785MHz_TnomVnom

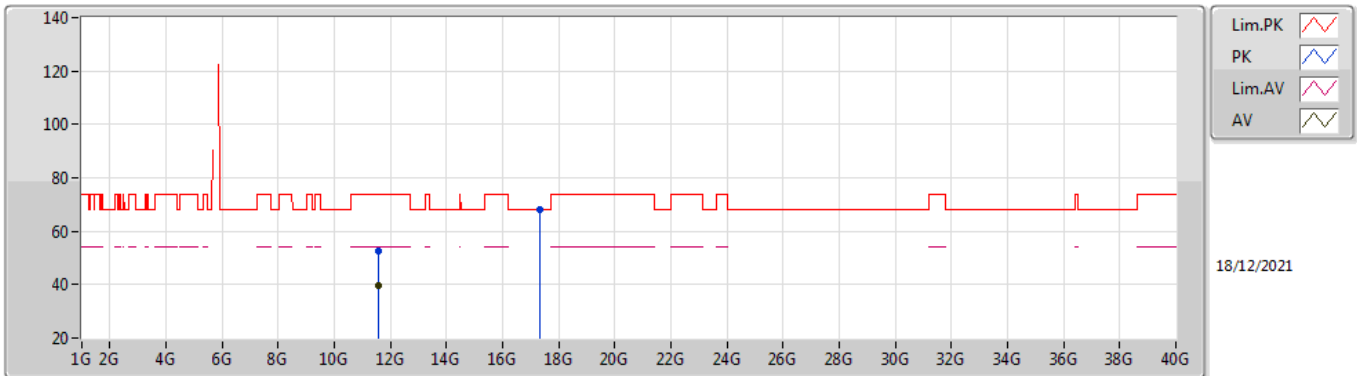

EUT_Z_2TX
Setting 22.5
02-B-S-5

Type	Freq (Hz)	Level (dBuV/m)	Limit (dBuV/m)	Margin (dB)	Raw (dBuV)	Dist (m)	Condition	Azimuth (°)	Height (m)	Comment	AF (dB)	CL (dB)	PA (dB)
PK	11.57232G	52.71	74.00	-21.29	38.80	3	Vertical	342	2.40	-	39.22	7.93	33.24
AV	11.56836G	39.67	54.00	-14.33	25.77	3	Vertical	342	2.40	-	39.21	7.93	33.24
PK	17.3494G	67.86	68.20	-0.34	47.63	3	Vertical	92	1.94	-	42.70	10.67	33.14

802.11a_Nss1,(6Mbps)_2TX

5785MHz_TnomVnom

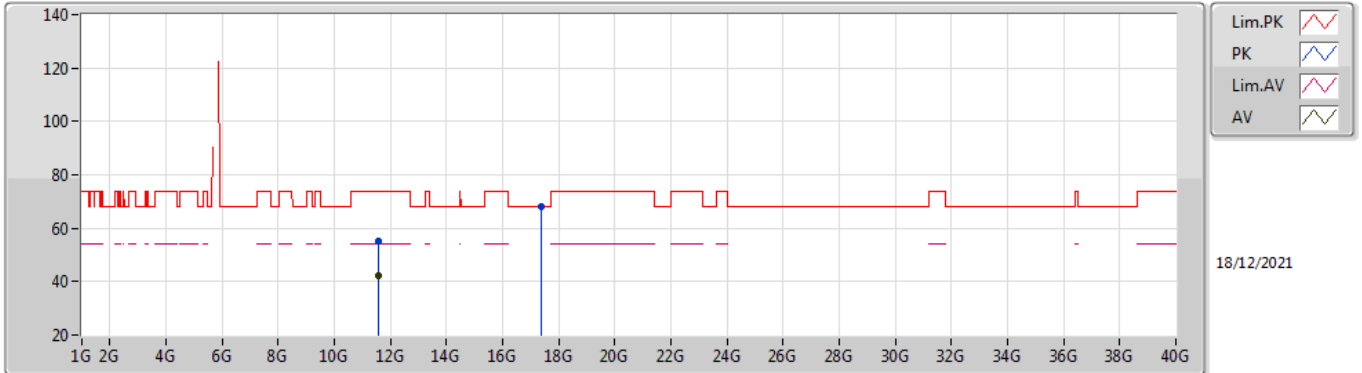

EUT_Z_2TX
Setting 22.5
02-B-S-5

Type	Freq (Hz)	Level (dBuV/m)	Limit (dBuV/m)	Margin (dB)	Raw (dBuV)	Dist (m)	Condition	Azimuth (°)	Height (m)	Comment	AF (dB)	CL (dB)	PA (dB)
PK	11.57124G	55.00	74.00	-19.00	41.10	3	Horizontal	339	1.96	-	39.21	7.93	33.24
AV	11.57172G	42.07	54.00	-11.93	28.16	3	Horizontal	339	1.96	-	39.22	7.93	33.24
PK	17.36488G	67.87	68.20	-0.33	47.49	3	Horizontal	322	2.94	-	42.82	10.68	33.12

802.11a_Nss1,(6Mbps)_2TX

5825MHz_TnomVnom

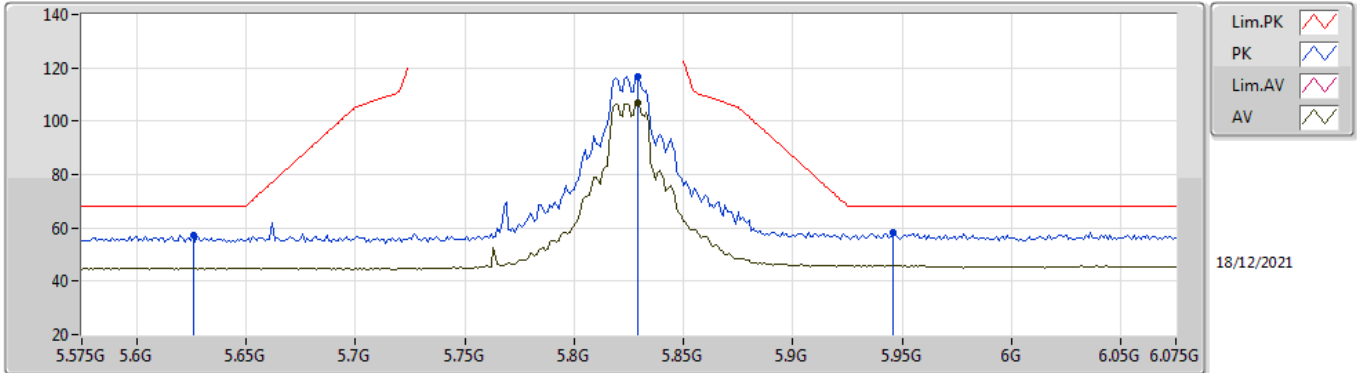

EUT Z_2TX
Setting 22.5
02-B-S-5-10

Type	Freq (Hz)	Level (dBuV/m)	Limit (dBuV/m)	Margin (dB)	Raw (dBuV)	Dist (m)	Condition	Azimuth (°)	Height (m)	Comment	AF (dB)	CL (dB)	PA (dB)
PK	5.626G	57.11	68.20	-11.09	49.80	3	Vertical	227	1.85	-	33.85	5.60	32.14
PK	5.829G	116.87	Inf	-Inf	109.63	3	Vertical	227	1.85	-	33.76	5.63	32.15
AV	5.829G	106.68	Inf	-Inf	99.44	3	Vertical	227	1.85	-	33.76	5.63	32.15
PK	5.946G	58.35	68.20	-9.85	50.67	3	Vertical	227	1.85	-	34.09	5.75	32.16

802.11a_Nss1,(6Mbps)_2TX

5825MHz_TnomVnom

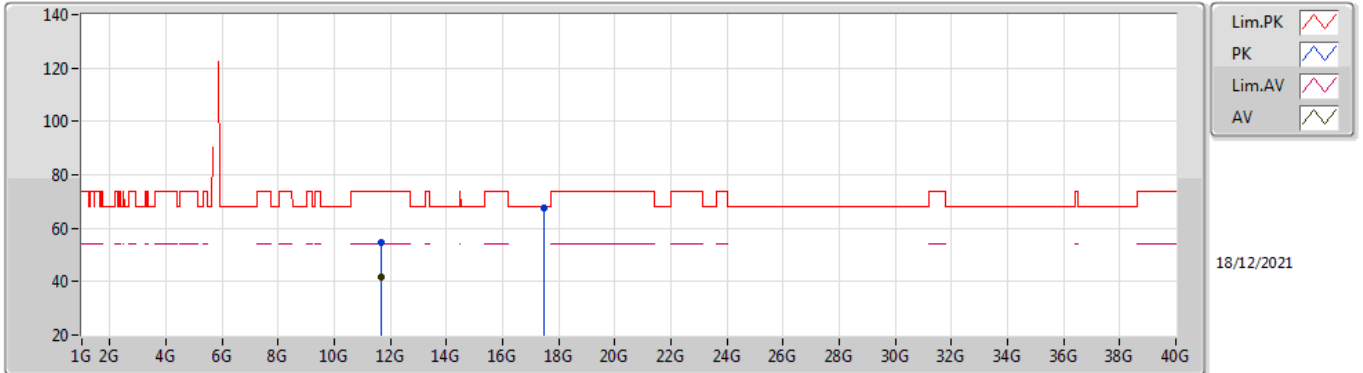

EUT_Z_2TX
Setting 22.5
02-B-S-5

Type	Freq (Hz)	Level (dBuV/m)	Limit (dBuV/m)	Margin (dB)	Raw (dBuV)	Dist (m)	Condition	Azimuth (°)	Height (m)	Comment	AF (dB)	CL (dB)	PA (dB)
PK	11.65424G	54.59	74.00	-19.41	40.54	3	Vertical	81	1.00	-	39.35	7.96	33.26
AV	11.64972G	41.62	54.00	-12.38	27.57	3	Vertical	81	1.00	-	39.35	7.96	33.26
PK	17.47564G	67.83	68.20	-0.37	46.46	3	Vertical	108	1.96	-	43.63	10.74	33.00

802.11a_Nss1,(6Mbps)_2TX

5825MHz_TnomVnom

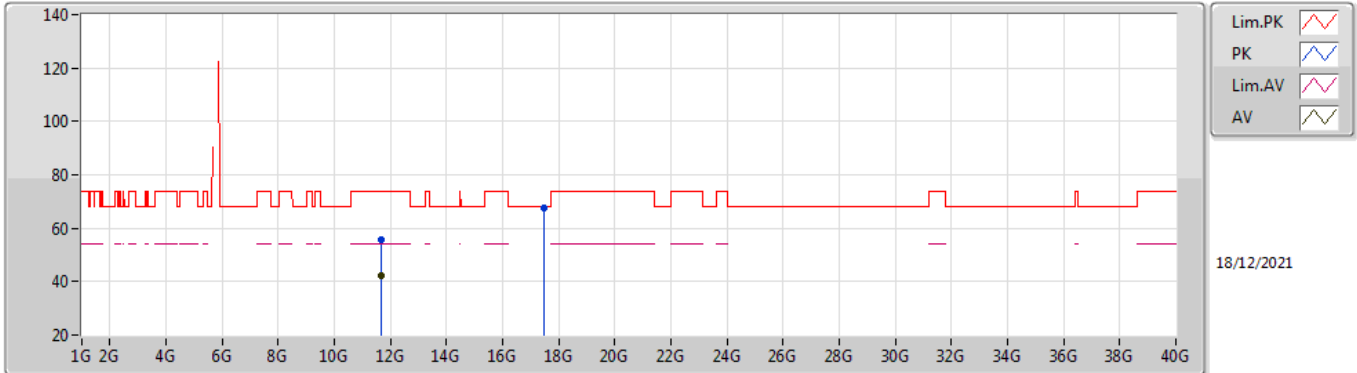

EUT_Z_2TX
Setting 22.5
02-B-S-5

Type	Freq (Hz)	Level (dBuV/m)	Limit (dBuV/m)	Margin (dB)	Raw (dBuV)	Dist (m)	Condition	Azimuth (°)	Height (m)	Comment	AF (dB)	CL (dB)	PA (dB)
PK	11.65336G	55.50	74.00	-18.50	41.45	3	Horizontal	335	1.92	-	39.35	7.96	33.26
AV	11.65272G	42.14	54.00	-11.86	28.09	3	Horizontal	335	1.92	-	39.35	7.96	33.26
PK	17.47096G	67.76	68.20	-0.44	46.42	3	Horizontal	38	2.00	-	43.60	10.74	33.00

802.11ac VHT20_Nss1,(MCS0)_2TX

5180MHz_TnomVnom

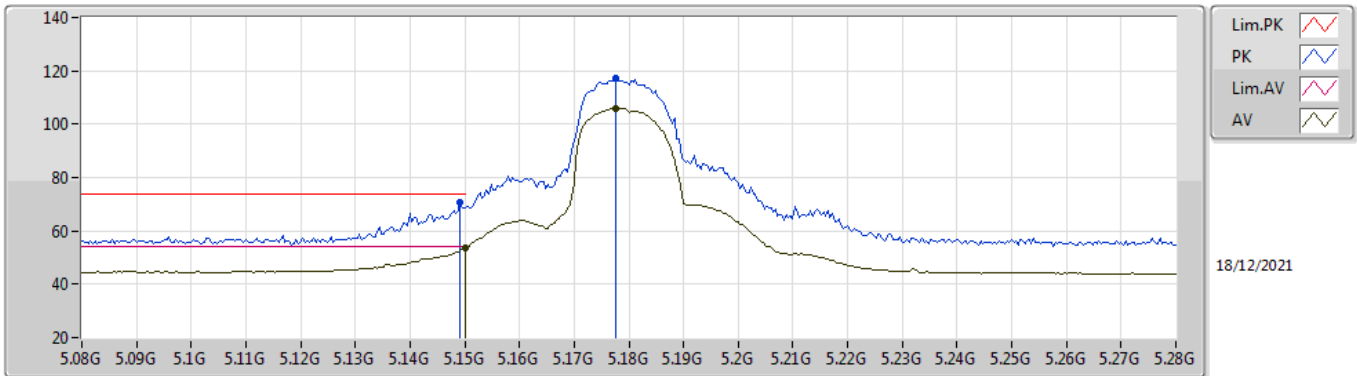

EUT_Z_2TX
Setting 21
02-B-S-5-10

Type	Freq (Hz)	Level (dBuV/m)	Limit (dBuV/m)	Margin (dB)	Raw (dBuV)	Dist (m)	Condition	Azimuth (°)	Height (m)	Comment	AF (dB)	CL (dB)	PA (dB)
PK	5.1492G	70.56	74.00	-3.44	63.96	3	Vertical	343	1.77	-	33.50	5.25	32.15
AV	5.15G	53.65	54.00	-0.35	47.05	3	Vertical	343	1.77	-	33.50	5.25	32.15
PK	5.1776G	117.24	Inf	-Inf	110.61	3	Vertical	343	1.77	-	33.50	5.28	32.15
AV	5.1776G	105.98	Inf	-Inf	99.35	3	Vertical	343	1.77	-	33.50	5.28	32.15

802.11ac VHT20_Nss1,(MCS0)_2TX

5180MHz_TnomVnom

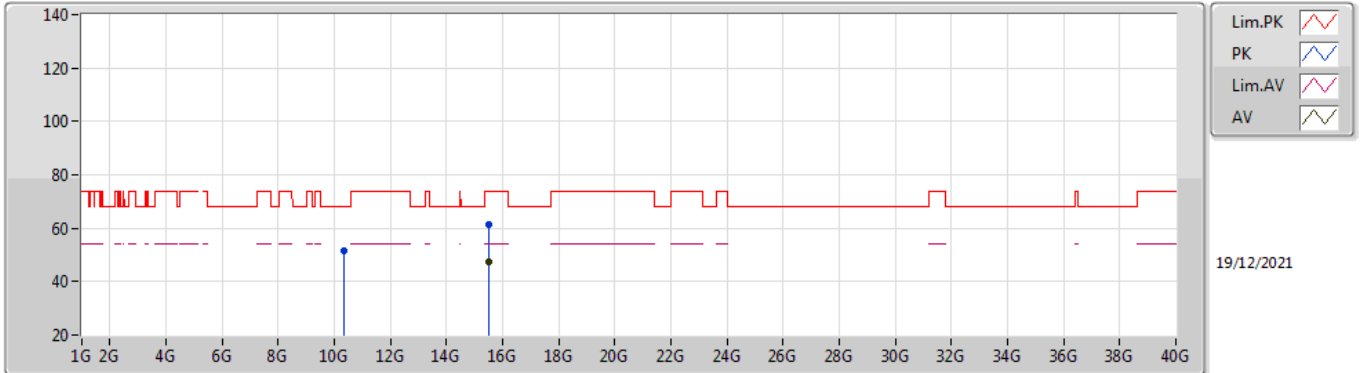

EUT_Z_2TX
Setting 21
02-B-S-5

Type	Freq (Hz)	Level (dBuV/m)	Limit (dBuV/m)	Margin (dB)	Raw (dBuV)	Dist (m)	Condition	Azimuth (°)	Height (m)	Comment	AF (dB)	CL (dB)	PA (dB)
PK	10.36708G	51.45	68.20	-16.75	38.53	3	Vertical	153	1.59	-	38.43	7.45	32.96
PK	15.53084G	61.29	74.00	-12.71	46.88	3	Vertical	9	1.97	-	37.81	9.79	33.19
AV	15.53192G	47.34	54.00	-6.66	32.94	3	Vertical	9	1.97	-	37.80	9.79	33.19

802.11ac VHT20_Nss1,(MCS0)_2TX

5180MHz_TnomVnom

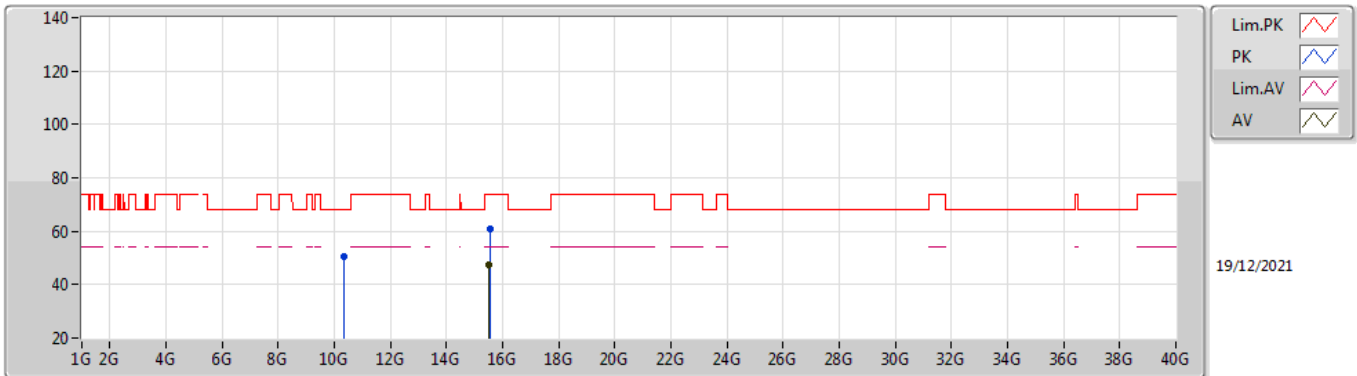

EUT_Z_2TX
Setting 21
02-B-S-5

Type	Freq (Hz)	Level (dBuV/m)	Limit (dBuV/m)	Margin (dB)	Raw (dBuV)	Dist (m)	Condition	Azimuth (°)	Height (m)	Comment	AF (dB)	CL (dB)	PA (dB)
PK	10.356G	50.70	68.20	-17.50	37.77	3	Horizontal	316	2.95	-	38.44	7.44	32.95
PK	15.53724G	60.88	74.00	-13.12	46.49	3	Horizontal	153	2.80	-	37.79	9.79	33.19
AV	15.53004G	47.32	54.00	-6.68	32.91	3	Horizontal	153	2.80	-	37.81	9.79	33.19

802.11ac VHT20_Nss1,(MCS0)_2TX

5200MHz_TnomVnom

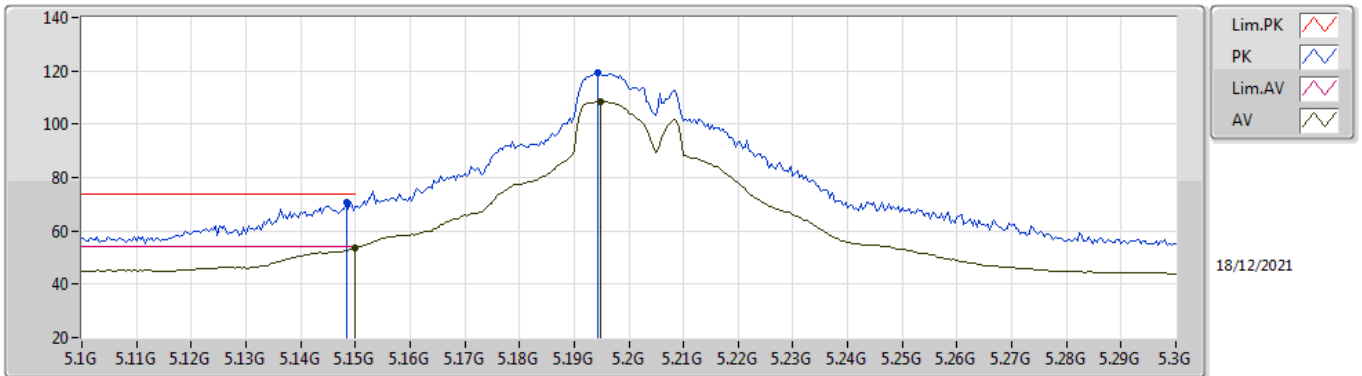

EUT_Z_2TX
Setting 25
02-B-S-5-10

Type	Freq (Hz)	Level (dBuV/m)	Limit (dBuV/m)	Margin (dB)	Raw (dBuV)	Dist (m)	Condition	Azimuth (°)	Height (m)	Comment	AF (dB)	CL (dB)	PA (dB)
PK	5.1484G	70.91	74.00	-3.09	64.31	3	Vertical	309	1.80	-	33.50	5.25	32.15
AV	5.15G	53.60	54.00	-0.40	47.00	3	Vertical	309	1.80	-	33.50	5.25	32.15
PK	5.1944G	119.32	Inf	-Inf	112.68	3	Vertical	309	1.80	-	33.50	5.29	32.15
AV	5.1948G	108.46	Inf	-Inf	101.82	3	Vertical	309	1.80	-	33.50	5.29	32.15

802.11ac VHT20_Nss1,(MCS0)_2TX

5200MHz_TnomVnom

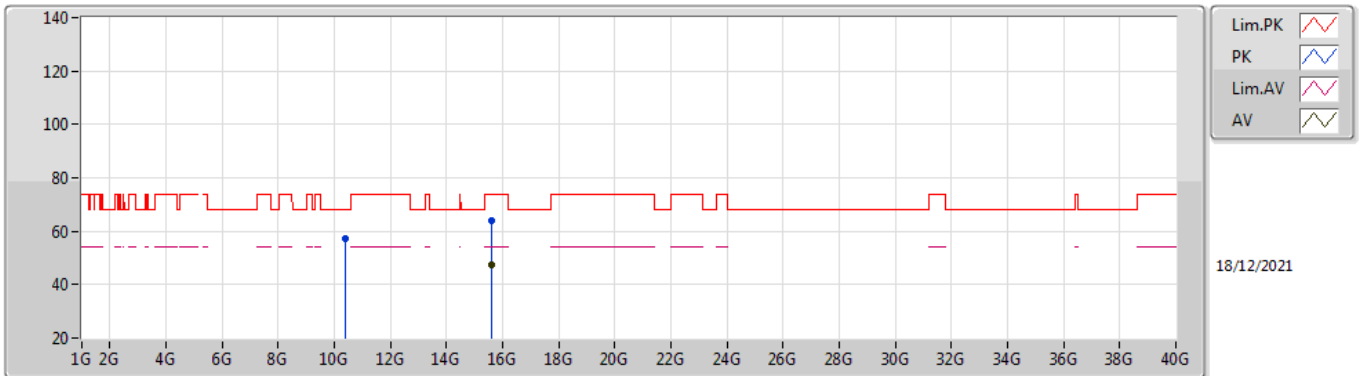

EUT_Z_2TX
Setting 25
02-B-S-5

Type	Freq (Hz)	Level (dBuV/m)	Limit (dBuV/m)	Margin (dB)	Raw (dBuV)	Dist (m)	Condition	Azimuth (°)	Height (m)	Comment	AF (dB)	CL (dB)	PA (dB)
PK	10.39812G	57.16	68.20	-11.04	44.28	3	Vertical	352	2.23	-	38.40	7.46	32.98
PK	15.59476G	63.75	74.00	-10.25	49.57	3	Vertical	114	2.01	-	37.62	9.82	33.26
AV	15.5958G	47.64	54.00	-6.36	33.47	3	Vertical	114	2.01	-	37.61	9.82	33.26

802.11ac VHT20_Nss1,(MCS0)_2TX

5200MHz_TnomVnom

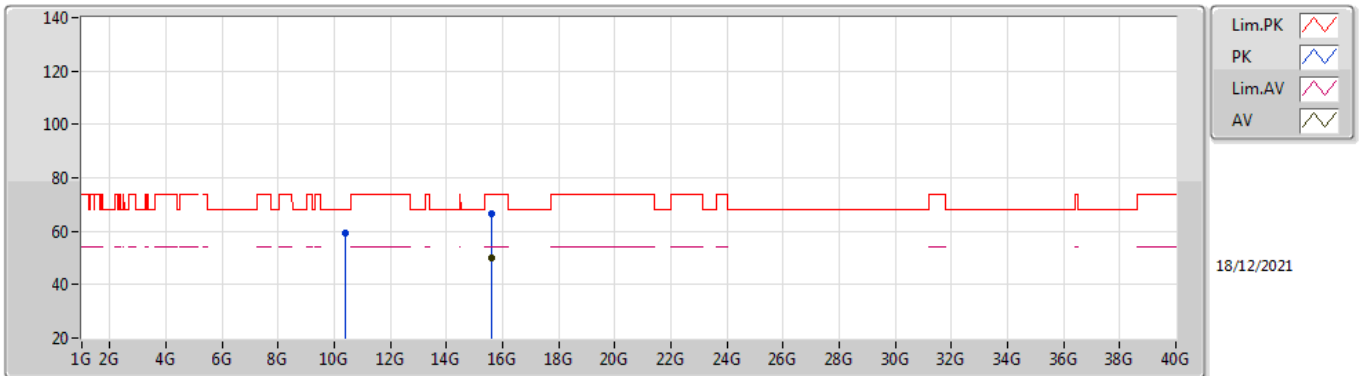

EUT_Z_2TX
Setting 25
02-B-S-5

Type	Freq (Hz)	Level (dBuV/m)	Limit (dBuV/m)	Margin (dB)	Raw (dBuV)	Dist (m)	Condition	Azimuth (°)	Height (m)	Comment	AF (dB)	CL (dB)	PA (dB)
PK	10.4004G	59.41	68.20	-8.79	46.53	3	Horizontal	332	2.00	-	38.40	7.46	32.98
PK	15.5916G	66.49	74.00	-7.51	52.30	3	Horizontal	37	2.05	-	37.63	9.82	33.26
AV	15.59256G	49.92	54.00	-4.08	35.74	3	Horizontal	37	2.05	-	37.62	9.82	33.26

802.11ac VHT20_Nss1,(MCS0)_2TX

5240MHz_TnomVnom

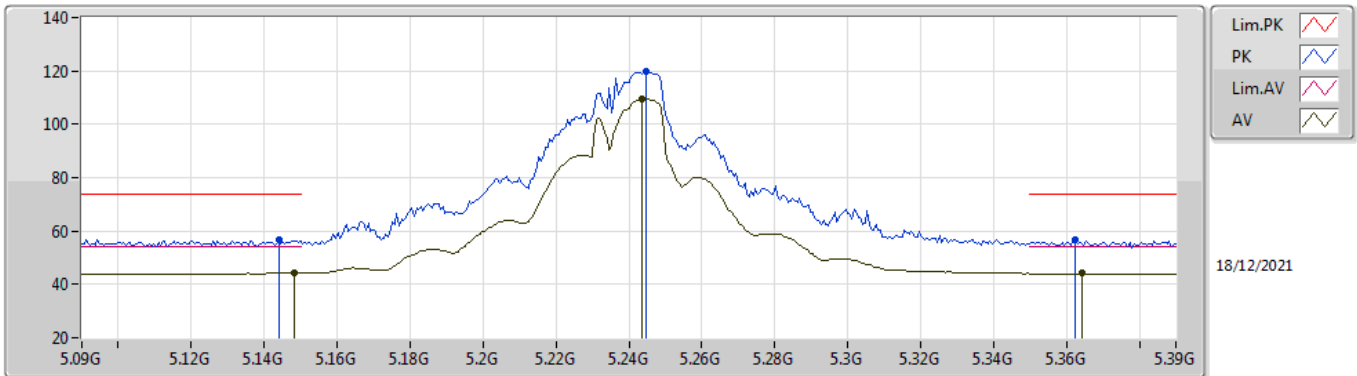

EUT_Z_2TX
Setting 27
02-B-S-5-10

Type	Freq (Hz)	Level (dBuV/m)	Limit (dBuV/m)	Margin (dB)	Raw (dBuV)	Dist (m)	Condition	Azimuth (°)	Height (m)	Comment	AF (dB)	CL (dB)	PA (dB)
PK	5.144G	56.73	74.00	-17.27	50.14	3	Vertical	280	1.80	-	33.50	5.24	32.15
AV	5.1482G	44.53	54.00	-9.47	37.93	3	Vertical	280	1.80	-	33.50	5.25	32.15
PK	5.2448G	119.85	Inf	-Inf	113.09	3	Vertical	280	1.80	-	33.59	5.32	32.15
AV	5.2436G	109.35	Inf	-Inf	102.59	3	Vertical	280	1.80	-	33.59	5.32	32.15
PK	5.3624G	56.84	74.00	-17.16	49.88	3	Vertical	280	1.80	-	33.72	5.38	32.14
AV	5.3642G	44.07	54.00	-9.93	37.10	3	Vertical	280	1.80	-	33.73	5.38	32.14

802.11ac VHT20_Nss1,(MCS0)_2TX

5240MHz_TnomVnom

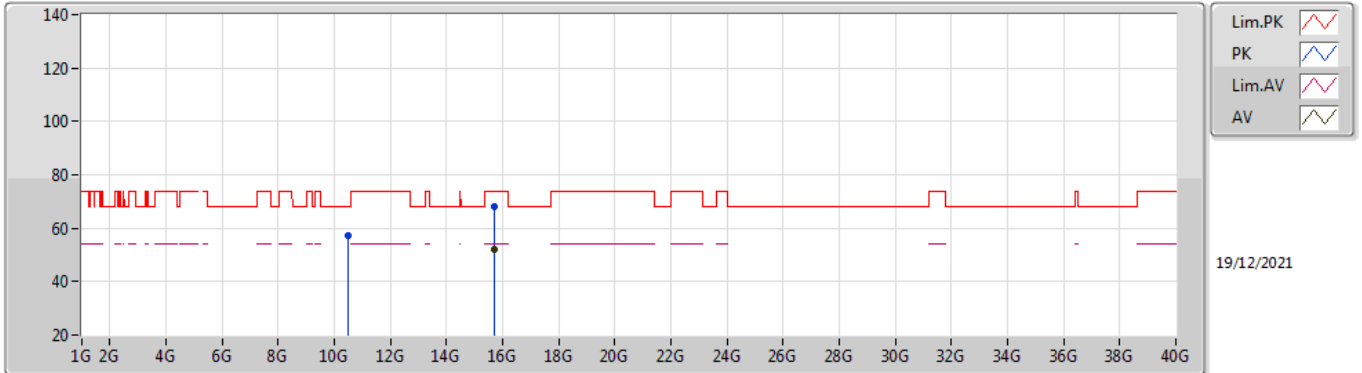

EUT_Z_2TX
Setting 27
02-B-S-5

Type	Freq (Hz)	Level (dBuV/m)	Limit (dBuV/m)	Margin (dB)	Raw (dBuV)	Dist (m)	Condition	Azimuth (°)	Height (m)	Comment	AF (dB)	CL (dB)	PA (dB)
PK	10.48556G	57.01	68.20	-11.19	44.16	3	Vertical	44	2.66	-	38.40	7.49	33.04
PK	15.71264G	68.18	74.00	-5.82	54.31	3	Vertical	356	2.04	-	37.40	9.87	33.40
AV	15.71384G	52.09	54.00	-1.91	38.22	3	Vertical	356	2.04	-	37.40	9.87	33.40

802.11ac VHT20_Nss1,(MCS0)_2TX

5240MHz_TnomVnom

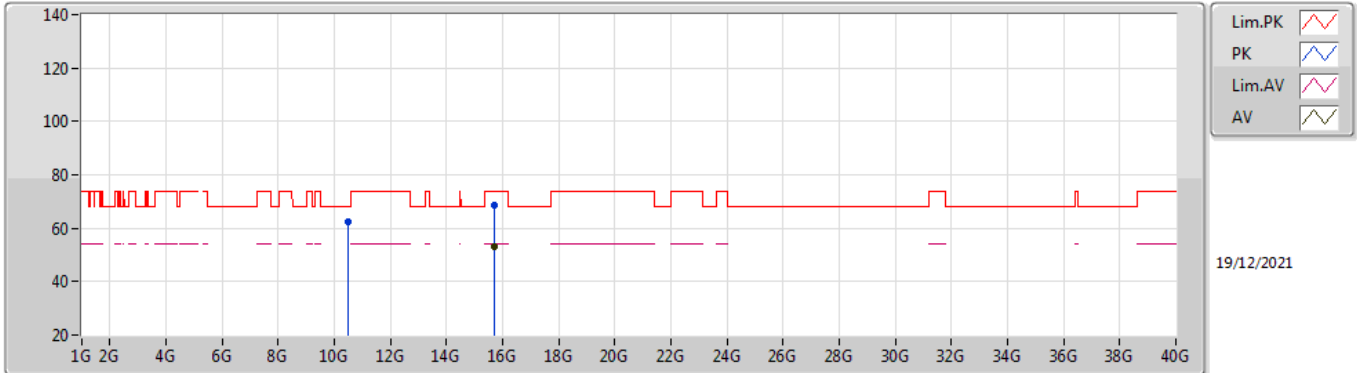

EUT_Z_2TX
Setting 27
02-B-S-5

Type	Freq (Hz)	Level (dBuV/m)	Limit (dBuV/m)	Margin (dB)	Raw (dBuV)	Dist (m)	Condition	Azimuth (°)	Height (m)	Comment	AF (dB)	CL (dB)	PA (dB)
PK	10.4806G	62.35	68.20	-5.85	49.50	3	Horizontal	329	2.02	-	38.40	7.49	33.04
PK	15.71396G	68.52	74.00	-5.48	54.65	3	Horizontal	33	2.02	-	37.40	9.87	33.40
AV	15.71384G	52.85	54.00	-1.15	38.98	3	Horizontal	33	2.02	-	37.40	9.87	33.40

802.11ac VHT20_Nss1,(MCS0)_2TX

5745MHz_TnomVnom

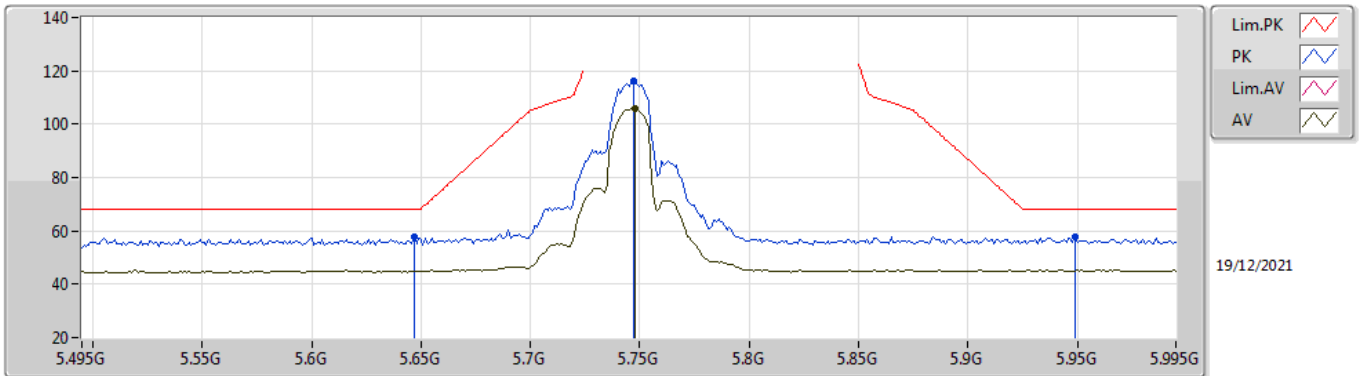

EUT_Z_2TX
Setting 22.5
02-B-S-5-10

Type	Freq (Hz)	Level (dBuV/m)	Limit (dBuV/m)	Margin (dB)	Raw (dBuV)	Dist (m)	Condition	Azimuth (°)	Height (m)	Comment	AF (dB)	CL (dB)	PA (dB)
PK	5.647G	57.51	68.20	-10.69	50.24	3	Vertical	308	2.02	-	33.81	5.60	32.14
PK	5.747G	116.36	Inf	-Inf	109.11	3	Vertical	308	2.02	-	33.79	5.60	32.14
AV	5.748G	106.02	Inf	-Inf	98.76	3	Vertical	308	2.02	-	33.80	5.60	32.14
PK	5.949G	57.59	68.20	-10.61	49.90	3	Vertical	308	2.02	-	34.10	5.75	32.16

802.11ac VHT20_Nss1,(MCS0)_2TX

5745MHz_TnomVnom

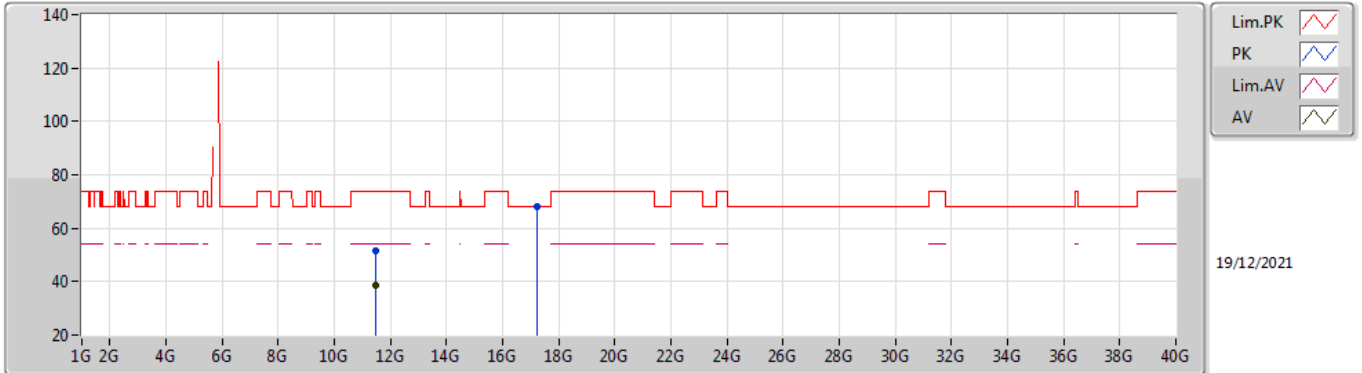

EUT_Z_2TX
Setting 22.5
02-B-S-5

Type	Freq (Hz)	Level (dBuV/m)	Limit (dBuV/m)	Margin (dB)	Raw (dBuV)	Dist (m)	Condition	Azimuth (°)	Height (m)	Comment	AF (dB)	CL (dB)	PA (dB)
PK	11.48884G	51.50	74.00	-22.50	37.84	3	Vertical	344	2.18	-	38.98	7.90	33.22
AV	11.48844G	38.43	54.00	-15.57	24.77	3	Vertical	344	2.18	-	38.98	7.90	33.22
PK	17.22652G	68.19	68.20	-0.01	48.78	3	Vertical	93	1.93	-	42.08	10.61	33.28

802.11ac VHT20_Nss1,(MCS0)_2TX

5745MHz_TnomVnom

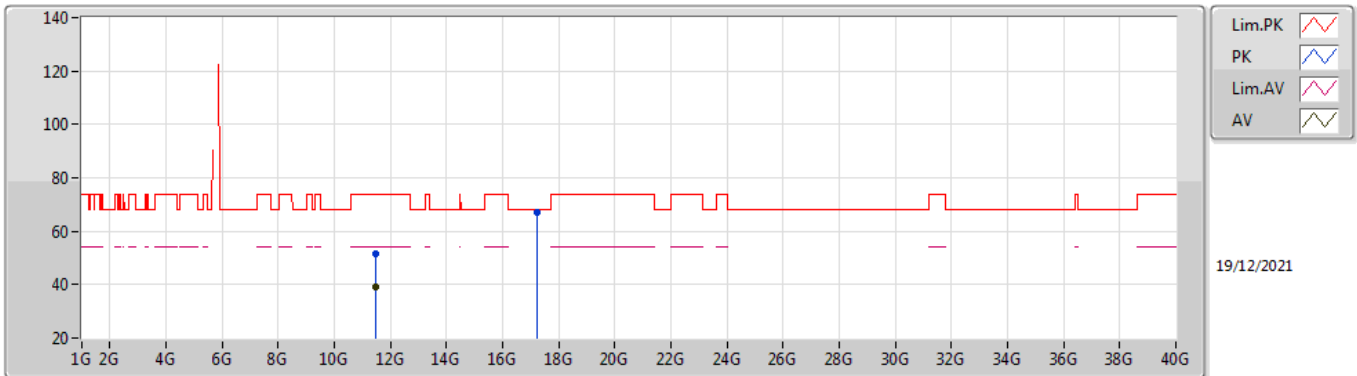

EUT_Z_2TX
Setting 22.5
02-B-S-5

Type	Freq (Hz)	Level (dBuV/m)	Limit (dBuV/m)	Margin (dB)	Raw (dBuV)	Dist (m)	Condition	Azimuth (°)	Height (m)	Comment	AF (dB)	CL (dB)	PA (dB)
PK	11.49364G	51.62	74.00	-22.38	37.95	3	Horizontal	187	2.74	-	38.99	7.90	33.22
AV	11.4908G	39.12	54.00	-14.88	25.46	3	Horizontal	187	2.74	-	38.98	7.90	33.22
PK	17.23132G	66.83	68.20	-1.37	47.40	3	Horizontal	80	1.86	-	42.09	10.62	33.28

802.11ac VHT20_Nss1,(MCS0)_2TX

5785MHz_TnomVnom

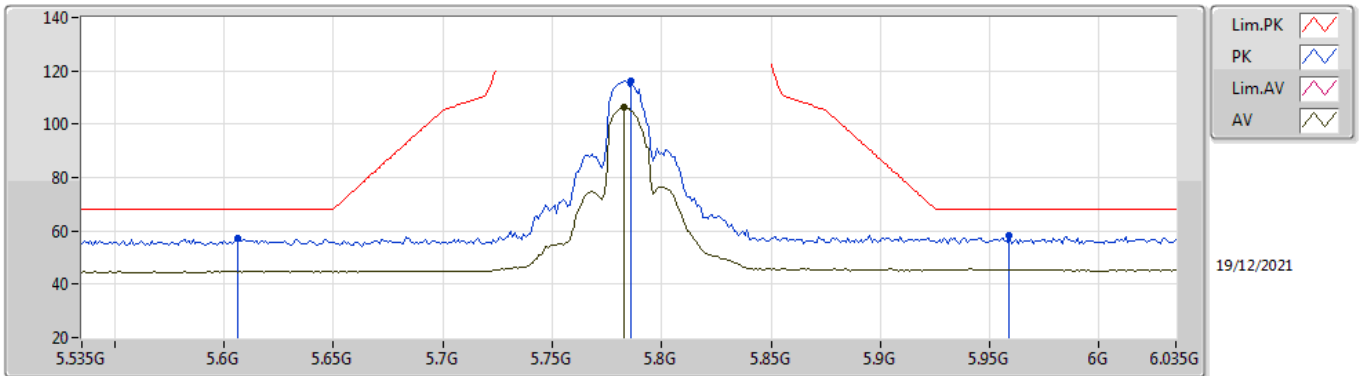

EUT_Z_2TX
Setting 22.5
02-B-S-5-10

Type	Freq (Hz)	Level (dBuV/m)	Limit (dBuV/m)	Margin (dB)	Raw (dBuV)	Dist (m)	Condition	Azimuth (°)	Height (m)	Comment	AF (dB)	CL (dB)	PA (dB)
PK	5.606G	57.02	68.20	-11.18	49.67	3	Vertical	221	1.87	-	33.89	5.60	32.14
PK	5.786G	116.17	Inf	-Inf	108.99	3	Vertical	221	1.87	-	33.73	5.60	32.15
AV	5.783G	106.36	Inf	-Inf	99.18	3	Vertical	221	1.87	-	33.73	5.60	32.15
PK	5.959G	58.21	68.20	-9.99	50.51	3	Vertical	221	1.87	-	34.10	5.76	32.16

802.11ac VHT20_Nss1,(MCS0)_2TX

5785MHz_TnomVnom

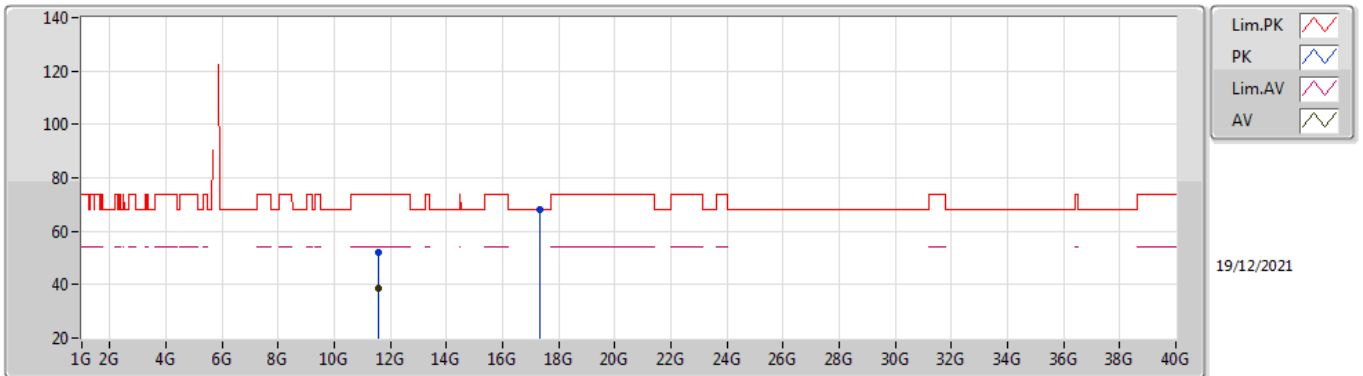

EUT_Z_2TX
Setting 22.5
02-B-S-5

Type	Freq (Hz)	Level (dBuV/m)	Limit (dBuV/m)	Margin (dB)	Raw (dBuV)	Dist (m)	Condition	Azimuth (°)	Height (m)	Comment	AF (dB)	CL (dB)	PA (dB)
PK	11.57032G	52.27	74.00	-21.73	38.37	3	Vertical	83	1.19	-	39.21	7.93	33.24
AV	11.56872G	38.64	54.00	-15.36	24.74	3	Vertical	83	1.19	-	39.21	7.93	33.24
PK	17.351G	68.15	68.20	-0.05	47.90	3	Vertical	93	1.96	-	42.71	10.68	33.14

802.11ac VHT20_Nss1,(MCS0)_2TX

5785MHz_TnomVnom

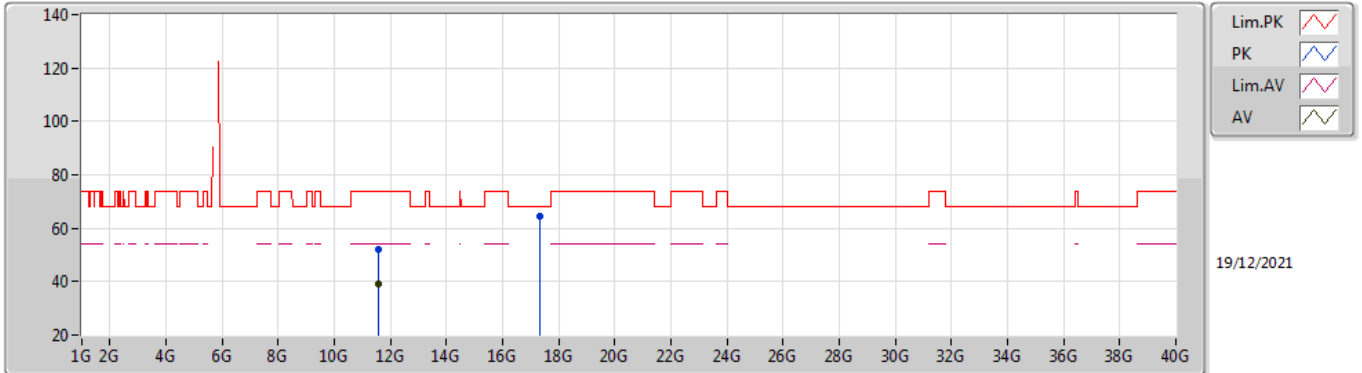

EUT_Z_2TX
Setting 22.5
02-B-S-5

Type	Freq (Hz)	Level (dBuV/m)	Limit (dBuV/m)	Margin (dB)	Raw (dBuV)	Dist (m)	Condition	Azimuth (°)	Height (m)	Comment	AF (dB)	CL (dB)	PA (dB)
PK	11.56064G	51.88	74.00	-22.12	38.02	3	Horizontal	336	2.65	-	39.18	7.92	33.24
AV	11.5764G	39.24	54.00	-14.76	25.32	3	Horizontal	336	2.65	-	39.23	7.93	33.24
PK	17.34848G	64.65	68.20	-3.55	44.43	3	Horizontal	33	2.00	-	42.69	10.67	33.14

802.11ac VHT20_Nss1,(MCS0)_2TX

5825MHz_TnomVnom

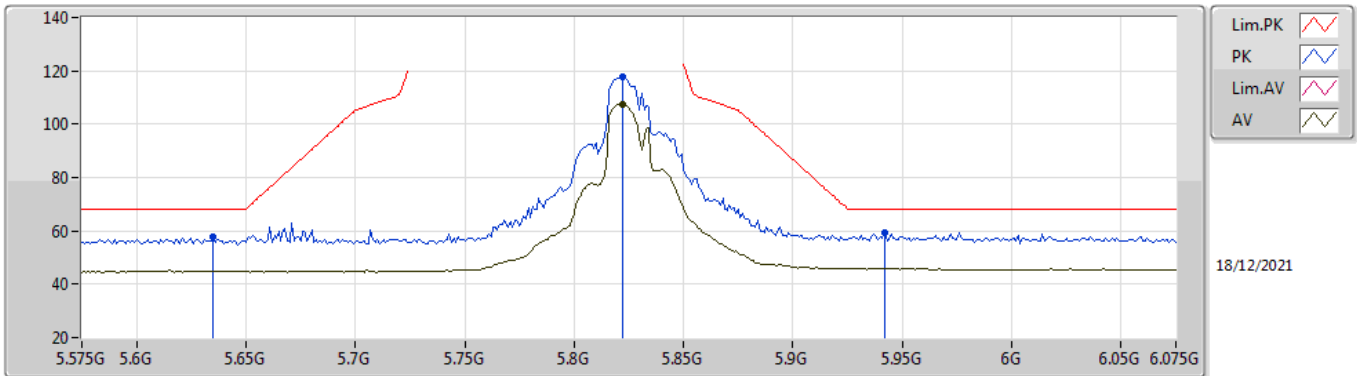

EUT_Z_2TX
Setting 23
02-B-S-5-10

Type	Freq (Hz)	Level (dBuV/m)	Limit (dBuV/m)	Margin (dB)	Raw (dBuV)	Dist (m)	Condition	Azimuth (°)	Height (m)	Comment	AF (dB)	CL (dB)	PA (dB)
PK	5.635G	57.51	68.20	-10.69	50.22	3	Vertical	227	1.87	-	33.83	5.60	32.14
PK	5.822G	117.57	Inf	-Inf	110.36	3	Vertical	227	1.87	-	33.74	5.62	32.15
AV	5.822G	107.50	Inf	-Inf	100.29	3	Vertical	227	1.87	-	33.74	5.62	32.15
PK	5.942G	59.14	68.20	-9.06	51.48	3	Vertical	227	1.87	-	34.08	5.74	32.16

802.11ac VHT20_Nss1,(MCS0)_2TX

5825MHz_TnomVnom

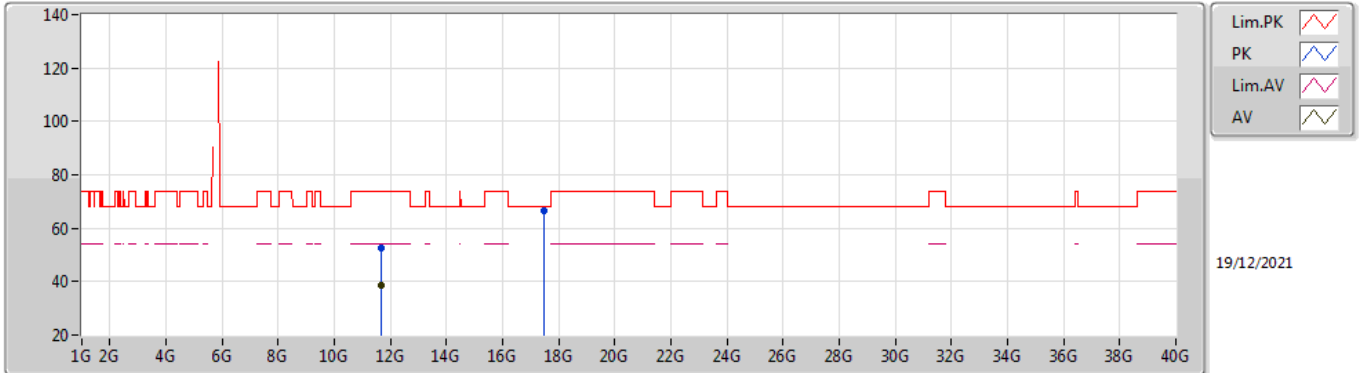

EUT_Z_2TX
Setting 23
02-B-S-5

Type	Freq (Hz)	Level (dBuV/m)	Limit (dBuV/m)	Margin (dB)	Raw (dBuV)	Dist (m)	Condition	Azimuth (°)	Height (m)	Comment	AF (dB)	CL (dB)	PA (dB)
PK	11.64796G	52.39	74.00	-21.61	38.34	3	Vertical	101	2.28	-	39.35	7.96	33.26
AV	11.6594G	38.59	54.00	-15.41	24.53	3	Vertical	101	2.28	-	39.36	7.96	33.26
PK	17.47636G	66.73	68.20	-1.47	45.36	3	Vertical	110	1.96	-	43.63	10.74	33.00

802.11ac VHT20_Nss1,(MCS0)_2TX

5825MHz_TnomVnom

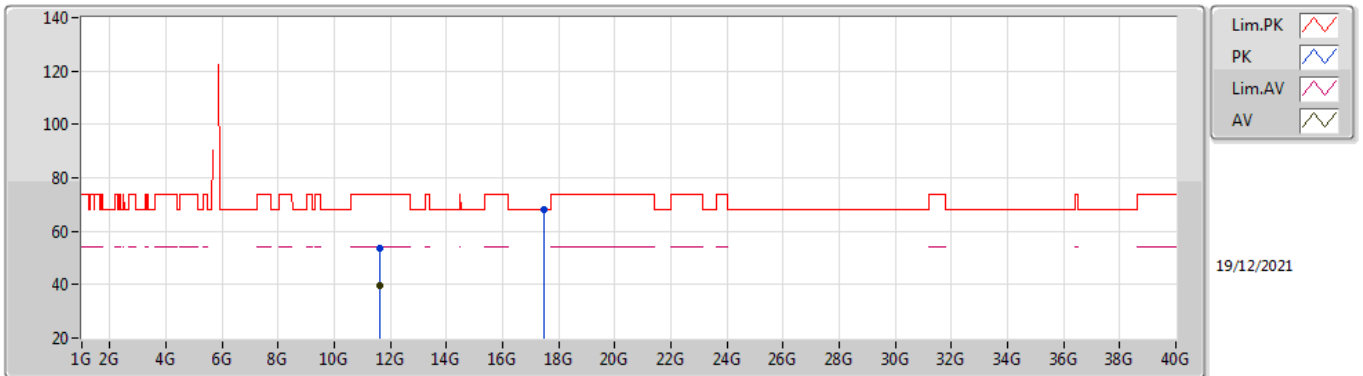

EUT_Z_2TX
Setting 23
02-B-S-5

Type	Freq (Hz)	Level (dBuV/m)	Limit (dBuV/m)	Margin (dB)	Raw (dBuV)	Dist (m)	Condition	Azimuth (°)	Height (m)	Comment	AF (dB)	CL (dB)	PA (dB)
PK	11.64152G	53.52	74.00	-20.48	39.48	3	Horizontal	4	1.58	-	39.34	7.96	33.26
AV	11.64568G	39.77	54.00	-14.23	25.72	3	Horizontal	4	1.58	-	39.35	7.96	33.26
PK	17.47948G	68.10	68.20	-0.10	46.69	3	Horizontal	38	2.00	-	43.66	10.74	32.99

802.11ac VHT40_Nss1,(MCS0)_2TX

5190MHz_TnomVnom

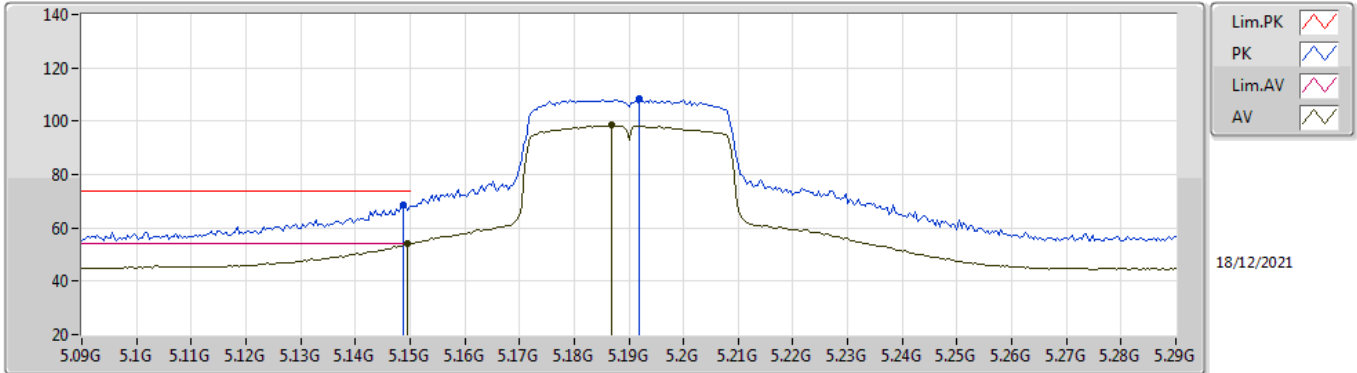

EUT_Z_2TX
Setting 19.5
02-B-S-5-10

Type	Freq (Hz)	Level (dBuV/m)	Limit (dBuV/m)	Margin (dB)	Raw (dBuV)	Dist (m)	Condition	Azimuth (°)	Height (m)	Comment	AF (dB)	CL (dB)	PA (dB)
PK	5.1488G	68.58	74.00	-5.42	61.98	3	Vertical	275	2.91	-	33.50	5.25	32.15
AV	5.1496G	53.91	54.00	-0.09	47.31	3	Vertical	275	2.91	-	33.50	5.25	32.15
PK	5.192G	108.36	Inf	-Inf	101.72	3	Vertical	275	2.91	-	33.50	5.29	32.15
AV	5.1868G	98.40	Inf	-Inf	91.76	3	Vertical	275	2.91	-	33.50	5.29	32.15

802.11ac VHT40_Nss1,(MCS0)_2TX

5190MHz_TnomVnom

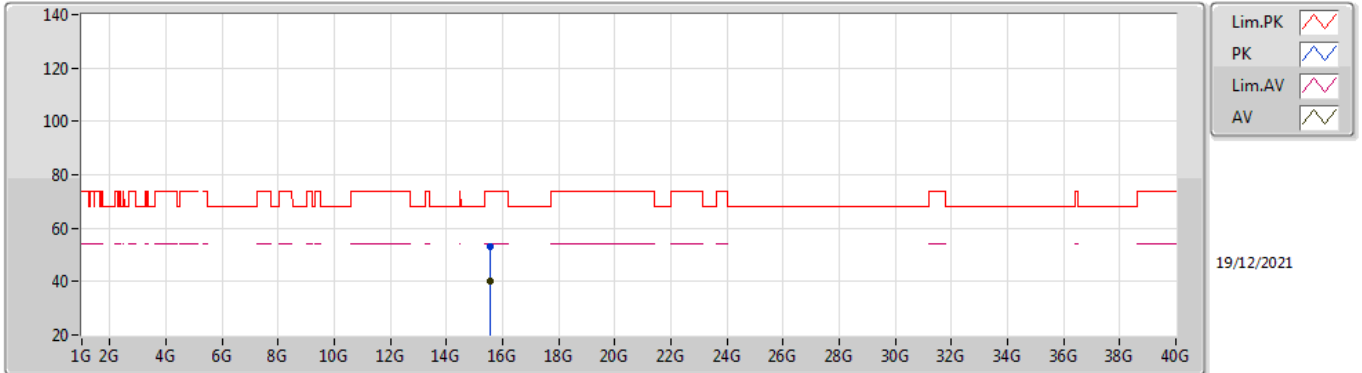

EUT_Z_2TX
Setting 19.5
02-B-S-5

Type	Freq (Hz)	Level (dBuV/m)	Limit (dBuV/m)	Margin (dB)	Raw (dBuV)	Dist (m)	Condition	Azimuth (°)	Height (m)	Comment	AF (dB)	CL (dB)	PA (dB)
PK	15.56974G	53.20	74.00	-20.80	38.93	3	Vertical	14	1.70	-	37.69	9.81	33.23
AV	15.56752G	39.98	54.00	-14.02	25.70	3	Vertical	14	1.70	-	37.70	9.81	33.23

802.11ac VHT40_Nss1,(MCS0)_2TX

5190MHz_TnomVnom

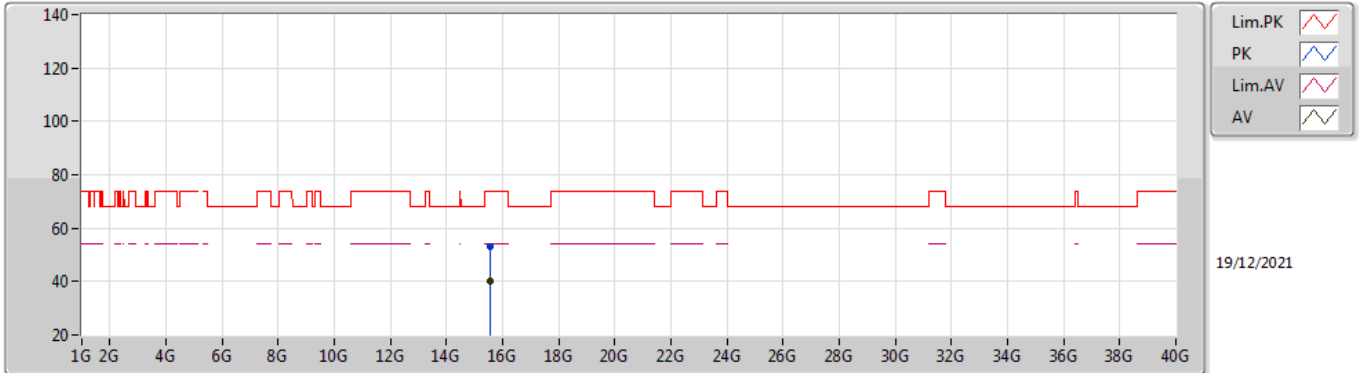

EUT_Z_2TX
Setting 19.5
02-B-S-5

Type	Freq (Hz)	Level (dBuV/m)	Limit (dBuV/m)	Margin (dB)	Raw (dBuV)	Dist (m)	Condition	Azimuth (°)	Height (m)	Comment	AF (dB)	CL (dB)	PA (dB)
PK	15.56844G	53.21	74.00	-20.79	38.94	3	Horizontal	304	2.26	-	37.69	9.81	33.23
AV	15.57186G	39.92	54.00	-14.08	25.66	3	Horizontal	304	2.26	-	37.68	9.81	33.23

802.11ac VHT40_Nss1,(MCS0)_2TX

5230MHz_TnomVnom

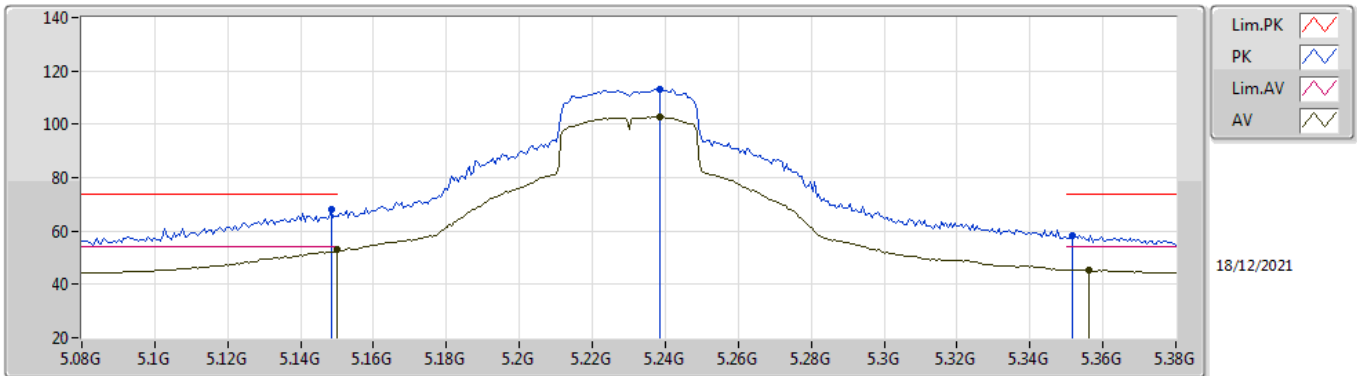

EUT_Z_2TX
Setting 23.5
02-B-S-5-10

Type	Freq (Hz)	Level (dBuV/m)	Limit (dBuV/m)	Margin (dB)	Raw (dBuV)	Dist (m)	Condition	Azimuth (°)	Height (m)	Comment	AF (dB)	CL (dB)	PA (dB)
PK	5.1484G	68.06	74.00	-5.94	61.46	3	Vertical	278	2.87	-	33.50	5.25	32.15
AV	5.15G	52.86	54.00	-1.14	46.26	3	Vertical	278	2.87	-	33.50	5.25	32.15
PK	5.2384G	113.32	Inf	-Inf	106.57	3	Vertical	278	2.87	-	33.58	5.32	32.15
AV	5.2384G	102.94	Inf	-Inf	96.19	3	Vertical	278	2.87	-	33.58	5.32	32.15
PK	5.3518G	58.47	74.00	-15.53	51.53	3	Vertical	278	2.87	-	33.70	5.38	32.14
AV	5.356G	45.56	54.00	-8.44	38.61	3	Vertical	278	2.87	-	33.71	5.38	32.14

802.11ac VHT40_Nss1,(MCS0)_2TX

5230MHz_TnomVnom

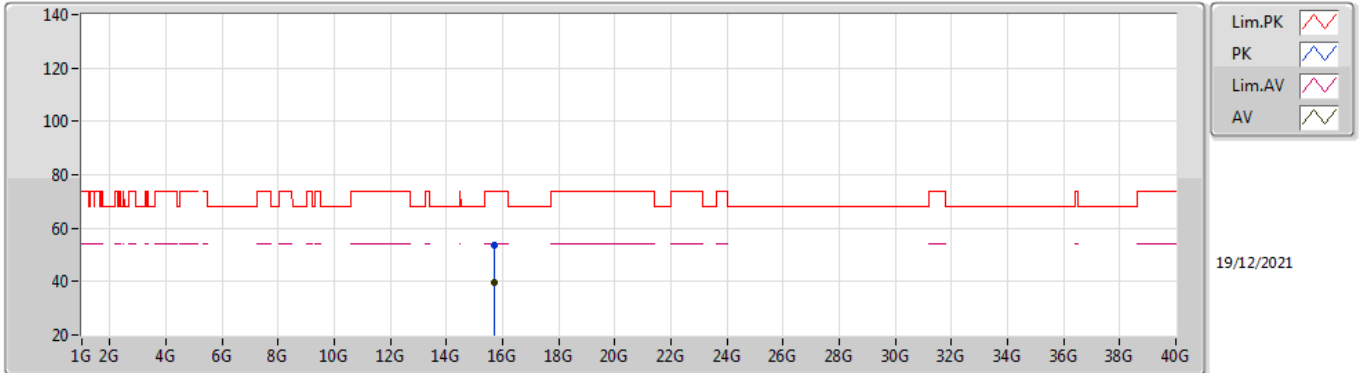

EUT_Z_2TX
Setting 23.5
02-B-S-5

Type	Freq (Hz)	Level (dBuV/m)	Limit (dBuV/m)	Margin (dB)	Raw (dBuV)	Dist (m)	Condition	Azimuth (°)	Height (m)	Comment	AF (dB)	CL (dB)	PA (dB)
PK	15.68988G	53.50	74.00	-20.50	39.59	3	Vertical	304	2.65	-	37.42	9.86	33.37
AV	15.6872G	39.51	54.00	-14.49	25.59	3	Vertical	304	2.65	-	37.43	9.86	33.37

802.11ac VHT40_Nss1,(MCS0)_2TX

5230MHz_TnomVnom

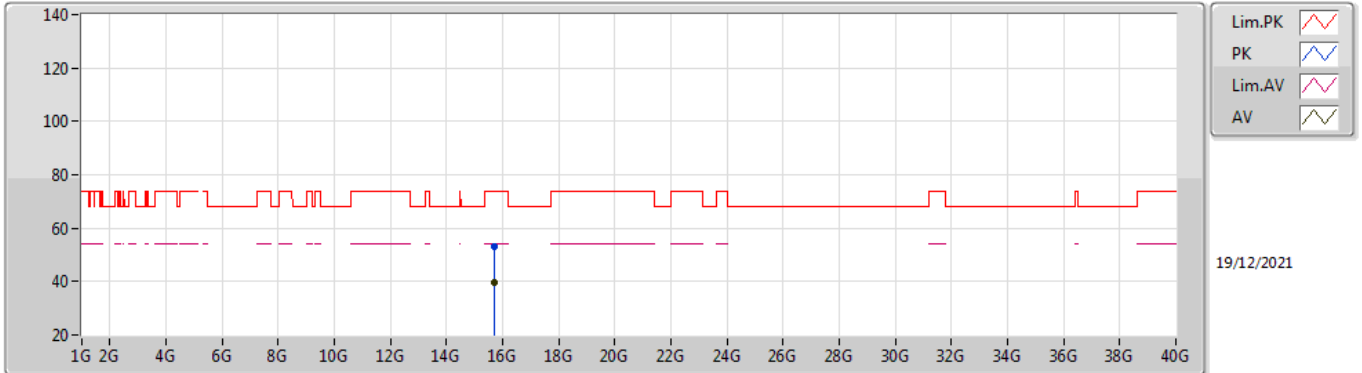

EUT_Z_2TX
Setting 23.5
02-B-S-5

Type	Freq (Hz)	Level (dBuV/m)	Limit (dBuV/m)	Margin (dB)	Raw (dBuV)	Dist (m)	Condition	Azimuth (°)	Height (m)	Comment	AF (dB)	CL (dB)	PA (dB)
PK	15.6874G	53.08	74.00	-20.92	39.16	3	Horizontal	138	1.26	-	37.43	9.86	33.37
AV	15.69186G	39.56	54.00	-14.44	25.66	3	Horizontal	138	1.26	-	37.42	9.86	33.38

802.11ac VHT40_Nss1,(MCS0)_2TX

5755MHz_TnomVnom

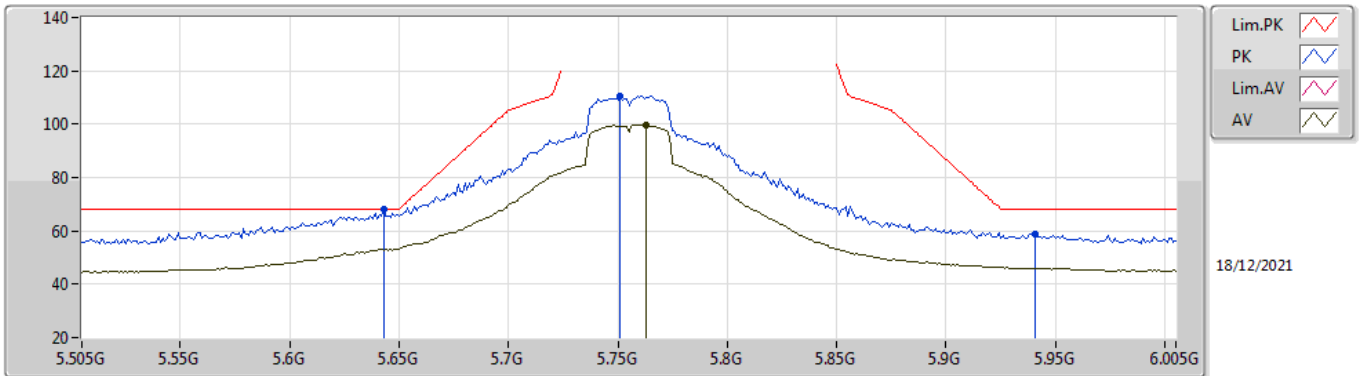

EUT_Z_2TX
Setting 24
02-B-S-5-10

Type	Freq (Hz)	Level (dBuV/m)	Limit (dBuV/m)	Margin (dB)	Raw (dBuV)	Dist (m)	Condition	Azimuth (°)	Height (m)	Comment	AF (dB)	CL (dB)	PA (dB)
PK	5.643G	67.98	68.20	-0.22	60.71	3	Vertical	224	1.82	-	33.81	5.60	32.14
PK	5.751G	110.75	Inf	-Inf	103.50	3	Vertical	224	1.82	-	33.80	5.60	32.15
AV	5.763G	99.90	Inf	-Inf	92.68	3	Vertical	224	1.82	-	33.77	5.60	32.15
PK	5.941G	58.96	68.20	-9.24	51.30	3	Vertical	224	1.82	-	34.08	5.74	32.16

802.11ac VHT40_Nss1,(MCS0)_2TX

5755MHz_TnomVnom

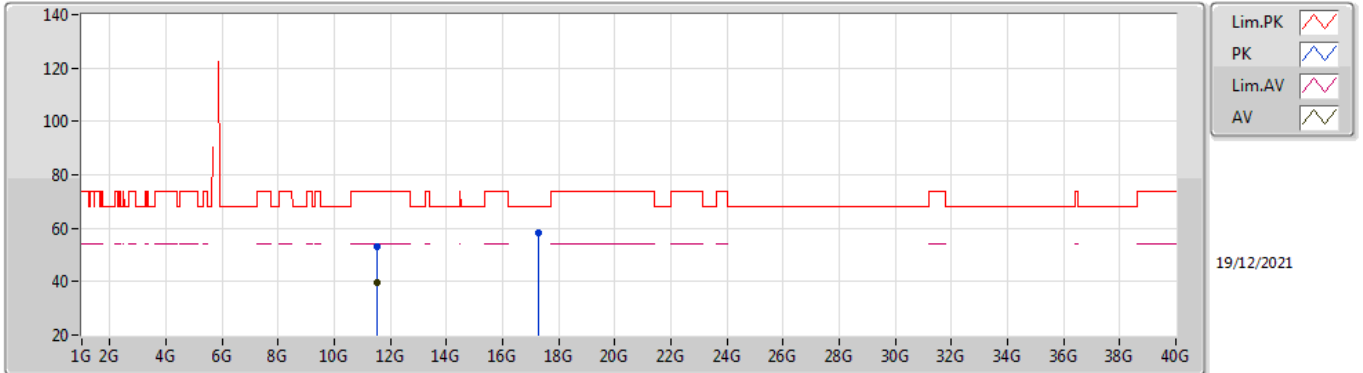

EUT_Z_2TX
Setting 24
02-B-S-5

Type	Freq (Hz)	Level (dBuV/m)	Limit (dBuV/m)	Margin (dB)	Raw (dBuV)	Dist (m)	Condition	Azimuth (°)	Height (m)	Comment	AF (dB)	CL (dB)	PA (dB)
PK	11.51186G	53.05	74.00	-20.95	39.33	3	Vertical	65	2.96	-	39.04	7.90	33.22
AV	11.51158G	39.42	54.00	-14.58	25.71	3	Vertical	65	2.96	-	39.03	7.90	33.22
PK	17.2617G	58.35	68.20	-9.85	38.77	3	Vertical	174	1.55	-	42.19	10.63	33.24

802.11ac VHT40_Nss1,(MCS0)_2TX

5755MHz_TnomVnom

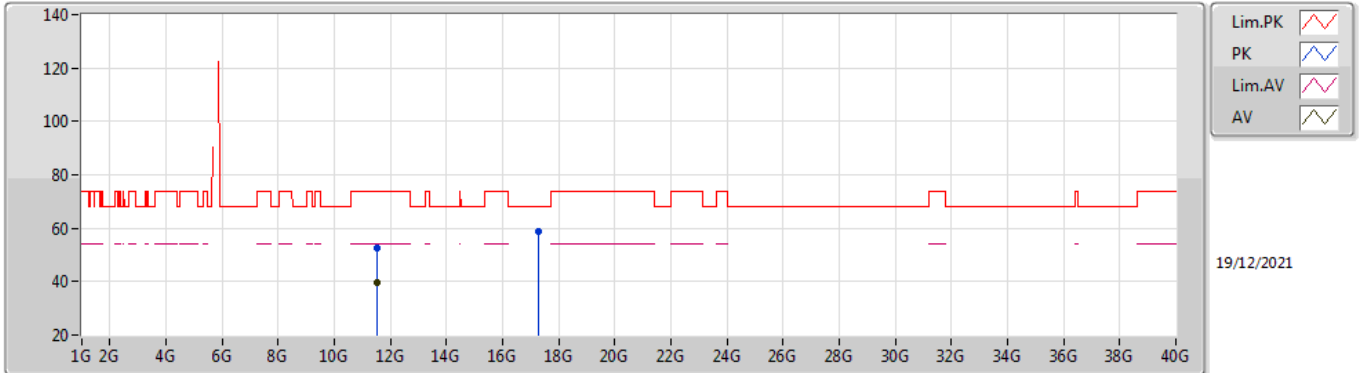

EUT_Z_2TX
Setting 24
02-B-S-5

Type	Freq (Hz)	Level (dBuV/m)	Limit (dBuV/m)	Margin (dB)	Raw (dBuV)	Dist (m)	Condition	Azimuth (°)	Height (m)	Comment	AF (dB)	CL (dB)	PA (dB)
PK	11.5126G	52.67	74.00	-21.33	38.94	3	Horizontal	90	3.00	-	39.04	7.91	33.22
AV	11.51484G	39.50	54.00	-14.50	25.77	3	Horizontal	90	3.00	-	39.04	7.91	33.22
PK	17.26546G	58.95	68.20	-9.25	39.36	3	Horizontal	130	1.30	-	42.20	10.63	33.24

802.11ac VHT40_Nss1,(MCS0)_2TX

5795MHz_TnomVnom

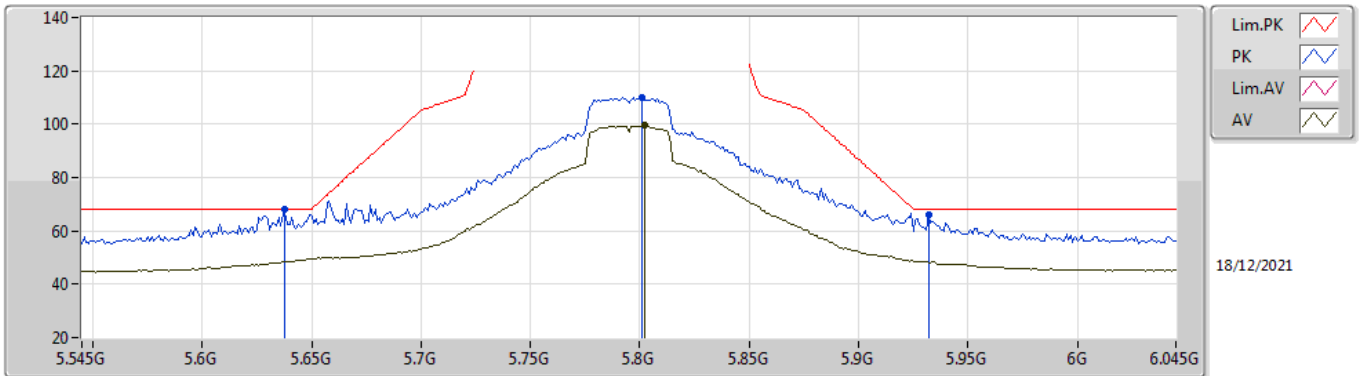

EUT_Z_2TX
Setting 25
02-B-S-5-10

Type	Freq (Hz)	Level (dBuV/m)	Limit (dBuV/m)	Margin (dB)	Raw (dBuV)	Dist (m)	Condition	Azimuth (°)	Height (m)	Comment	AF (dB)	CL (dB)	PA (dB)
PK	5.638G	67.92	68.20	-0.28	60.64	3	Vertical	281	1.80	-	33.82	5.60	32.14
PK	5.801G	110.11	Inf	-Inf	102.96	3	Vertical	281	1.80	-	33.70	5.60	32.15
AV	5.802G	99.40	Inf	-Inf	92.25	3	Vertical	281	1.80	-	33.70	5.60	32.15
PK	5.932G	66.09	68.20	-2.11	58.46	3	Vertical	281	1.80	-	34.06	5.73	32.16

802.11ac VHT40_Nss1,(MCS0)_2TX

5795MHz_TnomVnom

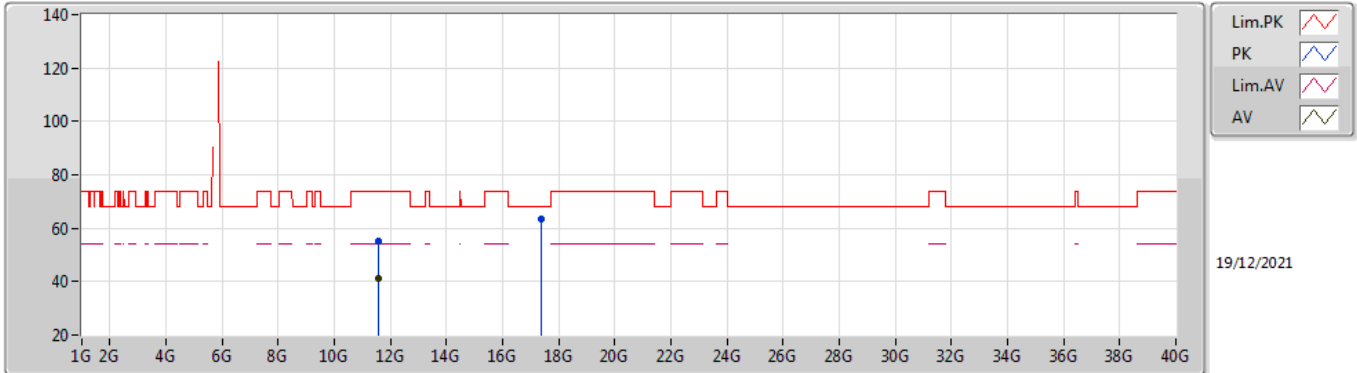

EUT_Z_2TX
Setting 25
02-B-S-5

Type	Freq (Hz)	Level (dBuV/m)	Limit (dBuV/m)	Margin (dB)	Raw (dBuV)	Dist (m)	Condition	Azimuth (°)	Height (m)	Comment	AF (dB)	CL (dB)	PA (dB)
PK	11.5948G	54.92	74.00	-19.08	40.94	3	Vertical	154	2.60	-	39.28	7.94	33.24
AV	11.58888G	41.10	54.00	-12.90	27.13	3	Vertical	154	2.60	-	39.27	7.94	33.24
PK	17.38848G	63.68	68.20	-4.52	43.08	3	Vertical	195	2.45	-	43.01	10.69	33.10

802.11ac VHT40_Nss1,(MCS0)_2TX

5795MHz_TnomVnom

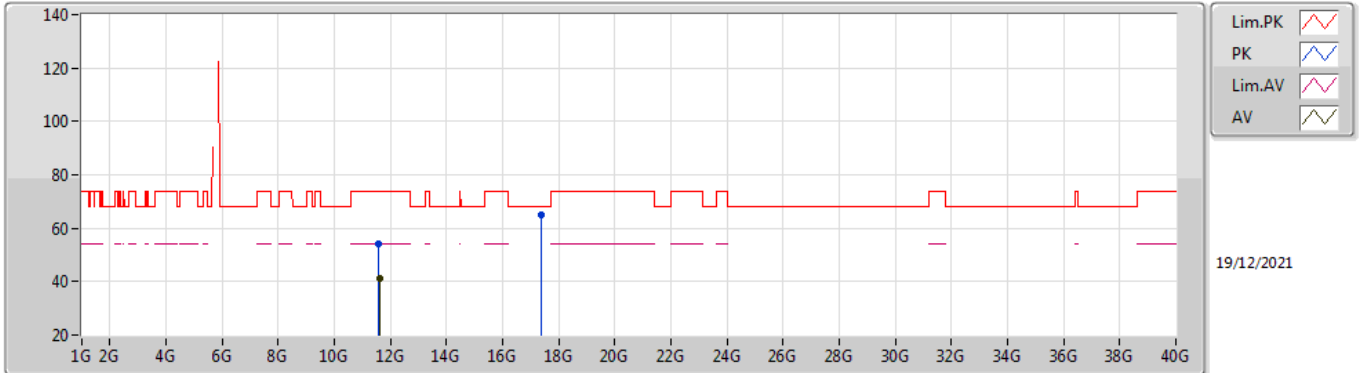

EUT_Z_2TX
Setting 25
02-B-S-5

Type	Freq (Hz)	Level (dBuV/m)	Limit (dBuV/m)	Margin (dB)	Raw (dBuV)	Dist (m)	Condition	Azimuth (°)	Height (m)	Comment	AF (dB)	CL (dB)	PA (dB)
PK	11.5982G	54.24	74.00	-19.76	40.26	3	Horizontal	177	1.69	-	39.29	7.94	33.25
AV	11.59864G	41.14	54.00	-12.86	27.15	3	Horizontal	177	1.69	-	39.30	7.94	33.25
PK	17.3914G	65.20	68.20	-3.00	44.56	3	Horizontal	34	2.02	-	43.03	10.70	33.09

802.11ac VHT80_Nss1,(MCS0)_2TX

5210MHz_TnomVnom

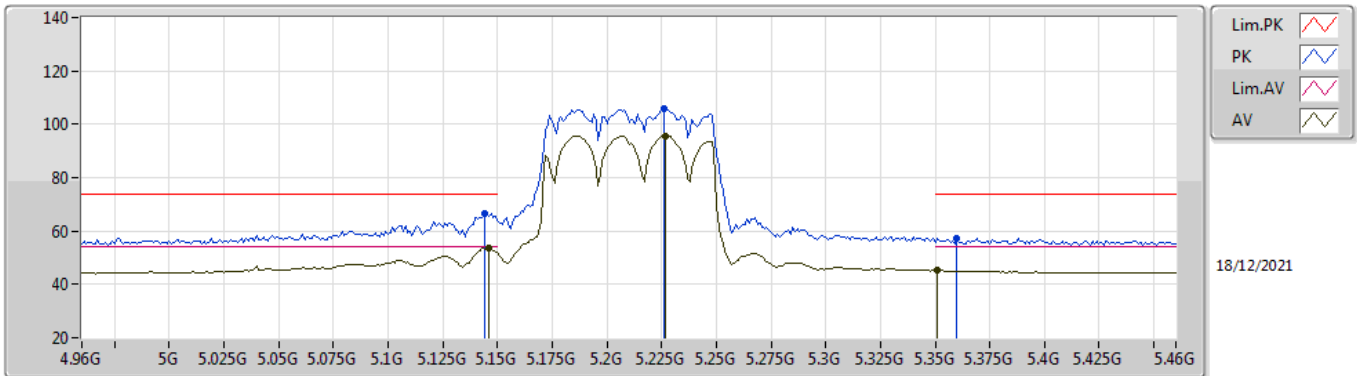

18/12/2021

EUT_Z_2TX
Setting 16.5
02-B-S-5-10

Type	Freq (Hz)	Level (dBuV/m)	Limit (dBuV/m)	Margin (dB)	Raw (dBuV)	Dist (m)	Condition	Azimuth (°)	Height (m)	Comment	AF (dB)	CL (dB)	PA (dB)
PK	5.144G	66.54	74.00	-7.46	59.95	3	Vertical	342	1.95	-	33.50	5.24	32.15
AV	5.146G	53.83	54.00	-0.17	47.23	3	Vertical	342	1.95	-	33.50	5.25	32.15
PK	5.226G	106.06	Inf	-Inf	99.35	3	Vertical	342	1.95	-	33.55	5.31	32.15
AV	5.227G	95.60	Inf	-Inf	88.89	3	Vertical	342	1.95	-	33.55	5.31	32.15
PK	5.36G	57.47	74.00	-16.53	50.51	3	Vertical	342	1.95	-	33.72	5.38	32.14
AV	5.351G	45.22	54.00	-8.78	38.28	3	Vertical	342	1.95	-	33.70	5.38	32.14

802.11ac VHT80_Nss1,(MCS0)_2TX

5210MHz_TnomVnom

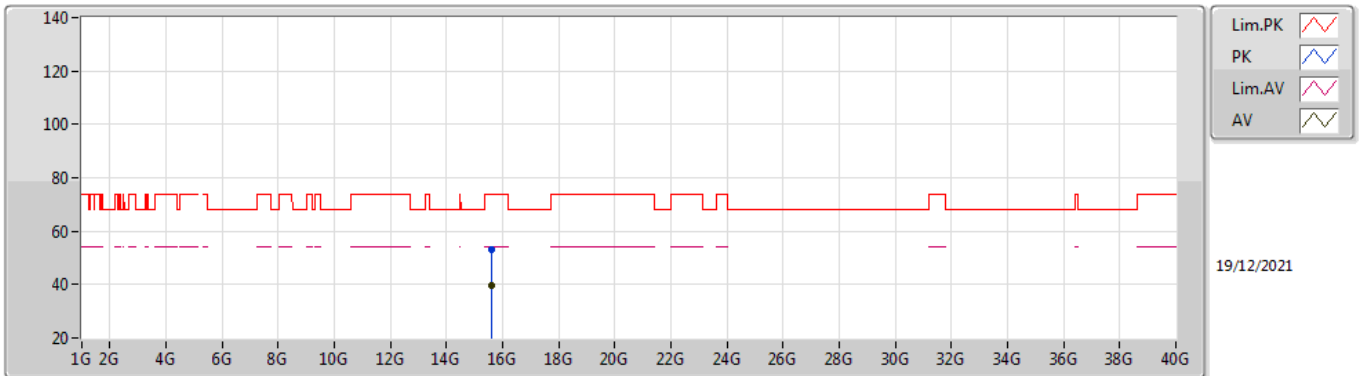

EUT_Z_2TX
Setting 16.5
02-B-S-5

Type	Freq (Hz)	Level (dBuV/m)	Limit (dBuV/m)	Margin (dB)	Raw (dBuV)	Dist (m)	Condition	Azimuth (°)	Height (m)	Comment	AF (dB)	CL (dB)	PA (dB)
PK	15.6304G	53.25	74.00	-20.75	39.18	3	Vertical	58	1.41	-	37.54	9.83	33.30
AV	15.62712G	39.71	54.00	-14.29	25.63	3	Vertical	58	1.41	-	37.55	9.83	33.30

802.11ac VHT80_Nss1,(MCS0)_2TX

5210MHz_TnomVnom

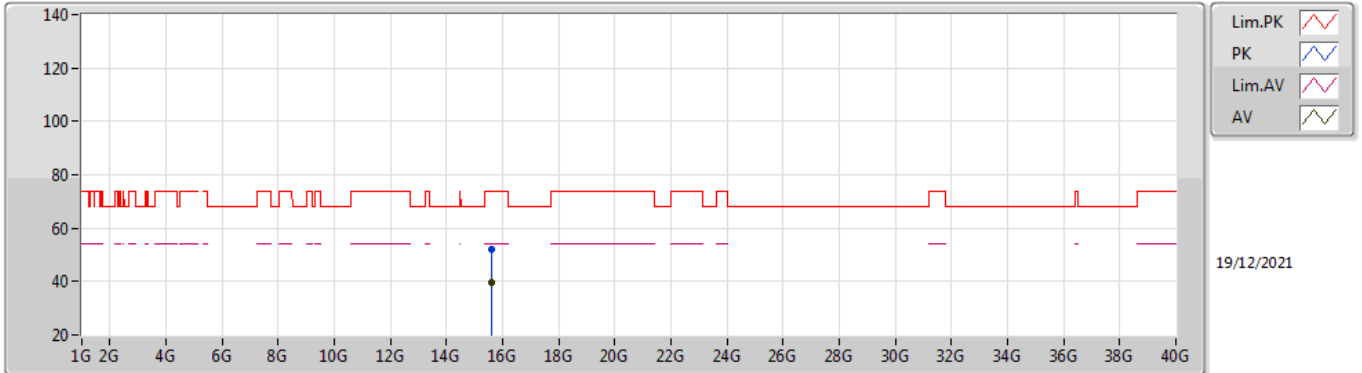

EUT_Z_2TX
Setting 16.5
02-B-S-5

Type	Freq (Hz)	Level (dBuV/m)	Limit (dBuV/m)	Margin (dB)	Raw (dBuV)	Dist (m)	Condition	Azimuth (°)	Height (m)	Comment	AF (dB)	CL (dB)	PA (dB)
PK	15.62864G	52.28	74.00	-21.72	38.21	3	Horizontal	85	1.39	-	37.54	9.83	33.30
AV	15.6295G	39.67	54.00	-14.33	25.60	3	Horizontal	85	1.39	-	37.54	9.83	33.30

802.11ac VHT80_Nss1,(MCS0)_2TX

5775MHz_TnomVnom

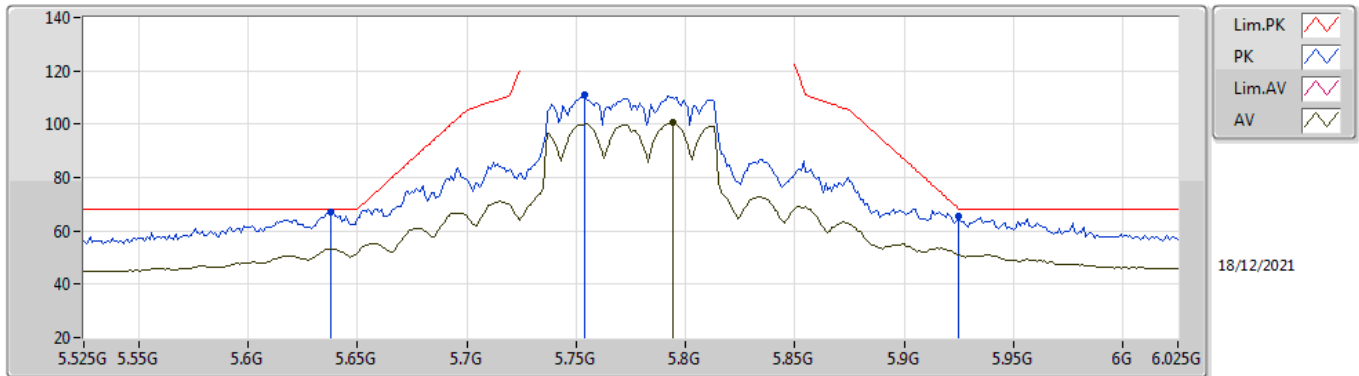

EUT_Z_2TX
Setting 21.5
02-B-S-5-10

Type	Freq (Hz)	Level (dBuV/m)	Limit (dBuV/m)	Margin (dB)	Raw (dBuV)	Dist (m)	Condition	Azimuth (°)	Height (m)	Comment	AF (dB)	CL (dB)	PA (dB)
PK	5.638G	67.01	68.20	-1.19	59.73	3	Vertical	222	1.98	-	33.82	5.60	32.14
PK	5.754G	111.13	Inf	-Inf	103.89	3	Vertical	222	1.98	-	33.79	5.60	32.15
AV	5.794G	100.46	Inf	-Inf	93.30	3	Vertical	222	1.98	-	33.71	5.60	32.15
PK	5.925G	65.32	68.20	-2.88	57.70	3	Vertical	222	1.98	-	34.05	5.73	32.16

802.11ac VHT80_Nss1,(MCS0)_2TX

5775MHz_TnomVnom

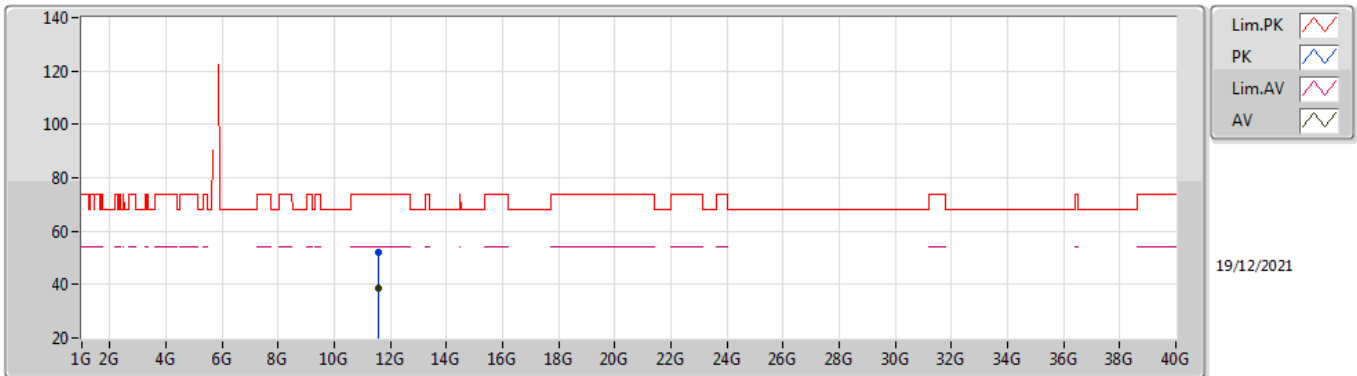

EUT_Z_2TX
Setting 21.5
02-B-S-5

Type	Freq (Hz)	Level (dBuV/m)	Limit (dBuV/m)	Margin (dB)	Raw (dBuV)	Dist (m)	Condition	Azimuth (°)	Height (m)	Comment	AF (dB)	CL (dB)	PA (dB)
PK	11.54978G	51.97	74.00	-22.03	38.13	3	Vertical	316	1.68	-	39.15	7.92	33.23
AV	11.55124G	38.69	54.00	-15.31	24.85	3	Vertical	316	1.68	-	39.15	7.92	33.23

802.11ac VHT80_Nss1,(MCS0)_2TX

5775MHz_TnomVnom

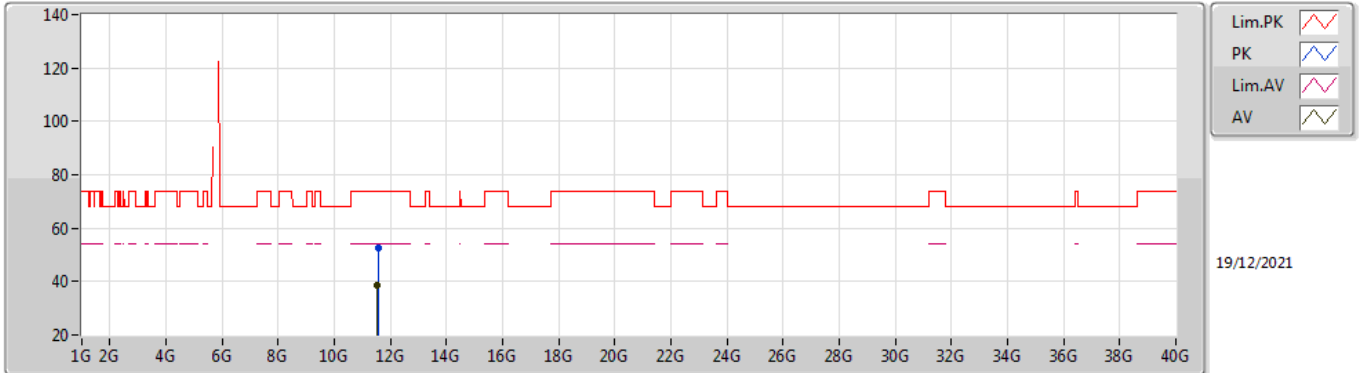

EUT_Z_2TX
Setting 21.5
02-B-S-5

Type	Freq (Hz)	Level (dBuV/m)	Limit (dBuV/m)	Margin (dB)	Raw (dBuV)	Dist (m)	Condition	Azimuth (°)	Height (m)	Comment	AF (dB)	CL (dB)	PA (dB)
PK	11.5496G	52.80	74.00	-21.20	38.96	3	Horizontal	270	2.37	-	39.15	7.92	33.23
AV	11.54842G	38.67	54.00	-15.33	24.83	3	Horizontal	270	2.37	-	39.15	7.92	33.23



Summary

Mode	Result	Type	Freq (Hz)	Level (dBuV/m)	Limit (dBuV/m)	Margin (dB)	Condition
Mode 1	Pass	AV	3.47318G	42.20	54.00	-11.80	Horizontal

Mode 1

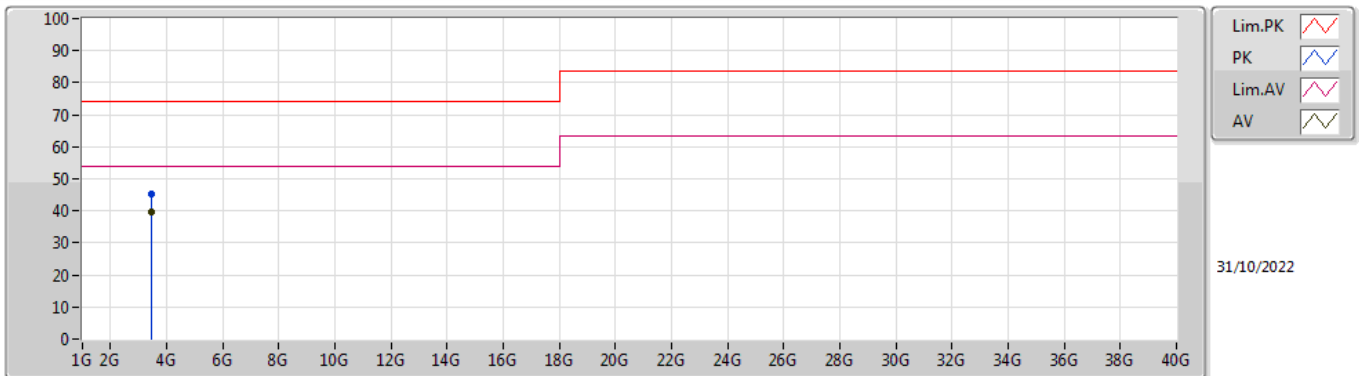

Type	Freq (Hz)	Level (dBuV/m)	Limit (dBuV/m)	Margin (dB)	Factor (dB/m)	Dist (m)	Condition	Azimuth (°)	Height (m)	Comment	Raw (dBuV/m)	AF (dB/m)	CL (dB)	PA (dB)
PK	3.47364G	45.38	74.00	-28.62	-1.07	3	Vertical	58	2.50	-	46.45	29.55	5.17	35.79
AV	3.47317G	39.56	54.00	-14.44	-1.07	3	Vertical	58	2.50	"Worst"	40.63	29.55	5.17	35.79

Mode 1

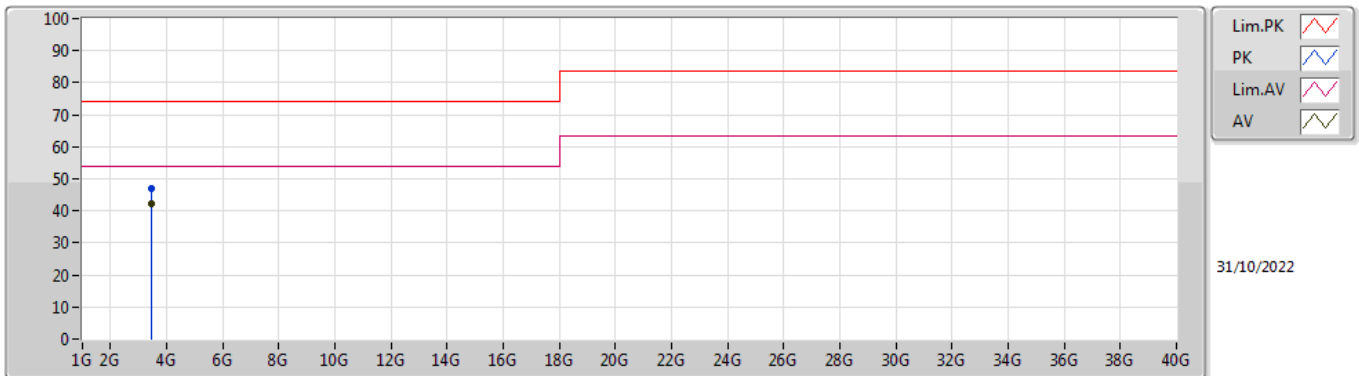

Type	Freq (Hz)	Level (dBuV/m)	Limit (dBuV/m)	Margin (dB)	Factor (dB/m)	Dist (m)	Condition	Azimuth (°)	Height (m)	Comment	Raw (dBuV/m)	AF (dB/m)	CL (dB)	PA (dB)
PK	3.47326G	46.99	74.00	-27.01	-1.07	3	Horizontal	123	1.45	-	48.06	29.55	5.17	35.79
AV	3.47318G	42.20	54.00	-11.80	-1.07	3	Horizontal	123	1.45	"Worst"	43.27	29.55	5.17	35.79