

FCC Test Report

Report No.: RFBDUJ-WTW-P22030486

FCC ID: RPV-ATW330

Test Model: ATW330-42

Series Model: ATW330-41

Received Date: 2022/3/14

Test Date: 2022/6/21 ~ 2022/8/5

Issued Date: 2022/9/28

Applicant: ATOP TECHNOLOGIES, INC.

Address: 1F, 30, R/D Rd. II, Science Park, Hsinchu, 30076, Taiwan

Issued By: Bureau Veritas Consumer Products Services (H.K.) Ltd., Taoyuan Branch
Hsin Chu Laboratory

Lab Address: E-2, No.1, Li Hsin 1st Road, Hsinchu Science Park, Hsinchu City 300,
Taiwan

Test Location: E-2, No.1, Li Hsin 1st Road, Hsinchu Science Park, Hsinchu City 300,
Taiwan

**FCC Registration /
Designation Number:** 723255 / TW2022



This report is governed by, and incorporates by reference, the Conditions of Testing as posted at the date of issuance of this report at <http://www.bureauveritas.com/home/about-us/our-business/cps/about-us/terms-conditions/> and is intended for your exclusive use. Any copying or replication of this report to or for any other person or entity, or use of our name or trademark, is permitted only with our prior written permission. This report sets forth our findings solely with respect to the test samples identified herein. The results set forth in this report are not indicative or representative of the quality or characteristics of the lot from which a test sample was taken or any similar or identical product unless specifically and expressly noted. Our report includes all of the tests requested by you and the results thereof based upon the information that you provided to us. Measurement uncertainty is only provided upon request for accredited tests. Statements of conformity are based on simple acceptance criteria without taking measurement uncertainty into account, unless otherwise requested in writing. You have 60 days from date of issuance of this report to notify us of any material error or omission caused by our negligence or if you require measurement uncertainty; provided, however, that such notice shall be in writing and shall specifically address the issue you wish to raise. A failure to raise such issue within the prescribed time shall constitute your unqualified acceptance of the completeness of this report, the tests conducted and the correctness of the report contents.

Table of Contents

Release Control Record	4
1 Certificate of Conformity	5
2 Summary of Test Results	6
2.1 Measurement Uncertainty	6
2.2 Modification Record	6
3 General Information	7
3.1 General Description of EUT	7
3.2 Description of Test Modes	9
3.2.1 Test Mode Applicability and Tested Channel Detail	10
3.3 Duty Cycle of Test Signal	12
3.4 Description of Support Units	13
3.4.1 Configuration of System under Test	14
3.5 General Description of Applied Standards and References	15
4 Test Types and Results	16
4.1 Radiated Emission and Bandedge Measurement	16
4.1.1 Limits of Radiated Emission and Bandedge Measurement	16
4.1.2 Test Instruments	17
4.1.3 Test Procedures	19
4.1.4 Deviation from Test Standard	19
4.1.5 Test Setup	20
4.1.6 EUT Operating Conditions	21
4.1.7 Test Results	22
4.2 Conducted Emission Measurement	27
4.2.1 Limits of Conducted Emission Measurement	27
4.2.2 Test Instruments	27
4.2.3 Test Procedures	28
4.2.4 Deviation from Test Standard	28
4.2.5 Test Setup	28
4.2.6 EUT Operating Conditions	28
4.2.7 Test Results	29
4.3 6dB Bandwidth Measurement	31
4.3.1 Limits of 6dB Bandwidth Measurement	31
4.3.2 Test Setup	31
4.3.3 Test Instruments	31
4.3.4 Test Procedure	31
4.3.5 Deviation from Test Standard	31
4.3.6 EUT Operating Conditions	31
4.3.7 Test Results	32
4.4 Conducted Output Power Measurement	33
4.4.1 Limits of Conducted Output Power Measurement	33
4.4.2 Test Setup	33
4.4.3 Test Instruments	33
4.4.4 Test Procedures	33
4.4.5 Deviation from Test Standard	33
4.4.6 EUT Operating Conditions	33
4.4.7 Test Results	34
4.5 Power Spectral Density Measurement	35
4.5.1 Limits of Power Spectral Density Measurement	35
4.5.2 Test Setup	35
4.5.3 Test Instruments	35
4.5.4 Test Procedure	35
4.5.5 Deviation from Test Standard	35
4.5.6 EUT Operating Condition	35

4.5.7 Test Results	36
4.6 Conducted Out of Band Emission Measurement	37
4.6.1 Limits of Conducted Out of Band Emission Measurement.....	37
4.6.2 Test Setup.....	37
4.6.3 Test Instruments	37
4.6.4 Test Procedure	37
4.6.5 Deviation from Test Standard	37
4.6.6 EUT Operating Condition	37
4.6.7 Test Results	38
5 Pictures of Test Arrangements.....	39
Annex A - Band-Edge Measurement.....	40
Appendix – Information of the Testing Laboratories	41



Release Control Record

Issue No.	Description	Date Issued
RFBDUJ-WTW-P22030486	Original release.	2022/9/28

1 Certificate of Conformity

Product: TCP/IP Wireless Pick to Light Controller

Brand: atop

Test Model: ATW330-42

Series Model: ATW330-41

Sample Status: Engineering sample

Applicant: ATOP TECHNOLOGIES, INC.

Test Date: 2022/6/21 ~ 2022/8/5

Standards: 47 CFR FCC Part 15, Subpart C (Section 15.247)
ANSI C63.10: 2013

The above equipment has been tested by **Bureau Veritas Consumer Products Services (H.K.) Ltd., Taoyuan Branch**, and found compliance with the requirement of the above standards. The test record, data evaluation & Equipment Under Test (EUT) configurations represented herein are true and accurate accounts of the measurements of the sample's EMC characteristics under the conditions specified in this report.

Prepared by : Cherry Chuo , **Date:** 2022/9/28
Cherry Chuo / Specialist

Approved by : May Chen , **Date:** 2022/9/28
May Chen / Manager

2 Summary of Test Results

47 CFR FCC Part 15, Subpart C (Section 15.247)			
FCC Clause	Test Item	Result	Remarks
15.207	AC Power Conducted Emission	Pass	Meet the requirement of limit. Minimum passing margin is -7.65 dB at 5.99609 MHz.
15.205 / 15.209 / 15.247(d)	Radiated Emissions and Band Edge Measurement	Pass	Meet the requirement of limit. Minimum passing margin is -2.0 dB at 250.02 MHz.
15.247(d)	Antenna Port Emission	Pass	Meet the requirement of limit.
15.247(a)(2)	6dB bandwidth	Pass	Meet the requirement of limit.
15.247(b)	Conducted power	Pass	Meet the requirement of limit.
15.247(e)	Power Spectral Density	Pass	Meet the requirement of limit.
15.203	Antenna Requirement	Pass	Antenna connector is R-SMA not a standard connector.

Note:

- For 2.4 GHz band compliance with rule 15.247(d) of the band-edge items, the test plots were recorded in Annex A.
- Determining compliance based on the results of the compliance measurement, not taking into account measurement instrumentation uncertainty.

2.1 Measurement Uncertainty

Where relevant, the following measurement uncertainty levels have been estimated for tests performed on the EUT as specified in CISPR 16-4-2:

Measurement	Frequency	Expanded Uncertainty (k=2) (\pm)
Conducted Emissions at mains ports	150kHz ~ 30MHz	1.9 dB
Conducted emissions	-	2.5 dB
Radiated Emissions up to 1 GHz	9kHz ~ 30MHz	3.1 dB
	30MHz ~ 1GHz	5.4 dB
Radiated Emissions above 1 GHz	1GHz ~ 18GHz	5.0 dB
	18GHz ~ 40GHz	5.3 dB

2.2 Modification Record

There were no modifications required for compliance.

3 General Information

3.1 General Description of EUT

Product	TCP/IP Wireless Pick to Light Controller
Brand	atop
Test Model	ATW330-42
Series Model	ATW330-41
Status of EUT	Engineering sample
Power Supply Rating	48 Vdc from PoE 12 Vdc form AC Adapter
Modulation Type	GFSK
Modulation Technology	DTS
Transfer Rate	Up to 2 Mbps
Operating Frequency	2402 ~ 2480 MHz
Number of Channel	79
Output Power	3.945 mW
Antenna Type	Refer to Note
Antenna Connector	Refer to Note
Cable Supplied	NA

Note:

1. All models are listed as below.

Brand	Model	Difference
atop	ATW330-41	Standard
	ATW330-42	Standard+PoE PD

Since the ATW330-41 and ATW330-42 are the same EUT, differing only in power supply, and cannot be powered up at the same time, the pre worst out result is the worst POE mode of ATW330-42, so the POE model of ATW330-42 will be tested as the representative model of the above model, and its data will be recorded in this report.

2. The EUT uses following accessories.

AC Adapter 1 (DC Jack)

Brand	Model	Part Number	Specification
UNIFIVE	SV324	SV324-1215 US	AC Input : 100-240Vac ; 50/60 Hz ; 0.6 A DC Output : 12Vdc ; 1.5A DC Output Cable : 1.8m

AC Adapter 2 (Terminal)

Brand	Model	Part Number	Specification
UNIFIVE	SV324	SV324-1215 US	AC Input : 100-240Vac ; 50/60 Hz ; 0.6 A DC Output : 12Vdc ; 1.5A DC Output Cable : 1.8m

3. The EUT was pre-tested under the following modes:

For Radiated Emission test

Test Mode	Item	Description
Mode A	Above 1GHz	PoE mode + Antenna 1
Mode B	Above 1GHz	PoE mode + Antenna 1 with Antenna base
Mode C	Below 1GHz	PoE mode + Antenna 1
Mode D	Below 1GHz	PoE mode + Antenna 1 with Antenna base
Mode E	Below 1GHz	Adapter mode, model: SV324 (DC Jack) + Antenna 1 with Antenna base
Mode F	Below 1GHz	Adapter mode, model: SV324 (Terminal) + Antenna 1 with Antenna base

Note: From the above modes, the worst case were found in **Mode A & C**. Therefore only the test data of the mode was recorded in this report.

AC Power Conducted Emission test

Test Mode	Description
Mode G	Adapter mode, model: SV324 (DC Jack) + Antenna 1
Mode H	Adapter mode, model: SV324 (Terminal) + Antenna 1
Mode I	PoE mode + Antenna 1

Note: From the above modes, the worst case was found in **Mode I**. Therefore only the test data of the mode was recorded in this report.

4. The antenna provided to the EUT, please refer to the following table:

Antenna No.	Antenna Gain (dBi)	Frequency range(GHz)	Antenna Type	Connector Type	Cable Length	Cable Loss(dB)
1	4.6	2.4~2.4835	Dipole	R-SMA	-	-
1 with Antenna base (option)	2	2.4~2.4835	Dipole	R-SMA	182 cm	2.6

Note: Max. gain was selected for the final test.

- Detail antenna specification please refer to antenna datasheet and/or antenna measurement report.
- The above EUT information is declared by manufacturer and for more detailed features description, please refers to the manufacturer's specifications or user's manual.

3.2 Description of Test Modes

79 channels are provided to this EUT:

Channel	Freq. (MHz)	Channel	Freq. (MHz)	Channel	Freq. (MHz)	Channel	Freq. (MHz)
0	2402	20	2422	40	2442	60	2462
1	2403	21	2423	41	2443	61	2463
2	2404	22	2424	42	2444	62	2464
3	2405	23	2425	43	2445	63	2465
4	2406	24	2426	44	2446	64	2466
5	2407	25	2427	45	2447	65	2467
6	2408	26	2428	46	2448	66	2468
7	2409	27	2429	47	2449	67	2469
8	2410	28	2430	48	2450	68	2470
9	2411	29	2431	49	2451	69	2471
10	2412	30	2432	50	2452	70	2472
11	2413	31	2433	51	2453	71	2473
12	2414	32	2434	52	2454	72	2474
13	2415	33	2435	53	2455	73	2475
14	2416	34	2436	54	2456	74	2476
15	2417	35	2437	55	2457	75	2477
16	2418	36	2438	56	2458	76	2478
17	2419	37	2439	57	2459	77	2479
18	2420	38	2440	58	2460	78	2480
19	2421	39	2441	59	2461		

3.2.1 Test Mode Applicability and Tested Channel Detail

EUT CONFIGURE MODE	APPLICABLE TO				DESCRIPTION
	RE \geq 1G	RE $<$ 1G	PLC	APCM	
-	√	√	√	√	-

Where **RE \geq 1G**: Radiated Emission above 1GHz & Bandedge Measurement
RE $<$ 1G: Radiated Emission below 1GHz
PLC: Power Line Conducted Emission
APCM: Antenna Port Conducted Measurement

NOTE:

1. The EUT had been pre-tested on the positioned of each 3 axis. The worst case was found when positioned on **X-plane**.

Radiated Emission Test (Above 1GHz):

- Pre-Scan has been conducted to determine the worst-case mode from all possible combinations between available modulations, data rates and antenna ports (if EUT with antenna diversity architecture).
- Following channel(s) was (were) selected for the final test as listed below.

AVAILABLE CHANNEL	TESTED CHANNEL	MODULATION TYPE	DATA RATE (Mbps)
0 to 78	0, 40, 78	GFSK	2

Radiated Emission Test (Below 1GHz):

- Pre-Scan has been conducted to determine the worst-case mode from all possible combinations between available modulations, data rates and antenna ports (if EUT with antenna diversity architecture).
- Following channel(s) was (were) selected for the final test as listed below.

AVAILABLE CHANNEL	TESTED CHANNEL	MODULATION TYPE	DATA RATE (Mbps)
0 to 78	78	GFSK	2

Power Line Conducted Emission Test:

- Pre-Scan has been conducted to determine the worst-case mode from all possible combinations between available modulations, data rates and antenna ports (if EUT with antenna diversity architecture).
- Following channel(s) was (were) selected for the final test as listed below.

AVAILABLE CHANNEL	TESTED CHANNEL	MODULATION TYPE	DATA RATE (Mbps)
0 to 78	78	GFSK	2

Antenna Port Conducted Measurement:

- This item includes all test value of each mode, but only includes spectrum plot of worst value of each mode.
- Pre-Scan has been conducted to determine the worst-case mode from all possible combinations between available modulations, data rates and antenna ports (if EUT with antenna diversity architecture).
- Following channel(s) was (were) selected for the final test as listed below.

AVAILABLE CHANNEL	TESTED CHANNEL	MODULATION TYPE	DATA RATE (Mbps)
0 to 78	0, 40, 78	GFSK	2

Test Condition:

APPLICABLE TO	ENVIRONMENTAL CONDITIONS	INPUT POWER (SYSTEM)	TESTED BY
RE \geq 1G	20deg. C, 70%RH	120Vac, 60Hz	Nelson Teng
RE $<$ 1G	20deg. C, 70%RH	120Vac, 60Hz	Ryan Du
PLC	25deg. C, 75%RH	120Vac, 60Hz	Ryan Du
APCM	25deg. C, 60%RH	120Vac, 60Hz	Eric Peng

3.3 Duty Cycle of Test Signal

Duty cycle of test signal is 100 %, duty factor is not required.

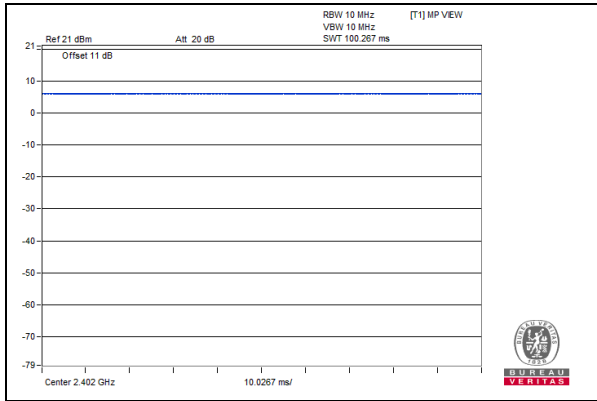

3.4 Description of Support Units

The EUT has been tested as an independent unit together with other necessary accessories or support units. The following support units or accessories were used to form a representative test configuration during the tests.

ID	Product	Brand	Model No.	Serial No.	FCC ID	Remarks
A.	Laptop	Lenovo	20U5S01X00 L14	PF-28LKK7	NA	Provided by Lab
B.	iPod	Apple	MD778TA/A	CC4JL03FF4T1	NA	Provided by Lab
C.	POE	atop	EHG7508-8PoE	NA	NA	Supplied by applicant
D.	DC Power Supply	GWINSTEK	GPD-3303S	NA	NA	Supplied by applicant

ID	Descriptions	Qty.	Length (m)	Shielding (Yes/No)	Cores (Qty.)	Remarks
1.	RJ45 Cable	1	10	No	0	Provided by Lab
2.	RJ45 Cable	1	10	No	0	Provided by Lab
3.	USB Cable	1	0.1	No	0	Provided by Lab
4.	GND Cable	1	3	No	0	Provided by Lab
5.	RS485	1	2.7	No	0	Supplied by applicant
6.	AC Power Cable	1	2.2	No	0	Supplied by applicant
7.	RJ45 Cable	1	3	No	0	Provided by Lab
8.	RJ45 Cable	1	3	No	0	Provided by Lab

3.4.1 Configuration of System under Test

For AC Power Conducted Emission test

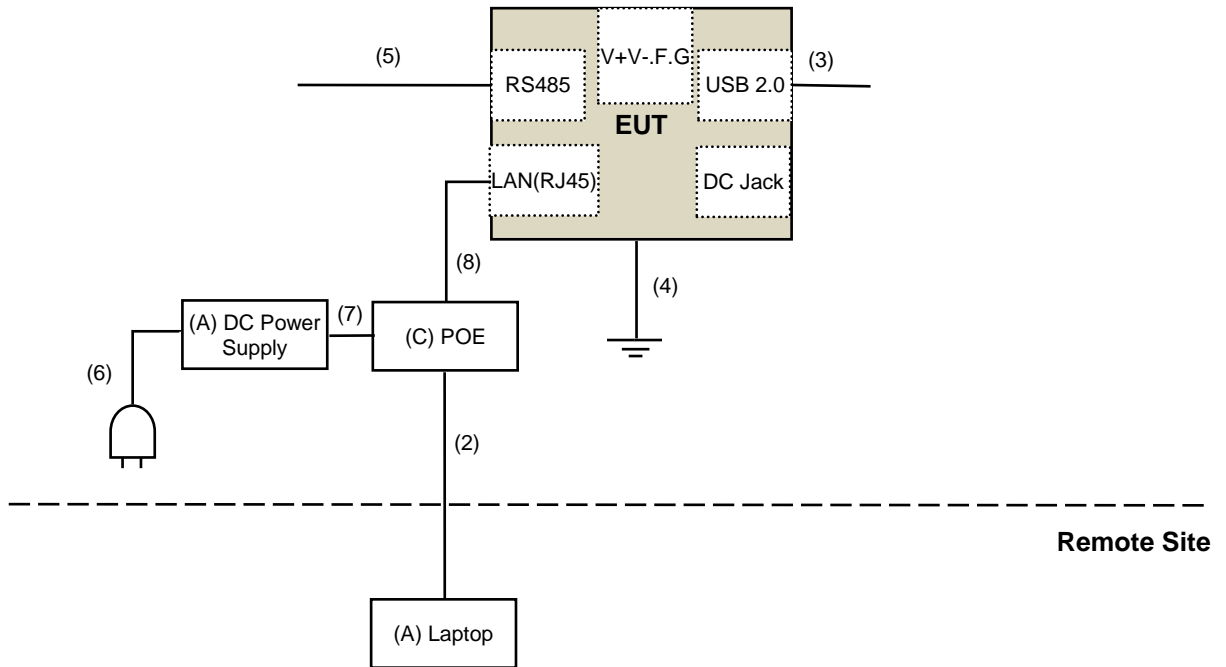

For Unwanted Emission test

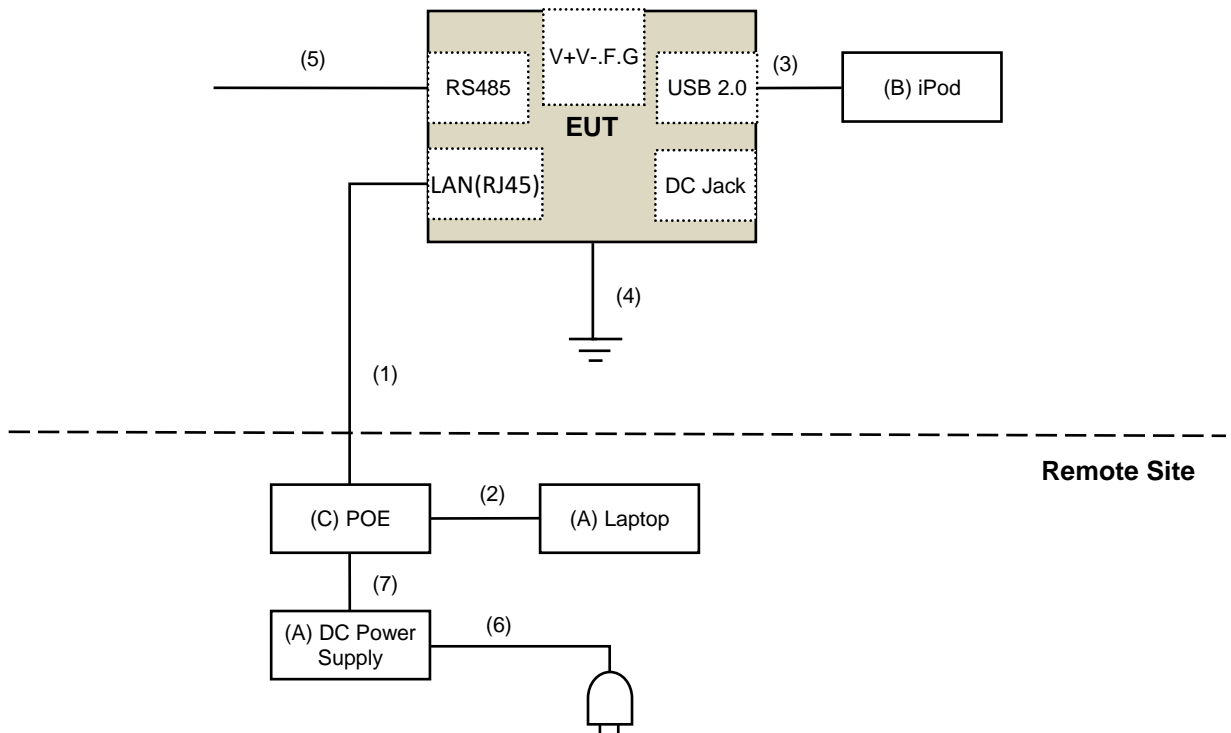

3.5 General Description of Applied Standards and References

The EUT is a RF Product. According to the specifications of the manufacturer, it must comply with the requirements of the following standards and references:

Test Standard:

FCC Part 15, Subpart C (15.247)

ANSI C63.10-2013

All test items have been performed and recorded as per the above standards.

References Test Guidance:

KDB 558074 D01 15.247 Meas Guidance v05r02

All test items have been performed as a reference to the above KDB test guidance.

4 Test Types and Results

4.1 Radiated Emission and Bandedge Measurement

4.1.1 Limits of Radiated Emission and Bandedge Measurement

Radiated emissions which fall in the restricted bands must comply with the radiated emission limits specified as below table. Other emissions shall be at least 20dB below the highest level of the desired power:

Frequencies (MHz)	Field Strength (microvolts/meter)	Measurement Distance (meters)
0.009 ~ 0.490	2400/F(kHz)	300
0.490 ~ 1.705	24000/F(kHz)	30
1.705 ~ 30.0	30	30
30 ~ 88	100	3
88 ~ 216	150	3
216 ~ 960	200	3
Above 960	500	3

Note:

1. The lower limit shall apply at the transition frequencies.
2. Emission level (dBuV/m) = 20 log Emission level (uV/m).
3. For frequencies above 1000MHz, the field strength limits are based on average detector, however, the peak field strength of any emission shall not exceed the maximum permitted average limits, specified above by more than 20dB under any condition of modulation.

4.1.2 Test Instruments

Description & Manufacturer	Model No.	Serial No.	Calibrated Date	Calibrated Until
Spectrum Analyzer KEYSIGHT	N9030B	MY57142938	2022/4/26	2023/4/25
Test Receiver KEYSIGHT	N9038A	MY59050100	2022/6/20	2023/6/19
Software	ADT_Radiated_V8.7.08	NA	NA	NA
Antenna Tower & Turn Table Max-Full	MF-7802	MF780208406	NA	NA
Fix tool for Boresight antenna tower BV	FBA-01	FBA_SIP01	NA	NA
Pre_Amplifier Agilent	8447D	2944A10636	2022/3/19	2023/3/18
LOOP ANTENNA Electro-Metrics	EM-6879	264	2022/3/18	2023/3/17
RF Coaxial Cable JYEBO	5D-FB	LOOPCAB-001	2022/1/6	2023/1/5
RF Coaxial Cable JYEBO	5D-FB	LOOPCAB-002	2022/1/6	2023/1/5
Pre_Amplifier Mini-Circuits	ZFL-1000VH2	QA0838008	2021/10/19	2022/10/18
Trilog Broadband Antenna Schwarzbeck	VULB 9168	9168-361	2021/10/26	2022/10/25
RF Coaxial Cable COMMATE/PEWC	8D	966-4-1	2022/3/8	2023/3/7
RF Coaxial Cable COMMATE/PEWC	8D	966-3-2	2022/2/26	2023/2/25
RF Coaxial Cable COMMATE/PEWC	8D	966-3-3	2022/2/26	2023/2/25
Fixed attenuator Mini-Circuits	UNAT-5+	PAD-3m-3-01	2021/9/23	2022/9/22
Horn Antenna Schwarzbeck	BBHA9120-D	9120D-406	2021/11/14	2022/11/13
Pre_Amplifier EMCI	EMC12630SE	980384	2022/1/10	2023/1/9
RF Coaxial Cable EMCI	EMC104-SM-SM-1500	180504	2022/4/25	2023/4/24
RF Coaxial Cable EMCI	EMC104-SM-SM-2000	180601	2022/6/6	2023/6/5
RF Cable EMCI	EMC104-SM-SM-6000	210201	2022/5/10	2023/5/9
Spectrum Analyzer KEYSIGHT	N9030B	MY57142938	2022/4/26	2023/4/25
Pre_Amplifier EMCI	EMC184045SE	980387	2022/1/10	2023/1/9
Horn Antenna Schwarzbeck	BBHA 9170	9170-739	2021/11/14	2022/11/13
RF Cable-Frequency range: 1-40GHz EMCI	EMC102-KM-KM-1200	160924	2022/1/10	2023/1/9
RF Coaxial Cable EMCI	EMC-KM-KM-4000	200214	2022/3/8	2023/3/7

Note:

1. The calibration interval of the above test instruments is 12 months and the calibrations are traceable to NML/ROC and NIST/USA.
2. The test was performed in 966 Chamber No. 3.
3. Tested Date: 2022/7/31

For other test items:

Description & Manufacturer	Model No.	Serial No.	Calibrated Date	Calibrated Until
Spectrum Analyzer R&S	FSV40	101516	2022/3/7	2023/3/6
Power Meter Anritsu	ML2495A	1529002	2022/6/22	2023/6/21
Pulse Power Sensor Anritsu	MA2411B	1726434	2022/6/22	2023/6/21
Attenuator WOKEN	MDCS18N-10	MDCS18N-10-01	2022/4/5	2023/4/4
Software	ADT_RF Test Software V6.6.5.4	NA	NA	NA

NOTE:

1. The test was performed in Oven room 2.
2. The calibration interval of the above test instruments is 12 months and the calibrations are traceable to NML/ROC and NIST/USA.
3. Tested Date: 2022/7/7

4.1.3 Test Procedures

For Radiated emission below 30MHz

- a. The EUT was placed on the top of a rotating table 0.8 meters above the ground at a 3 meter chamber room. The table was rotated 360 degrees to determine the position of the highest radiation.
- b. The EUT was set 3 meters away from the interference-receiving antenna, which was mounted on the top of a variable-height antenna tower.
- c. Parallel, perpendicular, and ground-parallel orientations of the antenna are set to make the measurement.
- d. For each suspected emission, the EUT was arranged to its worst case and the rotatable table was turned from 0 degrees to 360 degrees to find the maximum reading.
- e. The test-receiver system was set to Quasi-Peak Detect Function and Specified Bandwidth with Maximum Hold Mode.

Note:

1. The resolution bandwidth and video bandwidth of test receiver/spectrum analyzer is 9kHz at frequency below 30MHz.

For Radiated emission above 30MHz

- a. The EUT was placed on the top of a rotating table 0.8 meters (for 30MHz ~ 1GHz) / 1.5 meters (for above 1GHz) above the ground at 3 meter chamber room for test. The table was rotated 360 degrees to determine the position of the highest radiation.
- b. The EUT was set 3 meters away from the interference-receiving antenna, which was mounted on the top of a variable-height antenna tower.
- c. The height of antenna is varied from one meter to four meters above the ground to determine the maximum value of the field strength. Both horizontal and vertical polarizations of the antenna are set to make the measurement.
- d. For each suspected emission, the EUT was arranged to its worst case and then the antenna was tuned to heights from 1 meter to 4 meters and the rotatable table was turned from 0 degrees to 360 degrees to find the maximum reading.
- e. The test-receiver system was set to quasi-peak detect function and specified bandwidth with maximum hold mode when the test frequency is below 1 GHz.
- f. The test-receiver system was set to peak and average detects function and specified bandwidth with maximum hold mode when the test frequency is above 1 GHz. If the peak reading value also meets average limit, measurement with the average detector is unnecessary.

Note:

1. The resolution bandwidth and video bandwidth of test receiver/spectrum analyzer is 120kHz for Quasi-peak detection (QP) at frequency below 1GHz.
2. The resolution bandwidth of test receiver/spectrum analyzer is 1 MHz and the video bandwidth is 3 MHz for Peak detection (PK) at frequency above 1GHz.
3. The resolution bandwidth of test receiver/spectrum analyzer is 1MHz and the video bandwidth is $\geq 1/T$ (Duty cycle < 98%) or 10Hz (Duty cycle $\geq 98\%$) for Average detection (AV) at frequency above 1GHz.
4. All modes of operation were investigated and the worst-case emissions are reported.

4.1.4 Deviation from Test Standard

No deviation.

4.1.5 Test Setup

For Radiated emission below 30MHz

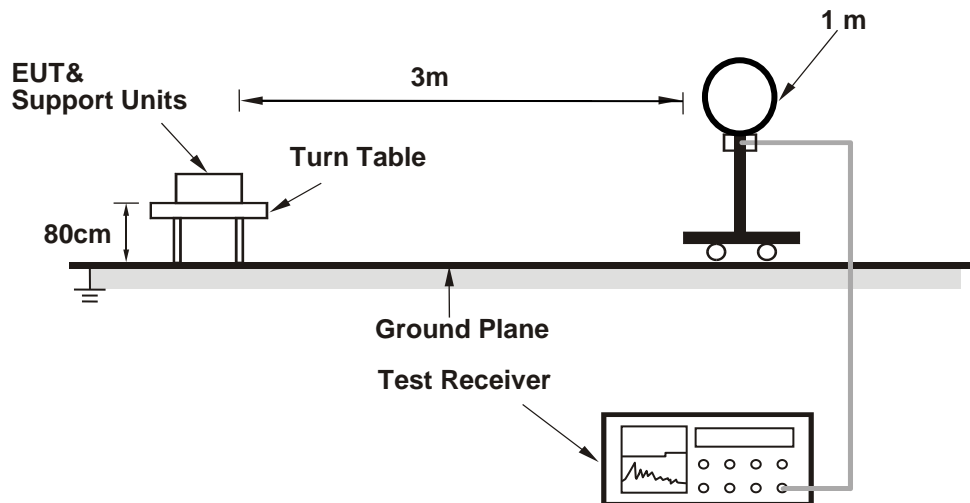

For Radiated emission 30MHz to 1GHz

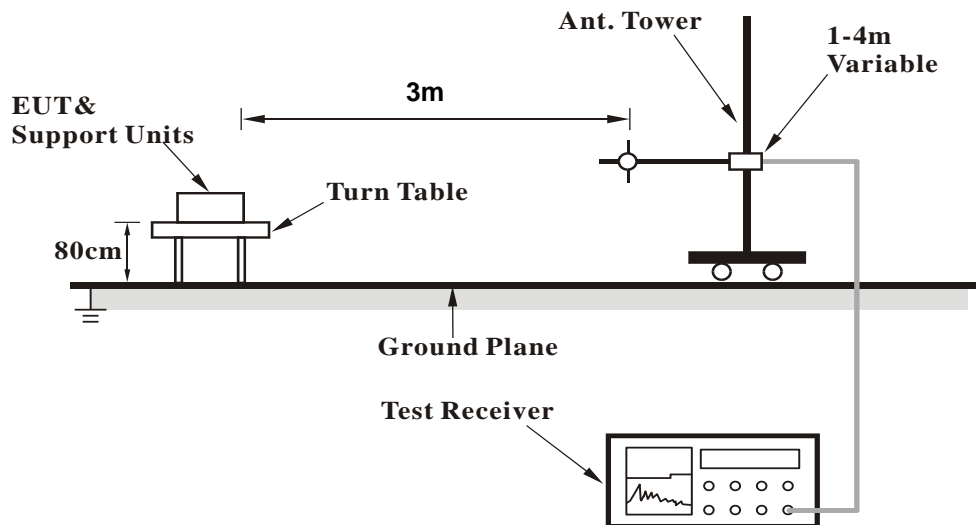

For Radiated emission above 1GHz

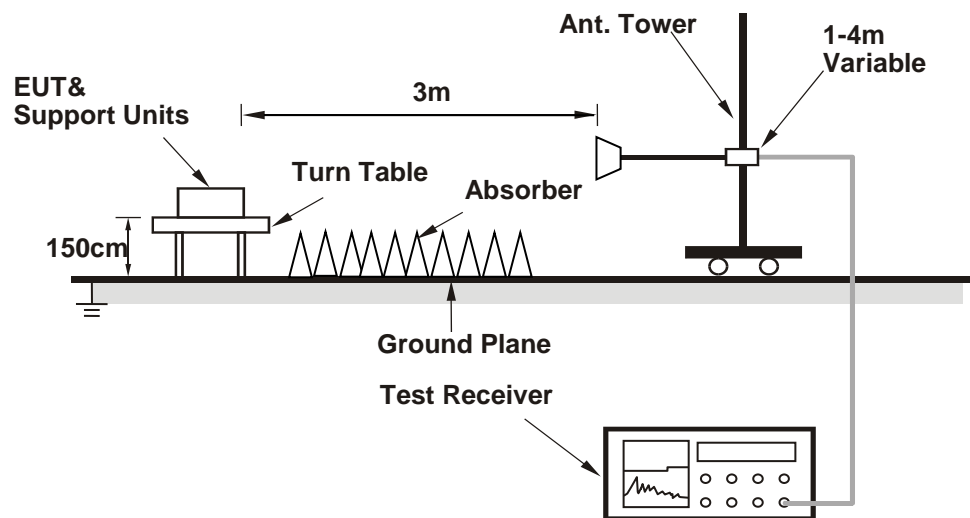

For the actual test configuration, please refer to the attached file (Test Setup Photo).

4.1.6 EUT Operating Conditions

- Placed the EUT on the testing table.
- Controlling software (tcptest_v125) has been activated to set the EUT under transmission condition continuously at specific channel frequency.

4.1.7 Test Results

Above 1GHz Data:

RF Mode	TX GFSK	Channel	CH 0 : 2402 MHz
Frequency Range	1 GHz ~ 25 GHz	Detector Function & Bandwidth	(PK) RB = 1 MHz, VB = 3 MHz (AV) RB = 1 MHz, VB = 10 Hz
Input Power (System)	120Vac, 60Hz	Environmental Conditions	20°C, 70% RH
Tested By	Nelson Teng		

Antenna Polarity & Test Distance : Horizontal at 3 m

No	Frequency (MHz)	Emission Level (dBuV/m)	Limit (dBuV/m)	Margin (dB)	Antenna Height (m)	Table Angle (Degree)	Raw Value (dBuV)	Correction Factor (dB/m)
1	2390.00	57.3 PK	74.0	-16.7	2.16 H	205	58.1	-0.8
2	2390.00	45.0 AV	54.0	-9.0	2.16 H	205	45.8	-0.8
3	*2402.00	96.5 PK			2.16 H	205	97.3	-0.8
4	*2402.00	94.8 AV			2.16 H	205	95.6	-0.8
5	4804.00	42.4 PK	74.0	-31.6	2.04 H	228	38.5	3.9
6	4804.00	33.4 AV	54.0	-20.6	2.04 H	228	29.5	3.9

Antenna Polarity & Test Distance : Vertical at 3 m

No	Frequency (MHz)	Emission Level (dBuV/m)	Limit (dBuV/m)	Margin (dB)	Antenna Height (m)	Table Angle (Degree)	Raw Value (dBuV)	Correction Factor (dB/m)
1	2390.00	56.6 PK	74.0	-17.4	1.64 V	29	57.4	-0.8
2	2390.00	46.7 AV	54.0	-7.3	1.64 V	29	47.5	-0.8
3	*2402.00	104.5 PK			1.64 V	29	105.3	-0.8
4	*2402.00	102.9 AV			1.64 V	29	103.7	-0.8
5	4804.00	42.5 PK	74.0	-31.5	2.02 V	109	38.6	3.9
6	4804.00	31.0 AV	54.0	-23.0	2.02 V	109	27.1	3.9

Remarks:

1. Emission Level(dBuV/m) = Raw Value(dBuV) + Correction Factor(dB/m)
2. Correction Factor(dB/m) = Antenna Factor(dB/m) + Cable Factor(dB) – Pre-Amplifier Factor(dB)
3. Margin value = Emission Level – Limit value
4. The other emission levels were very low against the limit.
5. " * ": Fundamental frequency, the limit was restricted at the RF Output Power.

RF Mode	TX GFSK	Channel	CH 40 : 2442 MHz
Frequency Range	1 GHz ~ 25 GHz	Detector Function & Bandwidth	(PK) RB = 1 MHz, VB = 3 MHz (AV) RB = 1 MHz, VB = 10 Hz
Input Power (System)	120Vac, 60Hz	Environmental Conditions	20°C, 70% RH
Tested By	Nelson Teng		

Antenna Polarity & Test Distance : Horizontal at 3 m

No	Frequency (MHz)	Emission Level (dBuV/m)	Limit (dBuV/m)	Margin (dB)	Antenna Height (m)	Table Angle (Degree)	Raw Value (dBuV)	Correction Factor (dB/m)
1	*2442.00	95.9 PK			2.23 H	320	96.8	-0.9
2	*2442.00	94.1 AV			2.23 H	320	95.0	-0.9
3	4884.00	42.9 PK	74.0	-31.1	2.05 H	232	39.0	3.9
4	4884.00	33.9 AV	54.0	-20.1	2.05 H	232	30.0	3.9
5	7326.00	56.1 PK	74.0	-17.9	1.99 H	73	46.0	10.1
6	7326.00	49.4 AV	54.0	-4.6	1.99 H	73	39.3	10.1

Antenna Polarity & Test Distance : Vertical at 3 m

No	Frequency (MHz)	Emission Level (dBuV/m)	Limit (dBuV/m)	Margin (dB)	Antenna Height (m)	Table Angle (Degree)	Raw Value (dBuV)	Correction Factor (dB/m)
1	*2442.00	105.2 PK			1.66 V	26	106.1	-0.9
2	*2442.00	103.5 AV			1.66 V	26	104.4	-0.9
3	4884.00	41.9 PK	74.0	-32.1	2.04 V	95	38.0	3.9
4	4884.00	30.7 AV	54.0	-23.3	2.04 V	95	26.8	3.9
5	7326.00	57.2 PK	74.0	-16.8	2.08 V	102	47.1	10.1
6	7326.00	50.9 AV	54.0	-3.1	2.08 V	102	40.8	10.1

Remarks:

1. Emission Level(dBuV/m) = Raw Value(dBuV) + Correction Factor(dB/m)
2. Correction Factor(dB/m) = Antenna Factor(dB/m) + Cable Factor(dB) – Pre-Amplifier Factor(dB)
3. Margin value = Emission Level – Limit value
4. The other emission levels were very low against the limit.
5. " * ": Fundamental frequency, the limit was restricted at the RF Output Power.

RF Mode	TX GFSK	Channel	CH 78 : 2480 MHz
Frequency Range	1 GHz ~ 25 GHz	Detector Function & Bandwidth	(PK) RB = 1 MHz, VB = 3 MHz (AV) RB = 1 MHz, VB = 10 Hz
Input Power (System)	120Vac, 60Hz	Environmental Conditions	20°C, 70% RH
Tested By	Nelson Teng		

Antenna Polarity & Test Distance : Horizontal at 3 m

No	Frequency (MHz)	Emission Level (dBuV/m)	Limit (dBuV/m)	Margin (dB)	Antenna Height (m)	Table Angle (Degree)	Raw Value (dBuV)	Correction Factor (dB/m)
1	*2480.00	96.2 PK			2.17 H	316	97.1	-0.9
2	*2480.00	94.4 AV			2.17 H	316	95.3	-0.9
3	2483.50	56.4 PK	74.0	-17.6	1.00 H	0	57.4	-1.0
4	2483.50	45.4 AV	54.0	-8.6	1.00 H	0	46.4	-1.0
5	4960.00	42.7 PK	74.0	-31.3	2.00 H	243	38.7	4.0
6	4960.00	33.6 AV	54.0	-20.4	2.00 H	243	29.6	4.0
7	7440.00	56.2 PK	74.0	-17.8	1.93 H	76	45.7	10.5
8	7440.00	49.5 AV	54.0	-4.5	1.93 H	76	39.0	10.5

Antenna Polarity & Test Distance : Vertical at 3 m

No	Frequency (MHz)	Emission Level (dBuV/m)	Limit (dBuV/m)	Margin (dB)	Antenna Height (m)	Table Angle (Degree)	Raw Value (dBuV)	Correction Factor (dB/m)
1	*2480.00	105.4 PK			1.63 V	36	106.3	-0.9
2	*2480.00	103.7 AV			1.63 V	36	104.6	-0.9
3	2483.50	59.8 PK	74.0	-14.2	1.63 V	30	60.8	-1.0
4	2483.50	48.8 AV	54.0	-5.2	1.63 V	30	49.8	-1.0
5	4960.00	41.7 PK	74.0	-32.3	2.05 V	106	37.7	4.0
6	4960.00	30.4 AV	54.0	-23.6	2.05 V	106	26.4	4.0
7	7440.00	57.5 PK	74.0	-16.5	2.04 V	101	47.0	10.5
8	7440.00	50.9 AV	54.0	-3.1	2.04 V	101	40.4	10.5

Remarks:

1. Emission Level(dBuV/m) = Raw Value(dBuV) + Correction Factor(dB/m)
2. Correction Factor(dB/m) = Antenna Factor(dB/m) + Cable Factor(dB) – Pre-Amplifier Factor(dB)
3. Margin value = Emission Level – Limit value
4. The other emission levels were very low against the limit.
5. " * ": Fundamental frequency, the limit was restricted at the RF Output Power.

Below 1GHz Data:

RF Mode	TX GFSK	Channel	CH 78 : 2480 MHz
Frequency Range	9 kHz ~ 1 GHz	Detector Function & Bandwidth	(QP) RB = 120kHz
Input Power (System)	120Vac, 60Hz	Environmental Conditions	20°C, 70% RH
Tested By	Ryan Du		

Antenna Polarity & Test Distance : Horizontal at 3 m

No	Frequency (MHz)	Emission Level (dBuV/m)	Limit (dBuV/m)	Margin (dB)	Antenna Height (m)	Table Angle (Degree)	Raw Value (dBuV)	Correction Factor (dB/m)
1	90.62	29.3 QP	43.5	-14.2	2.00 H	95	43.3	-14.0
2	250.02	44.0 QP	46.0	-2.0	1.00 H	290	53.6	-9.6
3	375.00	34.3 QP	46.0	-11.7	1.00 H	293	40.2	-5.9
4	500.06	40.0 QP	46.0	-6.0	2.00 H	124	42.9	-2.9
5	625.26	42.4 QP	46.0	-3.6	1.50 H	252	42.4	0.0
6	750.03	43.9 QP	46.0	-2.1	1.00 H	63	41.5	2.4

Remarks:

1. Emission Level(dBuV/m) = Raw Value(dBuV) + Correction Factor(dB/m)
2. Correction Factor(dB/m) = Antenna Factor(dB/m) + Cable Factor(dB) – Pre-Amplifier Factor(dB)
3. Margin value = Emission Level – Limit value
4. The other emission levels were very low against the limit of frequency range 30 MHz ~ 1 GHz.
5. The emission levels were very low against the limit of frequency range 9 kHz ~ 30 MHz: the amplitude of spurious emissions attenuated more than 20 dB below the permissible value to be report.

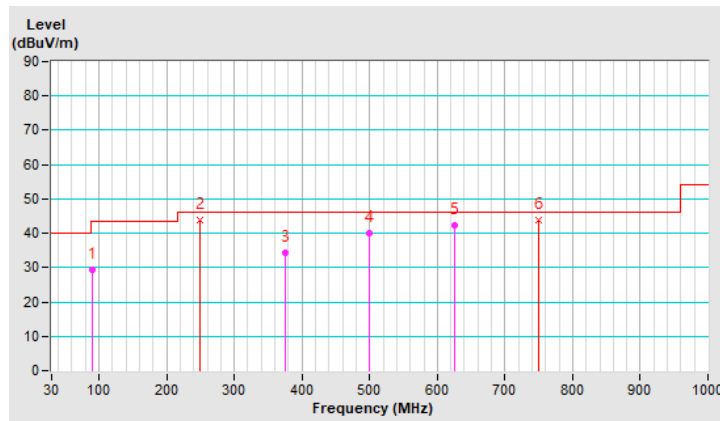

RF Mode	TX GFSK	Channel	CH 78 : 2480 MHz
Frequency Range	9 kHz ~ 1 GHz	Detector Function & Bandwidth	(QP) RB = 120kHz
Input Power (System)	120Vac, 60Hz	Environmental Conditions	20°C, 70% RH
Tested By	Ryan Du		

Antenna Polarity & Test Distance : Vertical at 3 m								
No	Frequency (MHz)	Emission Level (dBuV/m)	Limit (dBuV/m)	Margin (dB)	Antenna Height (m)	Table Angle (Degree)	Raw Value (dBuV)	Correction Factor (dB/m)
1	40.26	35.4 QP	40.0	-4.6	2.00 V	37	43.9	-8.5
2	68.29	34.1 QP	40.0	-5.9	1.00 V	14	44.4	-10.3
3	181.76	33.6 QP	43.5	-9.9	1.50 V	245	43.6	-10.0
4	250.00	40.2 QP	46.0	-5.8	2.00 V	356	49.8	-9.6
5	625.02	39.4 QP	46.0	-6.6	1.00 V	235	39.4	0.0
6	750.08	41.7 QP	46.0	-4.3	1.50 V	360	39.3	2.4

Remarks:

1. Emission Level(dBuV/m) = Raw Value(dBuV) + Correction Factor(dB/m)
2. Correction Factor(dB/m) = Antenna Factor(dB/m) + Cable Factor(dB) – Pre-Amplifier Factor(dB)
3. Margin value = Emission Level – Limit value
4. The other emission levels were very low against the limit of frequency range 30 MHz ~ 1 GHz.
5. The emission levels were very low against the limit of frequency range 9 kHz ~ 30 MHz: the amplitude of spurious emissions attenuated more than 20 dB below the permissible value to be report.

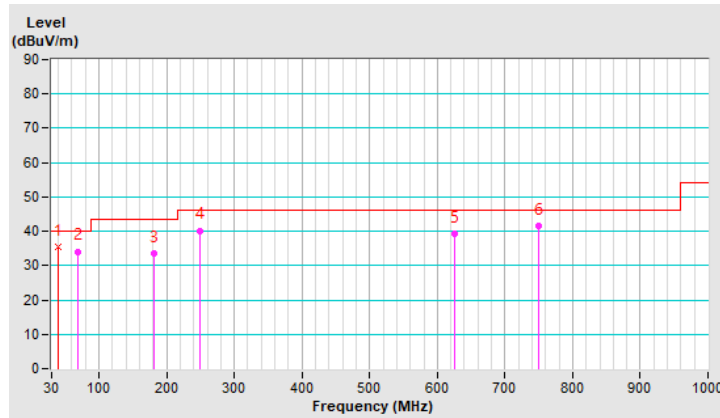

4.2 Conducted Emission Measurement

4.2.1 Limits of Conducted Emission Measurement

Frequency (MHz)	Conducted Limit (dBuV)	
	Quasi-peak	Average
0.15 - 0.5	66 - 56	56 - 46
0.50 - 5.0	56	46
5.0 - 30.0	60	50

Note: 1. The lower limit shall apply at the transition frequencies.

2. The limit decreases in line with the logarithm of the frequency in the range of 0.15 to 0.50MHz.

4.2.2 Test Instruments

Description & Manufacturer	Model No.	Serial No.	Calibrated Date	Calibrated Until
TEST RECEIVER R&S	ESCS 30	847124/029	2021/10/13	2022/10/12
LISN R&S	ESH3-Z5	848773/004	2021/10/29	2022/10/28
50 ohms Terminator NA	50	3	2021/10/27	2022/10/26
RF Coaxial Cable JYEBO	5D-FB	COCCAB-001	2021/9/25	2022/9/24
Fixed attenuator STI	STI02-2200-10	005	2021/8/27	2022/8/26
Software BVADT	BVADT_Cond_V7.3.7.4	NA	NA	NA

Note:

1. The calibration interval of the above test instruments are 12 months and the calibrations are traceable to NML/ROC and NIST/USA.
2. The test was performed in Conduction 1.
- 3 Tested Date: 2022/8/5

4.2.3 Test Procedures

- The EUT was placed 0.4 meters from the conducting wall of the shielded room with EUT being connected to the power mains through a line impedance stabilization network (LISN). Other support units were connected to the power mains through another LISN. The two LISNs provide 50 ohm/ 50uH of coupling impedance for the measuring instrument.
- Both lines of the power mains connected to the EUT were checked for maximum conducted interference.
- The frequency range from 150kHz to 30MHz was searched. Emission levels under (Limit - 20dB) was not recorded.

Note: The resolution bandwidth and video bandwidth of test receiver is 9kHz for quasi-peak detection (QP) and average detection (AV) at frequency 0.15MHz-30MHz.

4.2.4 Deviation from Test Standard

No deviation.

4.2.5 Test Setup

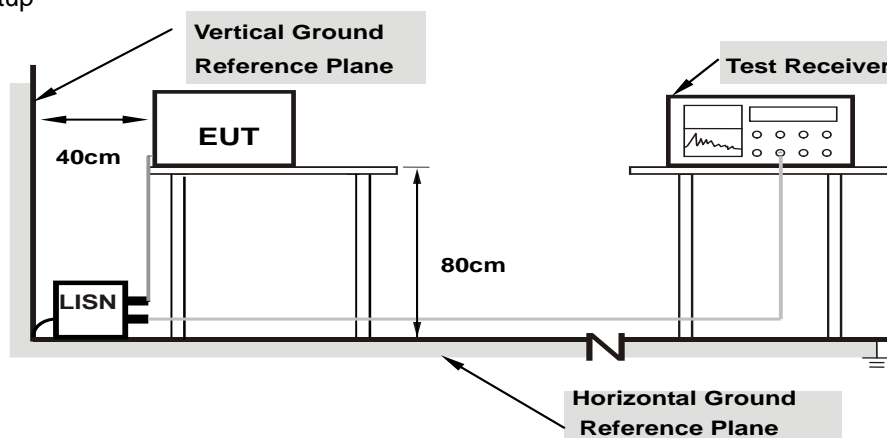

Note: 1.Support units were connected to second LISN.

For the actual test configuration, please refer to the attached file (Test Setup Photo).

4.2.6 EUT Operating Conditions

Same as 4.1.6.

4.2.7 Test Results

RF Mode	TX GFSK	Channel	CH 78 : 2480 MHz
Frequency Range	150 kHz ~ 30 MHz	Detector Function & Resolution Bandwidth	Quasi-Peak (QP) / Average (AV), 9 kHz
Input Power (System)	120Vac, 60Hz	Environmental Conditions	25°C, 75% RH
Tested By	Ryan Du		

Phase Of Power : Line (L)										
No	Frequency (MHz)	Correction Factor (dB)	Reading Value (dBuV)		Emission Level (dBuV)		Limit (dBuV)		Margin (dB)	
			Q.P.	AV.	Q.P.	AV.	Q.P.	AV.	Q.P.	AV.
1	0.15000	10.05	19.98	-2.32	30.03	7.73	66.00	56.00	-35.97	-48.27
2	0.90000	10.10	6.20	-8.74	16.30	1.36	56.00	46.00	-39.70	-44.64
3	5.80078	10.36	30.82	29.22	41.18	39.58	60.00	50.00	-18.82	-10.42
4	7.79688	10.48	29.48	29.34	39.96	39.82	60.00	50.00	-20.04	-10.18
5	9.79688	10.60	29.86	29.49	40.46	40.09	60.00	50.00	-19.54	-9.91
6	30.00000	11.38	14.48	12.98	25.86	24.36	60.00	50.00	-34.14	-25.64

Remarks:

1. Q.P. and AV. are abbreviations of quasi-peak and average individually.
2. The emission levels of other frequencies were very low against the limit.
3. Margin value = Emission level – Limit value
4. Correction factor = Insertion loss + Cable loss
5. Emission Level = Correction Factor + Reading Value

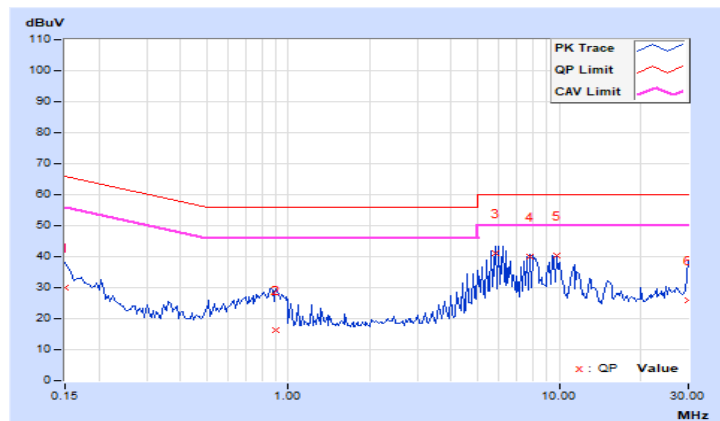

RF Mode	TX GFSK	Channel	CH 78 : 2480 MHz
Frequency Range	150 kHz ~ 30 MHz	Detector Function & Resolution Bandwidth	Quasi-Peak (QP) / Average (AV), 9 kHz
Input Power (System)	120Vac, 60Hz	Environmental Conditions	25°C, 75% RH
Tested By	Ryan Du		

Phase Of Power : Neutral (N)										
No	Frequency (MHz)	Correction Factor (dB)	Reading Value (dBuV)		Emission Level (dBuV)		Limit (dBuV)		Margin (dB)	
			Q.P.	AV.	Q.P.	AV.	Q.P.	AV.	Q.P.	AV.
1	0.15000	10.02	20.06	-2.56	30.08	7.46	66.00	56.00	-35.92	-48.54
2	0.85703	10.07	12.02	-4.12	22.09	5.95	56.00	46.00	-33.91	-40.05
3	4.59766	10.24	23.54	23.07	33.78	33.31	56.00	46.00	-22.22	-12.69
4	5.99609	10.30	32.16	32.05	42.46	42.35	60.00	50.00	-17.54	-7.65
5	7.79297	10.39	29.74	28.58	40.13	38.97	60.00	50.00	-19.87	-11.03
6	30.00000	11.00	27.09	26.34	38.09	37.34	60.00	50.00	-21.91	-12.66

Remarks:

1. Q.P. and AV. are abbreviations of quasi-peak and average individually.
2. The emission levels of other frequencies were very low against the limit.
3. Margin value = Emission level – Limit value
4. Correction factor = Insertion loss + Cable loss
5. Emission Level = Correction Factor + Reading Value

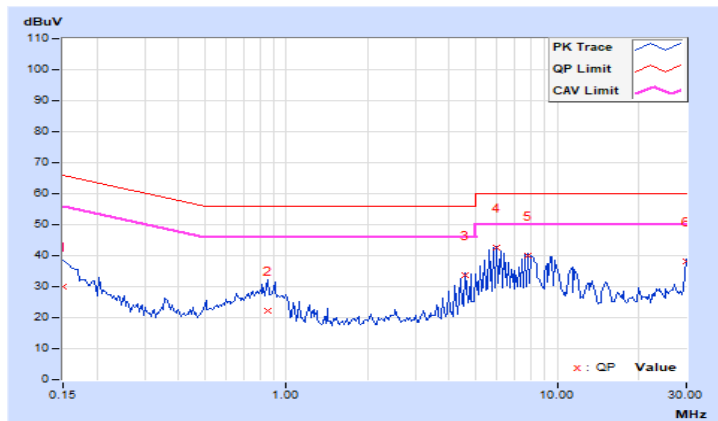

4.3 6dB Bandwidth Measurement

4.3.1 Limits of 6dB Bandwidth Measurement

The minimum of 6dB Bandwidth Measurement is 0.5 MHz.

4.3.2 Test Setup

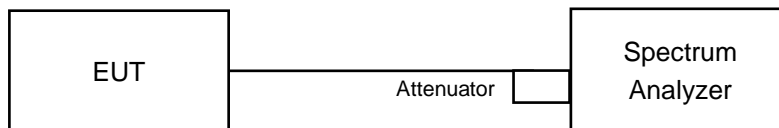

4.3.3 Test Instruments

Refer to section 4.1.2 to get information of above instrument.

4.3.4 Test Procedure

- a. Set resolution bandwidth (RBW) = 100kHz
- b. Set the video bandwidth (VBW) $\geq 3 \times$ RBW, Detector = Peak.
- c. Trace mode = max hold.
- d. Sweep = auto couple.
- e. Measure the maximum width of the emission that is constrained by the frequencies associated with the two amplitude points (upper and lower) that are attenuated by 6 dB relative to the maximum level measured in the fundamental emission

4.3.5 Deviation from Test Standard

No deviation.

4.3.6 EUT Operating Conditions

The software provided by client to enable the EUT under transmission condition continuously at lowest, middle and highest channel frequencies individually.

4.3.7 Test Results

Channel	Frequency (MHz)	6dB Bandwidth (MHz)	Minimum Limit (MHz)	Pass / Fail
0	2402	0.9	0.5	Pass
40	2442	0.88	0.5	Pass
78	2480	0.9	0.5	Pass

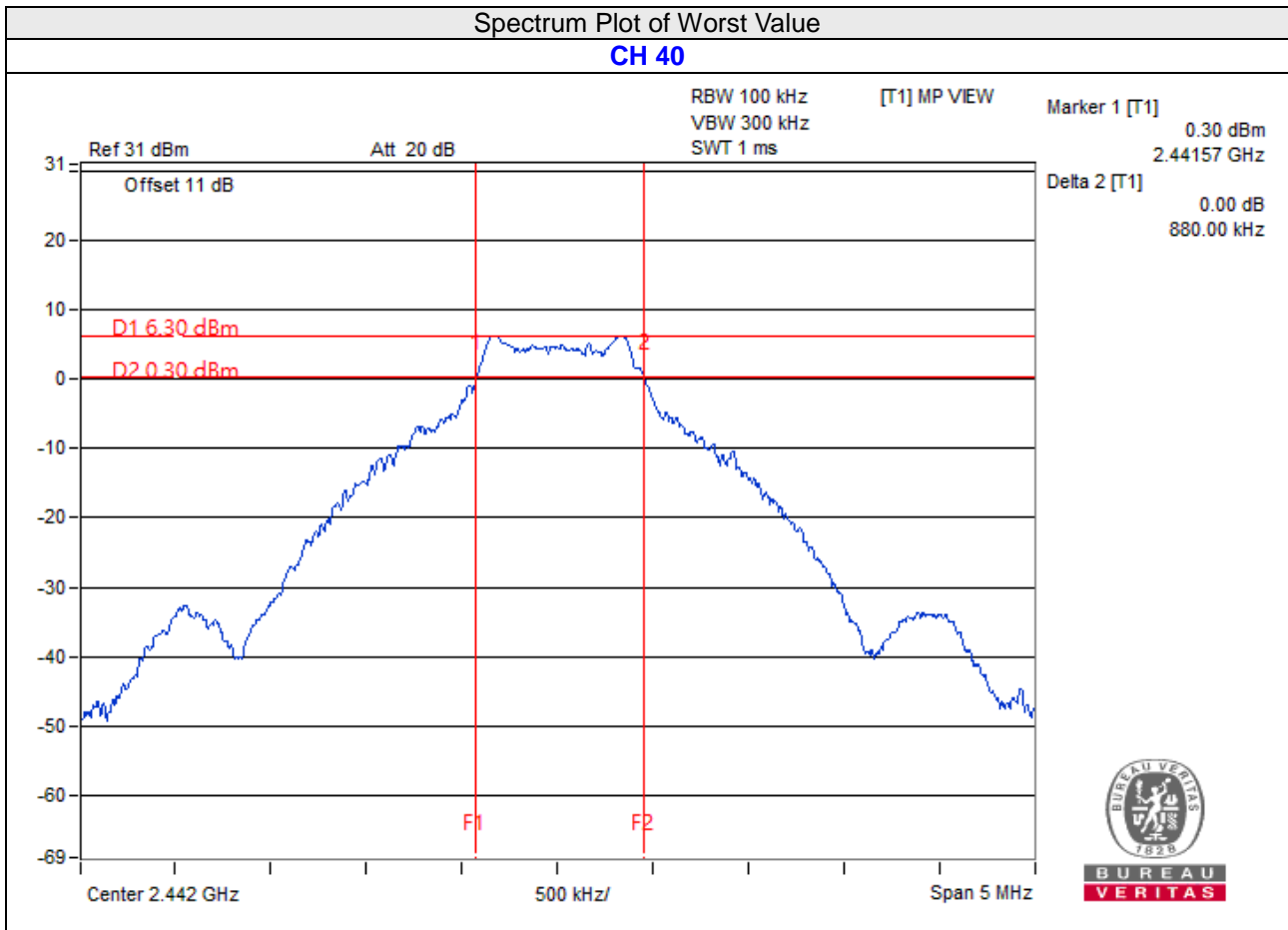

4.4 Conducted Output Power Measurement

4.4.1 Limits of Conducted Output Power Measurement

For systems using digital modulation in the 2400–2483.5 MHz bands: 1 Watt (30dBm)

4.4.2 Test Setup

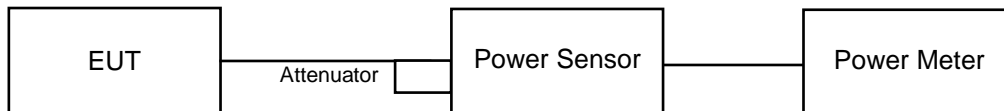

4.4.3 Test Instruments

Refer to section 4.1.2 to get information of above instrument.

4.4.4 Test Procedures

A peak power sensor was used on the output port of the EUT. A power meter was used to read the response of the peak power sensor. Record the power level.

Average power sensor was used to perform output power measurement, trigger and gating function of wide band power meter is enabled to measure max output power of TX on burst. Duty factor is not added to measured value.

4.4.5 Deviation from Test Standard

No deviation.

4.4.6 EUT Operating Conditions

The software provided by client to enable the EUT under transmission condition continuously at lowest, middle and highest channel frequencies individually.

4.4.7 Test Results

FOR PEAK POWER

Channel	Frequency (MHz)	Peak Power (mW)	Peak Power (dBm)	Limit (dBm)	Pass/Fail
0	2402	3.565	5.52	30	Pass
40	2442	3.664	5.64	30	Pass
78	2480	3.945	5.96	30	Pass

FOR AVERAGE POWER

Channel	Frequency (MHz)	Average Power (mW)	Average Power (dBm)
0	2402	3.548	5.50
40	2442	3.639	5.61
78	2480	3.917	5.93

4.5 Power Spectral Density Measurement

4.5.1 Limits of Power Spectral Density Measurement

The Maximum of Power Spectral Density Measurement is 8dBm in any 3 kHz.

4.5.2 Test Setup

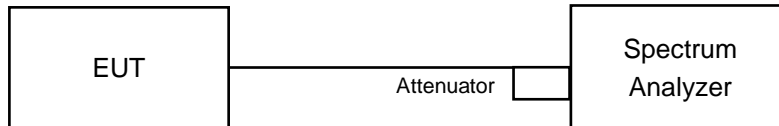

4.5.3 Test Instruments

Refer to section 4.1.2 to get information of above instrument.

4.5.4 Test Procedure

- a. Set analyzer center frequency to DTS channel center frequency.
- b. Set the span to 1.5 times the DTS bandwidth.
- c. Set the RBW to: $3 \text{ kHz} \leq \text{RBW} \leq 100 \text{ kHz}$.
- d. Set the VBW $\geq 3 \times \text{RBW}$.
- e. Detector = peak.
- f. Sweep time = auto couple.
- g. Trace mode = max hold.
- h. Allow trace to fully stabilize.
- i. Use the peak marker function to determine the maximum amplitude level within the RBW.

4.5.5 Deviation from Test Standard

No deviation.

4.5.6 EUT Operating Condition

The software provided by client to enable the EUT under transmission condition continuously at lowest, middle and highest channel frequencies individually.

4.5.7 Test Results

Channel	Freq. (MHz)	PSD (dBm/3kHz)	Limit (dBm/3kHz)	Pass /Fail
0	2402	-4.26	8	Pass
40	2442	-3.81	8	Pass
78	2480	-5.46	8	Pass

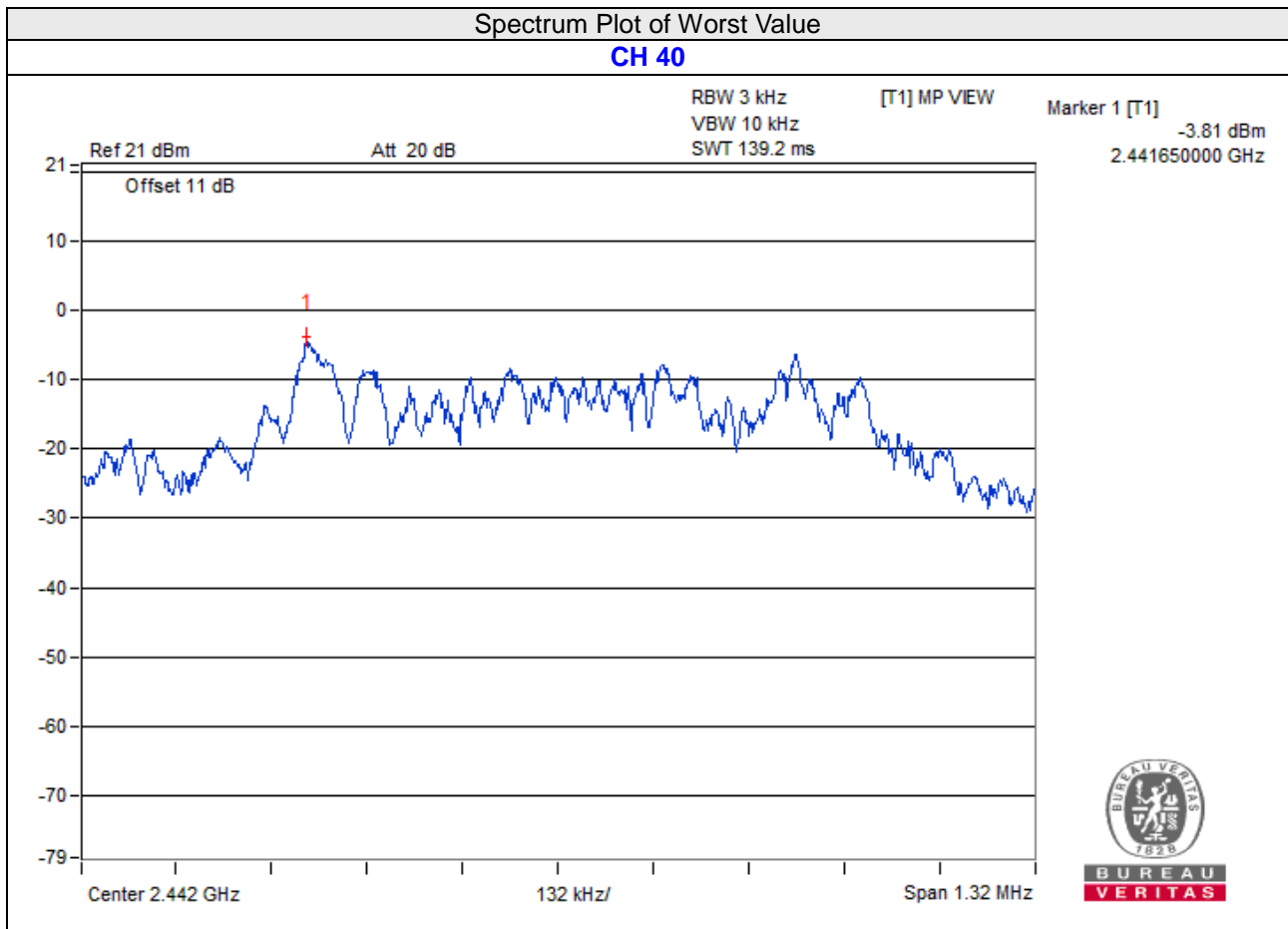

4.6 Conducted Out of Band Emission Measurement

4.6.1 Limits of Conducted Out of Band Emission Measurement

Below 20dB of the highest emission level of operating band (in 100kHz Resolution Bandwidth).

4.6.2 Test Setup

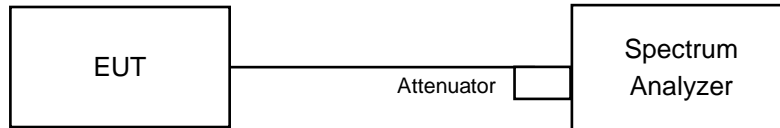

4.6.3 Test Instruments

Refer to section 4.1.2 to get information of above instrument.

4.6.4 Test Procedure

MEASUREMENT PROCEDURE REF

1. Set the RBW = 100 kHz.
2. Set the VBW \geq 300 kHz.
3. Detector = peak.
4. Sweep time = auto couple.
5. Trace mode = max hold.
6. Allow trace to fully stabilize.
7. Use the peak marker function to determine the maximum power level in any 100 kHz band segment within the fundamental EBW.

MEASUREMENT PROCEDURE OOB

1. Set RBW = 100 kHz.
2. Set VBW \geq 300 kHz.
3. Detector = peak.
4. Sweep = auto couple.
5. Trace Mode = max hold.
6. Allow trace to fully stabilize.
7. Use the peak marker function to determine the maximum amplitude level.

4.6.5 Deviation from Test Standard

No deviation.

4.6.6 EUT Operating Condition

The software provided by client to enable the EUT under transmission condition continuously at lowest, middle and highest channel frequencies individually.

4.6.7 Test Results

The spectrum plots are attached on the following pages. D1 line indicates the highest level, and D2 line indicates the 20dB offset below D1. It shows compliance with the requirement.

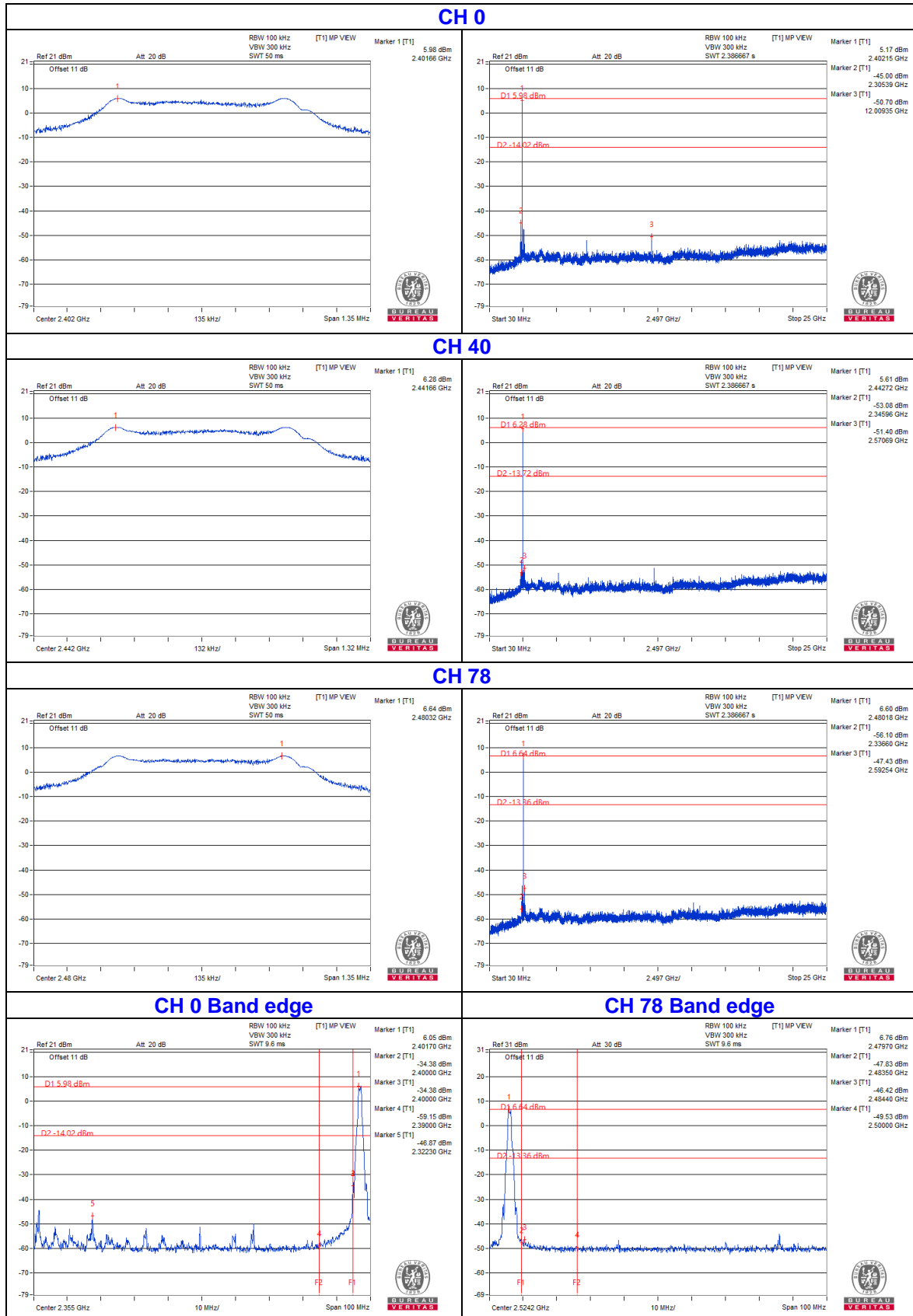

5 Pictures of Test Arrangements

Please refer to the attached file (Test Setup Photo).

Annex A - Band-Edge Measurement

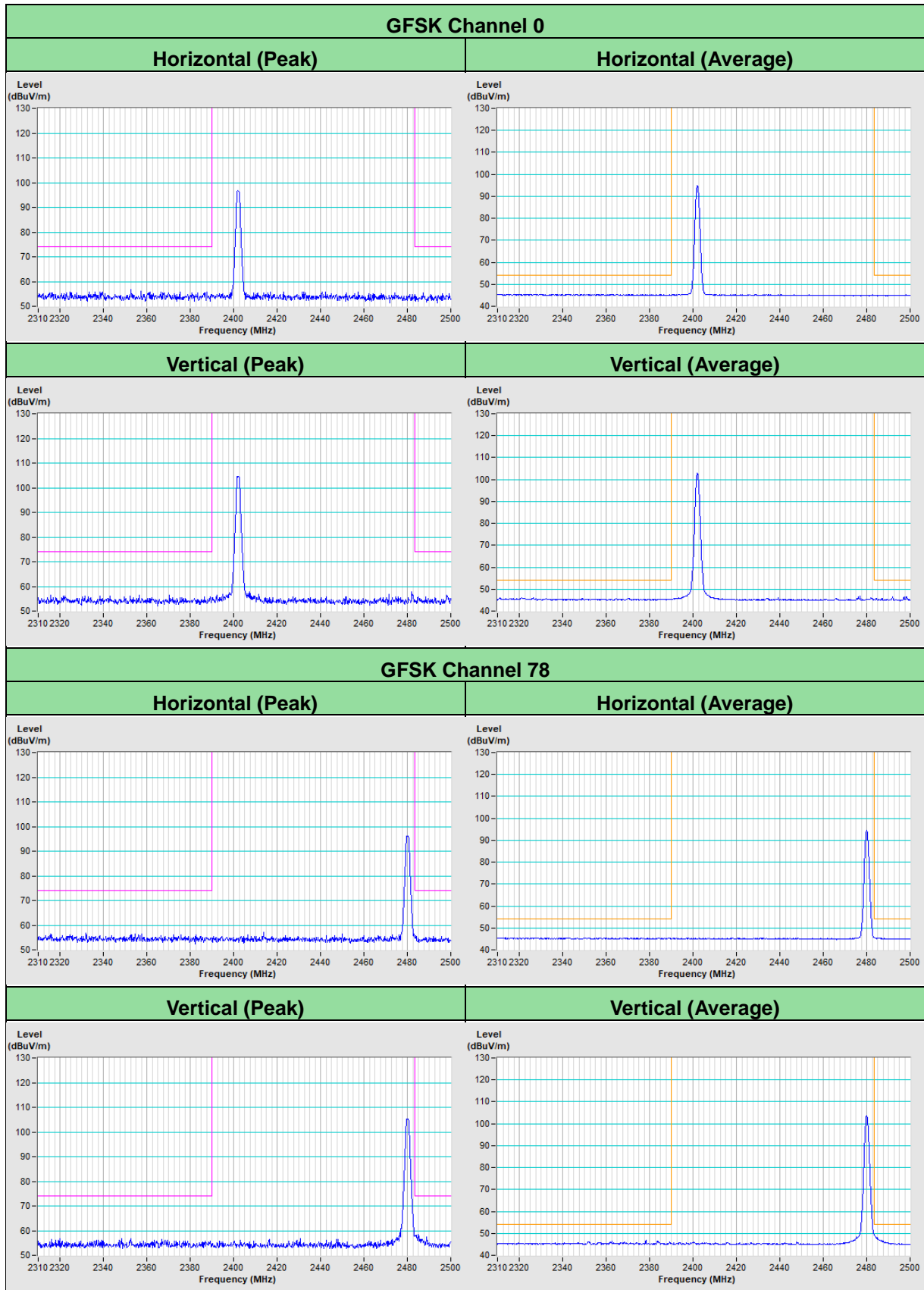

Appendix – Information of the Testing Laboratories

We, Bureau Veritas Consumer Products Services (H.K.) Ltd., Taoyuan Branch, were founded in 1988 to provide our best service in EMC, Radio, Telecom and Safety consultation. Our laboratories are FCC recognized accredited test firms and accredited according to ISO/IEC 17025.

If you have any comments, please feel free to contact us at the following:

Lin Kou EMC/RF Lab

Tel: 886-2-26052180

Fax: 886-2-26051924

Hsin Chu EMC/RF/Telecom Lab

Tel: 886-3-6668565

Fax: 886-3-6668323

Hwa Ya EMC/RF/Safety Lab

Tel: 886-3-3183232

Fax: 886-3-3270892

Email: service.adt@tw.bureauveritas.com

Web Site: www.bureauveritas-adt.com

The address and road map of all our labs can be found in our web site also.

--- END ---