

**SD** *GlucoNavii* **Voice N**  
Blood Glucose Voice Monitoring System

**User Instruction  
Guide**

  
**Voice**  
—  
  
**GDH**  
—  
  
**0.5 µL**

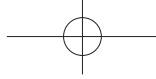



## SD GlucoNavii® Voice N BLOOD GLUCOSE MONITORING SYSTEM

### Dear SD GlucoNavii® Voice N System Owner;

Thank you for choosing SD GlucoNavii® Voice N Blood Glucose Monitoring System. Your new SD GlucoNavii® Voice N Blood Glucose Monitoring System is an important tool that can help you better manage your diabetes. Important steps for using the System are inside this guide. Please read it carefully.

If you have questions, we are here to help.  
Please contact SD Biosensor, Inc.  
Tel : +82-31-300-0400  
Fax : +82-31-300-0499  
website : [www.sdbiosensor.com](http://www.sdbiosensor.com)

We offer assistance 24 hours a day, 365 days a year in many languages. You can also visit [www.sdbiosensor.com](http://www.sdbiosensor.com) for diabetes management tools and product demonstrations.

Please refer to the instructions with following symbols in this User Instruction Guide.



To identify conditions or practices that could result in damage to equipment or other property.



To provide an additional useful information.



Before using any product to test your blood glucose, read all instructions and practice the test. Do all quality control checks as directed and consult with a diabetes health care professional. These recommendations apply to all blood glucose monitoring systems and are supported by the American Association of Diabetes Educators, the American Diabetes Association, the U.S. Food and Drug Administration, and the Advanced Medical Technology Association.

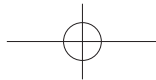

## TABLE OF CONTENTS

<b>Chapter 1 : Understanding Your New System</b> .....	4
1. Before You Start Testing.....	4
2. Special Information for Healthcare Providers and Caregivers.....	6
3. Indication for Use .....	6
4. Product Description and the Principle of the use.....	6
5. The Complete SD GlucoNavii® Voice N Blood Glucose Monitoring System .....	7
6. SD GlucoNavii® Voice N Meter .....	8
7. SD GlucoNavii® Voice N Test Strips .....	12
8. SD GlucoNavii® Voice N Accessories .....	13
9. Changing the Battery.....	14
10. Meter Set up .....	16
11. Using SD GlucoNavii® Voice N Test Strips.....	28
<b>Chapter 2 : Control Solution Test</b> .....	30
1. Performing a Control Solution Test.....	31
2. Troubleshooting Control Solution Test.....	34
<b>Chapter 3 : Testing Your Blood Sugar</b> .....	36
1. Getting a Drop of Blood .....	36
2. Performing a Blood Glucose Test .....	38
3. Understanding Test Results .....	40

<b>Chapter 4 : Using NFC function</b> .....	42
1. Information on NFC function .....	42
2. Information on Caution for NFC .....	42
3. Using NFC function .....	43
4. How to use GlucoNaviiApp .....	44
5. How to use SD NFC Software for PC .....	45
<b>Chapter 5 : Using the Meter Memory</b> .....	47
1. Searching Test Results.....	48
2. Downloading results to a computer.....	52
<b>Chapter 6 : Maintenance and Troubleshooting</b> .....	53
1. Performing a SD Glucose check strip.....	53
2. Cleaning the meter .....	54
3. Maintenance, Testing and Transportation.....	55
4. Cleaning the Lancing Device .....	56
5. Screen Messages and Troubleshooting .....	57
6. Warnings, Precautions and Limitations .....	63
<b>Chapter 7 : Product Technical Information</b> .....	65
1. System Specifications.....	65
<b>Annex 1 : Information for Healthcare Professionals</b> .....	67
<b>Annex 2 : Symbol</b> .....	68
<b>Annex 3 : References</b> .....	70

## CHAPTER 1 : Understanding Your New System

The SD GlucoNavii® Voice N Blood Glucose Monitoring System

### 1. Before You Start Testing

#### About the meter and test strips

- Carefully read and follow the instructions in the User Instruction Guide and Package Inserts for the test strips and SD GlucoNavii® control solution. It is very important to follow the instructions in order to prevent an incorrect result or improper treatment.
- The meter, test strips, and SD GlucoNavii® control solution are only for use outside the body (in vitro).
- Your new meter is designed for testing fresh capillary whole blood samples (for example, blood from your fingertip, palm, upper arm, or forearm) or fresh venous blood.
- Only use SD GlucoNavii® Voice N test strips. Other test strips will give inaccurate results or E-1 error message.
- Do not use the SD GlucoNavii® Voice N blood glucose monitoring system for testing of serum or plasma or arterial blood.
- Inspect the container of test strips before using them for the first time. If you see any damage to the container cap or if anything prevents the cap from closing properly, do not use the test strips. Contact SD Biosensor, Inc. Damaged test strips can cause inaccurate results, which could lead to improper treatment.

#### About your new meter

- Set the beep, date, time, hypo warning, post-meal alarm and alarm on your meter before you begin testing.
- SD GlucoNavii® Voice N system has been found to be accurate at altitudes up to 11,549 feet. (3,520 meters)

## SD GlucoNavii® Voice N BLOOD GLUCOSE MONITORING SYSTEM



- Keep the meter and testing supplies away from small children.
- The battery door, test strips, lancets, protective disks, and control solution cap are choking hazards.
- Do not eat the test strips.
- Do not swallow or inject SD GlucoNavii® control solution, or use control solutions for any purpose.

### Important Information

- **Dehydration:** Severe dehydration resulting from excessive water loss may cause false low results. If you believe you are suffering from severe dehydration, consult a healthcare professional immediately.
- **Low glucose results:** If your test result is lower than 70 mg/dL or is shown as Lo, it may mean hypoglycemia (low blood glucose). This may require immediate treatment according to your healthcare professional's recommendations. Although this result could be due to a test error, it is safer to treat first, and then repeat the test.
- **High glucose results:** If your test result is greater than 180 mg/dL or is shown as HI, it may mean hyperglycemia (high blood glucose). If you do not have symptoms, first repeat the test. Your healthcare professional can work with you to decide what actions, if any, you should take if you continue to get results higher than 180 mg/dL or if you have symptoms.
- **Repeated unexpected results:** If you continue to get unexpected results, check your system with control solution. See Checking the System with Control Solution on pages 30 - 35. If you are experiencing symptoms that are not consistent with your blood glucose results and you have followed all instructions in this User Instruction

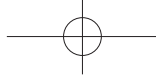

## SD GlucoNavii® Voice N BLOOD GLUCOSE MONITORING SYSTEM

Guide, call your healthcare professional. Never ignore symptoms or make significant changes to your diabetes control program without speaking to your healthcare professional.

- Consult your physician to determine if it is appropriate for your child to be taught how to use the meter system or any other medical products.

### 2. Special Information for Healthcare Providers and Caregivers

- Do not use this device to measure blood glucose in people who are experiencing cardiovascular collapse (severe shock) or decreased peripheral blood flow.
- **Hematocrit:** A hematocrit (percentage of your blood that is red blood cells) that is higher than 70% can cause false results.

### 3. Indication for use (Purpose of the devices)

Your new SD GlucoNavii® Voice N meter and accessories work together to measure the amount of glucose (sugar) in your blood.

Your SD GlucoNavii® Voice N blood glucose monitoring system is indicated for monitoring glucose in fresh capillary whole blood or fresh venous blood. Testing is done outside the body. (*in vitro* diagnostic use) This system is indicated for home (over-the-counter or OTC) by person with diabetes, or in clinical settings by healthcare professionals, as an aid to monitor the effectiveness of diabetes control. This system should not be used for the diagnosis of diabetes.

The SD GlucoNavii® Voice N blood glucose monitoring system is suitable for self-testing.

### 4. Product Description and the Principle of the use

SD GlucoNavii® Voice N test strip is designed with an electrode that measures glucose levels. Glucose in the

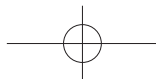



---

## SD GlucoNavii® Voice N BLOOD GLUCOSE MONITORING SYSTEM

blood sample mixes with reagent on the test strip that cause a small electric current. The amount of current that is created depends on how much glucose is in the blood.

SD GlucoNavii® Voice N meter measures the current that is created and converts the measurement to the amount of glucose that is in the blood.

The blood glucose result is displayed on the meter's LCD display.

By touching a drop of blood to the tip of the SD GlucoNavii® Voice N test strip, the strip's reaction chamber automatically draws the blood into the strip through capillary action. When the chamber is full, SD GlucoNavii® Voice N meter start to measure the blood glucose level. It is a simple and practical system for the daily monitoring of your blood glucose level.

### 5. The Complete GlucoNavii® Voice N BGMS

The system includes:

- SD GlucoNavii® Voice N Meter
- SD GlucoNavii® Voice N Test strips
- SD Glucose Check strip
- 3V battery type CR2032
- User Instruction Guide
- Quick Guide
- Self-test Diary
- Test Strip Package Insert
- Carrying Case
- Lancing device
- Lancet

#### <Option>

- SD GlucoNavii® control solution
- SD GlucoNavii® control solution insert
- SD GlucoNavii® NFC application for Android phone
- SD NFC Software for PC
- SD NFC Reader/Writer



### 6. SD GlucoNavii® Voice N Meter

Understanding Your New System



**Display**

Shows blood glucose result, messages, and glucose result stored in memory.

**ON/OFF Button**

Press to turn meter ON or OFF.

**Arrow Buttons**

Use for meter setup and review of memory moving to the right and left.

**Test Strip Slot**

Insert test strip here.



**Data port**

Communicate test results with a personal computer. (If you have software)

**Battery Cover**

Remove cover to change battery.





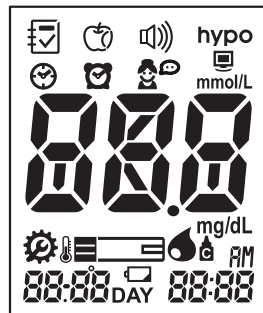

**Location of NFC function**

Tap a smartphone or SD NFC R/W for communication.

SD GlucoNavii® Voice N BLOOD GLUCOSE MONITORING SYSTEM







Display



 00:00	Indicates Measurement time		Indicates during the meter setting
	Indicates sound level		Warns when the batteries are low or must be replaced
	Indicates if environmental temperature is exceeded during testing		Indicates post-meal or pre-meal
00:00	Testing date		Indicates a test result stored in memory
mmol/L mg/dL	Unit of test result	000	Test result and Voice N message

Understanding Your New System

SD GlucoNavii® Voice N BLOOD GLUCOSE MONITORING SYSTEM

<b>DAY</b>	Indicates the average result		Test strip
	Tell you when to apply the sample and indicates if you select whole blood for blood reference type		Indicates a control solution test result
	Indicates alarm setting	<b>hypo</b>	Indicates hypo warning
	Indicates time setting		Indicates voice language setting
	Indicates S/W communication		

Understanding Your New System

SD GlucoNavii® Voice N BLOOD GLUCOSE MONITORING SYSTEM

**1) Strip Stand-by Display**

After turning on the meter, the below will be displayed automatically to show the test strip icon flashing. When the test strip icon is flash at any setting stage, it can be strip stand-by mode.

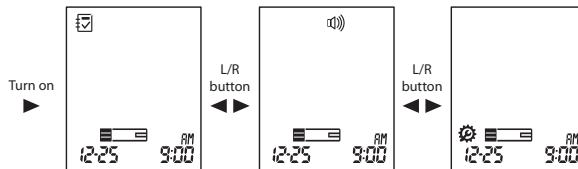

**2) Blood Stand-by Display**

If a test strip is inserted into the meter in either Strip Stand-by Display or turning off, the below will be displayed automatically to show the appropriate test result after applying blood sample. And if you pull off the test strip, it will return to Strip Stand-by Display. In this Blood Stand-by Display, the ON/OFF button doesn't act. But if you need to check the meter or the test strip, you may use a control solution. Then the control solution icon in the left-side of test strip icon will be displayed by pressing left button during 3 seconds.

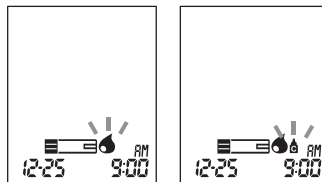

SD GlucoNavii® Voice N BLOOD GLUCOSE MONITORING SYSTEM

**7. SD GlucoNavii® Voice N Test Strip**

SD GlucoNavii® Voice N System measures the amount of glucose in whole blood. Blood is applied in the Yellow Window (TOP EDGE) of SD GlucoNavii® Voice N Test Strip and is automatically drawn into the reaction cell where the reaction takes place.

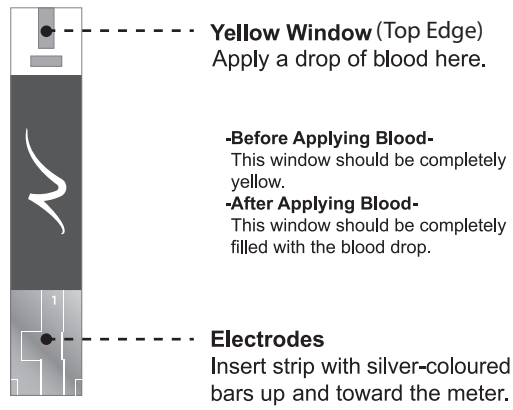

Understanding Your New System

SD GlucoNavii® Voice N BLOOD GLUCOSE MONITORING SYSTEM

**8. SD GlucoNavii® Voice N Accessories**

Lancet

SD Glucose check strip

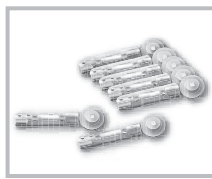

Electrode

Arming Knob

**Lancing Device**

Cap & Comfort dial with puncture depth selection

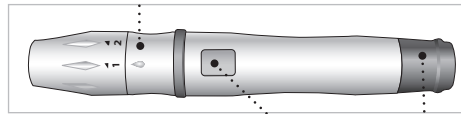

Release Button

Arming Knob

**SD GlucoNavii® control solution**



**SD Voice N Reader/Writer**



Understanding Your New System

## 9. Changing the Battery

### Inserting and replacing the Battery

Your meter is shipped with two 1.5V AA alkaline batteries that needs to be inserted before testing. The batteries that come with your meter can be found in the mesh pocket of your carrying case. Batteries' life will vary depending on usage, so always keep a spare on hand. The meter saves batteries' power by automatically turning off after 1 minute without inserting a test strip or 3 minutes with a test strip, from non-use. If the meter does automatically shut off, all tests in memory are saved.

**STEP-1:** Push the recessed plastic tab of the battery compartment forward to flip and open the battery door.

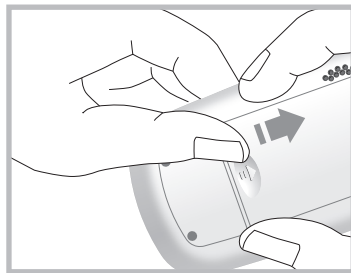

SD GlucoNavii® Voice N BLOOD GLUCOSE MONITORING SYSTEM

**STEP-2:** Insert the 1.5V AA alkaline batteries into the compartment correctly with respect to their polarity (follow the directions on the case).

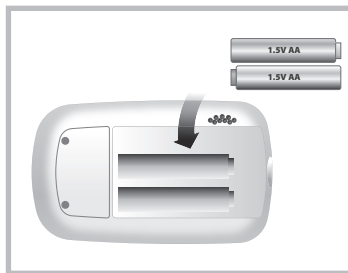

**STEP-3:** Snap battery cover back in place.

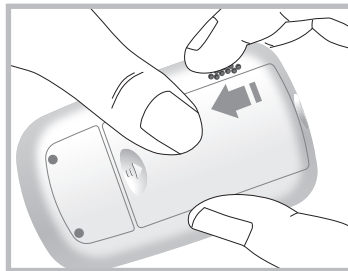

**STEP-4:** Push the ON/OFF button or insert a strip to start testing.



NOTE

After inserting or replacing the battery, confirm that the time and date are set correctly. If they are not, use the ON/OFF and left/right buttons to reset the meter before testing. See the "10 Meter Set up".



### 10. Meter Set up

#### STEP-1 : Setting the sound level

1. In strip stand-by mode with sound icon, if you press the ON/OFF button, the display for setting the sound level will be appeared.

Set the sound level by pressing the left or right button.

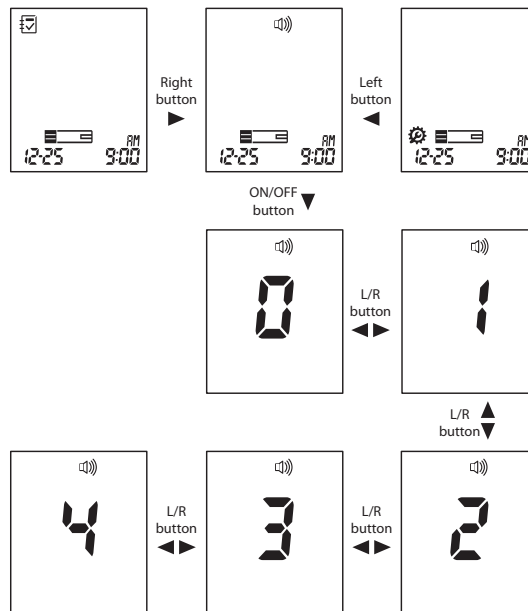

**STEP-2: Setting the Hypo warning**



- In strip stand-by mode with set icon, if you press the ON/OFF button, the display for setting the hypo warning will be appeared.
- Set the OFF or 60/70/80 mg/dL by pressing the left or right button.

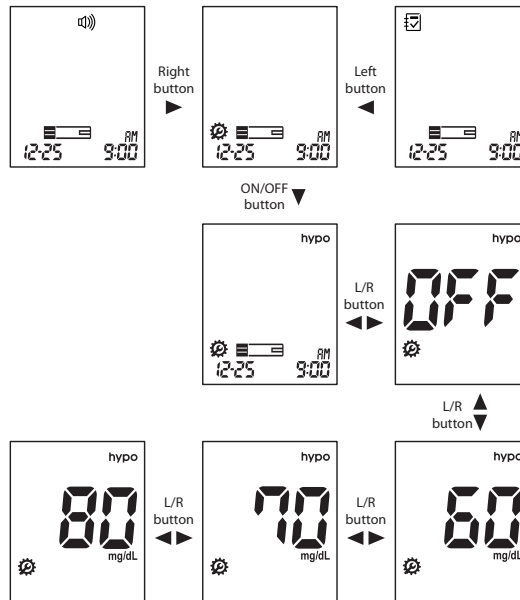

Your new meter comes with a preset time and date. You may need to change the time to your time zone. Having the right time and date in your meter is important if you use the meter memory. It also helps your healthcare team interpret your results.

**STEP-3: Setting the date and time**

**[ Date Setting ]**

1. In strip stand-by mode with hypo set icon, if you press the right button, the display for setting the date & time will be appeared. And when you press the ON/OFF button, year digit will be appeared. Set the correct year by pressing the left or right button and then go to time setting by pressing the ON/OFF button.

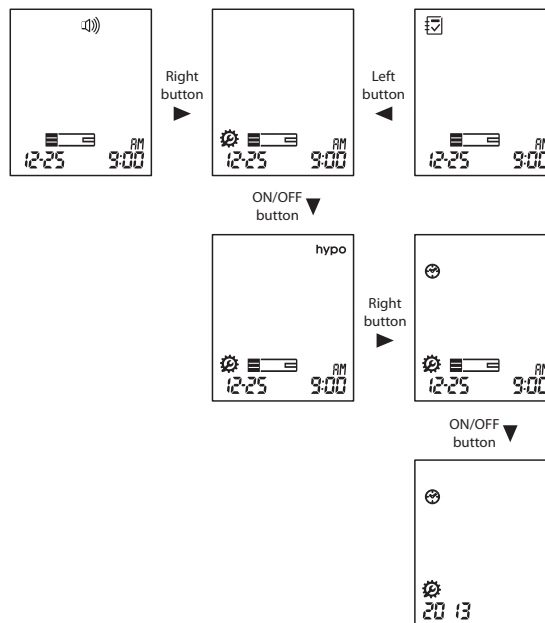

SD GlucoNavii® Voice N BLOOD GLUCOSE MONITORING SYSTEM

- Next will appear the setting display for month and day format. The meter can display the month and day in either a Month-Day (m-d) format or a Day-Month (d-m) format. Set the preferred format on the display by pressing either the left or the right button and select by pressing the ON/OFF button.



[Left or right button]



[ON/OFF button]

- Set the correct month or day on the display by pressing either the left or the right button and select by pressing the ON/OFF button.



**[ Time Setting ]**

1. Next will appear the display for setting the 12 or 24 Hour clock format. The meter can display the time in either the 12h format or the 24h format. Set the preferred format on the display by pressing either the left or the right button and select by pressing the ON/OFF button.



[Left or right button]



[ON/OFF button]

2. Next will appear the setting display for time format. Set the correct hour and minute on the display by pressing either the left or the right button and select the correct time by pressing the ON/OFF button.



**STEP-4: Post-meal alarm**

You can use the meter's post-meal alarm function to remind you to test your blood glucose after meal.

1. In strip stand-by mode with time set icon, if you press the right button, the display for setting the post-meal alarm set icon will be appeared. And when you press the left or right button, '2h' or 'OFF' will be appeared. Select the preferred feature by pressing the ON/OFF button.

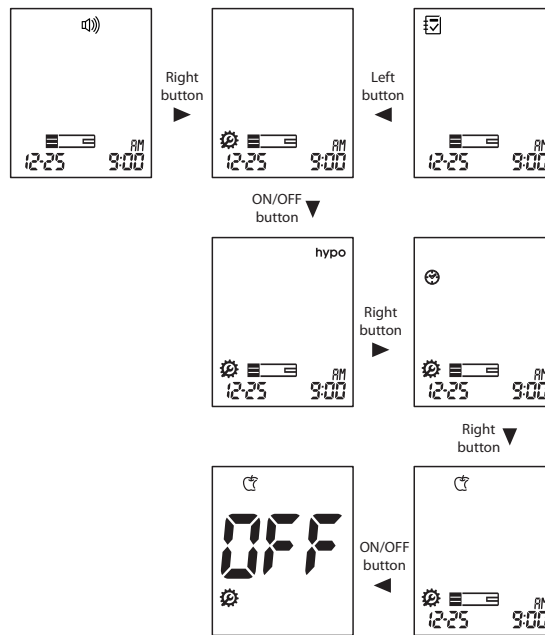

SD GlucoNavii® Voice N BLOOD GLUCOSE MONITORING SYSTEM

2. Set the post-meal alarm mode '2h' or 'off' by pressing either the left or the right button and then select the preferred feature by pressing the ON/OFF button.

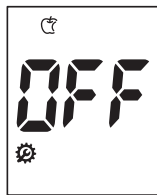

[Left or right button]



[ON/OFF button]



NOTE

- If you select the post-meal alarm '2h' feature and test with pre-meal mark, the 'clock symbol' will appear on result display and the 'beep' sound will be made in 2 hours to remind you to test your blood glucose after meal for 1 minute.
- If you perform the pre-meal test while the post-meal alarm setting is on, then the post-meal mark will appear automatically on your LCD when you test within following period: from 30min to 130min after your pre-meal test.
- If you mark the new test result with a pre-meal mark, the old alarm setting will be ignored and only the new setting will sound in 2 hours.

**STEP-5: Setting the alarm**

You can use the meter's alarm function to remind you to test your blood glucose.

1. In strip stand-by mode with post-meal alarm set icon, if you press the right button, the display for alarm set icon will be appeared. And when you press the left or right button, 'On' or 'OFF' will be appeared. Select the preferred feature by pressing the ON/OFF button.

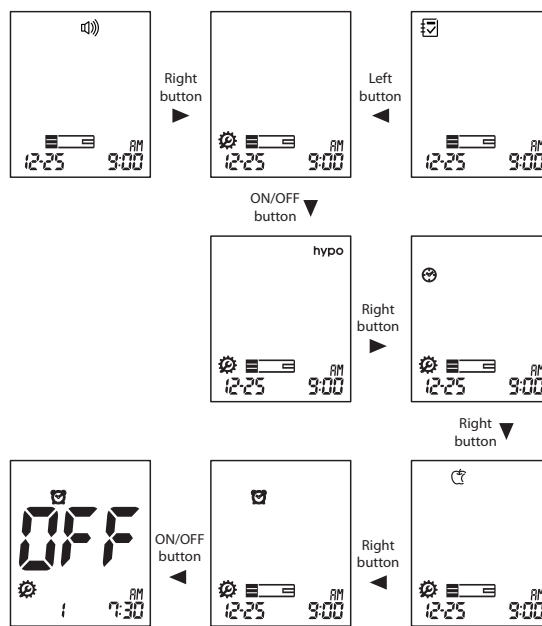



SD GlucoNavii® Voice N BLOOD GLUCOSE MONITORING SYSTEM

2. Set the first alarm on or off by pressing either the left or the right button and then select the preferred feature by pressing the ON/OFF button.

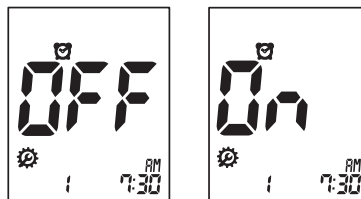

[Left or right button]

[ON/OFF button]

- If you select the alarm off feature, next will appear the Strip Stand-by Display.
- If you select the alarm on feature, you can set the alarm up to four times a day at any time you want.



NOTE

3. If you select the alarm on feature in first alarm mode, the clock will blink. Set the correct time and minute you want to set an alarm on the display by pressing either the left or the right button and then select the preferred feature by pressing the ON/OFF button.

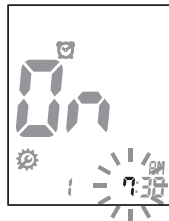

[ON/OFF button] [Left or right button]



If you select the alarm off feature in first (also second, third and fourth) alarm mode, next will appear the Strip Stand-by Display.

SD GlucoNavii® Voice N BLOOD GLUCOSE MONITORING SYSTEM

- If you finish setting the first alarm, next will appear the second alarm setting mode. Set the alarm with the same way as above. [2, 3]

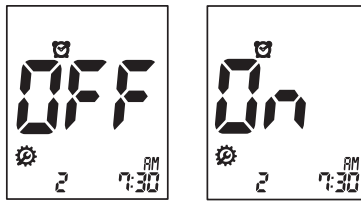

- You can set the third and fourth alarm mode with the same way as above. [2, 3]

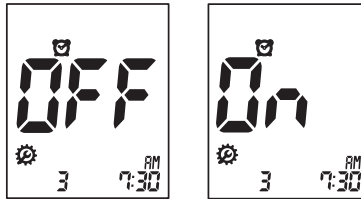

**STEP-6 : SETTING THE LANGUAGE**

This function is to review the latest test result when inserting the strip into the meter. You can check your latest test result before testing.

- In strip stand-by mode with alarm set icon, if you press the right button, the display for language set icon will be appeared. And when you press the left or right button, 'On' or 'OFF' will be appeared. Select the preferred feature by pressing the ON/OFF button.

SD GlucoNavii® Voice N BLOOD GLUCOSE MONITORING SYSTEM

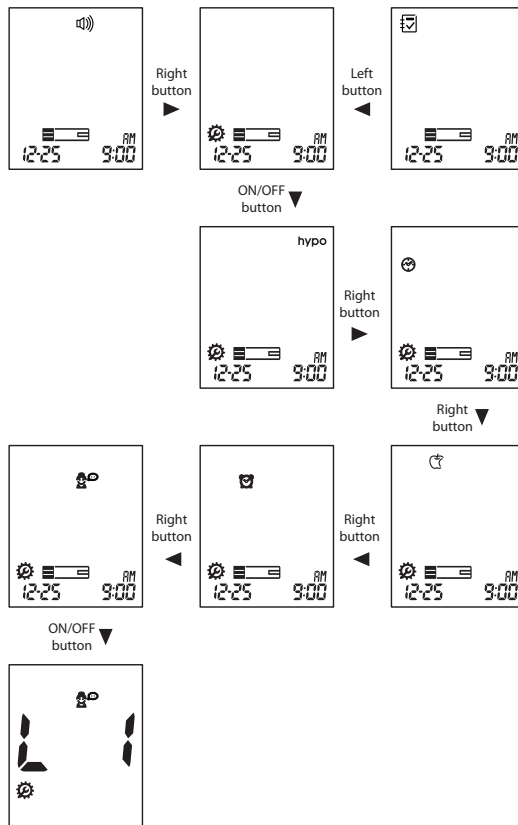

Understanding Your New System

SD GlucoNavii® Voice N BLOOD GLUCOSE MONITORING SYSTEM

2. When you press the left or right button, 'L-1', 'L-2' and 'L-3' will be appeared. The meter has 3 different languages per each country.

Language numbers are as follows.

- L 1 : English
- L 2 : Spanish
- L 3 : French
- L 4 : German
- L 5 : Russian
- L 6 : Portuguese
- L 7 : Hindustani
- L 8 : Chinese
- L 9 : Japanese
- L 10 : Korean

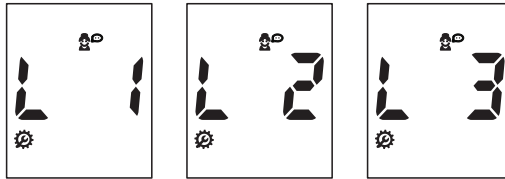

3. After selecting a language, announce level figure will be displayed. By pressing the left or right button, 'br' or 'FUL', namely brief or full level can be selected.

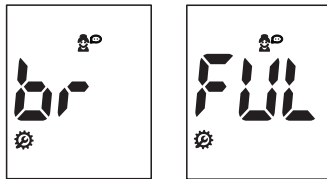

**11. Using SD GlucoNavii® Voice N Test Strips**  
**[ Important Test Strip Information ]**

- SD GlucoNavii® Voice N blood glucose test strip should be used with SD GlucoNavii® Voice N meter. Using other glucose test strip can cause inaccurate the result or 'E-1' error message.
- After removing a test strip from the container, replace the container cap immediately and close it tightly.
- Use the test strip within three minutes after you take it out of the container.
- Store test strip containers in a cool, dry place at 2-32°C(36-90°F). Keep away from direct sunlight and heat. Do not refrigerate test strips.
- Do not expose strips to heat, moisture or humidity. Temperatures outside the required range, as well as moisture and humidity (e.g. bathroom, kitchen, laundry room, car, or garage) can damage your test strips and lead to inaccurate results.
- Store test strips in their original container only to avoid damage or contamination. Do not transfer test strips to any other storage device, and do not store outside of their original container.
- Do not use test strips from any container that is damaged or left open to air.
- Write the opening date on the container label when you first open it. Discard remaining SD GlucoNavii® Voice N Test Strips after the discard date. (6 months after first opening from the container)
- SD GlucoNavii® Voice N Test Strips are for single use only. Never reuse a test strip that has had either blood or control solution applied to it.

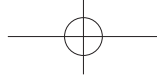

**SD GlucoNavii® Voice N BLOOD GLUCOSE MONITORING SYSTEM**

- Avoid getting dirt, food or liquids on the test strip. With clean, dry hands, you may touch the test strip anywhere on its surface.
- Do not bend, cut, or alter SD GlucoNavii® Voice N Test Strip in any way.



Do not swallow test strips. The test strip container may contain drying agents that are harmful if inhaled or swallowed and may cause skin or eye irritation.



Understanding Your New System

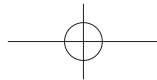

## CHAPTER 2 : Control Solution Test

### Why you do control solution test ;

- SD GlucoNavii® control solution is used to check that the meter and the test strips are working together as a system and that you are performing the test correctly.
- It is very important that you do this simple check routinely to make sure you get an accurate result.

### When you do control solution test ;

- You open a new box test strips.
- You left the test strip container open or you think your test strips have been damaged.
- Your test strips were stored in extreme temperatures and/or humidity.
- You want to check the meter and test strips.
- You dropped the meter.
- Your test result does not agree with how you feel.
- You want to check if you are testing correctly.

### Before you begin ;

- Use only SD GlucoNavii® control solution.
- Check the expiration date on the control solution container. Record the opening date on the container label. Do Not use after expiration or discard date (date opened plus three months), whichever comes first.
- Control solution, meter and test strips should be at room temperature 18-30°C (64-86°F) before testing with control solution.

Control solution display



---

### SD GlucoNavii® Voice N BLOOD GLUCOSE MONITORING SYSTEM

- Shake the container, discard the first drop of control solution, and wipe off the tip to ensure a proper sample and an accurate result.
- Store SD GlucoNavii® control solution tightly closed at temperatures between 8-30°C (46-86°F). Do Not refrigerate.



- Do not swallow SD GlucoNavii® control solution; it is not for human consumption.
- Do not apply SD GlucoNavii® control solution to the skin or eyes as it may cause irritation.

#### 1. Performing Control Solution Test



You need the meter, a test strip, and control solution Level M or Level H. The control level is printed on the test strip label. For more information how to obtain SD GlucoNavii® control solution, call at +82-31-300-0400.



A set of Level M and H control solutions is available for purchase. To order control solutions, talk to your pharmacist or medical surgical supply dealers. Your meter is designed to recognize the difference between SD GlucoNavii® control solution and blood. The meter automatically stores the test results using a control solution, letting your review them. But the meter does not include them in averages.



Control solution display



SD GlucoNavii® Voice N BLOOD GLUCOSE MONITORING SYSTEM

**STEP-1:**

- 1) Remove a new test strip from container. Be sure to tightly replace container cap after removing test strip.
- 2) Insert a test strip (yellow window printed '✓' facing up) into test strip slot. The meter turns on automatically.



**STEP-2:**

- 1) Press the left button for 3 seconds to check the testing system using a control solution in Blood Stand-by Display. If you don't want a control solution test, press the left button again.

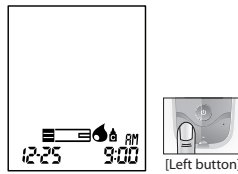

- 2) Shake the control solution container and discard the first drop of solution. Gently squeeze the container to form one small drop. Bring the drop to the edge of the strip, and allow the strip to automatically draw the control solution into the yellow window. When control solution is applied to the test strip, the meter counts down from 5 to 1 second on the display. Tightly replace the cap on control solution.

Control solution display

SD GlucoNavii® Voice N BLOOD GLUCOSE MONITORING SYSTEM

- 3) The control solution result appears on the screen in just 5 seconds.
- 4) Compare control solution result with the range printed on the test strip container.  
If the results are not within the control range printed on the test strip container, then the meter and strips may not be working properly. Repeat the control solution test.



- 5) Remove the used test strip for control solution from the meter and discard it.

The control solution range printed on the test strip container is for SD GlucoNavii® Control Solution only. It is not a recommended range for your blood glucose level.



[Example]

Control Range	
Level M	Level H
90-140 mg/dL	170-240 mg/dL
5.0-7.8 mmol/L	9.4-13.3 mmol/L

[This is an example. Refer to the ranges on your test strip container.]

Control solution display

**2. Troubleshooting Control Solution Test**

Check	Action
<p>Did you do the test in control solution mode? Did you see "control solution container icon" on the screen with the result?</p>	<p>If not, do the test again. Insert a test strip; Press the left button for 3 seconds in Blood Stand-by Display to display a control solution container icon.</p>
<p>Have the test strips and/or control solution expired?</p>	<p>Make sure that test strips and control solutions are not past expiration date. This date is shown the container/bottle. Make sure the expiration date of both a test strip and a control solution.(test strip : 6 months, control solution : 3months)</p>
<p>Were control solutions at room temperature (18-30°C, 64-86°F) when used?</p>	<p>If not, retest with new bottle of control solution, or warm up/cool down to room temperature. (18-30°C, 64-86°F)</p>

Control solution display

SD GlucoNavii® Voice N BLOOD GLUCOSE MONITORING SYSTEM

Check	Action
Did you insert test strip firmly into meter?	Make sure test strip is inserted into the test strip slot until it will go on further.
Did you follow the procedure correctly?	Read again "Chapter 2 : Control Solution Test" and retest.
Were test strips stored correctly? (at 2-32°C, 36-90°F) Was the bottle cap replaced immediately after removing a test strip?	If not, retest with a new container of test strips.
Is the meter damaged? Does it show an error message?	If yes, contact SD Biosensor, Inc. at +82-31-300-0400.
Is the control result outside the acceptable range(printed on your test strip container)?	Repeat the test. If you get the same results, do not use your meter and test strip until you solve the problem. If you still have problem, call SD Biosensor, Inc. at +82-31-300-0400.

Control solution display

## CHAPTER 3 : Testing Your Blood Sugar

### 1. Getting a Drop of Blood

- 1) Wash your hands in warm, soapy water. Rinse well and dry completely. Warming fingers can increase blood flow.
- 2) Turn the lancet insert cap counterclockwise to remove it, insert the lancet into the lancing device holder and push down firmly until it is fully seated. Twist the lancet protective disk until it separates from the lancet.

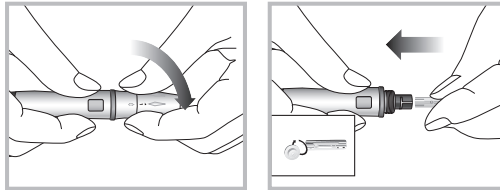

- 3) Replace the cap and turn it clockwise, until it is snug. Adjust the puncture depth setting by turning the comfort dial. The dial has 1 to 5 steps, and the higher the step number, the stronger the blood sampling pressure on the puncture site. The comfort tip offers 5 different levels of skin penetration.
  - 1-2 : for soft or thin skin
  - 3 : for average skin
  - 4-5 : for thick or callused skin