

# TEST REPORT

Report No.: BCTC2308109656-1E

---

Applicant: CHINA DRAGON TECHNOLOGY LIMITED

---

Product Name: WiFi 11a/b/g/n/ac 2T2R and BT5.0 Module

---

Model/Type reference: EL.RT8822VB-WFT

---

Tested Date: 2023-07-31 to 2023-08-23

---

Issued Date: 2023-08-23

---

**Shenzhen BCTC Testing Co., Ltd.**



# FCC ID: ROW-RT8822VBWFT

Product Name: WiFi 11a/b/g/n/ac 2T2R and BT5.0 Module  
Trademark: N/A  
Model/Type Reference: EL.RT8822VB-WFT  
Prepared For: CHINA DRAGON TECHNOLOGY LIMITED  
Address: B4 Bidg.haosan No.1 Industry Park, Shajing street, B, Shenzhen, China  
Manufacturer: CHINA DRAGON TECHNOLOGY LIMITED  
Address: B4 Bidg.haosan No.1 Industry Park, Shajing street, B, Shenzhen, China  
Prepared By: Shenzhen BCTC Testing Co., Ltd.  
Address: 1-2/F., Building B, Pengzhou Industrial Park, No.158, Fuyuan 1st Road, Zhancheng, Fuhai Subdistrict, Bao'an District, Shenzhen, Guangdong, China  
Sample Received Date: 2023-07-31  
Sample tested Date: 2023-07-31 to 2023-08-23  
Issue Date: 2023-08-23  
Report No.: BCTC2308109656-1E  
Test Standards: FCC Part15.247  
ANSI C63.10-2013  
Test Results: PASS  
Remark: This is Bluetooth Classic radio test report.

Tested by:

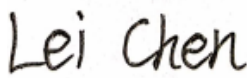

Lei Chen/Project Handler

Approved by:



Zero Zhou/Reviewer

The test report is effective only with both signature and specialized stamp. This result(s) shown in this report refer only to the sample(s) tested. Without written approval of Shenzhen BCTC Testing Co., Ltd, this report can't be reproduced except in full. The tested sample(s) and the sample information are provided by the client.



## Table Of Content

	Page
Test Report Declaration	
1. Version .....	5
2. Test Summary .....	6
3. Measurement Uncertainty .....	7
4. Product Information And Test Setup .....	8
4.1 Product Information.....	8
4.2 Test Setup Configuration .....	8
4.3 Support Equipment .....	9
4.4 Channel List.....	9
4.5 Test Mode .....	10
4.6 Table Of Parameters Of Text Software Setting.....	10
5. Test Facility And Test Instrument Used.....	11
5.1 Test Facility.....	11
5.2 Test Instrument Used.....	11
6. Conducted Emissions.....	13
6.1 Block Diagram Of Test Setup.....	13
6.2 Limit .....	13
6.3 Test procedure.....	13
6.4 EUT operating Conditions .....	13
6.5 Test Result.....	14
7. Radiated emissions .....	16
7.1 Block Diagram Of Test Setup.....	16
7.2 Limit .....	17
7.3 Test procedure.....	18
7.4 EUT operating Conditions .....	19
7.5 Test Result.....	19
8. Radiated Band Emission Measurement And Restricted Bands Of Operation .....	25
8.1 Block Diagram Of Test Setup.....	25
8.2 Limit .....	25
8.3 Test procedure.....	26
8.4 EUT operating Conditions .....	26
8.5 Test Result.....	27
9. Spurious RF Conducted Emissions.....	28
9.1 Block Diagram Of Test Setup.....	28
9.2 Limit .....	28
9.3 Test procedure.....	28
9.4 Test Result.....	29
10. 20 dB Bandwidth .....	50
10.1 Block Diagram Of Test Setup.....	50
10.2 Limit .....	50
10.3 Test procedure.....	50
10.4 Test Result.....	50
11. Maximum Peak Output Power.....	56
11.1 Block Diagram Of Test Setup.....	56
11.2 Limit .....	56

11.3	Test procedure .....	56
11.4	Test Result .....	56
12.	Hopping Channel Separation .....	62
12.1	Block Diagram Of Test Setup.....	62
12.2	Limit .....	62
12.3	Test procedure .....	62
12.4	Test Result.....	62
13.	Number Of Hopping Frequency.....	68
13.1	Block Diagram Of Test Setup.....	68
13.2	Limit .....	68
13.3	Test procedure .....	68
13.4	Test Result.....	68
14.	Dwell Time.....	71
14.1	Block Diagram Of Test Setup.....	71
14.2	Limit .....	71
14.3	Test procedure .....	71
14.4	Test Result.....	71
15.	Antenna Requirement .....	77
15.1	Limit .....	77
15.2	Test Result.....	77
16.	EUT Photographs.....	78
17.	EUT Test Setup Photographs.....	79

(Note: N/A Means Not Applicable)

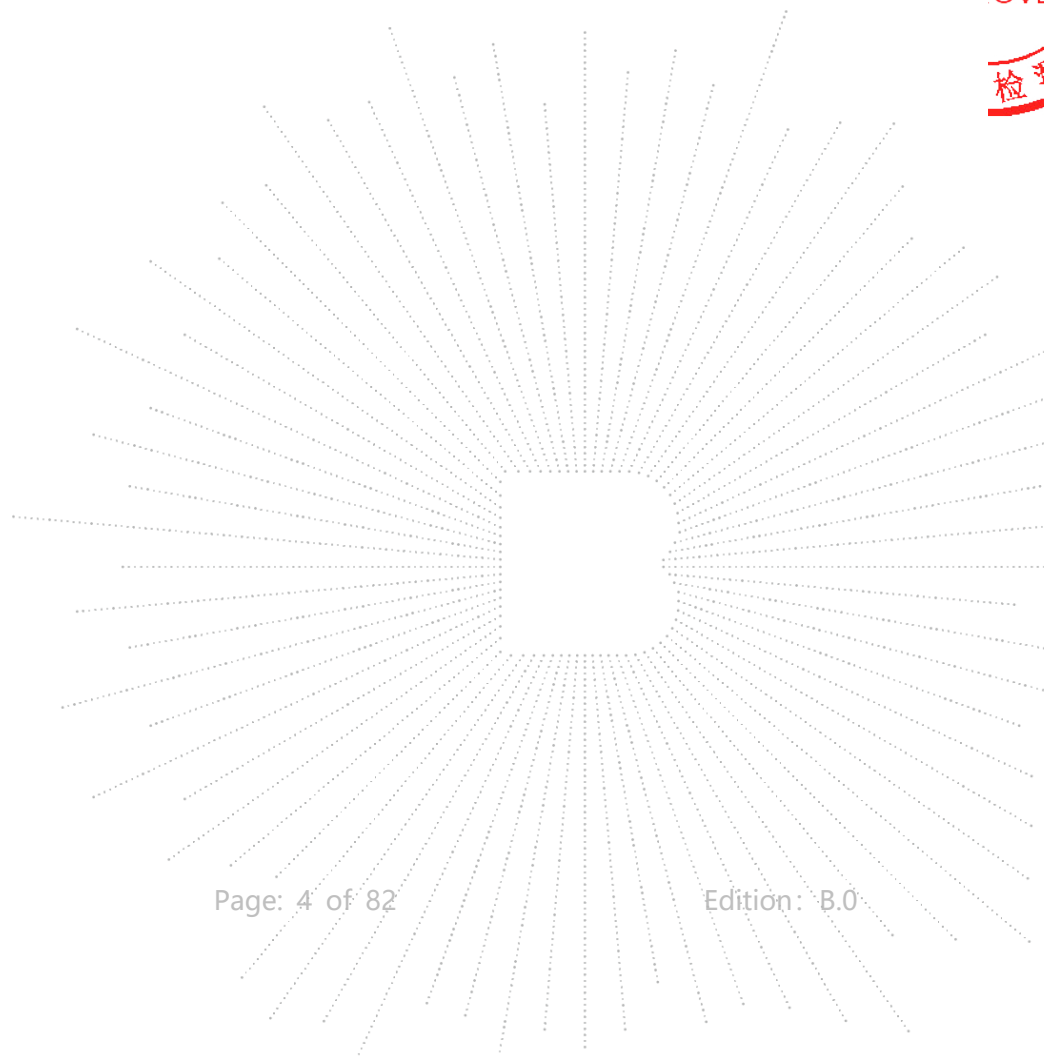

TEST  
 TO  
 OVER  
 検査

**1. Version**

Report No.	Issue Date	Description	Approved
BCTC2308109656-1E	2023-08-23	Original	Valid

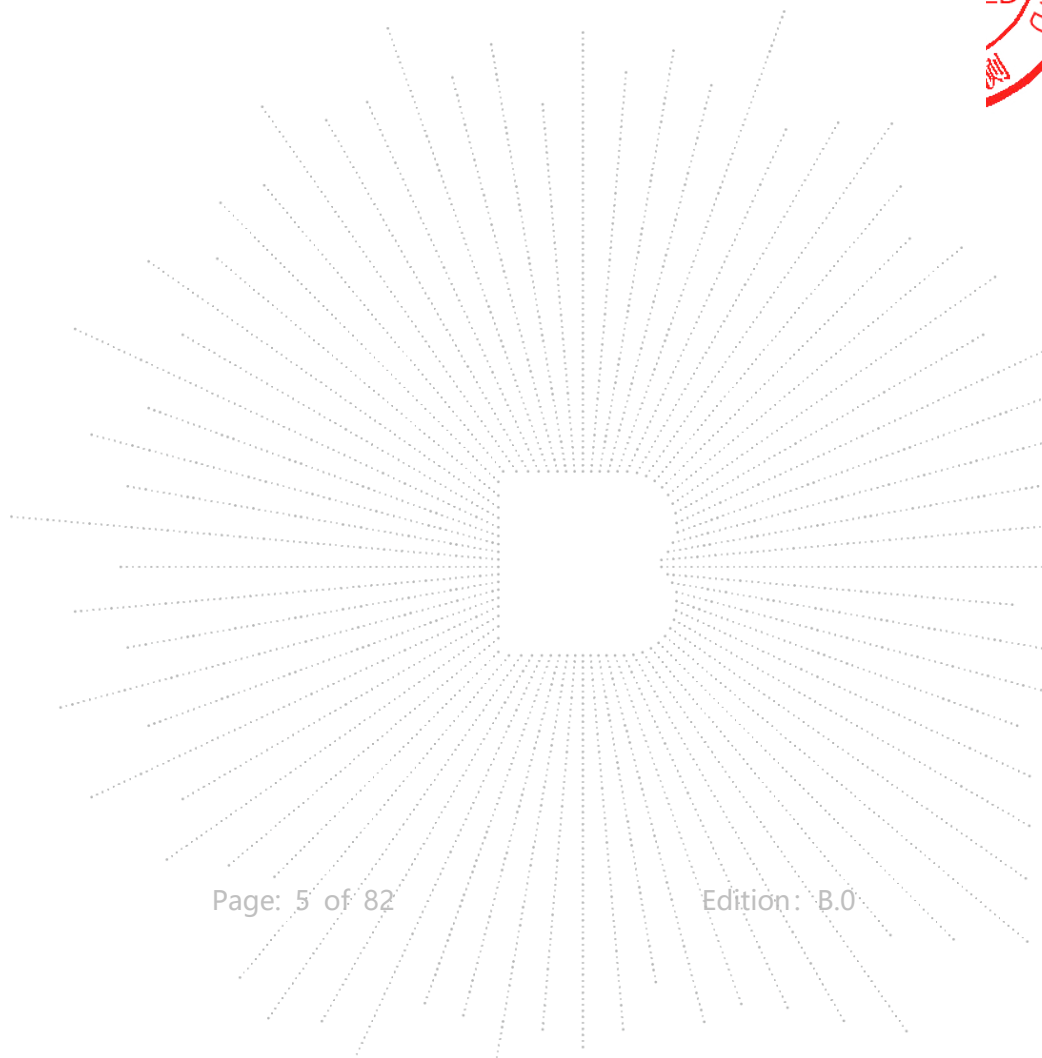

## 2. Test Summary

The Product has been tested according to the following specifications:

No.	Test Parameter	Clause No	Results
1	Conducted emission AC power port	§15.207	PASS
2	Conducted peak output power for FHSS	§15.247(b)(1)	PASS
3	20dB Occupied bandwidth	§15.247(a)(1)	PASS
4	Hopping channel separation	§15.247(a)(1)	PASS
5	Number of hopping frequencies	§15.247(a)(1)(iii)	PASS
6	Dwell Time	§15.247(a)(1)(iii)	PASS
7	Spurious RF conducted emissions	§15.247(d)	PASS
8	Band edge	§15.247(d)	PASS
9	Spurious radiated emissions for transmitter	§15.247(d) & §15.209 & §15.205	PASS
10	Antenna Requirement	15.203	PASS

CO., LTD

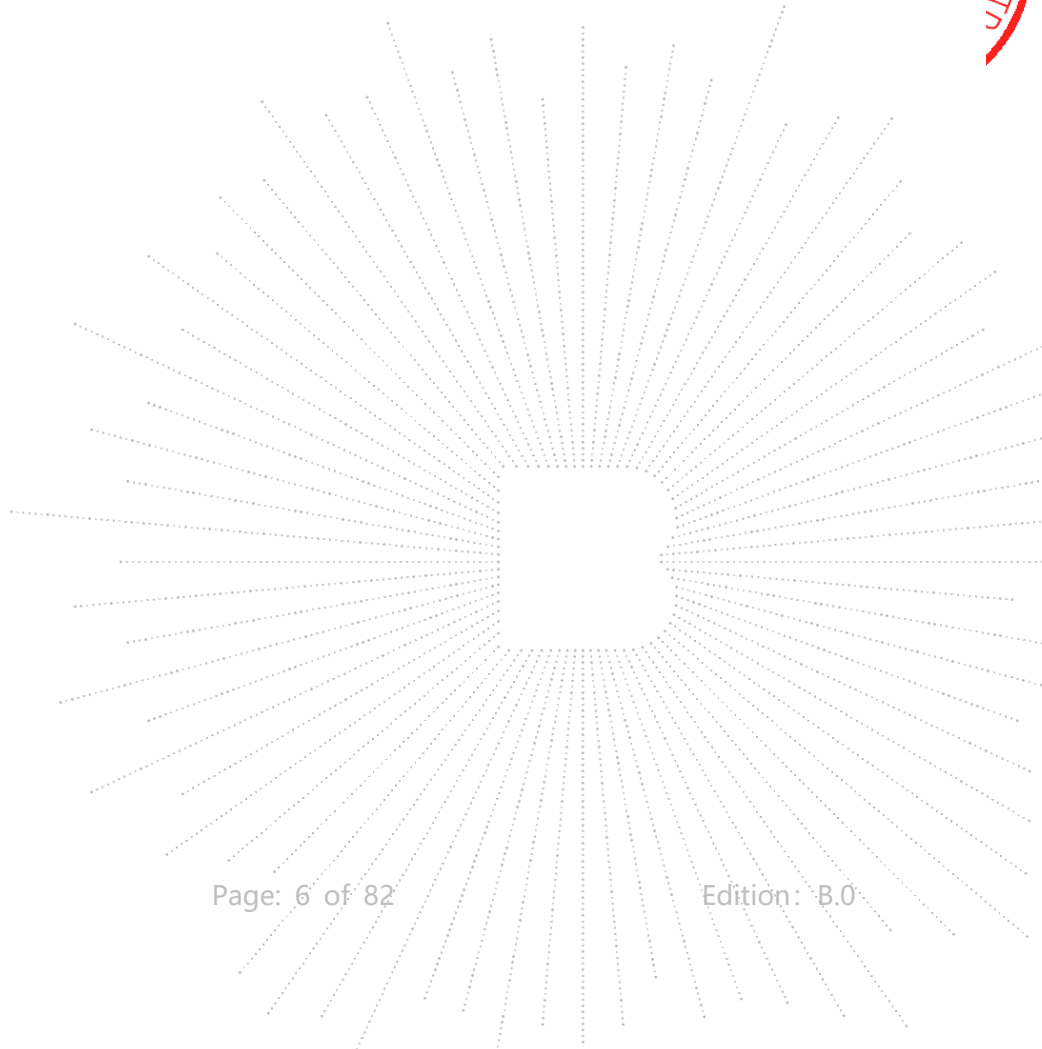

### 3. Measurement Uncertainty

Where relevant, the following measurement uncertainty levels have been estimated for tests performed on the Product as specified in CISPR 16-4-2. This uncertainty represents an expanded uncertainty expressed at approximately the 95% confidence level using a coverage factor of k=2.

No.	Item	Uncertainty
1	3m chamber Radiated spurious emission(30MHz-1GHz)	U=4.3dB
2	3m chamber Radiated spurious emission(9KHz-30MHz)	U=3.7dB
3	3m chamber Radiated spurious emission(1GHz-18GHz)	U=4.5dB
4	3m chamber Radiated spurious emission(18GHz-40GHz)	U=3.34dB
5	Conducted Emission (150kHz-30MHz)	U=3.20dB
6	Conducted Adjacent channel power	U=1.38dB
7	Conducted output power uncertainty Above 1G	U=1.576dB
8	Conducted output power uncertainty below 1G	U=1.28dB
9	humidity uncertainty	U=5.3%
10	Temperature uncertainty	U=0.59°C



## 4. Product Information And Test Setup

### 4.1 Product Information

Model/Type reference:	EL.RT8822VB-WFT
Model differences:	N/A
Bluetooth Version:	5.0
Hardware Version:	EL.RT8822VB-WFT_1V0
Software Version:	RTL8822CU-F9822CU-02_WL(ANT3)20221015.map
Operation Frequency:	2402-2480MHz
Type of Modulation:	GFSK, $\pi/4$ DQPSK, 8DPSK
Number Of Channel	79CH
Antenna installation:	Shrapnel antenna
Antenna Gain:	-0.5 dBi
Ratings:	DC 3.3V

### 4.2 Test Setup Configuration

See test photographs attached in *EUT TEST SETUP PHOTOGRAPHS* for the actual connections between Product and support equipment.

Conducted Emission:

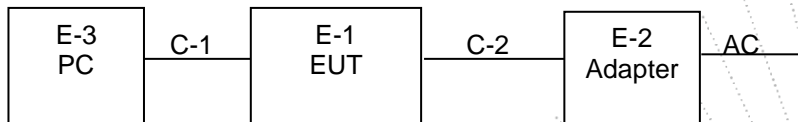

Radiated Spurious Emission

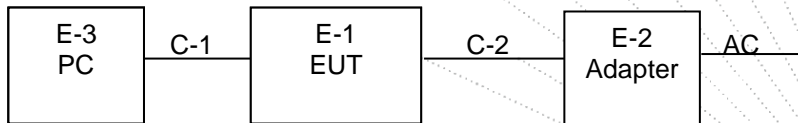



### 4.3 Support Equipment

No.	Device Type	Brand	Model	Series No.	Note
E-1	WiFi 11a/b/g/n/ac 2T2R and BT5.0 Module	N/A	EL.RT8822VB-W FT	N/A	EUT
E-2	Adapter	N/A	CD122	N/A	Auxiliary
E-3	PC	Lenovo	Thinkpad S2	N/A	Auxiliary

Item	Shielded Type	Ferrite Core	Length	Note
C-1	NO	NO	0.5M	USB cable unshielded
C-2	NO	NO	0.5M	DC cable unshielded

Notes:

1. All the equipment/cables were placed in the worst-case configuration to maximize the emission during the test.
2. Grounding was established in accordance with the manufacturer's requirements and conditions for the intended use.

### 4.4 Channel List

CH	Frequency (MHz)	CH	Frequency (MHz)	CH	Frequency (MHz)	CH	Frequency (MHz)
0	2402	1	2403	2	2404	3	2405
4	2406	5	2407	6	2408	7	2409
8	2410	9	2411	10	2412	11	2413
12	2414	13	2415	14	2416	15	2417
16	2418	17	2419	18	2420	19	2421
20	2422	21	2423	22	2424	23	2425
24	2426	25	2427	26	2428	27	2429
28	2430	29	2431	30	2432	31	2433
32	2434	33	2435	34	2436	35	2437
36	2438	37	2439	38	2440	39	2441
40	2442	41	2443	42	2444	43	2445
44	2446	45	2447	46	2448	47	2449
48	2450	49	2451	50	2452	51	2453
52	2454	53	2455	54	2456	55	2457
56	2458	57	2459	58	2460	59	2461
60	2462	61	2463	62	2464	63	2465
64	2466	65	2467	66	2468	67	2469
68	2470	69	2471	70	2472	71	2473
72	2474	73	2475	74	2476	75	2477
76	2478	77	2479	78	2480	79	/

#### 4.5 Test Mode

To investigate the maximum EMI emission characteristics generates from EUT, the test system was pre-scanning tested base on the consideration of following EUT operation mode or test configuration mode which possible have effect on EMI emission level. Each of these EUT operation mode(s) or test configuration mode(s) mentioned above was evaluated respectively.

Test Mode	Test mode	Low channel	Middle channel	High channel
1	Transmitting(GFSK)	2402MHz	2441MHz	2480MHz
2	Transmitting( $\pi/4$ DQPSK)	2402MHz	2441MHz	2480MHz
3	Transmitting(8DPSK)	2402MHz	2441MHz	2480MHz
4	Link mode (Conducted emission and Radiated emission)			

Note:

- (1) The measurements are performed at the highest, middle, lowest available channels.
- (2) Fully-charged battery is used during the test

#### 4.6 Table Of Parameters Of Text Software Setting

During testing channel & power controlling software provided by the customer was used to control the operating channel as well as the output power level. The RF output power selection is for the setting of RF output power expected by the customer and is going to be fixed on the firmware of the final end product power parameters

Test software Version	MP_Kit_RTL11ac_8822CU_USB_v13.00		
Frequency	2402 MHz	2441 MHz	2480 MHz
Parameters	DEF	DEF	DEF

## 5. Test Facility And Test Instrument Used

### 5.1 Test Facility

All measurement facilities used to collect the measurement data are located at Shenzhen BCTC Testing Co., Ltd. Address: 1-2/F., Building B, Pengzhou Industrial Park, No.158, Fuyuan 1st Road, Zhancheng, Fuhai Subdistrict, Bao'an District, Shenzhen, Guangdong, China. The site and apparatus are constructed in conformance with the requirements of ANSI C63.4 and CISPR 16-1-1 other equivalent standards.

FCC Test Firm Registration Number: 712850

A2LA certificate registration number is: CN1212

ISED Registered No.: 23583

ISED CAB identifier: CN0017

### 5.2 Test Instrument Used

Conducted Emissions Test					
Equipment	Manufacturer	Model#	Serial#	Last Cal.	Next Cal.
Receiver	R&S	ESR3	102075	May 15, 2023	May 14, 2024
LISN	R&S	ENV216	101375	May 15, 2023	May 14, 2024
Software	Frad	EZ-EMC	EMC-CON 3A1	\	\
Attenuator	\	10dB DC-6GHz	1650	May 15, 2023	May 14, 2024

RF Conducted Test					
Equipment	Manufacturer	Model#	Serial#	Last Cal.	Next Cal.
Power Meter	Keysight	E4419	\	May 15, 2023	May 14, 2024
Power Sensor (AV)	Keysight	E9300A	\	May 15, 2023	May 14, 2024
Signal Analyzer20kHz-26.5GHz	Keysight	N9020A	MY49100060	May 15, 2023	May 14, 2024
Spectrum Analyzer9kHz-40GHz	R&S	FSP40	100363	May 15, 2023	May 14, 2024
Radio frequency control box	MAIWEI	MW100-RFC B	\	\	\
Software	MAIWEI	MTS 8310	\	\	\

Radiated Emissions Test (966 Chamber01)					
Equipment	Manufacturer	Model#	Serial#	Last Cal.	Next Cal.
966 chamber	ChengYu	966 Room	966	May 15, 2023	May 14, 2026
Receiver	R&S	ESR3	102075	May 15, 2023	May 14, 2024
Receiver	R&S	ESRP	101154	May 15, 2023	May 14, 2024
Amplifier	Schwarzbeck	BBV9744	9744-0037	May 15, 2023	May 14, 2024
TRILOG Broadband Antenna	Schwarzbeck	VULB9163	942	May 29, 2023	May 28, 2024
Loop Antenna(9KHz-30MHz)	Schwarzbeck	FMZB1519B	00014	May 31, 2023	May 30, 2024
Amplifier	SKET	LAPA_01G18 G-45dB	\	May 15, 2023	May 14, 2024
Horn Antenna	Schwarzbeck	BBHA9120D	1541	May 31, 2023	May 30, 2024
Amplifier(18G Hz-40GHz)	MITEQ	TTA1840-35-HG	2034381	May 15, 2023	May 14, 2024
Horn Antenna(18G Hz-40GHz)	Schwarzbeck	BBHA9170	00822	May 31, 2023	May 30, 2024
Spectrum Analyzer9kHz-40GHz	R&S	FSP40	100363	May 15, 2023	May 14, 2024
Software	Frad	EZ-EMC	FA-03A2 RE	\	\

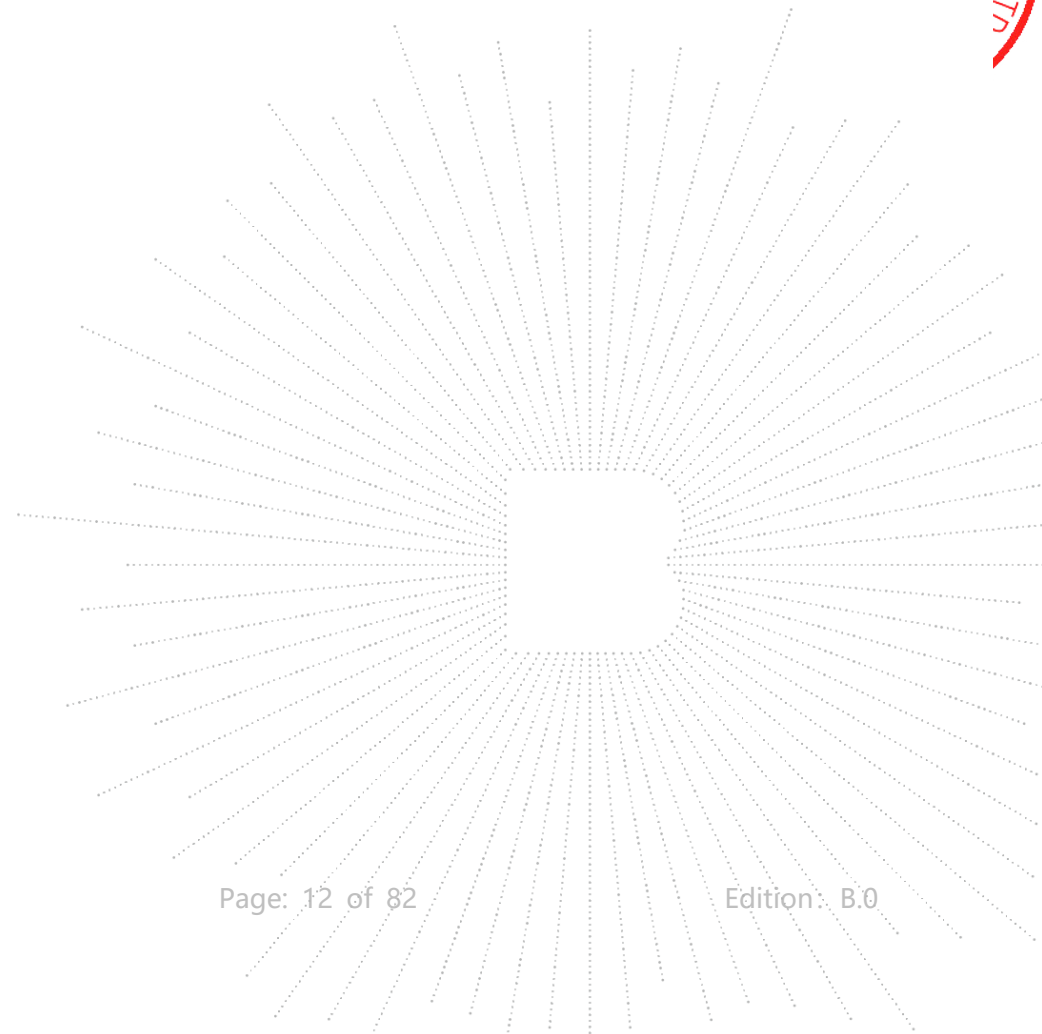
## 6. Conducted Emissions

### 6.1 Block Diagram Of Test Setup

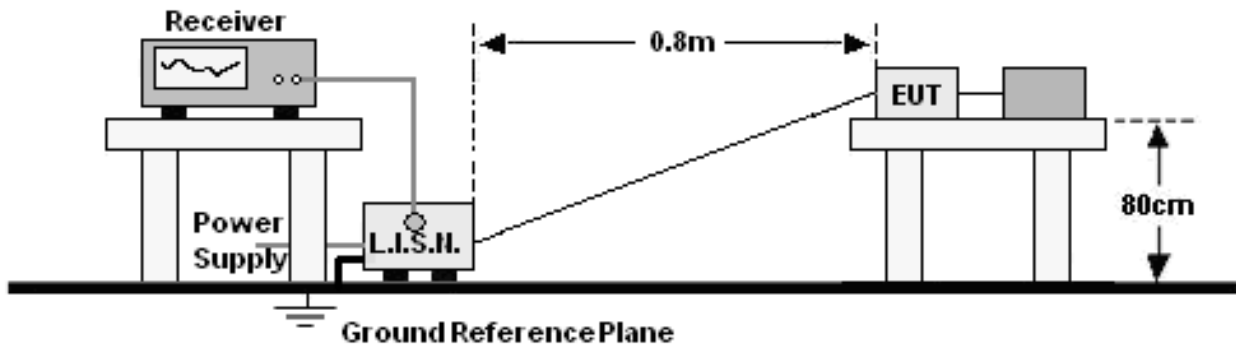

### 6.2 Limit

Frequency (MHz)	Limit (dBuV)	
	Quas-peak	Average
0.15 -0.5	66 - 56 *	56 - 46 *
0.50 -5.0	56.00	46.00
5.0 -30.0	60.00	50.00

Notes:

- \*Decreasing linearly with logarithm of frequency.
- The lower limit shall apply at the transition frequencies.

### 6.3 Test procedure

Receiver Parameters	Setting
Attenuation	10 dB
Start Frequency	0.15 MHz
Stop Frequency	30 MHz
IF Bandwidth	9 kHz

- The Product was placed on a nonconductive table 0.8 m above the horizontal ground reference plane, and 0.4 m from the vertical ground reference plane, and connected to the main through Line Impedance Stability Network (L.I.S.N).
- The RBW of the receiver was set at 9 kHz in 150 kHz ~ 30MHz with Peak and AVG detector in Max Hold mode. Run the receiver's pre-scan to record the maximum disturbance generated from Product in all power lines in the full band.
- For each frequency whose maximum record was higher or close to limit, measure its QP and AVG values and record.

### 6.4 EUT operating Conditions

The EUT was configured for testing in a typical fashion (as a customer would normally use it). The EUT has been programmed to continuously transmit during test. This operating condition was tested and used to collect the included data.

**6.5 Test Result**

Temperature:	26 °C	Relative Humidity:	54%
Pressure:	101KPa	Phase :	L
Test Mode:	Mode 4	Test Voltage :	AC120V/60Hz

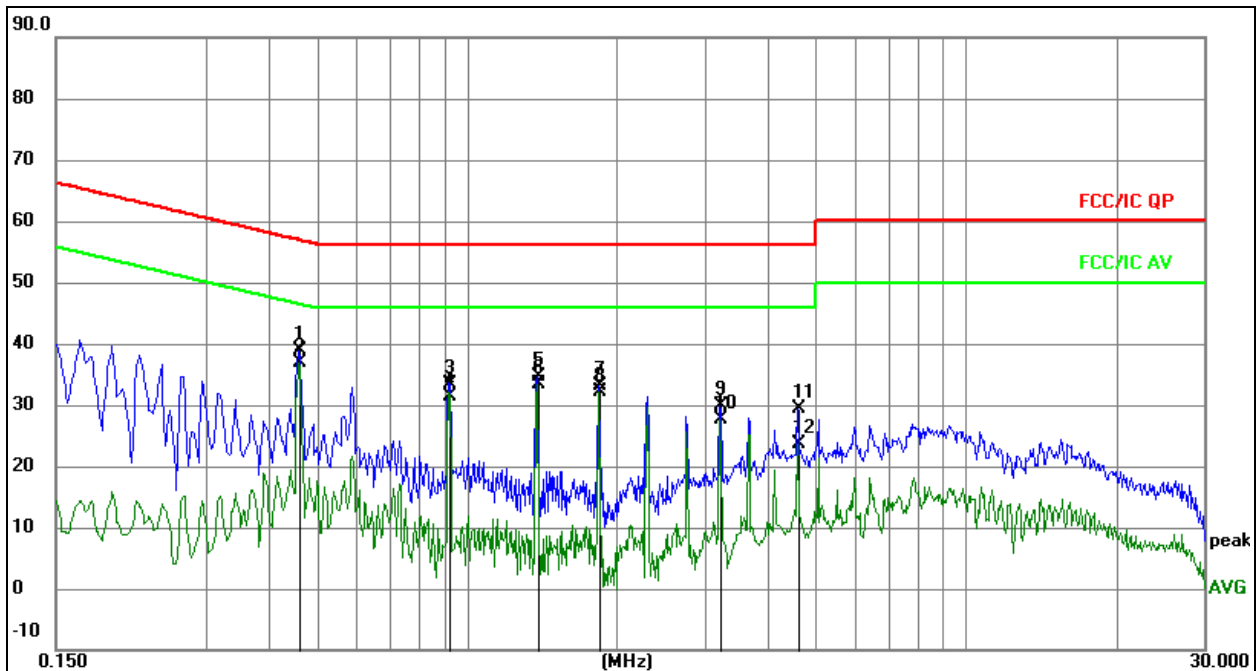
**Remark:**

1. All readings are Quasi-Peak and Average values.
2. Factor = Insertion Loss + Cable Loss.
3. Measurement = Reading Level + Correct Factor
4. Over = Measurement - Limit

No.	Mk.	Freq. MHz	Reading Level	Correct Factor dB	Measure- ment dBuV	Limit dBuV	Over dB	Detector
1		0.4605	29.15	9.62	38.77	56.68	-17.91	QP
2	*	0.4605	27.21	9.62	36.83	46.68	-9.85	AVG
3		0.9195	23.80	9.70	33.50	56.00	-22.50	QP
4		0.9195	21.59	9.70	31.29	46.00	-14.71	AVG
5		1.3829	24.86	9.73	34.59	56.00	-21.41	QP
6		1.3829	23.61	9.73	33.34	46.00	-12.66	AVG
7		1.8420	23.28	9.73	33.01	56.00	-22.99	QP
8		1.8420	22.44	9.73	32.17	46.00	-13.83	AVG
9		3.2235	20.19	9.80	29.99	56.00	-26.01	QP
10		3.2235	17.93	9.80	27.73	46.00	-18.27	AVG
11		4.6050	19.46	9.82	29.28	56.00	-26.72	QP
12		4.6050	13.70	9.82	23.52	46.00	-22.48	AVG

Temperature:	26 °C	Relative Humidity:	54%
Pressure:	101KPa	Phase :	N
Test Mode:	Mode 4	Test Voltage :	AC120V/60Hz

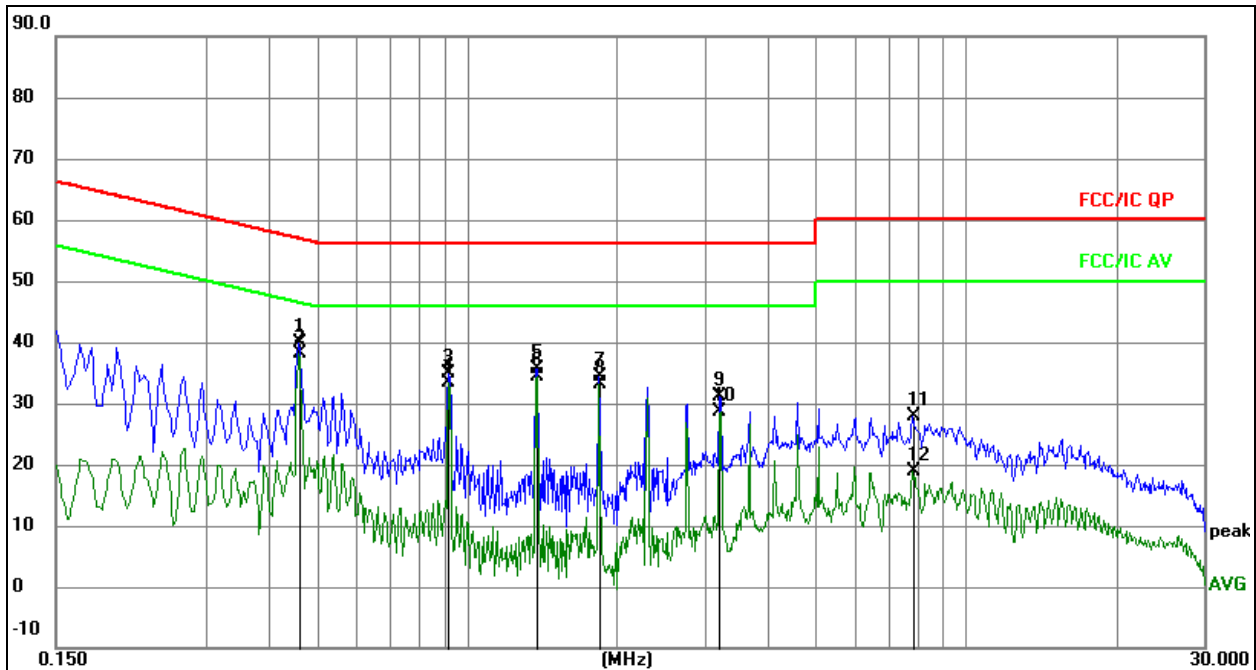
**Remark:**

1. All readings are Quasi-Peak and Average values.
2. Factor = Insertion Loss + Cable Loss.
3. Measurement = Reading Level + Correct Factor
4. Over = Measurement - Limit

No.	Mk.	Freq. MHz	Reading Level	Correct Factor dB	Measure- ment dBuV	Limit dBuV	Over dB	Detector
1		0.4588	30.23	9.62	39.85	56.71	-16.86	QP
2	*	0.4588	28.45	9.62	38.07	46.71	-8.64	AVG
3		0.9184	25.23	9.70	34.93	56.00	-21.07	QP
4		0.9184	23.75	9.70	33.45	46.00	-12.55	AVG
5		1.3810	25.94	9.73	35.67	56.00	-20.33	QP
6		1.3810	24.53	9.73	34.26	46.00	-11.74	AVG
7		1.8386	24.65	9.73	34.38	56.00	-21.62	QP
8		1.8386	23.45	9.73	33.18	46.00	-12.82	AVG
9		3.2069	21.25	9.80	31.05	56.00	-24.95	QP
10		3.2069	18.94	9.80	28.74	46.00	-17.26	AVG
11		7.8102	18.23	9.72	27.95	60.00	-32.05	QP
12		7.8102	9.09	9.72	18.81	50.00	-31.19	AVG



## 7. Radiated emissions

### 7.1 Block Diagram Of Test Setup

(A) Radiated Emission Test-Up Frequency Below 30MHz

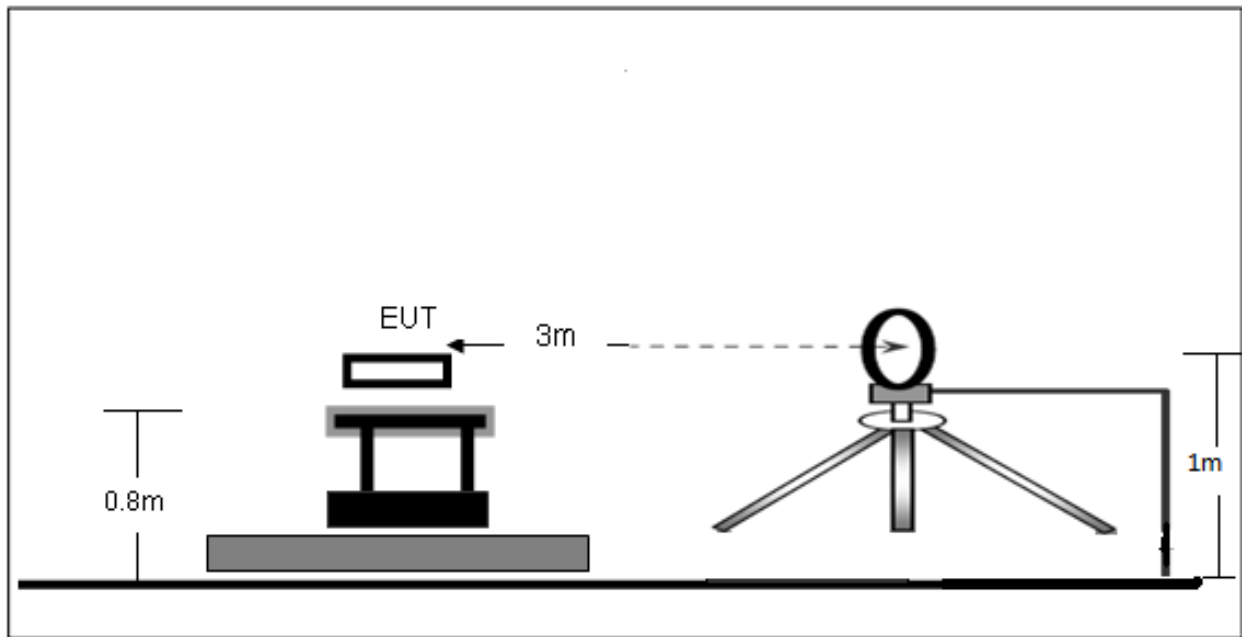

(B) Radiated Emission Test-Up Frequency 30MHz~1GHz

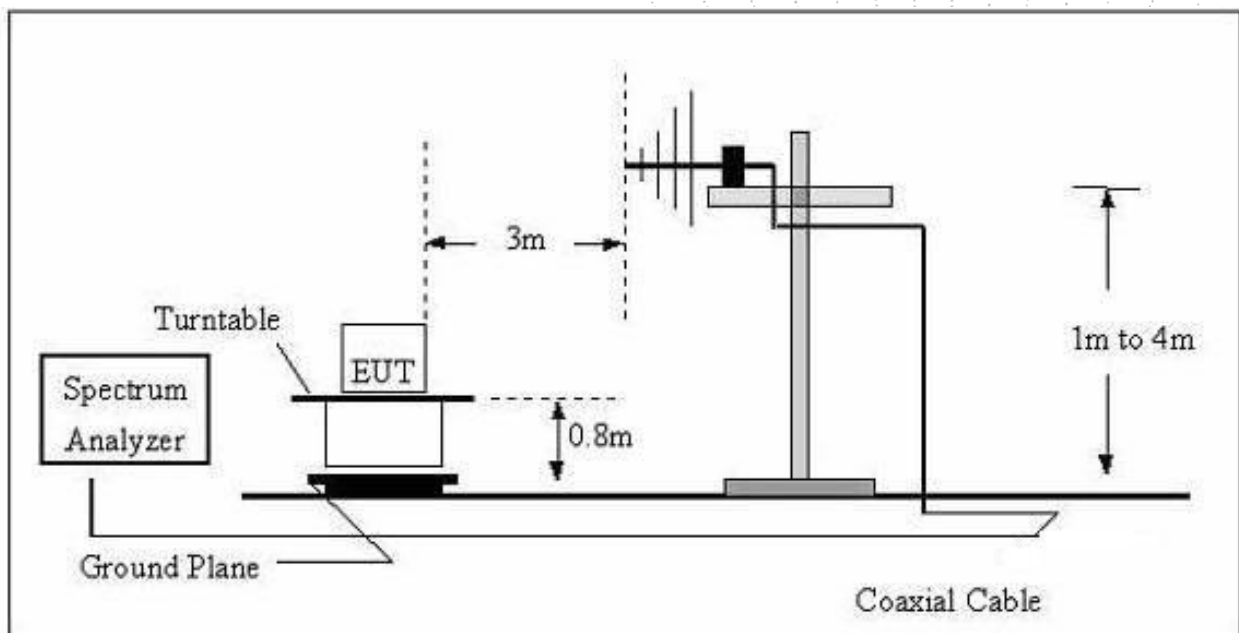



## (C) Radiated Emission Test-Up Frequency Above 1GHz

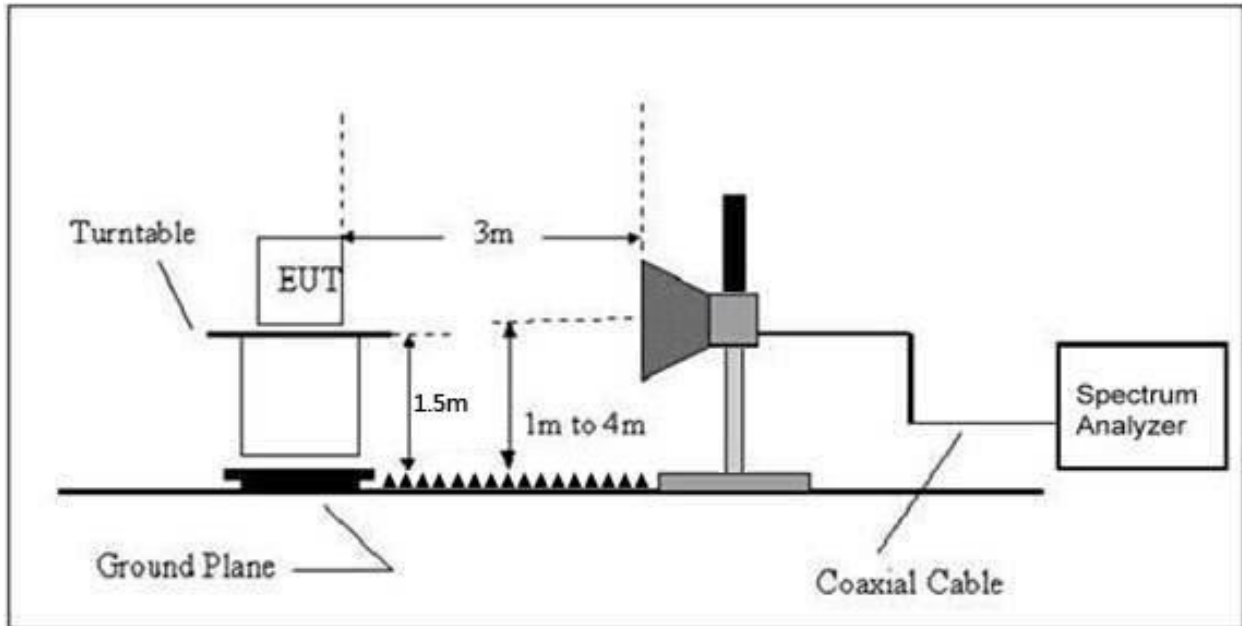

## 7.2 Limit

20dBc in any 100 kHz bandwidth outside the operating frequency band. In case the emission fall within the restricted band specified on 15.205(a), then the 15.209(a) limit in the table below has to be followed.

Frequency (MHz)	Field Strength uV/m	Distance (m)	Field Strength Limit at 3m Distance	
			uV/m	dBuV/m
0.009 ~ 0.490	$2400/F(\text{kHz})$	300	$10000 * 2400/F(\text{kHz})$	$20\log^{(2400/F(\text{kHz}))} + 80$
0.490 ~ 1.705	$24000/F(\text{kHz})$	30	$100 * 24000/F(\text{kHz})$	$20\log^{(24000/F(\text{kHz}))} + 40$
1.705 ~ 30	30	30	$100 * 30$	$20\log^{(30)} + 40$
30 ~ 88	100	3	100	$20\log^{(100)}$
88 ~ 216	150	3	150	$20\log^{(150)}$
216 ~ 960	200	3	200	$20\log^{(200)}$
Above 960	500	3	500	$20\log^{(500)}$

## Limits Of Radiated Emission Measurement (Above 1000MHz)

Frequency (MHz)	Limit (dBuV/m) (at 3M)	
	Peak	Average
Above 1000	74	54

## Notes:

- (1)The limit for radiated test was performed according to FCC PART 15C
- (2)The tighter limit applies at the band edges.
- (3) Emission level (dBuV/m)=20log Emission level (uV/m).

**Frequency Range Of Radiated Measurement**

(a) For an intentional radiator the spectrum shall be investigated from the lowest radio frequency signal generated in the device, without going below 9 kHz, up to at least the frequency shown in this paragraph:

- (1) If the intentional radiator operates below 10 GHz: to the tenth harmonic of the highest fundamental frequency or to 40 GHz, whichever is lower.
- (2) If the intentional radiator operates at or above 10 GHz and below 30 GHz: to the fifth harmonic of the highest fundamental frequency or to 100 GHz, whichever is lower.
- (3) If the intentional radiator operates at or above 30 GHz: to the fifth harmonic of the highest fundamental frequency or to 200 GHz, whichever is lower, unless specified otherwise elsewhere in the rules.
- (4) If the intentional radiator operates at or above 95 GHz: To the third harmonic of the highest fundamental frequency or to 750 GHz, whichever is lower, unless specified otherwise elsewhere in the rules.
- (5) If the intentional radiator contains a digital device, regardless of whether this digital device controls the functions of the intentional radiator or the digital device is used for additional control or function purposes other than to enable the operation of the intentional radiator, the frequency range shall be investigated up to the range specified in paragraphs (a) (1)through (4) of this section or the range applicable to the digital device, as shown in paragraph (b)(1) of this section, whichever is the higher frequency range of investigation.

**7.3 Test procedure**

Receiver Parameter	Setting
Attenuation	Auto
9kHz~150kHz	RBW 200Hz for QP
150kHz~30MHz	RBW 9kHz for QP
30MHz~1000MHz	RBW 120kHz for QP

Spectrum Parameter	Setting
1-25GHz	RBW 1 MHz /VBW 1 MHz for Peak, RBW 1 MHz / VBW 10Hz for Average

Below 1GHz test procedure as below:

- a. The EUT was placed on the top of a rotating table 0.8 meters above the ground at a 3 meter semi-anechoic chamber. The table was rotated 360 degrees to determine the position of the highest radiation.
- b. The EUT was set 3 meters away from the interference-receiving antenna, which was mounted on the top of a variable-height antenna tower.
- c. The antenna height is varied from one meter to four meters above the ground to determine the maximum value of the field strength. Both horizontal and vertical polarizations of the antenna are set to make the measurement.
- d. For each suspected emission, the EUT was arranged to its worst case and then the antenna was tuned to heights from 1 meter to 4 meters (for the test frequency of below 30MHz, the antenna was tuned to heights 1 meter) and the rotatable table was turned from 0 degrees to 360 degrees to find the maximum reading.
- e. The test-receiver system was set to Peak Detect Function and Specified Bandwidth with Maximum Hold Mode.
- f. If the emission level of the EUT in peak mode was 10dB lower than the limit specified, then testing could be stopped and the peak values of the EUT would be reported. Otherwise the emissions that did not have 10dB margin would be re-tested one by one using peak, quasi-peak or average method as specified and then reported in a data sheet.

Above 1GHz test procedure as below:

- a.The EUT was placed on the top of a rotating table 1.5 meters above the ground at a 3 meter camber. The table was rotated 360 degrees to determine the position of the highest radiation.
- b.The EUT was set 3 meters away from the interference-receiving antenna, which was mounted on the top of a variable-height antenna tower.
- c.The antenna height is varied from one meter to four meters above the ground to determine the maximum value of the field strength. Both horizontal and vertical polarizations of the antenna are set to make the measurement.
- d.For each suspected emission, the EUT was arranged to its worst case and then the antenna was tuned to heights from 1 meter to 4 meters and the rota table was turned from 0 degrees to 360 degrees to find the maximum reading.
- e.The test-receiver system was set to Peak Detect Function and Specified Bandwidth with Maximum Hold Mode.
- f. If the emission level of the EUT in peak mode was 10dB lower than the limit specified, then testing could be stopped and the peak values of the EUT would be reported. Otherwise the emissions that did not have 10dB margin would be re-tested one by one using peak, quasi-peak or average method as specified and then reported in a data sheet.
- g. Test the EUT in the lowest channel, the middlest channel, the Highest channel.

Note:

Both horizontal and vertical antenna polarities were tested and performed pretest to three orthogonal axis. The worst case emissions were reported.

## 7.4 EUT operating Conditions

The EUT was configured for testing in a typical fashion (as a customer would normally use it). The EUT has been programmed to continuously transmit during test. This operating condition was tested and used to collect the included data.

## 7.5 Test Result

Below 30MHz

Temperature:	26 °C	Relative Humidity:	54%
Pressure:	101KPa	Test Voltage :	AC120V/60Hz
Test Mode:	Mode 4	Polarization :	--

Freq.	Reading	Limit	Margin	State
(MHz)	(dBuV/m)	(dBuV/m)	(dB)	P/F
--	--	--	--	PASS
--	--	--	--	PASS

Note:

The amplitude of spurious emissions which are attenuated by more than 20dB below the permissible value has no need to be reported.

Distance extrapolation factor = $40 \log(\text{specific distance/test distance})(\text{dB})$ ;

Limit line = specific limits(dBuv) + distance extrapolation factor.

Between 30MHz – 1GHz

Temperature:	26 °C	Relative Humidity:	54%
Pressure:	101KPa	Phase :	Horizontal
Test Mode:	Mode 4	Test Voltage :	AC120V/60Hz

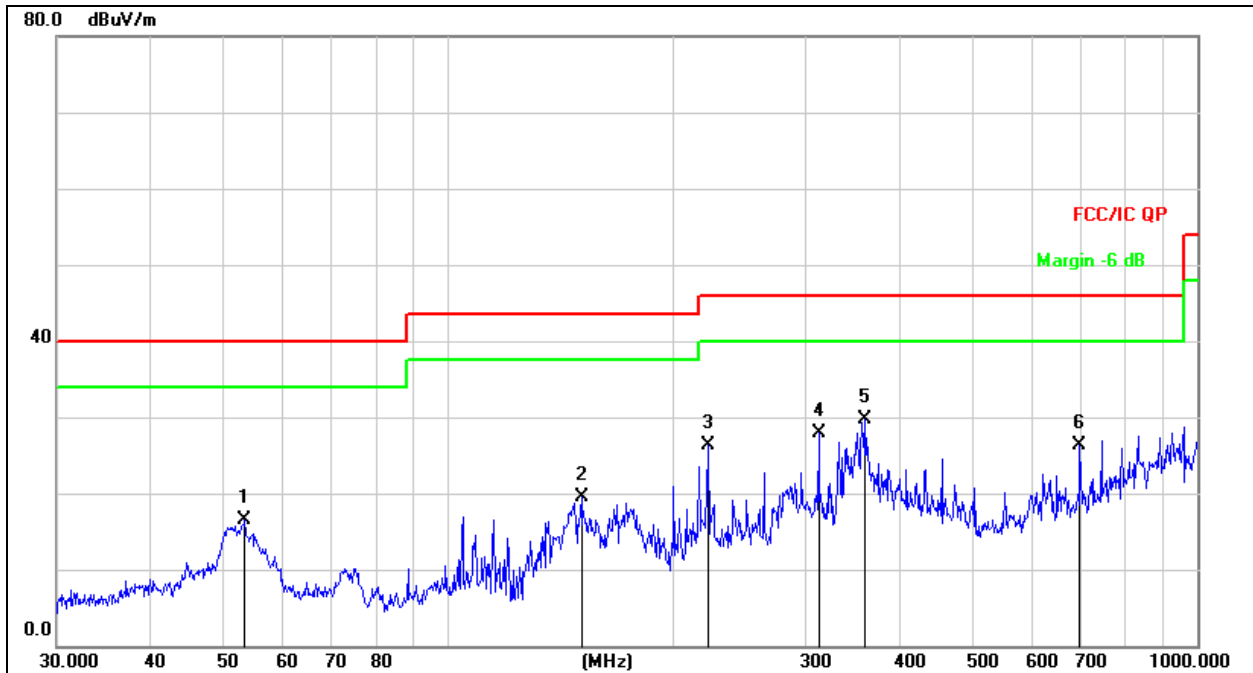

Remark:

- Factor = Antenna Factor + Cable Loss – Pre-amplifier.
- Measurement = Reading Level + Correct Factor
- Over = Measurement - Limit

No.	Mk.	Freq. MHz	Reading Level dBuV	Correct Factor dB	Measure- ment dBuV/m	Limit dB/m	Over dB	Detector
1		53.5052	32.53	-16.12	16.41	40.00	-23.59	QP
2		150.5378	40.56	-21.01	19.55	43.50	-23.95	QP
3		222.1698	42.96	-16.69	26.27	46.00	-19.73	QP
4		312.1794	41.98	-14.14	27.84	46.00	-18.16	QP
5	*	360.4476	42.41	-12.67	29.74	46.00	-16.26	QP
6		696.8567	33.51	-7.22	26.29	46.00	-19.71	QP

Temperature:	26 °C	Relative Humidity:	54%
Pressure:	101KPa	Phase :	Vertical
Test Mode:	Mode 4	Test Voltage :	AC120V/60Hz

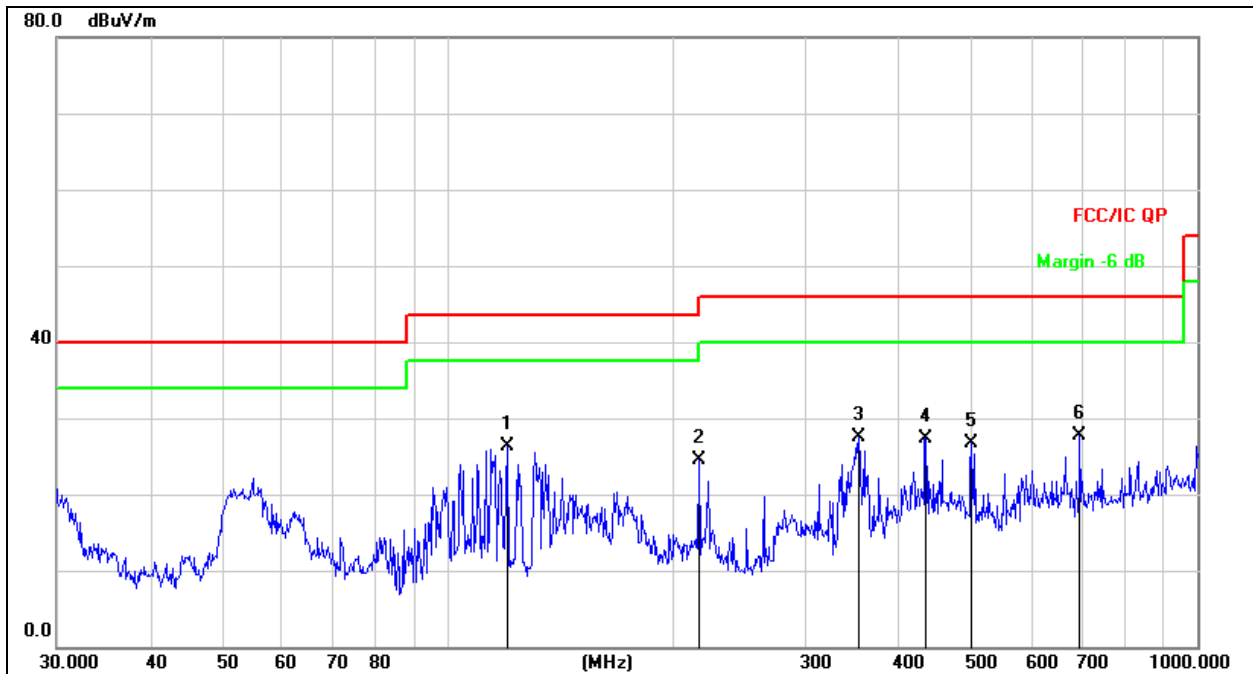

Remark:  
 1. Factor = Antenna Factor + Cable Loss – Pre-amplifier.  
 2. Measurement = Reading Level + Correct Factor  
 3. Over = Measurement - Limit

No.	Mk.	Freq. MHz	Reading Level dBuV	Correct Factor dB	Measure- ment dBuV/m	Limit dB/m	Over dB	Detector
1	*	119.8556	45.28	-19.07	26.21	43.50	-17.29	QP
2		216.0240	41.38	-16.88	24.50	46.00	-21.50	QP
3		352.9433	40.29	-12.76	27.53	46.00	-18.47	QP
4		434.0651	39.01	-11.72	27.29	46.00	-18.71	QP
5		499.4247	36.89	-10.26	26.63	46.00	-19.37	QP
6		696.8567	34.96	-7.22	27.74	46.00	-18.26	QP

Between 1GHz – 25GHz

.Polar (H/V)	Frequency	Reading Level	Correct Factor	Measure- ment	Limits	Over	Detector Type
	(MHz)	(dBuV/m)	(dB)	(dBuV/m)	(dBuV/ m)	(dB)	
GFSK Low channel							
V	4804.00	68.61	-19.99	48.62	74.00	-25.38	PK
V	4804.00	58.12	-19.99	38.13	54.00	-15.87	AV
V	7206.00	59.86	-14.22	45.64	74.00	-28.36	PK
V	7206.00	50.84	-14.22	36.62	54.00	-17.38	AV
H	4804.00	64.37	-19.99	44.38	74.00	-29.62	PK
H	4804.00	54.15	-19.99	34.16	54.00	-19.84	AV
H	7206.00	58.70	-14.22	44.48	74.00	-29.52	PK
H	7206.00	50.42	-14.22	36.20	54.00	-17.80	AV
GFSK Middle channel							
V	4882.00	67.38	-19.84	47.54	74.00	-26.46	PK
V	4882.00	59.56	-19.84	39.72	54.00	-14.28	AV
V	7323.00	57.05	-13.90	43.15	74.00	-30.85	PK
V	7323.00	47.28	-13.90	33.38	54.00	-20.62	AV
H	4882.00	63.34	-19.84	43.50	74.00	-30.50	PK
H	4882.00	52.88	-19.84	33.04	54.00	-20.96	AV
H	7323.00	55.21	-13.90	41.31	74.00	-32.69	PK
H	7323.00	47.98	-13.90	34.08	54.00	-19.92	AV
GFSK High channel							
V	4960.00	69.04	-19.68	49.36	74.00	-24.64	PK
V	4960.00	60.38	-19.68	40.70	54.00	-13.30	AV
V	7440.00	60.91	-13.57	47.34	74.00	-26.66	PK
V	7440.00	50.47	-13.57	36.90	54.00	-17.10	AV
H	4960.00	67.29	-19.68	47.61	74.00	-26.39	PK
H	4960.00	57.68	-19.68	38.00	54.00	-16.00	AV
H	7440.00	58.21	-13.57	44.64	74.00	-29.36	PK
H	7440.00	50.56	-13.57	36.99	54.00	-17.01	AV

Remark:

1.Emission Level = Meter Reading + Factor,

Factor = Antenna Factor + Cable Loss – Pre-amplifier.

Over= Emission Level - Limit

2.If peak below the average limit, the average emission was no test.

3. In restricted bands of operation, The spurious emissions below the permissible value more than 20dB

4. The amplitude of spurious emissions which are attenuated by more than 20dB below the permissible value has no need to be reported.



Polar (H/V)	Frequency	Reading Level	Correct Factor	Measurement	Limits	Over	Detector Type
	(MHz)	(dBuV/m)	(dB)	(dBuV/m)	(dBuV/m)	(dB)	
$\pi$ /4DQPSK Low channel							
V	4804.00	70.03	-19.99	50.04	74.00	-23.96	PK
V	4804.00	59.88	-19.99	39.89	54.00	-14.11	AV
V	7206.00	61.64	-14.22	47.42	74.00	-26.58	PK
V	7206.00	51.44	-14.22	37.22	54.00	-16.78	AV
H	4804.00	65.41	-19.99	45.42	74.00	-28.58	PK
H	4804.00	56.17	-19.99	36.18	54.00	-17.82	AV
H	7206.00	58.85	-14.22	44.63	74.00	-29.37	PK
H	7206.00	50.97	-14.22	36.75	54.00	-17.25	AV
$\pi$ /4DQPSK Middle channel							
V	4882.00	68.77	-19.84	48.93	74.00	-25.07	PK
V	4882.00	61.88	-19.84	42.04	54.00	-11.96	AV
V	7323.00	60.58	-13.90	46.68	74.00	-27.32	PK
V	7323.00	50.62	-13.90	36.72	54.00	-17.28	AV
H	4882.00	67.25	-19.84	47.41	74.00	-26.59	PK
H	4882.00	58.04	-19.84	38.20	54.00	-15.80	AV
H	7323.00	57.95	-13.90	44.05	74.00	-29.95	PK
H	7323.00	49.24	-13.90	35.34	54.00	-18.66	AV
$\pi$ /4DQPSK High channel							
V	4960.00	71.77	-19.68	52.09	74.00	-21.91	PK
V	4960.00	62.69	-19.68	43.01	54.00	-10.99	AV
V	7440.00	63.87	-13.57	50.30	74.00	-23.70	PK
V	7440.00	53.83	-13.57	40.26	54.00	-13.74	AV
H	4960.00	69.37	-19.68	49.69	74.00	-24.31	PK
H	4960.00	59.70	-19.68	40.02	54.00	-13.98	AV
H	7440.00	62.04	-13.57	48.47	74.00	-25.53	PK
H	7440.00	54.69	-13.57	41.12	54.00	-12.88	AV

**Remark:**

- 1.Emission Level = Meter Reading + Factor,  
Factor = Antenna Factor + Cable Loss – Pre-amplifier.  
Over= Emission Level - Limit
- 2.If peak below the average limit, the average emission was no test.
3. In restricted bands of operation, The spurious emissions below the permissible value more than 20dB
4. The amplitude of spurious emissions which are attenuated by more than 20dB below the permissible value has no need to be reported.

Polar (H/V)	Frequency	Reading Level	Correct Factor	Measurement	Limits	Over	Detector Type
	(MHz)	(dBuV/m)	(dB)	(dBuV/m)	(dBuV/m)	(dB)	
8DPSK Low channel							
V	4804.00	69.22	-19.99	49.23	74.00	-24.77	PK
V	4804.00	58.22	-19.99	38.23	54.00	-15.77	AV
V	7206.00	60.61	-14.22	46.39	74.00	-27.61	PK
V	7206.00	50.70	-14.22	36.48	54.00	-17.52	AV
H	4804.00	68.15	-19.99	48.16	74.00	-25.84	PK
H	4804.00	57.57	-19.99	37.58	54.00	-16.42	AV
H	7206.00	57.84	-14.22	43.62	74.00	-30.38	PK
H	7206.00	49.51	-14.22	35.29	54.00	-18.71	AV
8DPSK Middle channel							
V	4882.00	65.95	-19.84	46.11	74.00	-27.89	PK
V	4882.00	58.40	-19.84	38.56	54.00	-15.44	AV
V	7323.00	57.05	-13.90	43.15	74.00	-30.85	PK
V	7323.00	47.61	-13.90	33.71	54.00	-20.29	AV
H	4882.00	63.77	-19.84	43.93	74.00	-30.07	PK
H	4882.00	54.39	-19.84	34.55	54.00	-19.45	AV
H	7323.00	54.64	-13.90	40.74	74.00	-33.26	PK
H	7323.00	46.49	-13.90	32.59	54.00	-21.41	AV
8DPSK High channel							
V	4960.00	67.96	-19.68	48.28	74.00	-25.72	PK
V	4960.00	58.92	-19.68	39.24	54.00	-14.76	AV
V	7440.00	60.60	-13.57	47.03	74.00	-26.97	PK
V	7440.00	50.09	-13.57	36.52	54.00	-17.48	AV
H	4960.00	66.22	-19.68	46.54	74.00	-27.46	PK
H	4960.00	55.84	-19.68	36.16	54.00	-17.84	AV
H	7440.00	59.17	-13.57	45.60	74.00	-28.40	PK
H	7440.00	50.51	-13.57	36.94	54.00	-17.06	AV

**Remark:**

1. Emission Level = Meter Reading + Factor,  
Factor = Antenna Factor + Cable Loss – Pre-amplifier.  
Over= Emission Level - Limit
2. If peak below the average limit, the average emission was no test.
3. In restricted bands of operation, The spurious emissions below the permissible value more than 20dB
4. The amplitude of spurious emissions which are attenuated by more than 20dB below the permissible value has no need to be reported.



## 8. Radiated Band Emission Measurement And Restricted Bands Of Operation

### 8.1 Block Diagram Of Test Setup

Radiated Emission Test-Up Frequency Above 1GHz

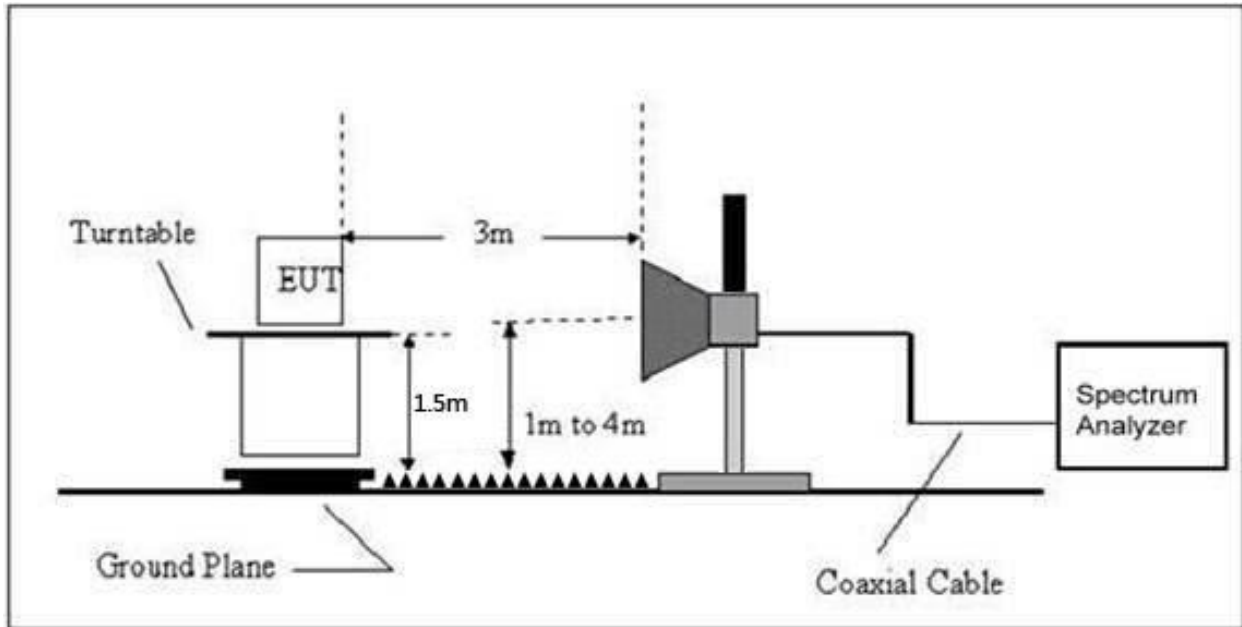

### 8.2 Limit

FCC Part15 C Section 15.209 and 15.205

(a) Except as shown in paragraph (d) of this section, only spurious emissions are permitted in any of the frequency bands listed below:

MHz	MHz	MHz	GHz
0.090-0.110	16.42-16.423	399.9-410	4.5-5.15
0.495-0.505	16.69475-16.69525	608-614	5.35-5.46
2.1735-2.1905	16.80425-16.80475	960-1240	7.25-7.75
4.125-4.128	25.5-25.67	1300-1427	8.025-8.5
4.17725-4.17775	37.5-38.25	1435-1626.5	9.0-9.2
4.20725-4.20775	73-74.6	1645.5-1646.5	9.3-9.5
6.215-6.218	74.8-75.2	1660-1710	10.6-12.7
6.26775-6.26825	108-121.94	1718.8-1722.2	13.25-13.4
6.31175-6.31225	123-138	2200-2300	14.47-14.5
8.291-8.294	149.9-150.05	2310-2390	15.35-16.2
8.362-8.366	156.52475-156.52525	2483.5-2500	17.7-21.4
8.37625-8.38675	156.7-156.9	2690-2900	22.01-23.12
8.41425-8.41475	162.0125-167.17	3260-3267	23.6-24.0
12.29-12.293	167.72-173.2	3332-3339	31.2-31.8
12.51975-12.52025	240-285	3345.8-3358	36.43-36.5
12.57675-12.57725	322-335.4	3600-4400	( <sup>2</sup> )
13.36-13.41			

## Limits Of Radiated Emission Measurement (Above 1000MHz)

Frequency (MHz)	Limit (dBuV/m) (at 3M)	
	Peak	Average
Above 1000	74	54

## Notes:

- (1)The limit for radiated test was performed according to FCC PART 15C.
- (2)The tighter limit applies at the band edges.
- (3)Emission level (dBuV/m)=20log Emission level (uV/m).

### 8.3 Test procedure

Receiver Parameter	Setting
Attenuation	Auto
Start Frequency	2300MHz
Stop Frequency	2520
RB / VB (Emission In Restricted Band)	1 MHz / 1 MHz for Peak, 1 MHz / 10Hz for Average

Above 1GHz test procedure as below:

- a.The EUT was placed on the top of a rotating table 1.5 meters above the ground at a 3 meter camber. The table was rotated 360 degrees to determine the position of the highest radiation.
- b.The EUT was set 3 meters away from the interference-receiving antenna, which was mounted on the top of a variable-height antenna tower.
- c.The antenna height is varied from one meter to four meters above the ground to determine the maximum value of the field strength. Both horizontal and vertical polarizations of the antenna are set to make the measurement.
- d.For each suspected emission, the EUT was arranged to its worst case and then the antenna was tuned to heights from 1 meter to 4 meters and the rota table was turned from 0 degrees to 360 degrees to find the maximum reading.
- e.The test-receiver system was set to Peak Detect Function and Specified Bandwidth with Maximum Hold Mode.
- f. If the emission level of the EUT in peak mode was 10dB lower than the limit specified, then testing could be stopped and the peak values of the EUT would be reported. Otherwise the emissions that did not have 10dB margin would be re-tested one by one using peak, quasi-peak or average method as specified and then reported in a data sheet.
- g. Test the EUT in the lowest channel, the middlest channel, the Highest channel.

## Note:

Both horizontal and vertical antenna polarities were tested and performed pretest to three orthogonal axis. The worst case emissions were reported.

### 8.4 EUT operating Conditions

The EUT was configured for testing in a typical fashion (as a customer would normally use it). The EUT has been programmed to continuously transmit during test. This operating condition was tested and used to collect the included data.



## 8.5 Test Result

	Polar (H/V)	Frequency (MHz)	Reading Level (dBuV/m)	Correct Factor (dB)	Measurement (dBuV/m)	Limits (dBuV/m)		Result	
					PK	PK	AV		
GFSK	Low Channel 2402MHz								
	H	2390.00	53.91	-25.43	28.48	74.00	54.00	PASS	
	H	2400.00	58.07	-25.40	32.67	74.00	54.00	PASS	
	V	2390.00	54.03	-25.43	28.60	74.00	54.00	PASS	
	V	2400.00	58.12	-25.40	32.72	74.00	54.00	PASS	
	High Channel 2480MHz								
	H	2483.50	57.11	-25.15	31.96	74.00	54.00	PASS	
	H	2500.00	51.56	-25.10	26.46	74.00	54.00	PASS	
	V	2483.50	57.13	-25.15	31.98	74.00	54.00	PASS	
	V	2500.00	53.04	-25.10	27.94	74.00	54.00	PASS	
	$\pi/4$ DQPSK	Low Channel 2402MHz							
		H	2390.00	54.08	-25.43	28.65	74.00	54.00	PASS
H		2400.00	58.50	-25.40	33.10	74.00	54.00	PASS	
V		2390.00	53.12	-25.43	27.69	74.00	54.00	PASS	
V		2400.00	57.34	-25.40	31.94	74.00	54.00	PASS	
High Channel 2480MHz									
H		2483.50	56.63	-25.15	31.48	2483.50	56.60	-6.79	
H		2500.00	52.86	-25.10	27.76	2500.00	51.76	-6.81	
V		2483.50	56.00	-25.15	30.85	2483.50	56.25	-6.79	
V		2500.00	52.09	-25.10	26.99	2500.00	52.41	-6.81	
8DPSK		Low Channel 2402MHz							
		H	2390.00	54.64	-25.43	29.21	74.00	54.00	PASS
	H	2400.00	59.21	-25.40	33.81	74.00	54.00	PASS	
	V	2390.00	54.67	-25.43	29.24	74.00	54.00	PASS	
	V	2400.00	59.48	-25.40	34.08	74.00	54.00	PASS	
	High Channel 2480MHz								
	H	2483.50	56.68	-25.15	31.53	74.00	54.00	PASS	
	H	2500.00	54.02	-25.10	28.92	74.00	54.00	PASS	
	V	2483.50	58.90	-25.15	33.75	74.00	54.00	PASS	
	V	2500.00	54.98	-25.10	29.88	74.00	54.00	PASS	

**Remark:**

- Emission Level = Meter Reading + Factor,  
Factor = Antenna Factor + Cable Loss – Pre-amplifier.  
Over= Emission Level – Limit
- If the PK measured levels comply with average limit, then the average level were deemed to comply with average limit.
- In restricted bands of operation, The spurious emissions below the permissible value more than 20dB
- The amplitude of spurious emissions which are attenuated by more than 20dB below the permissible value has no need to be reported.

## 9. Spurious RF Conducted Emissions

### 9.1 Block Diagram Of Test Setup



### 9.2 Limit

Regulation 15.247 (d), In any 100 kHz bandwidth outside the frequency band in which the spread spectrum or digitally modulated intentional radiator is operating, the radio frequency power that is produced by the intentional radiator shall be at least 20 dB below that in the 100 kHz bandwidth within the band that contains the highest level of the desired power, based on either an RF conducted or a radiated measurement, provided the transmitter demonstrates compliance with the peak conducted power limits. If the transmitter complies with the conducted power limits based on the use of RMS averaging over a time interval, as permitted under paragraph (b)(3) of this section, the attenuation required under this paragraph shall be 30 dB instead of 20 dB. Attenuation below the general limits specified in §15.209(a) is not required. In addition, radiated emissions which fall in the restricted bands, as defined in §15.205(a), must also comply with the radiated emission limits specified in §15.209(a) (see §15.205(c))

### 9.3 Test procedure

1. Remove the antenna from the EUT and then connect a low RF cable from the antenna port to the spectrum;
2. Set the spectrum analyzer:  
RBW = 100kHz, VBW = 300kHz, Sweep = auto  
Detector function = peak, Trace = max hold

## 9.4 Test Result

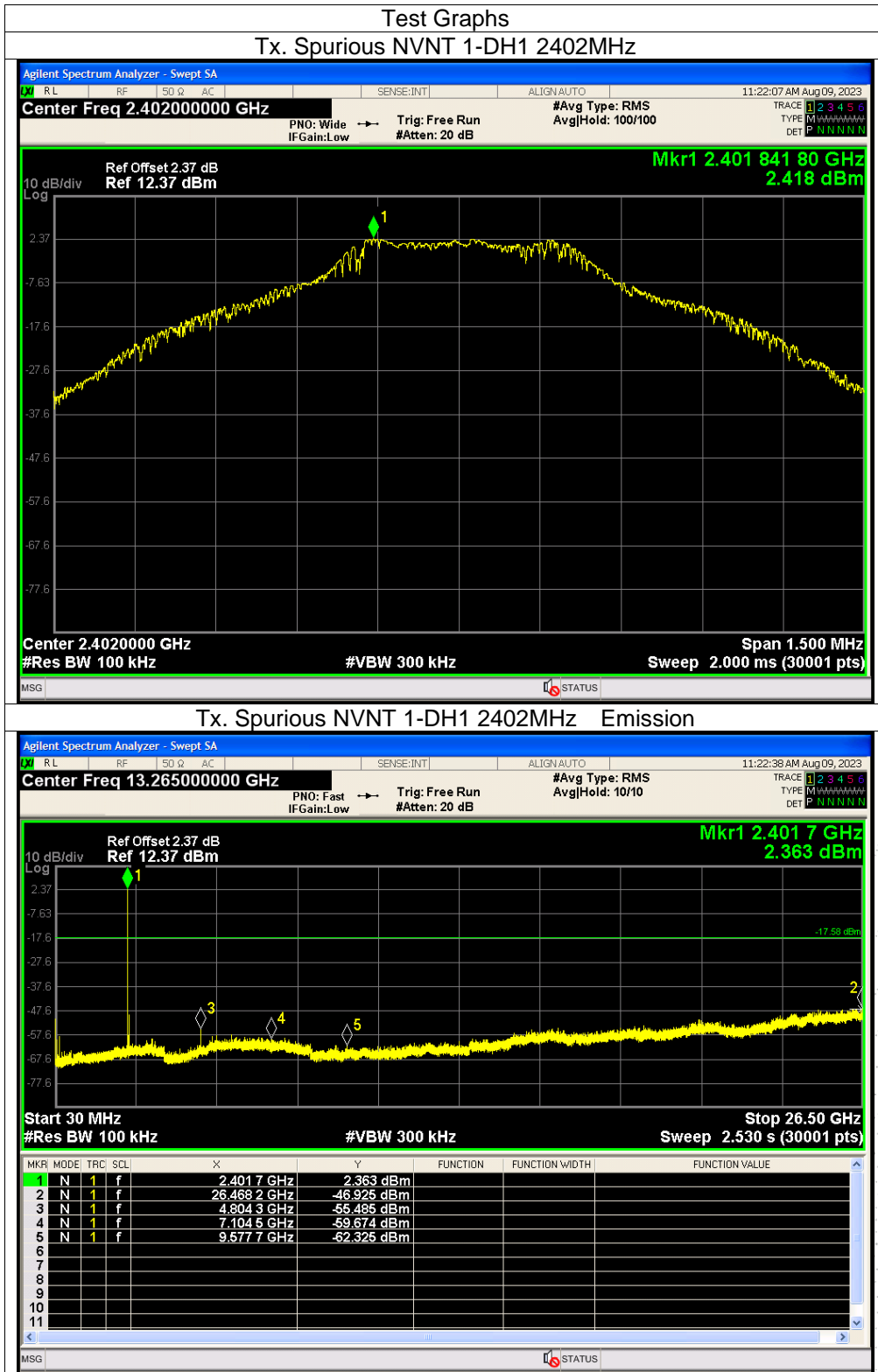

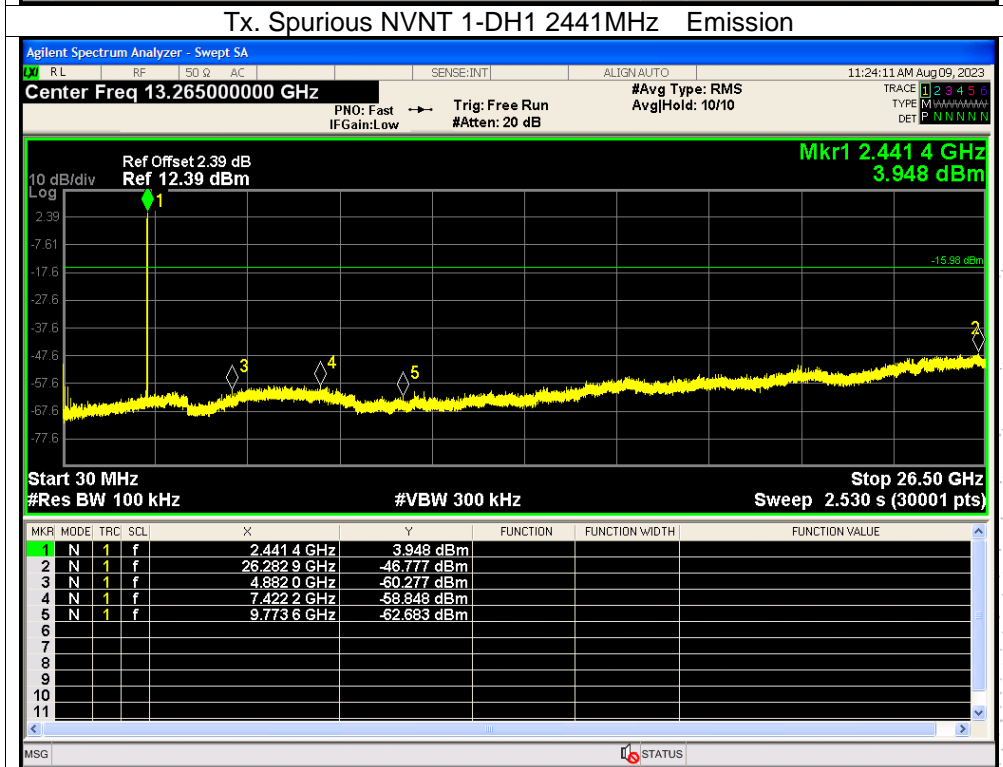
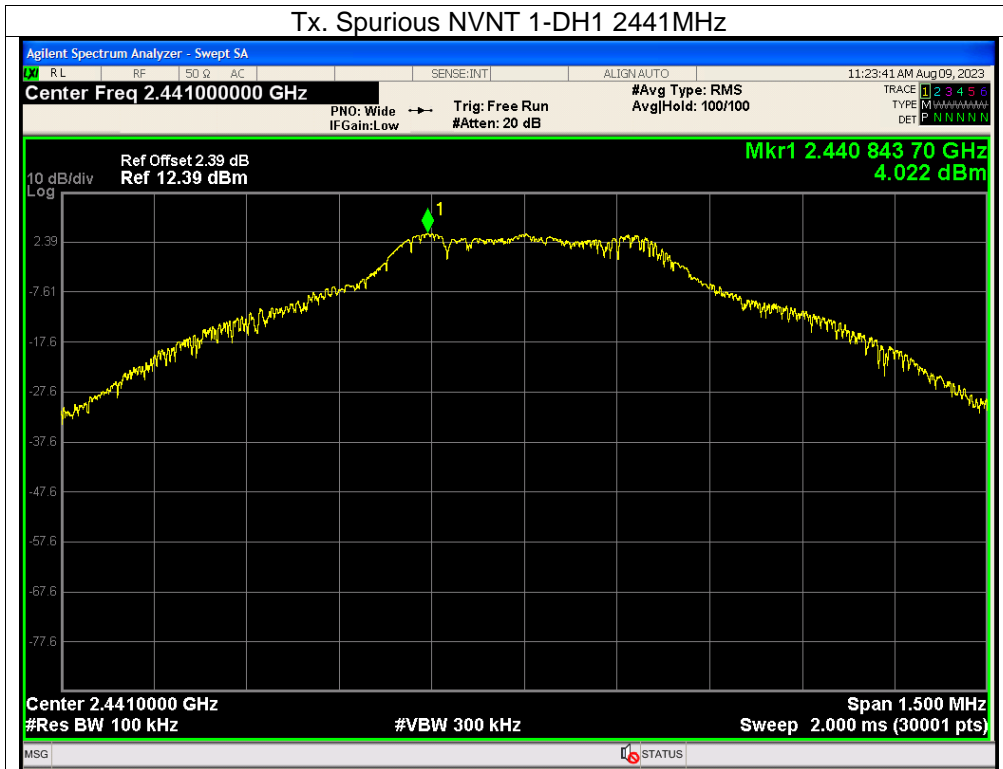

CO., LTD

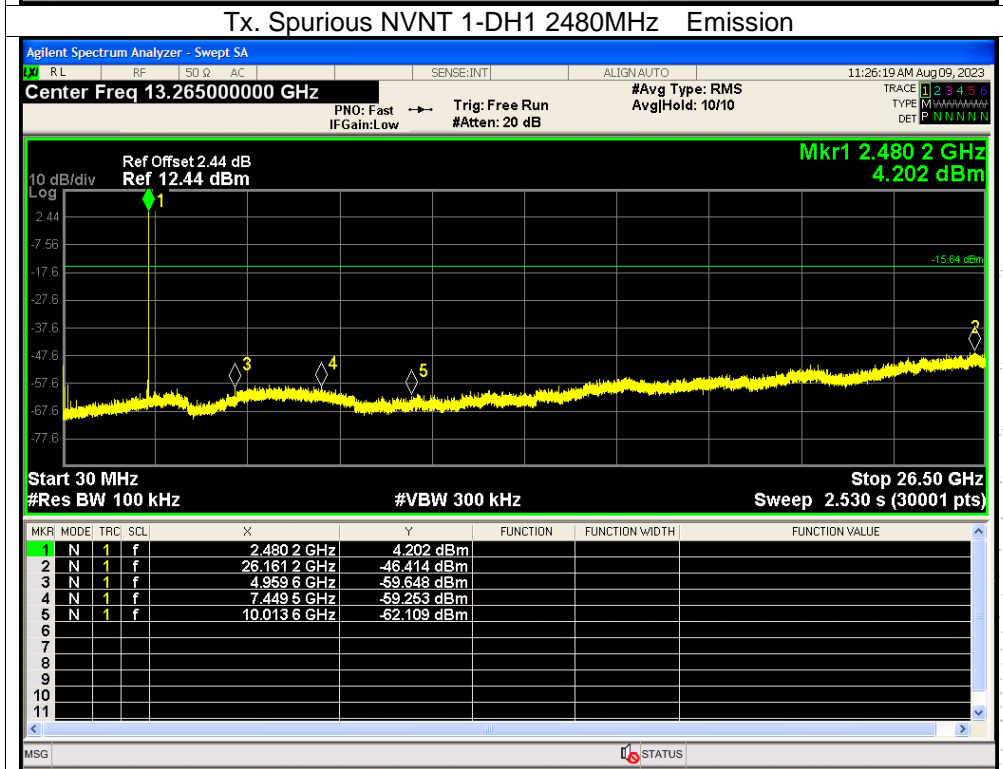
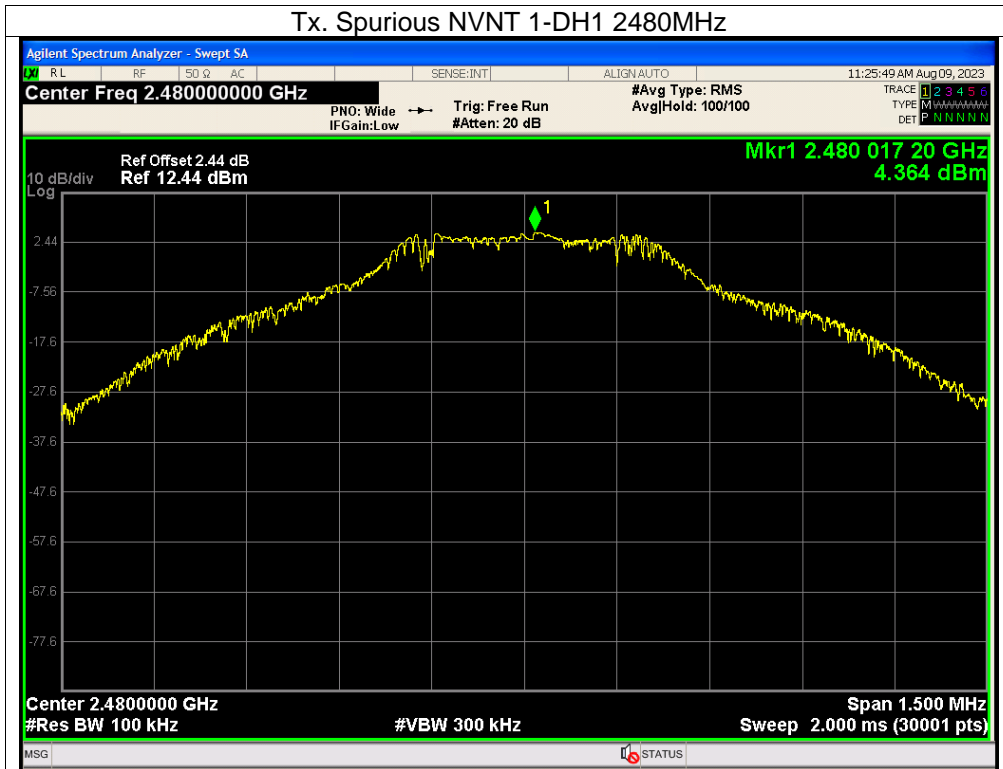



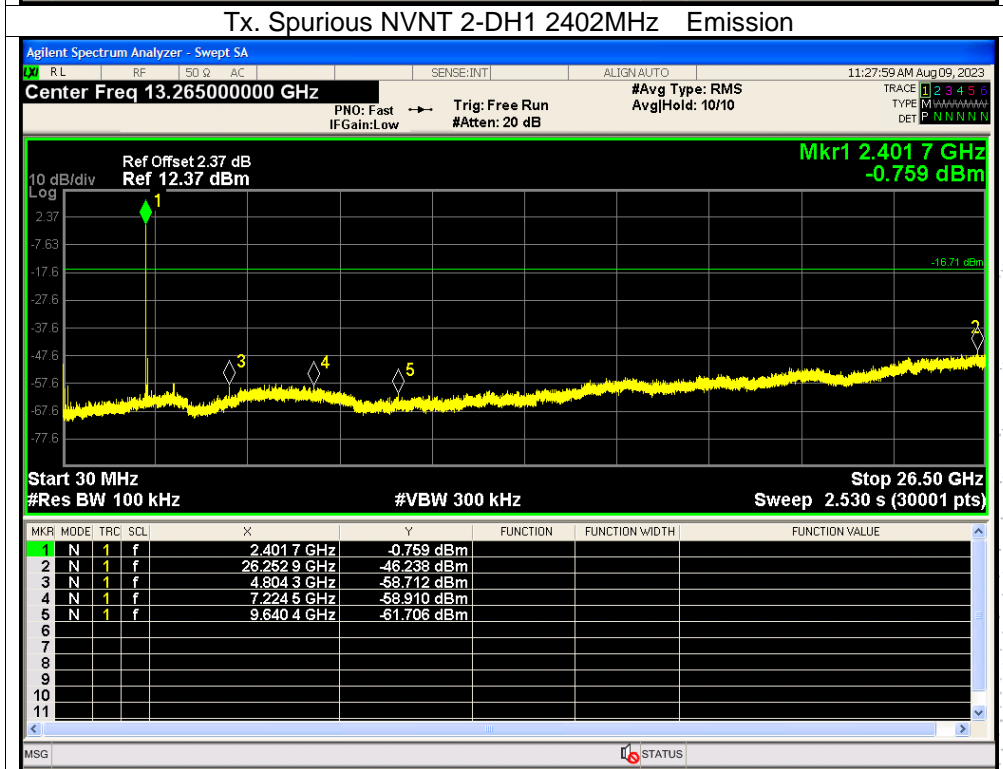
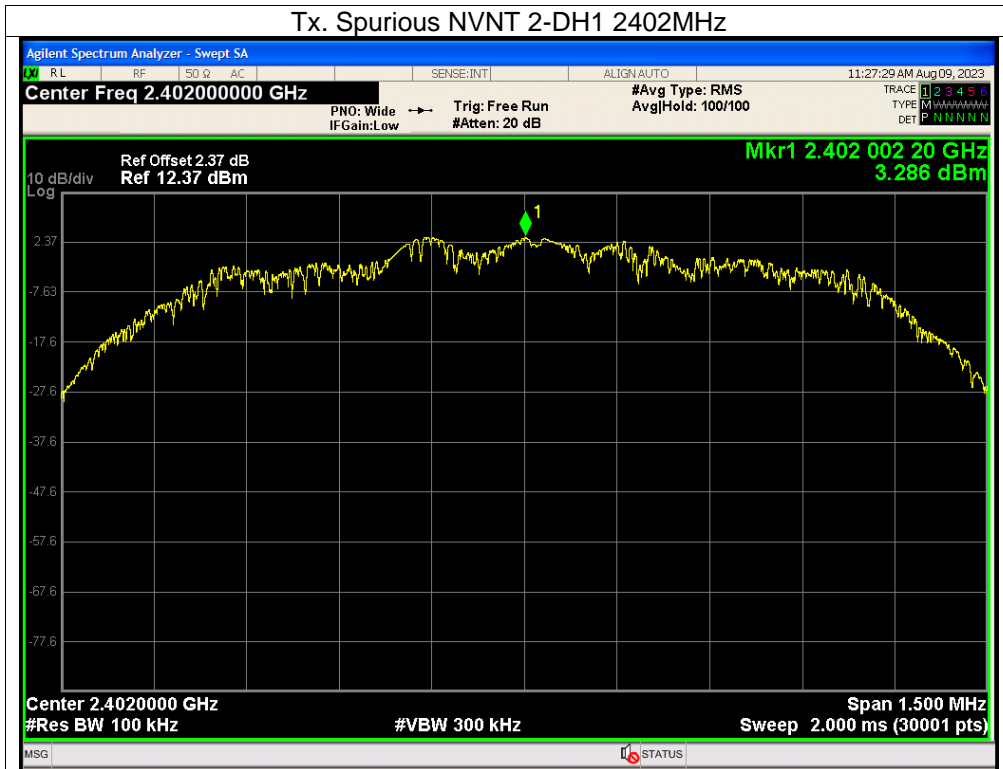



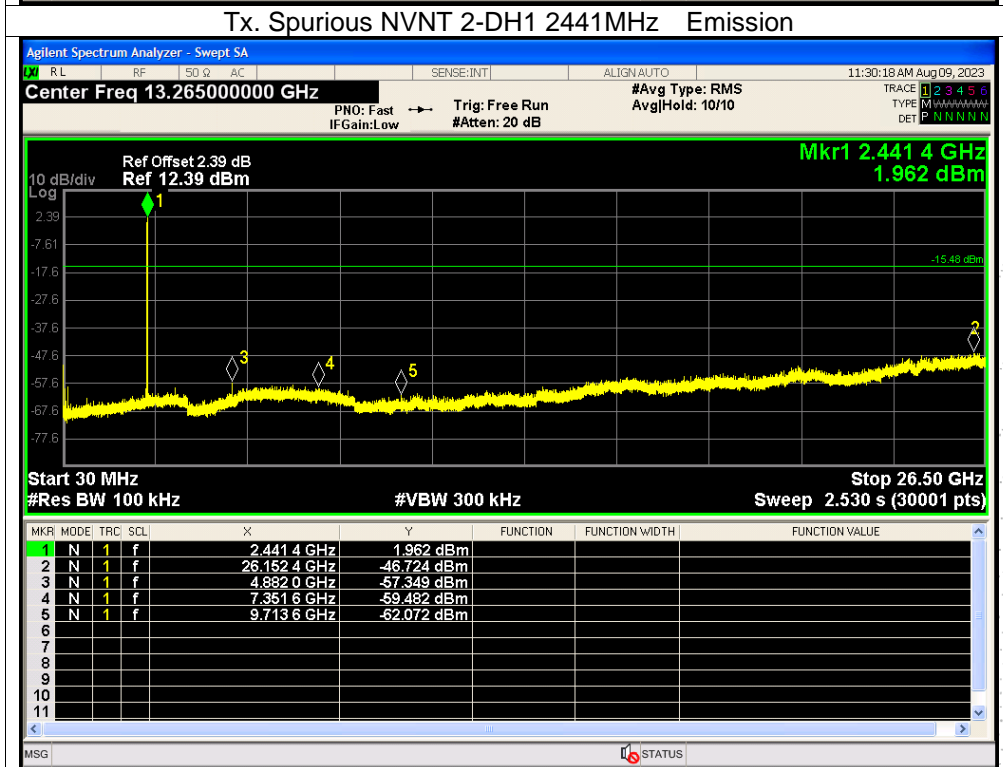
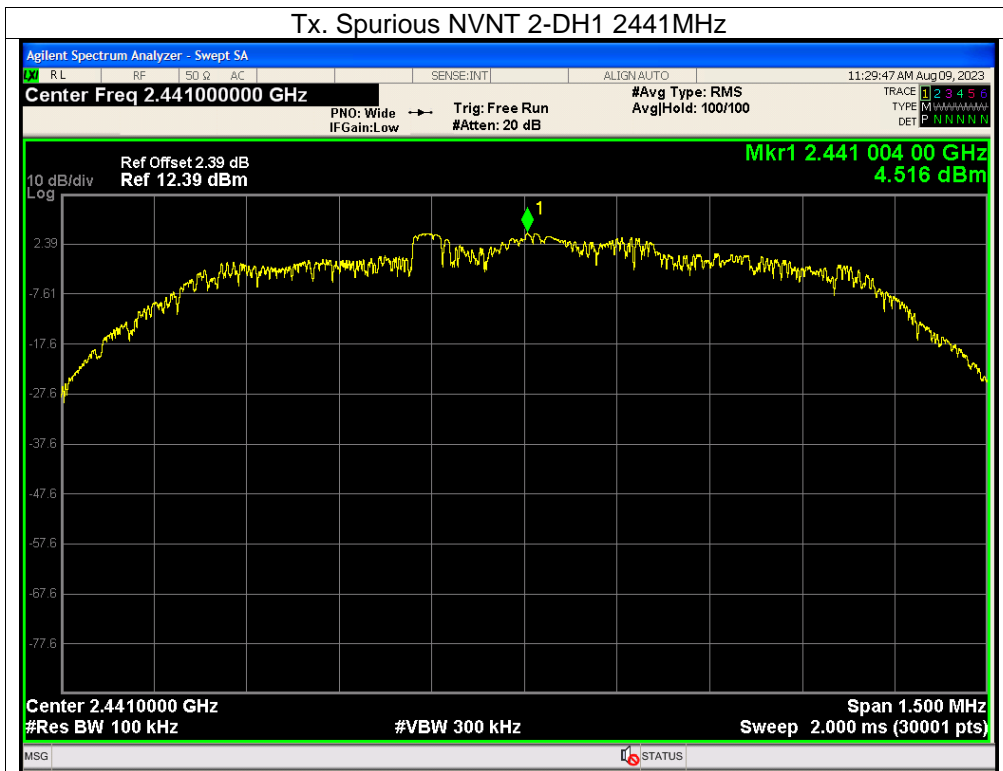

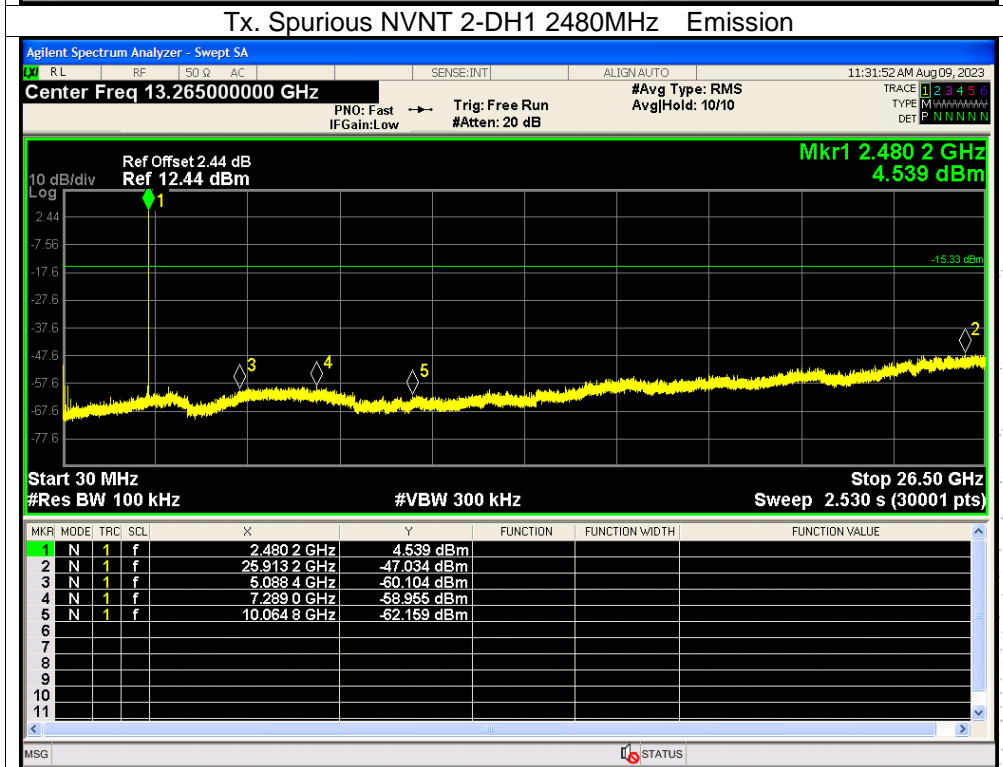
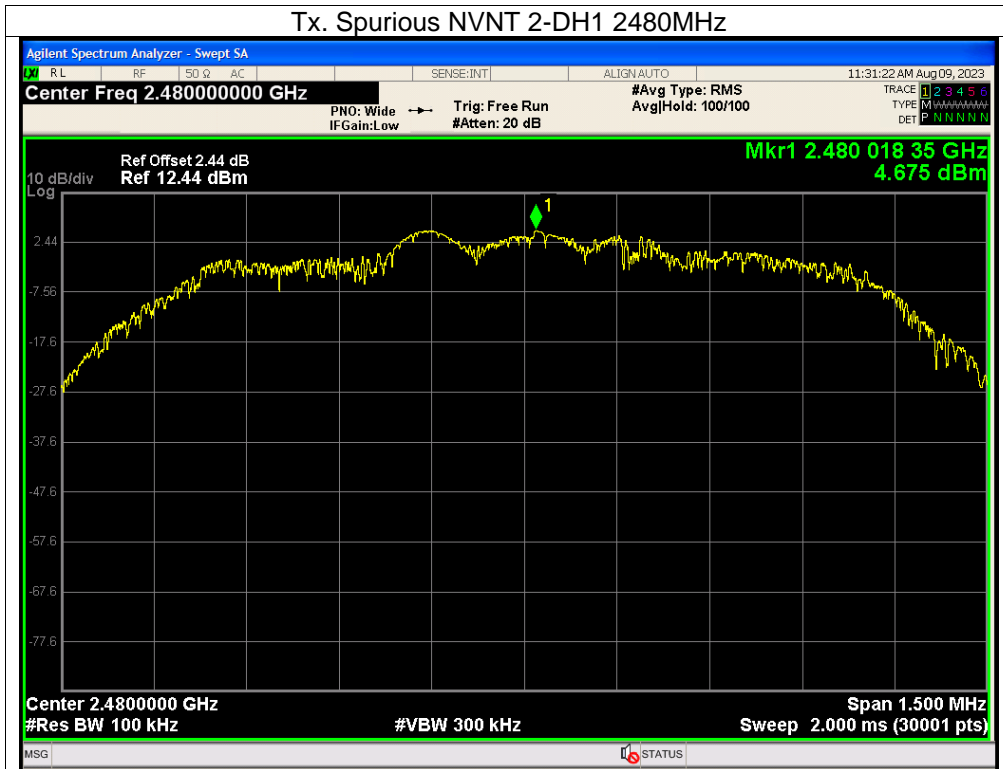

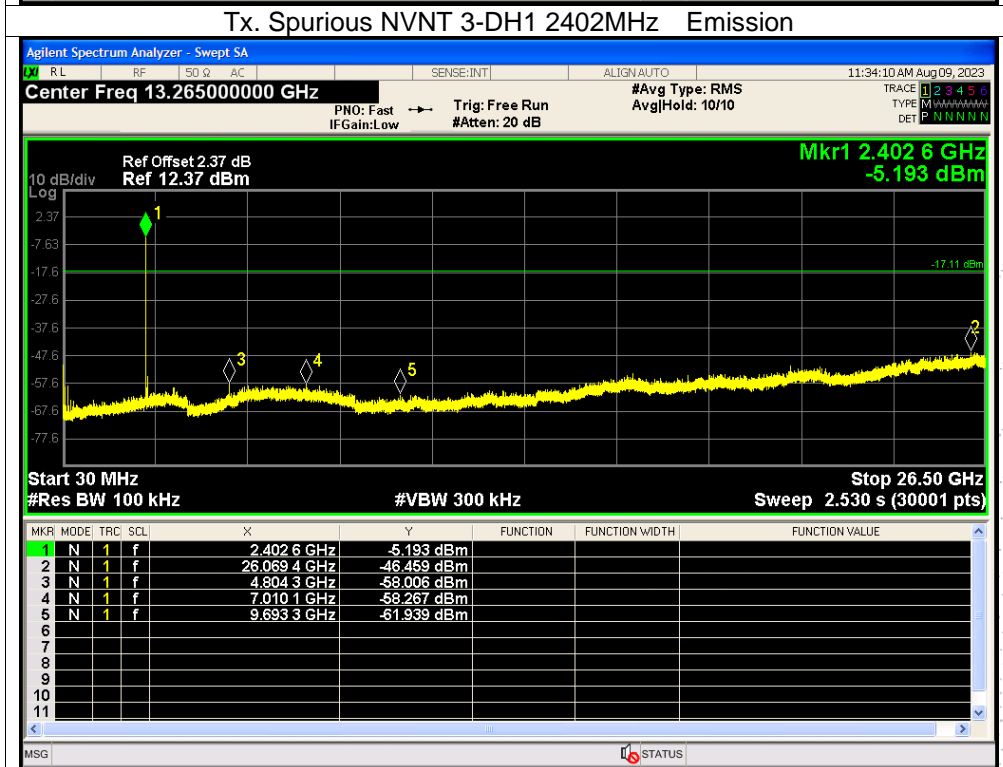
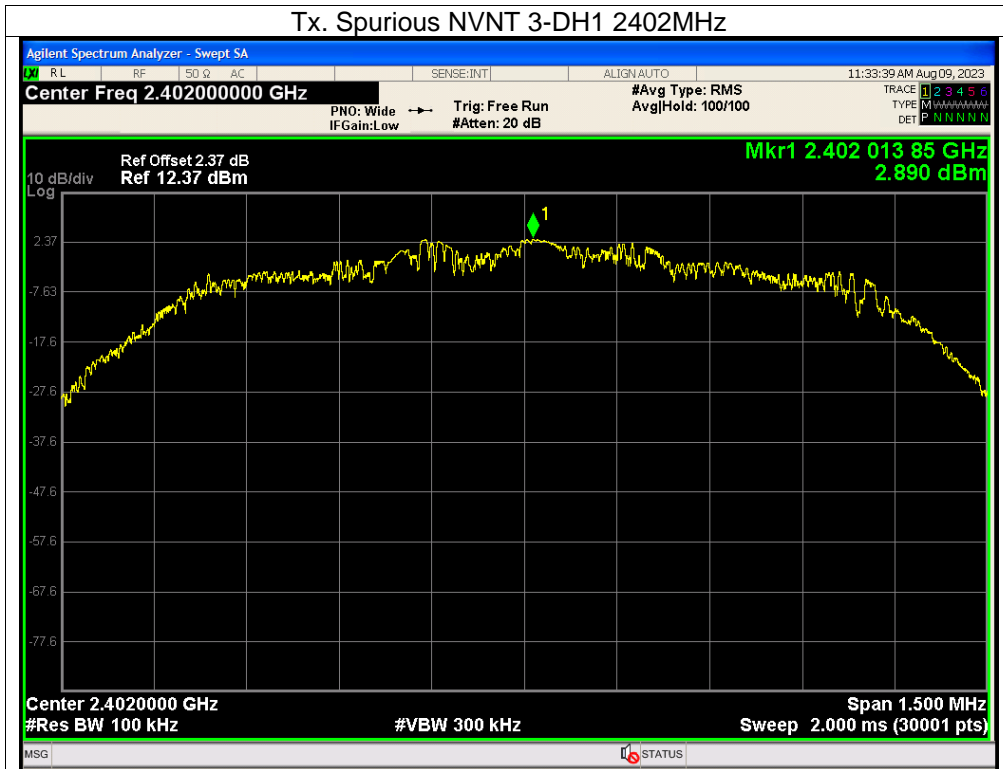

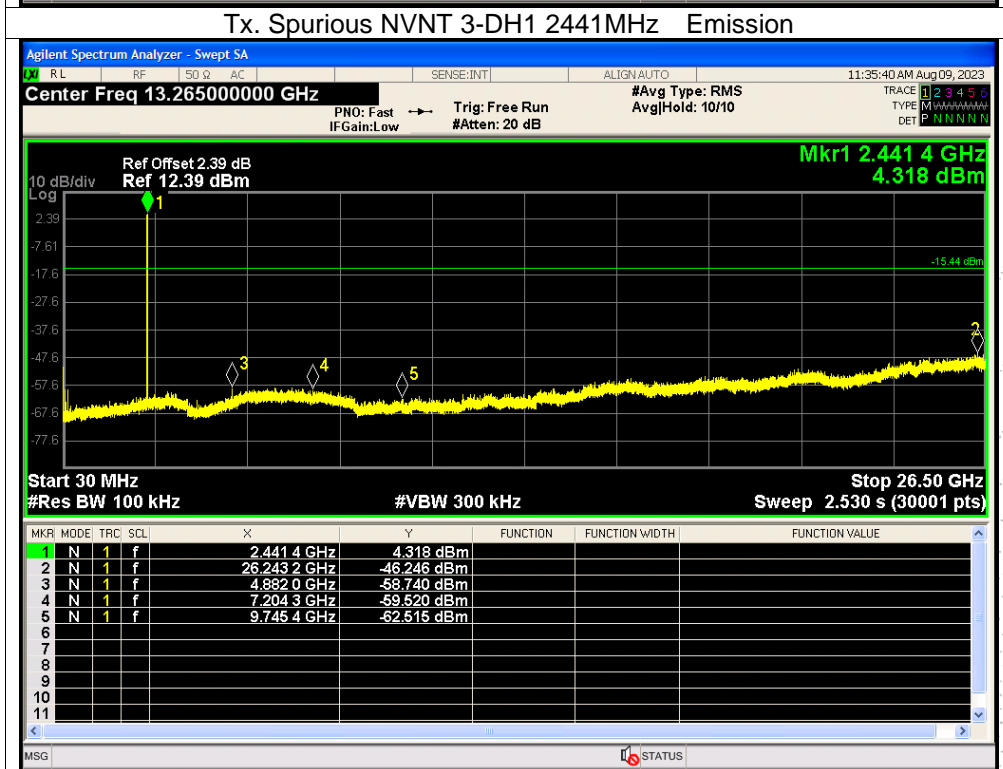
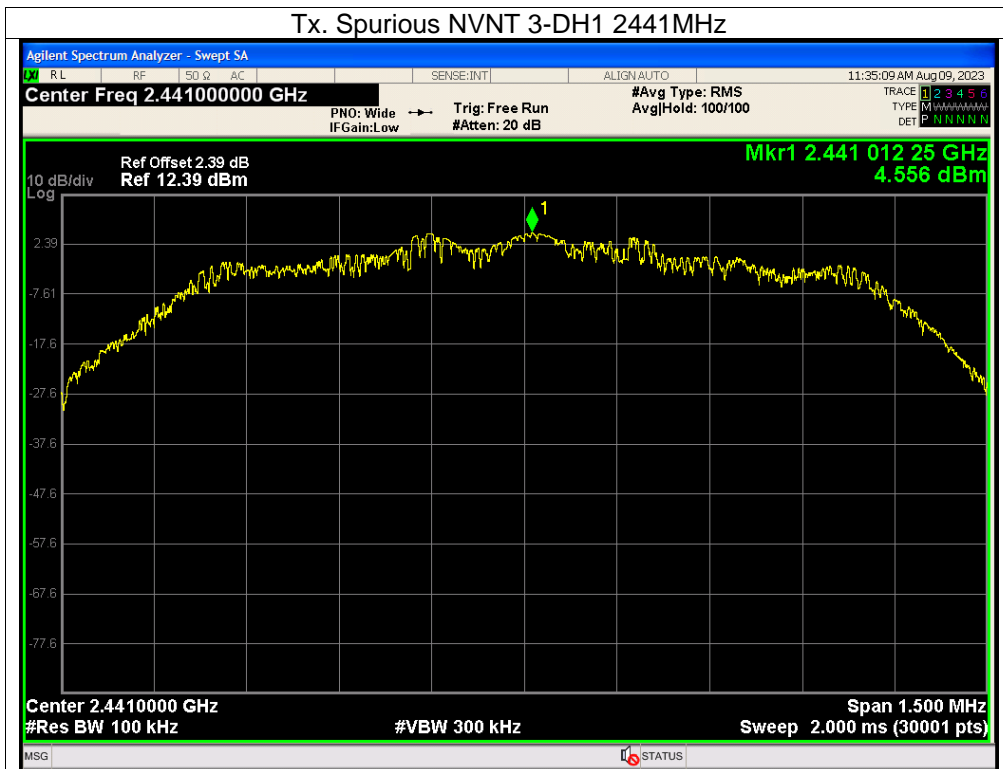

CO., LTD.

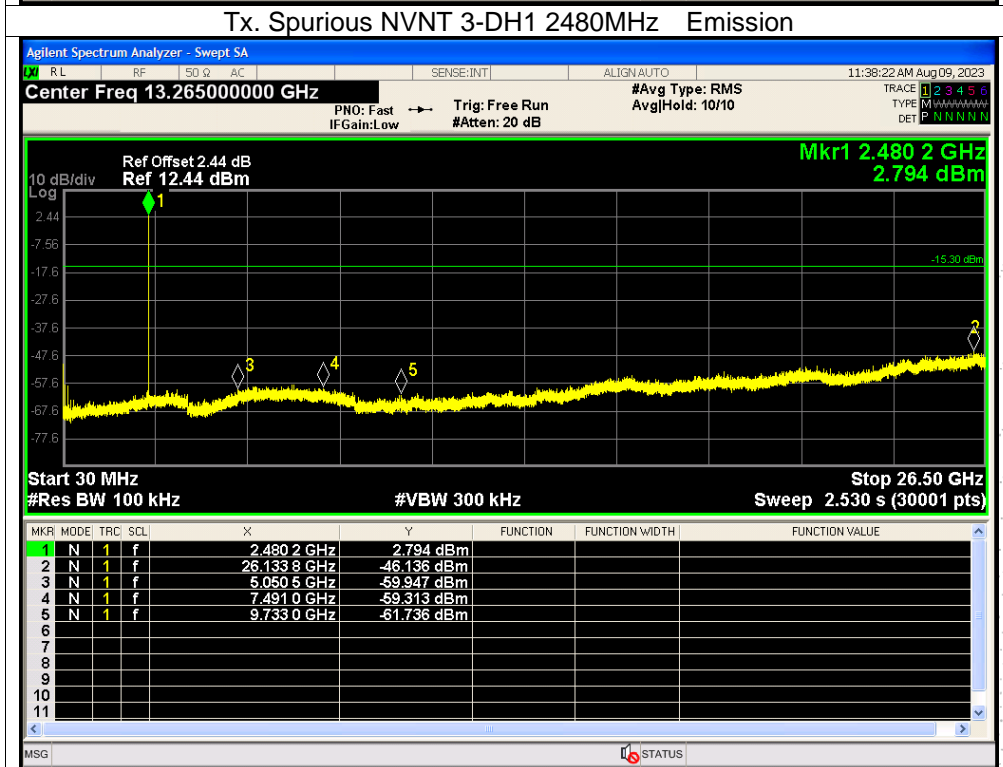
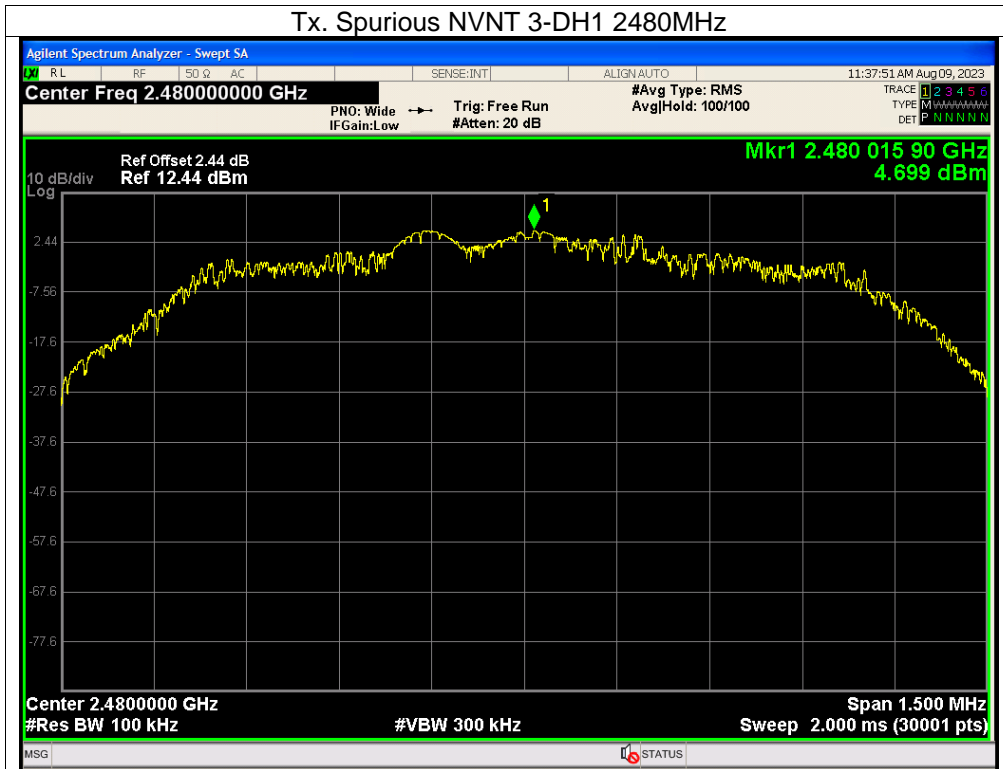

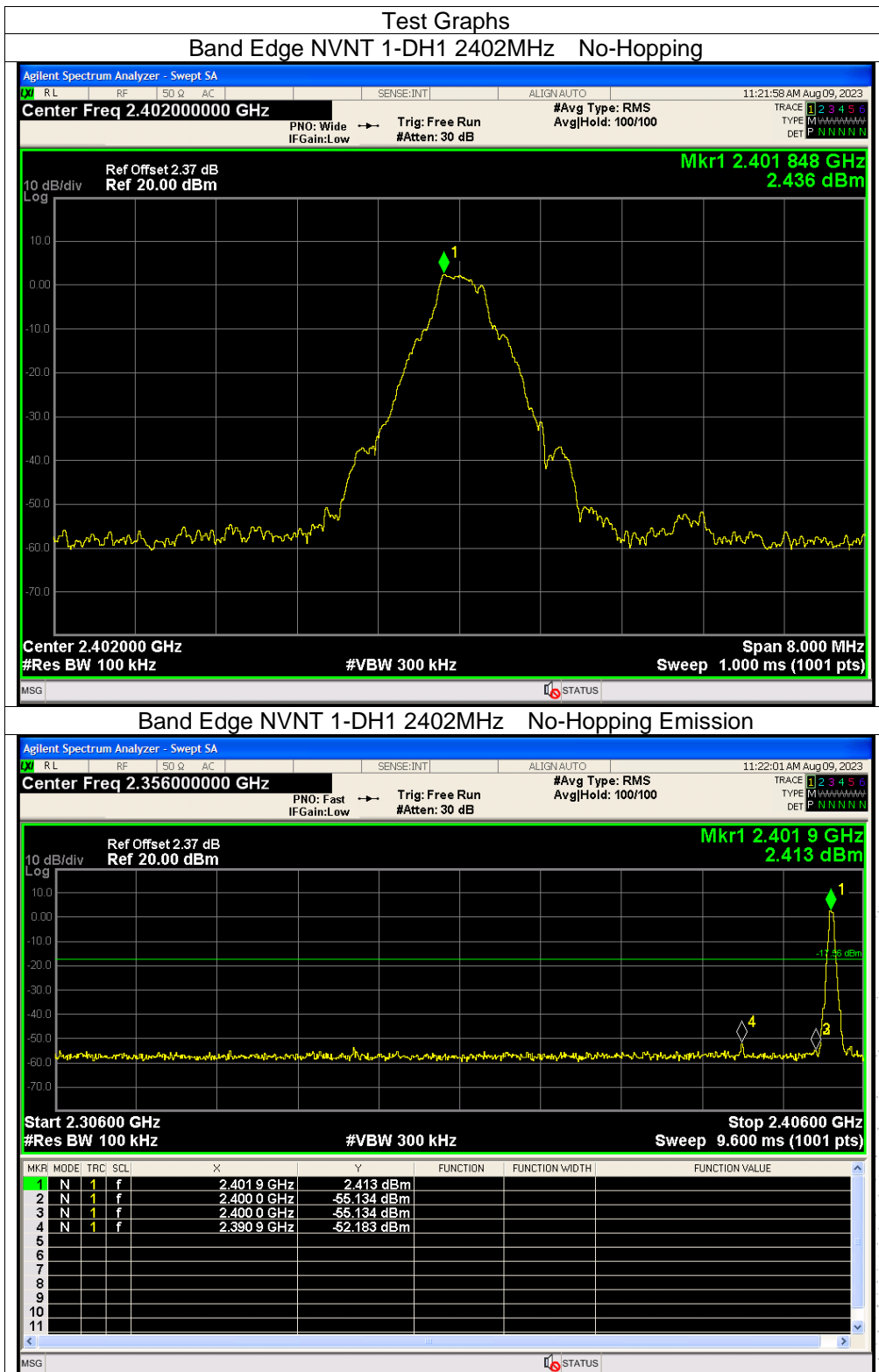

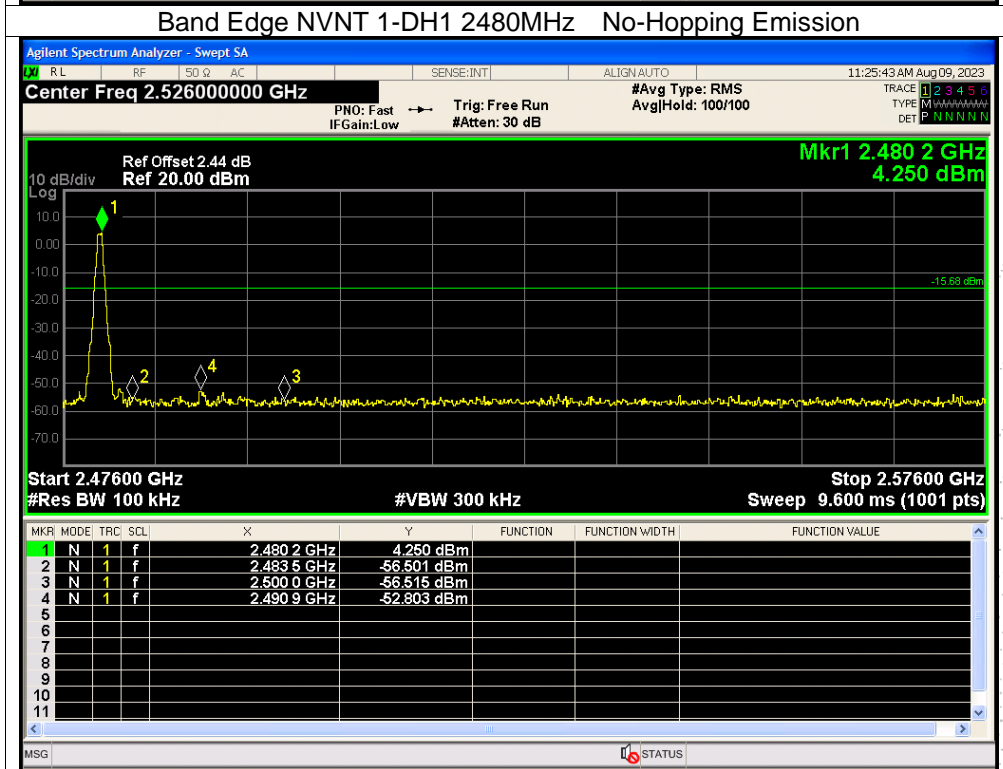
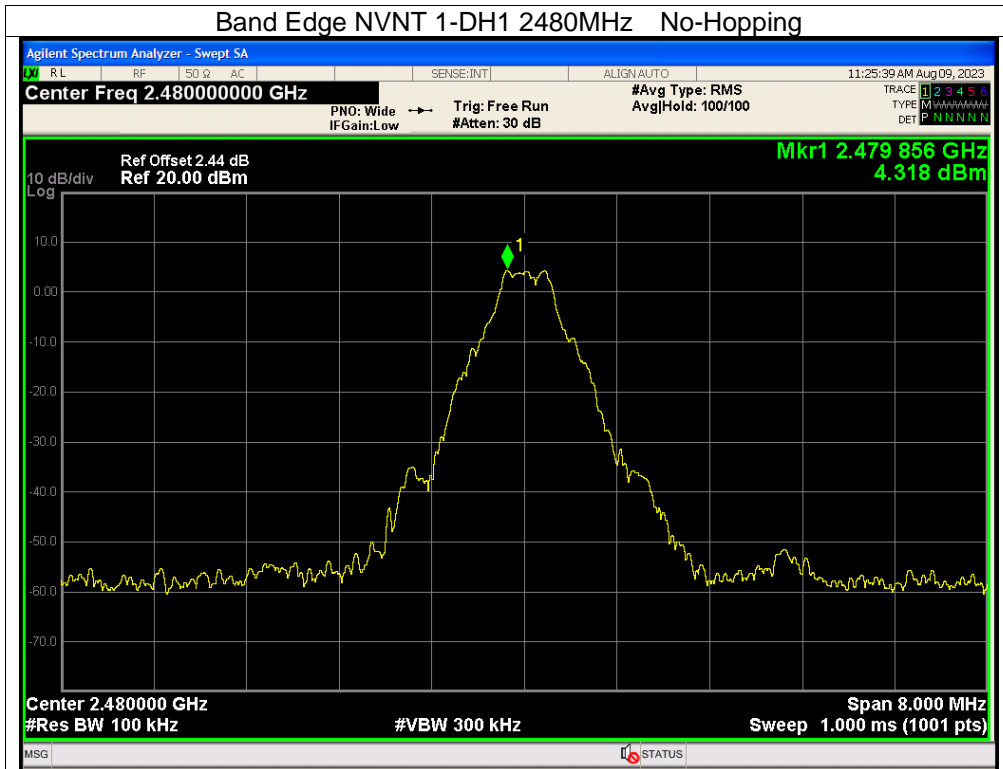

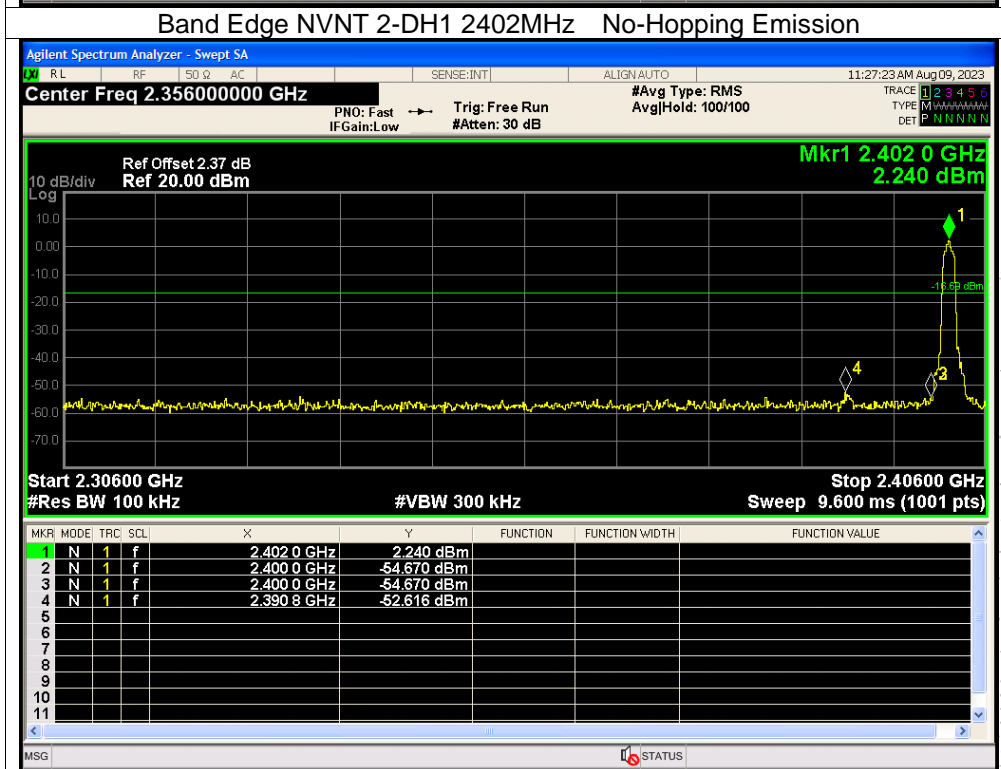
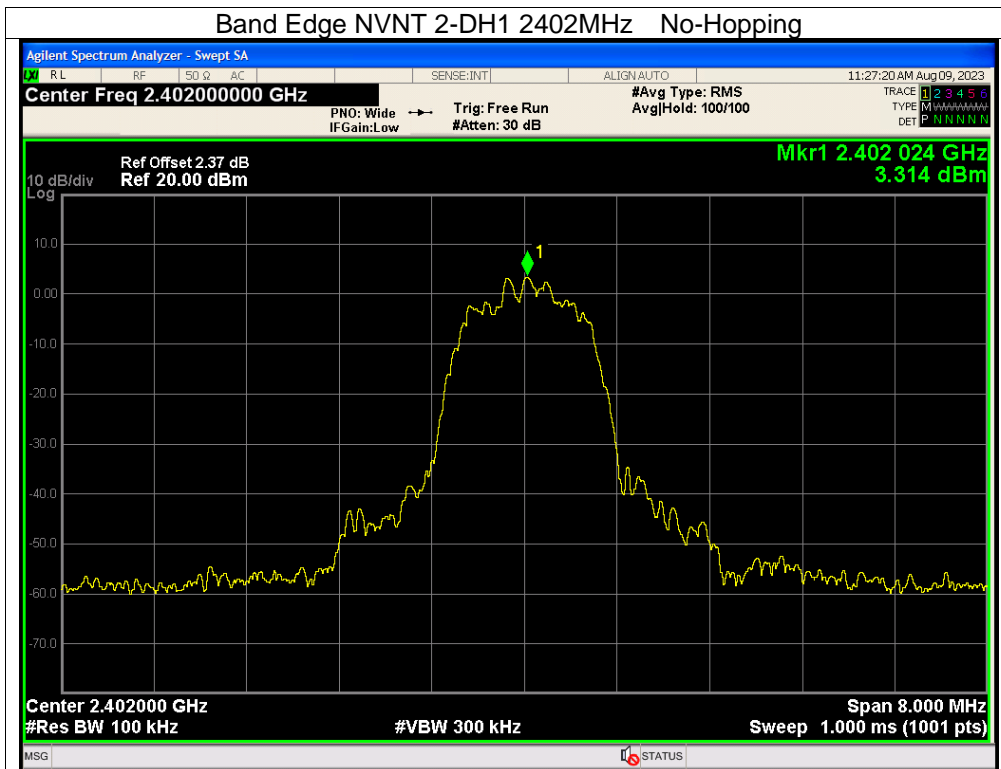



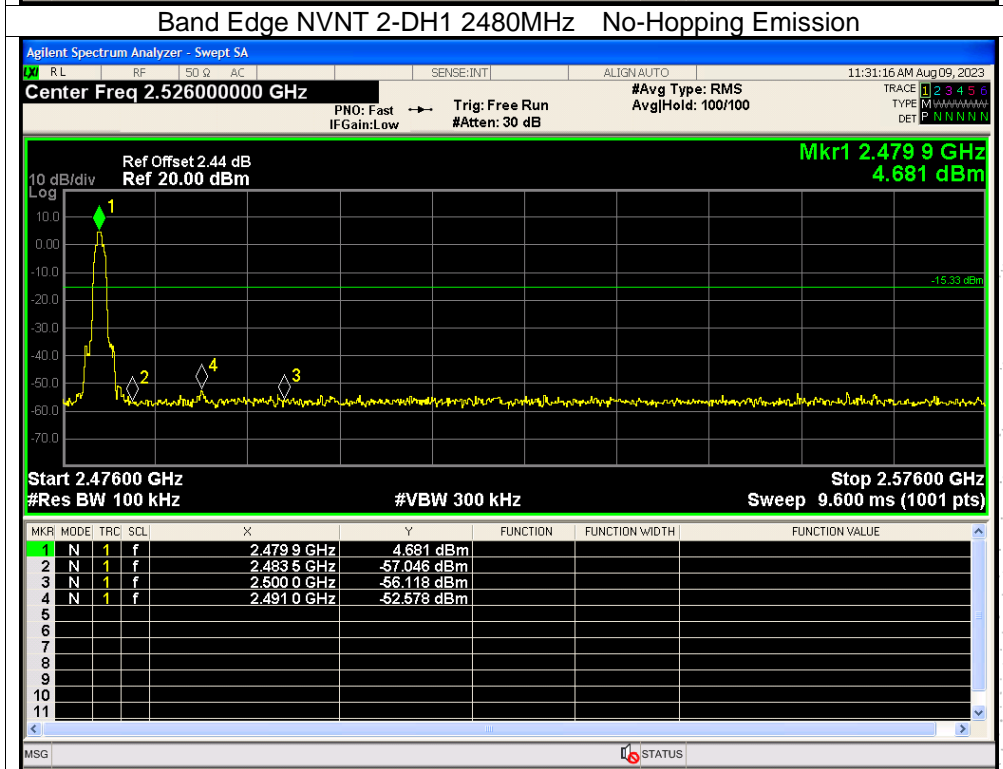
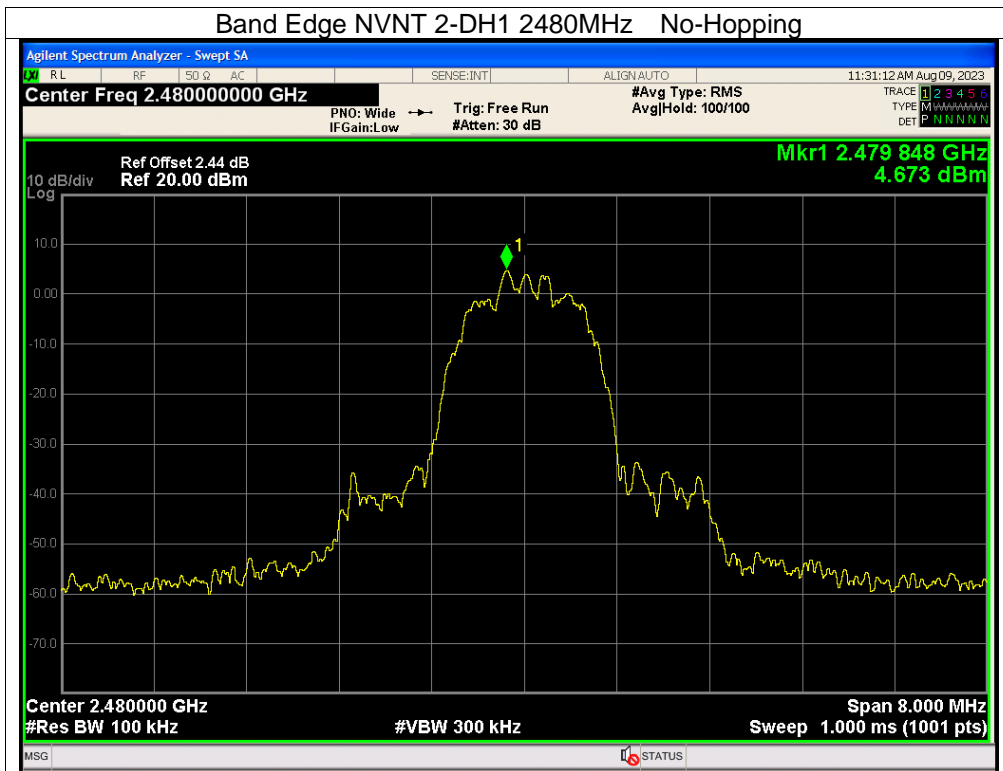

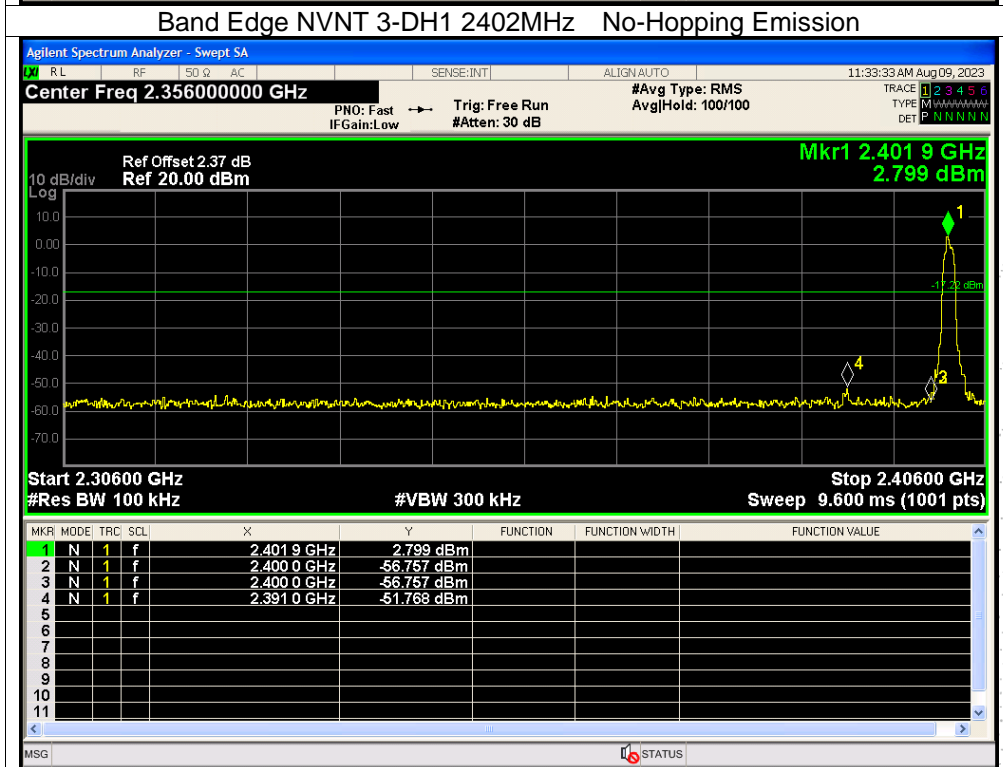
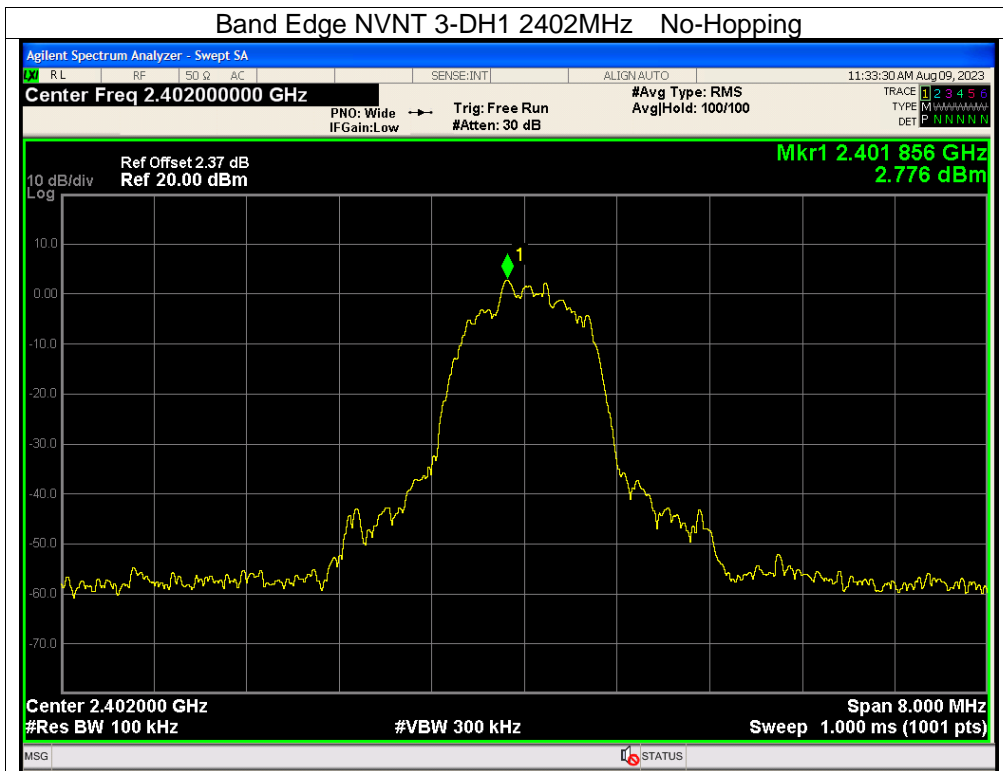

CO. LTD

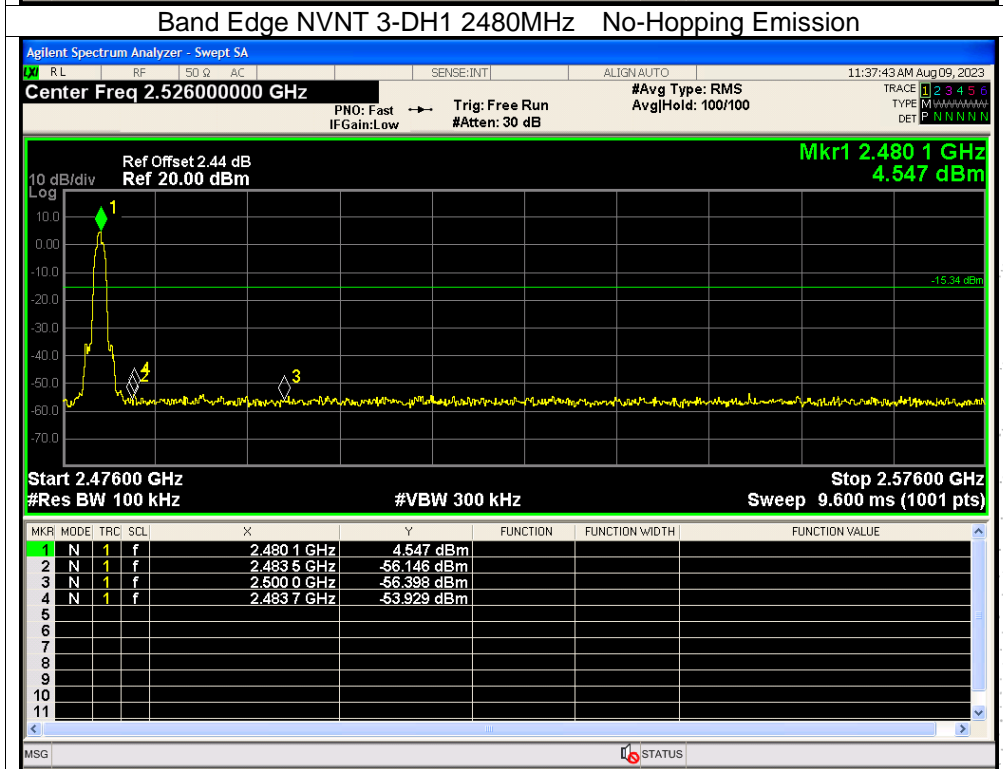
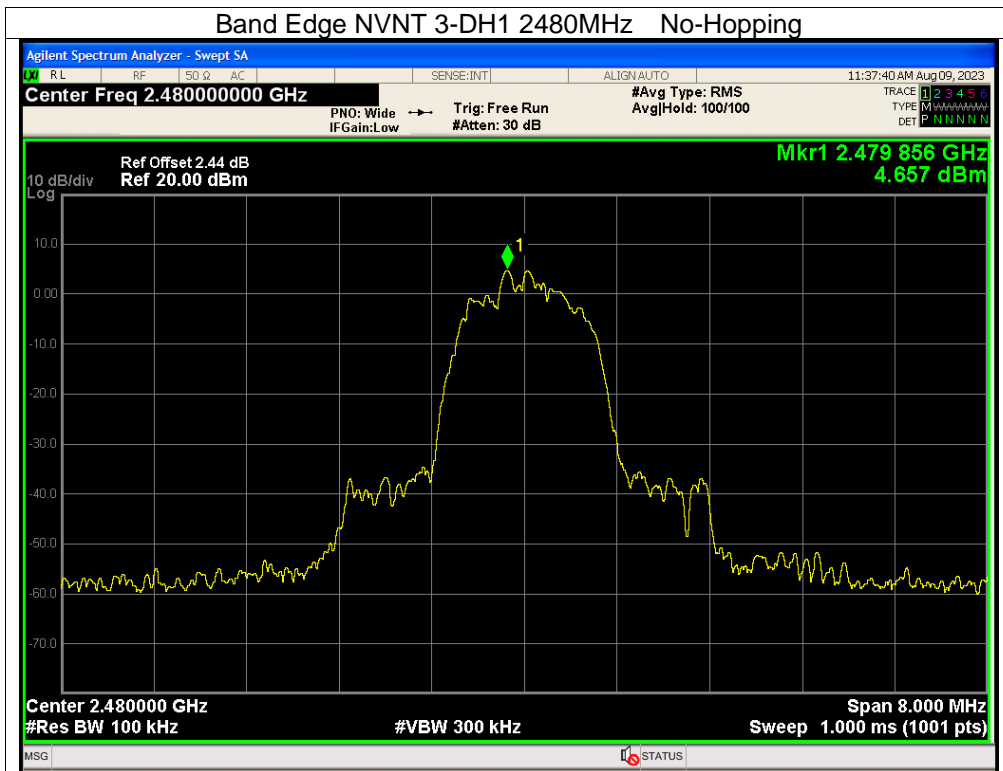

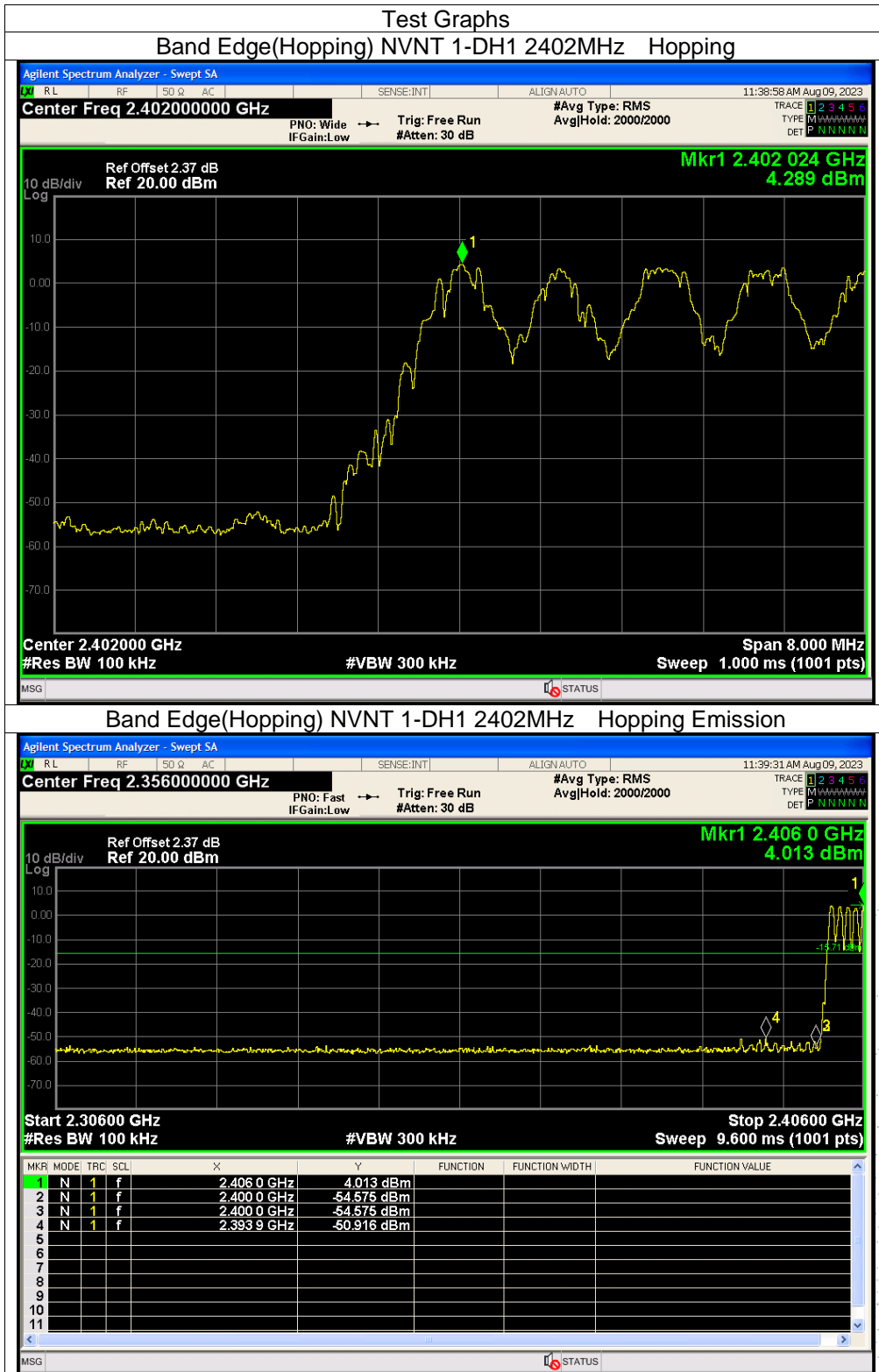

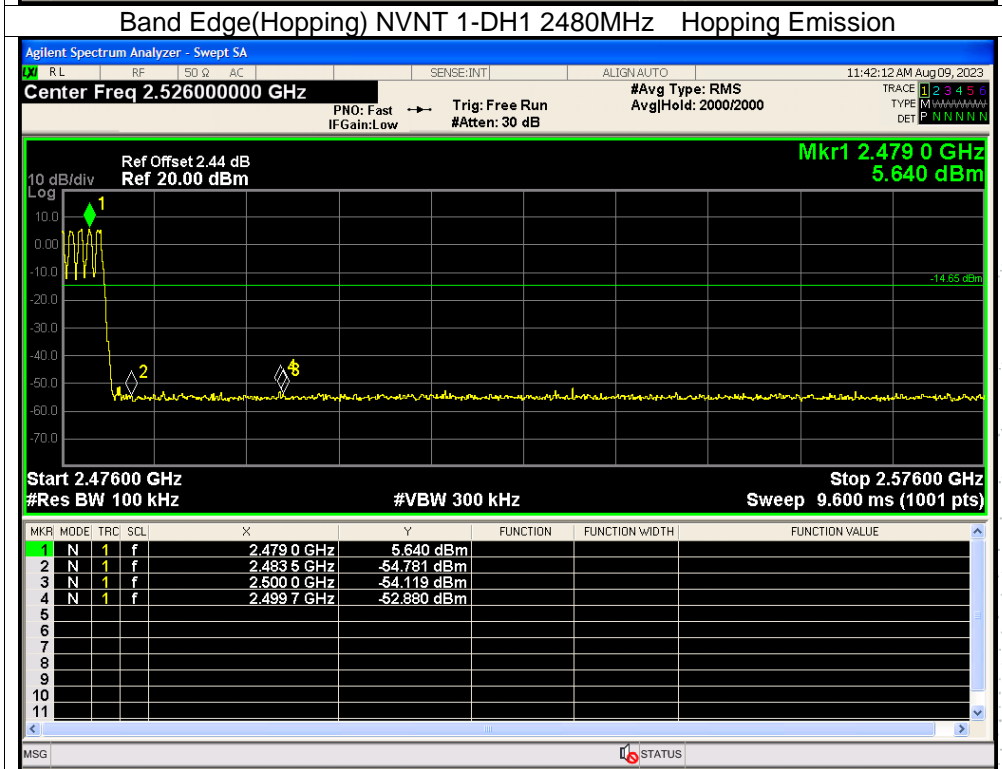
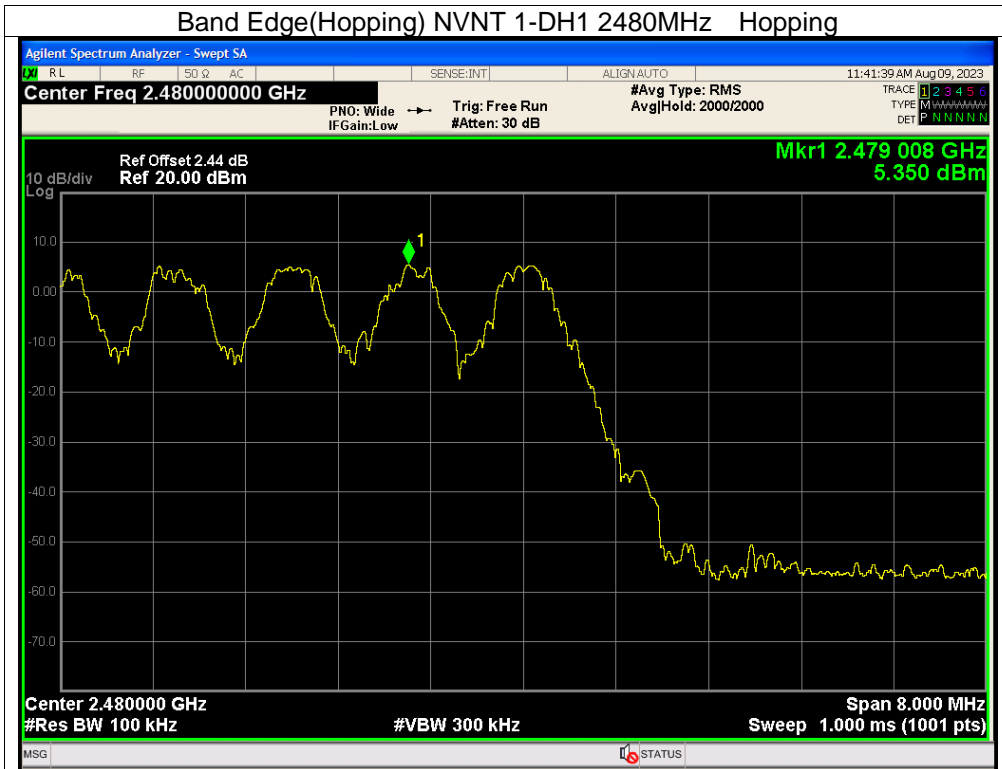

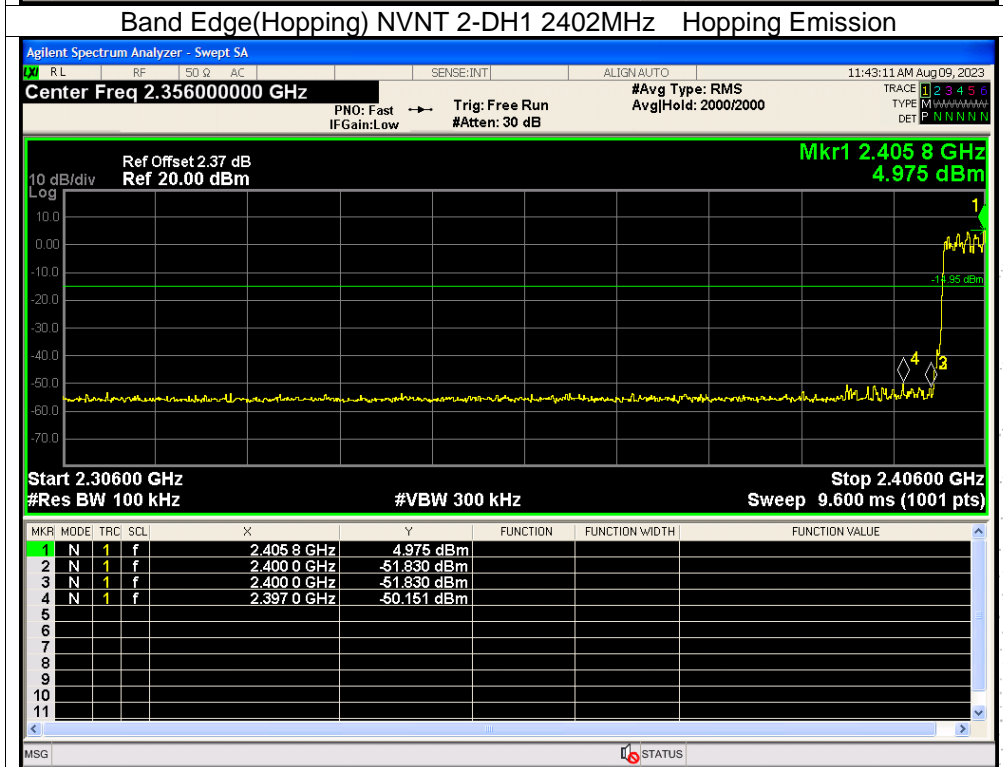
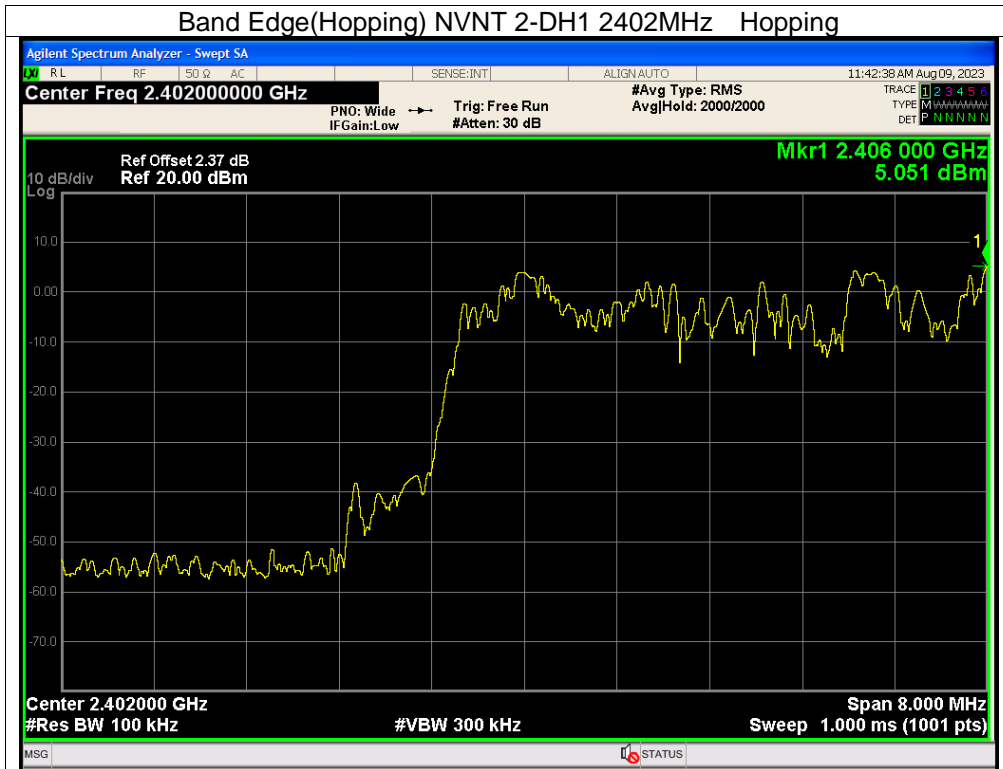

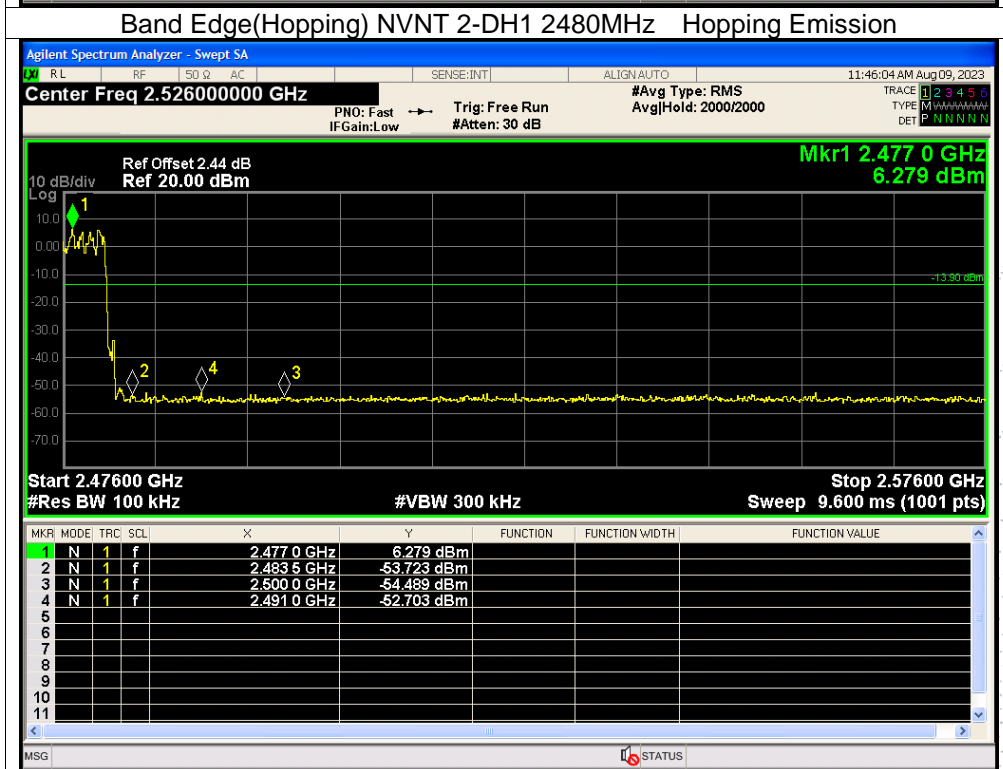

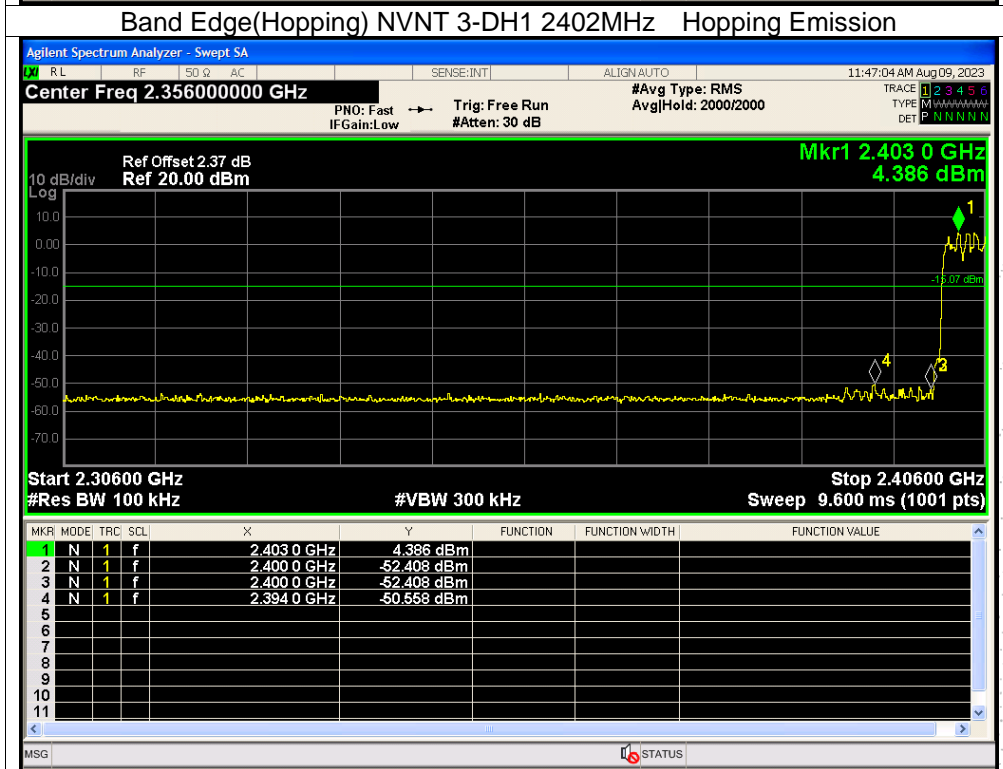
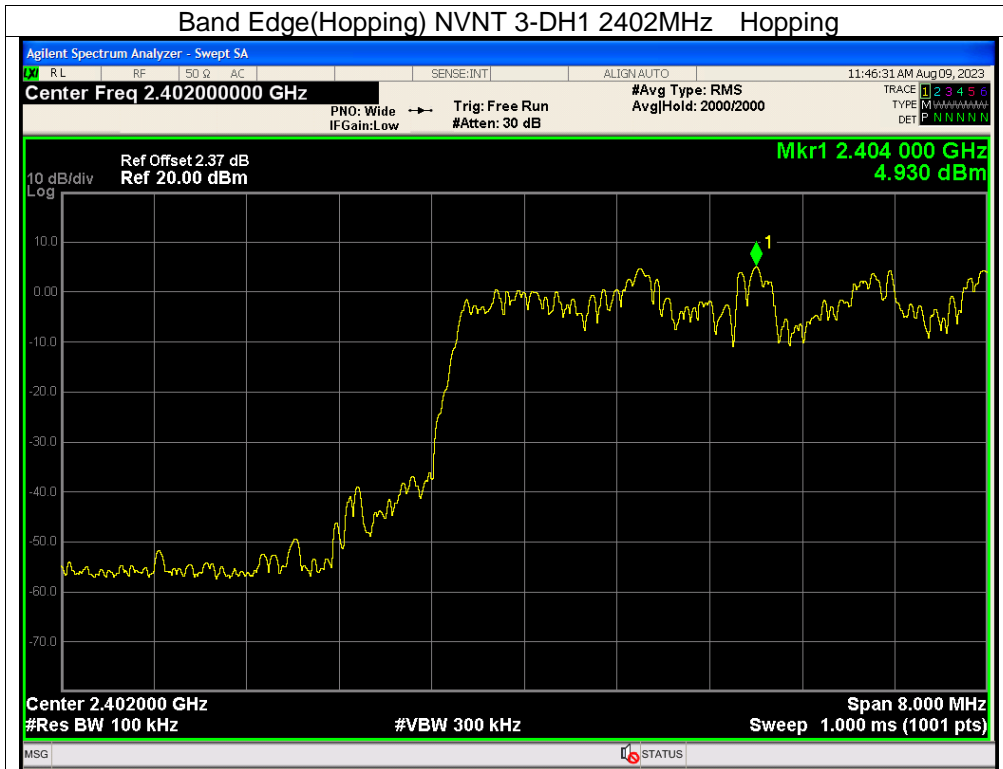

CO., LTD



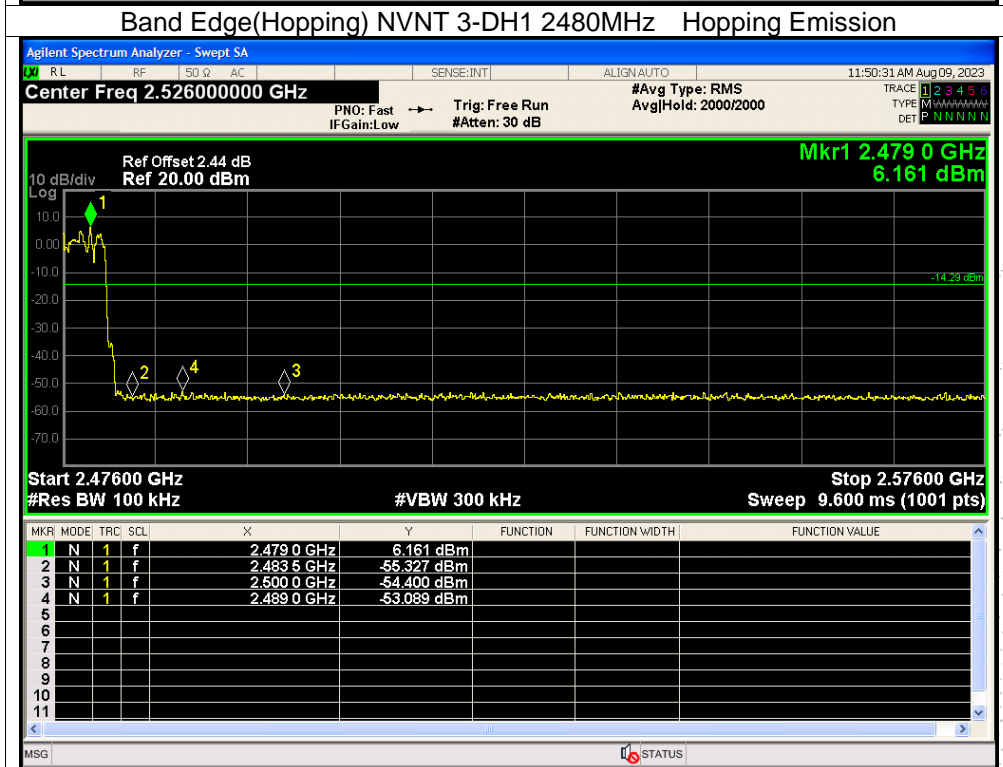
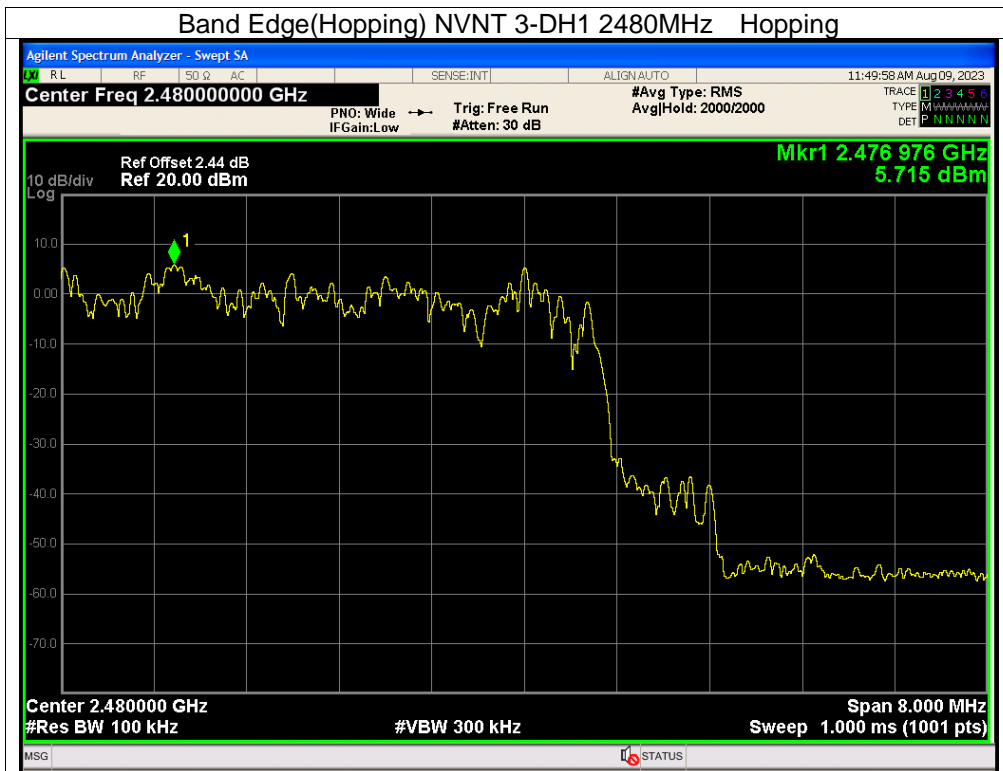

## 10. 20 dB Bandwidth

### 10.1 Block Diagram Of Test Setup



### 10.2 Limit

N/A

### 10.3 Test procedure

1. Set RBW = 30kHz.
2. Set the video bandwidth (VBW)  $\geq 3 \times$  RBW.
3. Detector = Peak.
4. Trace mode = max hold.
5. Sweep = auto couple.
6. Allow the trace to stabilize.
7. Measure the maximum width of the emission that is constrained by the frequencies associated with the two outermost amplitude points (upper and lower frequencies) that are attenuated by 6 dB relative to the maximum level measured in the fundamental emission.

### 10.4 Test Result

Temperature :	26°C	Relative Humidity :	54%
Test Voltage :	DC 3.3V	Remark	N/A

Condition	Mode	Frequency (MHz)	-20 dB Bandwidth (MHz)	Verdict
NVNT	1-DH1	2402	0.876	Pass
NVNT	1-DH1	2441	0.923	Pass
NVNT	1-DH1	2480	0.928	Pass
NVNT	2-DH1	2402	1.222	Pass
NVNT	2-DH1	2441	1.226	Pass
NVNT	2-DH1	2480	1.2	Pass
NVNT	3-DH1	2402	1.204	Pass
NVNT	3-DH1	2441	1.213	Pass
NVNT	3-DH1	2480	1.202	Pass

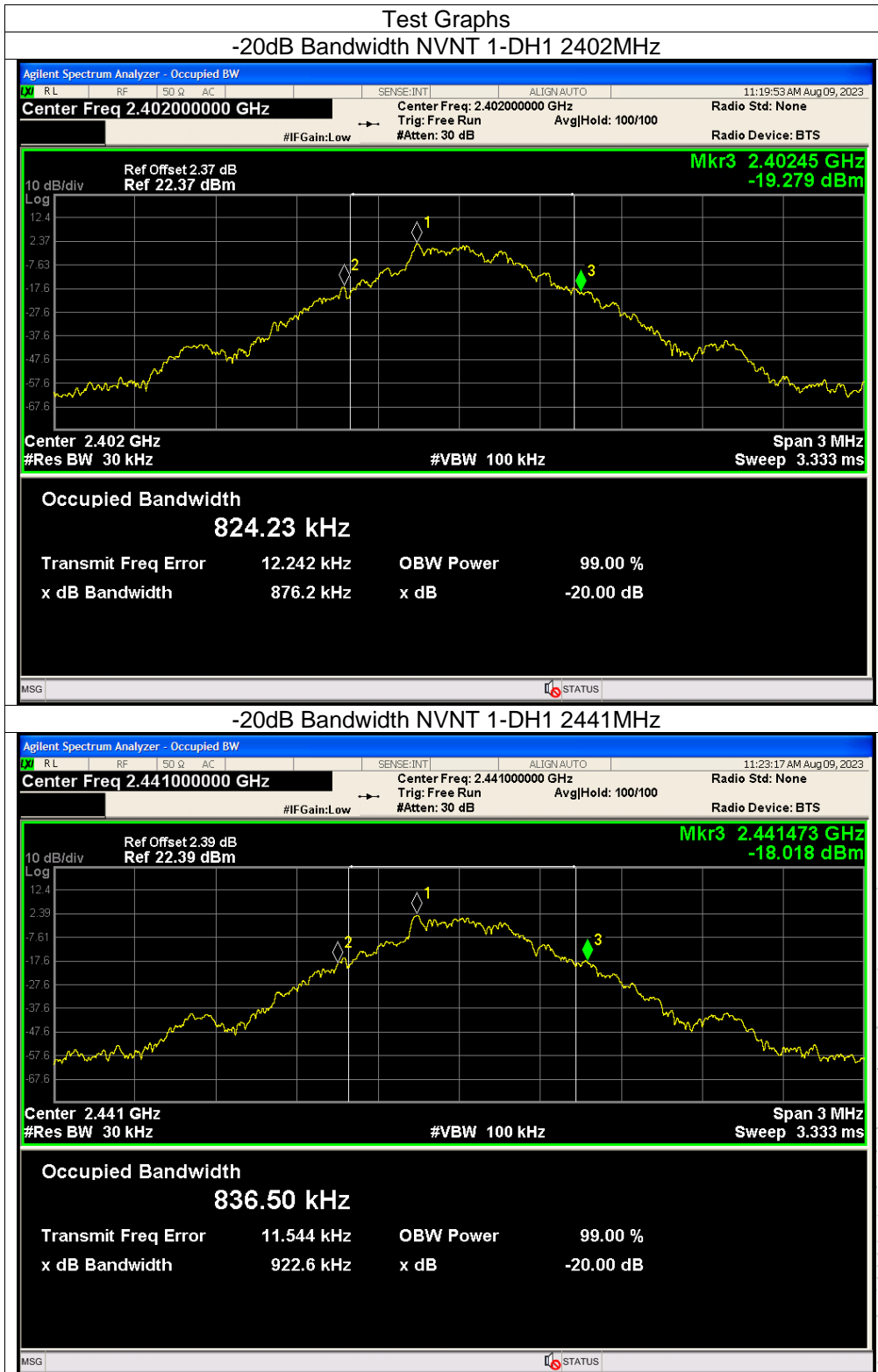

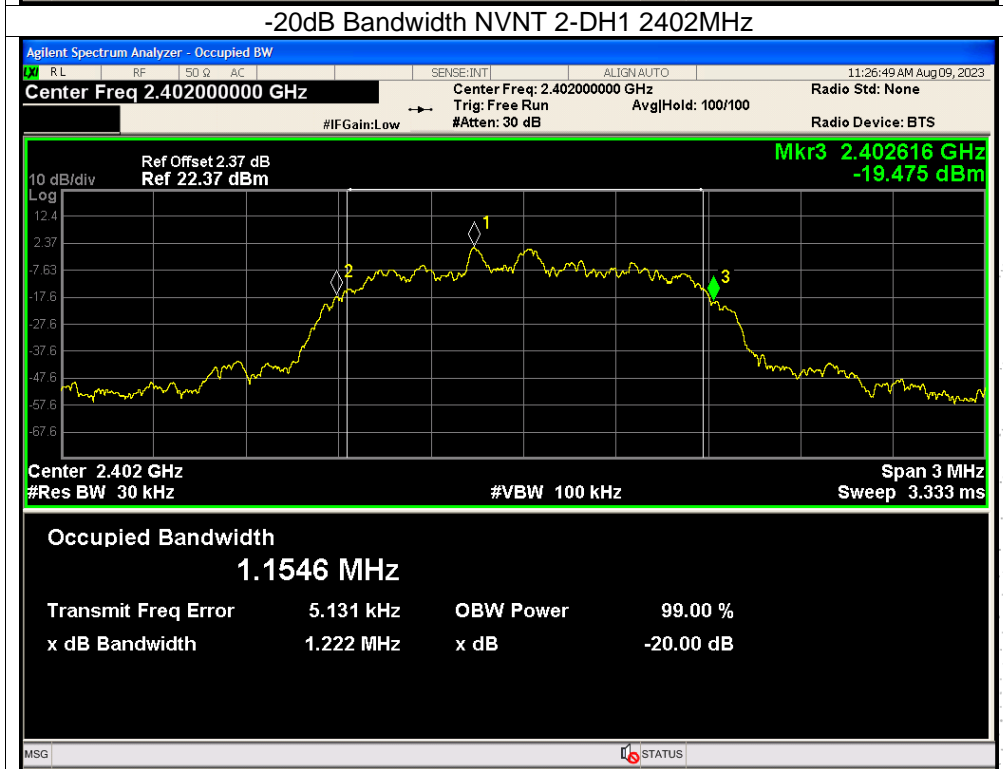
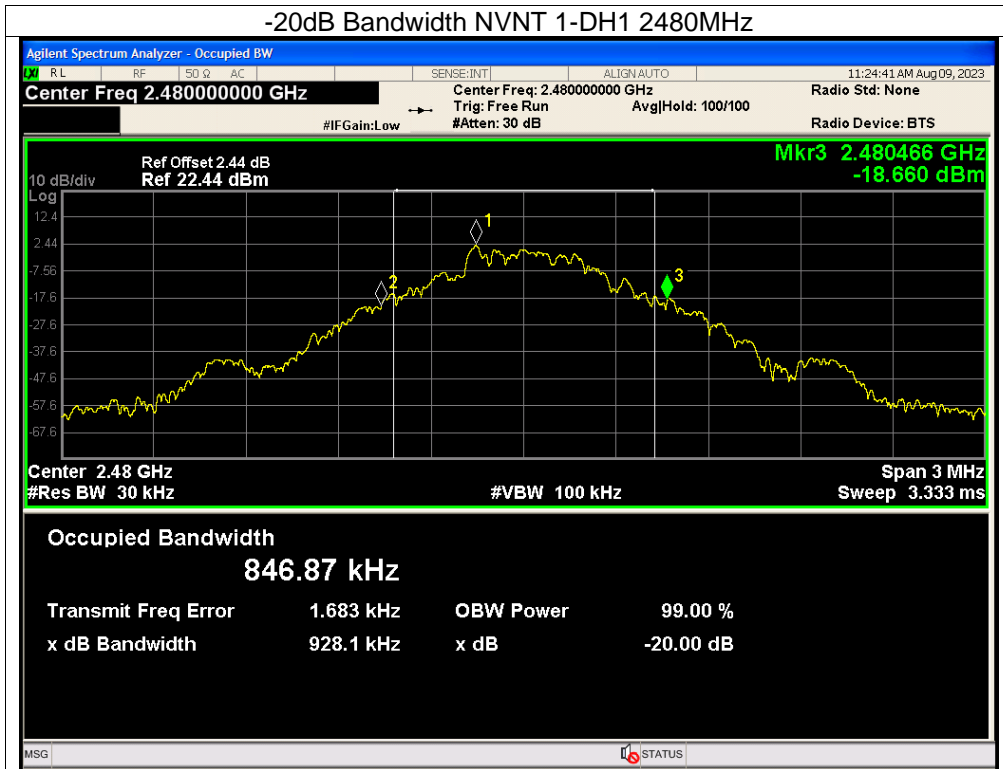

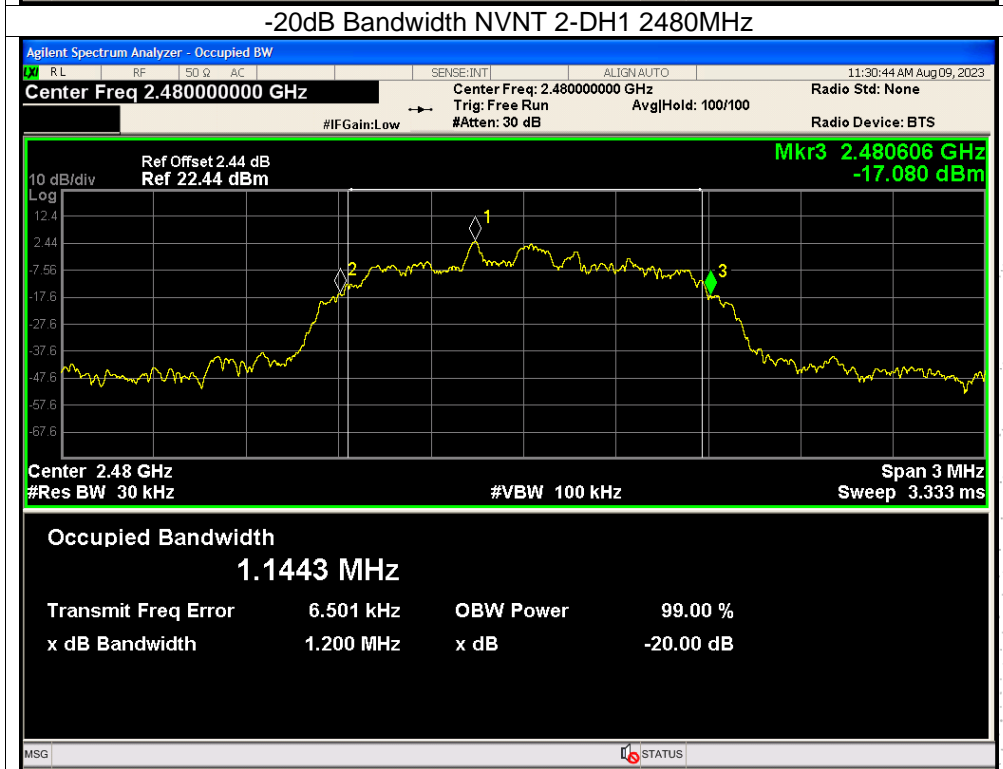
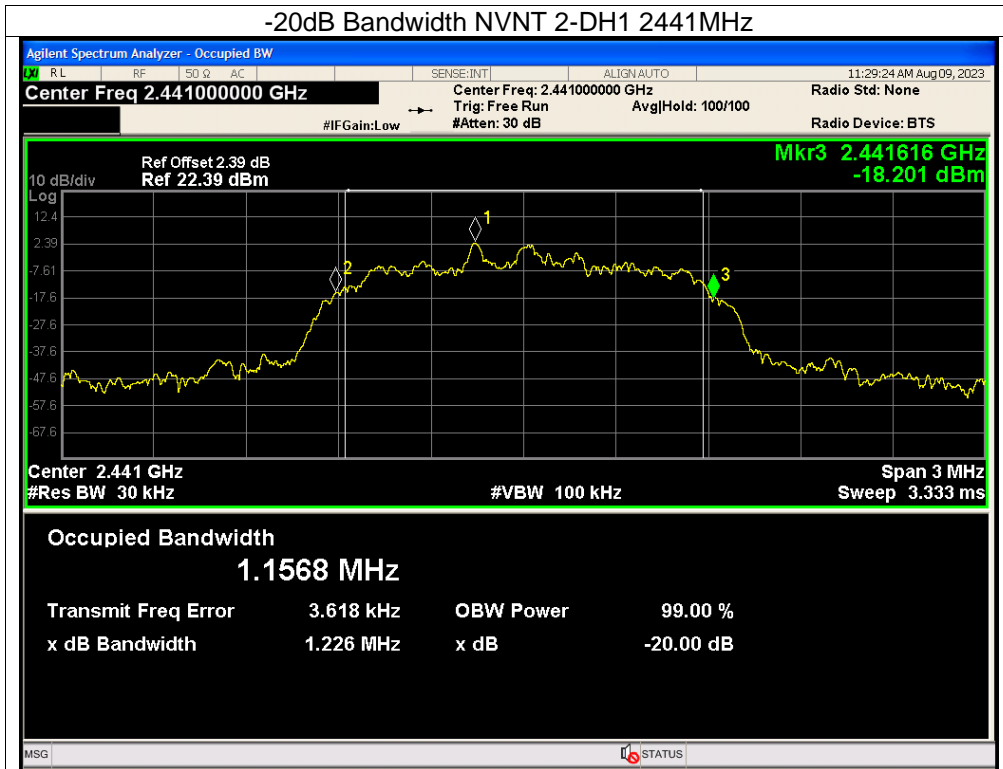

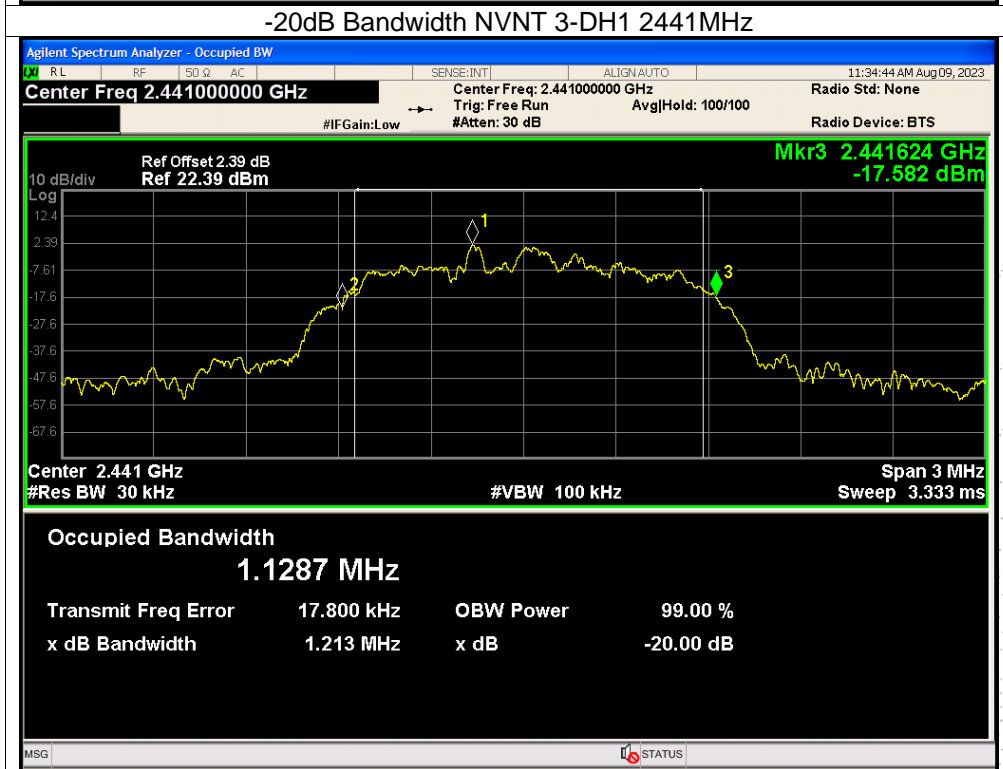
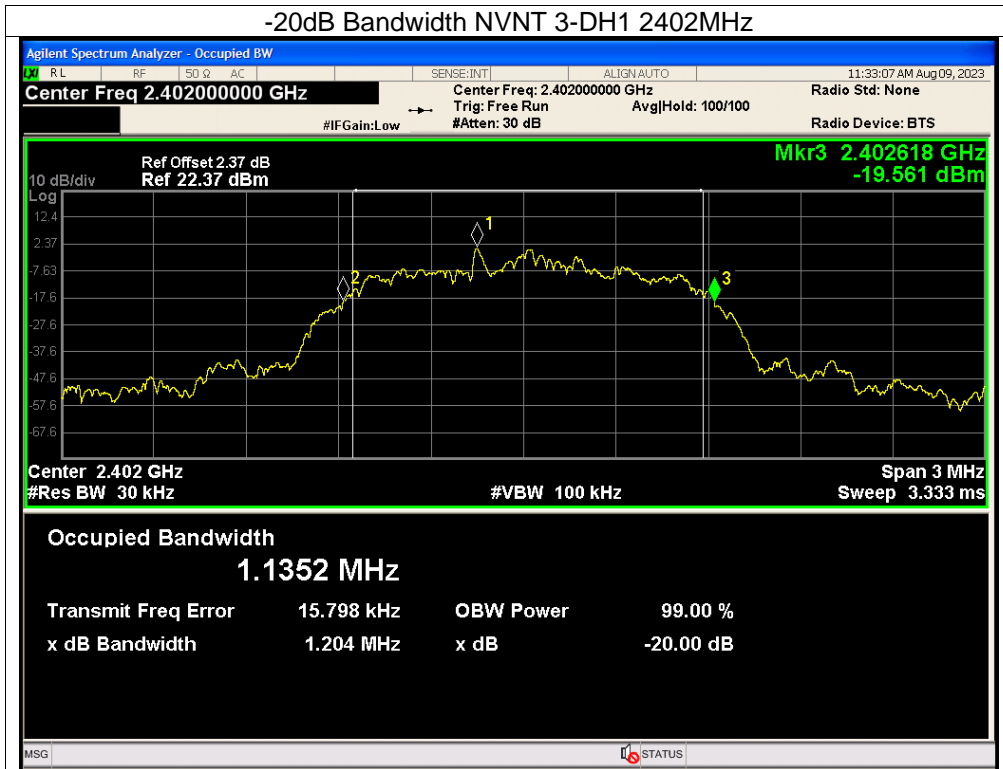

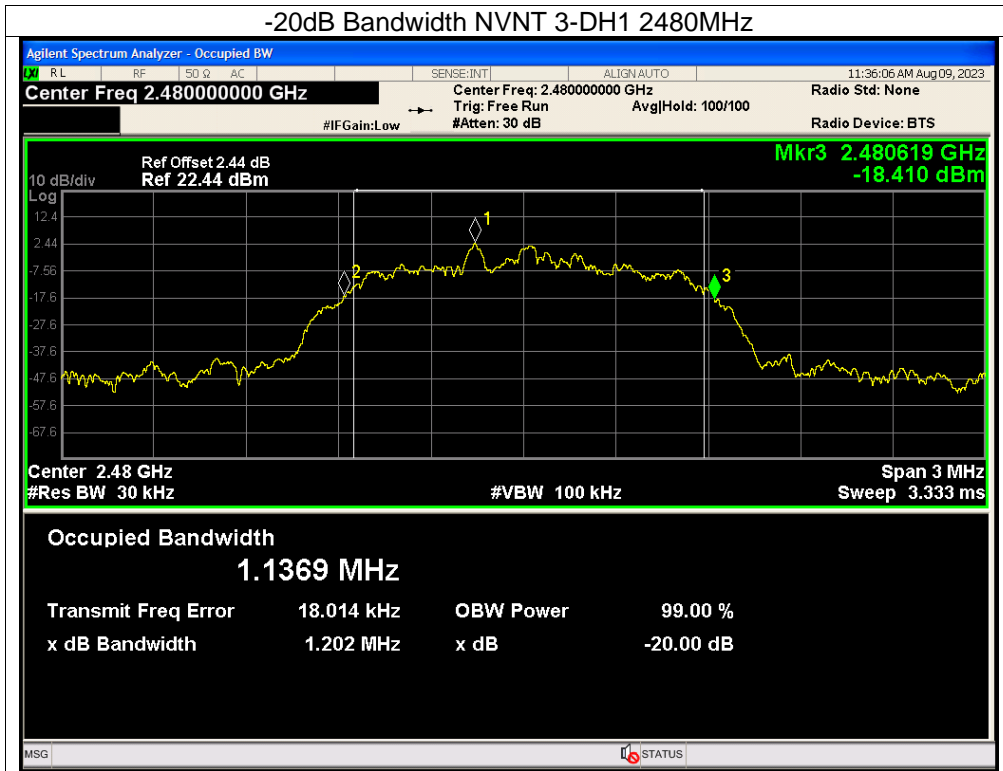

CO.LTD

