

TEST REPORT

Report No.: BCTC2105480474E

Applicant: CHINA DRAGON TECHNOLOGY LIMITED

Product Name: WLAN 11n USB 2T2R module

Model/Type
reference: CDW-N37603U-03

Tested Date: 2021-05-27 to 2021-05-31

Issued Date: 2021-05-31

Shenzhen BCTC Testing Co., Ltd.



FCC ID: ROW-N37603U03

Product Name: WLAN 11n USB 2T2R module
Trademark: N/A
Model/Type reference: CDW-N37603U-03
Prepared For: CHINA DRAGON TECHNOLOGY LIMITED
Address: B4 Bidg. haosan No.1 Industry Park, Shajing street, B Shenzhen, China
Manufacturer: CHINA DRAGON TECHNOLOGY LIMITED
Address: B4 Bidg. haosan No.1 Industry Park, Shajing street, B Shenzhen, China
Prepared By: Shenzhen BCTC Testing Co., Ltd.
Address: 1-2/F., Building B, Pengzhou Industrial Park, No.158, Fuyuan 1st Road, Tangwei, Fuhai Subdistrict, Bao'an District, Shenzhen, Guangdong, China
Sample Received Date: 2021-05-27
Sample tested Date: 2021-05-27 to 2021-05-31
Issue Date: 2021-05-31
Report No.: BCTC2105480474E
FCC Part15.247
ANSI C63.10:2013
Test Standards KDB 662911 D01 v02r01
558074 D01 15.247 Meas Guidance v05r02
Test Results PASS

Tested by:

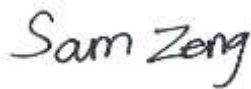

Sam zeng/Project Handler

Approved by:



Zero Zhou/Reviewer

The test report is effective only with both signature and specialized stamp. This result(s) shown in this report refer only to the sample(s) tested. Without written approval of Shenzhen BCTC Testing Co., Ltd, this report can't be reproduced except in full. The tested sample(s) and the sample information are provided by the client.

Table of Contents	Page
1 .VERSION	5
2 . SUMMARY OF TEST RESULTS	6
2.1 MEASUREMENT UNCERTAINTY	7
3 . GENERAL INFORMATION	8
3.1 GENERAL DESCRIPTION OF EUT	8
3.2 DESCRIPTION OF TEST MODES	10
3.3 BLOCK DIGRAM SHOWING THE CONFIGURATION OF SYSTEM TESTED	10
3.4 DESCRIPTION OF SUPPORT UNITS(CONDUCTED MODE)	11
3.5 EQUIPMENTS LIST FOR ALL TEST ITEMS	12
3.5.1TEST FACILITY	12
3.5.2 RADIATION TEST EQUIPMENT	12
4 . EMC EMISSION TEST	14
4.1 CONDUCTED EMISSION MEASUREMENT	14
4.1.1 POWER LINE CONDUCTED EMISSION LIMITS	14
4.1.2 TEST PROCEDURE	14
4.1.3 DEVIATION FROM TEST STANDARD	14
4.1.4 TEST SETUP	15
4.1.5 EUT OPERATING CONDITIONS	15
4.1.6 TEST RESULTS	16
4.2 RADIATED EMISSION MEASUREMENT	18
4.2.1 RADIATED EMISSION LIMITS	18
4.2.2 TEST PROCEDURE	19
4.2.3 DEVIATION FROM TEST STANDARD	19
4.2.4 TEST SETUP	20
4.2.5 EUT OPERATING CONDITIONS	21
4.2.6 TEST RESULTS (BETWEEN 9KHZ – 30 MHZ)	22
4.2.7 TEST RESULTS (BETWEEN 30MHZ – 1GHZ)	23
4.2.8 TEST RESULTS	25
4.3 RADIATED BAND EMISSION MEASUREMENT	29
4.3.1 TEST REQUIREMENT:	29
4.3.2 TEST PROCEDURE	29
4.3.3 DEVIATION FROM TEST STANDARD	30
4.3.4 TEST SETUP	30
4.3.5 EUT OPERATING CONDITIONS	30
5 . POWER SPECTRAL DENSITY TEST	33
5.1 APPLIED PROCEDURES / LIMIT	33

5.1.1 TEST PROCEDURE	33
5.1.2 DEVIATION FROM STANDARD	33
5.1.3 TEST SETUP	33
5.1.4 EUT OPERATION CONDITIONS	33
5.1.5 TEST RESULTS	34
6 . BANDWIDTH TEST	42
6.1 APPLIED PROCEDURES / LIMIT	42
6.1.1 TEST PROCEDURE	42
6.1.2 DEVIATION FROM STANDARD	42
6.1.3 TEST SETUP	42
6.1.4 EUT OPERATION CONDITIONS	42
6.1.5 TEST RESULTS	43
7 . PEAK OUTPUT POWER TEST	51
7.1 APPLIED PROCEDURES/LIMIT	51
7.1.1 TEST PROCEDURE	51
7.1.2 DEVIATION FROM STANDARD	51
7.1.3 TEST SETUP	51
7.1.4 EUT OPERATION CONDITIONS	51
7.1.5 TEST RESULTS	52
8 . 100 KHZ BANDWIDTH OF FREQUENCY BAND EDGE	53
8.1 APPLICABLE STANDARD	53
8.2 TEST PROCEDURE	53
8.3 DEVIATION FROM STANDARD	53
8.4 TEST SETUP	53
8.5 EUT OPERATION CONDITIONS	53
9 . DUTY CYCLE OF TEST SIGNAL	62
9.1 STANDARD REQUIREMENT	62
9.2 FORMULA:	62
10 . ANTENNA REQUIREMENT	65
10.1 STANDARD REQUIREMENT	65
10.2 EUT ANTENNA	65
11 . EUT PHOTOGRAPHS	66
12 . EUT TEST SETUP PHOTOGRAPHS	68
APPENDIX-PHOTOGRAPHS OF EUT CONSTRUCTIONAL DETAILS	

1.VERSION

Report No.	Issue Date	Description	Approved
BCTC2105480474E	2021-05-31	Original	Valid

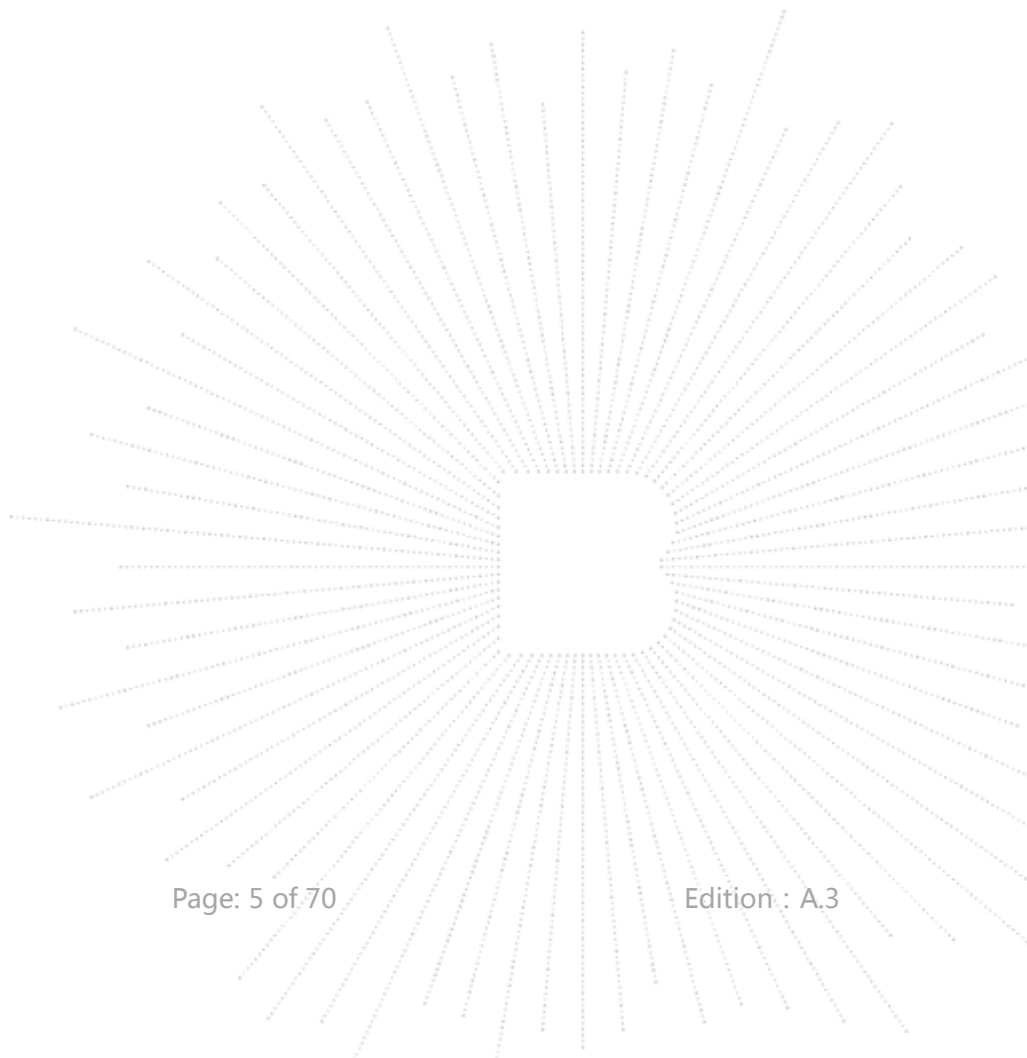

2. SUMMARY OF TEST RESULTS

Test procedures according to the technical standards:

FCC Part15 (15.247) , Subpart C			
Standard Section	Test Item	Judgment	Remark
15.207	Conducted Emission	PASS	
15.247 (a)(2)	6dB Bandwidth	PASS	
15.247 (b)	Peak Output Power	PASS	
15.247 (d) 15.209	Radiated Spurious Emission	PASS	
15.247 (e)	Power Spectral Density	PASS	
15.205	Restricted Band of Operation	PASS	
15.247 (d)	Band Edge (Out of Band Emissions)	PASS	
15.203	Antenna Requirement	PASS	

NOTE:

(1) "N/A" denotes test is not applicable in this Test Report

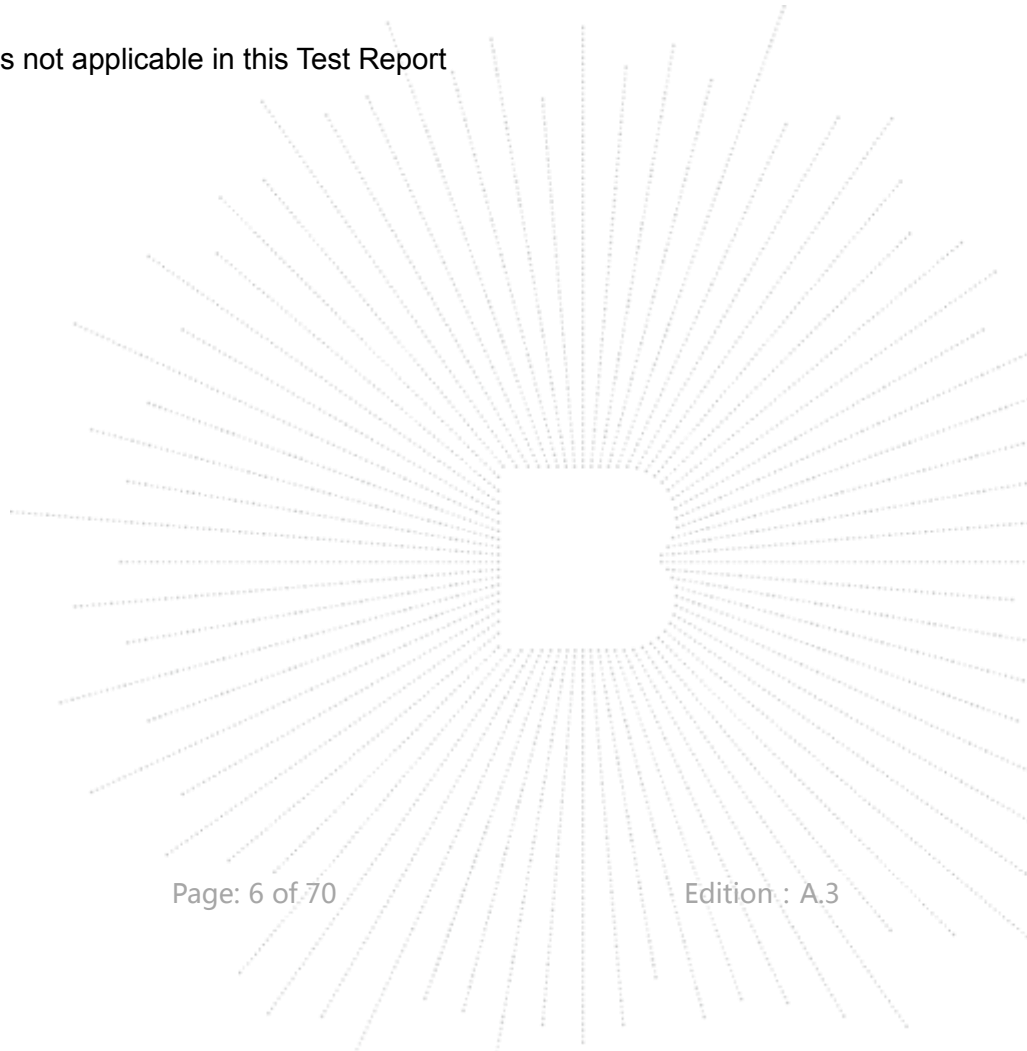

2.1 MEASUREMENT UNCERTAINTY

The reported uncertainty of measurement $y \pm U$, where expanded uncertainty U is based on a standard uncertainty multiplied by a coverage factor of $k=2$, providing a level of confidence of approximately **95** %.

No.	Item	Uncertainty
1	3m chamber Radiated spurious emission(30MHz-1GHz)	U=4.3dB
2	3m chamber Radiated spurious emission(9KHz-30MHz)	U=3.7dB
3	3m chamber Radiated spurious emission(1GHz-18GHz)	U=4.5dB
4	3m chamber Radiated spurious emission(18GHz-40GHz)	U=3.34dB
5	Conducted Emission (150kHz-30MHz)	U=3.20dB
6	Conducted Adjacent channel power	U=1.38dB
7	Conducted output power uncertainty Above 1G	U=1.576dB
8	Conducted output power uncertainty below 1G	U=1.28dB
9	humidity uncertainty	U=5.3%
10	Temperature uncertainty	U=0.59°C

3. GENERAL INFORMATION

3.1 GENERAL DESCRIPTION OF EUT

Model/Type reference:	CDW-N37603U-03
Model differences:	N/A
Hardware Version:	N/A
Software Version:	N/A
Operation Frequency:	802.11b/g/n20MHz:2412~2462 MHz 802.11n40MHz:2422~2452 MHz
Bit Rate of Transmitter	802.11b:11/5.5/2/1 Mbps 802.11g:54/48/36/24/18/12/9/6Mbps 802.11n Up to 300Mbps
Type of Modulation:	WIFI: OFDM/DSSS
Number Of Channel	802.11b/g/n20MHz:11 CH 802.11n40MHz: 7 CH
Antenna installation:	WIFI: IFA antenna*2
Antenna Gain:	WIFI: Antenna A:2.3dBi Antenna B:2.3dBi
Ratings:	DC 3.3V

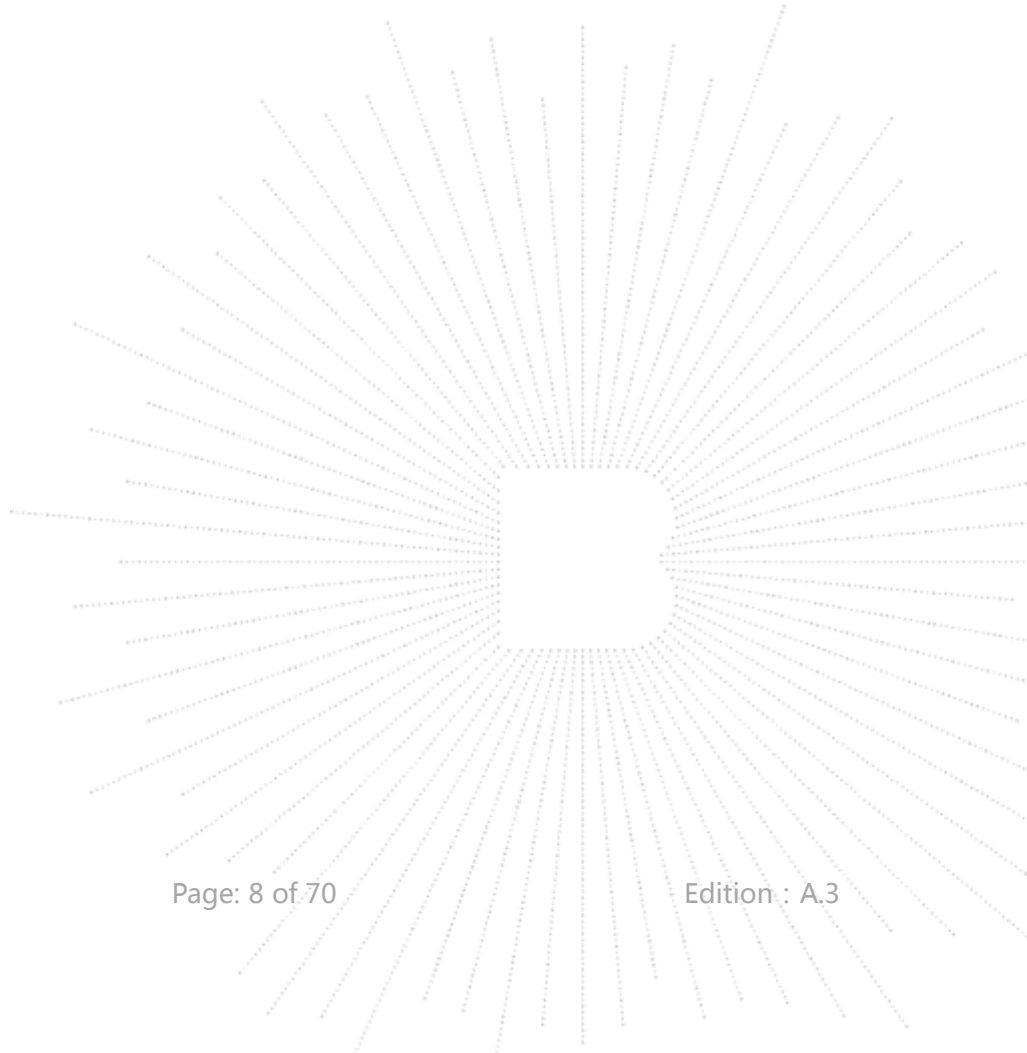

1.

Channel List for 802.11b/g/n(20)							
Channel	Frequency (MHz)	Channel	Frequency (MHz)	Channel	Frequency (MHz)	Channel	Frequency (MHz)
01	2412	04	2427	07	2442	10	2457
02	2417	05	2432	08	2447	11	2462
03	2422	06	2437	09	2452		
Channel List for 802.11n(40)							
Channel	Frequency (MHz)	Channel	Frequency (MHz)	Channel	Frequency (MHz)	Channel	Frequency (MHz)
03	2422	05	2432	07	2442	09	2452
04	2427	06	2437	08	2447		

2

Table for IFA antenna

Ant.	Brand	Model Name	Antenna Type	Gain (dBi)	NOTE
A	N/A	N/A	IFA antenna	2.3	N/A
B	N/A	N/A	IFA antenna	2.3	N/A

EUT has two IFA antennas with Max gain GANT 2.3dBi on every antenna, CDD device with two spatial streams, also can operate with one spatial streams according to KDB662911 D01 v02r01, Directional gain= GANT + Array Gain, where Array Gain is as follows.

1) For power spectral density(PSD) measurements,
 Array Gain= $10\log(N_{ANT}/N_{SS})\text{dB}=10\log(2/1)=3.01\text{dB}$,
 So the directional gain for PSD is 5.31dBi

2) For power measurements,
 Array Gain= $10\log(N_{ANT}/N_{SS})\text{dB}=10\log(2/1)=3.01\text{dB}$,
 So the directional gain for Power measurements is 5.31dBi

3.2 DESCRIPTION OF TEST MODES

Pretest Mode	Description
Mode 1	802.11b CH1/ CH6/ CH11
Mode 2	802.11g CH1/ CH6/ CH11
Mode 3	802.11n20 CH1/ CH6/ CH11
Mode 4	802.11n40 CH3/ CH6/ CH9
Mode 5	Link Mode

Conducted Emission	
Final Test Mode	Description
Mode 5	Link Mode

For Radiated Emission	
Final Test Mode	Description
Mode 1	802.11b CH1/ CH6/ CH11
Mode 2	802.11g CH1/ CH6/ CH11
Mode 3	802.11n20 CH1/ CH6/ CH11
Mode 4	802.11n40 CH3/ CH6/ CH9

Note:

- (1) The measurements are performed at all Bit Rate of Transmitter, the worst data was reported.

3.3 BLOCK DIGRAM SHOWING THE CONFIGURATION OF SYSTEM TESTED

Conducted Emission Test

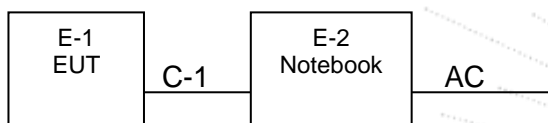

Radiated Spurious Emission

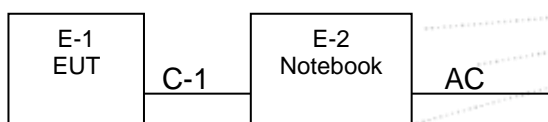

3.4 DESCRIPTION OF SUPPORT UNITS(CONDUCTED MODE)

The EUT has been tested as an independent unit together with other necessary accessories or support units. The following support units or accessories were used to form a representative test configuration during the tests.

No.	Device Type	Brand	Model	Series No.	Note
E-1	WLAN 11n USB 2T2R module	N/A	CDW-N37603U-03	N/A	EUT
E-2	Notebook	N/A	NOTE001	N/A	EUT

Item	Shielded Type	Ferrite Core	Length	Note
C-1	NO	NO	0.2M	DC cable unshielded

Note:

- (1) The support equipment was authorized by Declaration of Confirmation.
- (2) For detachable type I/O cable should be specified the length in cm in 『Length』 column.

3.5 EQUIPMENTS LIST FOR ALL TEST ITEMS

3.5.1 TEST FACILITY

All measurement facilities used to collect the measurement data are located at Shenzhen BCTC Testing Co., Ltd. Address: 1-2/F., Building B, Pengzhou Industrial Park, No.158, Fuyuan 1st Road, Tangwei, Fuhai Subdistrict, Bao'an District, Shenzhen, Guangdong, China. The site and apparatus are constructed in conformance with the requirements of ANSI C63.4 and CISPR 16-1-1 other equivalent standards.

FCC Test Firm Registration Number: 712850

IC Registered No.: 23583

3.5.2 RADIATION TEST EQUIPMENT

Item	Equipment	Manufacturer	Type No.	Serial No.	Last calibration	Calibrated until
1	Spectrum Analyzer (9kHz-26.5GHz)	Agilent	E4407B	MY45109572	Jun. 08, 2020	Jun. 07, 2021
2	Test Receiver (9kHz-7GHz)	R&S	ESR7	101154	Jun. 08, 2020	Jun. 07, 2021
3	Bilog Antenna (30MHz-3GHz)	SCHWARZBECK	VULB9163	VULB9163-942	Jun. 08, 2020	Jun. 07, 2021
4	Horn Antenna (1GHz-18GHz)	SCHWARZBECK	BBHA9120D	1541	Jun. 10, 2020	Jun. 09, 2021
5	Horn Antenna (18GHz-40GHz)	SCHWARZBECK	BBHA9170	00822	Jun. 10, 2020	Jun. 09, 2021
6	Amplifier (9KHz-6GHz)	SCHWARZBECK	BBV9744	9744-0037	Jun. 04, 2020	Jun. 03, 2021
7	Amplifier (0.5GHz-18GHz)	SCHWARZBECK	BBV9718	9718-309	Jun. 04, 2020	Jun. 03, 2021
8	Amplifier (18GHz-40GHz)	MITEQ	TTA1840-35-HG	2034381	Jun. 08, 2020	Jun. 07, 2021
9	Loop Antenna (9KHz-30MHz)	SCHWARZBECK	FMZB1519B	00014	Jun. 08, 2020	Jun. 07, 2021
10	RF cables1 (9kHz-30MHz)	Huber+Suhnar	9kHz-30MHz	B1702988-0008	Jun. 08, 2020	Jun. 07, 2021
11	RF cables2 (30MHz-1GHz)	Huber+Suhnar	30MHz-1GHz	1486150	Jun. 08, 2020	Jun. 07, 2021
12	RF cables3 (1GHz-40GHz)	Huber+Suhnar	1GHz-40GHz	1607106	Jun. 08, 2020	Jun. 07, 2021
13	Power Metter	Keysight	E4419B	\	Jun. 08, 2020	Jun. 07, 2021
14	Power Sensor (AV)	Keysight	E9 300A	\	Jun. 08, 2020	Jun. 07, 2021
15	Signal Analyzer 20kHz-26.5GHz	KEYSIGHT	N9020A	MY49100060	Jun. 04, 2020	Jun. 03, 2021
16	Spectrum Analyzer 9kHz-40GHz	Agilent	FSP40	100363	Jun. 13, 2020	Jun. 12, 2021
17	D.C. Power Supply	LongWei	TPR-6405D	\	\	\
18	Software	Frad	EZ-EMC	FA-03A2 RE	\	\

Conduction Test equipment

Item	Equipment	Manufacturer	Type No.	Serial No.	Last calibration	Calibrated until
1	Test Receiver	R&S	ESR3	102075	Jun. 08, 2020	Jun. 07, 2021
2	LISN	SCHWARZBECK	NSLK8127	8127739	Jun. 13, 2020	Jun. 12, 2021
3	LISN	R&S	ENV216	101375	Jun. 04, 2020	Jun. 03, 2021
4	RF cables	Huber+Suhnar	9kHz-30MHz	B1702988-0008	Jun. 08, 2020	Jun. 07, 2021
5	Software	Frad	EZ-EMC	EMC-CON 3A1	\	\

RF conducted test

Item	Equipment	Manufacturer	Type No.	Serial No.	Last calibration	Calibrated until
1	Power Metter	Keysight	E4419B	\	Jun. 08, 2020	Jun. 07, 2021
2	Power Sensor (AV)	Keysight	E9 300A	\	Jun. 08, 2020	Jun. 07, 2021
3	Signal Analyzer 20kHz-26.5GHz	KEYSIGHT	N9020A	MY49100060	Jun. 04, 2020	Jun. 03, 2021
4	Spectrum Analyzer 9kHz-40GHz	Agilent	FSP40	100363	Jun. 13, 2020	Jun. 12, 2021

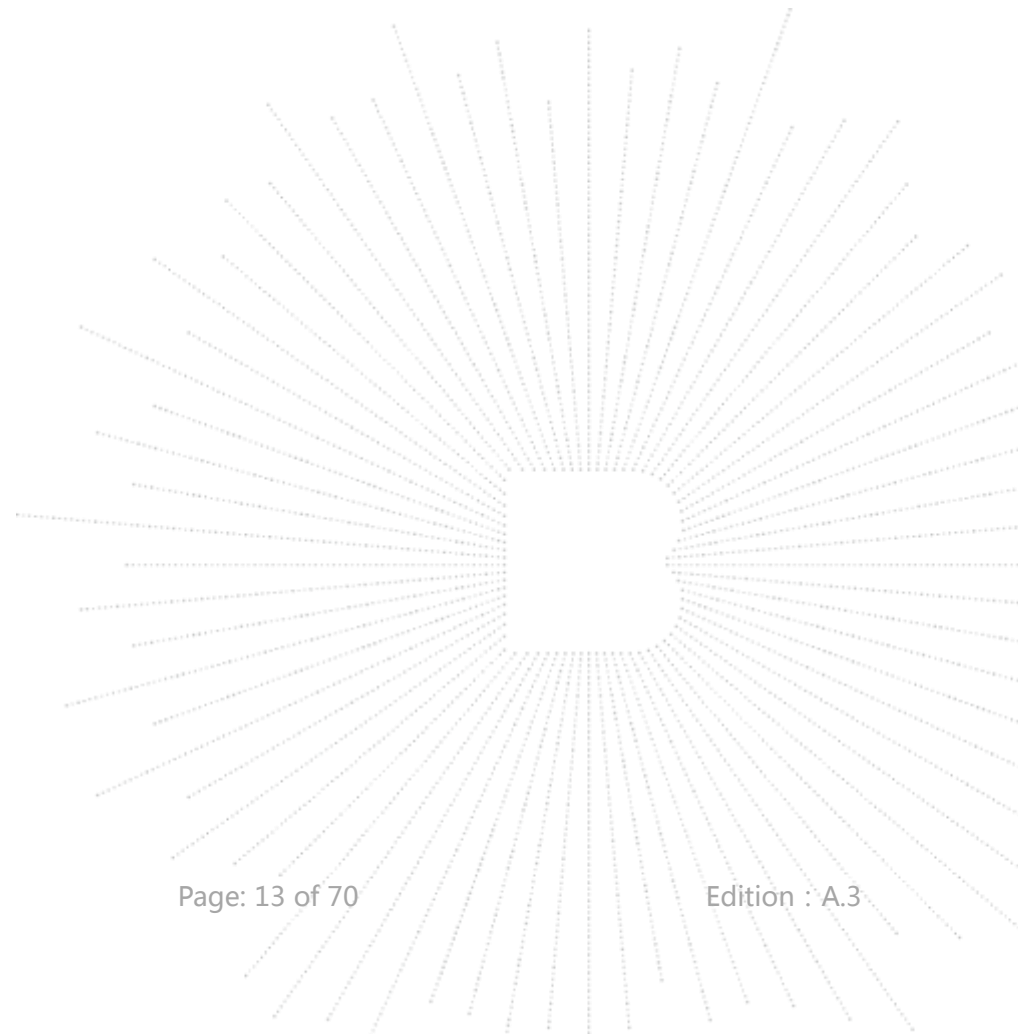

4. EMC EMISSION TEST

4.1 CONDUCTED EMISSION MEASUREMENT

4.1.1 POWER LINE CONDUCTED EMISSION Limits (Frequency Range 150KHz-30MHz)

FREQUENCY (MHz)	Limit (dBuV)		Standard
	Quasi-peak	Average	
0.15 -0.5	66 - 56 *	56 - 46 *	FCC
0.50 -5.0	56.00	46.00	FCC
5.0 -30.0	60.00	50.00	FCC

Note:

- (1) The tighter limit applies at the band edges.
- (2) The limit of " * " marked band means the limitation decreases linearly with the logarithm of the frequency in the range.

The following table is the setting of the receiver

Receiver Parameters	Setting
Attenuation	10 dB
Start Frequency	0.15 MHz
Stop Frequency	30 MHz
IF Bandwidth	9 kHz

4.1.2 TEST PROCEDURE

- a. The EUT was placed 0.8 meters from the horizontal ground plane with EUT being connected to the power mains through a line impedance stabilization network (LISN). All other support equipments powered from additional LISN(s). The LISN provide 50 Ohm/ 50uH of coupling impedance for the measuring instrument.
- b. Interconnecting cables that hang closer than 40 cm to the ground plane shall be folded back and forth in the center forming a bundle 30 to 40 cm long.
- c. I/O cables that are not connected to a peripheral shall be bundled in the center. The end of the cable may be terminated, if required, using the correct terminating impedance. The overall length shall not exceed 1 m.
- d. LISN at least 80 cm from nearest part of EUT chassis.
- e. For the actual test configuration, please refer to the related Item –EUT Test Photos.

4.1.3 DEVIATION FROM TEST STANDARD

No deviation

4.1.4 TEST SETUP

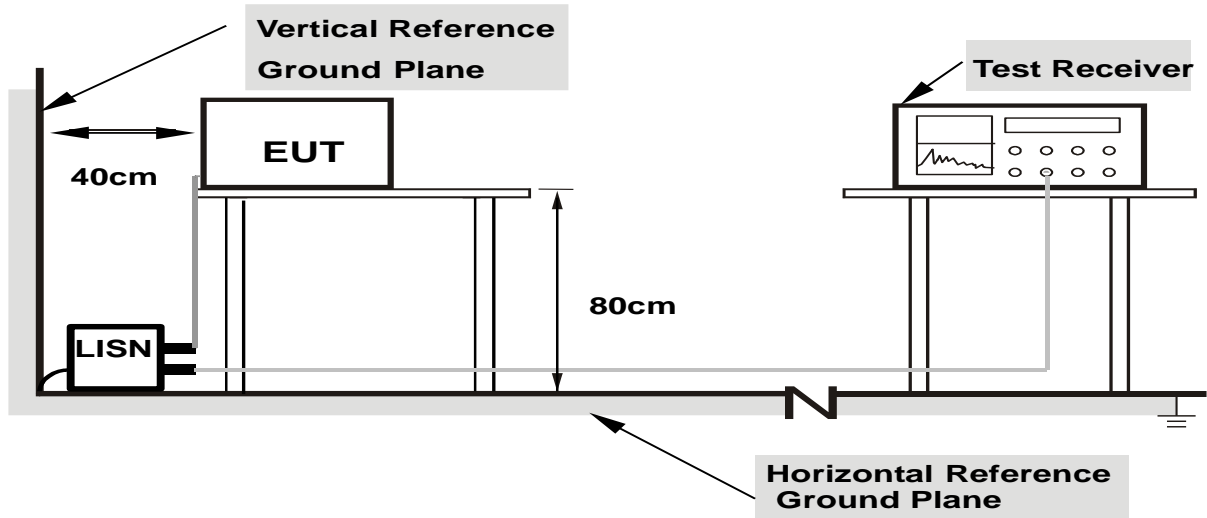

- Note:**
- 1.Support units were connected to second LISN.
 - 2.Both of LISNs (AMN) are 80 cm from EUT and at least 80 from other units and other metal planes

4.1.5 EUT OPERATING CONDITIONS

The EUT was configured for testing in a typical fashion (as a customer would normally use it). The EUT has been programmed to continuously transmit during test. This operating condition was tested and used to collect the included data.

We pretest AC 120V and AC 240V, the worst voltage was AC 120V and the data recording in the report.

4.1.6 TEST RESULTS

Temperature :	26 °C	Relative Humidity :	54%
Pressure :	101kPa	Phase :	L
Test Voltage :	AC 120V/60Hz	Test Mode :	Mode 5

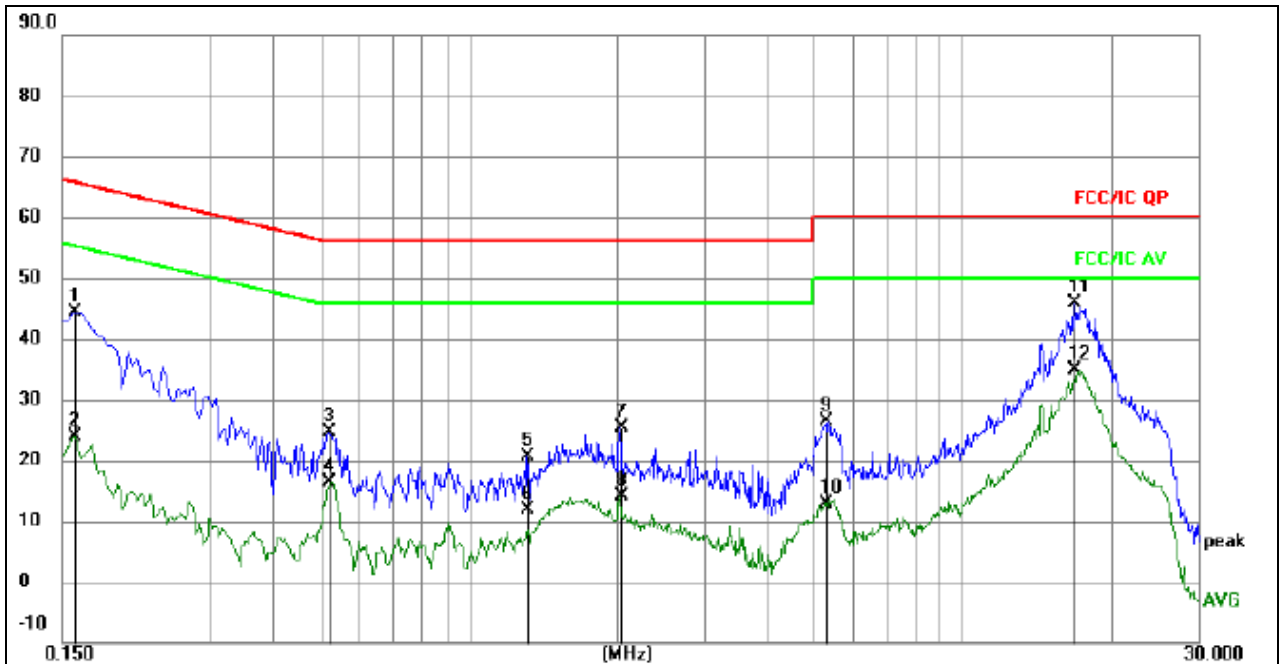

Remark:

1. All readings are Quasi-Peak and Average values.
2. Factor = Insertion Loss + Cable Loss.

No.	Mk.	Freq. MHz	Reading Level dB	Correct Factor dB	Measure- ment dBuV	Limit dBuV	Over dB	Detector
1		0.1590	34.84	9.51	44.35	65.52	-21.17	QP
2		0.1590	14.30	9.51	23.81	55.52	-31.71	AVG
3		0.5190	14.86	9.67	24.53	56.00	-31.47	QP
4		0.5190	6.67	9.67	16.34	46.00	-29.66	AVG
5		1.3154	10.98	9.58	20.56	56.00	-35.44	QP
6		1.3154	2.42	9.58	12.00	46.00	-34.00	AVG
7		2.0264	15.78	9.59	25.37	56.00	-30.63	QP
8		2.0264	4.51	9.59	14.10	46.00	-31.90	AVG
9		5.2755	16.68	9.79	26.47	60.00	-33.53	QP
10		5.2755	3.15	9.79	12.94	50.00	-37.06	AVG
11	*	16.7730	36.23	9.73	45.96	60.00	-14.04	QP
12		16.7730	25.25	9.73	34.98	50.00	-15.02	AVG

Temperature :	26 °C	Relative Humidity :	54%
Pressure :	101kPa	Phase :	N
Test Voltage :	AC 120V/60Hz	Test Mode :	Mode 5

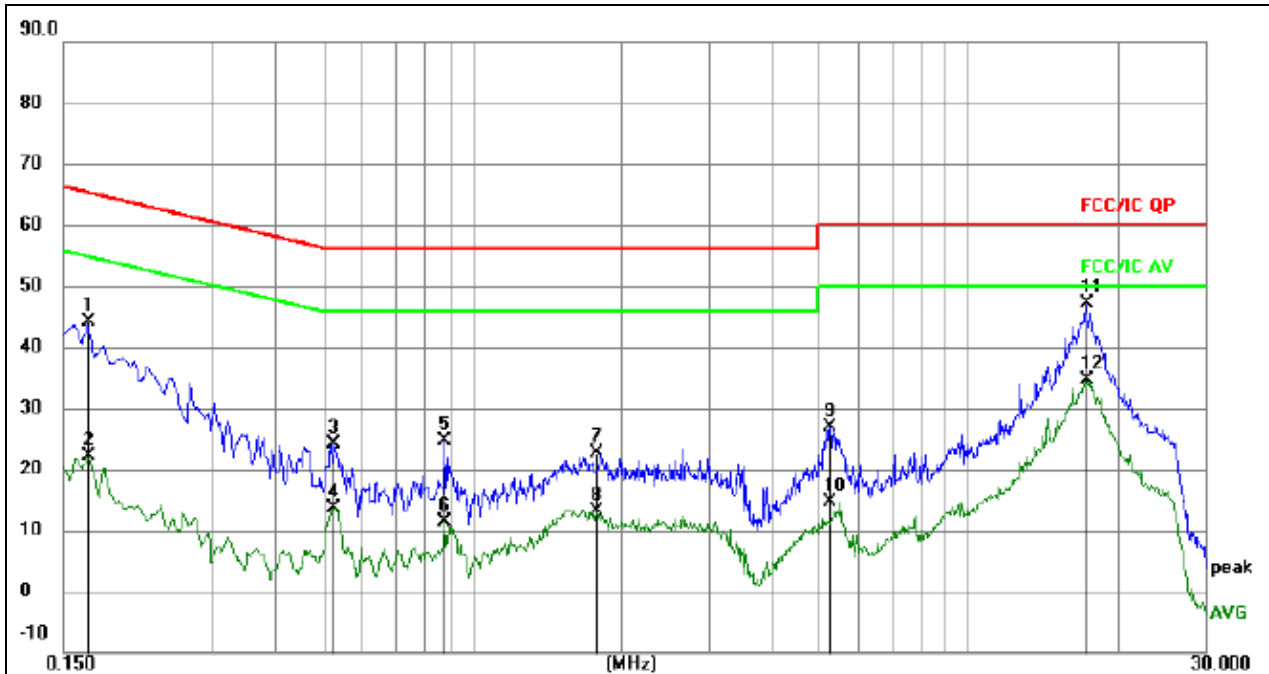

Remark:

1. All readings are Quasi-Peak and Average values.
2. Factor = Insertion Loss + Cable Loss.

No.	Mk.	Freq. MHz	Reading Level	Correct Factor dB	Measure- ment dBuV	Limit dBuV	Over dB	Detector
1		0.1677	34.52	9.50	44.02	65.07	-21.05	QP
2		0.1677	12.60	9.50	22.10	55.07	-32.97	AVG
3		0.5265	14.49	9.70	24.19	56.00	-31.81	QP
4		0.5265	3.90	9.70	13.60	46.00	-32.40	AVG
5		0.8803	14.96	9.61	24.57	56.00	-31.43	QP
6		0.8803	1.86	9.61	11.47	46.00	-34.53	AVG
7		1.7810	13.03	9.59	22.62	56.00	-33.38	QP
8		1.7810	3.63	9.59	13.22	46.00	-32.78	AVG
9		5.2490	17.11	9.79	26.90	60.00	-33.10	QP
10		5.2490	4.90	9.79	14.69	50.00	-35.31	AVG
11	*	17.1994	37.34	9.74	47.08	60.00	-12.92	QP
12		17.1994	24.81	9.74	34.55	50.00	-15.45	AVG

4.2 RADIATED EMISSION MEASUREMENT

4.2.1 RADIATED EMISSION LIMITS (Frequency Range 9kHz-1000MHz)

20dBc in any 100 kHz bandwidth outside the operating frequency band. In case the emission fall within the restricted band specified on 15.205(a), then the 15.209(a) limit in the table below has to be followed.

Frequencies (MHz)	Field Strength (micorvolts/meter)	Measurement Distance (meters)
0.009~0.490	2400/F(KHz)	300
0.490~1.705	24000/F(KHz)	30
1.705~30.0	30	30
30~88	100	3
88~216	150	3
216~960	200	3
Above 960	500	3

LIMITS OF RADIATED EMISSION MEASUREMENT (Above 1000MHz)

FREQUENCY (MHz)	Limit (dBuV/m) (at 3M)	
	PEAK	AVERAGE
Above 1000	74	54

Notes:

- (1) The limit for radiated test was performed according to FCC PART 15C.
- (2) The tighter limit applies at the band edges.
- (3) Emission level (dBuV/m)=20log Emission level (uV/m).

Spectrum Parameter	Setting
Attenuation	Auto
Start Frequency	1000 MHz
Stop Frequency	25GHz
RB / VB (emission in restricted band)	1 MHz / 1 MHz for Peak, 1 MHz / 10Hz for Average

Receiver Parameter	Setting
Attenuation	Auto
Start ~ Stop Frequency	9kHz~150kHz / RB 200Hz for QP
Start ~ Stop Frequency	150kHz~30MHz / RB 9kHz for QP
Start ~ Stop Frequency	30MHz~1000MHz / RB 120kHz for QP

4.2.2 TEST PROCEDURE

Below 1GHz test procedure as below:

- a. The EUT was placed on the top of a rotating table 0.8 meters above the ground at a 3 meter semi-anechoic chamber. The table was rotated 360 degrees to determine the position of the highest radiation.
- b. The EUT was set 3 meters away from the interference-receiving antenna, which was mounted on the top of a variable-height antenna tower.
- c. The antenna height is varied from one meter to four meters above the ground to determine the maximum value of the field strength. Both horizontal and vertical polarizations of the antenna are set to make the measurement.
- d. For each suspected emission, the EUT was arranged to its worst case and then the antenna was tuned to heights from 1 meter to 4 meters (for the test frequency of below 30MHz, the antenna was tuned to heights 1 meter) and the rotatable table was turned from 0 degrees to 360 degrees to find the maximum reading.
- e. The test-receiver system was set to Peak Detect Function and Specified Bandwidth with Maximum Hold Mode.
- f. If the emission level of the EUT in peak mode was 10dB lower than the limit specified, then testing could be stopped and the peak values of the EUT would be reported. Otherwise the emissions that did not have 10dB margin would be re-tested one by one using peak, quasi-peak or average method as specified and then reported in a data sheet.

Above 1GHz test procedure as below:

- g. Different between above is the test site, change from Semi- Anechoic Chamber to fully Anechoic Chamber and change form table 0.8 metre to 1.5 metre(Above 18GHz the distance is 1 meter and table is 1.5 metre).
- h. Test the EUT in the lowest channel ,the middle channel ,the Highest channel

Note:

Both horizontal and vertical antenna polarities were tested and performed pretest to three orthogonal axis. The worst case emissions were reported

4.2.3 DEVIATION FROM TEST STANDARD

No deviation

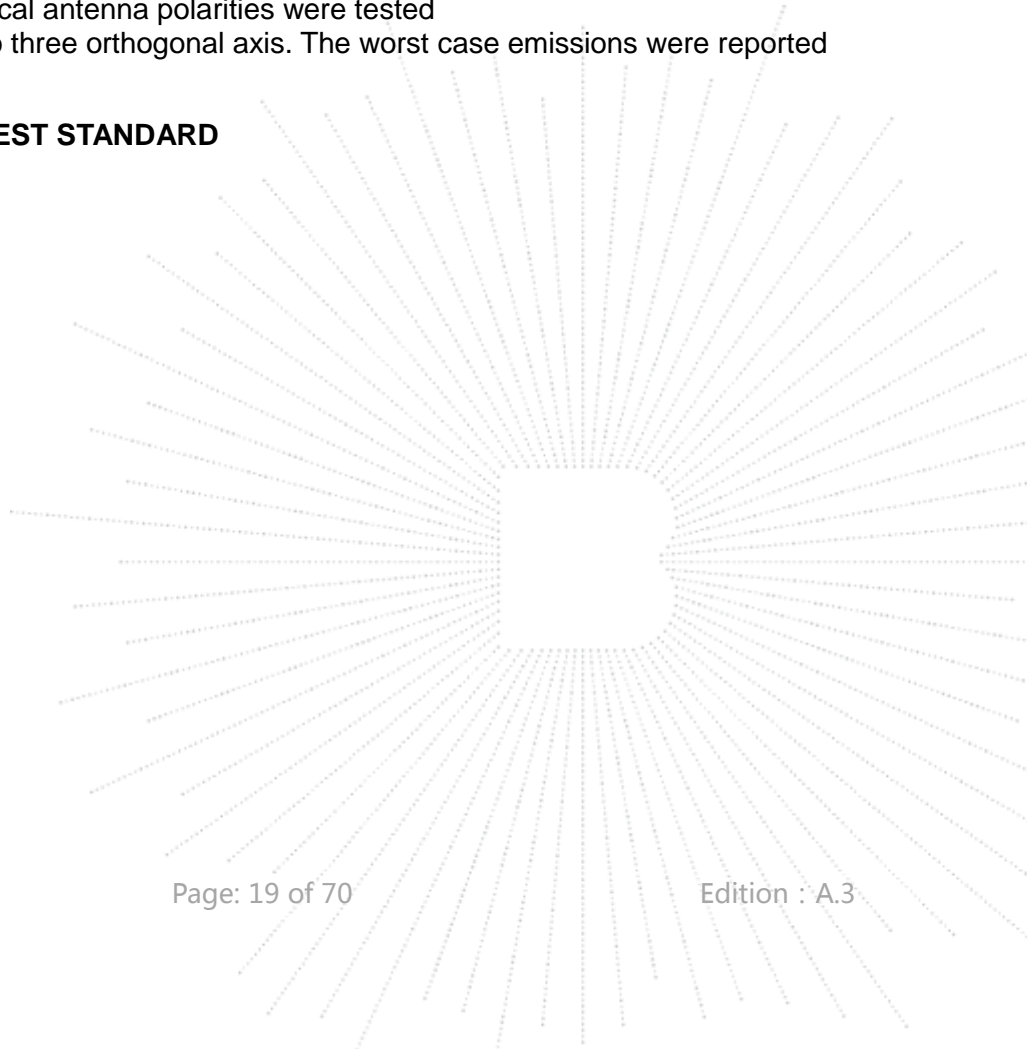

4.2.4 TEST SETUP

(A) Radiated Emission Test-Up Frequency Below 30MHz

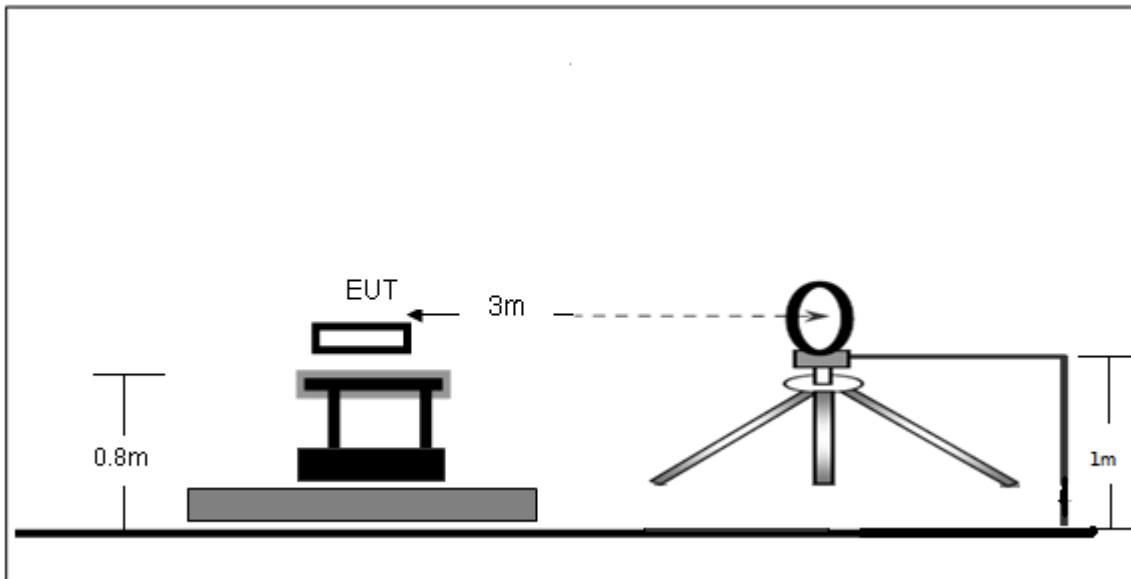

(B) Radiated Emission Test-Up Frequency 30MHz~1GHz

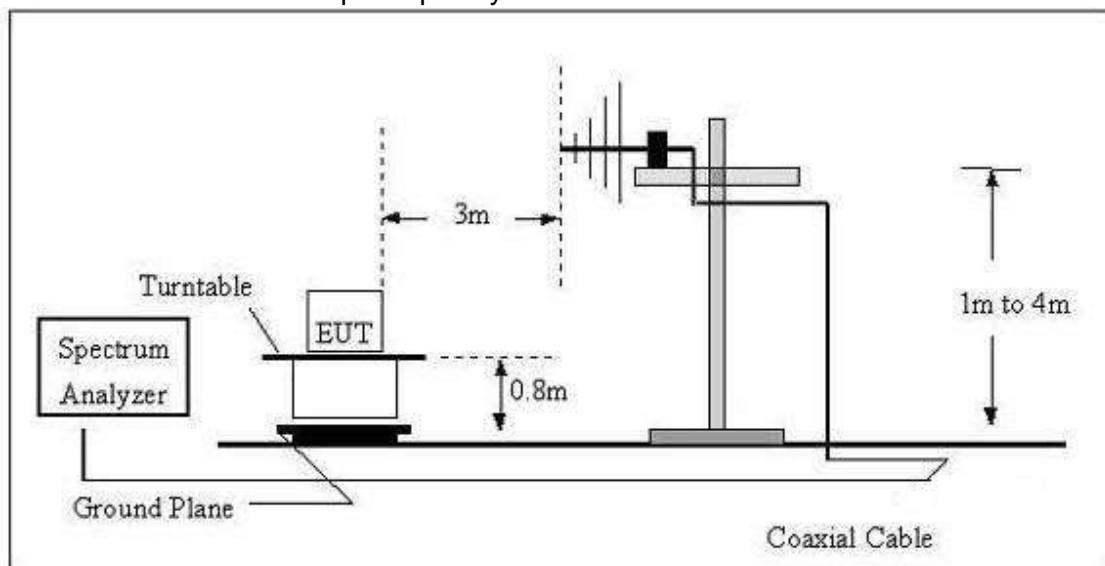

(C) Radiated Emission Test-Up Frequency Above 1GHz

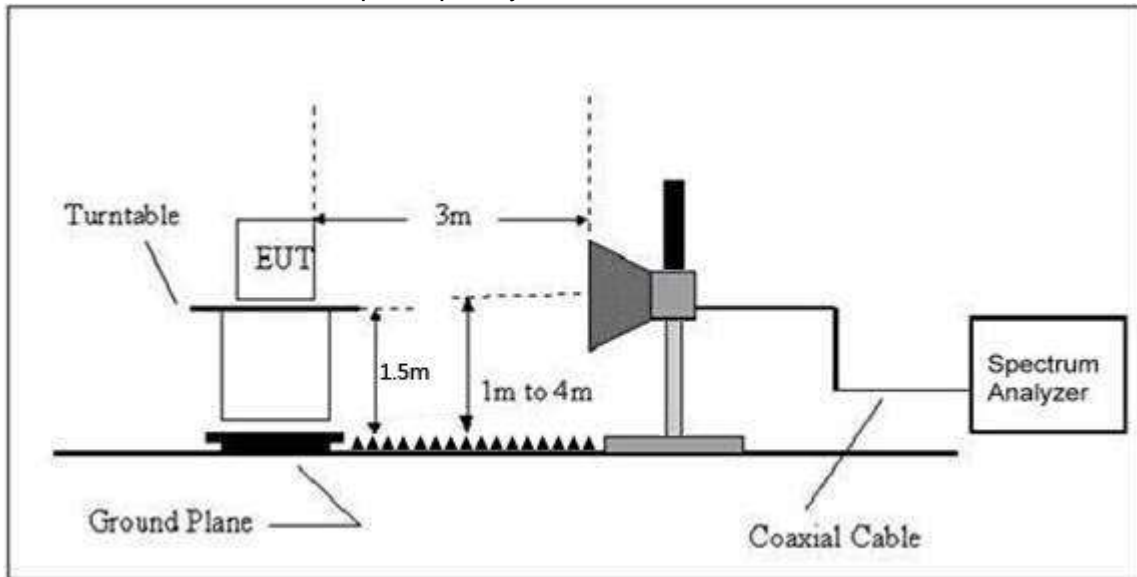
**4.2.5 EUT OPERATING CONDITIONS**

The EUT tested system was configured as the statements of 2.4 Unless otherwise a special operating condition is specified in the follows during the testing.

4.2.6 TEST RESULTS (BETWEEN 9KHZ – 30 MHZ)

Temperature:	26 °C	Relative Humidity :	54%
Pressure:	101kPa	Test Voltage :	DC 5V
Test Mode :	Mode 4	Polarization :	--

Freq.	Reading	Limit	Margin	State
(MHz)	(dBuV/m)	(dBuV/m)	(dB)	P/F
--	--	--	--	PASS
--	--	--	--	PASS

NOTE:

The amplitude of spurious emissions which are attenuated by more than 20dB below the permissible value has no need to be reported.

Distance extrapolation factor = $40 \log(\text{specific distance}/\text{test distance})$ (dB);

Limit line = specific limits(dBuv) + distance extrapolation factor.

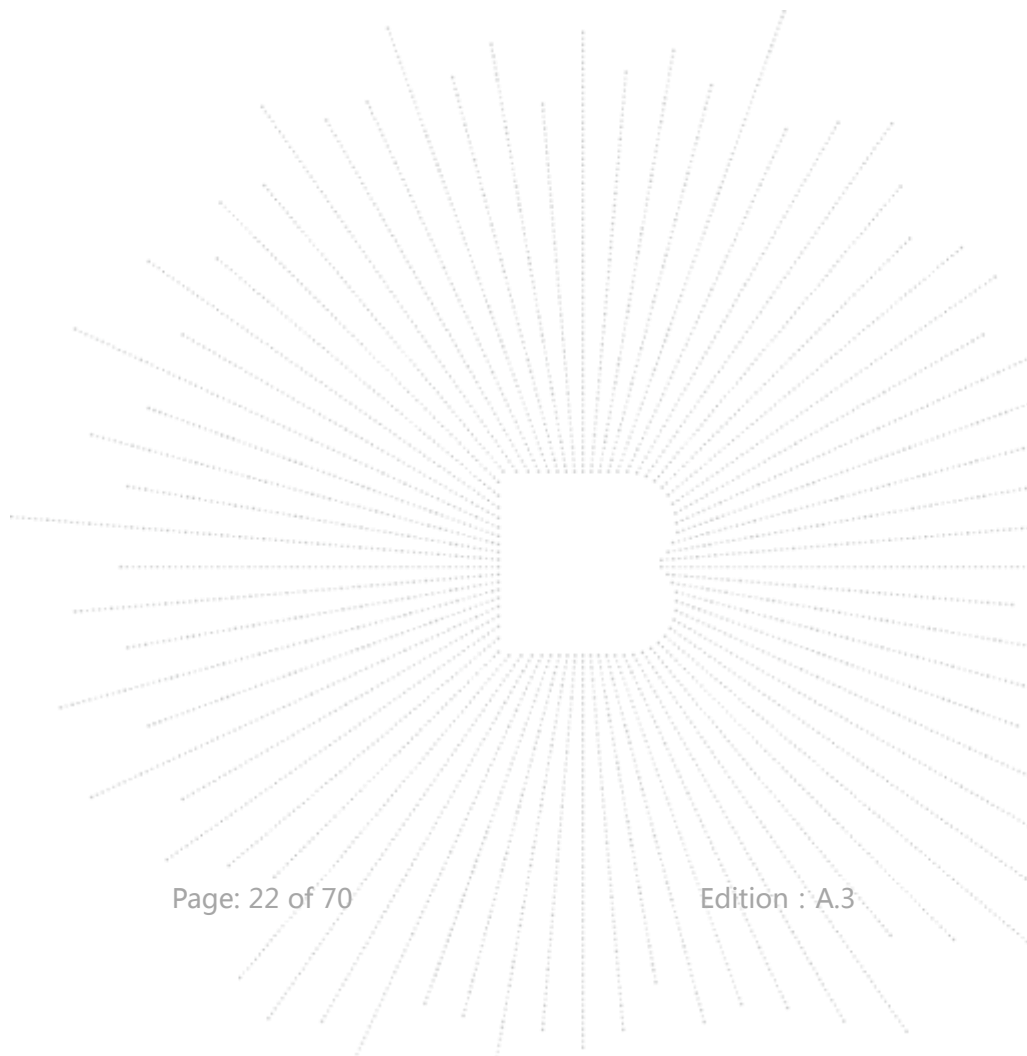

4.2.7 TEST RESULTS (BETWEEN 30MHZ – 1GHZ)

Temperature :	26 °C	Relative Humidity :	54%
Pressure :	101 kPa	Polarization :	Horizontal
Test Voltage :	DC 5V	Test Mode :	Mode 4

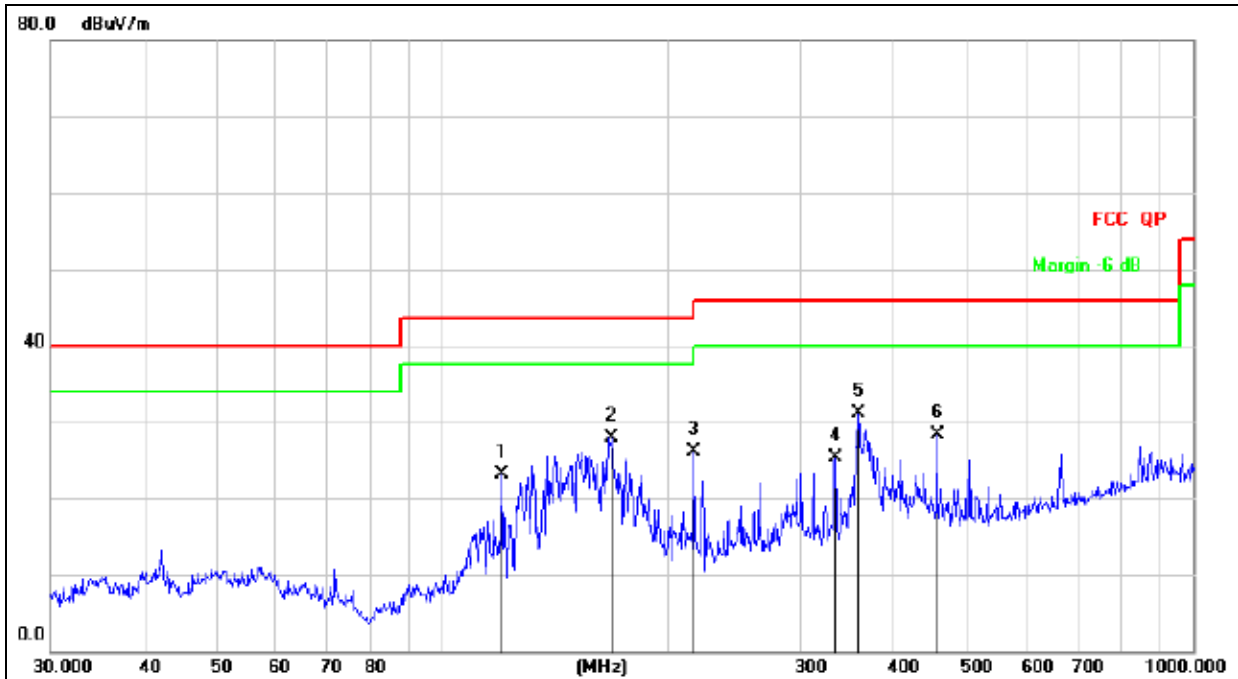

Remark:
 Factor = Antenna Factor + Cable Loss – Pre-amplifier.

No.	Mk.	Freq.	Reading Level	Correct Factor	Measurement	Limit	Over	Detector
		MHz	dBuV	dB	dBuV/m	dB/m	dB	
1		119.8556	39.90	-16.76	23.14	43.50	-20.36	QP
2		167.8243	45.42	-17.48	27.94	43.50	-15.56	QP
3		216.0240	41.09	-14.93	26.16	46.00	-19.84	QP
4		333.6867	36.85	-11.50	25.35	46.00	-20.65	QP
5	*	357.9287	42.00	-10.85	31.15	46.00	-14.85	QP
6		455.9058	36.73	-8.50	28.23	46.00	-17.77	QP

Temperature :	26 °C	Relative Humidity :	54%
Pressure :	101kPa	Polarization :	Vertical
Test Voltage :	DC 5V	Test Mode :	Mode 4

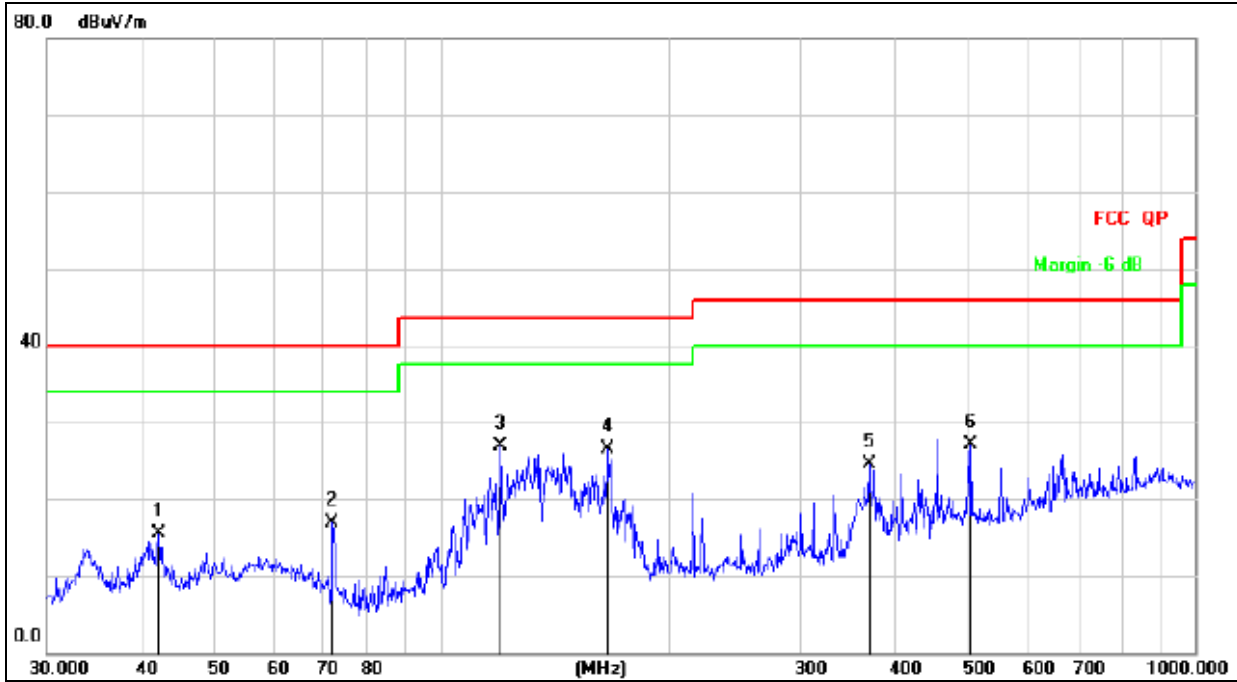

Remark:
 Factor = Antenna Factor + Cable Loss – Pre-amplifier.

No.	Mk.	Freq.	Reading Level	Correct Factor	Measurement	Limit	Over	Detector
		MHz	dBuV	dB	dBuV/m	dB/m	dB	
1		42.3022	30.20	-14.74	15.46	40.00	-24.54	QP
2		71.8320	34.55	-17.66	16.89	40.00	-23.11	QP
3	*	119.8556	43.60	-16.76	26.84	43.50	-16.66	QP
4		166.6514	43.99	-17.56	26.43	43.50	-17.07	QP
5		369.4047	35.06	-10.53	24.53	46.00	-21.47	QP
6		504.7062	34.49	-7.45	27.04	46.00	-18.96	QP

4.2.8 TEST RESULTS

Between 1GHz – 25GHz

802.11b

Polar (H/V)	Frequency	Reading Level	Correct Factor	Measure- ment	Limits	Over	Detector Type
	(MHz)	(dBuV/m)	(dB)	(dBuV/m)	(dBuV/ m)	(dB)	
Low channel:2412MHz							
V	4824.00	54.63	-0.43	54.20	74.00	-19.80	PK
V	4824.00	45.29	-0.43	44.86	54.00	-9.14	AV
V	7236.00	46.96	8.31	55.27	74.00	-18.73	PK
V	7236.00	37.09	8.31	45.40	54.00	-8.60	AV
H	4804.00	52.47	-0.43	52.04	74.00	-21.96	PK
H	4804.00	42.86	-0.43	42.43	54.00	-11.57	AV
H	7236.00	45.41	8.31	53.72	74.00	-20.28	PK
H	7236.00	37.24	8.31	45.55	54.00	-8.45	AV
Middle channel:2437MHz							
V	4874.00	51.97	-0.38	51.59	74.00	-22.41	PK
V	4874.00	45.65	-0.38	45.27	54.00	-8.73	AV
V	7311.00	44.85	8.83	53.68	74.00	-20.32	PK
V	7311.00	35.69	8.83	44.52	54.00	-9.48	AV
H	4874.00	50.65	-0.38	50.27	74.00	-23.73	PK
H	4874.00	40.55	-0.38	40.17	54.00	-13.83	AV
H	7311.00	43.22	8.83	52.05	74.00	-21.95	PK
H	7311.00	36.17	8.83	45.00	54.00	-9.00	AV
High channel:2462MHz							
V	4924.00	54.19	-0.32	53.87	74.00	-20.13	PK
V	4924.00	44.86	-0.32	44.54	54.00	-9.46	AV
V	7386.00	45.64	9.35	54.99	74.00	-19.01	PK
V	7386.00	36.00	9.35	45.35	54.00	-8.65	AV
H	4924.00	51.19	-0.32	50.87	74.00	-23.13	PK
H	4924.00	42.02	-0.32	41.70	54.00	-12.30	AV
H	7386.00	42.74	9.35	52.09	74.00	-21.91	PK
H	7386.00	34.12	9.35	43.47	54.00	-10.53	AV

Remark:

1. Emission Level = Meter Reading + Factor,

Factor = Antenna Factor + Cable Loss – Pre-amplifier.

Over = Emission Level - Limit

2. If peak below the average limit, the average emission was no test.

3. In restricted bands of operation, The spurious emissions below the permissible value more than 20dB

4. The amplitude of spurious emissions which are attenuated by more than 20dB below the permissible value has no need to be reported.

5. The Worst mode is Antenna A.

802.11g

Polar (H/V)	Frequency	Reading Level	Correct Factor	Measure- ment	Limits	Over	Detector Type
	(MHz)	(dBuV/m)	(dB)	(dBuV/m)	(dBuV/ m)	(dB)	
Low channel:2412MHz							
V	4824.00	54.06	-0.43	53.63	74.00	-20.37	PK
V	4824.00	43.96	-0.43	43.53	54.00	-10.47	AV
V	7236.00	46.73	8.31	55.04	74.00	-18.96	PK
V	7236.00	37.27	8.31	45.58	54.00	-8.42	AV
H	4804.00	52.07	-0.43	51.64	74.00	-22.36	PK
H	4804.00	42.16	-0.43	41.73	54.00	-12.27	AV
H	7236.00	43.98	8.31	52.29	74.00	-21.71	PK
H	7236.00	35.20	8.31	43.51	54.00	-10.49	AV
Middle channel:2437MHz							
V	4874.00	50.86	-0.38	50.48	74.00	-23.52	PK
V	4874.00	44.23	-0.38	43.85	54.00	-10.15	AV
V	7311.00	43.23	8.83	52.06	74.00	-21.94	PK
V	7311.00	34.45	8.83	43.28	54.00	-10.72	AV
H	4874.00	47.70	-0.38	47.32	74.00	-26.68	PK
H	4874.00	37.36	-0.38	36.98	54.00	-17.02	AV
H	7311.00	42.09	8.83	50.92	74.00	-23.08	PK
H	7311.00	34.81	8.83	43.64	54.00	-10.36	AV
High channel:2462MHz							
V	4924.00	53.71	-0.32	53.39	74.00	-20.61	PK
V	4924.00	42.95	-0.32	42.63	54.00	-11.37	AV
V	7386.00	45.16	9.35	54.51	74.00	-19.49	PK
V	7386.00	35.29	9.35	44.64	54.00	-9.36	AV
H	4924.00	52.02	-0.32	51.70	74.00	-22.30	PK
H	4924.00	41.45	-0.32	41.13	54.00	-12.87	AV
H	7386.00	44.06	9.35	53.41	74.00	-20.59	PK
H	7386.00	35.57	9.35	44.92	54.00	-9.08	AV

Remark:

1. Emission Level = Meter Reading + Factor,

Factor = Antenna Factor + Cable Loss – Pre-amplifier.

Over = Emission Level - Limit

2. If peak below the average limit, the average emission was no test.

3. In restricted bands of operation, The spurious emissions below the permissible value more than 20dB

4. The amplitude of spurious emissions which are attenuated by more than 20dB below the permissible value has no need to be reported.

5. The Worst mode is Antenna A.

802.11n20

Polar (H/V)	Frequency	Reading Level	Correct Factor	Measurement	Limits	Over	Detector Type
	(MHz)	(dBuV/m)	(dB)	(dBuV/m)	(dBuV/m)	(dB)	
Low channel:2412MHz							
V	4824.00	54.21	-0.43	53.78	74.00	-20.22	PK
V	4824.00	45.15	-0.43	44.72	54.00	-9.28	AV
V	7236.00	45.81	8.31	54.12	74.00	-19.88	PK
V	7236.00	35.05	8.31	43.36	54.00	-10.64	AV
H	4804.00	49.48	-0.43	49.05	74.00	-24.95	PK
H	4804.00	39.59	-0.43	39.16	54.00	-14.84	AV
H	7236.00	43.42	8.31	51.73	74.00	-22.27	PK
H	7236.00	35.16	8.31	43.47	54.00	-10.53	AV
Middle channel:2437MHz							
V	4874.00	50.79	-0.38	50.41	74.00	-23.59	PK
V	4874.00	43.31	-0.38	42.93	54.00	-11.07	AV
V	7311.00	40.24	8.83	49.07	74.00	-24.93	PK
V	7311.00	30.60	8.83	39.43	54.00	-14.57	AV
H	4874.00	48.91	-0.38	48.53	74.00	-25.47	PK
H	4874.00	38.01	-0.38	37.63	54.00	-16.37	AV
H	7311.00	37.82	8.83	46.65	74.00	-27.35	PK
H	7311.00	29.53	8.83	38.36	54.00	-15.64	AV
High channel:2462MHz							
V	4924.00	52.28	-0.32	51.96	74.00	-22.04	PK
V	4924.00	43.77	-0.32	43.45	54.00	-10.55	AV
V	7386.00	45.99	9.35	55.34	74.00	-18.66	PK
V	7386.00	35.05	9.35	44.40	54.00	-9.60	AV
H	4924.00	49.92	-0.32	49.60	74.00	-24.40	PK
H	4924.00	40.38	-0.32	40.06	54.00	-13.94	AV
H	7386.00	43.27	9.35	52.62	74.00	-21.38	PK
H	7386.00	35.00	9.35	44.35	54.00	-9.65	AV

Remark:

1. Emission Level = Meter Reading + Factor,

Factor = Antenna Factor + Cable Loss – Pre-amplifier.

Over = Emission Level - Limit

2. If peak below the average limit, the average emission was no test.

3. In restricted bands of operation, The spurious emissions below the permissible value more than 20dB

4. The amplitude of spurious emissions which are attenuated by more than 20dB below the permissible value has no need to be reported.

5. Test Mode is MIMO Mode.

802.11n40

Polar (H/V)	Frequency	Reading Level	Correct Factor	Measurement	Limits	Over	Detector Type
	(MHz)	(dBuV/m)	(dB)	(dBuV/m)	(dBuV/m)	(dB)	
Low channel:2422MHz							
V	4844.00	53.71	-0.43	53.28	74.00	-20.72	PK
V	4844.00	42.72	-0.43	42.29	54.00	-11.71	AV
V	7266.00	42.83	8.31	51.14	74.00	-22.86	PK
V	7266.00	32.82	8.31	41.13	54.00	-12.87	AV
H	4844.00	50.21	-0.43	49.78	74.00	-24.22	PK
H	4844.00	40.09	-0.43	39.66	54.00	-14.34	AV
H	7266.00	40.83	8.31	49.14	74.00	-24.86	PK
H	7266.00	32.94	8.31	41.25	54.00	-12.75	AV
Middle channel:2437MHz							
V	4874.00	52.71	-0.38	52.33	74.00	-21.67	PK
V	4874.00	45.31	-0.38	44.93	54.00	-9.07	AV
V	7311.00	45.70	8.83	54.53	74.00	-19.47	PK
V	7311.00	36.13	8.83	44.96	54.00	-9.04	AV
H	4874.00	50.76	-0.38	50.38	74.00	-23.62	PK
H	4874.00	40.71	-0.38	40.33	54.00	-13.67	AV
H	7311.00	43.09	8.83	51.92	74.00	-22.08	PK
H	7311.00	34.13	8.83	42.96	54.00	-11.04	AV
High channel:2452MHz							
V	4904.00	54.18	-0.32	53.86	74.00	-20.14	PK
V	4904.00	45.82	-0.32	45.50	54.00	-8.50	AV
V	7356.00	46.10	9.35	55.45	74.00	-18.55	PK
V	7356.00	35.95	9.35	45.30	54.00	-8.70	AV
H	4904.00	52.66	-0.32	52.34	74.00	-21.66	PK
H	4904.00	43.56	-0.32	43.24	54.00	-10.76	AV
H	7356.00	45.06	9.35	54.41	74.00	-19.59	PK
H	7356.00	37.02	9.35	46.37	54.00	-7.63	AV

Remark:

1. Emission Level = Meter Reading + Factor,

Factor = Antenna Factor + Cable Loss – Pre-amplifier.

Over = Emission Level - Limit

2. If peak below the average limit, the average emission was no test.

3. In restricted bands of operation, The spurious emissions below the permissible value more than 20dB

4. The amplitude of spurious emissions which are attenuated by more than 20dB below the permissible value has no need to be reported.

5. Test Mode is MIMO Mode.

4.3 RADIATED BAND EMISSION MEASUREMENT

4.3.1 TEST REQUIREMENT:

FCC Part15 C Section 15.209 and 15.205

(a) Except as shown in paragraph (d) of this section, only spurious emissions are permitted in any of the frequency bands listed below:

MHz	MHz	MHz	GHz
0.090-0.110	16.42-16.423	399.9-410	4.5-5.15
0.495-0.505	16.69475-16.69525	608-614	5.35-5.46
2.1735-2.1905	16.80425-16.80475	960-1240	7.25-7.75
4.125-4.128	25.5-25.67	1300-1427	8.025-8.5
4.17725-4.17775	37.5-38.25	1435-1626.5	9.0-9.2
4.20725-4.20775	73-74.6	1645.5-1646.5	9.3-9.5
6.215-6.218	74.8-75.2	1660-1710	10.6-12.7
6.26775-6.26825	108-121.94	1718.8-1722.2	13.25-13.4
6.31175-6.31225	123-138	2200-2300	14.47-14.5
8.291-8.294	149.9-150.05	2310-2390	15.35-16.2
8.362-8.366	156.52475-156.52525	2483.5-2500	17.7-21.4
8.37625-8.38675	156.7-156.9	2690-2900	22.01-23.12
8.41425-8.41475	162.0125-167.17	3260-3267	23.6-24.0
12.29-12.293	167.72-173.2	3332-3339	31.2-31.8
12.51975-12.52025	240-285	3345.8-3358	36.43-36.5
12.57675-12.57725	322-335.4	3600-4400	36.43-36.5
13.36-13.41			

LIMITS OF RADIATED EMISSION MEASUREMENT (Above 1000MHz)

FREQUENCY (MHz)	Class B (dBuV/m) (at 3M)	
	PEAK	AVERAGE
Above 1000	74	54

Notes:

- (1) The limit for radiated test was performed according to FCC PART 15C.
- (2) The tighter limit applies at the band edges.
- (3) Emission level (dBuV/m)=20log Emission level (uV/m).

Spectrum Parameter	Setting
Attenuation	Auto
Start Frequency	2300MHz
Stop Frequency	2520
RB / VB (emission in restricted band)	1 MHz / 1 MHz for Peak, 1 MHz / 10Hz for Average

4.3.2 TEST PROCEDURE

Above 1GHz test procedure as below:

- a. 1. The EUT was placed on the top of a rotating table 1.5 meters above the ground at a 3 meter camber. The table was rotated 360 degrees to determine the position of the highest radiation.
- b. The EUT was set 3 meters away from the interference-receiving antenna, which was mounted on the top of a variable-height antenna tower.
- c. The antenna height is varied from one meter to four meters above the ground to determine the maximum value of the field strength. Both horizontal and vertical polarizations of the antenna are set to make the measurement.

- d. For each suspected emission, the EUT was arranged to its worst case and then the antenna was tuned to heights from 1 meter to 4 meters and the rota table was turned from 0 degrees to 360 degrees to find the maximum reading.
- e. The test-receiver system was set to Peak Detect Function and Specified Bandwidth with Maximum Hold Mode.
- f. If the emission level of the EUT in peak mode was 10dB lower than the limit specified, then testing could be stopped and the peak values of the EUT would be reported. Otherwise the emissions that did not have 10dB margin would be re-tested one by one using peak, quasi-peak or average method as specified and then reported in a data sheet.
- g. Test the EUT in the lowest channel, the Highest channel

Note:

Both horizontal and vertical antenna polarities were tested and performed pretest to three orthogonal axis. The worst case emissions were reported

4.3.3 DEVIATION FROM TEST STANDARD

No deviation

4.3.4 TEST SETUP

Radiated Emission Test-Up Frequency Above 1GHz

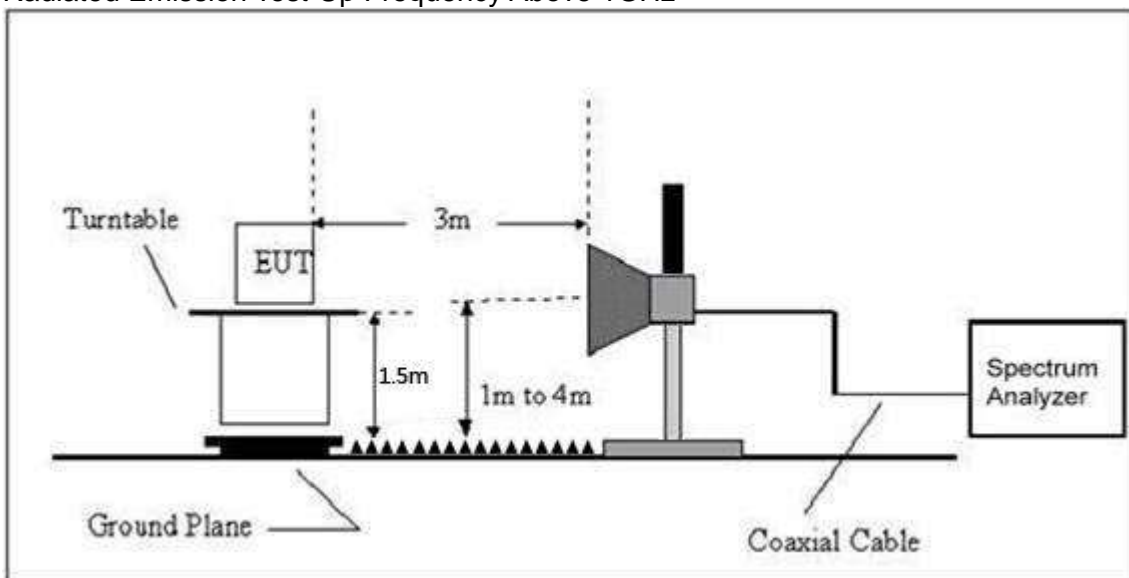

4.3.5 EUT OPERATING CONDITIONS

The EUT tested system was configured as the statements of 2.3 Unless otherwise a special operating condition is specified in the follows during the testing.

4.3.6 TEST RESULT

	Polar (H/V)	Frequency (MHz)	Reading Level (dBuV/m)	Correct Factor (dB)	Measurement (dBuV/m)	Limits (dBuV/m)		Result
					PK	PK	AV	
802.11b	Low Channel 2412MHz							
	H	2390.00	56.49	-6.70	49.79	74.00	54.00	PASS
	H	2400.00	48.31	-6.71	41.60	74.00	54.00	PASS
	V	2390.00	56.90	-6.70	50.20	74.00	54.00	PASS
	V	2400.00	48.15	-6.71	41.44	74.00	54.00	PASS
	High Channel 2462MHz							
	H	2483.50	54.80	-6.79	48.01	74.00	54.00	PASS
	H	2485.00	48.23	-6.81	41.42	74.00	54.00	PASS
	V	2483.50	57.07	-6.79	50.28	74.00	54.00	PASS
	V	2485.00	49.70	-6.81	42.89	74.00	54.00	PASS
802.11g	Low Channel 2412MHz							
	H	2390.00	57.05	-6.70	50.35	74.00	54.00	PASS
	H	2400.00	49.52	-6.71	42.81	74.00	54.00	PASS
	V	2390.00	56.16	-6.70	49.46	74.00	54.00	PASS
	V	2400.00	49.13	-6.71	42.42	74.00	54.00	PASS
	High Channel 2462MHz							
	H	2483.50	55.73	-6.79	48.94	74.00	54.00	PASS
	H	2485.00	48.41	-6.81	41.60	74.00	54.00	PASS
	V	2483.50	56.17	-6.79	49.38	74.00	54.00	PASS
	V	2485.00	49.13	-6.81	42.32	74.00	54.00	PASS

Remark:

1. Emission Level = Meter Reading + Factor,
Factor = Antenna Factor + Cable Loss – Pre-amplifier.
Over= Emission Level - Limit
2. If the PK measured levels comply with average limit, then the average level were deemed to comply with average limit.
- 3 In restricted bands of operation, The spurious emissions below the permissible value more than 20dB
4. The amplitude of spurious emissions which are attenuated by more than 20dB below the permissible value has no need to be reported.

	Polar (H/V)	Frequency (MHz)	Reading Level (dBuV/m)	Correct Factor (dB)	Measurement (dBuV/m)	Limits (dBuV/m)		Result
					PK	PK	AV	
802.11 n20	Low Channel 2412MHz							
	H	2390.00	57.53	-6.70	50.83	74.00	54.00	PASS
	H	2400.00	48.77	-6.71	42.06	74.00	54.00	PASS
	V	2390.00	57.32	-6.70	50.62	74.00	54.00	PASS
	V	2400.00	49.86	-6.71	43.15	74.00	54.00	PASS
	High Channel 2462MHz							
	H	2483.50	56.33	-6.79	49.54	74.00	54.00	PASS
	H	2500.00	49.32	-6.81	42.51	74.00	54.00	PASS
	V	2483.50	55.69	-6.79	48.90	74.00	54.00	PASS
	V	2500.00	47.35	-6.81	40.54	74.00	54.00	PASS
802.11 n40	Low Channel 2422MHz							
	H	2390.00	56.96	-6.70	50.26	74.00	54.00	PASS
	H	2400.00	49.53	-6.71	42.82	74.00	54.00	PASS
	V	2390.00	56.96	-6.70	50.26	74.00	54.00	PASS
	V	2400.00	49.21	-6.71	42.50	74.00	54.00	PASS
	High Channel 2452MHz							
	H	2483.50	55.20	-6.79	48.41	74.00	54.00	PASS
	H	2500.00	48.67	-6.81	41.86	74.00	54.00	PASS
	V	2483.50	57.32	-6.79	50.53	74.00	54.00	PASS
	V	2500.00	49.88	-6.81	43.07	74.00	54.00	PASS

Remark:

1. Emission Level = Meter Reading + Factor,

Factor = Antenna Factor + Cable Loss – Pre-amplifier.

Over= Emission Level - Limit

2. If the PK measured levels comply with average limit, then the average level were deemed to comply with average limit.

3 In restricted bands of operation, The spurious emissions below the permissible value more than 20dB

4. The amplitude of spurious emissions which are attenuated by more than 20dB below the permissible value has no need to be reported.

5. POWER SPECTRAL DENSITY TEST

5.1 APPLIED PROCEDURES / LIMIT

FCC Part15 (15.247) , Subpart C				
Section	Test Item	Limit	Frequency Range (MHz)	Result
15.247	Power Spectral Density	8 dBm (in any 3KHz)	2400-2483.5	PASS

5.1.1 TEST PROCEDURE

1. Set analyzer center frequency to DTS channel center frequency.
2. Set the span to 1.5 times the DTS bandwidth.
3. Set the RBW to: $3 \text{ kHz} \leq \text{RBW} \leq 100 \text{ kHz}$.
4. Set the VBW $\geq 3 \times \text{RBW}$.
5. Detector = peak.
6. Sweep time = auto couple.
7. Trace mode = max hold.
8. Allow trace to fully stabilize.
9. Use the peak marker function to determine the maximum amplitude level within the RBW.
10. If measured value exceeds limit, reduce RBW (no less than 3 kHz) and repeat.

5.1.2 DEVIATION FROM STANDARD

No deviation.

5.1.3 TEST SETUP

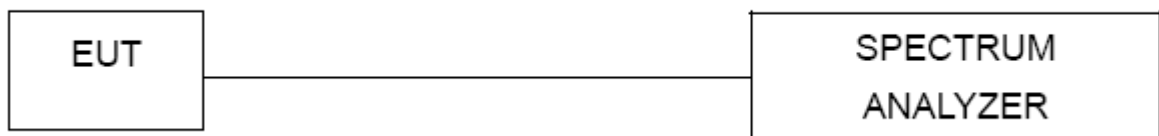

5.1.4 EUT OPERATION CONDITIONS

The EUT tested system was configured as the statements of 2.1 Unless otherwise a special operating condition is specified in the follows during the testing.

Note: Power Spectral Density(dBm)=Reading+Cable Loss

5.1.5 TEST RESULTS

Temperature :	26 °C	Relative Humidity :	54%
Pressure :	101kPa	Test Voltage :	AC120V/60Hz
Test Mode :	TX b Mode		

Frequency	Power Spectral Density (dBm/3KHz) ANTA	Power Spectral Density (dBm/3KHz) ANT B	Total power density (dBm/3KHz)	Limit (dBm/3KHz)	Result
2412 MHz	-9.964	-9.611	/	8	PASS
2437 MHz	-10.095	-9.763	/	8	PASS
2462 MHz	-9.530	-9.786	/	8	PASS

Note: A(B) Represent the value of antenna A and B, The worst data is Antenna A, only shown Antenna A Plot.

TX CH01

TX CH06

TX CH11

Temperature :	26 °C	Relative Humidity :	54%
Pressure :	101kPa	Test Voltage :	AC120V/60Hz
Test Mode :	TX g Mode		

Frequency	Power Spectral Density (dBm/3KHz) ANTA	Power Spectral Density (dBm/3KHz) ANTB	Total power density (dBm/3KHz)	Limit (dBm/3KHz)	Result
2412 MHz	-14.468	-13.150	/	8	PASS
2437 MHz	-13.705	-14.678	/	8	PASS
2462 MHz	-14.051	-13.741	/	8	PASS

Note: A(B) Represent the value of antenna A and B, The worst data is Antenna B, only shown Antenna B Plot.

TX CH01

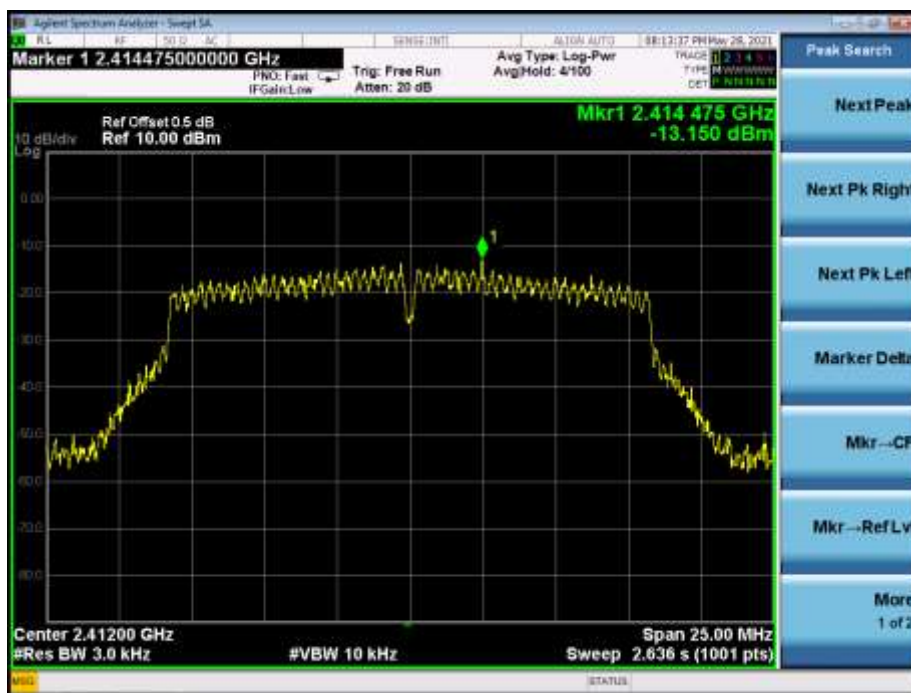

TX CH06

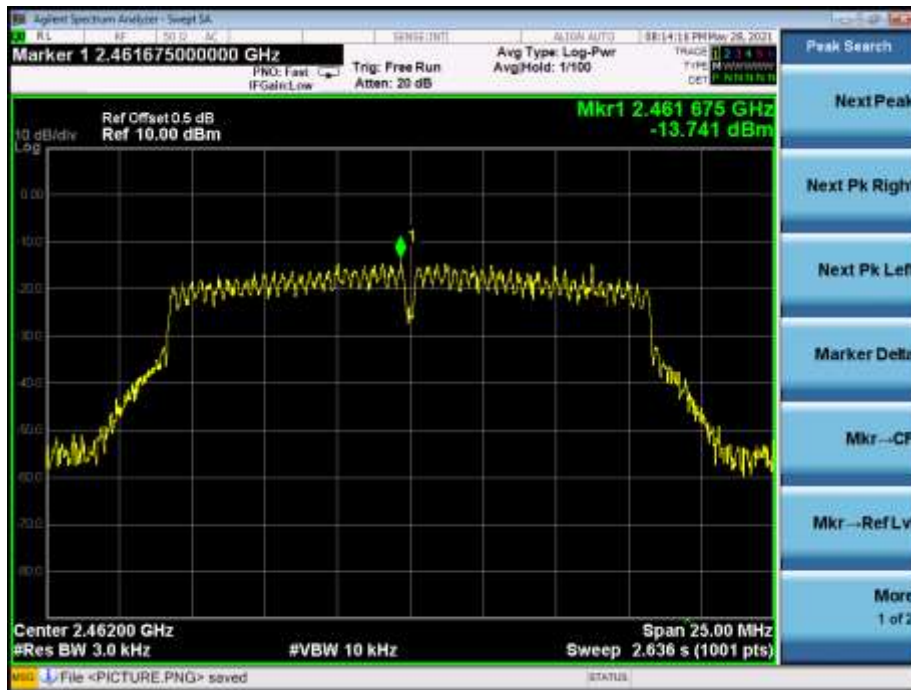
TX CH11

Temperature :	26 °C	Relative Humidity :	54%
Pressure :	101kPa	Test Voltage :	AC120V/60Hz
Test Mode :	TX n Mode(20M)		

Frequency	Power Spectral Density (dBm/3KHz) ANTA	Power Spectral Density (dBm/3KHz) ANTB	Total power density (dBm/3KHz)	Limit (dBm/3KHz)	Result
2412 MHz	-15.622	-14.810	-12.187	8	PASS
2437 MHz	-14.496	-13.127	-10.747	8	PASS
2462 MHz	-15.389	-14.929	-12.143	8	PASS

Note: A(B) Represent the value of antenna A and B, The worst data is Antenna B, only shown Antenna B Plot.

Note: Antenna A gain: 2.3dBi, Antenna B gain: 2.3dBi, Directional gain=[Gain_{ANT} + 10 log(N_{ANT}) dBi] =5.31dbi

TX CH01

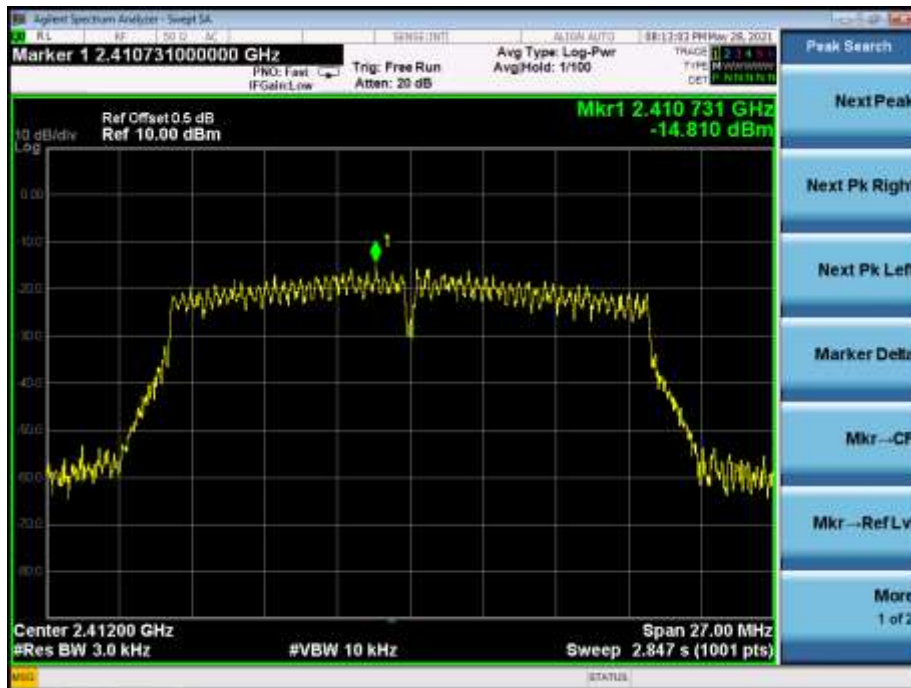

TX CH06

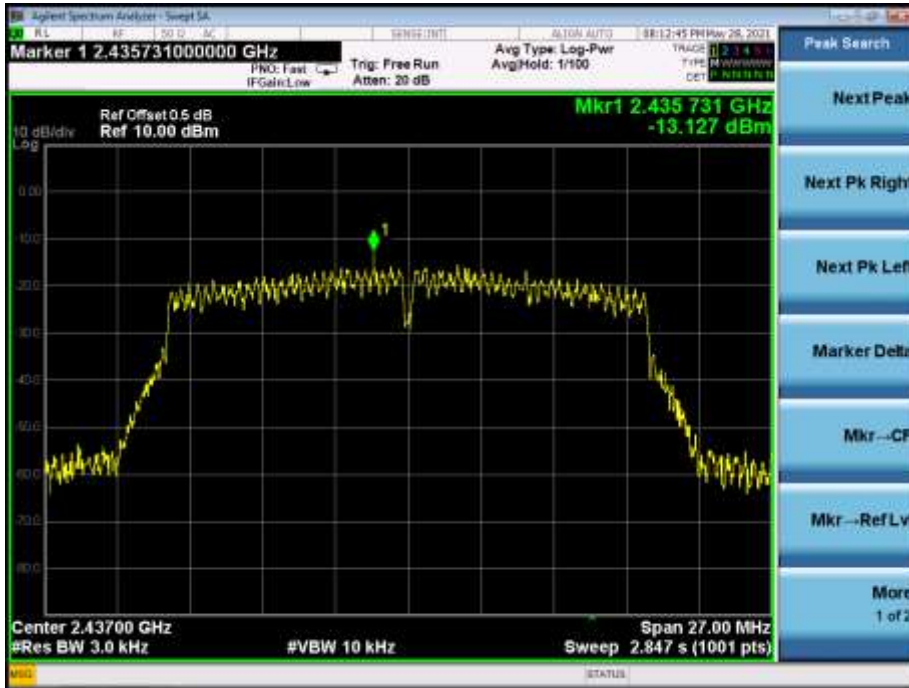

TX CH11

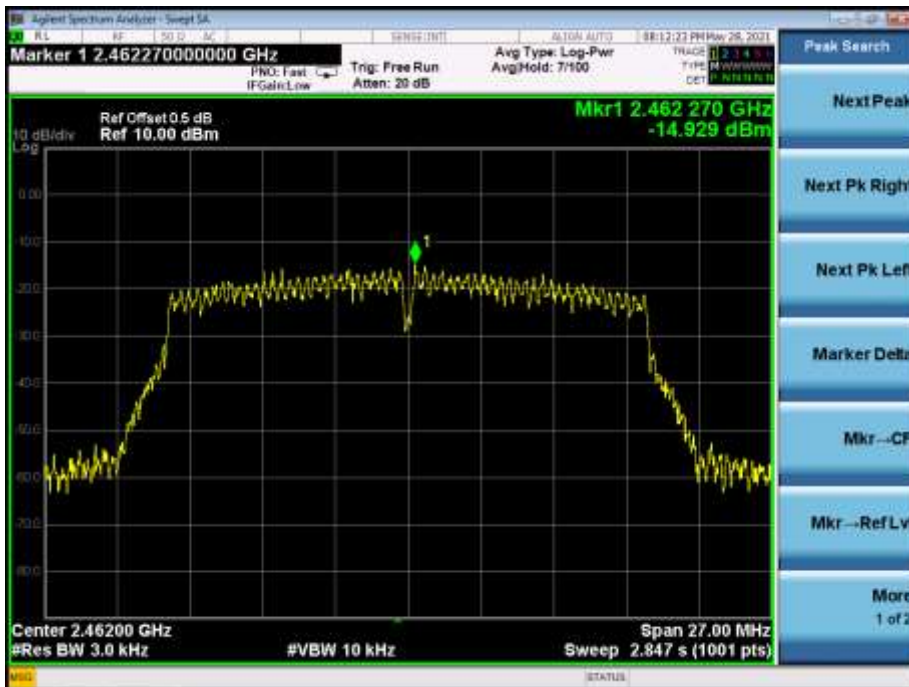

Temperature :	26 °C	Relative Humidity :	54%
Pressure :	101kPa	Test Voltage :	AC120V/60Hz
Test Mode :	TX n Mode(40M)		

Frequency	Power Spectral Density (dBm/3KHz) ANTA	Power Spectral Density (dBm/3KHz) ANT B	Total power density (dBm/3KHz)	Limit (dBm/3KHz)	Result
2422 MHz	-15.286	-16.622	-12.893	8	PASS
2437 MHz	-16.241	-15.459	-12.822	8	PASS
2452 MHz	-16.112	-17.261	-13.638	8	PASS

Note: A(B) Represent the value of antenna A and B, The worst data is Antenna B, only shown Antenna B Plot.

Note:Antenna A gain: 2.3dbi, Antenna B gain: 2.3dbi, Directional gain=[Gain_{ANT} + 10 log(N_{ANT} dBi)] =5.31dbi

TX CH03



TX CH06



TX CH09

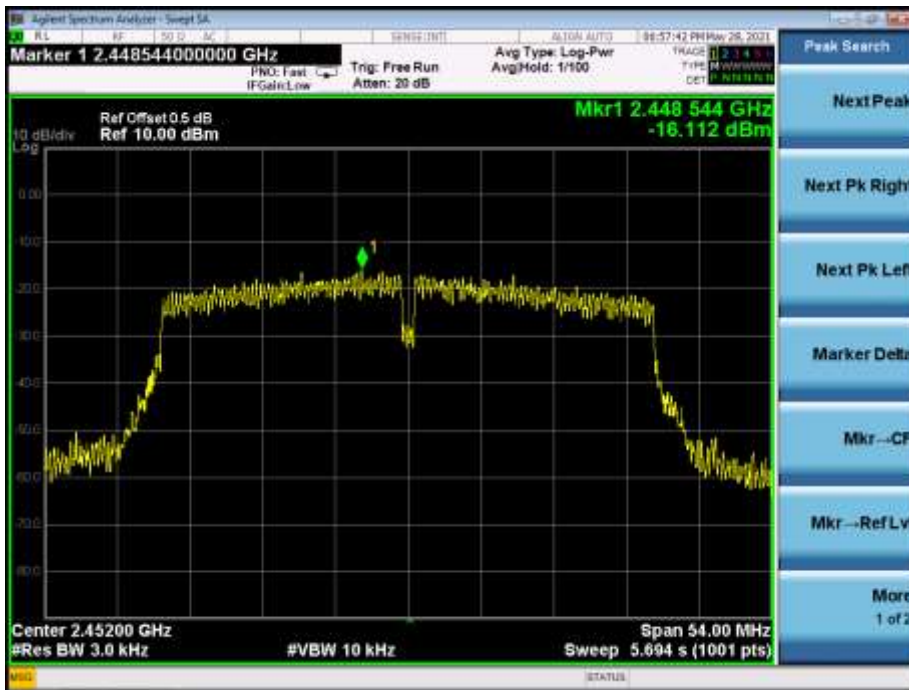

6. BANDWIDTH TEST

6.1 APPLIED PROCEDURES / LIMIT

FCC Part15 (15.247) , Subpart C				
Section	Test Item	Limit	Frequency Range (MHz)	Result
15.247(a)(2)	Bandwidth	$\geq 500\text{KHz}$ (6dB bandwidth)	2400-2483.5	PASS

6.1.1 TEST PROCEDURE

1. Set RBW = 100 kHz.
2. Set the video bandwidth (VBW) $\geq 3 \times$ RBW.
3. Detector = Peak.
4. Trace mode = max hold.
5. Sweep = auto couple.
6. Allow the trace to stabilize.
7. Measure the maximum width of the emission that is constrained by the frequencies associated with the two outermost amplitude points (upper and lower frequencies) that are attenuated by 6 dB relative to the maximum level measured in the fundamental emission.

6.1.2 DEVIATION FROM STANDARD

No deviation.

6.1.3 TEST SETUP

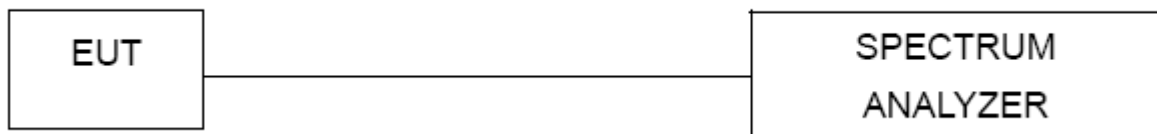

6.1.4 EUT OPERATION CONDITIONS

The EUT tested system was configured as the statements of 2.4 Unless otherwise a special operating condition is specified in the follows during the testing.

6.1.5 TEST RESULTS

Temperature :	26 °C	Relative Humidity :	54%
Pressure :	101kPa	Test Voltage :	AC120V/60Hz
Test Mode :	TX b Mode		

Frequency (MHz)	6dB bandwidth (MHz) ANTA	6dB bandwidth (MHz) ANTB	Limit (kHz)	Result
2412	10.04	10.04	500	Pass
2437	10.04	09.59	500	Pass
2462	09.11	10.03	500	Pass

Note: A(B) Represent the value of antenna A and B, The worst data is Antenna A, only shown Antenna A Plot.

TX CH 01

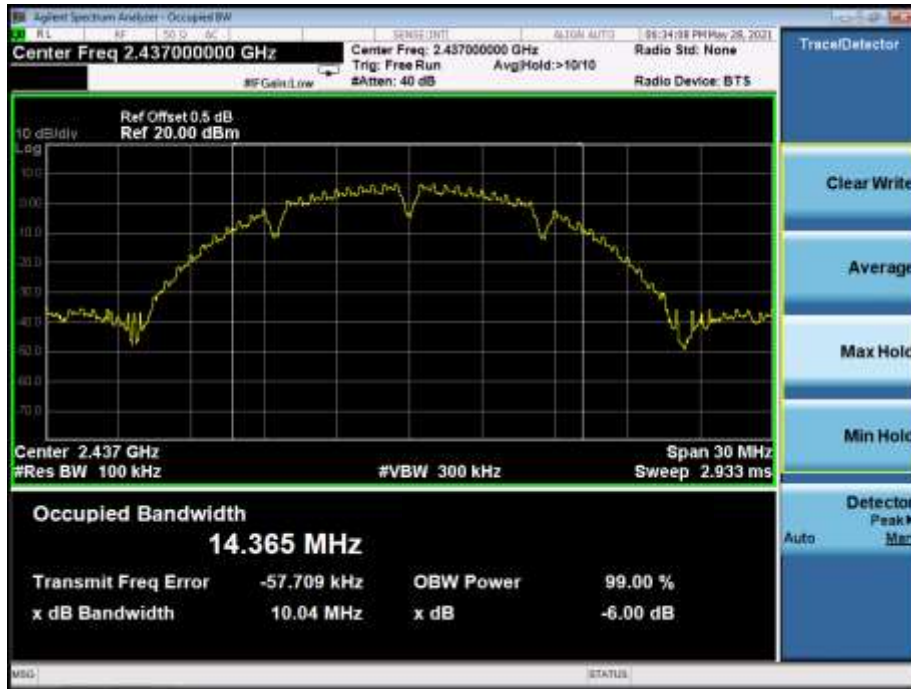

TX CH 06

TX CH 11

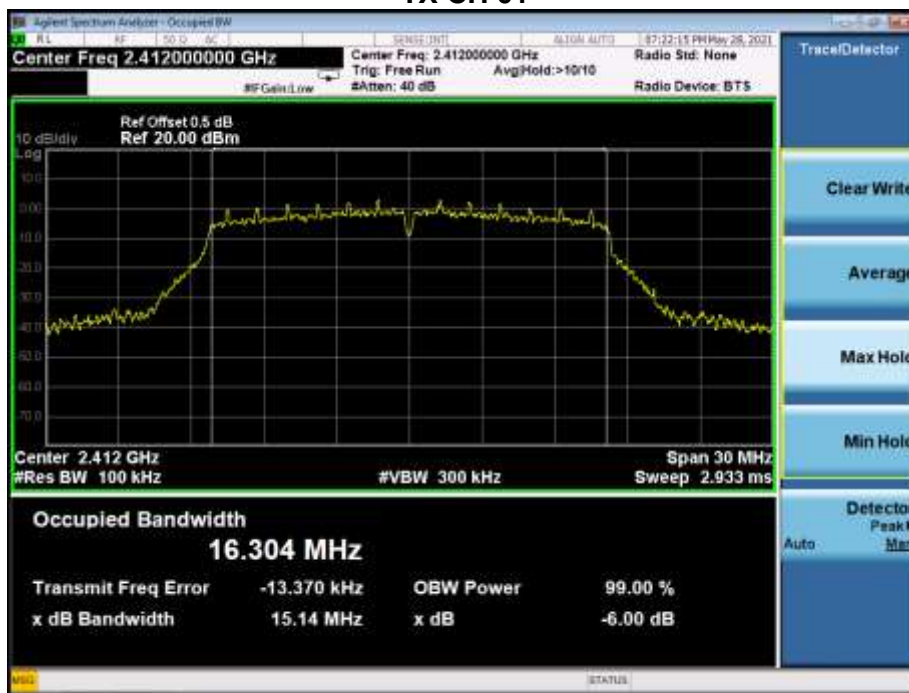

Temperature :	26 °C	Relative Humidity :	54%
Pressure :	101kPa	Test Voltage :	AC120V/60Hz
Test Mode :	TX g Mode		

Frequency (MHz)	6dB bandwidth (MHz) ANTA	6dB bandwidth (MHz) ANTB	Limit (kHz)	Result
2412	13.91	15.14	500	Pass
2437	15.14	15.08	500	Pass
2462	15.14	15.09	500	Pass

Note: A(B) Represent the value of antenna A and B, The worst data is Antenna B, only shown Antenna B Plot.

TX CH 01

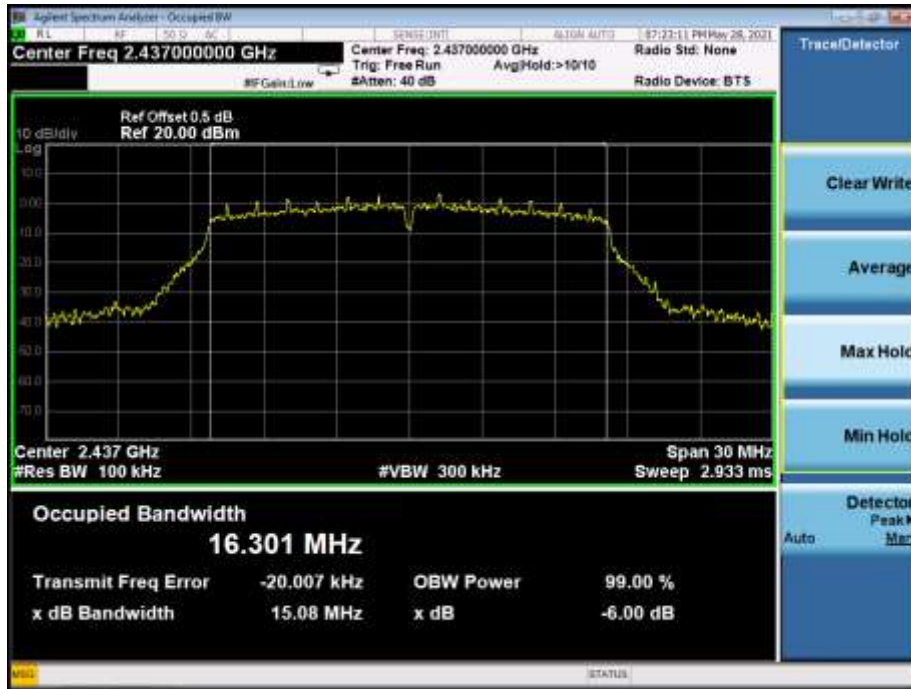

TX CH 06

TX CH 11



Temperature :	26 °C	Relative Humidity :	54%
Pressure :	101kPa	Test Voltage :	AC120V/60Hz
Test Mode :	TX n Mode(20M)		

Frequency (MHz)	6dB bandwidth (MHz) ANTA	6dB bandwidth (MHz) ANTB	Limit (kHz)	Result
2412	15.10	15.03	500	Pass
2437	15.13	15.14	500	Pass
2462	15.15	15.11	500	Pass

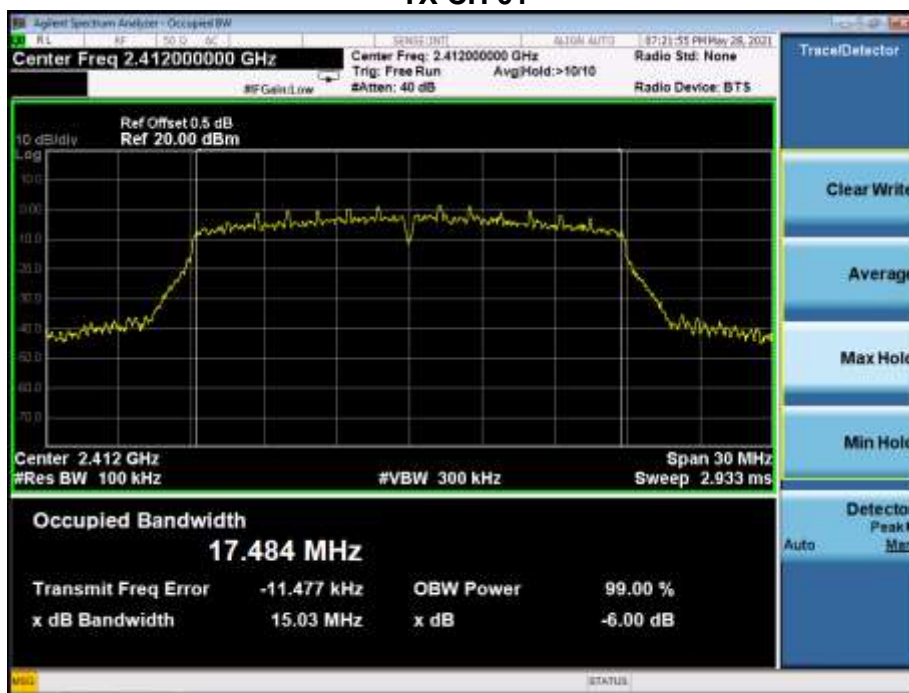
Note: A(B) Represent the value of antenna A and B, The worst data is Antenna B, only shown Antenna B Plot.

TX CH 01

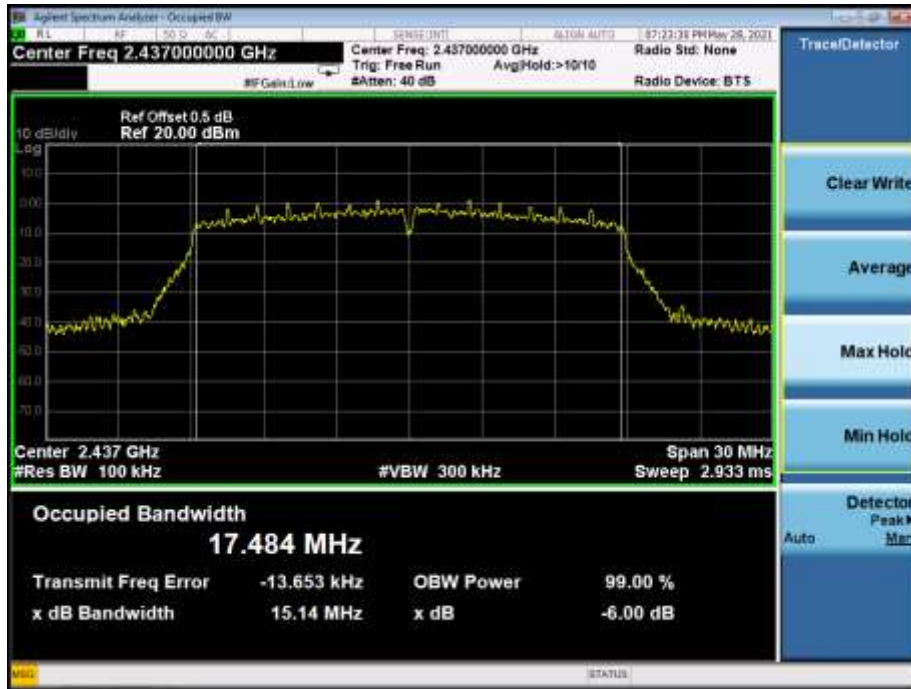

TX CH 06

TX CH 11



Temperature :	26 °C	Relative Humidity :	54%
Pressure :	101kPa	Test Voltage :	AC120V/60Hz
Test Mode :	TX n Mode(40M)		

Frequency (MHz)	6dB bandwidth (MHz) ANTA	6dB bandwidth (MHz) ANTB	Limit (kHz)	Result
2422	35.12	35.11	500	Pass
2437	35.08	35.13	500	Pass
2452	35.13	35.13	500	Pass

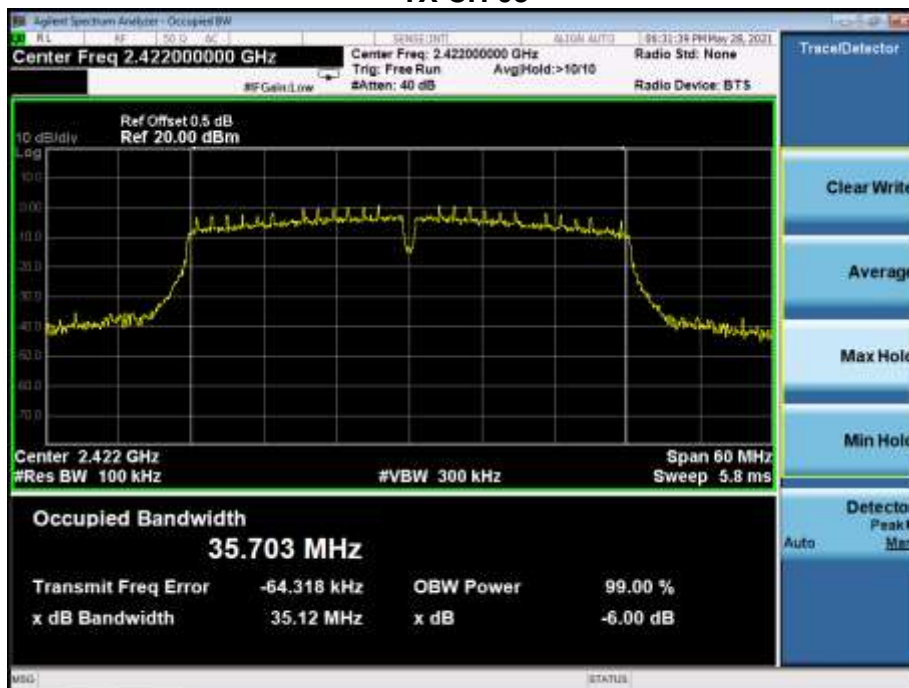
Note: A(B) Represent the value of antenna A and B, The worst data is Antenna A, only shown Antenna A Plot.

TX CH 03

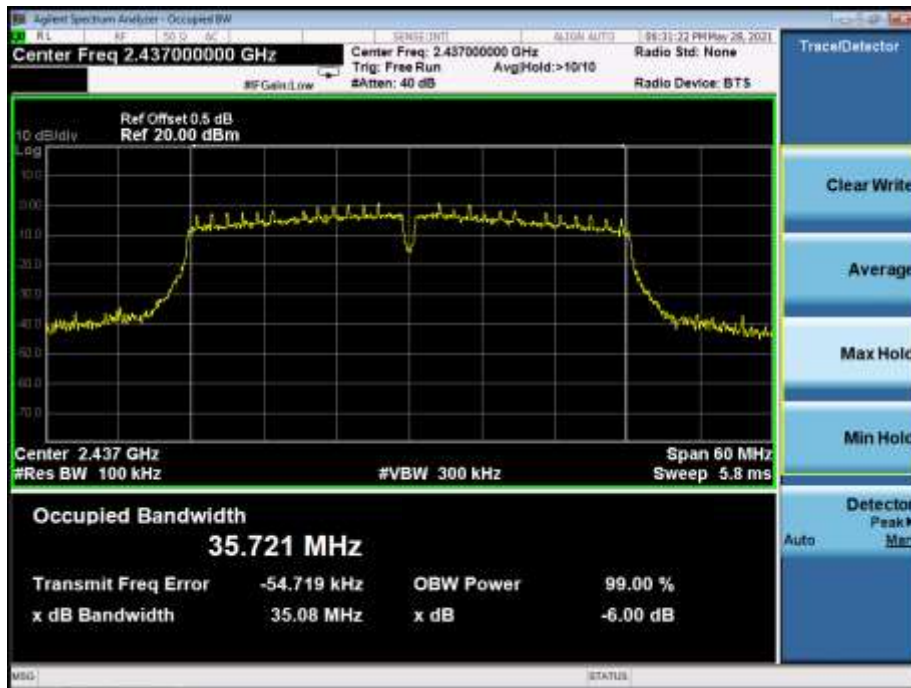
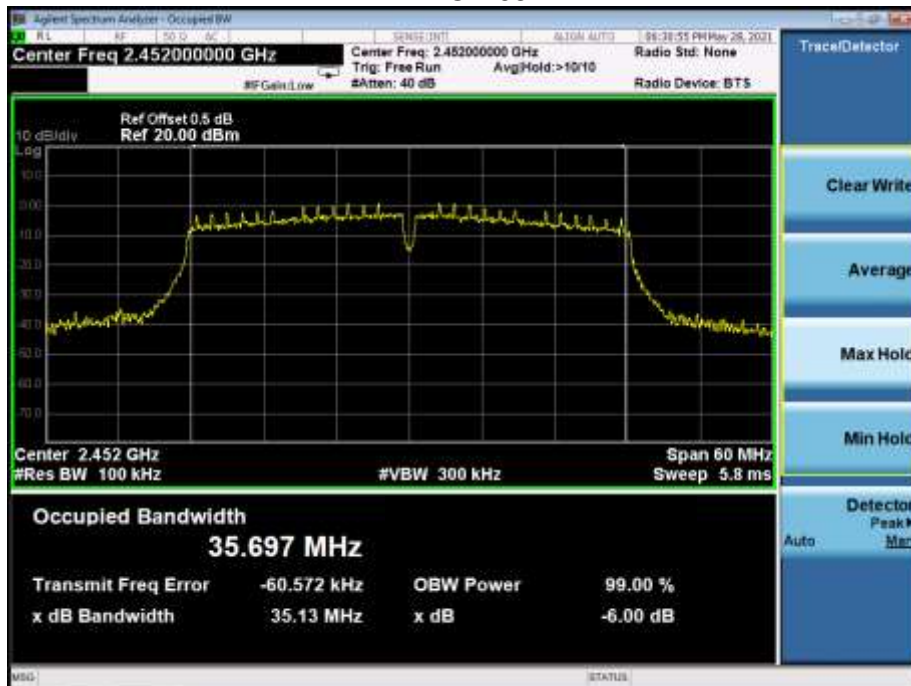

TX CH 06

TX CH 09

7. PEAK OUTPUT POWER TEST

7.1 APPLIED PROCEDURES/LIMIT

FCC Part15 (15.247) , Subpart C				
Section	Test Item	Limit	Frequency Range (MHz)	Result
15.247(b)(3)	Peak Output Power	1 watt or 30dBm	2400-2483.5	PASS

7.1.1 TEST PROCEDURE

- a. The EUT was directly connected to the Power meter

7.1.2 DEVIATION FROM STANDARD

No deviation.

7.1.3 TEST SETUP



7.1.4 EUT OPERATION CONDITIONS

The EUT tested system was configured as the statements of 2.4 Unless otherwise a special operating condition is specified in the follows during the testing.

7.1.5 TEST RESULTS

Temperature :	26 °C	Relative Humidity :	54%
Pressure :	101kPa	Test Voltage :	AC120V/60Hz

Note:Antenna A gain: 2.3dBi, Antenna B gain: 2.3dBi, The Array gain=0 dB for NANT \leq 4,
So the directional gain for Power measurements is 5.31dBi

Test Mode	Frequency	Maximum Conducted Output Power(PK) ANTA	Maximum Conducted Output Power(PK) ANTB	Total Power Conducted Output Power(PK)	LIMIT
	(MHz)	(dBm)	(dBm)	(dBm)	dBm
802.11b	2412	17.329	17.217	/	30
	2437	17.855	17.522	/	30
	2462	17.334	17.163	/	30
802.11g	2412	16.960	16.127	/	30
	2437	16.964	16.545	/	30
	2462	16.576	16.742	/	30
802.11n20	2412	15.280	15.172	18.237	30
	2437	15.376	15.398	18.397	30
	2462	15.316	15.383	18.360	30
802.11n40	2422	14.882	14.439	17.676	30
	2437	14.955	14.152	17.582	30
	2452	14.059	14.526	17.309	30

8. 100 KHZ BANDWIDTH OF FREQUENCY BAND EDGE

8.1 APPLICABLE STANDARD

in any 100 kHz bandwidth outside the frequency bands in which the spread spectrum intentional radiator is operating, the radio frequency power that is produced by the intentional radiator shall be at least 20dB below that in the 100kHz bandwidth within the band that contains the highest level of the desired power, In addition, radiated emissions which fall in the restricted bands, as defined in§15.205(a), must also comply with the radiated emission limits specified in15.209(a).

8.2 TEST PROCEDURE

Using the following spectrum analyzer setting:

- a) Set the RBW = 100KHz.
- b) Set the VBW = 300KHz.
- c) Sweep time = auto couple.
- d) Detector function = peak.
- e) Trace mode = max hold.
- f) Allow trace to fully stabilize.

8.3 DEVIATION FROM STANDARD

No deviation.

8.4 TEST SETUP



8.5 EUT OPERATION CONDITIONS

The EUT tested system was configured as the statements of 2.4 Unless otherwise a special operating condition is specified in the follows during the testing.

8.6 TEST RESULTS

Note: A(B) Represent the value of antenna A and B, The worst data is Antenna A, only shown Antenna A Plot.

802.11b: Band Edge, Left Side



802.11b: Band Edge, Right Side



802.11g: Band Edge, Left Side



802.11g: Band Edge, Right Side



802.11n-HT20: Band Edge, Left Side

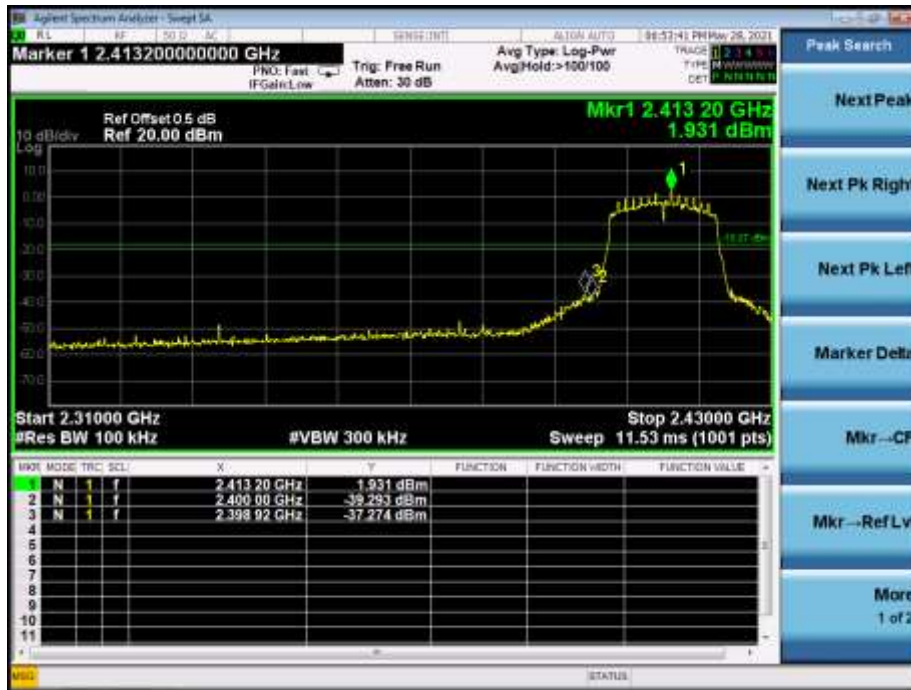

802.11n-HT20: Band Edge, Right Side



802.11n-HT40: Band Edge, Left Side



802.11n-HT40: Band Edge, Right Side



CONDUCTED EMISSION MEASUREMENT

Note: A(B) Represent the value of antenna A and B, The worst data is Antenna A ,only shown Antenna A Plot.
802.11b

Low Channel 2412MHz



Middle Channel 2437MHz

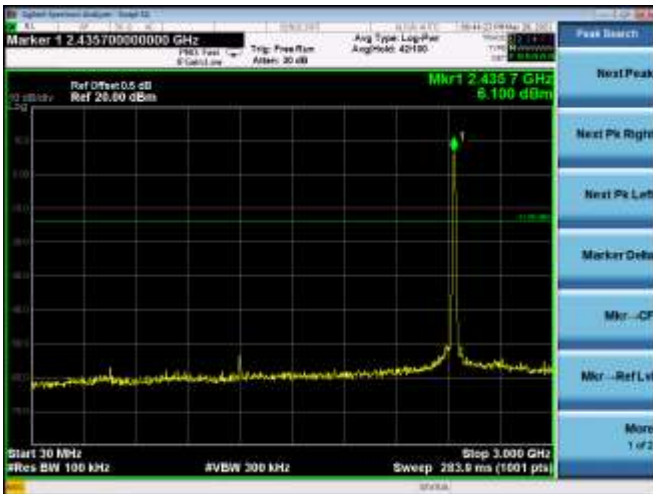

High Channel 2462MHz



802.11g

Low Channel 2412MHz

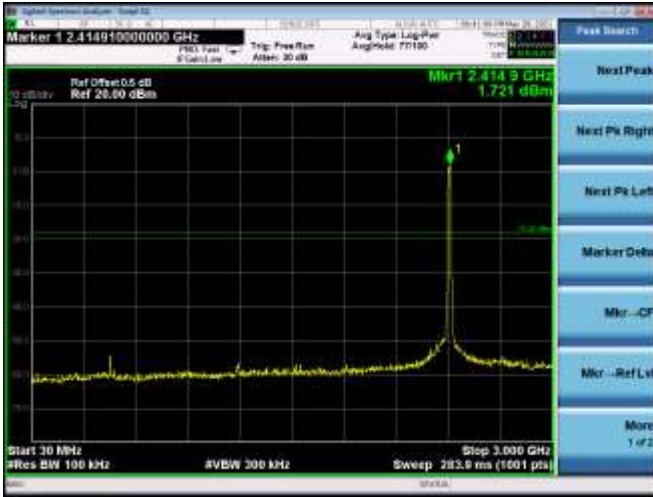

Middle Channel 2437MHz



High Channel 2462MHz

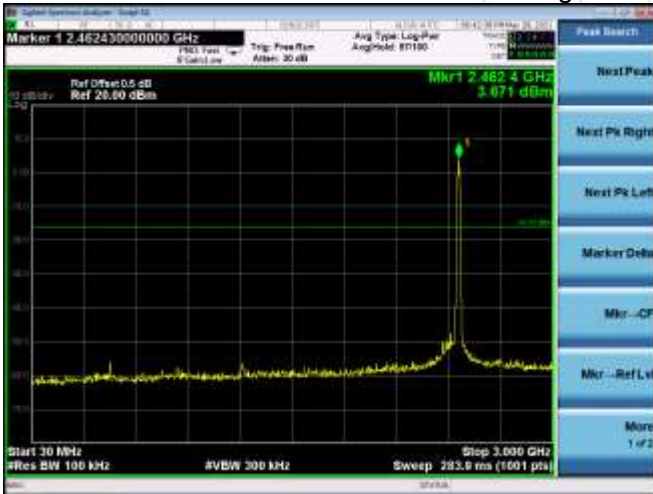

802.11n20

Low Channel 2412MHz

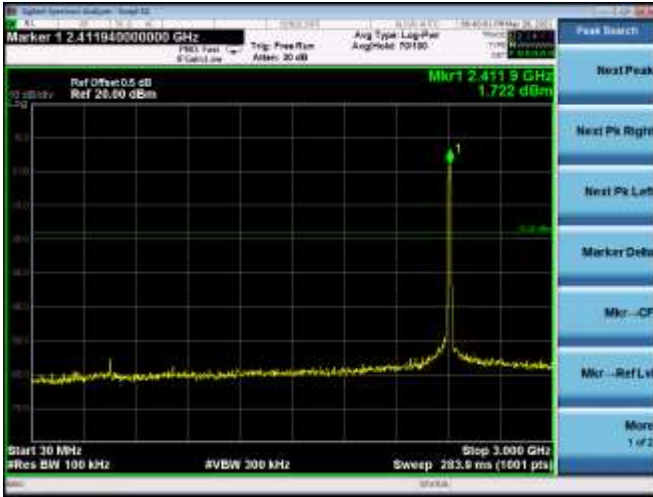

Middle Channel 2437MHz



High Channel 2462MHz



802.11n40

Low Channel 2422MHz



Middle Channel 2437MHz

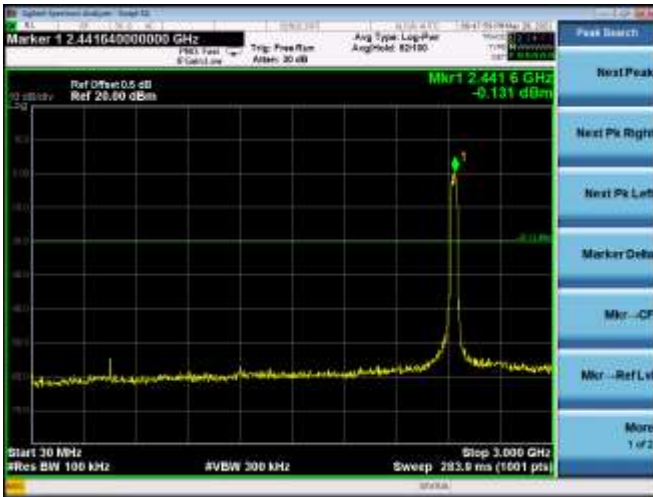

High Channel 2452MHz

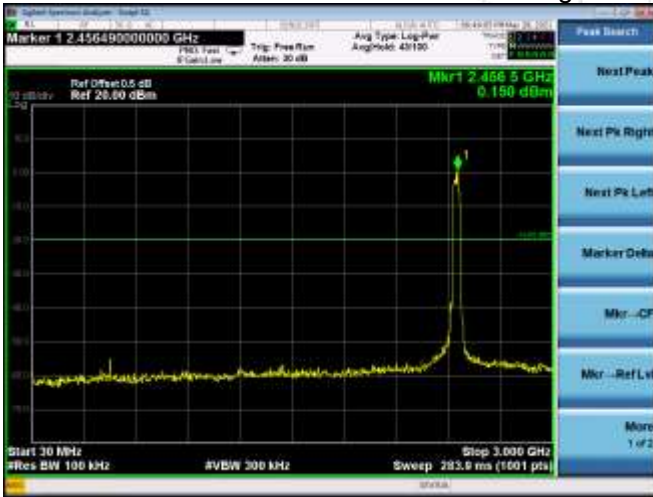

9. DUTY CYCLE OF TEST SIGNAL

9.1 STANDARD REQUIREMENT

Pre-analysis Check: While conducting average power measurement, duty cycle of each mode shall be checked to ensure its duty cycle in order to compensate for the loss due to insufficient ratio of duty cycle.

All duty cycle is pre-scanned, and result as obtained below shows only the most representative ones where duty cycle is conducted as the given transmission with given virtual operation that expresses the percentage.

9.2 FORMULA:

Duty Cycle = $T_{on} / (T_{on} + T_{off})$

Measurement Procedure:

1. Set span = Zero
2. RBW = 8MHz
3. VBW = 8MHz,
4. Detector = Peak

Duty Cycle:

	Duty Cycle	Duty Fator (dB)
802.11b	1	0
802.11g	1	0
802.11n(HT20)	1	0
802.11n(HT40)	1	0

Note: A(B) Represent the value of antenna A and B, The worst data is Antenna A ,only shown Antenna A Plot.

802.11b

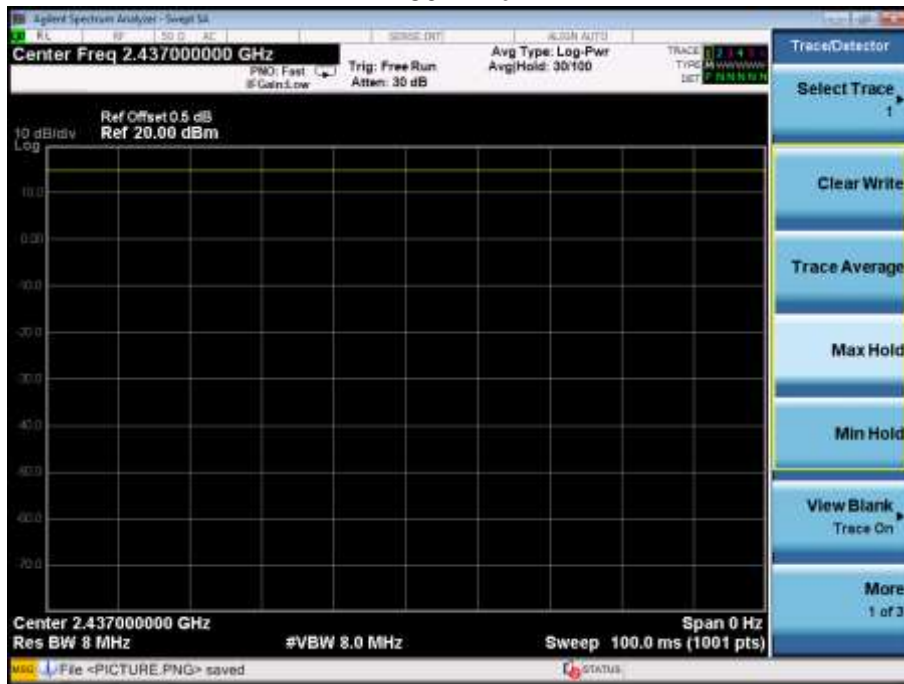

802.11g

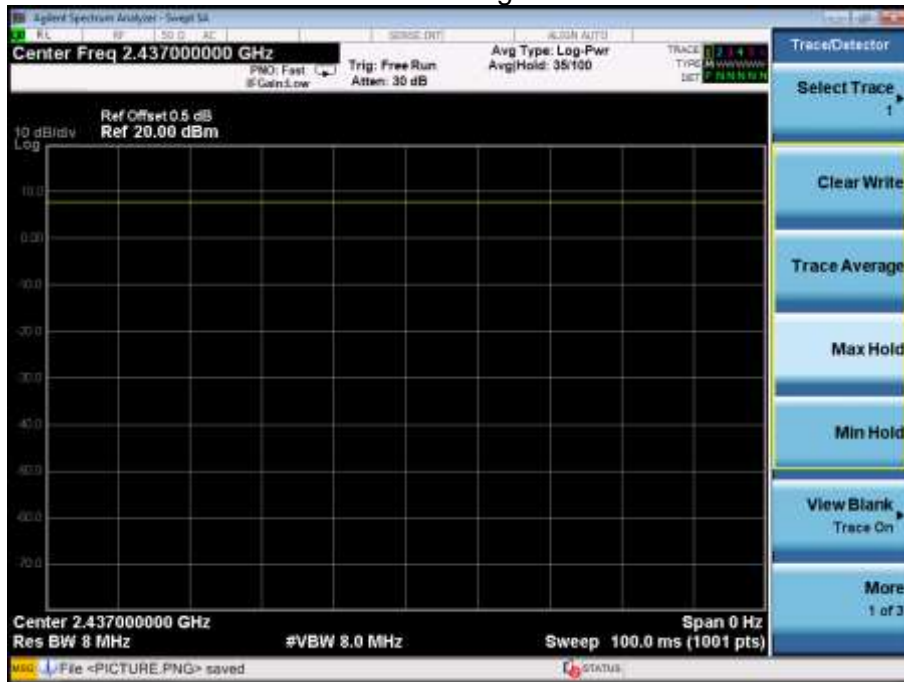

802.11n(HT20)

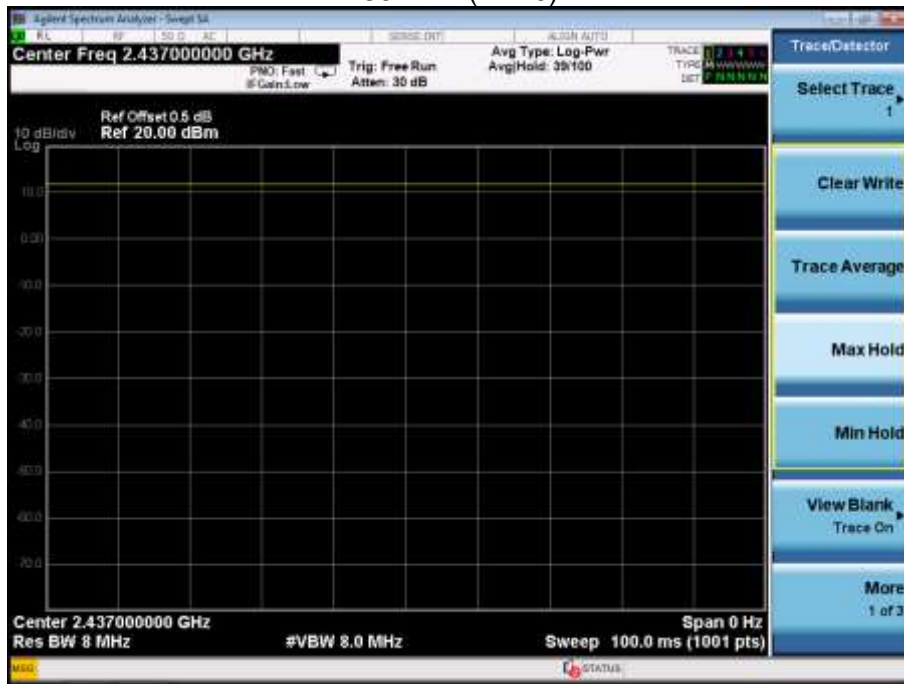

802.11n(HT40)



10. ANTENNA REQUIREMENT

10.1 STANDARD REQUIREMENT

15.203 requirement: For intentional device, according to 15.203: an intentional radiator shall be designed to ensure that no antenna other than that furnished by the responsible party shall be used with the device.

10.2 EUT ANTENNA

The EUT antenna is IFA antenna, antenna(A) Gain 2.3dBi, antenna(B) Gain 2.3dBi, impedance 50Ω. It comply with the standard requirement.

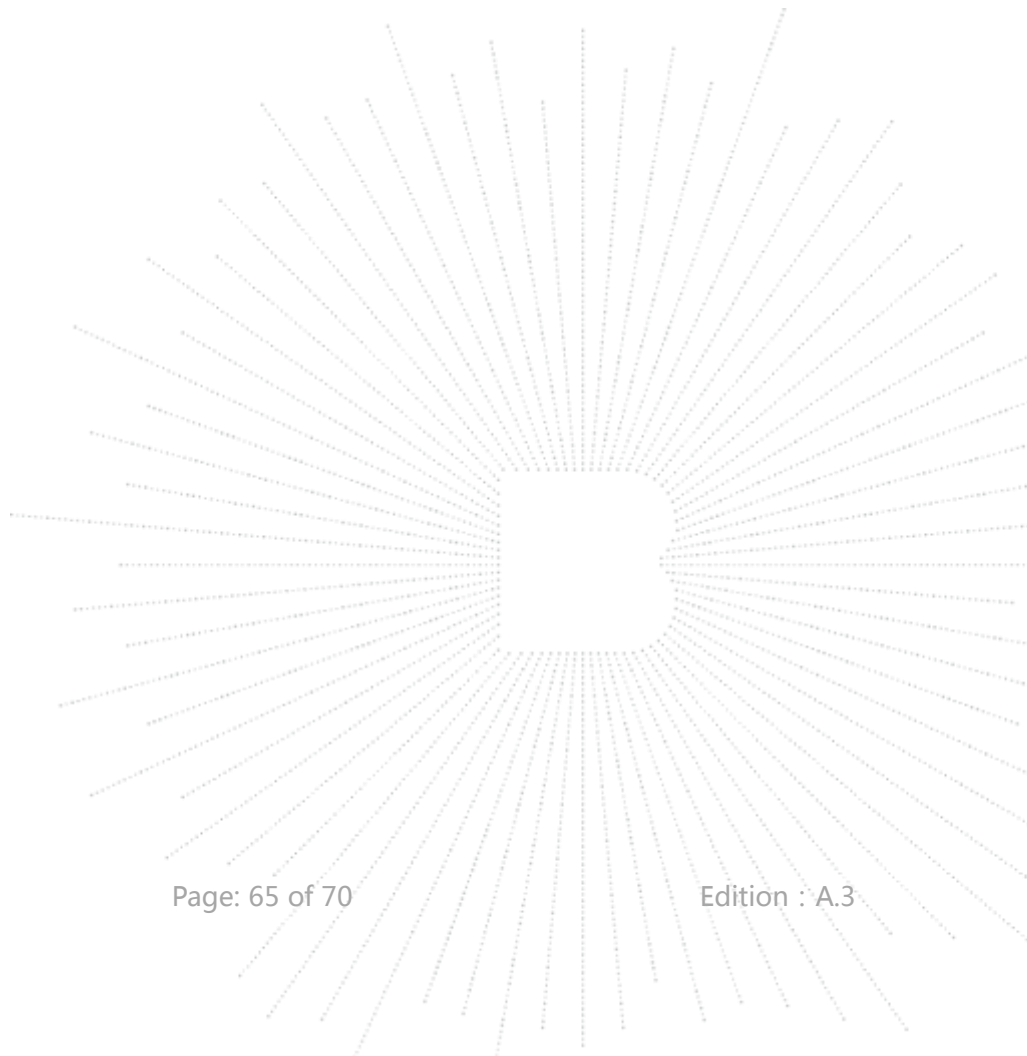

11. EUT PHOTOGRAPHS

EUT Photo 1

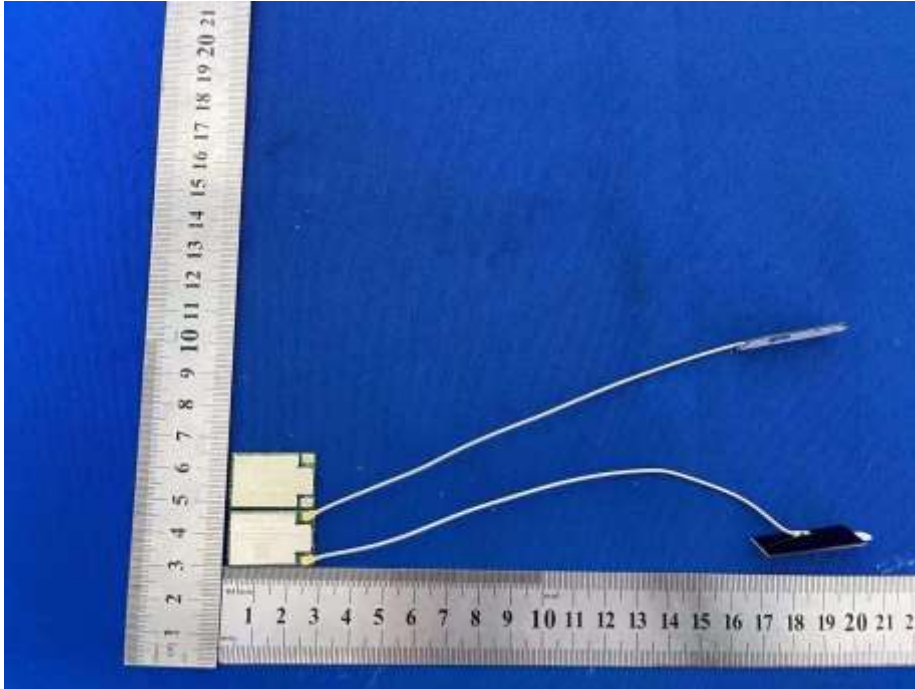

EUT Photo 2

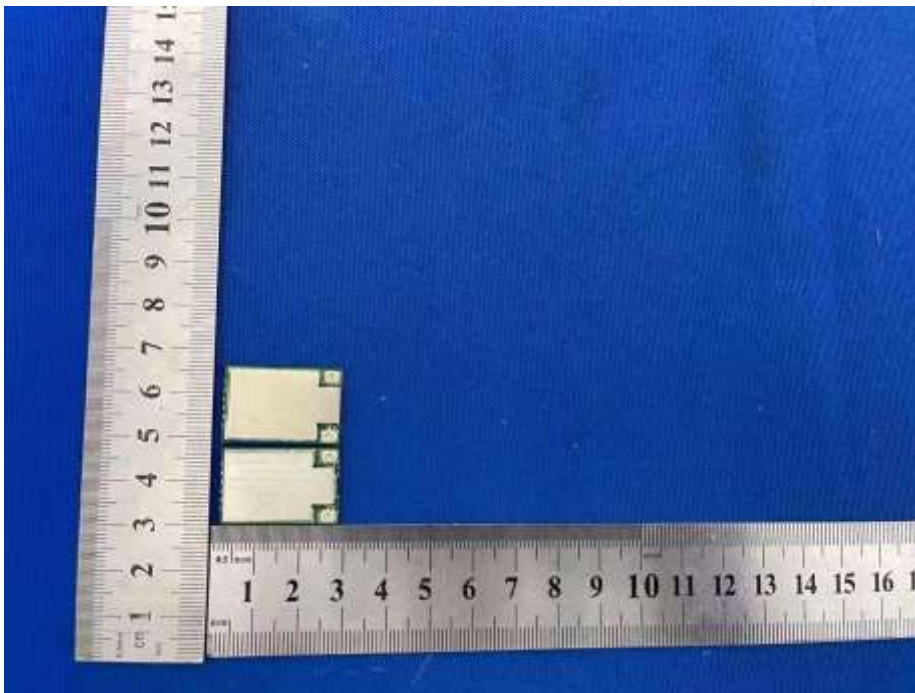

EUT Photo 3

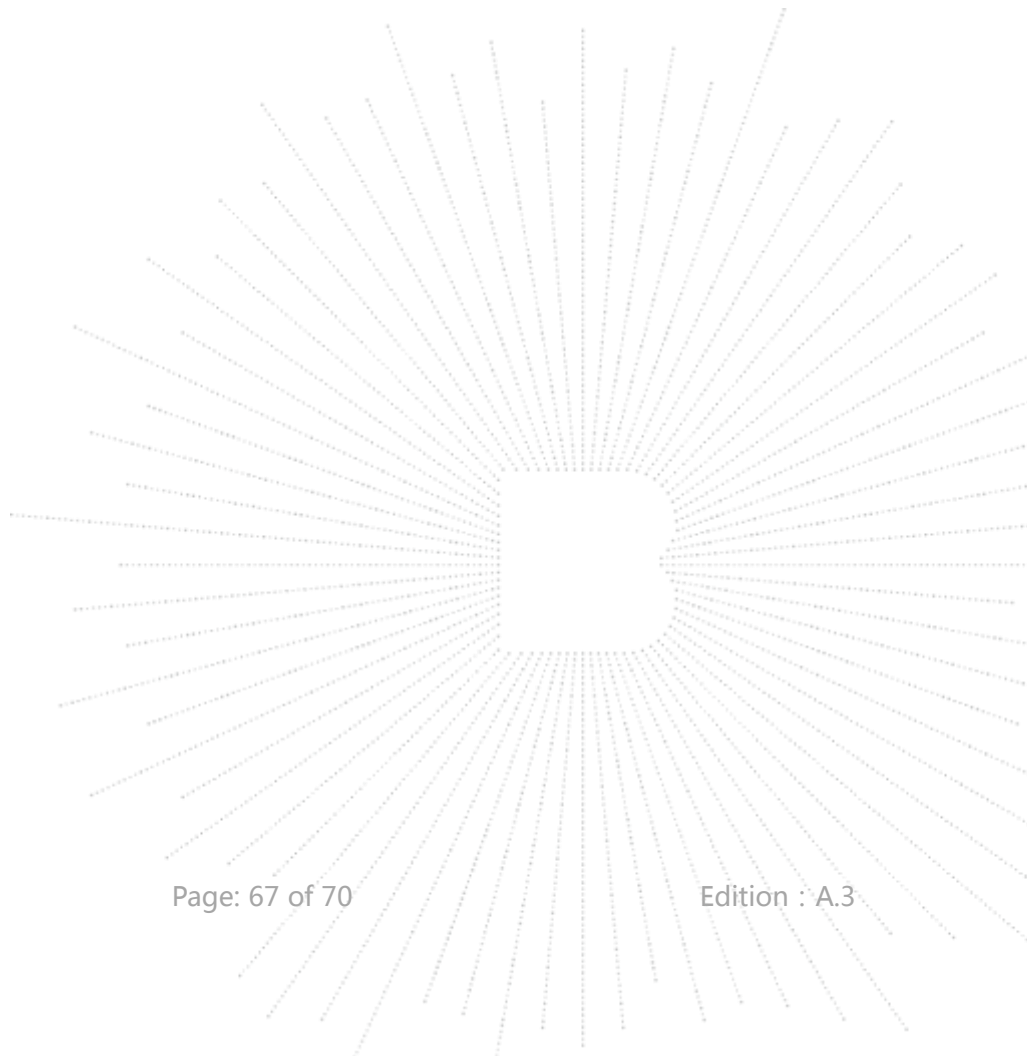

12. EUT TEST SETUP PHOTOGRAPHS

Conducted emissions



Radiated Measurement Photos



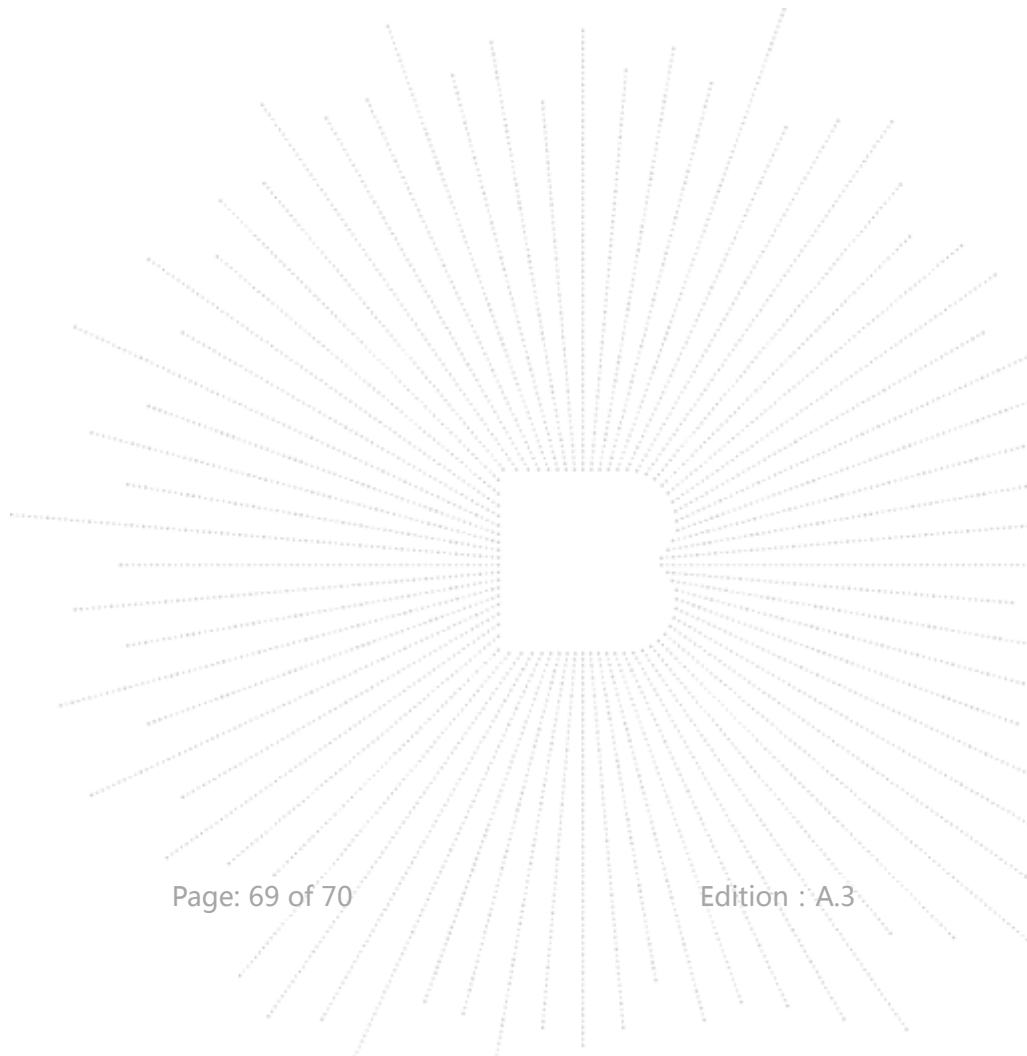
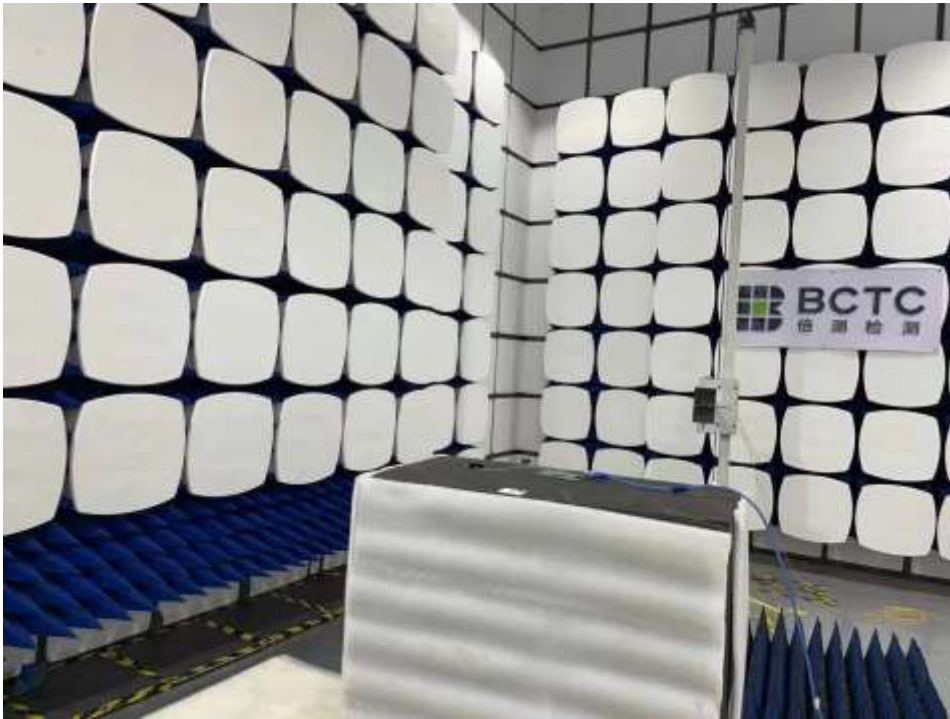

STATEMENT

- 1.The equipment lists are traceable to the national reference standards.
- 2.The test report can not be partially copied unless prior written approval is issued from our lab.
- 3.The test report is invalid without stamp of laboratory.
- 4.The test report is invalid without signature of person(s) testing and authorizing.
- 5.The test process and test result is only related to the Unit Under Test.
- 6.The quality system of our laboratory is in accordance with ISO/IEC17025.
- 7.If there is any objection to report, the client should inform issuing laboratory within 15 days from the date of receiving test report.

Address:

1-2/F., Building B, Pengzhou Industrial Park, No.158, Fuyuan 1st Road, Tangwei, Fuhai Subdistrict, Bao'an District, Shenzhen, Guangdong, China

TEL : 400-788-9558

P. C.: 518103

FAX : 0755-33229357

Website : <http://www.chnbctc.com>

E-Mail : bctc@bctc-lab.com.cn

***** END *****