

TEST REPORT

Report No.: BCTC2102419658E

Applicant: CHINA DRAGON TECHNOLOGY LIMITED

Product Name: WLAN 11n USB 2T2R module

Model/Type Ref.: CDW-947603U-00

Tested Date: 2021-02-02 to 2021-02-24

Issued Date: 2021-02-24

Shenzhen **BCTC** Testing Co., Ltd.



FCC ID: ROW-CDW947603U00

Product Name: WLAN 11n USB 2T2R module
Trademark: N/A
Model/Type Ref.: CDW-947603U-00
Prepared For: CHINA DRAGON TECHNOLOGY LIMITED
Address: B4 Bidg.haosan No.1 Industry Park,Shajing street, B, Shenzhen, China
Manufacturer: CHINA DRAGON TECHNOLOGY LIMITED
Address: B4 Bidg.haosan No.1 Industry Park,Shajing street, B, Shenzhen, China
Prepared By: Shenzhen BCTC Testing Co., Ltd.
Address: 1-2/F., Building B, Pengzhou Industrial Park, No.158, Fuyuan 1st Road, Tangwei, Fuhai Subdistrict, Bao'an District, Shenzhen, Guangdong, China
Sample Received Date: 2021-02-02
Sample tested Date: 2021-02-02 to 2021-02-24
Issue Date: 2021-02-24
Report No.: BCTC2102419658E
FCC Part15.247
Test Standards ANSI C63.10:2013
KDB 662911 D01 v02r01
558074 D01 15.247 Meas Guidance v05r02
Test Results PASS

Tested by:

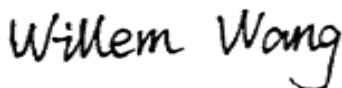
Willem Wang/Project Handler

Approved by:

Zero Zhou/Reviewer

The test report is effective only with both signature and specialized stamp. This result(s) shown in this report refer only to the sample(s) tested. Without written approval of Shenzhen BCTC Testing Co., Ltd, this report can't be reproduced except in full. The tested sample(s) and the sample information are provided by the client.

Table of Contents

	Page
1 .VERSION	6
2 . SUMMARY OF TEST RESULTS	7
2.1 MEASUREMENT UNCERTAINTY	8
3 . GENERAL INFORMATION	9
3.1 GENERAL DESCRIPTION OF EUT	9
3.2 DESCRIPTION OF TEST MODES	10
3.3 BLOCK DIGRAM SHOWING THE CONFIGURATION OF SYSTEM TESTED	11
3.4 DESCRIPTION OF SUPPORT UNITS(CONDUCTED MODE)	11
3.5 EQUIPMENTS LIST FOR ALL TEST ITEMS	12
3.5.1TEST FACILITY	12
4 . EMC EMISSION TEST	14
4.1 CONDUCTED EMISSION MEASUREMENT	14
4.1.1 POWER LINE CONDUCTED EMISSION LIMITS	14
4.1.2 TEST PROCEDURE	14
4.1.3 DEVIATION FROM TEST STANDARD	14
4.1.4 TEST SETUP	15
4.1.5 EUT OPERATING CONDITIONS	15
4.1.6 TEST RESULTS	16
4.2 RADIATED EMISSION MEASUREMENT	18
4.2.1 RADIATED EMISSION LIMITS	18
4.2.2 TEST PROCEDURE	19
4.2.3 DEVIATION FROM TEST STANDARD	19
4.2.4 TEST SETUP	20
4.2.5 EUT OPERATING CONDITIONS	21
4.2.6 TEST RESULTS (BETWEEN 9KHZ – 30 MHZ)	22
4.2.7 TEST RESULTS (BETWEEN 30MHZ – 1GHZ)	23
4.2.8 TEST RESULTS	25
4.3 RADIATED BAND EMISSION MEASUREMENT	29
4.3.1 TEST REQUIREMENT:	29
4.3.2 TEST PROCEDURE	29
4.3.3 DEVIATION FROM TEST STANDARD	30
4.3.4 TEST SETUP	30
4.3.5 EUT OPERATING CONDITIONS	30

Table of Contents

	Page
5 . POWER SPECTRAL DENSITY TEST	33
5.1 APPLIED PROCEDURES / LIMIT	33
5.1.1 TEST PROCEDURE	33
5.1.2 DEVIATION FROM STANDARD	33
5.1.3 TEST SETUP	33
5.1.4 EUT OPERATION CONDITIONS	33
5.1.5 TEST RESULTS	34
6 . BANDWIDTH TEST	42
6.1 APPLIED PROCEDURES / LIMIT	42
6.1.1 TEST PROCEDURE	42
6.1.2 DEVIATION FROM STANDARD	42
6.1.3 TEST SETUP	42
6.1.4 EUT OPERATION CONDITIONS	42
6.1.5 TEST RESULTS	43
7 . PEAK OUTPUT POWER TEST	51
7.1 APPLIED PROCEDURES/LIMIT	51
7.1.1 TEST PROCEDURE	51
7.1.2 DEVIATION FROM STANDARD	51
7.1.3 TEST SETUP	51
7.1.4 EUT OPERATION CONDITIONS	51
7.1.5 TEST RESULTS	52
8 . 100 KHZ BANDWIDTH OF FREQUENCY BAND EDGE	53
8.1 APPLICABLE STANDARD	53
8.2 TEST PROCEDURE	53
8.3 DEVIATION FROM STANDARD	53
8.4 TEST SETUP	53
8.5 EUT OPERATION CONDITIONS	53
9 . DUTY CYCLE OF TEST SIGNAL	63
9.1 STANDARD REQUIREMENT	63
9.2 FORMULA:	63
10 . ANTENNA REQUIREMENT	66
10.1 STANDARD REQUIREMENT	66
10.2 EUT ANTENNA	66

Table of Contents

	Page
11 . EUT TEST PHOTO	67
12 . EUT PHOTO	70
APPENDIX-PHOTOGRAPHS OF EUT CONSTRUCTIONAL DETAILS	

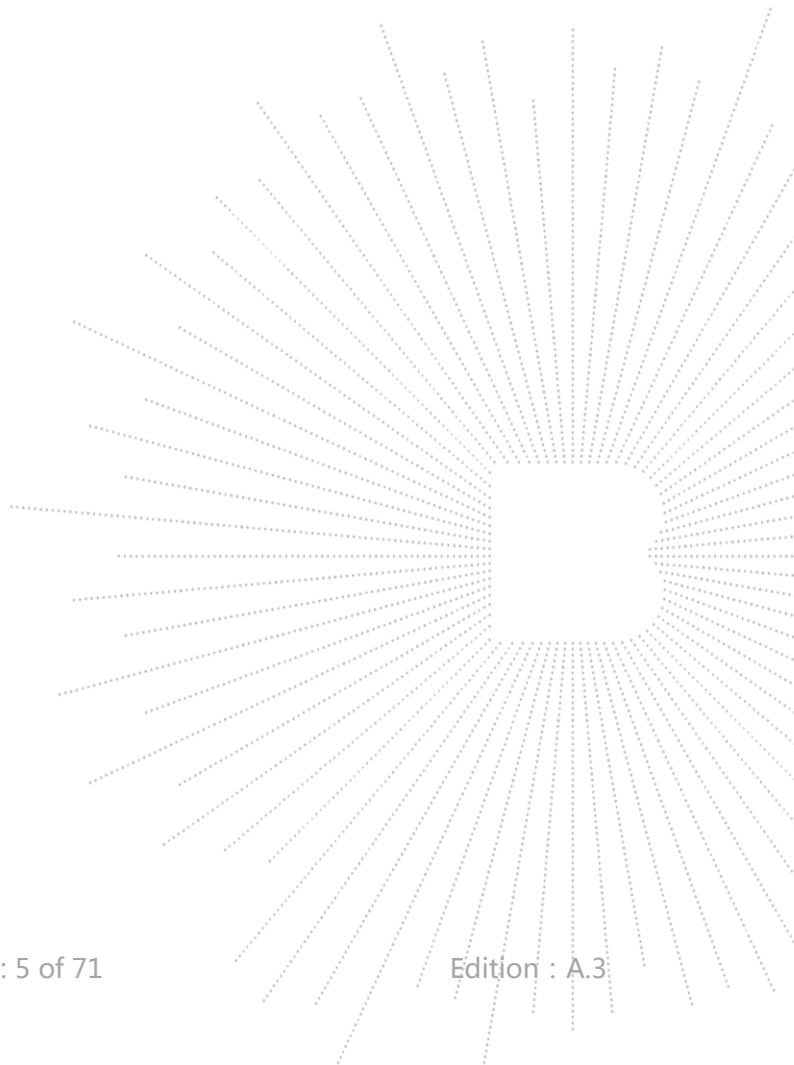

1.VERSION

Report No.	Issue Date	Description	Approved
BCTC2102419658E	2021-02-24	Original	Valid

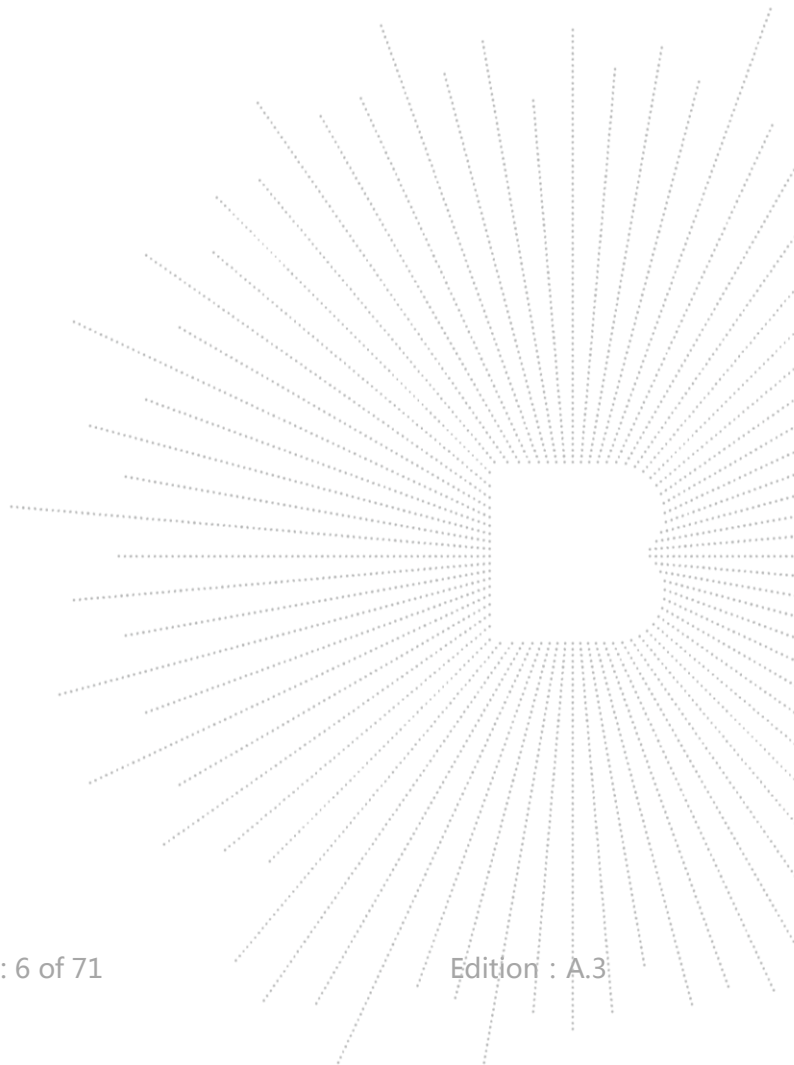

2. SUMMARY OF TEST RESULTS

Test procedures according to the technical standards:

FCC Part15 (15.247) , Subpart C			
Standard Section	Test Item	Judgment	Remark
15.207	Conducted Emission	PASS	
15.247 (a)(2)	6dB Bandwidth	PASS	
15.247 (b)	Peak Output Power	PASS	
15.247 (d)	Radiated Spurious Emission	PASS	
15.247 (e)	Power Spectral Density	PASS	
15.205	Restricted Band of Operation	PASS	
15.247 (d)	Band Edge (Out of Band Emissions)	PASS	
15.203	Antenna Requirement	PASS	

NOTE:

(1) "N/A" denotes test is not applicable in this Test Report

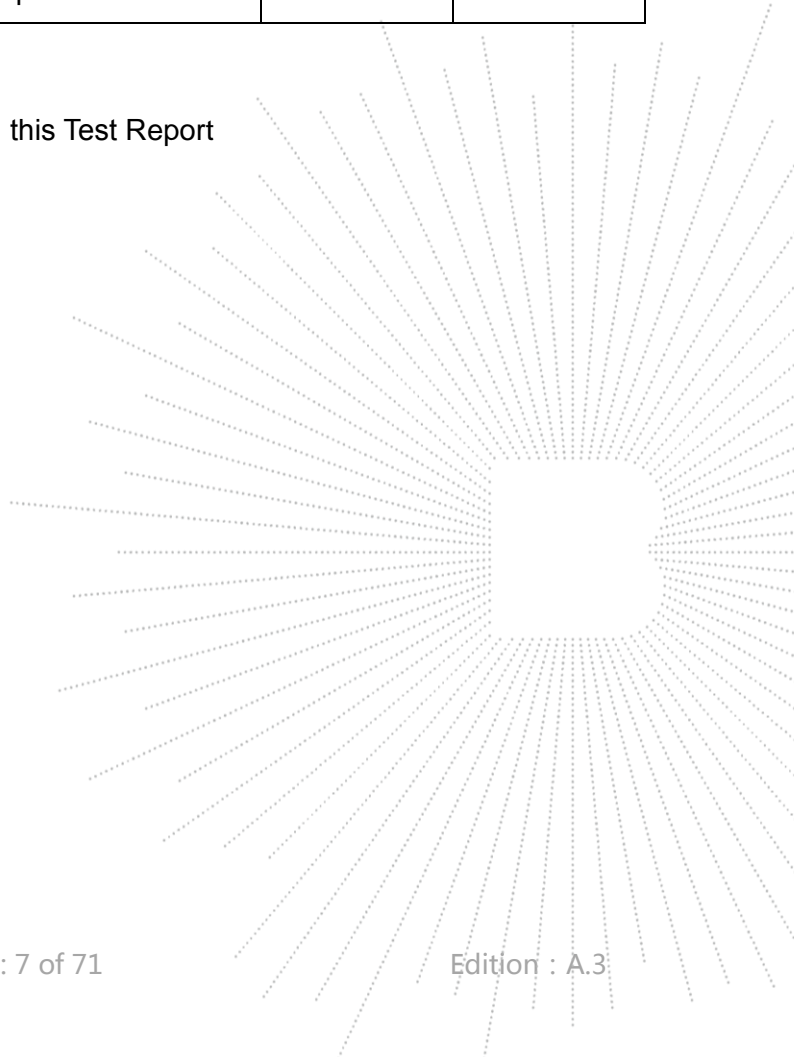

2.1 MEASUREMENT UNCERTAINTY

The reported uncertainty of measurement $y \pm U$, where expanded uncertainty U is based on a standard uncertainty multiplied by a coverage factor of $k=2$, providing a level of confidence of approximately **95 %**.

No.	Item	Uncertainty
1	3m chamber Radiated spurious emission(30MHz-1GHz)	U=4.3dB
2	3m chamber Radiated spurious emission(1GHz-18GHz)	U=4.5dB
3	3m chamber Radiated spurious emission(18GHz-40GHz)	U=3.34dB
4	Conducted Adjacent channel power	U=1.38dB
5	Conducted output power uncertainty Above 1G	U=1.576dB
6	Conducted output power uncertainty below 1G	U=1.28dB
7	humidity uncertainty	U=5.3%
8	Temperature uncertainty	U=0.59°C

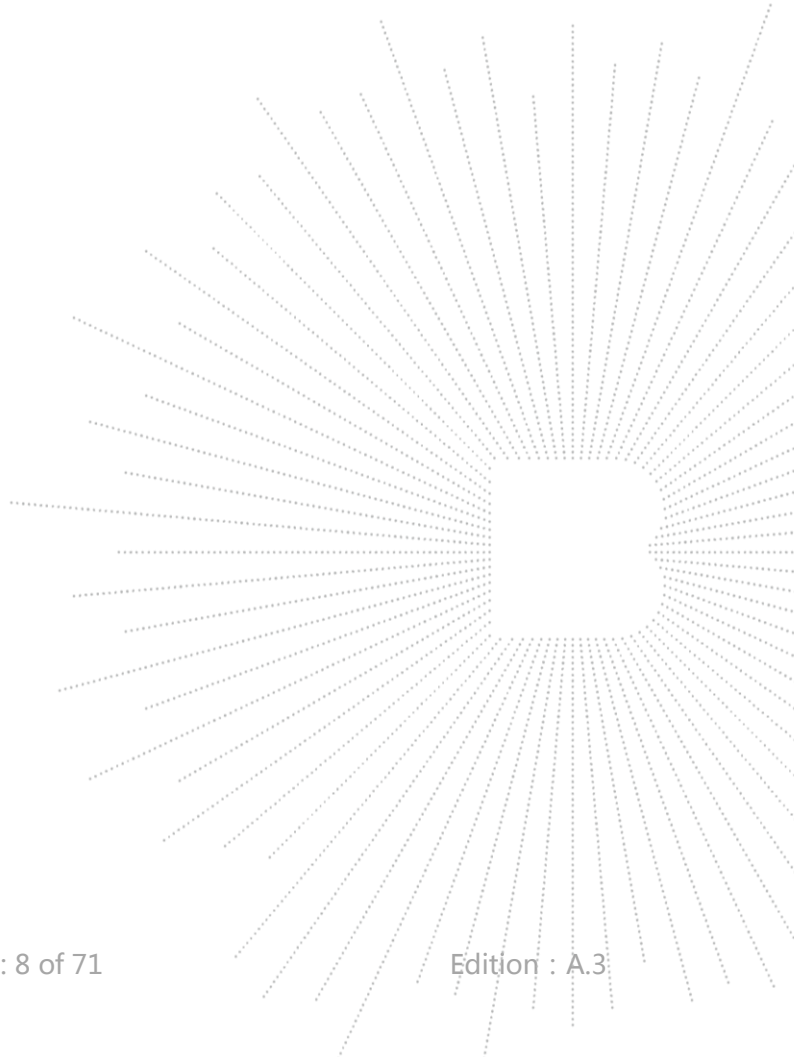

3. GENERAL INFORMATION

3.1 GENERAL DESCRIPTION OF EUT

Model/Type Ref.:	CDW-947603U-00
Model differences:	N/A
Hardware Version:	N/A
Software Version:	N/A
Operation Frequency:	802.11b/g/n20MHz:2412~2462 MHz 802.11n40MHz:2422~2452 MHz
Bit Rate of Transmitter	802.11b:11/5.5/2/1 Mbps 802.11g:54/48/36/24/18/12/9/6Mbps 802.11n Up to 300Mbps
Type of Modulation:	WIFI: OFDM/DSSS
Number Of Channel	802.11b/g/n20MHz:11 CH 802.11n40MHz: 7 CH
Antenna installation:	External antenna*2
Antenna Gain:	Antenna A: 2dBi Antenna B: 2dBi
Ratings:	DC 5V

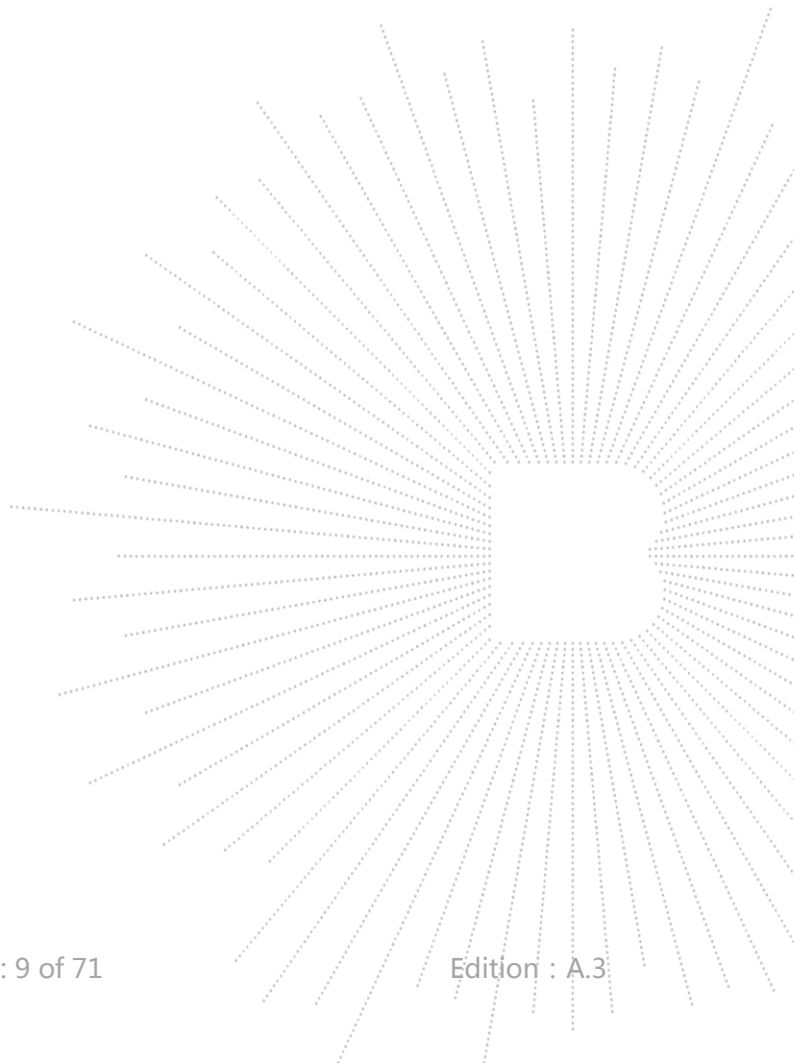

1.

Channel List for 802.11b/g/n(20)							
Channel	Frequency (MHz)	Channel	Frequency (MHz)	Channel	Frequency (MHz)	Channel	Frequency (MHz)
01	2412	04	2427	07	2442	10	2457
02	2417	05	2432	08	2447	11	2462
03	2422	06	2437	09	2452		

Channel List for 802.11n(40)							
Channel	Frequency (MHz)	Channel	Frequency (MHz)	Channel	Frequency (MHz)	Channel	Frequency (MHz)
03	2422	05	2432	07	2442	09	2452
04	2427	06	2437	08	2447		

2

Table for External antenna

Ant.	Brand	Model Name	Antenna Type	Gain (dBi)	NOTE
A	N/A	N/A	External antenna	2	
B	N/A	N/A	External antenna	2	

EUT has two External antennas with Max gain GANT 5dBi on every antenna, CDD device with two spatial streams, also can operate with one spatial streams according to KDB662911 D01 v02r01,

Directional gain= GANT + Array Gain, where Array Gain is as follows.

1) For power spectral density (PSD) measurements,

Array Gain=10log(NANT/NSS)dB=10log(2/1)=3.01dB,

So the directional gain for PSD is 5.01dBi

2) For power measurements,

The Array gain=0 dB for NANT≤4,

So the directional gain for Power measurements is 2dBi

3.2 DESCRIPTION OF TEST MODES

Pretest Mode	Description
Mode 1	802.11b CH1/ CH6/ CH11
Mode 2	802.11g CH1/ CH6/ CH11
Mode 3	802.11n20 CH1/ CH6/ CH11
Mode 4	802.11n40 CH3/ CH6/ CH9
Mode 5	Link Mode

Note:

(1) The measurements are performed at all Bit Rate of Transmitter, the worst data was reported.

3.3 BLOCK DIGRAM SHOWING THE CONFIGURATION OF SYSTEM TESTED

Conducted Emission Test:

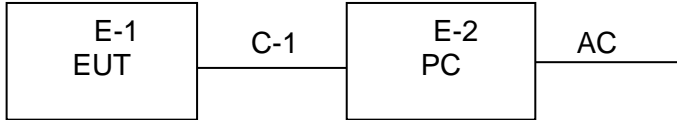

Radiated Spurious Emission:

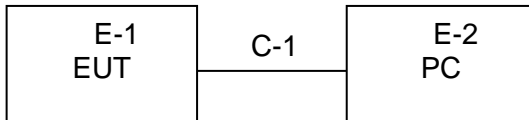

3.4 DESCRIPTION OF SUPPORT UNITS(CONDUCTED MODE)

The EUT has been tested as an independent unit together with other necessary accessories or support units. The following support units or accessories were used to form a representative test configuration during the tests.

No.	Device Type	Brand	Model	Series No.	Data Cable	Power Cord
E-1	WLAN 11n USB 2T2R module	N/A	CDW-9476 03U-00	N/A	EUT	E-1
E-2	PC	N/A	NOTE001	N/A	Auxiliary	E-2

Item	Shielded Type	Ferrite Core	Length	Note
C-1	NO	NO	0.4M	DC cable unshielded

Note:

- (1) The support equipment was authorized by Declaration of Confirmation.
- (2) For detachable type I/O cable should be specified the length in cm in 「Length」 column.

3.5 EQUIPMENTS LIST FOR ALL TEST ITEMS

3.5.1 TEST FACILITY

All measurement facilities used to collect the measurement data are located at Shenzhen BCTC Testing Co., Ltd. Address: 1-2/F., Building B, Pengzhou Industrial Park, No.158, Fuyuan 1st Road, Tangwei, Fuhai Subdistrict, Bao'an District, Shenzhen, Guangdong, China. The site and apparatus are constructed in conformance with the requirements of ANSI C63.4 and CISPR 16-1-1 other equivalent standards.

FCC Test Firm Registration Number: 712850

IC Registered No.: 23583

Conducted emissions Test					
Equipment	Manufacturer	Model#	Serial#	Last Cal.	Next Cal.
Receiver	R&S	ESR3	102075	Jun. 08, 2020	Jun. 07, 2021
LISN	R&S	ENV216	101375	Jun. 04, 2020	Jun. 03, 2021
ISN	HPX	ISN T800	S1509001	Jun. 04, 2020	Jun. 03, 2021
Software	Frad	EZ-EMC	EMC-CON 3A1	\	\

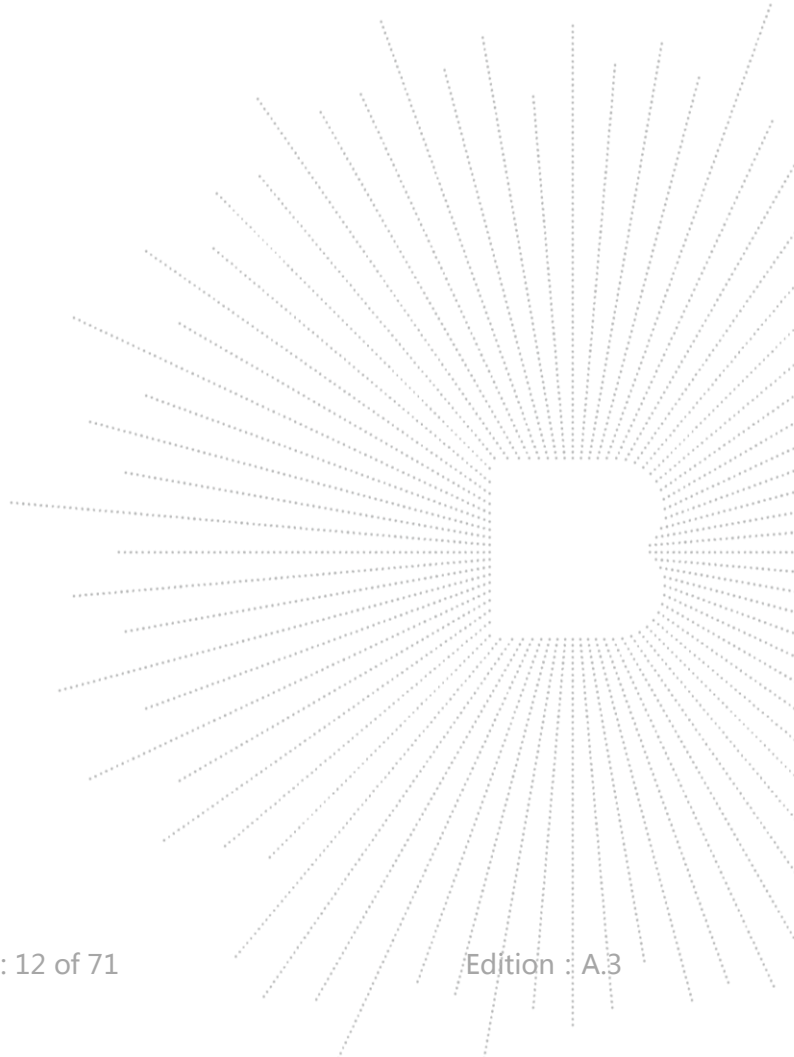

Radiated emissions Test (966 chamber)					
Equipment	Manufacturer	Model#	Serial#	Last Cal.	Next Cal.
966 chamber	ChengYu	966 Room	966	Jun. 06. 2020	Jun. 05, 2023
Receiver	R&S	ESR3	102075	Jun. 08, 2020	Jun. 07, 2021
Receiver	R&S	ESRP	101154	Jun. 08, 2020	Jun. 07, 2021
Amplifier	Schwarzbeck	BBV9718	9718-309	Jun. 04, 2020	Jun. 03, 2021
Amplifier	Schwarzbeck	BBV9744	9744-0037	Jun. 04, 2020	Jun. 03, 2021
TRILOG Broadband Antenna	schwarzbeck	VULB 9163	VULB9163- 942	Jun. 08, 2020	Jun. 07, 2021
Horn Antenna	SCHWARZBEC K	BBHA9120 D	1201	Jun. 10, 2020	Jun. 09, 2021
Horn Antenna (18GHz-40GHz)	SCHWARZBEC K	BBHA9170	822	Jun. 10, 2020	Jun. 09, 2021
Amplifier (18GHz-40GHz)	MITEQ	TTA1840-3 5-HG	2034381	Jun. 08, 2020	Jun. 07, 2021
Loop Antenna (9kHz-30MHz)	SCHWARZBEC K	FMZB1519 B	014	Jun. 08, 2020	Jun. 07, 2021
RF cables1 (9kHz-30MHz)	Huber+Suhnar	9kHz-30MH z	B1702988-0 008	Jun. 08, 2020	Jun. 07, 2021
RF cables2 (30MHz-1GHz)	Huber+Suhnar	30MHz-1G Hz	1486150	Jun. 08, 2020	Jun. 07, 2021
RF cables3 (1GHz-40GHz)	Huber+Suhnar	1GHz-40G Hz	1607106	Jun. 08, 2020	Jun. 07, 2021
Power Metter	Keysight	E4419B	\	Jun. 08, 2020	Jun. 07, 2021
Power Sensor (AV)	Keysight	E9 300A	\	Jun. 08, 2020	Jun. 07, 2021
Signal Analyzer 20kHz-26.5GHz	KEYSIGHT	N9020A	MY4910006 0	Jun. 04, 2020	Jun. 03, 2021
Spectrum Analyzer 9kHz-40GHz	Agilent	FSP40	100363	Jun. 13, 2020	Jun. 12, 2021
Software	Frad	EZ-EMC	FA-03A2 RE	\	\

4. EMC EMISSION TEST

4.1 CONDUCTED EMISSION MEASUREMENT

4.1.1 POWER LINE CONDUCTED EMISSION Limits (Frequency Range 150KHz-30MHz)

FREQUENCY (MHz)	Limit (dBuV)		Standard
	Quasi-peak	Average	
0.15 -0.5	66 - 56 *	56 - 46 *	FCC
0.50 -5.0	56.00	46.00	FCC
5.0 -30.0	60.00	50.00	FCC

Note:

- (1) The tighter limit applies at the band edges.
- (2) The limit of " * " marked band means the limitation decreases linearly with the logarithm of the frequency in the range.

The following table is the setting of the receiver

Receiver Parameters	Setting
Attenuation	10 dB
Start Frequency	0.15 MHz
Stop Frequency	30 MHz
IF Bandwidth	9 kHz

4.1.2 TEST PROCEDURE

- a. The EUT was placed 0.8 meters from the horizontal ground plane with EUT being connected to the power mains through a line impedance stabilization network (LISN). All other support equipments powered from additional LISN(s). The LISN provide 50 Ohm/ 50uH of coupling impedance for the measuring instrument.
- b. Interconnecting cables that hang closer than 40 cm to the ground plane shall be folded back and forth in the center forming a bundle 30 to 40 cm long.
- c. I/O cables that are not connected to a peripheral shall be bundled in the center. The end of the cable may be terminated, if required, using the correct terminating impedance. The overall length shall not exceed 1 m.
- d. LISN at least 80 cm from nearest part of EUT chassis.
- e. For the actual test configuration, please refer to the related Item –EUT Test Photos.

4.1.3 DEVIATION FROM TEST STANDARD

No deviation

4.1.4 TEST SETUP

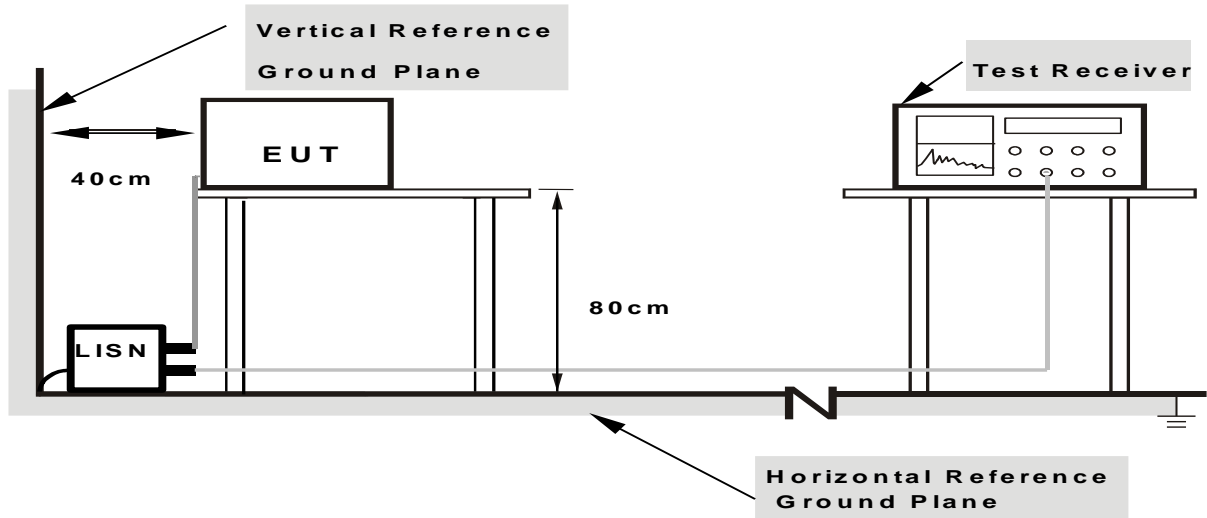

Note: 1. Support units were connected to second LISN.

2. Both of LISNs (AMN) are 80 cm from EUT and at least 80 cm from other units and other metal planes

4.1.5 EUT OPERATING CONDITIONS

The EUT was configured for testing in a typical fashion (as a customer would normally use it). The EUT has been programmed to continuously transmit during test. This operating condition was tested and used to collect the included data.

We pretest AC 120V and AC 240V, the worst voltage was AC 120V and the data recording in the report.

4.1.6 TEST RESULTS

Temperature :	26 °C	Relative Humidity :	54%
Pressure :	101kPa	Phase :	L
Test Voltage :	AC 120V/60Hz	Test Mode :	Mode 5

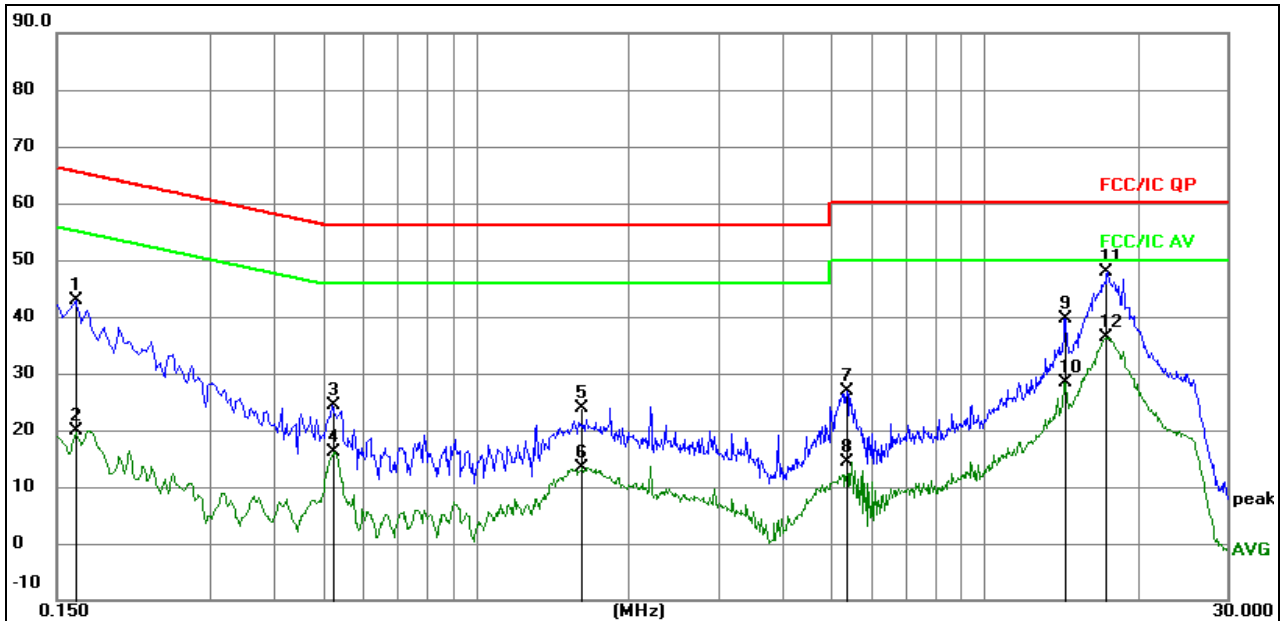

Remark:

1. All readings are Quasi-Peak and Average values.
2. Factor = Insertion Loss + Cable Loss.

No.	Mk.	Freq. MHz	Reading Level	Correct Factor dB	Measure- ment dBuV	Limit dBuV	Over dB	Detector
1		0.1633	33.29	9.50	42.79	65.29	-22.50	QP
2		0.1633	10.46	9.50	19.96	55.29	-35.33	AVG
3		0.5210	14.66	9.68	24.34	56.00	-31.66	QP
4		0.5210	6.54	9.68	16.22	46.00	-29.78	AVG
5		1.6190	14.19	9.58	23.77	56.00	-32.23	QP
6		1.6190	3.90	9.58	13.48	46.00	-32.52	AVG
7		5.3615	17.03	9.79	26.82	60.00	-33.18	QP
8		5.3615	4.65	9.79	14.44	50.00	-35.56	AVG
9		14.3641	30.01	9.70	39.71	60.00	-20.29	QP
10		14.3641	18.79	9.70	28.49	50.00	-21.51	AVG
11	*	17.3826	38.04	9.74	47.78	60.00	-12.22	QP
12		17.3826	26.63	9.74	36.37	50.00	-13.63	AVG

Temperature :	26 °C	Relative Humidity :	54%
Pressure :	101kPa	Phase :	N
Test Voltage :	AC 120V/60Hz	Test Mode :	Mode 5

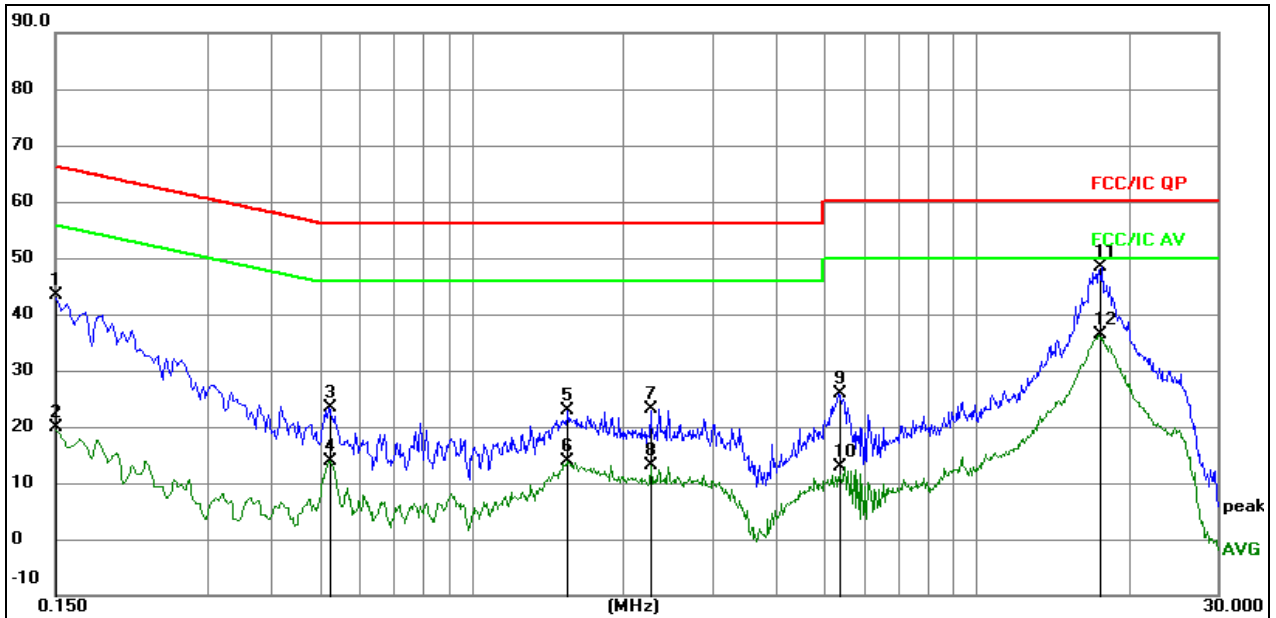
Remark:

1. All readings are Quasi-Peak and Average values.
2. Factor = Insertion Loss + Cable Loss.

No.	Mk.	Freq. MHz	Reading Level	Correct Factor dB	Measure- ment dBuV	Limit dBuV	Over dB	Detector
1		0.1500	33.93	9.52	43.45	66.00	-22.55	QP
2		0.1500	10.27	9.52	19.79	56.00	-36.21	AVG
3		0.5235	13.71	9.69	23.40	56.00	-32.60	QP
4		0.5235	4.07	9.69	13.76	46.00	-32.24	AVG
5		1.5494	13.19	9.58	22.77	56.00	-33.23	QP
6		1.5494	4.36	9.58	13.94	46.00	-32.06	AVG
7		2.2695	13.44	9.61	23.05	56.00	-32.95	QP
8		2.2695	3.44	9.61	13.05	46.00	-32.95	AVG
9		5.3385	16.14	9.79	25.93	60.00	-34.07	QP
10		5.3385	3.01	9.79	12.80	50.00	-37.20	AVG
11	*	17.4794	38.74	9.74	48.48	60.00	-11.52	QP
12		17.4794	26.71	9.74	36.45	50.00	-13.55	AVG

4.2 RADIATED EMISSION MEASUREMENT

4.2.1 RADIATED EMISSION LIMITS (Frequency Range 9kHz-1000MHz)

20dBc in any 100 kHz bandwidth outside the operating frequency band. In case the emission fall within the restricted band specified on 15.205(a), then the 15.209(a) limit in the table below has to be followed.

Frequencies (MHz)	Field Strength (micorvolts/meter)	Measurement Distance (meters)
0.009~0.490	2400/F(KHz)	300
0.490~1.705	24000/F(KHz)	30
1.705~30.0	30	30
30~88	100	3
88~216	150	3
216~960	200	3
Above 960	500	3

LIMITS OF RADIATED EMISSION MEASUREMENT (Above 1000MHz)

FREQUENCY (MHz)	Limit (dBuV/m) (at 3M)	
	PEAK	AVERAGE
Above 1000	74	54

Notes:

- (1) The limit for radiated test was performed according to FCC PART 15C.
- (2) The tighter limit applies at the band edges.
- (3) Emission level (dBuV/m)=20log Emission level (uV/m).

Spectrum Parameter	Setting
Attenuation	Auto
Start Frequency	1000 MHz
Stop Frequency	25GHz
RB / VB (emission in restricted band)	1 MHz / 1 MHz for Peak, 1 MHz / 10Hz for Average

Receiver Parameter	Setting
Attenuation	Auto
Start ~ Stop Frequency	9kHz~150kHz / RB 200Hz for QP
Start ~ Stop Frequency	150kHz~30MHz / RB 9kHz for QP
Start ~ Stop Frequency	30MHz~1000MHz / RB 120kHz for QP

4.2.2 TEST PROCEDURE

Below 1GHz test procedure as below:

- a. The EUT was placed on the top of a rotating table 0.8 meters above the ground at a 3 meter semi-anechoic chamber. The table was rotated 360 degrees to determine the position of the highest radiation.
- b. The EUT was set 3 meters away from the interference-receiving antenna, which was mounted on the top of a variable-height antenna tower.
- c. The antenna height is varied from one meter to four meters above the ground to determine the maximum value of the field strength. Both horizontal and vertical polarizations of the antenna are set to make the measurement.
- d. For each suspected emission, the EUT was arranged to its worst case and then the antenna was tuned to heights from 1 meter to 4 meters (for the test frequency of below 30MHz, the antenna was tuned to heights 1 meter) and the rotatable table was turned from 0 degrees to 360 degrees to find the maximum reading.
- e. The test-receiver system was set to Peak Detect Function and Specified Bandwidth with Maximum Hold Mode.
- f. If the emission level of the EUT in peak mode was 10dB lower than the limit specified, then testing could be stopped and the peak values of the EUT would be reported. Otherwise the emissions that did not have 10dB margin would be re-tested one by one using peak, quasi-peak or average method as specified and then reported in a data sheet.

Above 1GHz test procedure as below:

- g. Different between above is the test site, change from Semi- Anechoic Chamber to fully Anechoic Chamber and change form table 0.8 metre to 1.5 metre(Above 18GHz the distance is 1 meter and table is 1.5 metre).
- h. Test the EUT in the lowest channel ,the middle channel ,the Highest channel

Note:

Both horizontal and vertical antenna polarities were tested and performed pretest to three orthogonal axis. The worst case emissions were reported

4.2.3 DEVIATION FROM TEST STANDARD

No deviation

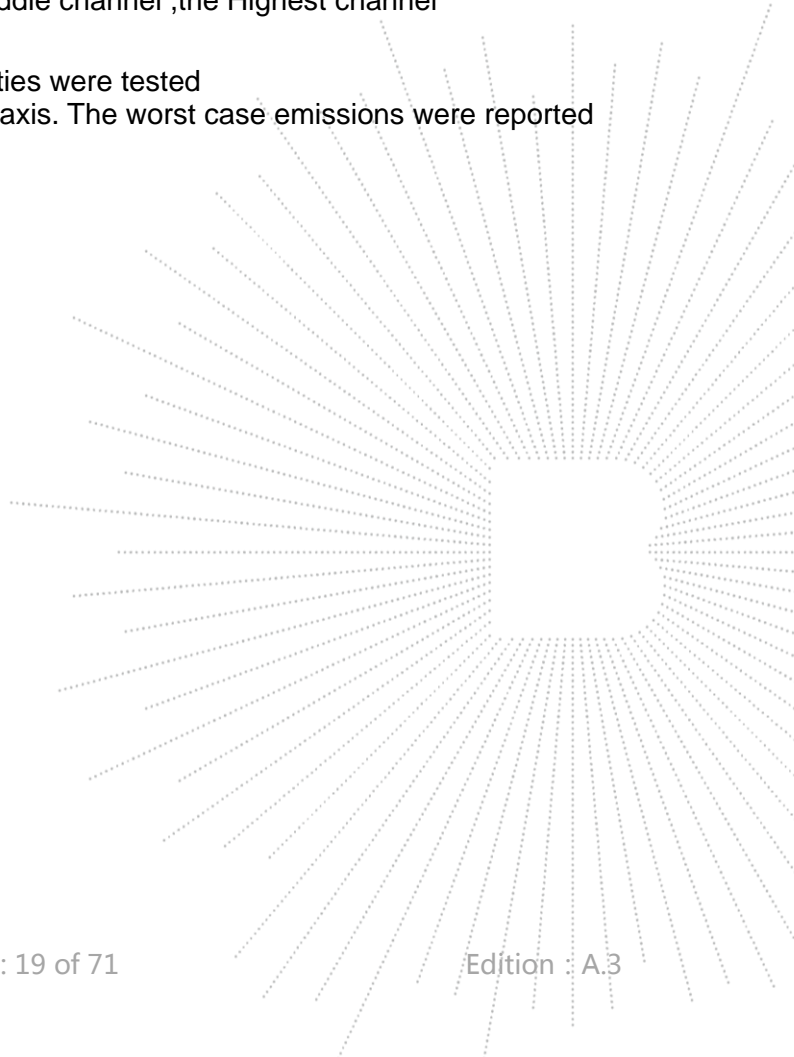

4.2.4 TEST SETUP

(A) Radiated Emission Test-Up Frequency Below 30MHz

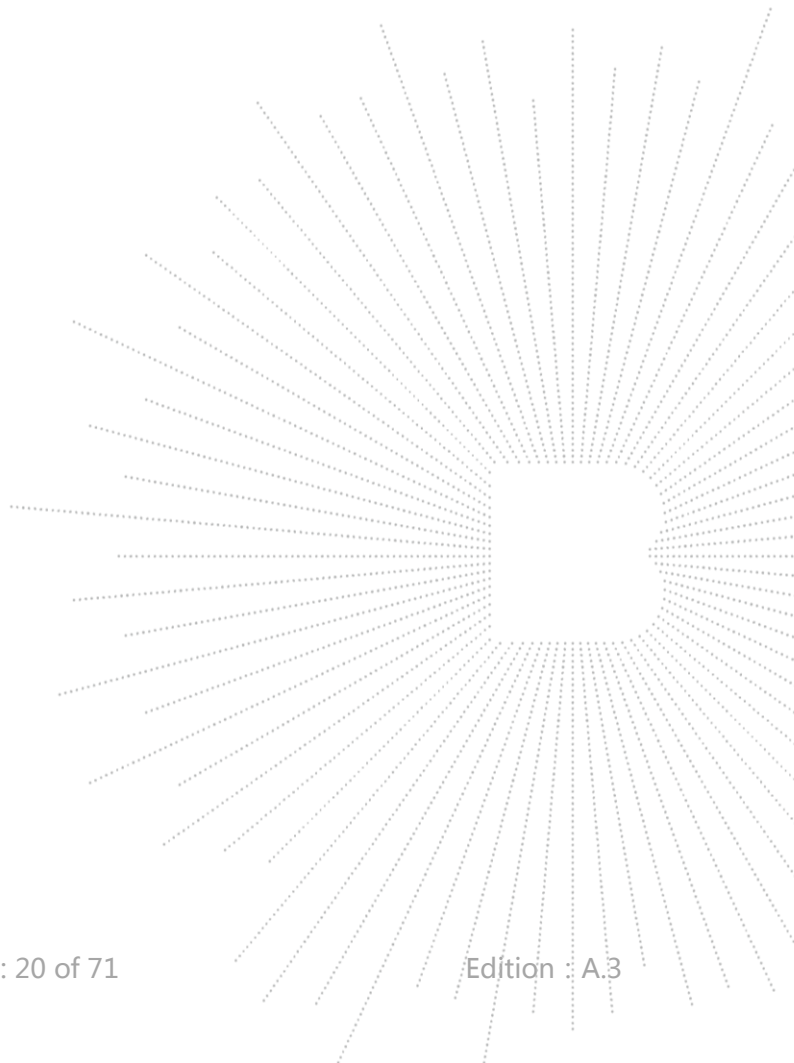
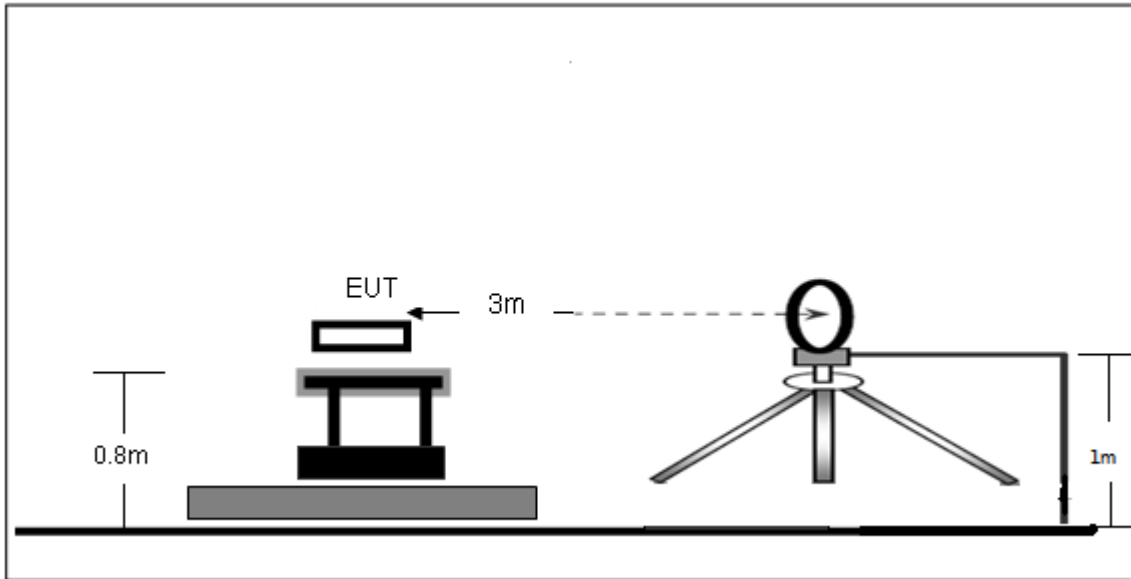

(B) Radiated Emission Test-Up Frequency 30MHz~1GHz

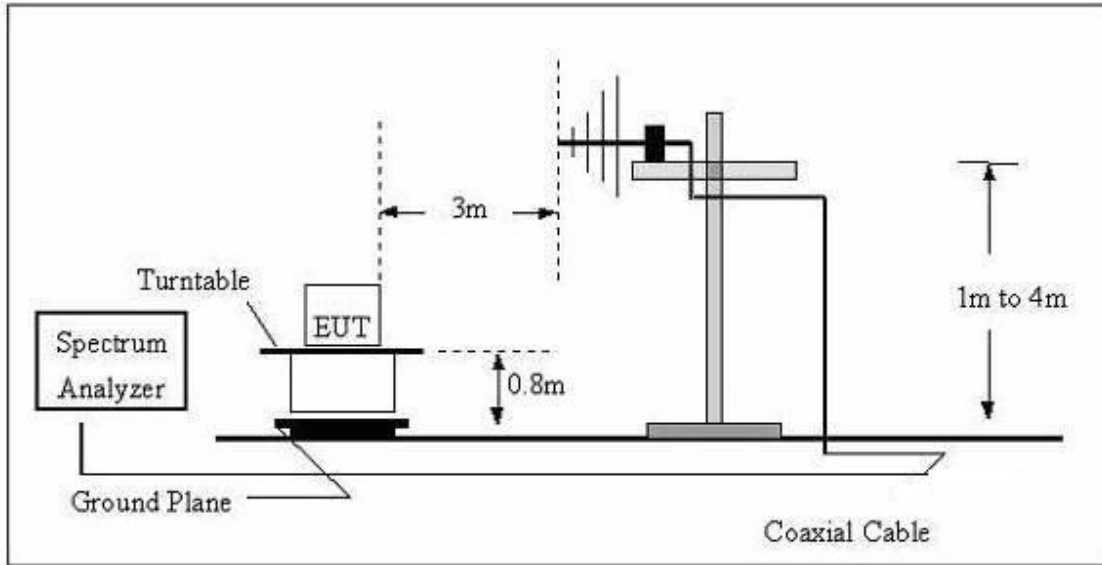

(C) Radiated Emission Test-Up Frequency Above 1GHz

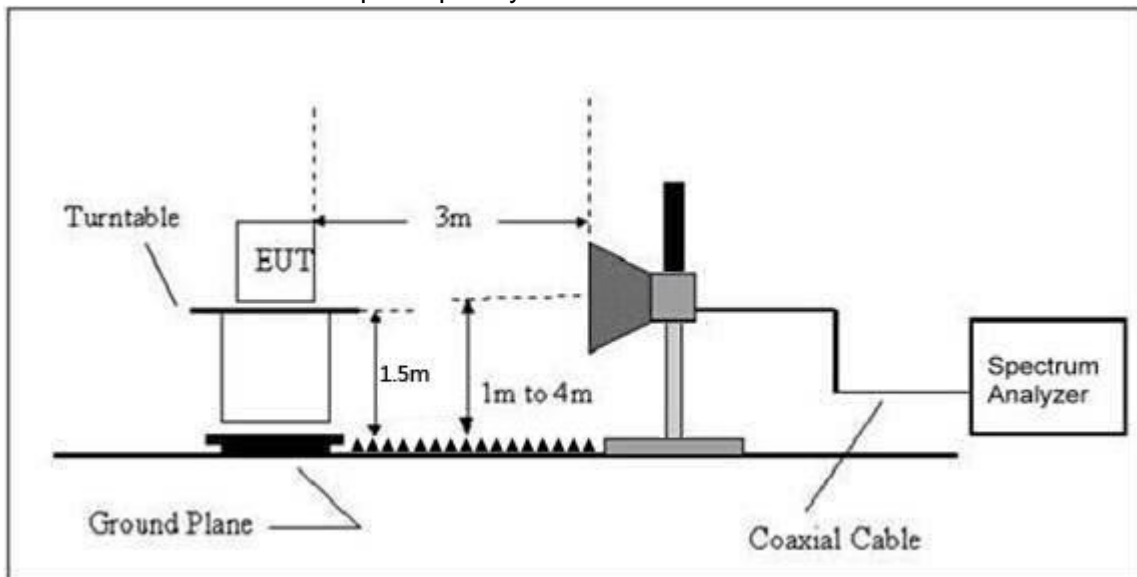
4.2.5 EUT OPERATING CONDITIONS

The EUT tested system was configured as the statements of 2.4 Unless otherwise a special operating condition is specified in the follows during the testing.

4.2.6 TEST RESULTS (BETWEEN 9KHZ – 30 MHZ)

Temperature:	26 °C	Relative Humidity :	54%
Pressure:	101kPa	Test Voltage :	DC 5V
Test Mode :	Mode 5	Polarization :	--

Freq.	Reading	Limit	Margin	State
(MHz)	(dBuV/m)	(dBuV/m)	(dB)	P/F
--	--	--	--	PASS
--	--	--	--	PASS

NOTE:

The amplitude of spurious emissions which are attenuated by more than 20dB below the permissible value has no need to be reported.

Distance extrapolation factor = $40 \log(\text{specific distance}/\text{test distance})$ (dB);

Limit line = specific limits(dBuv) + distance extrapolation factor.

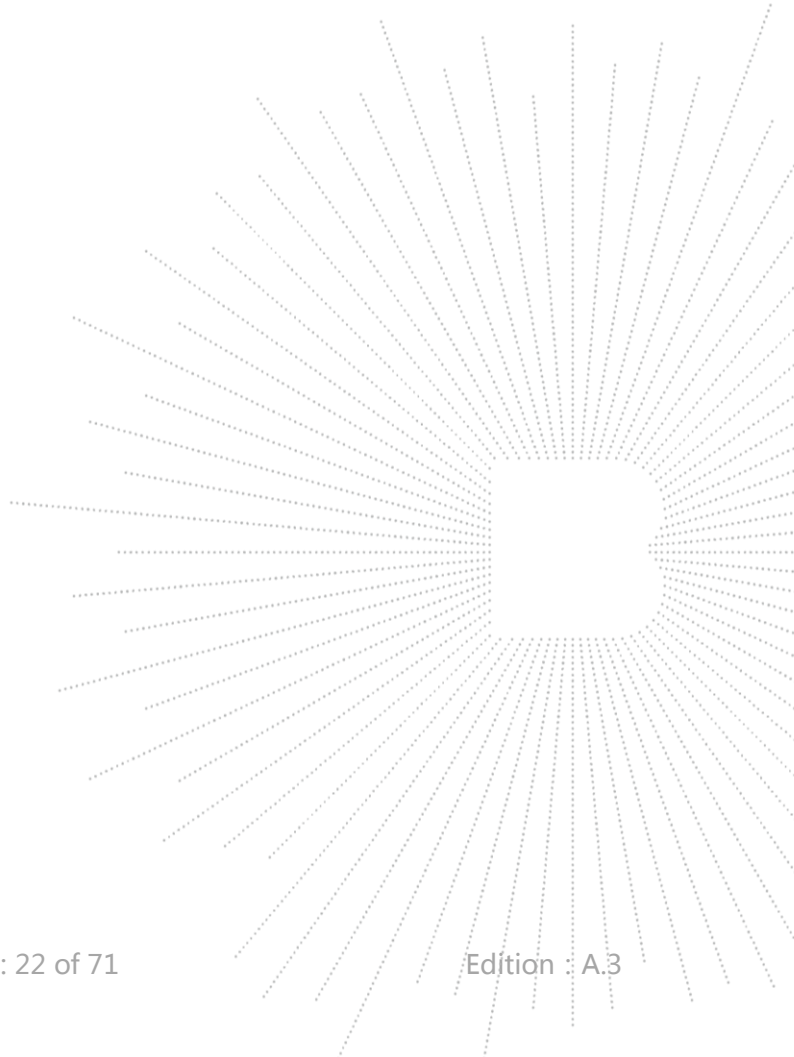

4.2.7 TEST RESULTS (BETWEEN 30MHZ – 1GHZ)

Temperature :	26 °C	Relative Humidity :	54%
Pressure :	101 kPa	Polarization :	Horizontal
Test Voltage :	DC 5V	Test Mode :	Mode 5

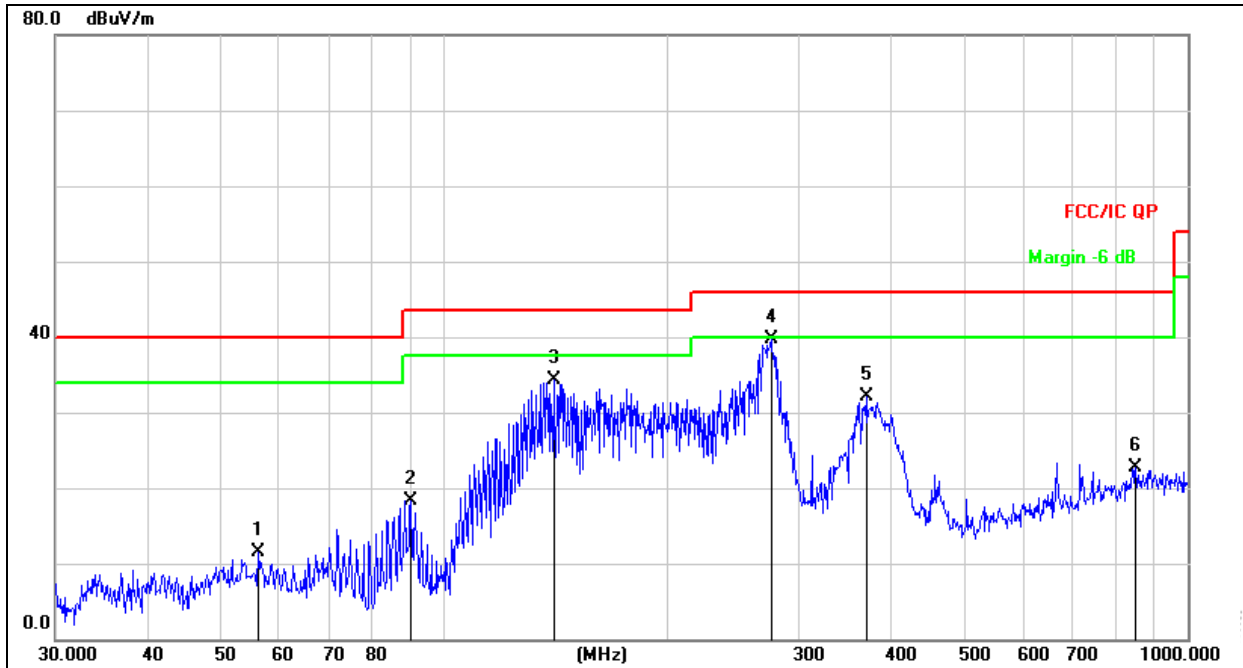

Remark:
 Factor = Antenna Factor + Cable Loss – Pre-amplifier.

No.	Mk.	Freq. MHz	Reading Level dBuV	Correct Factor dB	Measure- ment dBuV/m	Limit dB/m	Over dB	Detector
1		56.1974	25.97	-14.44	11.53	40.00	-28.47	QP
2		90.2205	35.84	-17.45	18.39	43.50	-25.11	QP
3		140.3421	52.32	-18.08	34.24	43.50	-9.26	QP
4	*	275.1570	52.95	-13.31	39.64	46.00	-6.36	QP
5		369.4047	42.64	-10.53	32.11	46.00	-13.89	QP
6		851.0353	23.62	-0.96	22.66	46.00	-23.34	QP

Temperature :	26 °C	Relative Humidity :	54%
Pressure :	101kPa	Polarization :	Vertical
Test Voltage :	DC 5V	Test Mode :	Mode 5

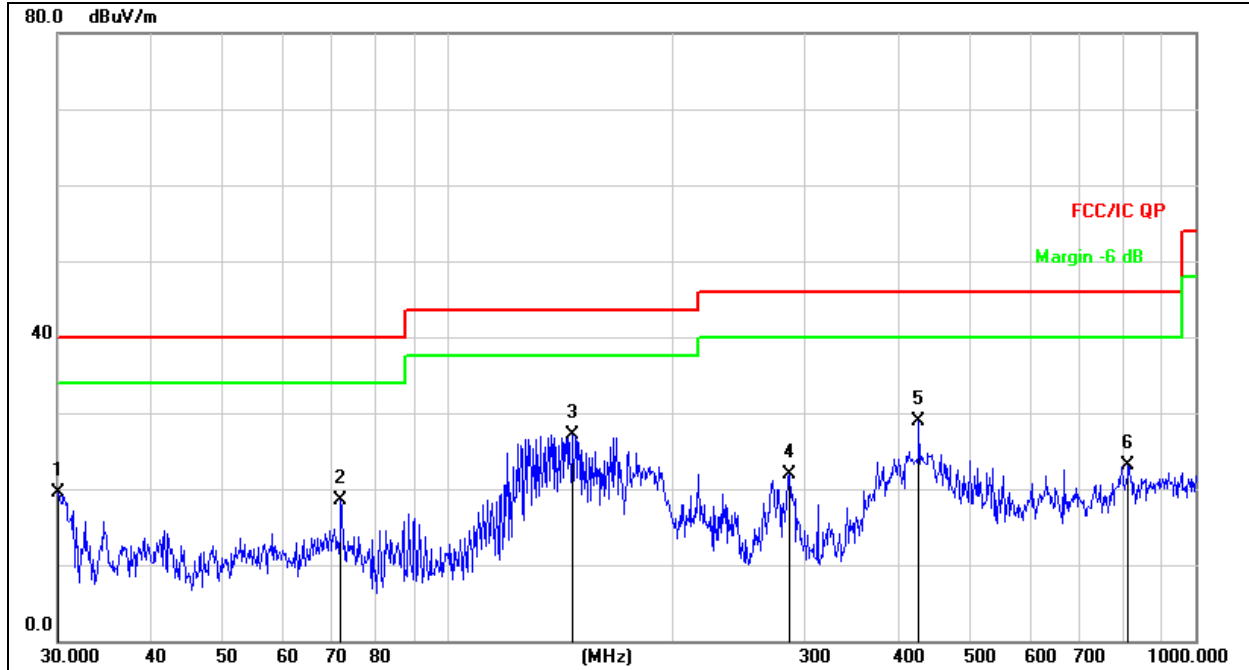

Remark:

Factor = Antenna Factor + Cable Loss – Pre-amplifier.

No.	Mk.	Freq.	Reading Level	Correct Factor	Measurement	Limit	Over	Detector
		MHz	dBuV	dB	dBuV/m	dB/m	dB	
1		30.1054	35.58	-16.10	19.48	40.00	-20.52	QP
2		71.8320	36.15	-17.66	18.49	40.00	-21.51	QP
3	*	146.8877	45.70	-18.51	27.19	43.50	-16.31	QP
4		285.9778	34.88	-12.91	21.97	46.00	-24.03	QP
5		426.5210	37.96	-9.12	28.84	46.00	-17.16	QP
6		813.1115	24.82	-1.73	23.09	46.00	-22.91	QP

4.2.8 TEST RESULTS

Between 1GHz – 25GHz

802.11b

Polar (H/V)	Frequency	Reading Level	Correct Factor	Measure- ment	Limits	Over	Detector Type
	(MHz)	(dBuV/m)	(dB)	(dBuV/m)	(dBuV/ m)	(dB)	
Low channel:2412MHz							
V	4824.00	54.92	-0.43	54.49	74.00	-19.51	PK
V	4824.00	46.49	-0.43	46.06	54.00	-7.94	AV
V	7236.00	45.49	8.31	53.80	74.00	-20.20	PK
V	7236.00	35.01	8.31	43.32	54.00	-10.68	AV
H	4804.00	51.44	-0.43	51.01	74.00	-22.99	PK
H	4804.00	41.37	-0.43	40.94	54.00	-13.06	AV
H	7236.00	42.64	8.31	50.95	74.00	-23.05	PK
H	7236.00	33.93	8.31	42.24	54.00	-11.76	AV
Middle channel:2437MHz							
V	4874.00	52.20	-0.38	51.82	74.00	-22.18	PK
V	4874.00	45.60	-0.38	45.22	54.00	-8.78	AV
V	7311.00	44.80	8.83	53.63	74.00	-20.37	PK
V	7311.00	35.81	8.83	44.64	54.00	-9.36	AV
H	4874.00	50.13	-0.38	49.75	74.00	-24.25	PK
H	4874.00	41.08	-0.38	40.70	54.00	-13.30	AV
H	7311.00	41.99	8.83	50.82	74.00	-23.18	PK
H	7311.00	33.19	8.83	42.02	54.00	-11.98	AV
High channel:2462MHz							
V	4924.00	53.24	-0.32	52.92	74.00	-21.08	PK
V	4924.00	45.22	-0.32	44.90	54.00	-9.10	AV
V	7386.00	44.97	9.35	54.32	74.00	-19.68	PK
V	7386.00	34.92	9.35	44.27	54.00	-9.73	AV
H	4924.00	51.76	-0.32	51.44	74.00	-22.56	PK
H	4924.00	41.98	-0.32	41.66	54.00	-12.34	AV
H	7386.00	43.83	9.35	53.18	74.00	-20.82	PK
H	7386.00	36.35	9.35	45.70	54.00	-8.30	AV

Remark:

1. Emission Level = Meter Reading + Factor,

Factor = Antenna Factor + Cable Loss – Pre-amplifier.

Over = Emission Level - Limit

2. If peak below the average limit, the average emission was no test.

3. In restricted bands of operation, The spurious emissions below the permissible value more than 20dB

4. The amplitude of spurious emissions which are attenuated by more than 20dB below the permissible value has no need to be reported.

5. The Worst mode is Antenna A.

802.11g

Polar (H/V)	Frequency	Reading Level	Correct Factor	Measurement	Limits	Over	Detector Type
	(MHz)	(dBuV/m)	(dB)	(dBuV/m)	(dBuV/m)	(dB)	
Low channel:2412MHz							
V	4824.00	54.67	-0.43	54.24	74.00	-19.76	PK
V	4824.00	45.97	-0.43	45.54	54.00	-8.46	AV
V	7236.00	45.95	8.31	54.26	74.00	-19.74	PK
V	7236.00	36.08	8.31	44.39	54.00	-9.61	AV
H	4804.00	50.67	-0.43	50.24	74.00	-23.76	PK
H	4804.00	40.29	-0.43	39.86	54.00	-14.14	AV
H	7236.00	43.94	8.31	52.25	74.00	-21.75	PK
H	7236.00	35.88	8.31	44.19	54.00	-9.81	AV
Middle channel:2437MHz							
V	4874.00	52.23	-0.38	51.85	74.00	-22.15	PK
V	4874.00	44.47	-0.38	44.09	54.00	-9.91	AV
V	7311.00	44.49	8.83	53.32	74.00	-20.68	PK
V	7311.00	35.47	8.83	44.30	54.00	-9.70	AV
H	4874.00	49.84	-0.38	49.46	74.00	-24.54	PK
H	4874.00	40.35	-0.38	39.97	54.00	-14.03	AV
H	7311.00	42.02	8.83	50.85	74.00	-23.15	PK
H	7311.00	34.19	8.83	43.02	54.00	-10.98	AV
High channel:2462MHz							
V	4924.00	54.49	-0.32	54.17	74.00	-19.83	PK
V	4924.00	45.36	-0.32	45.04	54.00	-8.96	AV
V	7386.00	46.81	9.35	56.16	74.00	-17.84	PK
V	7386.00	37.09	9.35	46.44	54.00	-7.56	AV
H	4924.00	53.15	-0.32	52.83	74.00	-21.17	PK
H	4924.00	42.54	-0.32	42.22	54.00	-11.78	AV
H	7386.00	44.41	9.35	53.76	74.00	-20.24	PK
H	7386.00	36.15	9.35	45.50	54.00	-8.50	AV

Remark:

1. Emission Level = Meter Reading + Factor,

Factor = Antenna Factor + Cable Loss – Pre-amplifier.

Over = Emission Level - Limit

2. If peak below the average limit, the average emission was no test.

3. In restricted bands of operation, The spurious emissions below the permissible value more than 20dB

4. The amplitude of spurious emissions which are attenuated by more than 20dB below the permissible value has no need to be reported.

5. The Worst mode is Antenna A.

802.11n20

Polar (H/V)	Frequency	Reading Level	Correct Factor	Measurement	Limits	Over	Detector Type
	(MHz)	(dBuV/m)	(dB)	(dBuV/m)	(dBuV/m)	(dB)	
Low channel:2412MHz							
V	4824.00	52.11	-0.43	51.68	74.00	-22.32	PK
V	4824.00	42.96	-0.43	42.53	54.00	-11.47	AV
V	7236.00	43.04	8.31	51.35	74.00	-22.65	PK
V	7236.00	33.13	8.31	41.44	54.00	-12.56	AV
H	4804.00	49.60	-0.43	49.17	74.00	-24.83	PK
H	4804.00	40.34	-0.43	39.91	54.00	-14.09	AV
H	7236.00	40.70	8.31	49.01	74.00	-24.99	PK
H	7236.00	33.05	8.31	41.36	54.00	-12.64	AV
Middle channel:2437MHz							
V	4874.00	50.93	-0.38	50.55	74.00	-23.45	PK
V	4874.00	44.68	-0.38	44.30	54.00	-9.70	AV
V	7311.00	40.30	8.83	49.13	74.00	-24.87	PK
V	7311.00	30.98	8.83	39.81	54.00	-14.19	AV
H	4874.00	49.25	-0.38	48.87	74.00	-25.13	PK
H	4874.00	38.54	-0.38	38.16	54.00	-15.84	AV
H	7311.00	39.19	8.83	48.02	74.00	-25.98	PK
H	7311.00	30.73	8.83	39.56	54.00	-14.44	AV
High channel:2462MHz							
V	4924.00	53.19	-0.32	52.87	74.00	-21.13	PK
V	4924.00	43.95	-0.32	43.63	54.00	-10.37	AV
V	7386.00	46.47	9.35	55.82	74.00	-18.18	PK
V	7386.00	36.14	9.35	45.49	54.00	-8.51	AV
H	4924.00	51.60	-0.32	51.28	74.00	-22.72	PK
H	4924.00	41.71	-0.32	41.39	54.00	-12.61	AV
H	7386.00	44.29	9.35	53.64	74.00	-20.36	PK
H	7386.00	37.15	9.35	46.50	54.00	-7.50	AV

Remark:

1. Emission Level = Meter Reading + Factor,

Factor = Antenna Factor + Cable Loss – Pre-amplifier.

Over = Emission Level - Limit

2. If peak below the average limit, the average emission was no test.

3. In restricted bands of operation, The spurious emissions below the permissible value more than 20dB

4. The amplitude of spurious emissions which are attenuated by more than 20dB below the permissible value has no need to be reported.

5. Test Mode is MIMO Mode.

802.11n40

Polar (H/V)	Frequency	Reading Level	Correct Factor	Measurement	Limits	Over	Detector Type
	(MHz)	(dBuV/m)	(dB)	(dBuV/m)	(dBuV/m)	(dB)	
Low channel:2422MHz							
V	4844.00	53.92	-0.43	53.49	74.00	-20.51	PK
V	4844.00	45.44	-0.43	45.01	54.00	-8.99	AV
V	7266.00	42.94	8.31	51.25	74.00	-22.75	PK
V	7266.00	32.87	8.31	41.18	54.00	-12.82	AV
H	4844.00	52.38	-0.43	51.95	74.00	-22.05	PK
H	4844.00	42.29	-0.43	41.86	54.00	-12.14	AV
H	7266.00	40.37	8.31	48.68	74.00	-25.32	PK
H	7266.00	31.64	8.31	39.95	54.00	-14.05	AV
Middle channel:2437MHz							
V	4874.00	52.33	-0.38	51.95	74.00	-22.05	PK
V	4874.00	44.72	-0.38	44.34	54.00	-9.66	AV
V	7311.00	44.28	8.83	53.11	74.00	-20.89	PK
V	7311.00	35.88	8.83	44.71	54.00	-9.29	AV
H	4874.00	50.00	-0.38	49.62	74.00	-24.38	PK
H	4874.00	40.67	-0.38	40.29	54.00	-13.71	AV
H	7311.00	42.95	8.83	51.78	74.00	-22.22	PK
H	7311.00	34.09	8.83	42.92	54.00	-11.08	AV
High channel:2452MHz							
V	4904.00	54.15	-0.32	53.83	74.00	-20.17	PK
V	4904.00	45.69	-0.32	45.37	54.00	-8.63	AV
V	7356.00	47.18	9.35	56.53	74.00	-17.47	PK
V	7356.00	38.15	9.35	47.50	54.00	-6.50	AV
H	4904.00	52.18	-0.32	51.86	74.00	-22.14	PK
H	4904.00	41.43	-0.32	41.11	54.00	-12.89	AV
H	7356.00	44.53	9.35	53.88	74.00	-20.12	PK
H	7356.00	35.66	9.35	45.01	54.00	-8.99	AV

Remark:

1. Emission Level = Meter Reading + Factor,

Factor = Antenna Factor + Cable Loss – Pre-amplifier.

Over = Emission Level - Limit

2. If peak below the average limit, the average emission was no test.

3. In restricted bands of operation, The spurious emissions below the permissible value more than 20dB

4. The amplitude of spurious emissions which are attenuated by more than 20dB below the permissible value has no need to be reported.

5. Test Mode is MIMO Mode.

4.3 RADIATED BAND EMISSION MEASUREMENT

4.3.1 TEST REQUIREMENT:

FCC Part15 C Section 15.209 and 15.205

(a) Except as shown in paragraph (d) of this section, only spurious emissions are permitted in any of the frequency bands listed below:

MHz	MHz	MHz	GHz
0.090-0.110	16.42-16.423	399.9-410	4.5-5.15
0.495-0.505	16.69475-16.69525	608-614	5.35-5.46
2.1735-2.1905	16.80425-16.80475	960-1240	7.25-7.75
4.125-4.128	25.5-25.67	1300-1427	8.025-8.5
4.17725-4.17775	37.5-38.25	1435-1626.5	9.0-9.2
4.20725-4.20775	73-74.6	1645.5-1646.5	9.3-9.5
6.215-6.218	74.8-75.2	1660-1710	10.6-12.7
6.26775-6.26825	108-121.94	1718.8-1722.2	13.25-13.4
6.31175-6.31225	123-138	2200-2300	14.47-14.5
8.291-8.294	149.9-150.05	2310-2390	15.35-16.2
8.362-8.366	156.52475-156.52525	2483.5-2500	17.7-21.4
8.37625-8.38675	156.7-156.9	2690-2900	22.01-23.12
8.41425-8.41475	162.0125-167.17	3260-3267	23.6-24.0
12.29-12.293	167.72-173.2	3332-3339	31.2-31.8
12.51975-12.52025	240-285	3345.8-3358	36.43-36.5
12.57675-12.57725	322-335.4	3600-4400	(²)
13.36-13.41			

LIMITS OF RADIATED EMISSION MEASUREMENT (Above 1000MHz)

FREQUENCY (MHz)	Class B (dBuV/m) (at 3M)	
	PEAK	AVERAGE
Above 1000	74	54

Notes:

- (1) The limit for radiated test was performed according to FCC PART 15C.
- (2) The tighter limit applies at the band edges.
- (3) Emission level (dBuV/m)=20log Emission level (uV/m).

Spectrum Parameter	Setting
Attenuation	Auto
Start Frequency	2300MHz
Stop Frequency	2520
RB / VB (emission in restricted band)	1 MHz / 1 MHz for Peak, 1 MHz / 10Hz for Average

4.3.2 TEST PROCEDURE

Above 1GHz test procedure as below:

- a. 1. The EUT was placed on the top of a rotating table 1.5 meters above the ground at a 3 meter camber. The table was rotated 360 degrees to determine the position of the highest radiation.
- b. The EUT was set 3 meters away from the interference-receiving antenna, which was mounted on the top of a variable-height antenna tower.

- c. The antenna height is varied from one meter to four meters above the ground to determine the maximum value of the field strength. Both horizontal and vertical polarizations of the antenna are set to make the measurement.
- d. For each suspected emission, the EUT was arranged to its worst case and then the antenna was tuned to heights from 1 meter to 4 meters and the rota table was turned from 0 degrees to 360 degrees to find the maximum reading.
- e. The test-receiver system was set to Peak Detect Function and Specified Bandwidth with Maximum Hold Mode.
- f. If the emission level of the EUT in peak mode was 10dB lower than the limit specified, then testing could be stopped and the peak values of the EUT would be reported. Otherwise the emissions that did not have 10dB margin would be re-tested one by one using peak, quasi-peak or average method as specified and then reported in a data sheet.
- g. Test the EUT in the lowest channel, the Highest channel

Note:

Both horizontal and vertical antenna polarities were tested and performed pretest to three orthogonal axis. The worst case emissions were reported

4.3.3 DEVIATION FROM TEST STANDARD

No deviation

4.3.4 TEST SETUP

Radiated Emission Test-Up Frequency Above 1GHz

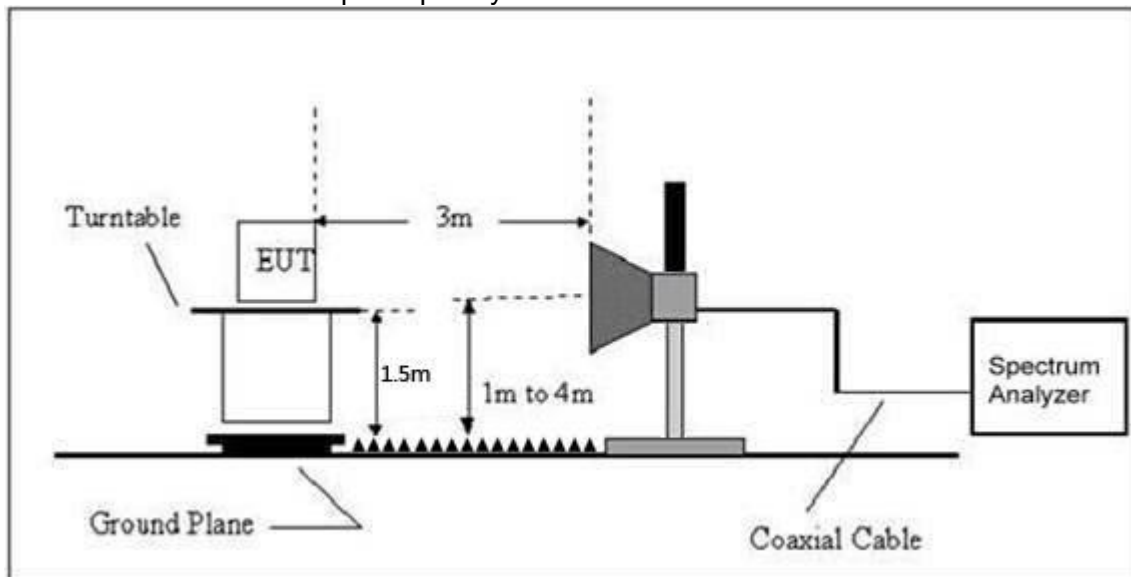

4.3.5 EUT OPERATING CONDITIONS

The EUT tested system was configured as the statements of 2.3 Unless otherwise a special operating condition is specified in the follows during the testing.

4.3.6 TEST RESULT

	Polar (H/V)	Frequency (MHz)	Reading Level (dBuV/m)	Correct Factor (dB)	Measurement (dBuV/m)	Limits (dBuV/m)		Result
					PK	PK	AV	
802.11b	Low Channel 2412MHz							
	H	2390.00	56.04	-6.70	49.34	74.00	54.00	PASS
	H	2400.00	47.81	-6.71	41.10	74.00	54.00	PASS
	V	2390.00	56.39	-6.70	49.69	74.00	54.00	PASS
	V	2400.00	48.49	-6.71	41.78	74.00	54.00	PASS
	High Channel 2462MHz							
	H	2483.50	54.16	-6.79	47.37	74.00	54.00	PASS
	H	2485.00	47.49	-6.81	40.68	74.00	54.00	PASS
	V	2483.50	55.88	-6.79	49.09	74.00	54.00	PASS
	V	2485.00	48.66	-6.81	41.85	74.00	54.00	PASS
802.11g	Low Channel 2412MHz							
	H	2390.00	56.83	-6.70	50.13	74.00	54.00	PASS
	H	2400.00	48.44	-6.71	41.73	74.00	54.00	PASS
	V	2390.00	57.05	-6.70	50.35	74.00	54.00	PASS
	V	2400.00	48.83	-6.71	42.12	74.00	54.00	PASS
	High Channel 2462MHz							
	H	2483.50	56.18	-6.79	49.39	74.00	54.00	PASS
	H	2485.00	49.02	-6.81	42.21	74.00	54.00	PASS
	V	2483.50	56.98	-6.79	50.19	74.00	54.00	PASS
	V	2485.00	48.88	-6.81	42.07	74.00	54.00	PASS

Remark:

1. Emission Level = Meter Reading + Factor,
Factor = Antenna Factor + Cable Loss – Pre-amplifier.
Over= Emission Level - Limit
2. If the PK measured levels comply with average limit, then the average level were deemed to comply with average limit.
- 3 In restricted bands of operation, The spurious emissions below the permissible value more than 20dB
4. The amplitude of spurious emissions which are attenuated by more than 20dB below the permissible value has no need to be reported.
5. The Worst mode is Antenna A.

	Polar (H/V)	Frequency (MHz)	Reading Level (dBuV/m)	Correct Factor (dB)	Measurement (dBuV/m)	Limits (dBuV/m)		Result
					PK	PK	AV	
802.11 n20	Low Channel 2412MHz							
	H	2390.00	56.88	-6.70	50.18	74.00	54.00	PASS
	H	2400.00	49.50	-6.71	42.79	74.00	54.00	PASS
	V	2390.00	56.55	-6.70	49.85	74.00	54.00	PASS
	V	2400.00	48.40	-6.71	41.69	74.00	54.00	PASS
	High Channel 2462MHz							
	H	2483.50	57.11	-6.79	50.32	74.00	54.00	PASS
	H	2500.00	47.93	-6.81	41.12	74.00	54.00	PASS
	V	2483.50	55.30	-6.79	48.51	74.00	54.00	PASS
	V	2500.00	47.83	-6.81	41.02	74.00	54.00	PASS
802.11 n40	Low Channel 2422MHz							
	H	2390.00	56.99	-6.70	50.29	74.00	54.00	PASS
	H	2400.00	49.22	-6.71	42.51	74.00	54.00	PASS
	V	2390.00	57.67	-6.70	50.97	74.00	54.00	PASS
	V	2400.00	48.73	-6.71	42.02	74.00	54.00	PASS
	High Channel 2452MHz							
	H	2483.50	57.31	-6.79	50.52	74.00	54.00	PASS
	H	2500.00	49.18	-6.81	42.37	74.00	54.00	PASS
	V	2483.50	57.74	-6.79	50.95	74.00	54.00	PASS
	V	2500.00	49.13	-6.81	42.32	74.00	54.00	PASS

Remark:

1. Emission Level = Meter Reading + Factor,

Factor = Antenna Factor + Cable Loss – Pre-amplifier.

Over= Emission Level - Limit

2. If the PK measured levels comply with average limit, then the average level were deemed to comply with average limit.

3 In restricted bands of operation, The spurious emissions below the permissible value more than 20dB

4. The amplitude of spurious emissions which are attenuated by more than 20dB below the permissible value has no need to be reported.

5. Test Mode is MIMO Mode.

5. POWER SPECTRAL DENSITY TEST

5.1 APPLIED PROCEDURES / LIMIT

FCC Part15 (15.247) , Subpart C				
Section	Test Item	Limit	Frequency Range (MHz)	Result
15.247	Power Spectral Density	8 dBm (in any 3KHz)	2400-2483.5	PASS

5.1.1 TEST PROCEDURE

1. Set analyzer center frequency to DTS channel center frequency.
2. Set the span to 1.5 times the DTS bandwidth.
3. Set the RBW to: $3 \text{ kHz} \leq \text{RBW} \leq 100 \text{ kHz}$.
4. Set the VBW $\geq 3 \times \text{RBW}$.
5. Detector = peak.
6. Sweep time = auto couple.
7. Trace mode = max hold.
8. Allow trace to fully stabilize.
9. Use the peak marker function to determine the maximum amplitude level within the RBW.
10. If measured value exceeds limit, reduce RBW (no less than 3 kHz) and repeat.

5.1.2 DEVIATION FROM STANDARD

No deviation.

5.1.3 TEST SETUP

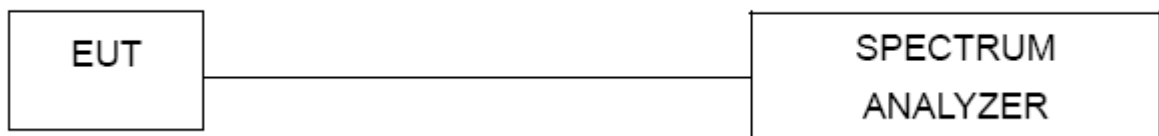

5.1.4 EUT OPERATION CONDITIONS

The EUT tested system was configured as the statements of 2.1 Unless otherwise a special operating condition is specified in the follows during the testing.

Note: Power Spectral Density(dBm)=Reading+Cable Loss

5.1.5 TEST RESULTS

Temperature :	26 °C	Relative Humidity :	54%
Pressure :	101kPa	Test Voltage :	DC 5V
Test Mode :	TX b Mode		

Frequency	Power Spectral Density (dBm/3KHz) ANTA	Power Spectral Density (dBm/3KHz) ANTB	Total power density (dBm/3KHz)	Limit (dBm/3KHz)	Result
2412 MHz	-9.334	0.979	/	8	PASS
2437 MHz	-2.814	0.165	/	8	PASS
2462 MHz	-1.870	-0.300	/	8	PASS

Note: A(B) Represent the value of antenna A and A, The worst data is Antenna B, only shown Antenna B Plot.

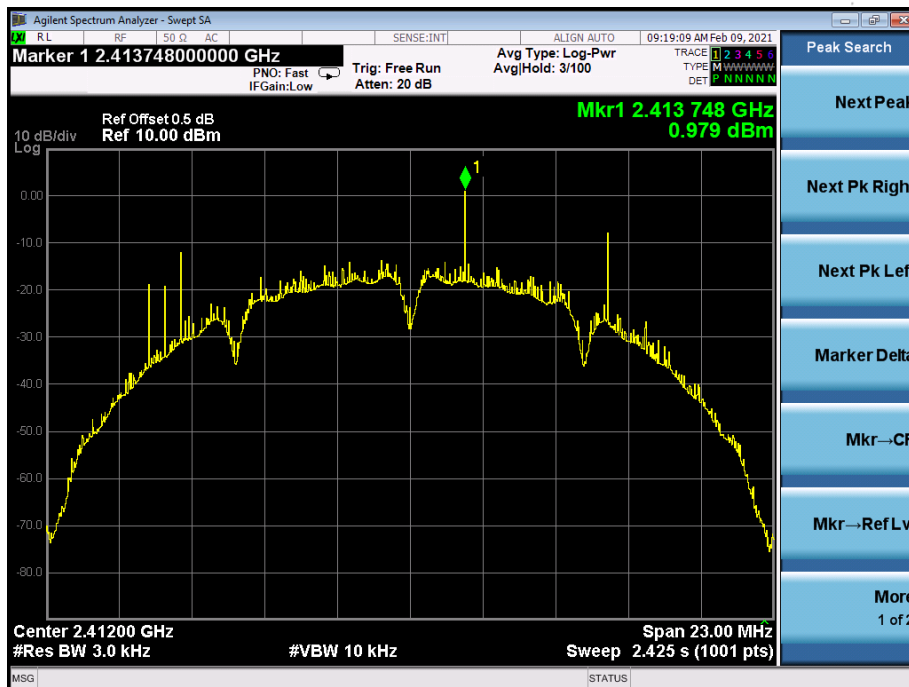
TX CH01

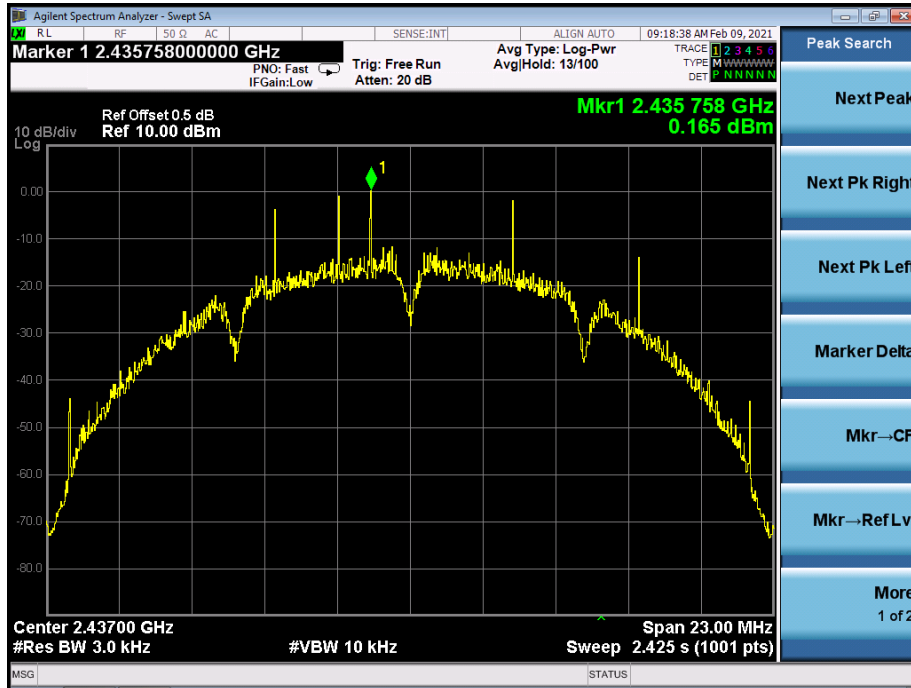
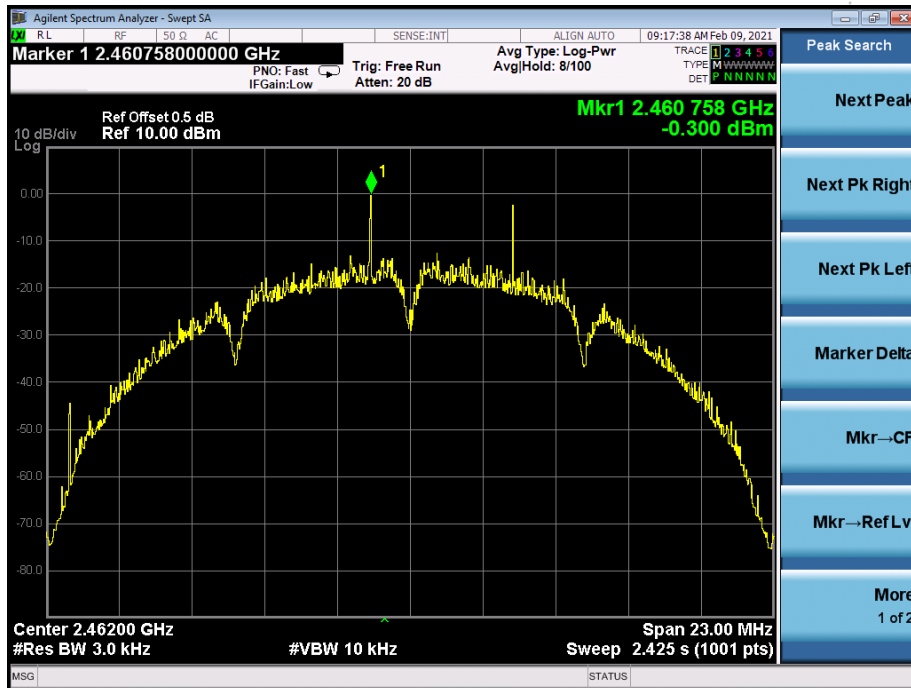
TX CH06

TX CH11

Temperature :	26 °C	Relative Humidity :	54%
Pressure :	101kPa	Test Voltage :	DC 5V
Test Mode :	TX g Mode		

Frequency	Power Spectral Density (dBm/3KHz) ANTA	Power Spectral Density (dBm/3KHz) ANTB	Total power density (dBm/3KHz)	Limit (dBm/3KHz)	Result
2412 MHz	-17.207	-17.040	/	8	PASS
2437 MHz	-17.089	-17.160	/	8	PASS
2462 MHz	-17.500	-17.844	/	8	PASS

Note: A(B) Represent the value of antenna A and B, The worst data is Antenna A, only shown Antenna A Plot.

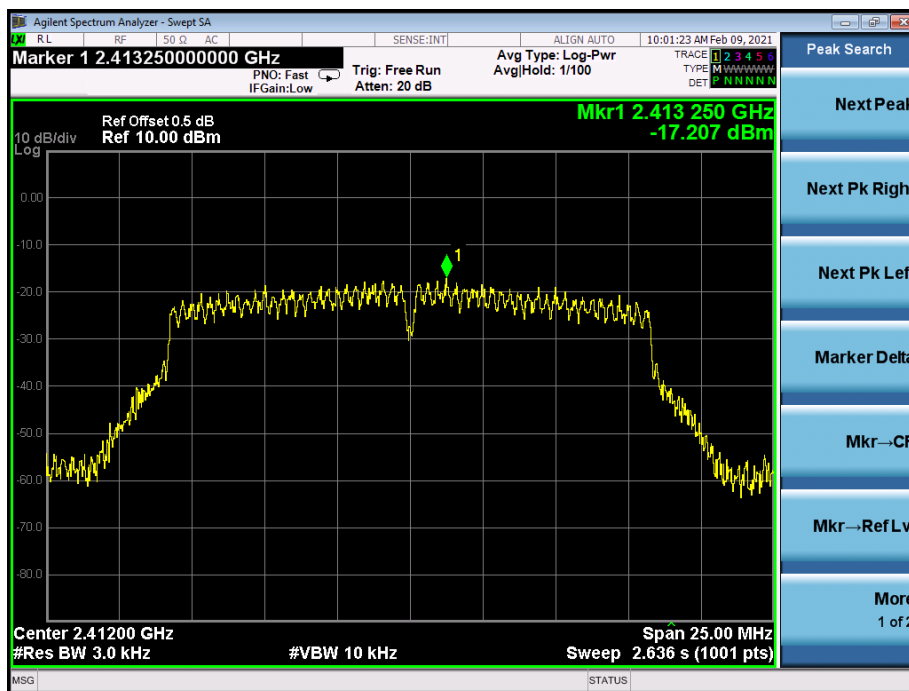
TX CH01

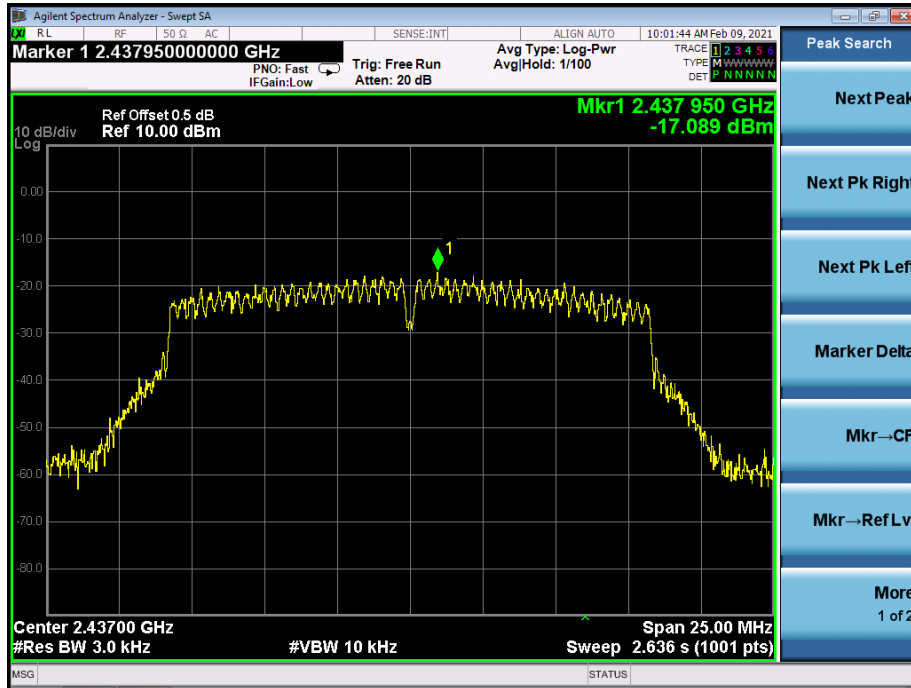
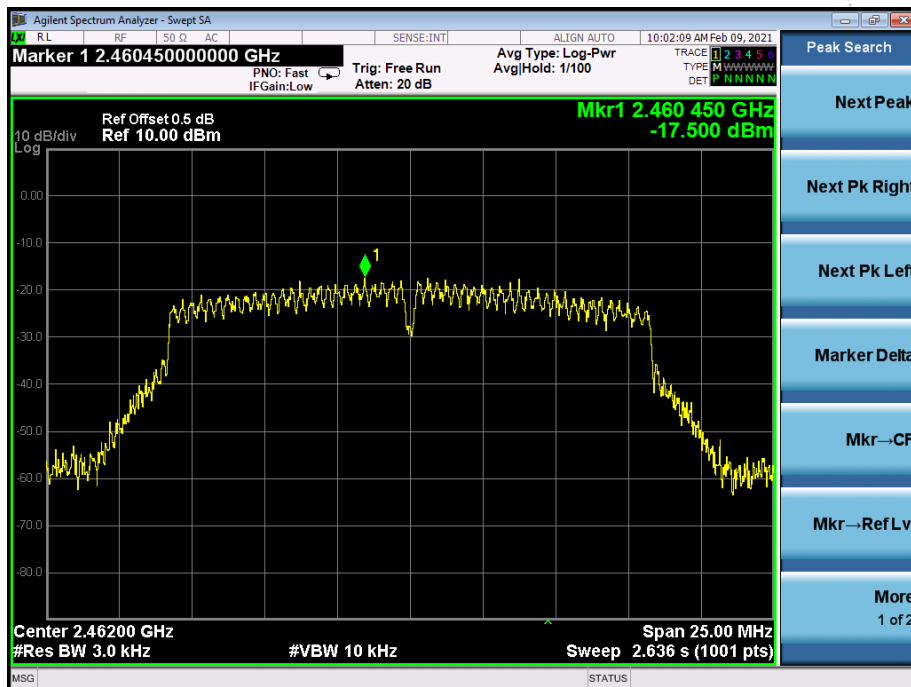

TX CH06

TX CH11

Temperature :	26 °C	Relative Humidity :	54%
Pressure :	101kPa	Test Voltage :	DC 5V
Test Mode :	TX n Mode(20M)		

Frequency	Power Spectral Density (dBm/3KHz) ANTA	Power Spectral Density (dBm/3KHz) ANTB	Total power density (dBm/3KHz)	Limit (dBm/3KHz)	Result
2412 MHz	-18.405	-14.050	-12.69	8	PASS
2437 MHz	-18.767	-18.793	-15.77	8	PASS
2462 MHz	-18.045	-18.984	-15.48	8	PASS

Note: A(B) Represent the value of antenna A and B, The worst data is Antenna B, only shown Antenna B Plot.

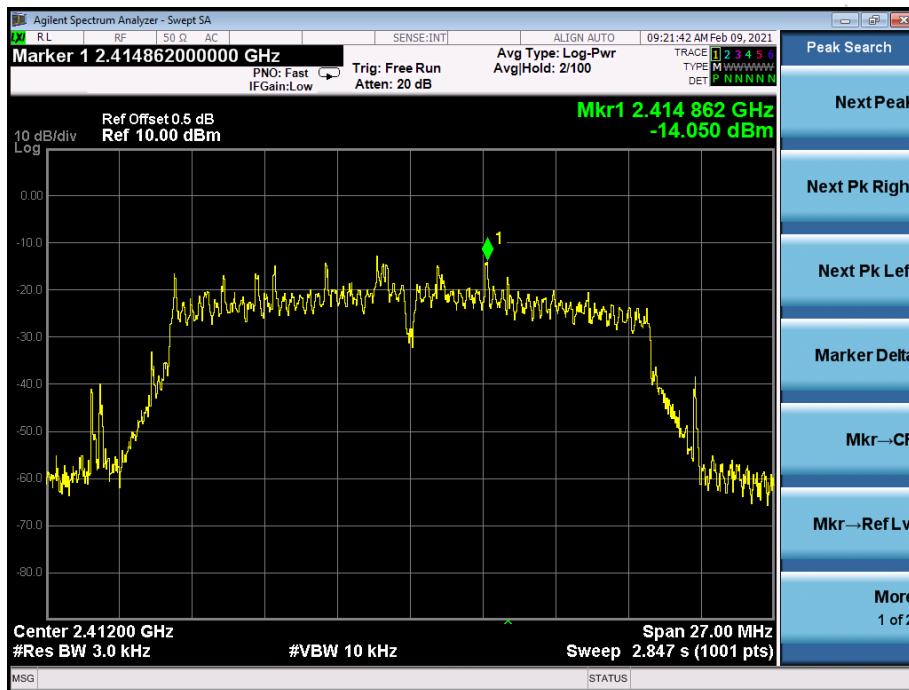
TX CH01

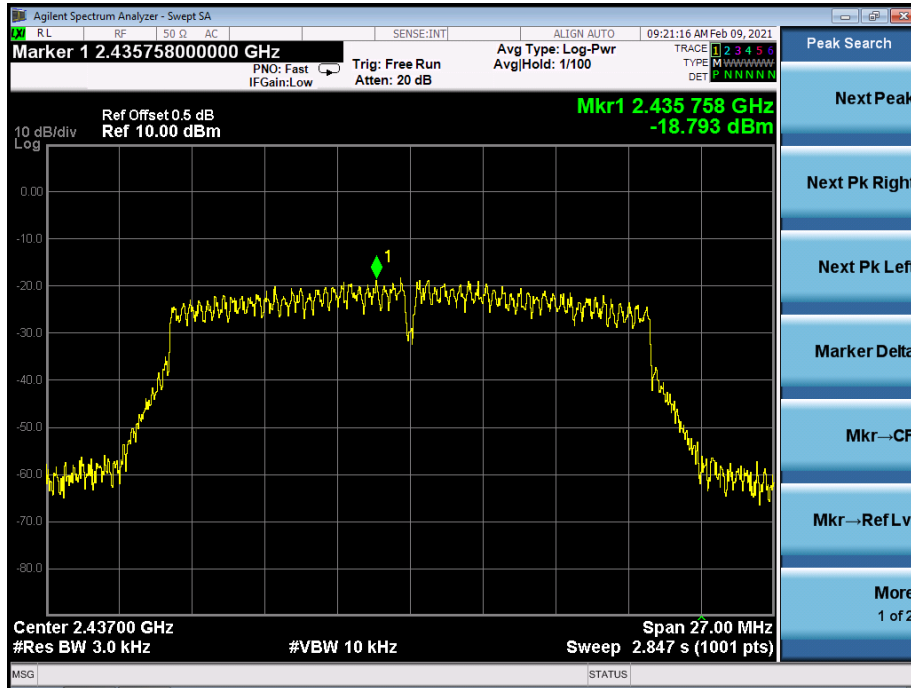
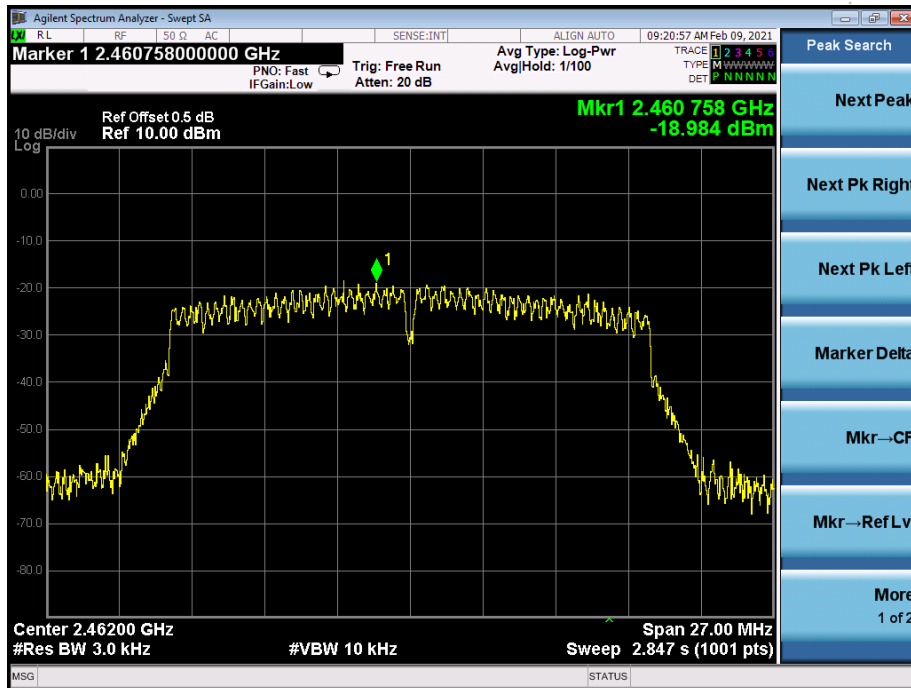

TX CH06

TX CH11

Temperature :	26 °C	Relative Humidity :	54%
Pressure :	101kPa	Test Voltage :	DC 5V
Test Mode :	TX n Mode(40M)		

Frequency	Power Spectral Density (dBm/3KHz) ANTA	Power Spectral Density (dBm/3KHz) ANTB	Total power density (dBm/3KHz)	Limit (dBm/3KHz)	Result
2422 MHz	-19.129	-19.114	-16.11	8	PASS
2437 MHz	-18.622	-19.019	-15.81	8	PASS
2452 MHz	-18.628	-19.943	-16.23	8	PASS

Note: A(B) Represent the value of antenna A and B, The worst data is Antenna A, only shown Antenna A Plot.

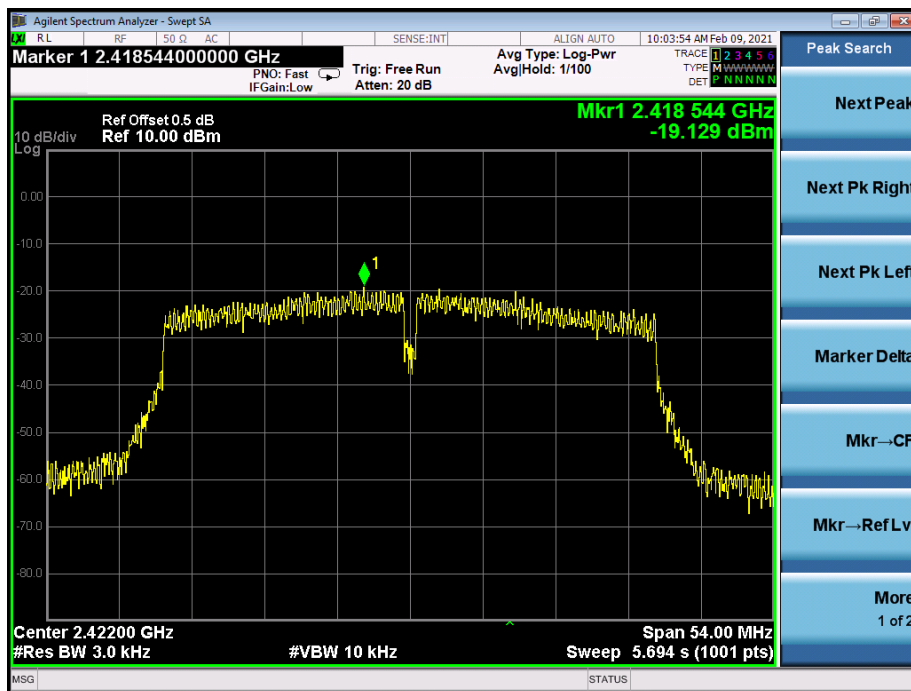
TX CH03

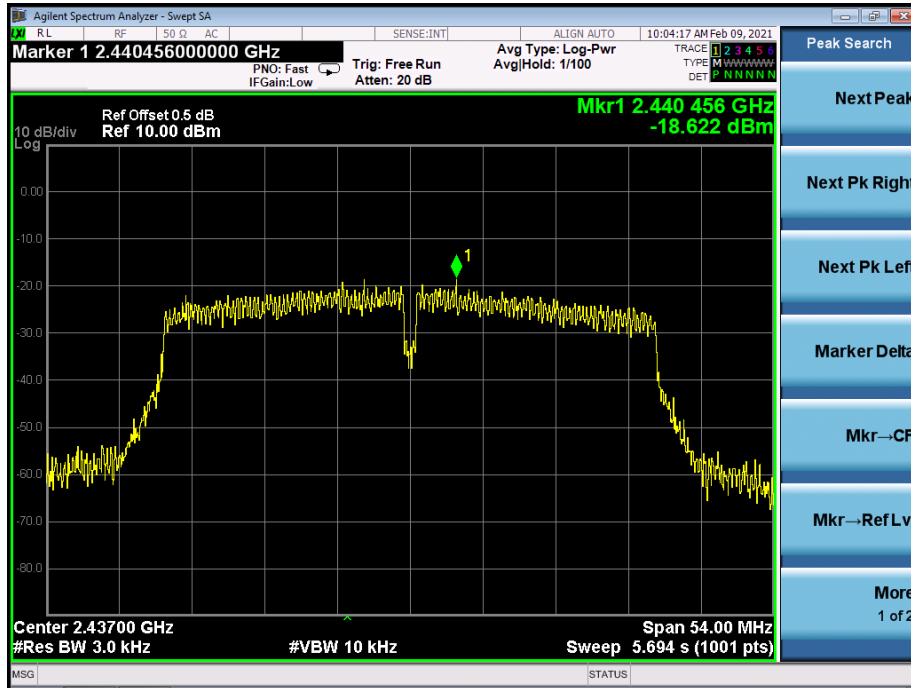
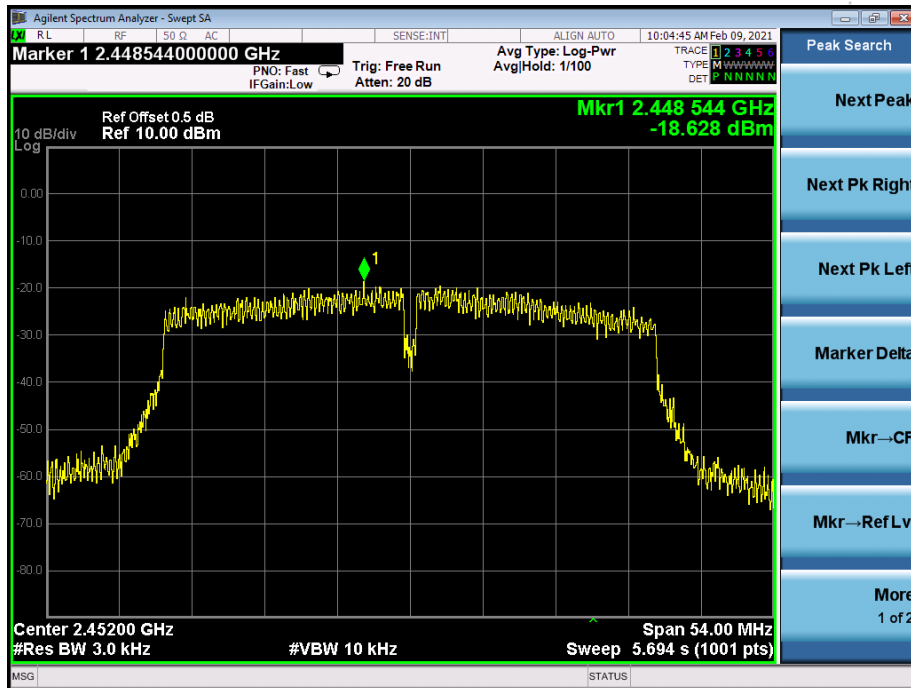

TX CH06

TX CH09

6. BANDWIDTH TEST

6.1 APPLIED PROCEDURES / LIMIT

FCC Part15 (15.247) , Subpart C				
Section	Test Item	Limit	Frequency Range (MHz)	Result
15.247(a)(2)	Bandwidth	$\geq 500\text{KHz}$ (6dB bandwidth)	2400-2483.5	PASS

6.1.1 TEST PROCEDURE

1. Set RBW = 100 kHz.
2. Set the video bandwidth (VBW) $\geq 3 \times$ RBW.
3. Detector = Peak.
4. Trace mode = max hold.
5. Sweep = auto couple.
6. Allow the trace to stabilize.
7. Measure the maximum width of the emission that is constrained by the frequencies associated with the two outermost amplitude points (upper and lower frequencies) that are attenuated by 6 dB relative to the maximum level measured in the fundamental emission.

6.1.2 DEVIATION FROM STANDARD

No deviation.

6.1.3 TEST SETUP

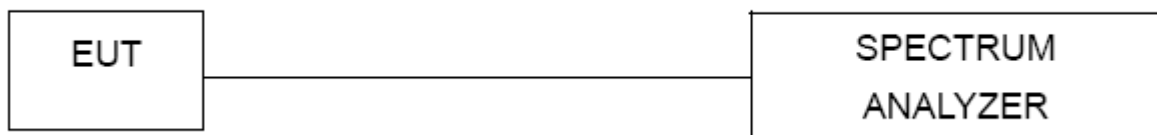

6.1.4 EUT OPERATION CONDITIONS

The EUT tested system was configured as the statements of 2.4 Unless otherwise a special operating condition is specified in the follows during the testing.

6.1.5 TEST RESULTS

Temperature :	26 °C	Relative Humidity :	54%
Pressure :	101kPa	Test Voltage :	DC 5V
Test Mode :	TX b Mode		

Frequency (MHz)	6dB bandwidth (MHz) ANTA	6dB bandwidth (MHz) ANTB	Limit (kHz)	Result
2412	9.59	9.58	500	Pass
2437	10.04	10.03	500	Pass
2462	10.05	10.00	500	Pass

Note: A(B) Represent the value of antenna A and B, The worst data is Antenna A, only shown Antenna A Plot.

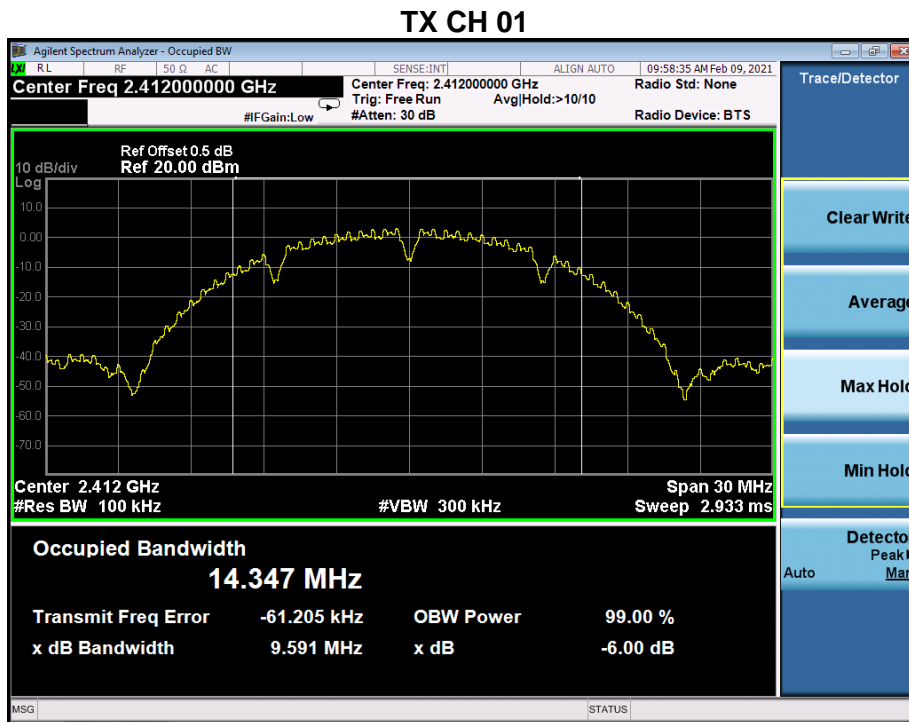

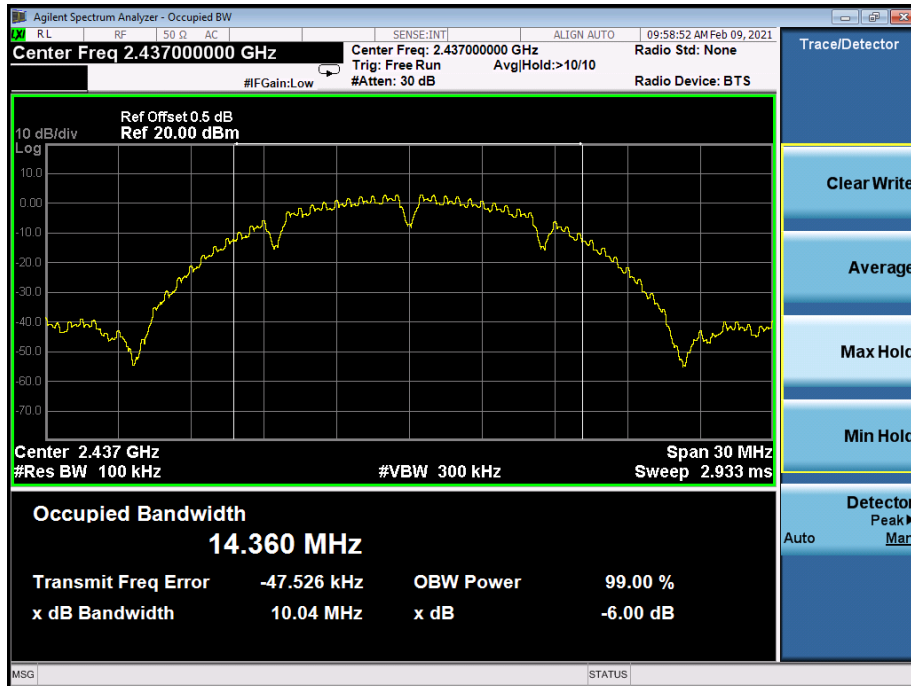
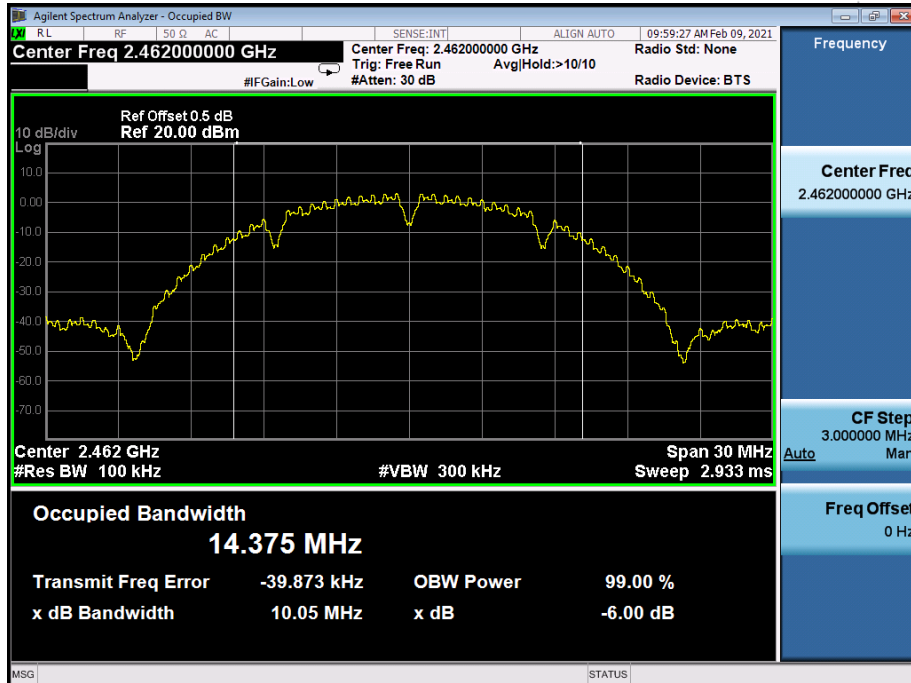
TX CH 06

TX CH 11

Temperature :	26 °C	Relative Humidity :	54%
Pressure :	101kPa	Test Voltage :	DC 5V
Test Mode :	TX g Mode		

Frequency (MHz)	6dB bandwidth (MHz) ANTA	6dB bandwidth (MHz) ANTB	Limit (kHz)	Result
2412	15.15	15.13	500	Pass
2437	15.13	15.13	500	Pass
2462	15.11	15.15	500	Pass

Note: A(B) Represent the value of antenna A and B, The worst data is Antenna B, only shown Antenna B Plot.

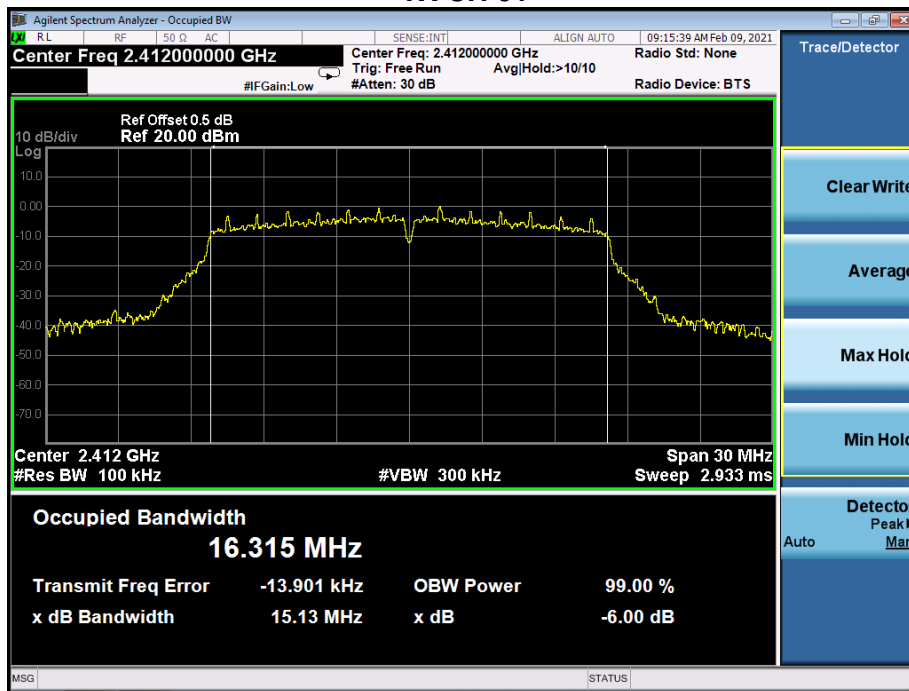
TX CH 01

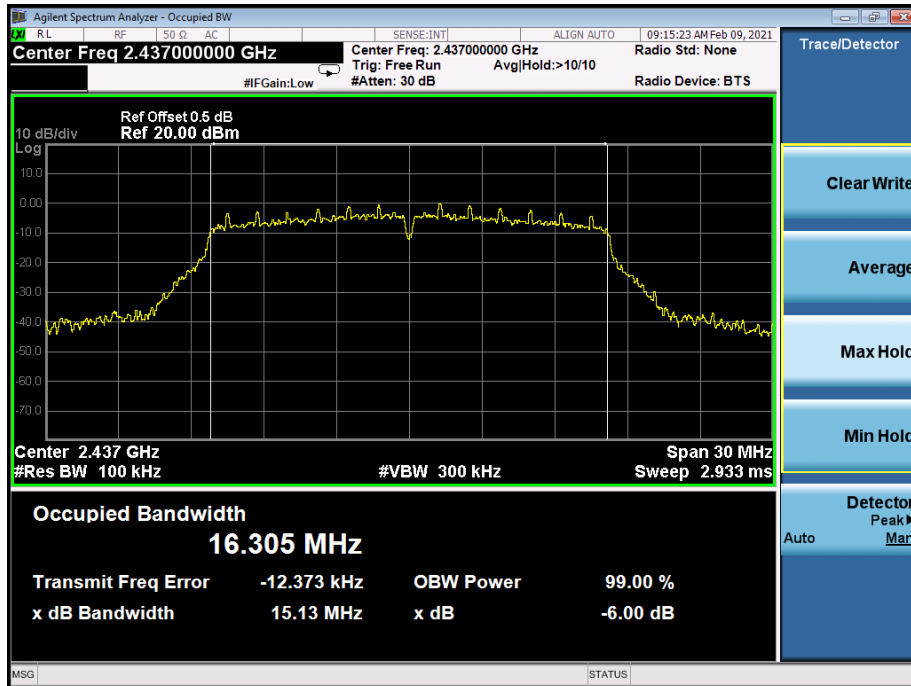
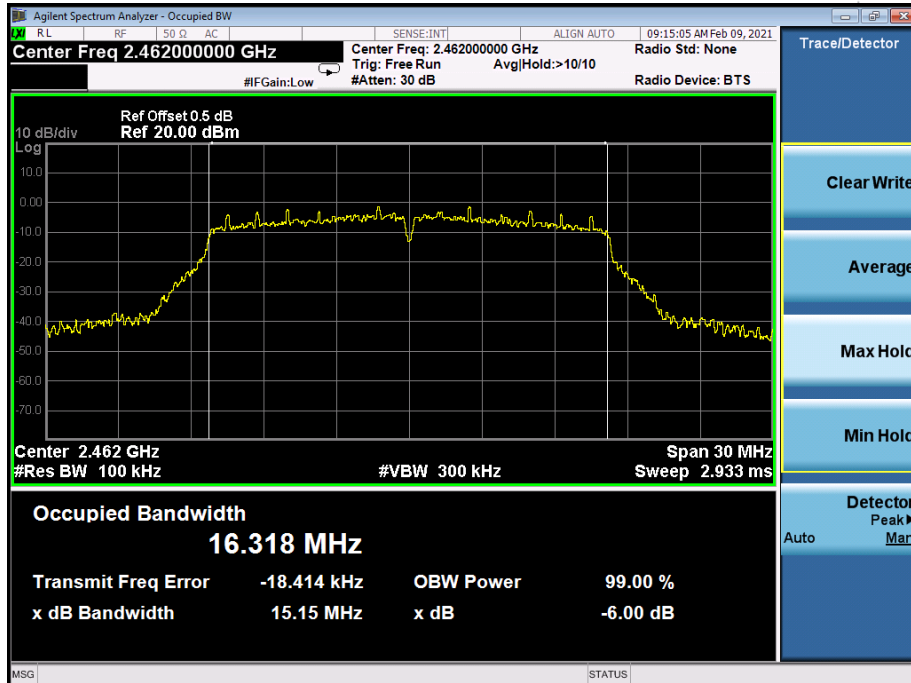

TX CH 06

TX CH 11

Temperature :	26 °C	Relative Humidity :	54%
Pressure :	101kPa	Test Voltage :	DC 5V
Test Mode :	TX n Mode(20M)		

Frequency (MHz)	6dB bandwidth (MHz) ANTA	6dB bandwidth (MHz) ANTB	Limit (kHz)	Result
2412	15.13	15.12	500	Pass
2437	15.05	15.12	500	Pass
2462	15.13	15.12	500	Pass

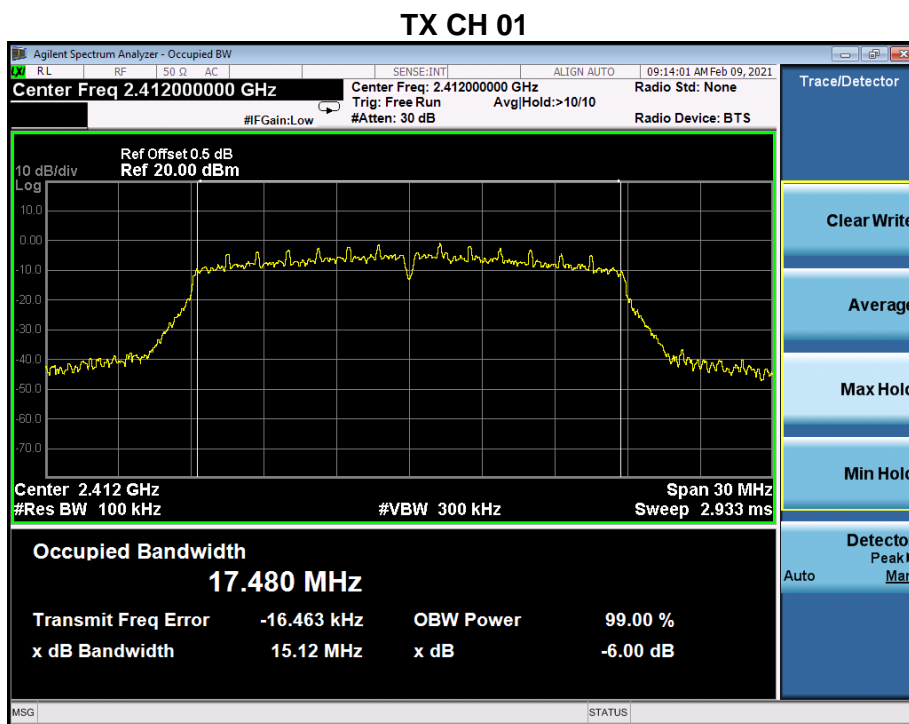
Note: A(B) Represent the value of antenna A and B, The worst data is Antenna B, only shown Antenna B Plot.

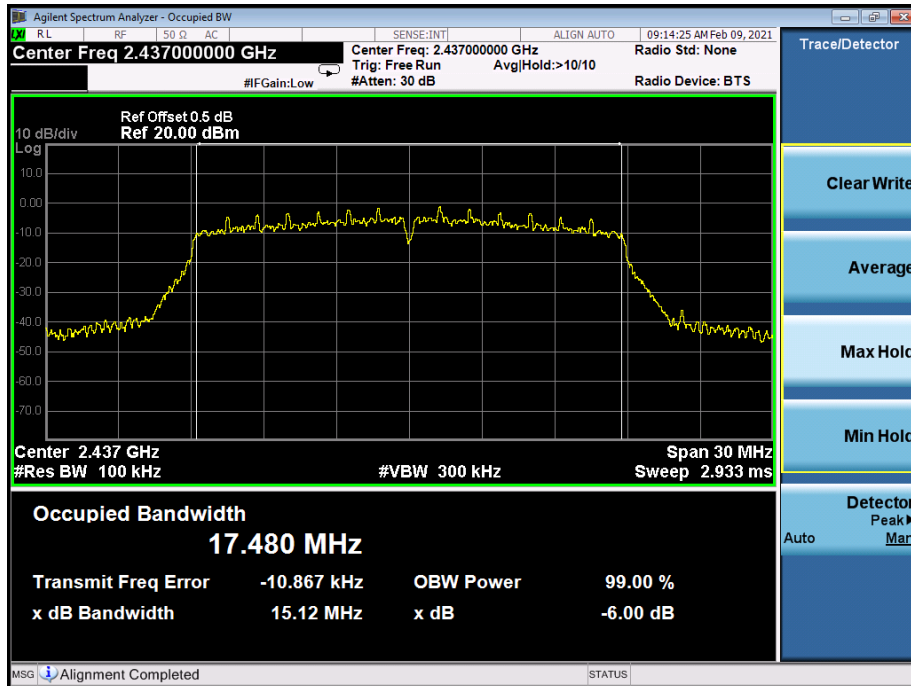
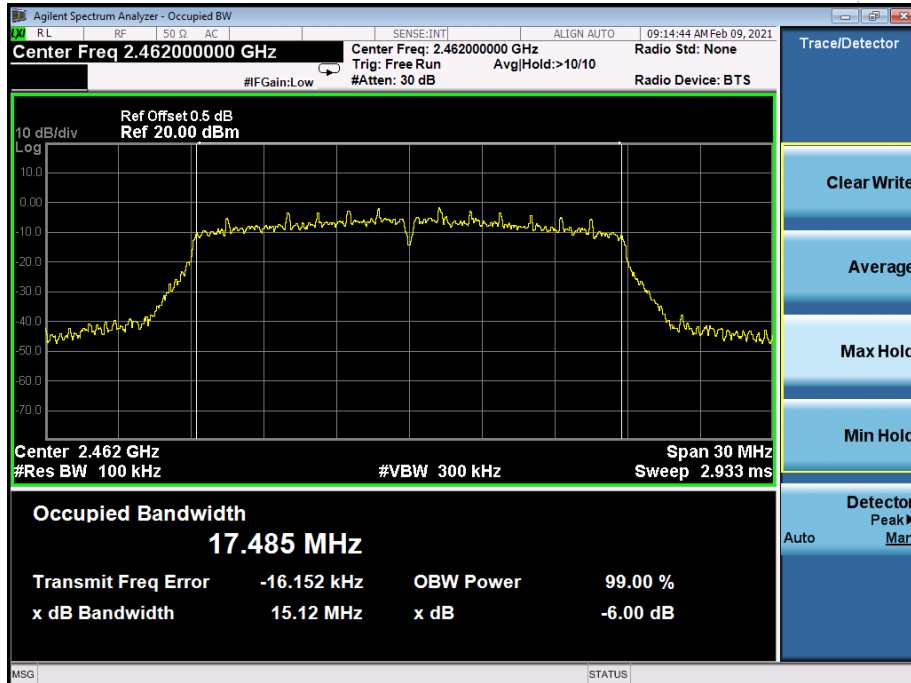

TX CH 06

TX CH 11

Temperature :	26 °C	Relative Humidity :	54%
Pressure :	101kPa	Test Voltage :	DC 5V
Test Mode :	TX n Mode(40M)		

Frequency (MHz)	6dB bandwidth (MHz) ANTA	6dB bandwidth (MHz) ANTB	Limit (kHz)	Result
2422	35.10	35.13	500	Pass
2437	35.11	35.10	500	Pass
2452	35.11	35.11	500	Pass

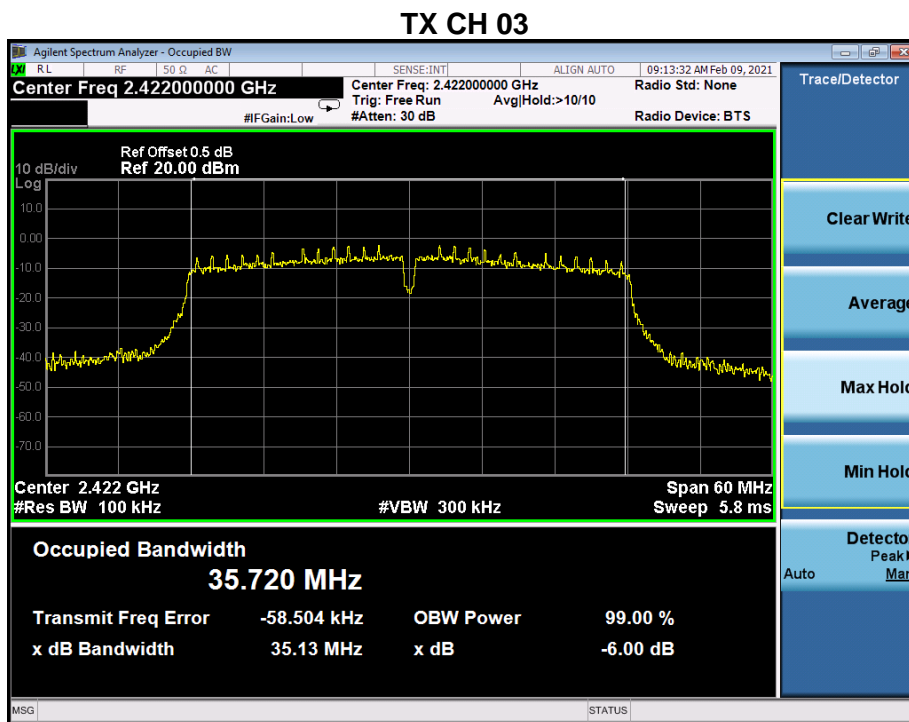
Note: A(B) Represent the value of antenna A and B, The worst data is Antenna B, only shown Antenna B Plot.

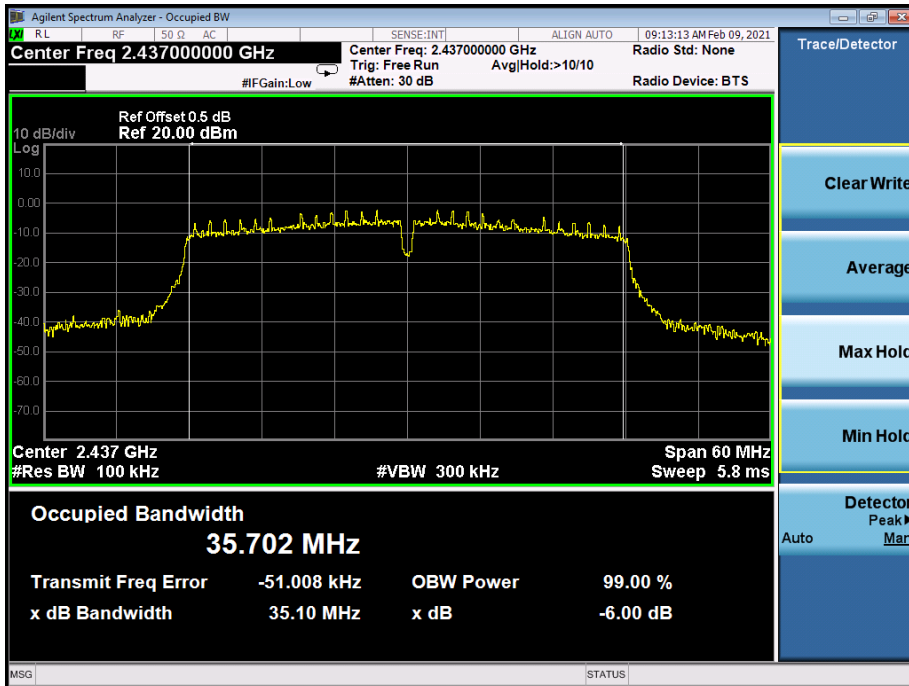

TX CH 06

TX CH 09
