

# MFA Report Tracker

*For MFA internal use only*

*Please keep this page with the report in out files.*

Applicant:	Thrane & Thrane A/S
Model:	Explorer 500
FCC ID:	ROJEXPLORER-500

Formulaire:	L:\Project\Formulaire\FCC.Certification.General.rtf
Last Modified:	1998-Sept-16
Purpose:	FCC, Transmitter Certification for general "Business Band" transmitters. Including "Land Mobile" and "Fixed Radio" stations.
MFA Project ID:	p0580015
Client ID:	THRANETHRANE
MFA Document ID:	d0580057
Date:	August 23, 2005
This Printing	2005-Sep-27 Tue
Writer:	DEL/del

<input type="checkbox"/>	< Check here if this report has been manually modified.
<input type="checkbox"/>	< Check here if this report was made from another report.
	Original document:
<input type="checkbox"/>	< Check here if this report varies significantly from the formulaire



**M. Flom Associates, Inc.**  
**International Compliance Testing Laboratory**  
3356 N. San Marcos Place, Suite 107  
Chandler, AZ 85225  
toll-free: (866) 311-3268  
fax: (480) 926-3598  
<http://www.mflom.com>  
[info@mflom.com](mailto:info@mflom.com)

Date: August 23, 2005

Applicant: Thrane & Thrane A/S  
Lundtoftegardsvej 93D  
DK-2800 Lyngby, Denmark

Attention of: Morten Becker Saul  
+45 39 55 8209  
Email: mbs@thrane.com

Equipment: Explorer 500  
FCC ID: ROJEXPLORER-500  
P.O. Number: ATS JUNOS-1  
FCC Rules: Part 25, 15.247 (Bluetooth) and Confidentiality

Gentlemen:

Enclosed please find your copy of the Engineering Test Reports for which you are subject to the restrictions as listed on the attached summary.

As you know, the FCC, after a TCB issues a Grant, still has 30 days to review a submission and request added information. It is your decision whether or not to market the equipment subject to a possible recall before the end of the 30 days.

If your equipment is still retained by us, it will be returned to you 30 days after approval is achieved. Our invoice for services has been directed to your Accounts Payable Department.

Should you need any clarification, just fax or phone. Thank you again for this order - it has been a pleasure to be of service.

Sincerely yours,

Michael Schafer, President

enclosure(s)  
DEL/del



# M. Flom Associates, Inc.

## International Compliance Testing Laboratory

3356 N. San Marcos Place, Suite 107  
Chandler, AZ 85225

toll-free: (866) 311-3268  
fax: (480) 926-3598

<http://www.mflom.com>  
[info@mflom.com](mailto:info@mflom.com)

### Memo

Date: August 23, 2005

Applicant: Thrane & Thrane A/S  
Lundtoftegardsvej 93D  
DK-2800 Lyngby, Denmark

Equipment: Explorer 500  
FCC ID: ROJEXPLORER-500

Please note that the enclosed Reports reflect the results of tests performed to the currently published Federal Communications Commissions Rules and Regulations.

Should the FCC's Examiners' interpretations request new and unpublished requirements, we will be pleased to provide them. We will invoice you accordingly, i.e. for the time spent on re-testing, providing the amended pages and/or Reports and for the time necessary to be spent on electronic filing. We will of course provide you with copies of any of the additions.

We regret any added expense to the Applicants, but of late the FCC continues to change their requirements without any prior written publication and/or notices.

As in the past, we will continue to provide all liaison with the FCC necessary for the successful conclusion of your project and the receipt of your Grant of Equipment Authorization.

Sincerely yours,

David E. Lee, Quality Assurance Manager



# M. Flom Associates, Inc.

## International Compliance Testing Laboratory

3356 N. San Marcos Place, Suite 107  
Chandler, AZ 85225

toll-free: (866) 311-3268  
fax: (480) 926-3598

<http://www.mflom.com>  
[info@mflom.com](mailto:info@mflom.com)

### Summary of Restrictions

1. All submissions to the FCC are subject to **their** Examiner's interpretation.
2. Please allow from 60 to 90 days before hearing from the FCC with regard to any submission.
3. The FCC can set aside any action; modify or set aside any action, within 30 days. (FCC Rule 1.108, 1.113).
4. Under Rule 2.803, if device is not type accepted/certificated then it must **not** be sold, leased, offered for sale, imported, shipped or distributed or advertised for sale.
5. FCC can revoke its certificates at any time if the equipment does not meet or **continue** to meet their Rules. (Rule Parts 2.927, 2.939).
6. FCC can request a sample at any time (2.936).

M. Flom Associates, Inc.

David E. Lee, Quality Assurance Manager



# M. Flom Associates, Inc.

## International Compliance Testing Laboratory

3356 N. San Marcos Place, Suite 107  
Chandler, AZ 85225

toll-free: (866) 311-3268  
fax: (480) 926-3598

<http://www.mflom.com>  
[info@mflom.com](mailto:info@mflom.com)

Date: August 23, 2005

Federal Communications Commission  
Via: Electronic Filing

Attention: Authorization & Evaluation Division

Applicant: Thrane & Thrane A/S  
Equipment: Explorer 500  
FCC ID: ROJEXPLORER-500  
FCC Rules: Part 25, and Confidentiality

Gentlemen:

On behalf of the Applicant, enclosed please find Application Form 731, Engineering Test Report and all pertinent documentation, the whole for approval of the referenced equipment as shown.

Filing fees are attached.

We trust the same is in order. Should you need any further information, kindly contact the writer who is authorized to act as agent.

Sincerely yours,

Michael Schafer, President

enclosure(s)  
cc: Applicant  
DEL/del



## Transmitter Certification

of

FCC ID: ROJEXPLORER-500

Model: Explorer 500

to

**Federal Communications Commission**

Rule Part(s) Part 25, and Confidentiality

Date of report: August 23, 2005

**On the Behalf of the Applicant:**

Thrane & Thrane A/S

**At the Request of:**

Thrane & Thrane A/S  
Lundtoftegardsvej 93D  
DK-2800 Lyngby, Denmark

P.O. ATS JUNOS-1

**Attention of:**

Morten Becker Saul  
+45 39 55 8209  
Email: [mbs@thrane.com](mailto:mbs@thrane.com)

**Supervised by:**

David E. Lee, Quality Assurance Manager

## List of Exhibits

(FCC **Certification** (Transmitters) - Revised 9/28/98)

Applicant: Thrane & Thrane A/S

FCC ID: ROJEXPLORER-500

### By Applicant:

1. Letter of Authorization
2. Confidentiality Request: 0.457 And 0.459
3. Identification Drawings, 2.1033(c)(11)
  - Label
  - Location of Label
  - Compliance Statement
  - Location of Compliance Statement
4. Photographs, 2.1033(c)(12)
5. Documentation: 2.1033(c)
  - (3) User Manual
  - (9) Tune Up Info
  - (10) Schematic Diagram
  - (10) Circuit Description
  - Block Diagram
  - Parts List
  - Active Devices
6. MPE Report

### By M.F.A. Inc.:

- A. Testimonial & Statement of Certification

**The Applicant has been cautioned as to the following:**

15.21 **Information to the User.**

The users manual or instruction manual for an intentional radiator shall caution the user that changes or modifications not expressly approved by the party responsible for compliance could void the user's authority to operate the equipment.

15.27(a) **Special Accessories.**

Equipment marketed to a consumer must be capable of complying with the necessary regulations in the configuration in which the equipment is marketed. Where special accessories, such as shielded cables and/or special connectors are required to enable an unintentional or intentional radiator to comply with the emission limits in this part, the equipment must be marketed with, i.e. shipped and sold with, those special accessories. However, in lieu of shipping or packaging the special accessories with the unintentional or intentional radiator, the responsible party may employ other methods of ensuring that the special accessories are provided to the consumer, without additional charge.

Information detailing any alternative method used to supply the special accessories for a grant of equipment authorization or retained in the verification records, as appropriate. The party responsible for the equipment, as detailed in § 2.909 of this chapter, shall ensure that these special accessories are provided with the equipment. The instruction manual for such devices shall include appropriate instructions on the first page of text concerned with the installation of the device that these special accessories must be used with the device. It is the responsibility of the user to use the needed special accessories supplied with the equipment.



## Table of Contents

<u>Rule</u>	<u>Description</u>	<u>Page</u>
2.1033(c)(14)	Rule Summary	2
	Standard Test Conditions and Engineering Practices	3
2.1033(c)	General Information Required	4
2.1046(a)	Carrier Output Power (Conducted)	6
2.1046(a)	EIRP Carrier Power (Radiated)	8
2.1051	Unwanted Emissions (Transmitter Conducted)	10
2.1053(a)	Field Strength of Spurious Radiation	14
2.1049(c)(1)	Emission Masks (Occupied Bandwidth)	18
2.1055(a)(1)	Frequency Stability (Temperature Variation)	41
2.1055(b)(1)	Frequency Stability (Voltage Variation)	43
25.216	Limits on Emissions (Mobile Earth Stations)	45
25.253	Special Requirements	47
15.205	Restricted Bands Of Operation	2

Required information per ISO/IEC Guide 25-1990, paragraph 13.2:

a) **Test Report**

b) Laboratory: M. Flom Associates, Inc.  
(FCC: 31040/SIT) 3356 N. San Marcos Place, Suite 107  
(Canada: IC 2044) Chandler, AZ 85225

c) Report Number: d0580057

d) Client: Thrane & Thrane A/S  
Lundtoftegardsvej 93D  
DK-2800 Lyngby, Denmark

e) Identification: Explorer 500  
FCC ID: ROJEXPLORER-500  
EUT Description: Immarsat Terminal

f) EUT Condition: Not required unless specified in individual tests.

g) Report Date: August 23, 2005  
EUT Received: August 22, 2005

h, j, k): As indicated in individual tests.

i) Sampling method: No sampling procedure used.

l) Uncertainty: In accordance with MFA internal quality manual.

m) Supervised by:



David E. Lee, Quality Assurance Manager

n) Results: The results presented in this report relate only to the item tested.

o) Reproduction: This report must not be reproduced, except in full, without written permission from this laboratory.

Sub-part

2.1033(c)(14):

## Test and Measurement Data

All tests and measurement data shown were performed in accordance with FCC Rules and Regulations, Volume II; Part 2, Sub-part J, Sections 2.947, 2.1033(c), 2.1041, 2.1046, 2.1047, 2.1079, 2.1051, 2.1053, 2.1055, 2.1057 and the following individual Parts:

- 15 Subpart C - Unlicensed Low Power Devices
- 21 - Domestic Public Fixed Radio Services
- 22 - Public Mobile Services
- 22 Subpart H - Cellular Radiotelephone Service
- 22.901(d) - Alternative technologies and auxiliary services
- 23 - International Fixed Public Radiocommunication services
- 24 - Personal Communications Services
- 25 - Satellite Communications
- 74 Subpart H - Low Power Auxiliary Stations
- 80 - Stations in the Maritime Services
- 80 Subpart E - General Technical Standards
- 80 Subpart F - Equipment Authorization for Compulsory Ships
- 80 Subpart K - Private Coast Stations and Marine Utility Stations
- 80 Subpart S - Compulsory Radiotelephone Installations for Small Passenger Boats
- 80 Subpart T - Radiotelephone Installation Required for Vessels on the Great Lakes
- 80 Subpart U - Radiotelephone Installations Required by the Bridge-to-Bridge Act
- 80 Subpart V - Emergency Position Indicating Radio Beacons (EPIRB'S)
- 80 Subpart W - Global Maritime Distress and Safety System (GMDSS)
- 80 Subpart X - Voluntary Radio Installations
- 87 - Aviation Services
- 90 - Private Land Mobile Radio Services
- 94 - Private Operational-Fixed Microwave Service
- 95 Subpart A - General Mobile Radio Service (GMRS)
- 95 Subpart C - Radio Control (R/C) Radio Service
- 95 Subpart D - Citizens Band (CB) Radio Service
- 95 Subpart E - Family Radio Service
- 95 Subpart F - Interactive Video and Data Service (IVDS)
- 97 - Amateur Radio Service
- 101 - Fixed Microwave Services



## Standard Test Conditions and Engineering Practices

Except as noted herein, the following conditions and procedures were observed during the testing:

In accordance with ANSI C63.4-1992/2000, section 6.1.9, and unless otherwise indicated in the specific measurement results, the ambient temperature of the actual EUT was maintained within the range of 10° to 40°C (50° to 104 °F) unless the particular equipment requirements specify testing over a different temperature range. Also, unless otherwise indicated, the humidity levels were in the range of 10% to 90% relative humidity.

Prior to testing, the EUT was tuned up in accordance with the manufacturer's alignment procedures. All external gain controls were maintained at the position of maximum and/or optimum gain throughout the testing.

Measurement results, unless otherwise noted, are worst-case measurements.

 <p style="text-align: center;"><b>AZLA</b>  <small>THE AMERICAN ASSOCIATION FOR LABORATORY ACCREDITATION</small></p> <p style="text-align: center;"><b>ACCREDITED LABORATORY</b></p> <p>AZLA has accredited  <b>M. FLOM ASSOCIATES, INC.</b>  <b>Chandler, AZ</b>      for technical competence in the field of  <b>Electrical Testing</b></p> <p><small>The accreditation covers the specific tests and types of tests listed on the agreed scope of accreditation. This laboratory meets the requirements of ISO/IEC 17025-1999 'General Requirements for the Competence of Testing and Calibration Laboratories' and any additional program requirements in the identified field of testing.</small></p> <p><small>Presented this 10<sup>th</sup> day of June 2004.</small></p> <div style="display: flex; justify-content: space-around; align-items: center;">  <div style="text-align: center;">   <small>President        For the Accreditation Council        Certificate Number: 2152-01        Valid to August 31, 2006</small> </div> </div> <p><small>For tests or types of tests to which this accreditation applies, please refer to the laboratory's Electrical Scope of Accreditation.</small></p>	<h3 style="margin-top: 0;">A2LA</h3> <hr/> <p>“A2LA has accredited M. Flom Associates, Inc. Chandler, AZ for technical competence in the field of Electrical Testing. The accreditation covers the specific tests and types of tests listed on the agreed scope of accreditation. This laboratory meets the requirements of ISO/IEC 17025 - 1999 'General Requirements for the Competence of Testing and Calibration Laboratories' and any additional program requirements in the identified field of testing.”</p> <hr/> <p>Certificate Number: <b>2152-01</b></p>
---	---

## List of General Information Required for Certification

In Accordance with FCC Rules and Regulations,  
 Volume II, Part 2, Part 25 and Confidentiality

Sub-part 2.1033

(c)(1): **Name and Address of Applicant:**

Thrane & Thrane A/S  
 Lundtoftegardsvej 93D  
 DK-2800 Lyngby, Denmark

**Manufacturer:**

Thrane & Thrane A/S  
 Lundtoftegardsvej 93D  
 DK-2800 Lyngby, Denmark

(c)(2): **FCC ID:**

ROJEXPLORER-500

**Model Number:**

Explorer 500

(c)(3): **Instruction Manual(s):**

Please see attached exhibits

(c)(4): **Type of Emission:**

16QAM; 42K0D1W, 84K0D1W, 200KD1W,  
 QPSK; 21K0G1D, 42K0G1D, 84K0G1D, 200KG1D

(c)(5): **Frequency Range, MHz:**

1626.5 - 1660.5

(c)(6): **Power Rating, Watts:**

15.0

Switchable

Variable

N/A

(c)(7): **Maximum Power Rating, Watts:**

25.0

**DUT Results:**

Passes

Fails

Subpart 2.1033 (continued)

(c)(8): Voltages & currents in all elements in final RF stage, including final transistor or solid-state device:

Composite Unit: Figures are with both Part 25 and Part 15.247 units operating;

Collector Current, A	=	3.0
Collector Voltage, Vdc	=	8.0
Supply Voltage, Vdc	=	10 - 16

(c)(9): **Tune-Up Procedure:**

Please see attached exhibits

(c)(10): **Circuit Diagram/Circuit Description:**

Including description of circuitry & devices provided for determining and stabilizing frequency, for suppression of spurious radiation, for limiting modulation and limiting power.

Please see attached exhibits

(c)(11): **Label Information:**

Please see attached exhibits

(c)(12): **Photographs:**

Please see attached exhibits

(c)(13): **Digital Modulation Description:**

Attached Exhibits  
 N/A

(c)(14): **Test and Measurement Data:**

Follows

**Name of Test:** Carrier Output Power (Conducted)  
**Specification:** 47 CFR 2.1046(a)  
**Guide:** ANSI/TIA/EIA-603-1992, Paragraph 2.2.1

**Measurement Procedure**

- A) The EUT was connected to a resistive coaxial attenuator of normal load impedance, and the unmodulated output power was measured by means of an RF Power Meter.
- B) Measurement accuracy is  $\pm 3\%$ .

**Transmitter Test Set-Up: RF Power Output**

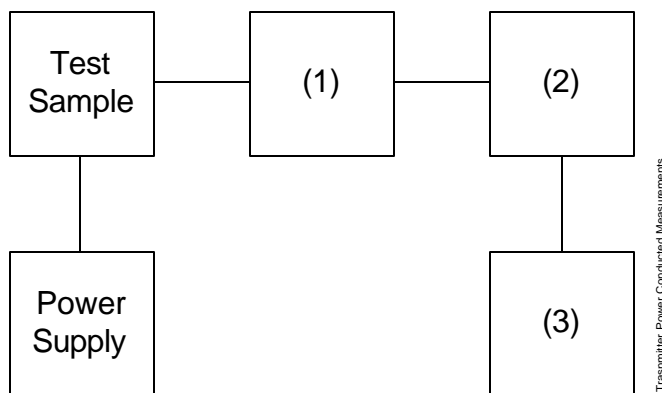

Asset	Description	s/n	Cycle	Last Cal
(1)	<b>Coaxial Attenuator</b>			
X	i00231/2 PASTERNAK PE7021-30 (30 dB)	231 or 232	NCR	
	i00122/3 NARDA 766 (10 dB)	7802 or 7802A	NCR	
(2)	<b>Power Meters</b>			
X	i00020 HP 8901A Power Mode	2105A01087	12 mo.	Apr-05
(3)	<b>Frequency Counter</b>			
X	i00020 HP 8901A Frequency Mode	2105A01087	12 mo.	Apr-05

**Name of Test:** Carrier Output Power (Conducted)

**Measurement Results**  
(Worst case)

Immarsat:  
 Frequency of Carrier, MHz = 1643.5, 1626.5, 1660.5  
 Ambient Temperature = 23°C ± 3°C

Power Setting	RF Power, dBm	RF Power, Watts
High	31.1	1.29



Performed by: Fred Chastain, Test Technician



**Name of Test:** EIRP Carrier Power (Radiated)

**Specification:** TIA/EIA 603(Substitution Method)

### Measurement Procedure

#### Definition

The average radiated power of a licensed device is the equivalent power required, when delivered to a half-wave dipole or horn antenna, to produce at a distant point the same average received power as produced by the licensed device.

#### Method of Measurement:

- A) Connect the equipment as illustrated. Place the transmitter to be tested on the turntable in the standard test site.

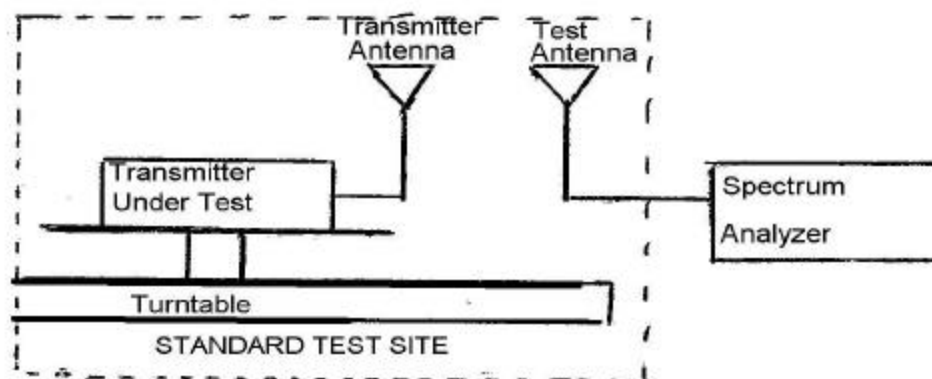

- B) Raise and lower the test antenna from 1m to 6 m with the transmitter facing the antenna and record the highest received signal in dB as LVL.
- C) Replace the transmitter under test with a half-wave or horn vertically polarized antenna. The center of the antenna should be at the same location as the transmitter under test. Connect the antenna to a signal generator with a known output power and record the path loss in dB or LOSS.
- D) Calculate the radiated output power from the following:

$$\text{average radiated power} = 10 \log_{10} \left( \frac{10(\text{LVL} - \text{LOSS})}{10} \right) \text{ (dBm)}$$

Name of Test: EIRP Carrier Power (Radiated)

**Test Equipment**

Asset	Description	s/n	Cycle	Last Cal
<b>Transducer</b>				
	i00088	EMCO 3109-B 25MHz-300MHz	2336	24 mo. Sep-03
X	i00089	April 2001 200MHz-1GHz	001500	24 mo. Sep-03
X	i00103	EMCO 3115 1GHz-18GHz	9208-3925	24 mo. Jan-04
<b>Amplifier</b>				
X	i00028	HP 8449A	2749A00121	12 mo. May-05
<b>Spectrum Analyzer</b>				
X	i00029	HP 8563E	3213A00104	12 mo. May-05
X	i00033	HP 85462A	3625A00357	12 mo. Sep-04
<b>Substitution Generator</b>				
	i00067	HP 8920A Communication TS	3345U01242	12 mo. Jun-05
X	i00207	HP 8753D Network Analyzer	3410A08514	12 mo. Jul-05

**Measurement Results**

g0580128: 2005-Aug-23 Tue 06:26:00  
State: 2:High Power

Ambient Temperature: 28°C ± 3°C

Frequency Tuned, MHz	Frequency Emission, MHz	Meter, dBuV/m	CF, dB	EIRP, dBm	EIRP, Watts
1626.500000	1626.600000	108.94	27.64	41.4	13.80
1643.500000	1643.500000	108.23	27.66	40.7	11.75
1660.500000	1660.405000	108.92	27.68	41.4	13.80



Performed by:

Fred Chastain, Test Technician

**Name of Test:** Unwanted Emissions (Transmitter Conducted)

**Specification:** 47 CFR 2.1051

**Guide:** ANSI/TIA/EIA-603-1992, Paragraph 2.2.13

**Measurement Procedure**

- A) The emissions were measured for the worst case as follows:
  - 1). within a band of frequencies defined by the carrier frequency plus and minus one channel.
  - 2). from the lowest frequency generated in the EUT and to at least the 10th harmonic of the carrier frequency, or 40 GHz, whichever is lower.
- B) The magnitude of spurious emissions that are attenuated more than 20 dB below the permissible value need not be specified.

**Transmitter Test Set-Up: Spurious Emission**

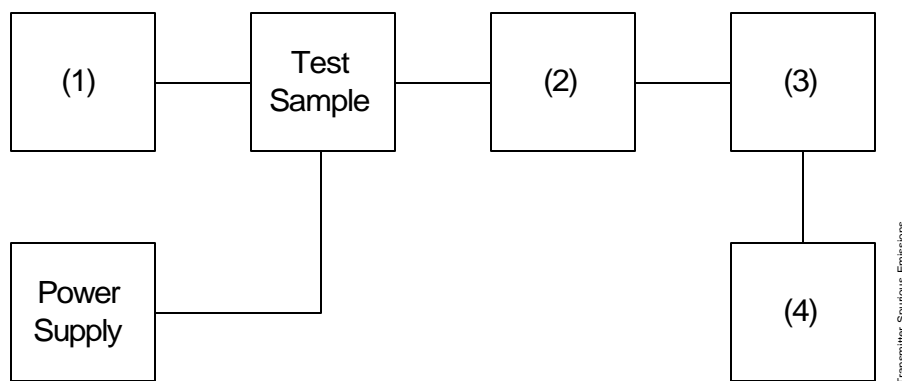

Asset	Description	s/n		
<b>(1) Audio Oscillator/Generator</b>				
X	i00017	HP 8903A Audio Analyzer	2216A01753	12 mo. Apr-05
	i00002	HP 3336B Synthesizer / Level Gen.	1931A01465	12 mo. Apr-05
<b>(2) Coaxial Attenuator</b>				
X	i00231/2	PASTERNAK PE7021-30 (30 dB)	231 or 232	NCR
	i0012/3	NARDA 766 (10 dB)	7802 or 7802A	NCR
<b>(3) Filters; Notch, HP, LP, BP</b>				
X	-	High Pass, 3GHz	-	NCR
<b>(4) Spectrum Analyzer</b>				
	i00048	HP 8566B Spectrum Analyzer	2511A01467	12 mo. Oct-04
X	i00029	HP 8563E Spectrum Analyzer	3213A00104	12 mo. May-05

**Name of Test:** Unwanted Emissions (Transmitter Conducted)

**Measurement Results**  
(Worst Case)

Summary:

Frequency of carrier, MHz = 1643.5, 1626.5, 1660.5  
 Spectrum Searched, GHz = 50MHz - 10\*Fc  
 Maximum Response, Hz = N/A  
 All Other Emissions = = 20 dB Below Limit  
 Limit(s), dBc  
 $-(43+10x\text{LOG P}) = -13\text{dBm}$

Tabulated Results follow:

**Measurement Results**

g0580125: 2005-Aug-22 Mon 11:39:00  
 State: 2:High Power

Ambient Temperature: 23°C ± 3°C

Frequency Tuned, MHz	Frequency Emission, MHz	Level, dBm	Level, dBc
1643.500000	50.000000	-68.70	-101.50
1626.500000	50.000000	-69.30	-102.10
1660.500000	50.000000	-69.50	-102.30
1626.500000	125.433333	-66.00	-98.80
1660.500000	143.766667	-66.00	-98.80
1643.500000	148.900000	-65.20	-98.00
1643.500000	214.250000	-65.50	-98.30
1626.500000	263.200000	-65.80	-98.60
1660.500000	298.950000	-65.80	-98.60
1643.500000	319.750000	-65.80	-98.60
1626.500000	367.233333	-65.30	-98.10
1660.500000	370.533333	-66.20	-99.00
1643.500000	398.116667	-66.30	-99.10
1660.500000	414.800000	-66.00	-98.80
1626.500000	432.766667	-66.00	-98.80
1660.500000	516.266667	-66.00	-98.80
1643.500000	555.500000	-66.20	-99.00
1626.500000	573.466667	-66.20	-99.00
1643.500000	611.500000	-66.00	-98.80
1626.500000	623.050000	-65.70	-98.50
1660.500000	698.400000	-66.00	-98.80
1626.500000	701.233333	-66.20	-99.00
1643.500000	727.083333	-65.50	-98.30
1660.500000	739.000000	-66.00	-98.80

**Name of Test:** Unwanted Emissions (Transmitter Conducted)

Frequency Tuned, MHz	Frequency Emission, MHz	Level, dBm	Level, dBc
1660.500000	802.700000	-66.00	-98.80
1626.500000	889.966667	-65.50	-98.30
1643.500000	896.933333	-65.30	-98.10
1626.500000	905.083333	-65.80	-98.60
1660.500000	925.066667	-65.30	-98.10
1643.500000	947.066667	-66.00	-98.80
1660.500000	995.366667	-65.30	-98.10
1626.500000	1031.850000	-66.20	-99.00
1643.500000	1057.333333	-66.20	-99.00
1643.500000	1101.783333	-66.00	-98.80
1660.500000	1121.766667	-65.70	-98.50
1626.500000	1202.983333	-65.70	-98.50
1626.500000	1208.383333	-65.80	-98.60
1643.500000	1212.233333	-65.30	-98.10
1660.500000	1212.233333	-65.70	-98.50
1660.500000	1328.916667	-66.00	-98.80
1643.500000	1340.283333	-65.80	-98.60
1626.500000	1360.450000	-65.30	-98.10
1660.500000	1436.983333	-65.50	-98.30
1643.500000	1458.250000	-65.80	-98.60
1626.500000	1494.366667	-64.80	-97.60
1626.500000	1524.516667	-66.00	-98.80
1643.500000	1534.600000	-65.50	-98.30
1660.500000	1552.383333	-65.80	-98.60
1643.500000	1723.600000	-65.50	-98.30
1626.500000	1760.450000	-65.50	-98.30
1660.500000	1770.533333	-65.80	-98.60
1643.500000	1803.983333	-65.80	-98.60
1626.500000	1819.566667	-65.30	-98.10
1660.500000	1871.633333	-66.00	-98.80
1660.500000	1899.950000	-65.30	-98.10
1643.500000	1927.083333	-65.20	-98.00
1626.500000	1999.316667	-65.20	-98.00
1626.500000	3253.445000	-65.50	-98.30
1643.500000	3287.108333	-66.80	-99.60
1660.500000	3321.256667	-67.50	-100.30
1626.500000	4879.568333	-67.70	-100.50
1643.500000	4930.306667	-67.70	-100.50
1660.500000	4981.285000	-67.80	-100.60
1626.500000	6506.121667	-65.50	-98.30
1643.500000	6573.515000	-66.20	-99.00
1660.500000	6642.111667	-66.20	-99.00
1626.500000	8132.811667	-64.70	-97.50
1643.500000	8217.166667	-66.30	-99.10
1660.500000	8302.876667	-66.30	-99.10

**Name of Test:** Unwanted Emissions (Transmitter Conducted)

Frequency Tuned, MHz	Frequency Emission, MHz	Level, dBm	Level, dBc
1626.500000	9759.485000	-66.50	-99.30
1643.500000	9861.448333	-66.30	-99.10
1660.500000	9963.388333	-66.00	-98.80
1626.500000	11385.975000	-66.30	-99.10
1643.500000	11504.001667	-66.70	-99.50
1660.500000	11623.630000	-65.30	-98.10
1626.500000	13012.475000	-66.30	-99.10
1643.500000	13147.623333	-66.30	-99.10
1660.500000	13283.551667	-63.20	-96.00
1626.500000	14638.191667	-65.00	-97.80
1643.500000	14791.005000	-63.80	-96.60
1660.500000	14944.516667	-63.70	-96.50
1626.500000	16264.756667	-63.70	-96.50
1643.500000	16435.475000	-63.80	-96.60
1660.500000	16604.741667	-63.70	-96.50



Performed by:

Fred Chastain, Test Technician

**Name of Test:** Field Strength of Spurious Radiation  
**Specification:** 47 CFR 2.1053(a)  
**Guide:** ANSI/TIA/EIA-603-1992/2001, Paragraph 1.2.12 and Table 16, 47 CFR 22.917

### Measurement Procedure

#### Definition:

Radiated spurious emissions are emissions from the equipment when transmitting into a non-radiating load on a frequency or frequencies which are outside an occupied band sufficient to ensure transmission of information of required quality for the class of communications desired.

#### Method of Measurement:

- A) Connect the equipment as illustrated
- B) Adjust the spectrum analyzer for the following settings:
  - 1) Resolution Bandwidth 100 kHz (<1 GHz), 1 MHz (> 1GHz).
  - 2) Video Bandwidth = 3 times Resolution Bandwidth, or 30 kHz (22.917)
  - 3) Sweep Speed  $\leq 2000$  Hz/second
  - 4) Detector Mode = Mean or Average Power
- C) Place the transmitter to be tested on the turntable in the standard test site. The transmitter is transmitting into a non-radiating load that is placed on the turntable. The RF cable to this load should be of minimum length.

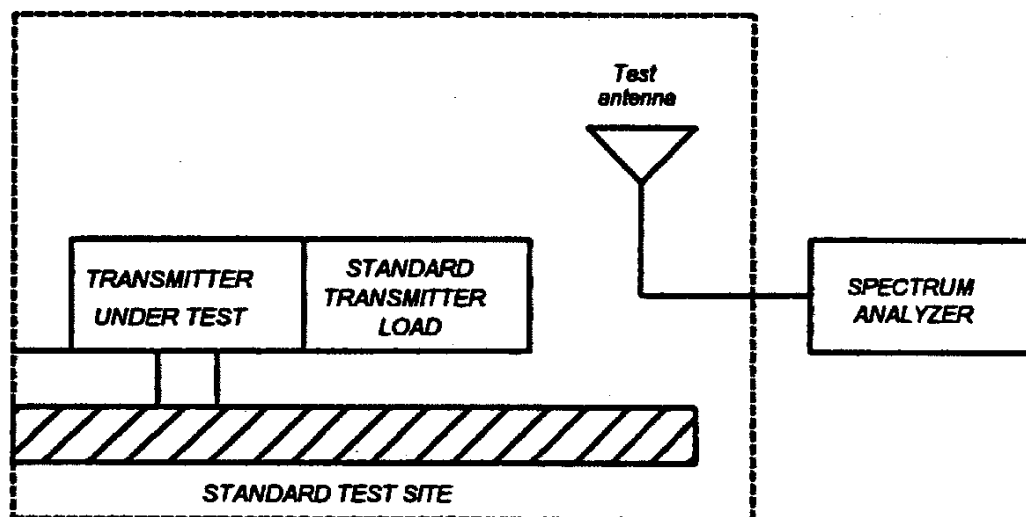

**Name of Test:** Field Strength of Spurious Radiation (Cont.)

- D) For each spurious measurement the test antenna should be adjusted to the correct length for the frequency involved. This length may be determined from a calibration ruler supplied with the equipment. Measurements shall be made from the lowest radio frequency generated in the equipment to the tenth harmonic of the carrier, except for the region close to the carrier equal to  $\pm$  the test bandwidth (see section 1.3.4.4).
- E) For each spurious frequency, raise and lower the test antenna from 1 m to 4 m to obtain a maximum reading on the spectrum analyzer with the test antenna at horizontal polarity. Repeat this procedure to obtain the highest possible reading. Record this maximum reading.
- F) Repeat step E) for each spurious frequency with the test antenna polarized vertically.

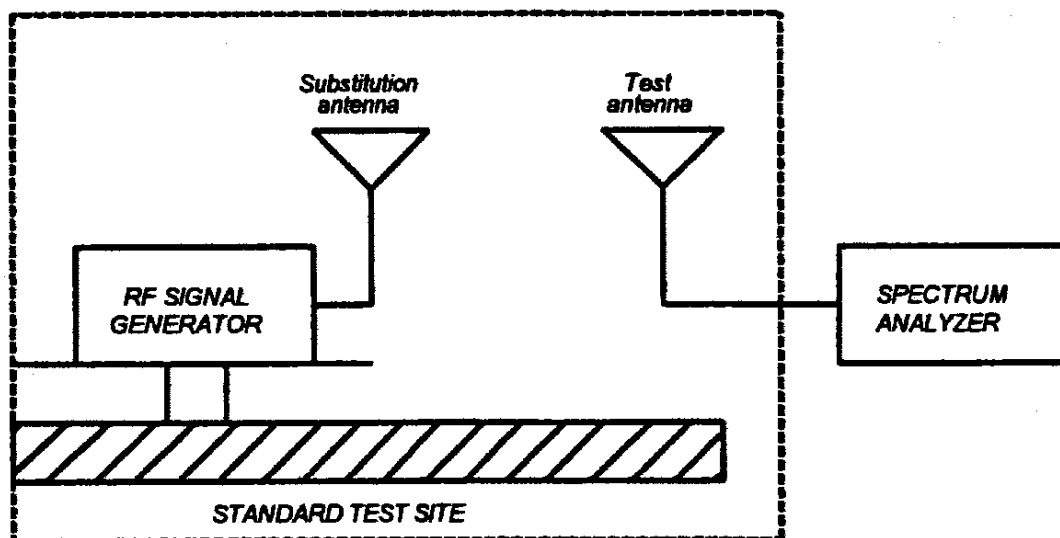

- G) Reconnect the equipment as illustrated.
- H) Keep the spectrum analyzer adjusted as in step B).
- I) Remove the transmitter and replace it with a substitution antenna (the antenna should be half-wavelength for each frequency involved). The center of the substitution antenna should be approximately at the same location as the center of the transmitter. At lower frequencies, where the substitution antenna is very long, this will be impossible to achieve when the antenna is polarized vertically. In such case the lower end of the antenna should be 0.3 m above the ground.



**Name of Test:** Field Strength of Spurious Radiation (Cont.)

- J) Feed the substitution antenna at the transmitter end with a signal generator connected to the antenna by means of a non-radiating cable. With the antennas at both ends horizontally polarized and with the signal generator tuned to a particular spurious frequency, raise and lower the test antenna to obtain a maximum reading at the spectrum analyzer. Adjust the level of the signal generator output until the previously recorded maximum reading for this set of conditions is obtained. This should be done carefully repeating the adjustment of the test antenna and generator output.
- K) Repeat step J) with both antennas vertically polarized for each spurious frequency.
- L) Calculate power in dBm into a reference ideal half-wave dipole antenna by reducing the readings obtained in steps J) and K) by the power loss in the cable between the generator and the antenna and further corrected for the gain of the substitution antenna used relative to an ideal half-wave dipole antenna.
- M) The levels recorded in step L) are absolute levels of radiated spurious emissions in dBm. The radiated spurious emissions in dB can be calculated by the following:

Radiated spurious emissions dB =

$$10 \log_{10}(\text{TX power in watts}/0.001) - \text{the levels in step I)}$$

*NOTE: It is permissible that other antennas provided can be referenced to a dipole.*

**Test Equipment**

Asset	Description	s/n	Cycle	Last Cal
<b>Transducer</b>				
	i00088	EMCO 3109-B 25MHz-300MHz	2336	24 mo. Sep-03
X	i00089	Aprel 2001 200MHz-1GHz	001500	24 mo. Sep-03
X	i00103	EMCO 3115 1GHz-18GHz	9208-3925	24 mo. Jan-04
<b>Amplifier</b>				
X	i00028	HP 8449A	2749A00121	12 mo. May-05
<b>Spectrum Analyzer</b>				
X	i00029	HP 8563E	3213A00104	12 mo. May-05
X	i00033	HP 85462A	3625A00357	12 mo. Sep-04
<b>Substitution Generator</b>				
X	i00067	HP 8920A Communication TS	3345U01242	12 mo. Jun-05
	i00207	HP 8753D Network Analyzer	3410A08514	12 mo. Jul-05

**Microphone, Antenna Port, and Cabling**

Microphone	<u>No</u>	Cable Length	<u>-</u>	Meters
Antenna Port Terminated	<u>Yes</u>	Load	<u>50 ohm</u>	Antenna Gain
All Ports Terminated by Load	<u>Yes</u>	Peripheral	<u>No</u>	<u>-</u>

Name of Test: Field Strength of Spurious Radiation

Measurement Results

g0580129: 2005-Aug-23 Tue 06:40:00

STATE: 2:High Power

Ambient Temperature: 29°C ± 3°C

Frequency Tuned, MHz	Frequency Emission, MHz	EIRP, dBm	EIRP, dBc
1623.500000	3253.000088	-49.50	-90.20
1643.500000	3287.000088	-50.60	-91.30
1660.500000	3320.835000	-47.20	-87.90
1626.500000	4879.500088	-48.90	-89.60
1643.500000	4930.500088	-52.00	-92.70
1660.500000	4981.235000	-50.10	-90.80
1626.500000	6506.000000	-61.60	-102.30
1643.500000	6574.016667	-59.90	-100.60
1660.500000	6642.016667	-61.90	-102.60
1626.500000	8132.500000	-59.70	-100.40
1643.500000	8217.516667	-57.50	-98.20
1660.500000	8302.516667	-59.20	-99.90
1626.500000	9759.000000	-54.10	-94.80
1643.500000	9861.016667	-55.80	-96.50
1660.500000	9963.016667	-53.80	-94.50
1626.500000	11385.500000	-56.80	-97.50
1643.500000	11504.516667	-55.70	-96.40
1660.500000	11623.516667	-55.00	-95.70
1626.500000	13012.000000	-55.10	-95.80
1643.500000	13148.016667	-53.90	-94.60
1660.500000	13284.016667	-52.30	-93.00
1626.500000	14638.500000	-50.40	-91.10
1643.500000	14791.516667	-51.00	-91.70
1660.500000	14944.516667	-49.40	-90.10
1626.500000	16265.000000	-51.90	-92.60
1643.500000	16435.016667	-50.60	-91.30
1660.500000	16605.016667	-51.10	-91.80



Performed by:

Fred Chastain, Test Technician

**Name of Test:** Field Strength of Spurious Radiation

**Measurement Results**

g0580150: 2005-Aug-24 Wed 09:45:00

STATE: 2:High Power

Ambient Temperature: 31°C ± 3°C

Frequency Tuned, MHz	Frequency Emission, MHz	ERP, dBm	ERP, dBc
2402.000000	4803.966666	-56.40	-77.60
2441.000000	4881.983333	-62.30	-83.50
2481.000000	4959.980000	-59.60	-80.80
2402.000000	7205.948333	-53.90	-75.10
2441.000000	7322.946666	-44.50	-65.70
2481.000000	7439.943333	-45.90	-67.10
2402.000000	9607.948333	-53.40	-74.60
2441.000000	9763.946666	-52.70	-73.90
2481.000000	9919.943333	-55.30	-76.50
2402.000000	12009.948333	-53.80	-75.00
2441.000000	12204.947999	-59.00	-80.20
2481.000000	12399.943333	-56.00	-77.20
2402.000000	14411.948333	-58.80	-80.00
2441.000000	14645.947999	-59.60	-80.80
2481.000000	14879.943333	-52.10	-73.30
2402.000000	16813.948333	-60.40	-81.60
2441.000000	17086.947999	-63.30	-84.50
2481.000000	17359.943333	-61.50	-82.70



Performed by:

Fred Chastain, Test Technician

**Name of Test:** Emission Masks (Occupied Bandwidth)

**Specification:** 47 CFR 2.1049(c)(1)

**Guide:** ANSI/TIA/EIA-603-1992, Paragraph 2.2.11

**Measurement Procedure**

- A) The EUT and test equipment were set up as shown below
- B) For EUTs supporting audio modulation, the audio signal generator was adjusted to the frequency of maximum response and with output level set for ±2.5/±1.25 kHz deviation (or 50% modulation). With level constant, the signal level was increased 16 dB.
- C) For EUTs supporting digital modulation, the digital modulation mode was operated to its maximum extent.



D) The Occupied Bandwidth was measured with the Spectrum Analyzer controls set as shown on the test results.

**Transmitter Test Set-Up: Occupied Bandwidth**

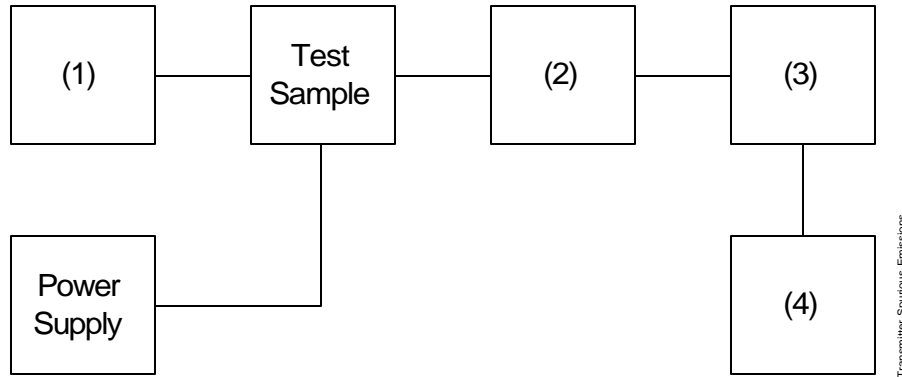

Asset	Description	s/n	Cycle	Last Cal
<b>(1) Audio Oscillator/Generator</b>				
X i00017	HP 8903A Modulation Meter	2216A01753	12 mo.	Apr-05
<b>(2) Coaxial Attenuator</b>				
X i00231/2	PASTERNAK PE7021-30 (30 dB)	231 or 232	NCR	
i00123	NARDA 766 (10 dB)	7802A	NCR	
<b>(3) Interface</b>				
X i00021	HP 8954A Transceiver Interface	2146A00159	NCR	
<b>(4) Spectrum Analyzer</b>				
X i00048	HP 8566B Spectrum Analyzer	2511A01467	12 mo.	Oct-04
i00029	HP 8563E Spectrum Analyzer	3213A00104	12 mo.	May-05

Name of Test: Emission Masks (Occupied Bandwidth)

Immarsat:

Measurement Results

g0580101: 2005-Aug-22 Mon 09:10:00  
State: 2:High Power

Ambient Temperature: 23°C ± 3°C

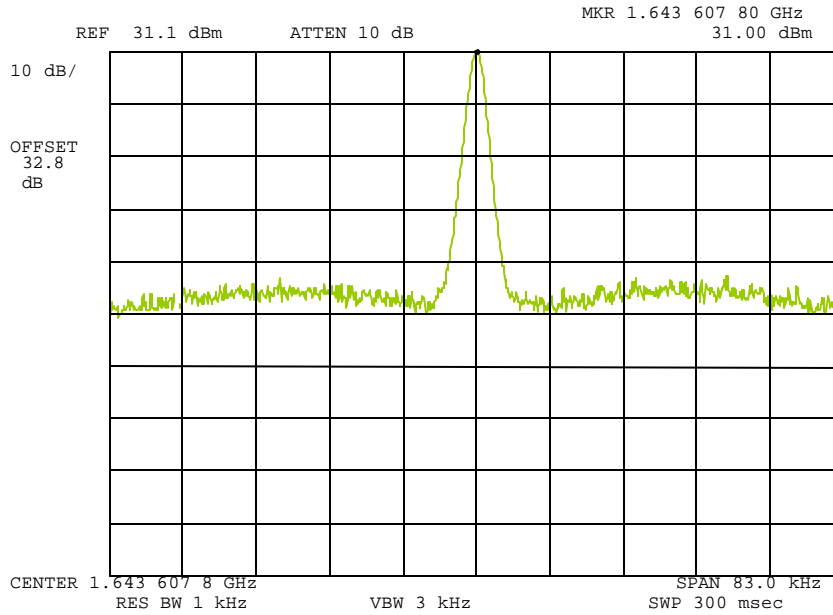

Power:  
Modulation:

HIGH  
NONE  
REFERENCE MAX POWER



Performed by:

Fred Chastain, Test Technician

Name of Test: Emission Masks (Occupied Bandwidth)

Measurement Results

g0580102: 2005-Aug-22 Mon 09:13:00

State: 2:High Power

Ambient Temperature: 23°C ± 3°C

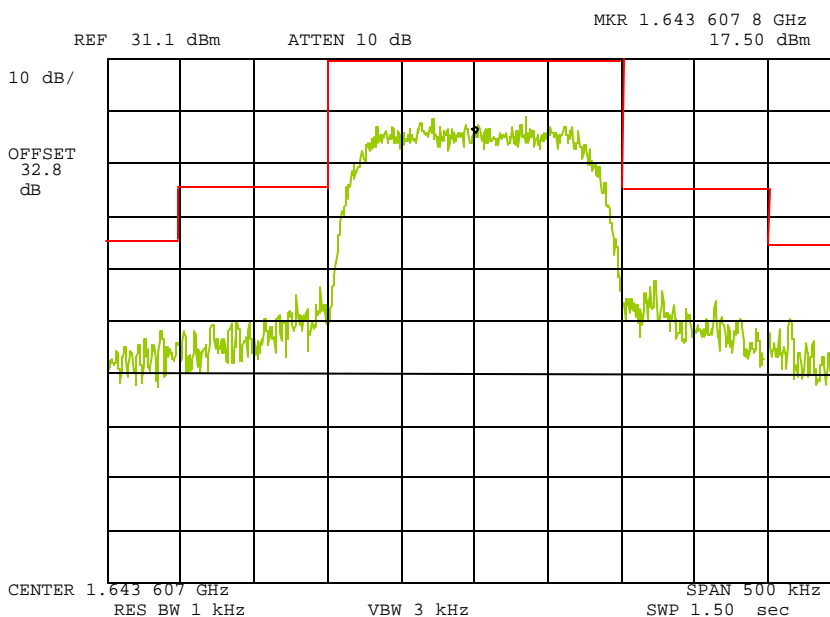

Power:

HIGH

Modulation:

16QAM, 151.2kHz Symbol Rate (20/5ms)  
200KG1D



Performed by:

Fred Chastain, Test Technician

Name of Test: Emission Masks (Occupied Bandwidth)

Measurement Results

g0580103: 2005-Aug-22 Mon 09:14:00

State: 2:High Power

Ambient Temperature: 23°C ± 3°C

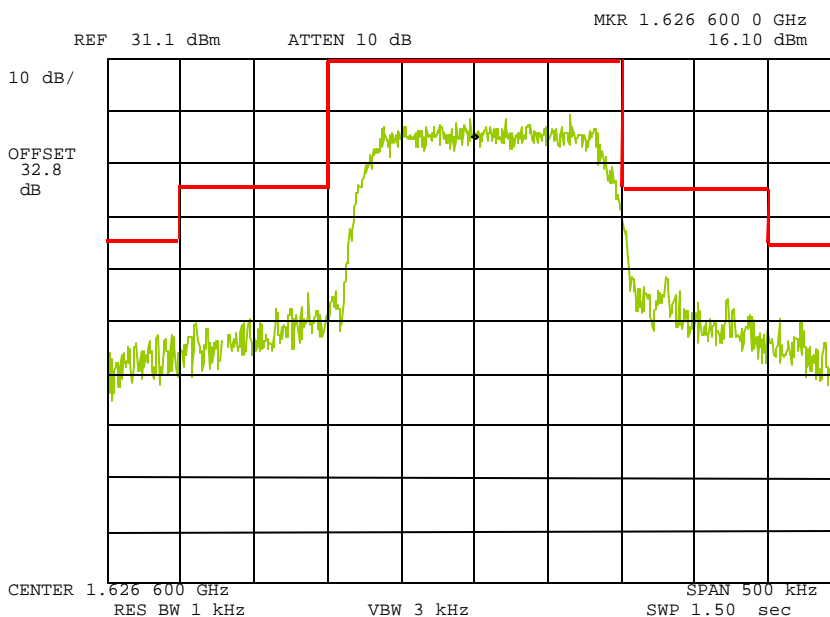

Power:  
Modulation:

HIGH  
16QAM, 151.2kHz Symbol Rate (20/5ms)  
200KG1D



Performed by:

Fred Chastain, Test Technician

Name of Test: Emission Masks (Occupied Bandwidth)

Measurement Results

g0580104: 2005-Aug-22 Mon 09:15:00

State: 2:High Power

Ambient Temperature: 23°C ± 3°C

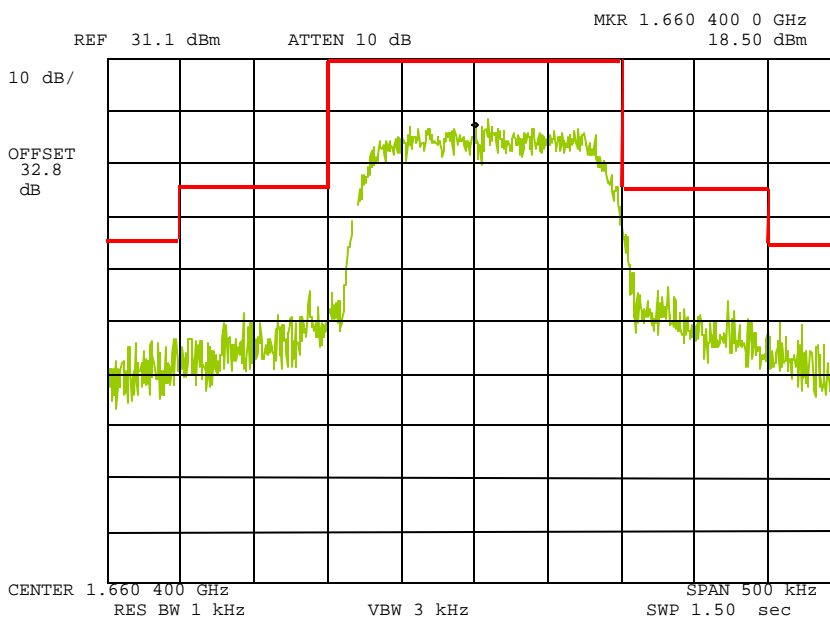

Power:  
Modulation:

HIGH  
16QAM, 151.2kHz Symbol Rate (20/5ms)  
200KG1D



Performed by:

Fred Chastain, Test Technician



Name of Test: Emission Masks (Occupied Bandwidth)

Measurement Results

g0580105: 2005-Aug-22 Mon 09:17:00  
State: 2:High Power

Ambient Temperature: 23°C ± 3°C

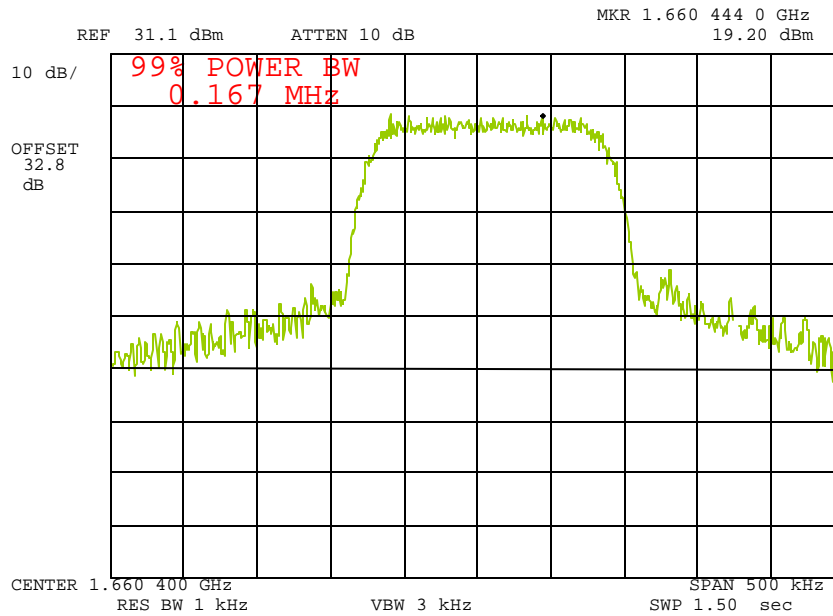

Power: HIGH  
Modulation: 16QAM, 151.2kHz Symbol Rate (20/5ms)  
99% Power Bandwidth



Performed by:

Fred Chastain, Test Technician

Name of Test: Emission Masks (Occupied Bandwidth)

Measurement Results

g0580106: 2005-Aug-22 Mon 09:22:00

State: 2:High Power

Ambient Temperature: 23°C ± 3°C

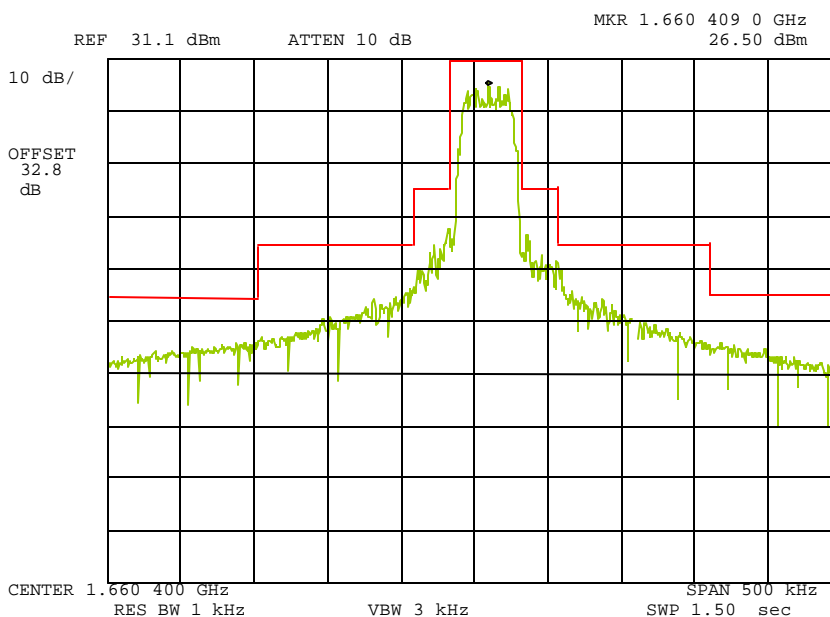

Power:  
Modulation:

HIGH  
16QAM, 33.6kHz Symbol Rate (20/5ms)  
42K0G1D



Performed by:

Fred Chastain, Test Technician



Name of Test: Emission Masks (Occupied Bandwidth)

Measurement Results

g0580108: 2005-Aug-22 Mon 09:23:00

State: 2:High Power

Ambient Temperature: 23°C ± 3°C

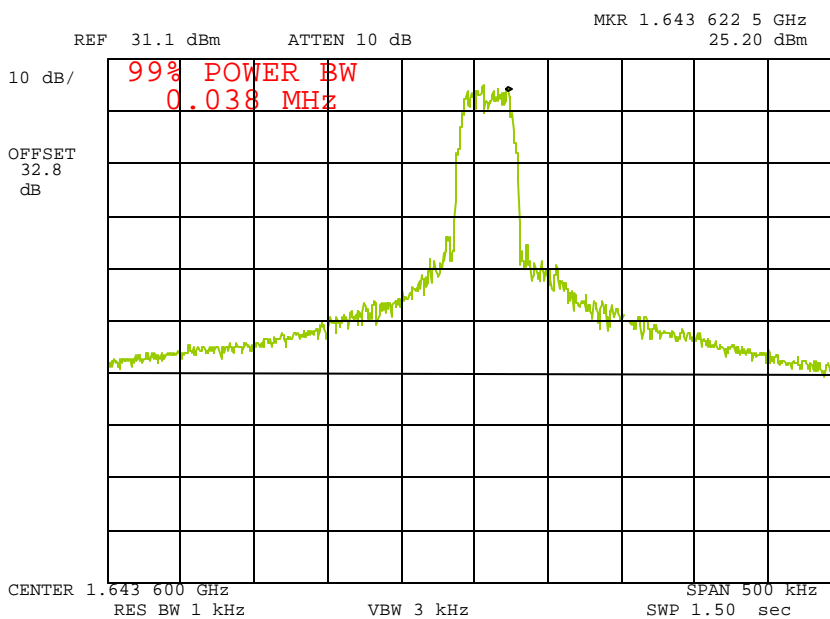

Power:  
Modulation:

HIGH  
16QAM, 33.6kHz Symbol Rate (20/5ms)  
99% Power Bandwidth



Performed by:

Fred Chastain, Test Technician

Name of Test: Emission Masks (Occupied Bandwidth)

Measurement Results

g0580109: 2005-Aug-22 Mon 09:24:00

State: 2:High Power

Ambient Temperature: 23°C ± 3°C

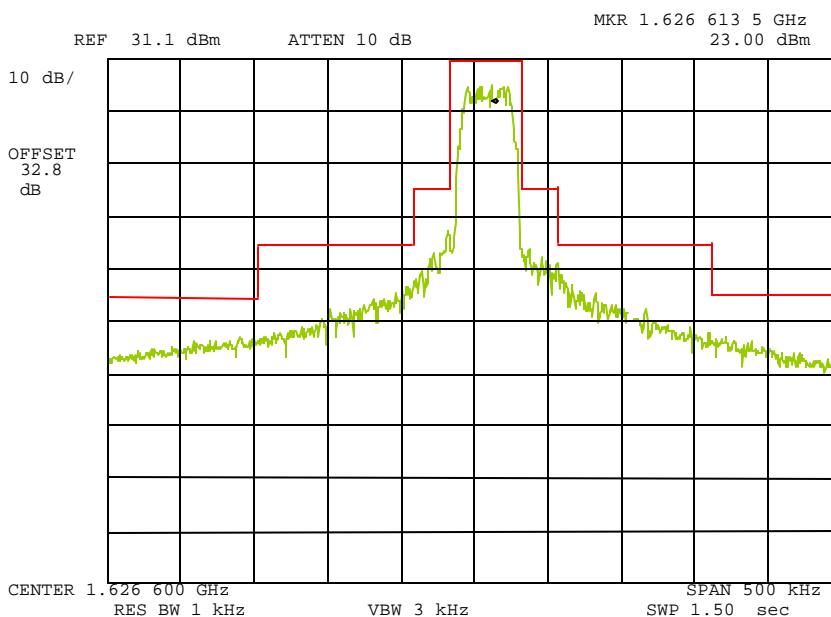

Power:  
Modulation:

HIGH  
16QAM, 33.6kHz Symbol Rate (20/5ms)  
42K0G1D



Performed by:

Fred Chastain, Test Technician

Name of Test: Emission Masks (Occupied Bandwidth)

Measurement Results

g0580112: 2005-Aug-22 Mon 09:35:00  
State: 2:High Power

Ambient Temperature: 23°C ± 3°C

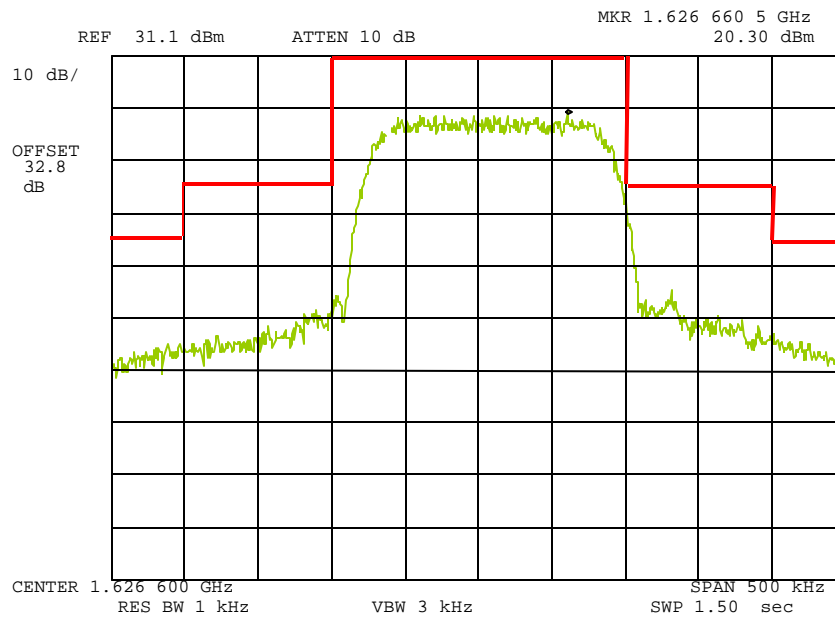

Power:  
Modulation:

HIGH  
QPSK, 151.2kHz Symbol Rate (20/5ms)  
200KD1W



Performed by:

Fred Chastain, Test Technician

Name of Test: Emission Masks (Occupied Bandwidth)

Measurement Results

g0580113: 2005-Aug-22 Mon 09:35:00

State: 2:High Power

Ambient Temperature: 23°C ± 3°C

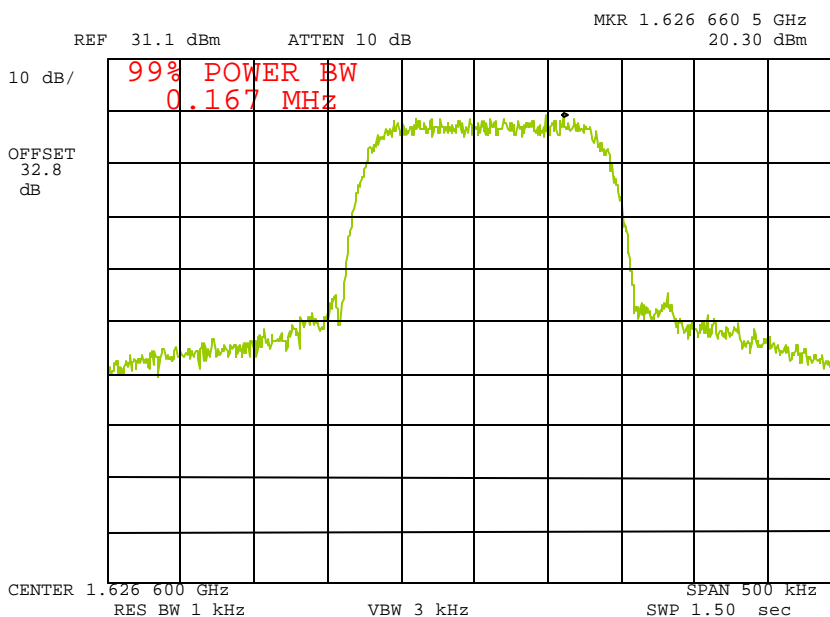

Power:  
Modulation:

HIGH  
QPSK, 151.2kHz Symbol Rate (20/5ms)  
99% Power Bandwidth



Performed by:

Fred Chastain, Test Technician

Name of Test: Emission Masks (Occupied Bandwidth)

Measurement Results

g0580114: 2005-Aug-22 Mon 09:38:00  
State: 2:High Power

Ambient Temperature: 23°C ± 3°C

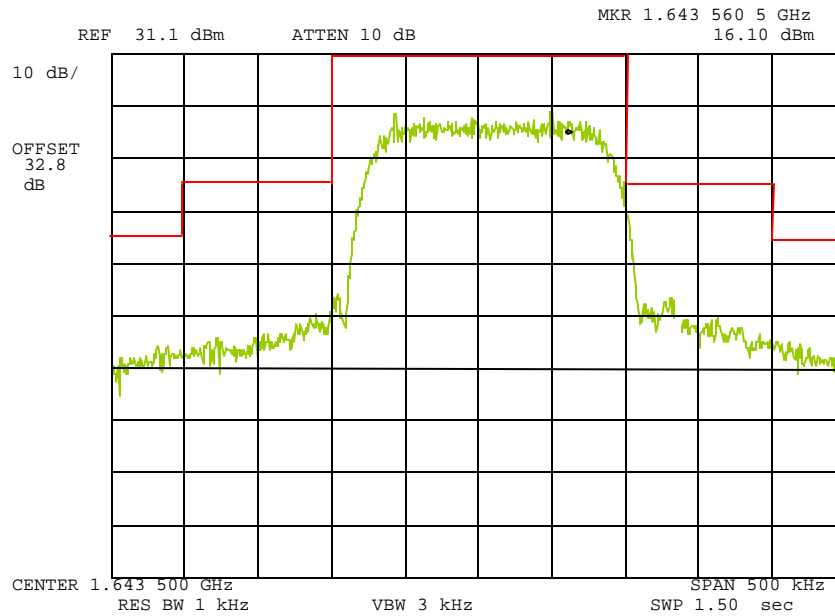

Power:  
Modulation:

HIGH  
QPSK, 151.2kHz Symbol Rate (20/5ms)  
200KD1W



Performed by:

Fred Chastain, Test Technician



Name of Test: Emission Masks (Occupied Bandwidth)

**Measurement Results**

g0580115: 2005-Aug-22 Mon 09:39:00

State: 2:High Power

Ambient Temperature: 23°C ± 3°C

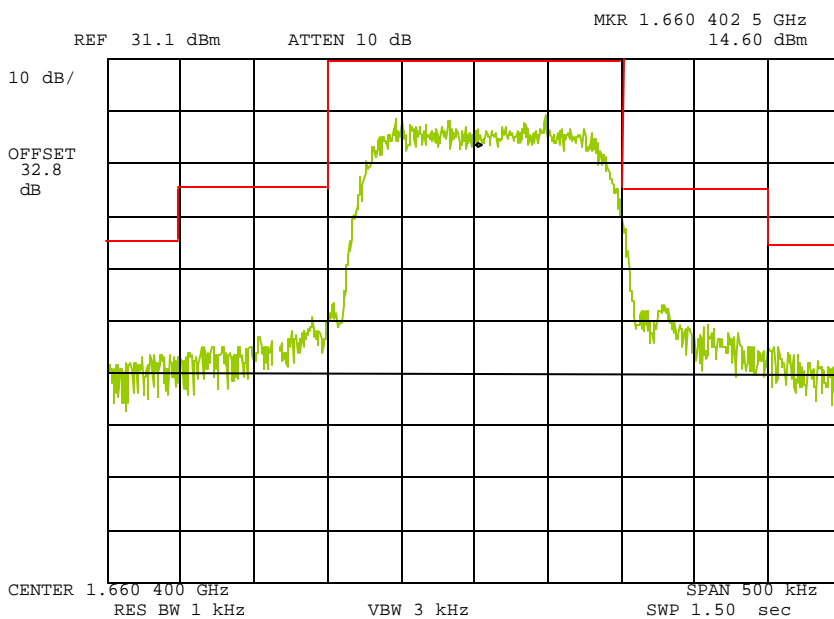

Power:  
 Modulation:

HIGH  
 QPSK, 151.2kHz Symbol Rate (20/5ms)  
 200KD1W



Performed by:

Fred Chastain, Test Technician



Name of Test: Emission Masks (Occupied Bandwidth)

Measurement Results

g0580117: 2005-Aug-22 Mon 09:44:00

State: 2:High Power

Ambient Temperature: 23°C ± 3°C

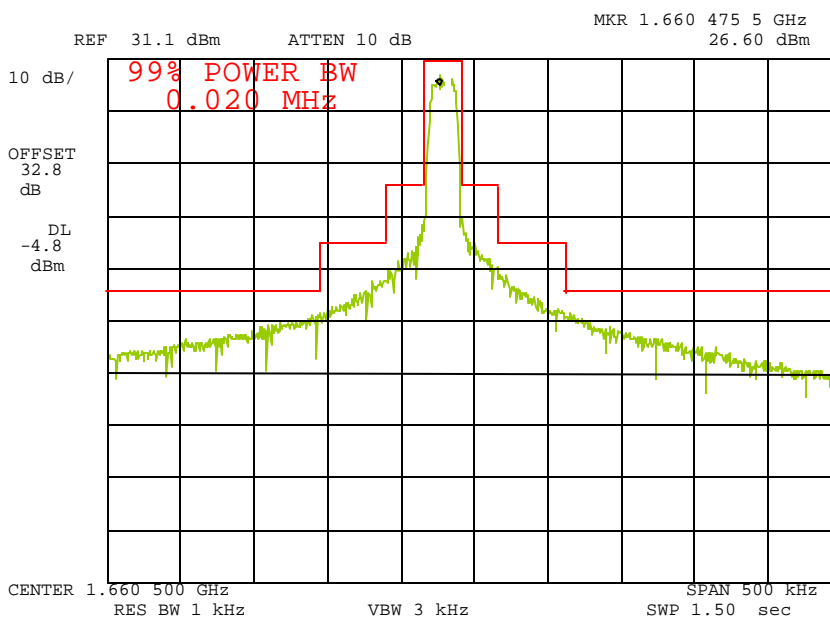

Power:  
Modulation:

HIGH  
QPSK, 16.8kHz Symbol Rate (5ms)  
99% Power Bandwidth



Performed by:

Fred Chastain, Test Technician



Name of Test: Emission Masks (Occupied Bandwidth)

Measurement Results

g0580120: 2005-Aug-22 Mon 10:02:00

State: 2:High Power

Ambient Temperature: 23°C ± 3°C

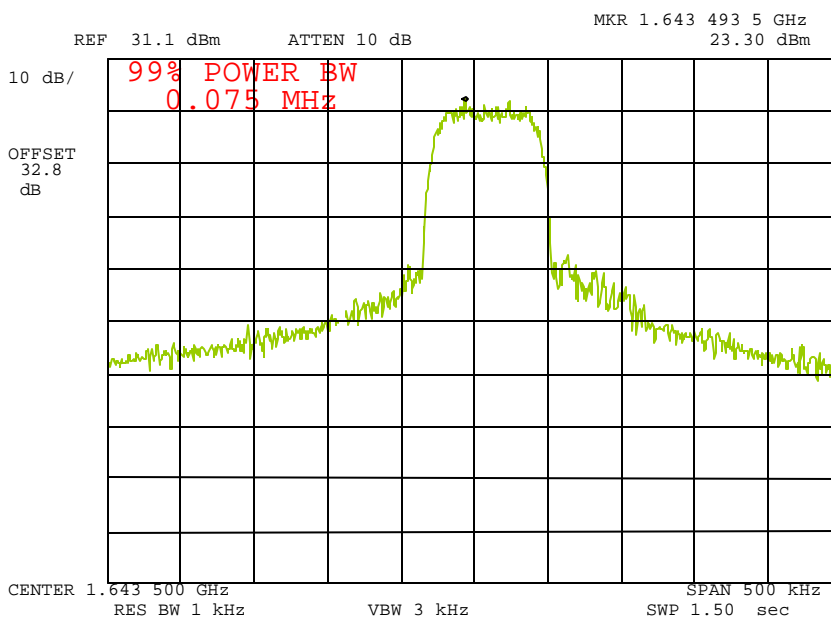

Power:

HIGH

Modulation:

16QAM, 67.2kHz Symbol Rate (20/5ms)  
84K0G1D - 99% Power Bandwidth



Performed by:

Fred Chastain, Test Technician

Name of Test: Emission Masks (Occupied Bandwidth)

Measurement Results

g0580122: 2005-Aug-22 Mon 10:06:00  
State: 2:High Power

Ambient Temperature: 23°C ± 3°C

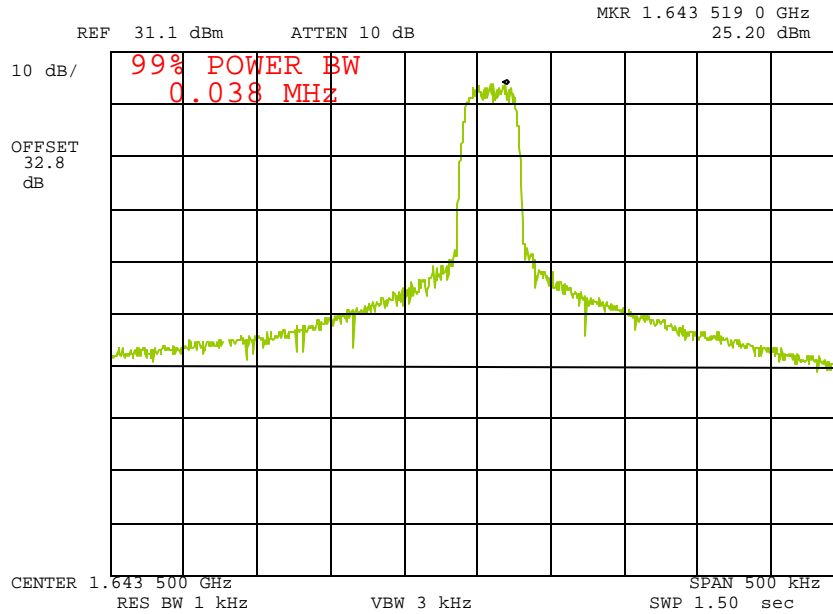

Power:  
Modulation:

HIGH  
QPSK, 33.6kHz Symbol Rate (20ms)  
42K0D1W



Performed by:

Fred Chastain, Test Technician

Name of Test: Emission Masks (Occupied Bandwidth)

Measurement Results

g0580123: 2005-Aug-22 Mon 10:07:00  
State: 2:High Power

Ambient Temperature: 23°C ± 3°C

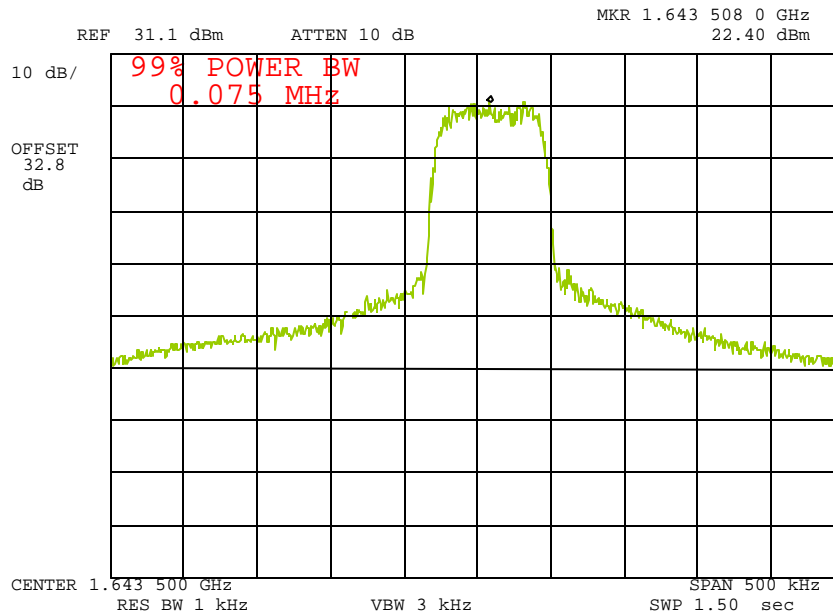

Power:  
Modulation:

HIGH  
QPSK, 67kHz Symbol Rate (20/5ms)  
84K0D1W - 99% Power Bandwidth



Performed by:

Fred Chastain, Test Technician

Name of Test: Emission Masks (Occupied Bandwidth)

Measurement Results

g0580110: 2005-Aug-22 Mon 09:28:00  
State: 2:High Power

Ambient Temperature: 23°C ± 3°C

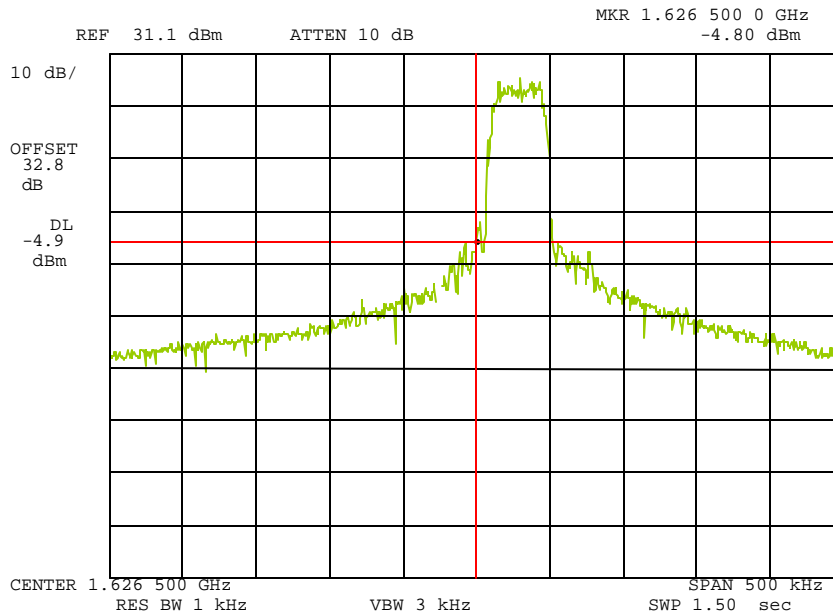

Power:  
Modulation:

HIGH  
16QAM, 33.6kHz Symbol Rate (20/5ms)  
42K0G1D - Lower Band Edge



Performed by:

Fred Chastain, Test Technician





**Name of Test:** Frequency Stability (Temperature Variation)

**Specification:** 47 CFR 2.1055(a)(1)

**Guide:** ANSI/TIA/EIA-603-1992, Paragraph 2.2.2

**Measurement Procedure**

- A) The EUT and test equipment were set up as shown on the following page.
- B) With all power removed, the temperature was decreased to -30°C and permitted to stabilize for three hours. Power was applied and the maximum change in frequency was noted within one minute.
- C) With power OFF, the temperature was raised in 10°C steps. The sample was permitted to stabilize at each step for at least one-half hour. Power was applied and the maximum frequency change was noted within one minute.
- D) The temperature tests were performed for the worst case.

**Transmitter Test Set-Up: Temperature Variation**

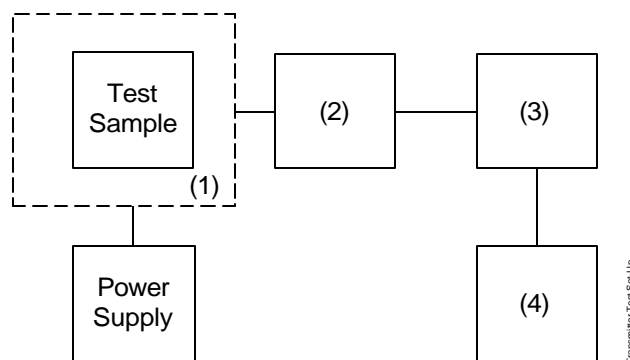

Asset	Description	s/n	Cycle	Last Cal
<b>(1) Temperature, Humidity, Vibration</b>				
X i00027	Tenney Temp. Chamber	9083-765-234	NCR	
<b>(2) Coaxial Attenuator</b>				
X i00231/2	PASTERNAK PE7021-30 (30 dB)	231 or 232	NCR	
i00122/3	NARDA 766 (10 dB)	7802 or 7802A	NCR	
<b>(3) RF Power</b>				
X i00067	HP 8920A Communications TS	3345U01242	12 mo.	Jun-05
<b>(4) Frequency Counter</b>				
X i00067	HP 8920A Communications TS	3345U01242	12 mo.	Jun-05

Name of Test: Frequency Stability (Temperature Variation)

Measurement Results

State: Ambient Temperature: 23°C ± 3°C

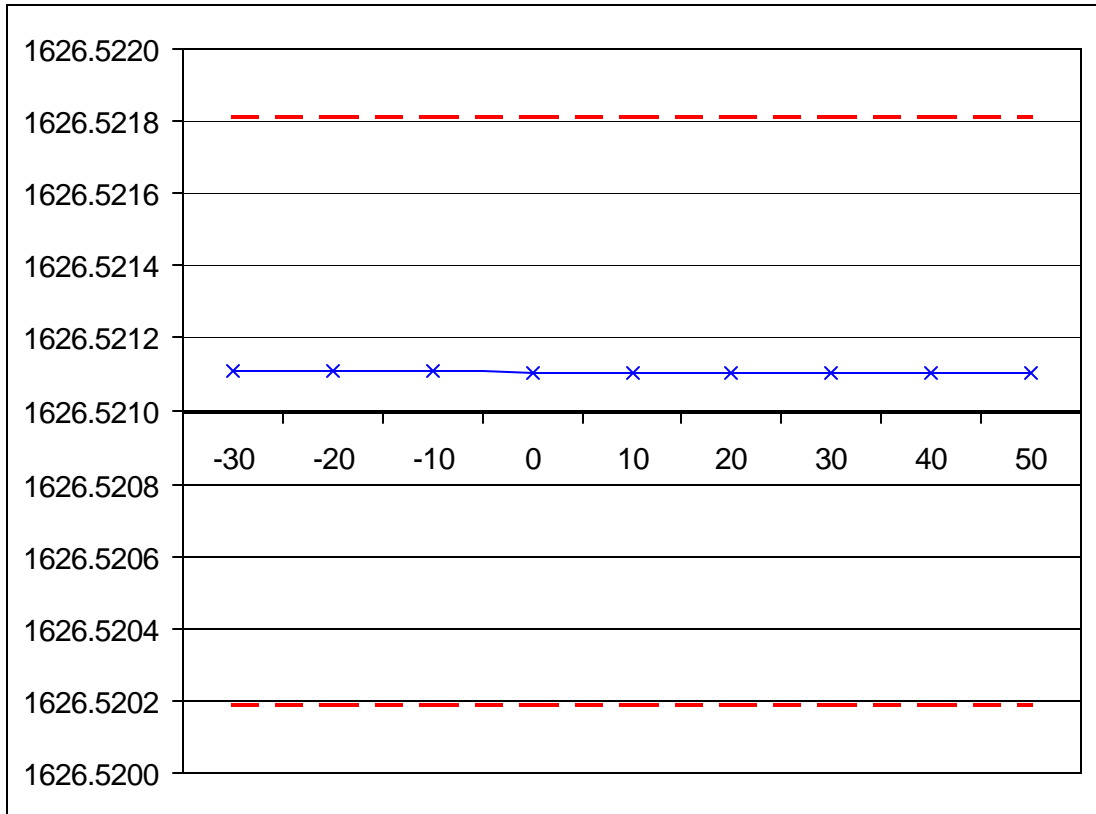

Plot based on data obtained during Immarsat Compliance Testing with device locked to Satellite.

Limits shown are 0.5ppm



Performed by:

Fred Chastain, Test Technician

**Name of Test:** Frequency Stability (Voltage Variation)  
**Specification:** 47 CFR 2.1055(d)(1)  
**Guide:** ANSI/TIA/EIA-603-1992, Paragraph 2.2.2

**Measurement Procedure**

- A) The EUT was placed in a temperature chamber (if required) at 25±5°C and connected as shown below.
- B) The power supply voltage to the EUT was varied from 85% to 115% of the nominal value measured at the input to the EUT.
- C) The variation in frequency was measured for the worst case.

**Transmitter Test Set-Up: Voltage Variation**

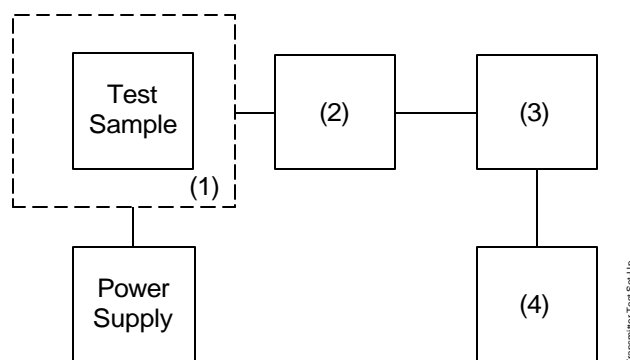

Asset	Description	s/n	Cycle	Last Cal
<b>(1) Temperature, Humidity, Vibration</b>				
i00027	Tenney Temp. Chamber	9083-765-234	NCR	
<b>(2) Coaxial Attenuator</b>				
X i00231/2	PASTERNAK PE7021-30 (30 dB)	231 or 232	NCR	
i00122/3	NARDA 766 (10 dB)	7802 or 7802A	NCR	
<b>(3) RF Power</b>				
X i00020	HP 8901A Power Mode	2105A01087	12 mo.	Apr-05
<b>(4) Frequency Counter</b>				
X i00020	HP 8901A Frequency Mode	2105A01087	12 mo.	Apr-05

**Results:** Frequency Stability (Voltage Variation)

State: Ambient Temperature: 23°C ± 3°C

Limit, ppm = ± 0.5  
 Limit, Hz = ± 814  
 Battery End Point (Voltage) = 10.0

% of STV	Voltage	Frequency, MHz	Change, Hz	Change, ppm
115	15.87	1643.607640	+40	
100	13.20	1643.607640	+40	>0.05
85	11.73	1643.607635	+35	
BEP	10.0	1643.607630	+30	



Performed by: Fred Chastain, Test Technician

**Name of Test:** Limits on emissions from mobile earth stations for protection of aeronautical radio navigation satellite service

**Specification:** 47 CFR 25.216

### Measurement Procedure

- A) The EUT and test equipment were set up as shown on the following page.
- B) With all power removed, the temperature was decreased to -30°C and permitted to stabilize for three hours. Power was applied and the maximum change in frequency was noted within one minute.
- C) With power OFF, the temperature was raised in 10°C steps. The sample was permitted to stabilize at each step for at least one-half hour. Power was applied and the maximum frequency change was noted within one minute.
- D) The temperature tests were performed for the worst case.

### Transmitter Test Set-Up: Temperature Variation

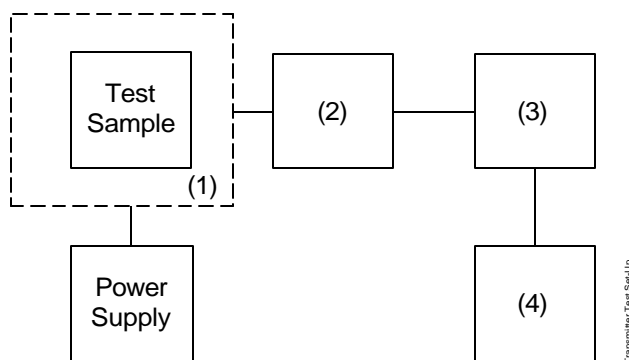

Asset	Description	s/n	Cycle	Last Cal
<b>(1) Temperature, Humidity, Vibration</b>				
X	i00027 Tenney Temp. Chamber	9083-765-234	NCR	
<b>(2) Coaxial Attenuator</b>				
X	i00231/2 PASTERNAK PE7021-30 (30 dB)	231 or 232	NCR	
	i00122/3 NARDA 766 (10 dB)	7802 or 7802A	NCR	
<b>(3) RF Power</b>				
X	i00067 HP 8920A Communications TS	3345U01242	12 mo.	Jun-05
<b>(4) Frequency Counter</b>				
X	i00067 HP 8920A Communications TS	3345U01242	12 mo.	Jun-05



**Name of Test:** Special requirements for ancillary terrestrial components operating in the 1626.5-1660.5 MHz / 1525-1559 MHz bands

**Specification:** 47 CFR 25.253(d)(6), (d)(7), (g)(3)

#### Measurement Procedure

*(d)(6) Exceed a peak antenna gain of 16 dBi;*

The EUT has a peak antenna gain of 11.1dBi

*(d)(7) Exceed an EIRP in the 1559-1605 MHz band of -70 dBW/MHz for wideband emissions and -80 dBW for narrowband emissions (discrete emissions of less than 700 Hz bandwidth). The ATC station shall not exceed an EIRP in the 1605-1610 MHz frequency range that is determined by the linear interpolation from -70 dBW/MHz at 1605 MHz to -10 dBW/MHz at 1610 MHz for wideband emissions. The wideband EIRP level is to be measured using a root mean square (RMS) detector function with a resolution bandwidth of 1 MHz or equivalent and the video bandwidth is not less than the resolution bandwidth. The narrowband EIRP level is to be measured using an RMS detector function with a resolution bandwidth of 1 kHz or equivalent. The measurements are to be made over a 20 millisecond averaging period when the base station is transmitting.*

And

*(g)(3) . . . exceed an EIRP in the 1559-1605 MHz band of -70 dBW/MHz for wideband emissions and -80 dBW for narrowband emissions (discrete emissions of less than 700 Hz bandwidth). The ATC station shall not exceed an EIRP in the 1605-1610 MHz frequency range that is determined by the linear interpolation from -70 dBW/MHz at 1605 MHz to -10 dBW/MHz at 1610 MHz for wideband emissions. The wideband EIRP level is to be measured using a root mean square (RMS) detector function with a resolution bandwidth of 1 MHz or equivalent and the video bandwidth is not less than the resolution bandwidth. The narrowband EIRP level is to be measured using an RMS detector function with a resolution bandwidth of 1 kHz or equivalent. The measurements are to be made over a 20 millisecond averaging period when the mobile terminal is transmitting.*

The plots extracted from the Immarsat compliance data filed by the applicant, which show compliance with the corresponding paragraphs of 47CFR25.253 are attached



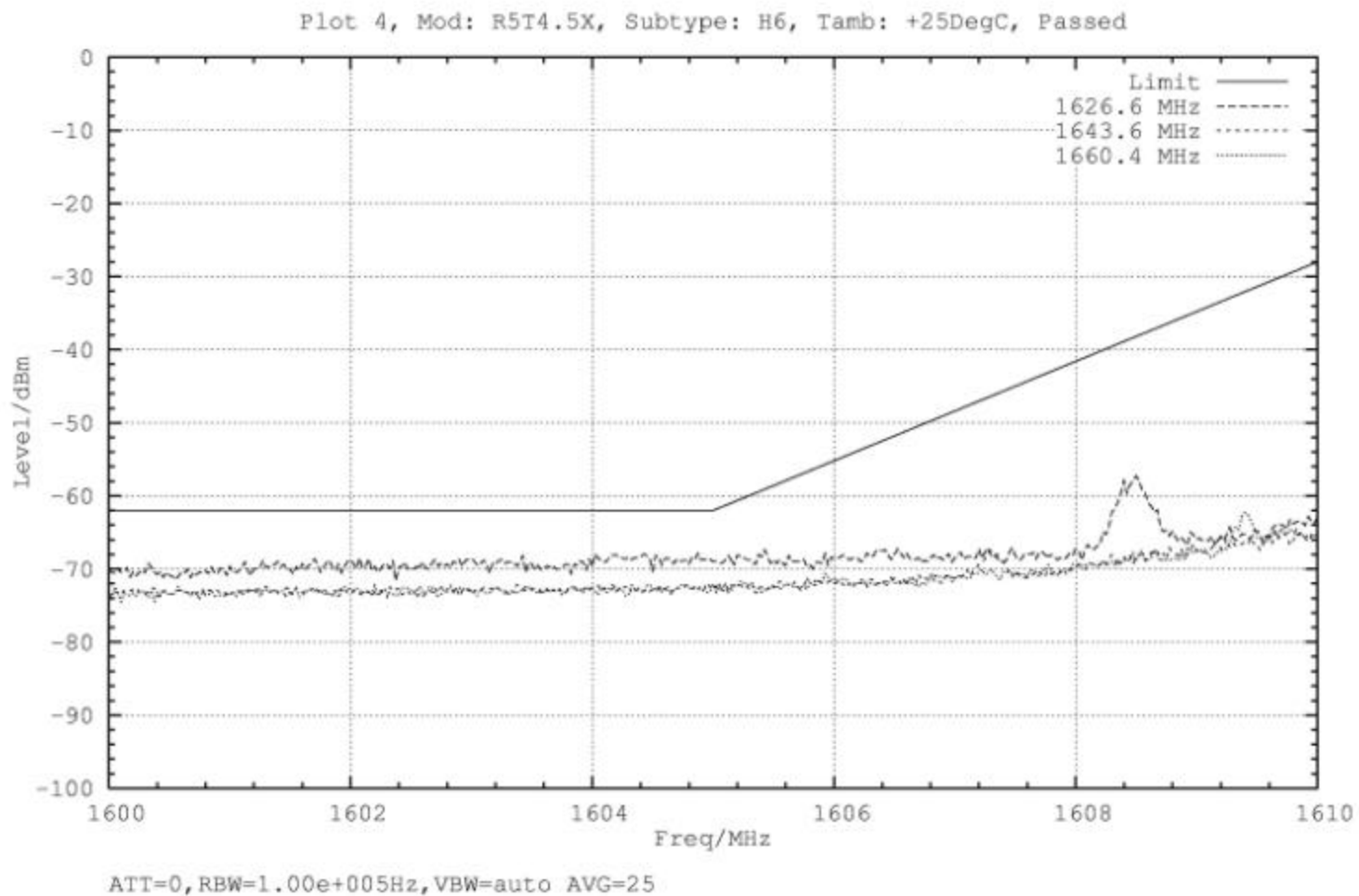

Plot 6, Mod: R5T4.5X, Subtype: H6, Tamb: +25DegC, Passed

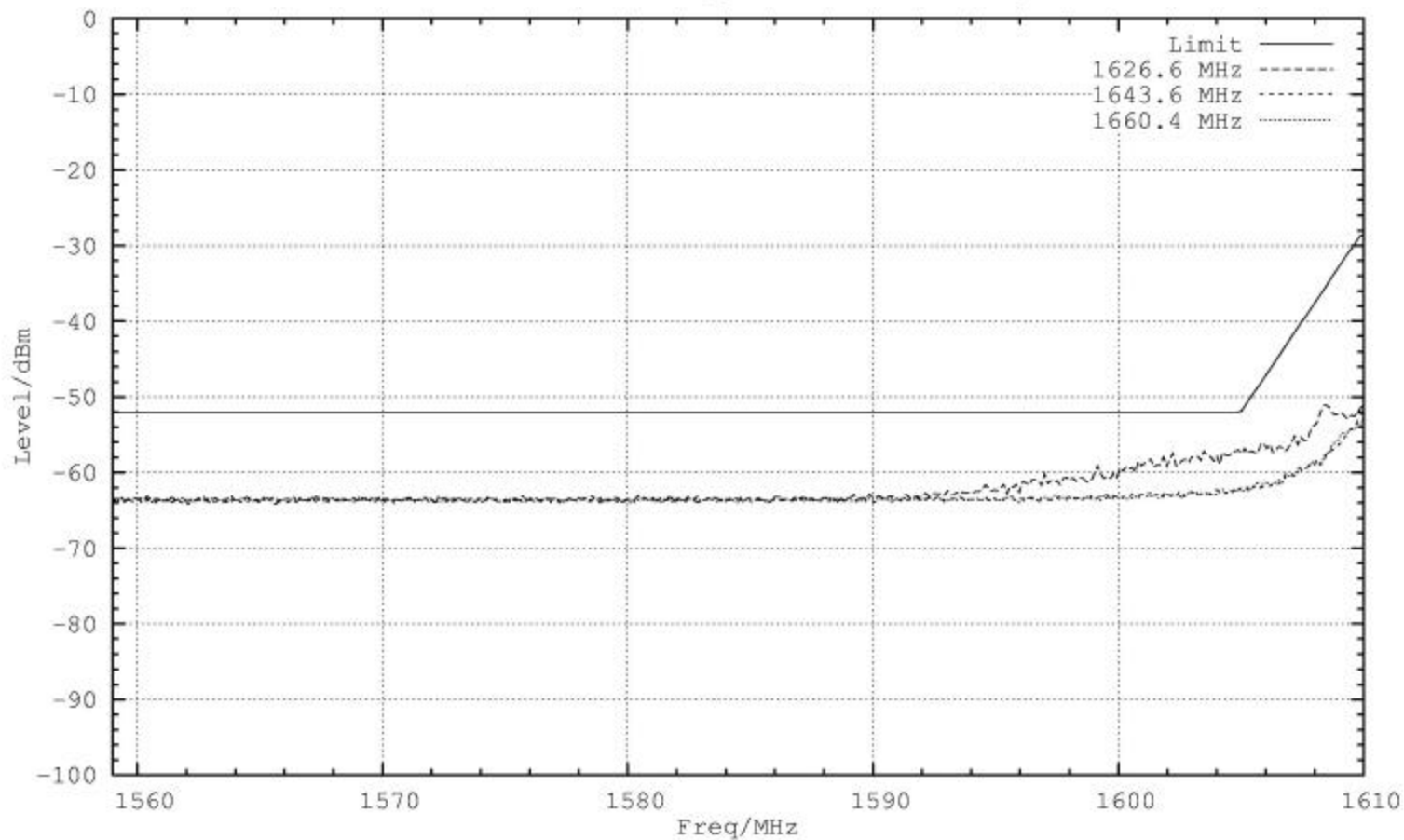

ATT=0, RBW=1.00e+006Hz, VBW=auto AVG=25

**Name of Test:** Necessary Bandwidth and Emission Bandwidth

**Specification:** 47 CFR 2.202(g)

Modulation = 21K0D1W

**Necessary Bandwidth Calculation:**

Maximum Modulation (M), kHz	=	3.1
Maximum Deviation (D), kHz	=	7.4
Constant Factor (K)	=	1
Necessary Bandwidth (B <sub>N</sub> ), kHz	=	(2xM)+(2xDxK)
		(2x3.1)+(2x7.4x1)
		6.2+14.8
	=	21.0

Modulation = 42K0G1D / D1W

**Necessary Bandwidth Calculation:**

Maximum Modulation (M), kHz	=	14.1
Maximum Deviation (D), kHz	=	7.4
Constant Factor (K)	=	1
Necessary Bandwidth (B <sub>N</sub> ), kHz	=	(2xM)+(2xDxK)
		(2x13.1)+(2x7.4x1)
		28.2+14.8
	=	42.0

Modulation = 84K0G1D / D1W

**Necessary Bandwidth Calculation:**

Maximum Modulation (M), kHz	=	29.6
Maximum Deviation (D), kHz	=	7.4
Constant Factor (K)	=	1
Necessary Bandwidth (B <sub>N</sub> ), kHz	=	(2xM)+(2xDxK)
		(2x13.1)+(2x7.4x1)
		59.2+14.8
	=	84.0

Modulation = 200KG1D / D1W

**Necessary Bandwidth Calculation:**

Maximum Modulation (M), kHz	=	92.6
Maximum Deviation (D), kHz	=	7.4
Constant Factor (K)	=	1
Necessary Bandwidth (B <sub>N</sub> ), kHz	=	(2xM)+(2xDxK)
		(2x13.1)+(2x7.4x1)
		185.2+14.8
	=	200.0



Calculated by:

David E. Lee, Quality Assurance Manager

**Name of Test:** Restricted Bands of Operation

**Specification:** 47 CFR 15.205

#### Measurement Procedure

The EUT was set up on a three-meter open field site according to the procedure on ANSI C63.4.

Sensitivity of system was measured:

Below 2 GHz:

CISPR Bandwidths	=	8 dB $\mu$ V
1 MHz RBW, 1 MHz VBW	=	12 dB $\mu$ V
1 MHz RBW, 10 Hz VBW	=	3 dB $\mu$ V

Above 2 GHz:

1 MHz RBW, 1 MHz VBW	=	33 dB $\mu$ V
1 MHz RBW, 10 Hz VBW	=	22 dB $\mu$ V

Sensitivity of system with preamps:

Below 2 GHz:

Preamps are not used in this range.

Above 2 GHz:

Peak	=	3 dB $\mu$ V
Average	=	-8 dB $\mu$ V

Cable Loss:

915 MHz	=	-0.8 dB $\mu$ V
2450 MHz	=	-3 dB $\mu$ V

Note:

dB loss vs. frequency included in programmed software.

Reference Level Offset:

set @ 1 dB, accounts for cable and connector loss.

**Test Results:** No harmonic or spurious emissions were detected in the restricted bands in excess of the limits of 15.205. System measurement sensitivity was -130 dBm.



Supervised By:

David E. Lee, Quality Assurance Manager

§ 15.205 Restricted Bands of Operation

(a) Except as shown in paragraph (b) of this section, only spurious emissions are permitted in any of the frequency bands listed below:

MHz	MHz	MHz	GHz
0.090-0.110	16.42-16.423	399.9-410	4.5-5.25
0.495-0.505	16.69475-16.69625	608-614	5.35-5.46
2.1735-2.1905	16.80425-16.80475	960-1240	7.25-7.75
4.125-4.128	25.5-25.67	1300-1427	8.025-8.5
4.17725-4.17775	37.5-38.25	1435-1626.5	9.0-9.2
4.20725-4.20775	73-74.6	1645.5-1646.5	9.3-9.5
6.215-6.218	74.8-75.2	1660-1710	10.6-12.7
6.26775-6.26825	108-121.94	1718.8-1722.2	13.25-13.4
6.31175-6.31225	123-138	2200-2300	14.47-14.5
8.291-8.294	149.9-150.05	2310-2390	15.35-16.2
8.362-8.366	156.52475-156.52525	2483.5-2500	17.7-21.4
8.37625-8.38675	156.7-156.9	2655-2900	22.01-23.12
8.41425-8.41475	162.0125-167.17	3260-3267	23.6-24.0
12.29-12.293	167.72-173.2	3332-3339	31.2-31.8
12.51975-12.52025	240-285	3345.8-3358	36.43-36.5
12.57675-12.57725	322-339.4	3600-4400	
13.36-13.41			

END OF TEST REPORT

**Testimonial  
and  
Statement of Certification**

**This is to Certify:**

1. **That** the application was prepared either by, or under the direct supervision of, the undersigned.
2. **That** the technical data supplied with the application was taken under my direction and supervision.
3. **That** the data was obtained on representative units, randomly selected.
4. **That**, to the best of my knowledge and belief, the facts set forth in the application and accompanying technical data are true and correct.



Certifying Engineer:

David E. Lee, Quality Assurance Manager