



**CETECOM™**

Test report no.: 1-8390/14-01-08\_AnnexB

# Annex B

**CETECOM™**

**CETECOM ICT Services**  
*consulting - testing - certification >>>*

This test report annex is electronically signed and valid without handwriting signature. For verification of the electronic signatures, the public keys can be requested at the testing laboratory.

**Test report annex authorised:**

Karsten Gerald  
Professional  
Radio Communications & EMC

**Internal photos of the EUT (as provided by the manufacturer)**

Photo 1:

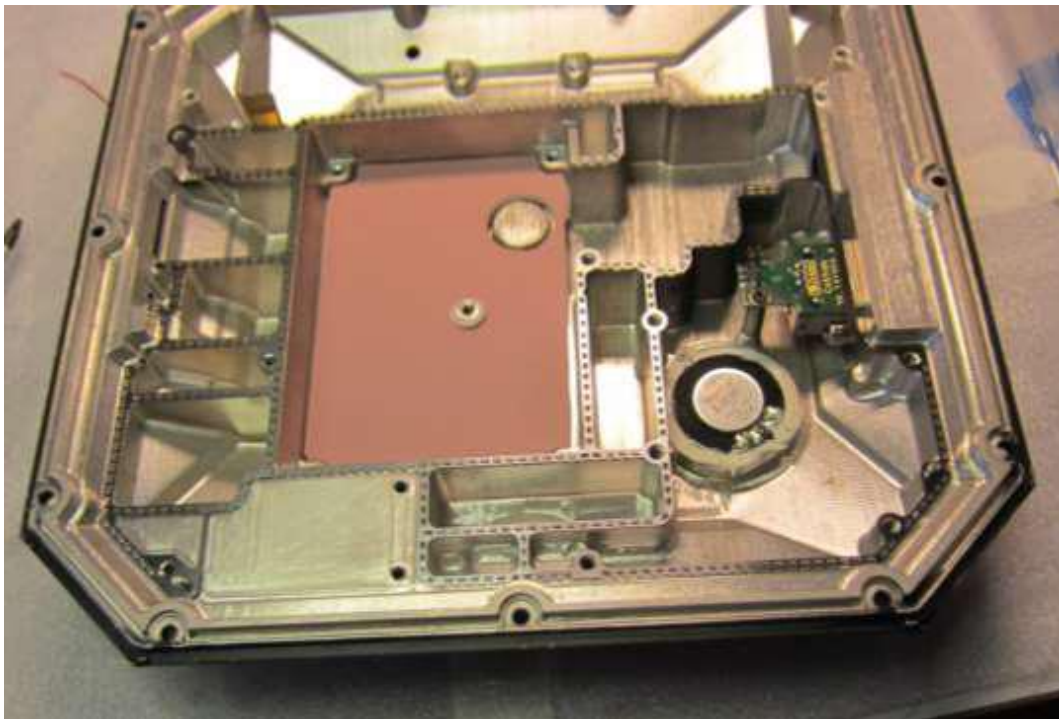

Photo 2:

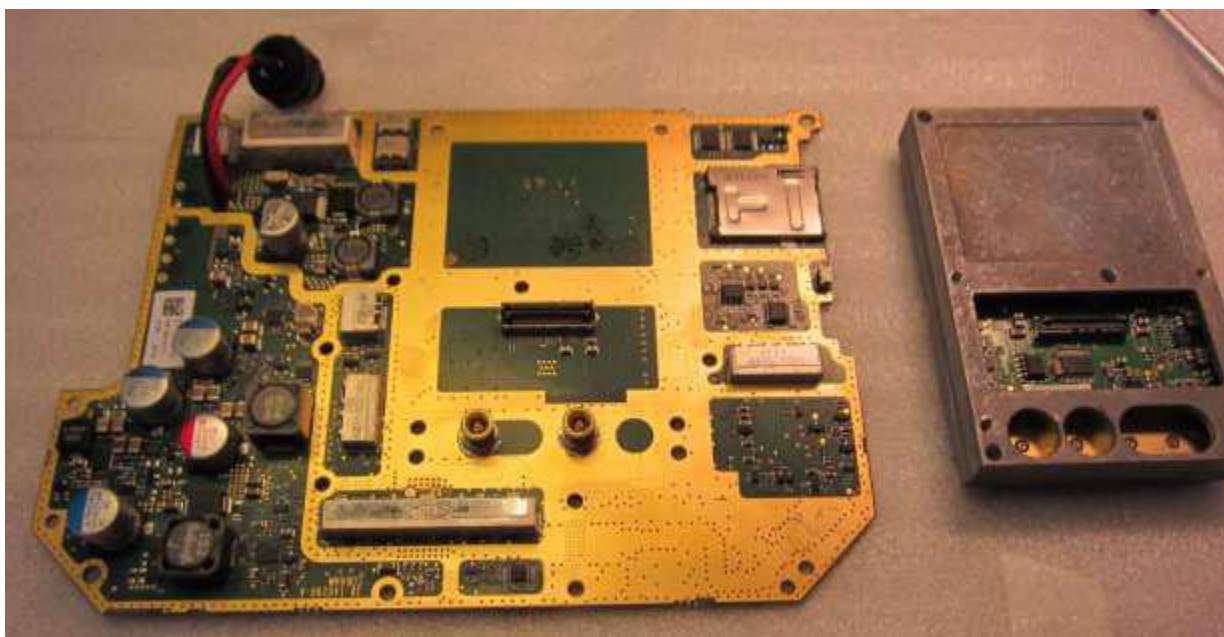

Photo 3:



Photo 4:





Photo 5:

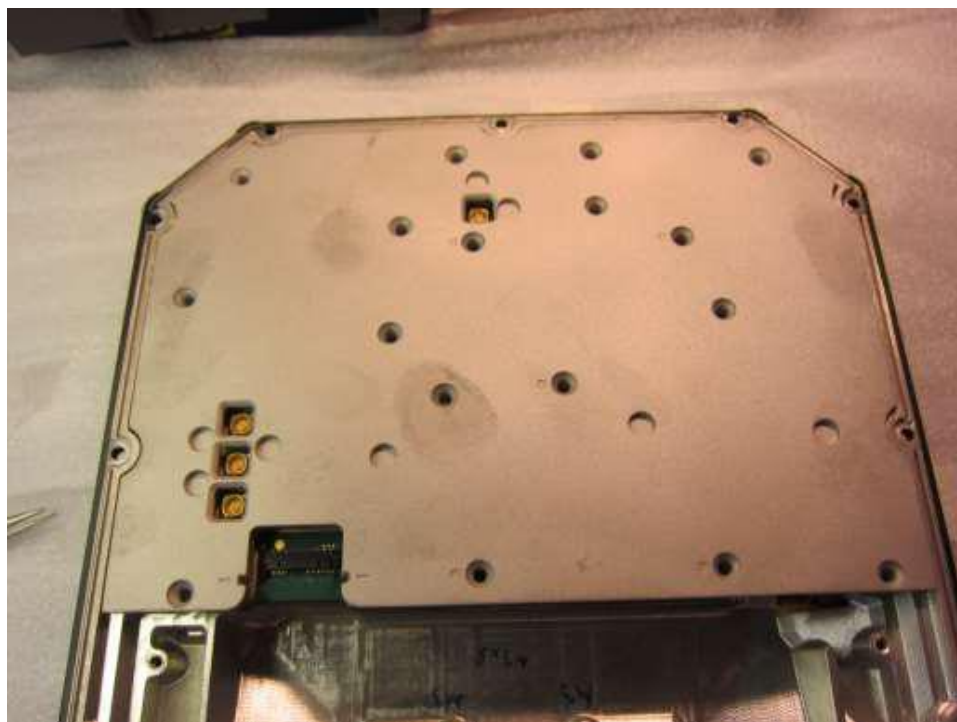

Photo 6:

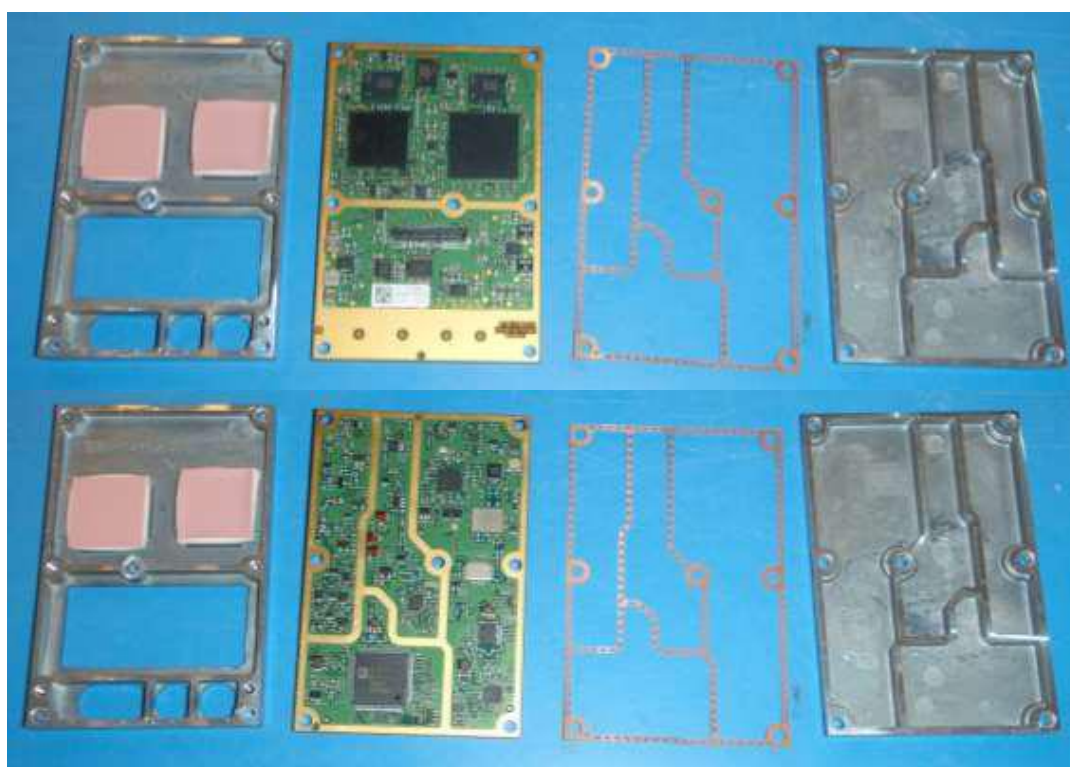

Photo 7:

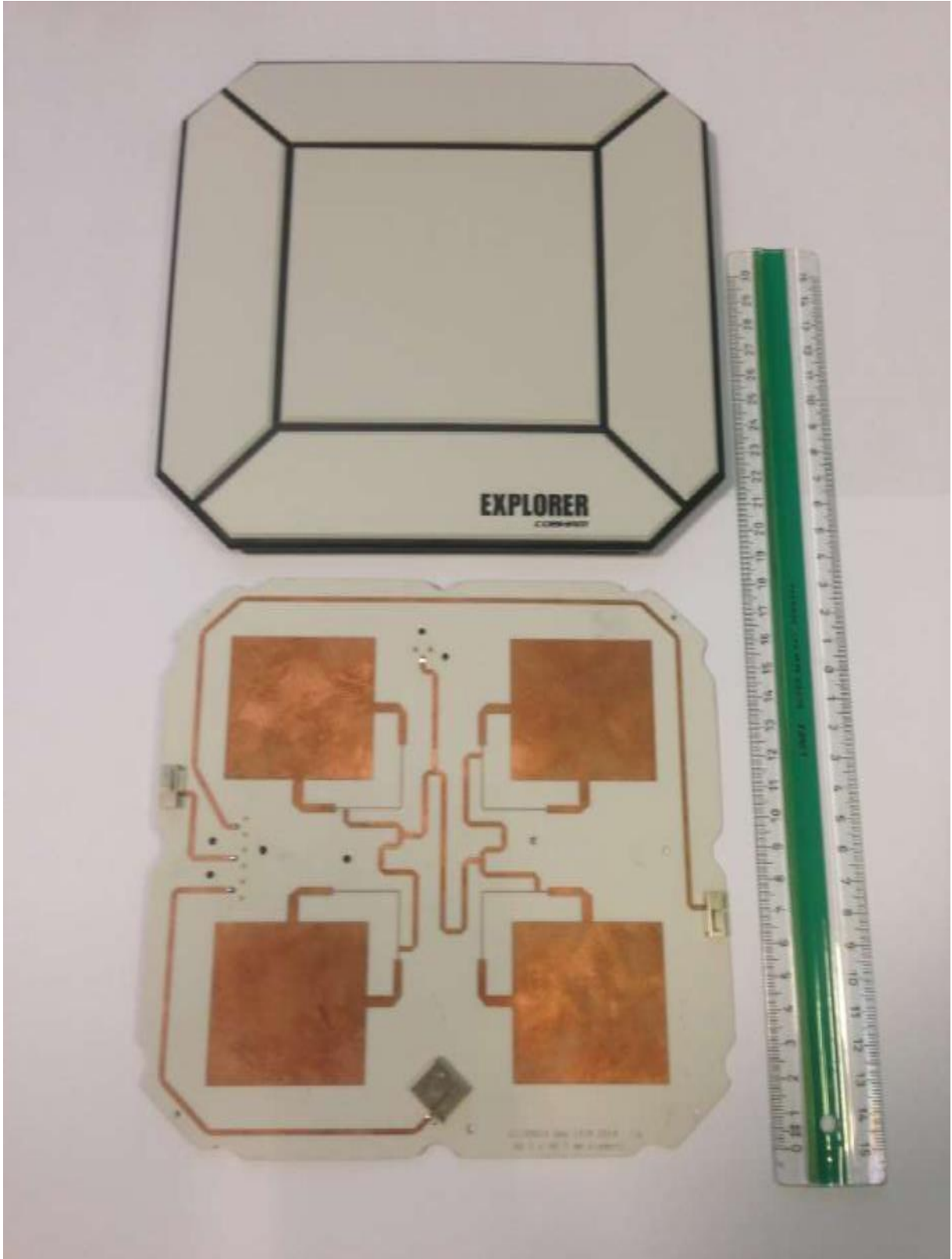

Photo 8:

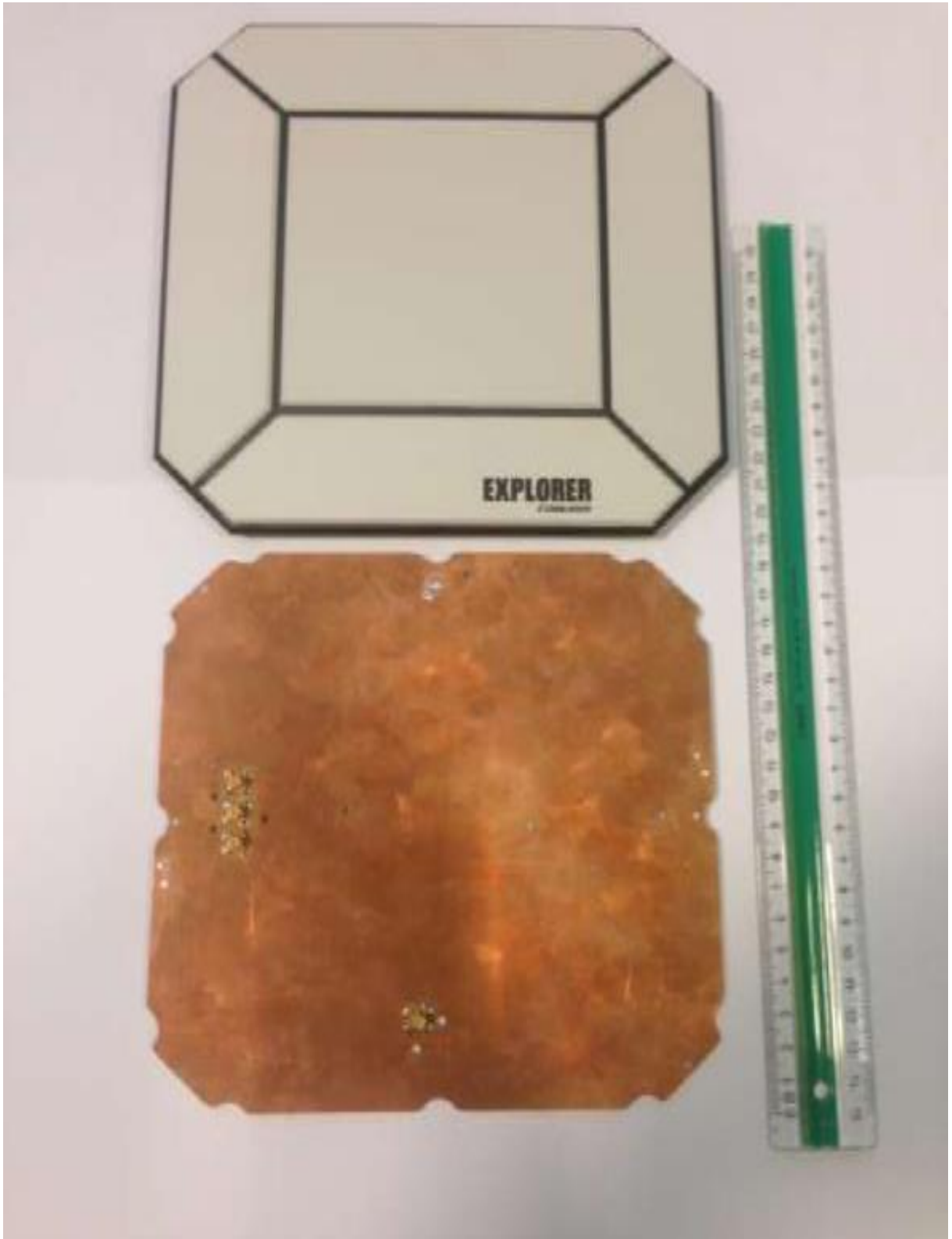
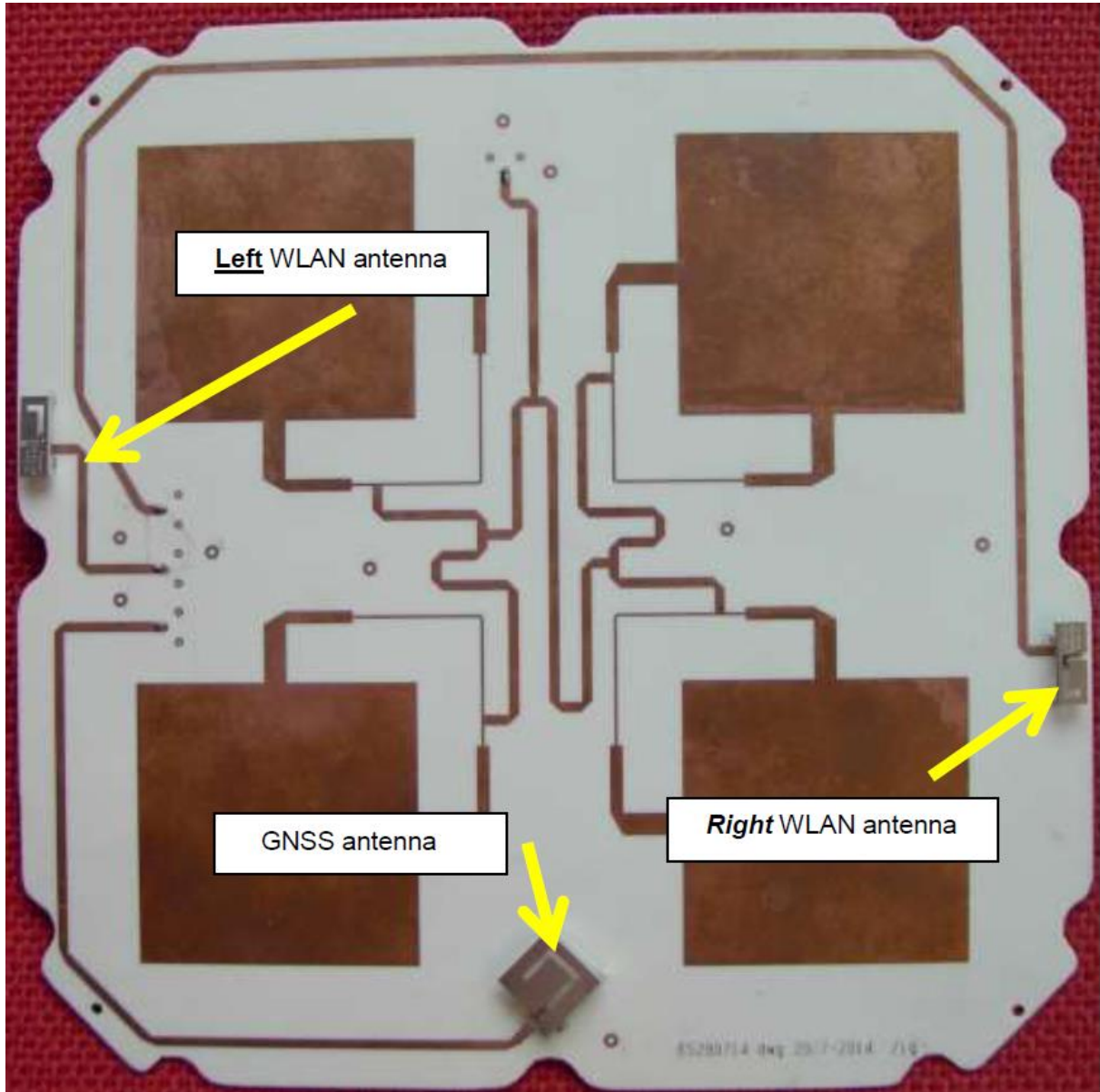

Photo 9:



## Document history

Version	Applied changes	Date of release
	Initial release	2014-11-13