

Application note and implementation guideline

OnBoard™ SMD – 2400 antenna

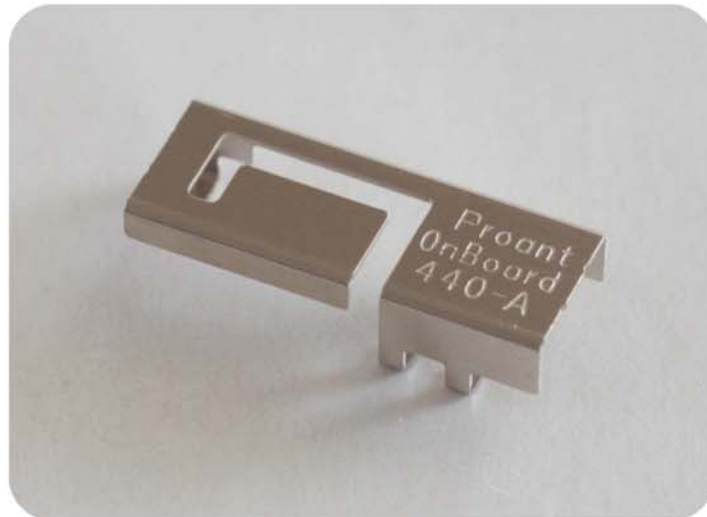

Patent: SE537042 + Pending

Table of contents

1. General	3
2. Intended applications.....	3
3. Technical data.....	3
4. Mechanical dimensions	4
5. PCB layout	5
6. Electrical performance.....	6
7. Radiation pattern	7
8. OnBoard SMD 2400 Evaluation board.....	8
9. Antenna tuning and impedance matching.....	9
10. General implementation guidelines.....	10
11. Package dimensions	11
12. Part marking.....	12
13. Disclaimer	12
14. Ordering information.....	12

1. General

This document is a guideline for implementation of the OnBoard SMD 2400 antenna. The antenna is a combination of small size, low cost and high performance. Integration of embedded antennas is a task that involves tradeoff of different aspects, and this document aims to help when optimizing the performance of the antenna solution.

2. Intended applications

The antenna is optimized for the ISM band of 2.4 GHz, which is utilized by several protocols. Some of the applications are:

WLAN/Wifi	IEEE 802.11 (b, g, n)	2400–2497 MHz
Bluetooth	IEEE 802.15.1	2400–2483.5 MHz
ZigBee	IEEE 802.15.4	2400 – 2483.5 MHz
RFID	ISO/IEC 18000	2.45 GHz
WirelessHART	IEEE 802.15.4	2400 – 2483.5 MHz

3. Technical data

Part number	PRO-OB-440
Frequency ¹	2400 - 2500 MHz
Impedance ¹	50 Ω
Return loss ¹	< -10 dB
Total efficiency ¹	> 75% (-1.25dB)
Dimensions (LxBxH)	13.8 x 6.0 x 3.5 mm (0.541 x 0.236 x 0.138 in)
Assembly	Pick and place
Soldering	Reflow or equivalent
Packing	Tape and reel
Temperature	-40 to +125 ⁰ C
Mechanical resistance ²	Immunity to vibrations IEC/EN 60068-2-6, Fc test Immunity to shock IEC/EN 60068-2-27, Ea test
Antenna gain	2dBi

¹⁾ Measured on the Proant evaluation board PRO-EB-450

²⁾ The product has been tested according to the standard IEC 60721-3-5 – Class 5M3 (road vehicles in areas without well-developed road systems, light-weighted vehicles, tracked vehicles and self propelled machines)

4. Mechanical dimensions

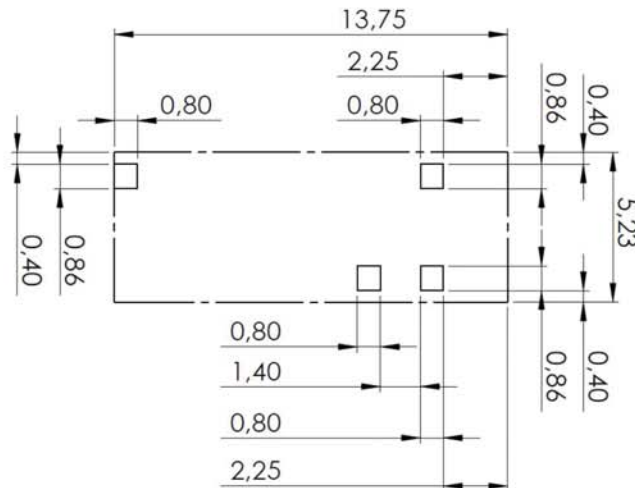

Antenna pins and keep-out block. Above dimensions are given in millimeter.

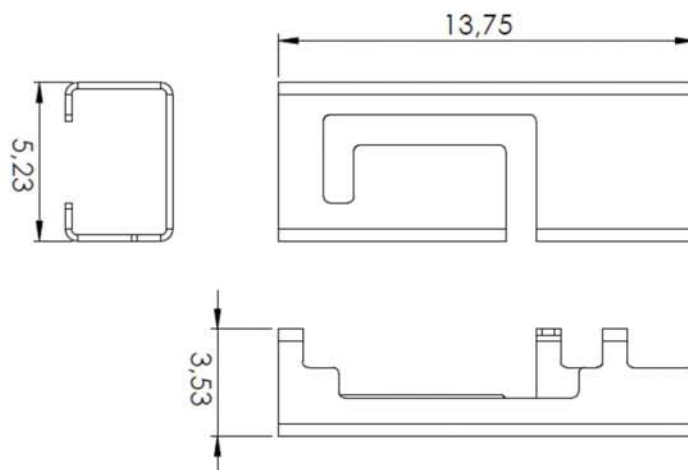

Antenna drawing. Above dimensions are given in millimeter.

5. PCB layout

The antenna is developed for optimum performance when mounted on a ground plane, and is therefore very suitably mounted on a printed circuit board, where all empty space in the layout shall be filled solid copper. This also means that no ground cutout area is required under the antenna. If there are several layers in the PCB, there is an advantage to add via holes for interconnection of the ground areas. It is also very important that there is a ground clearance around the NC pads and the RF feed pad, through all layers of the PCB. Otherwise there will be capacitive coupling which may detune the antenna.

- 3 ■ ■ 1
 ■ 2
- 4 ■
- 1 = GND
 2 = RF FEED
 3 = NC
 4 = NC



Pin configuration

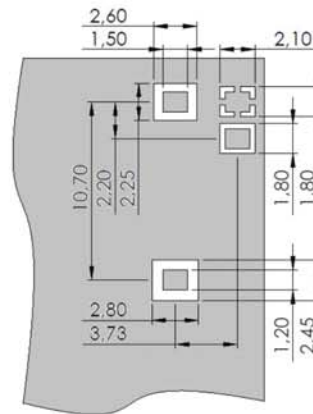

PCB Layout (from evaluation board)

The antenna is preferably positioned along one side of the PCB ground plane, where pin 1 shall be as close as possible to the layout corner.

It is also recommended to implement a pi-matching network as seen in the PCB layout to compensate for eventual mismatch due to the practical implementation. The components can be positioned below the antenna next to the feed pad. See chapter 8 for more details.

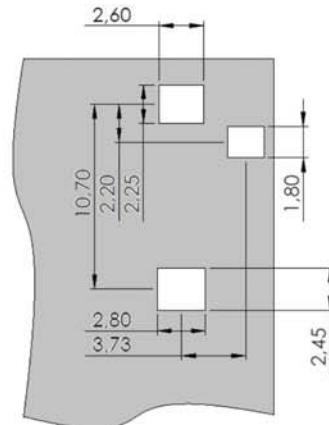

Clearance through all layers

6. Electrical performance

All results are measured with the antenna mounted on the evaluation board.

Smith chart

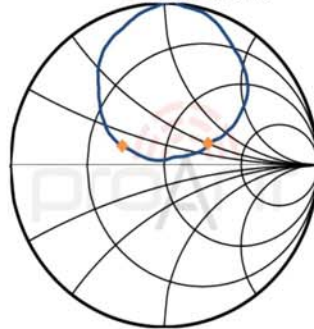

Return Loss

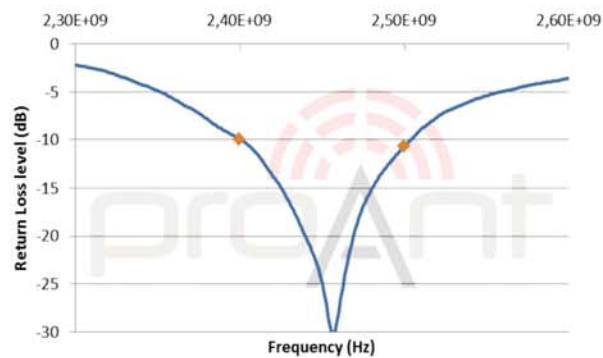

Total efficiency

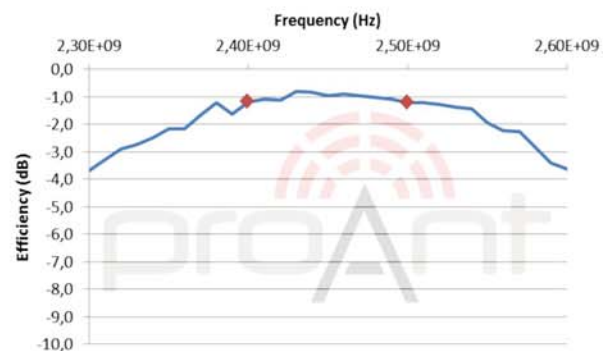

7. Radiation pattern

All results are measured with antenna mounted on the evaluation board. The figure to the right shows the corresponding antenna position for each chart. Gain values are given in dBi.

VP = Vertical Polarization, HP = Horizontal Polarization

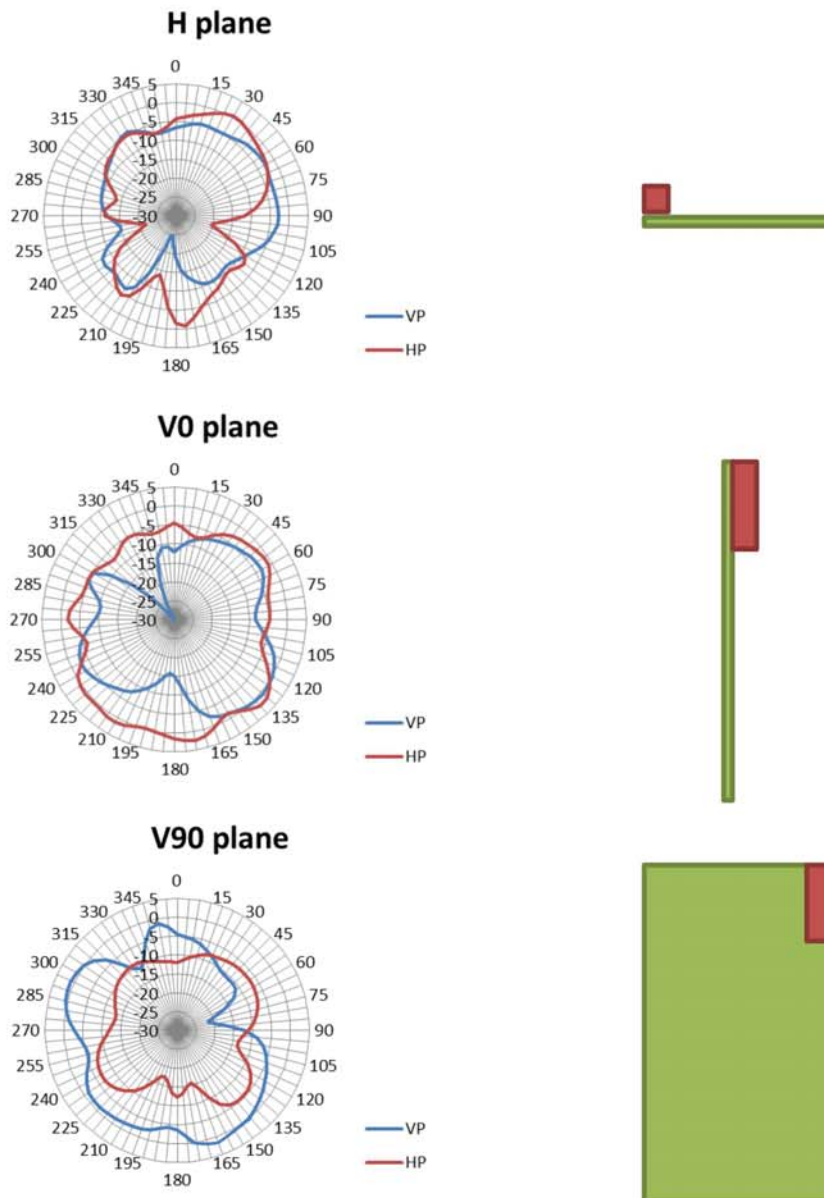

8. OnBoard SMD 2400 Evaluation board

The evaluation board is developed to simplify antenna testing and evaluation. It has an arbitrary size of 100 x 50 mm and includes an SMA connector. The purpose is to give a reference design for an optimal antenna implementation. The evaluation board can also be used to test other implementations by cutting and soldering the PCB into any device.

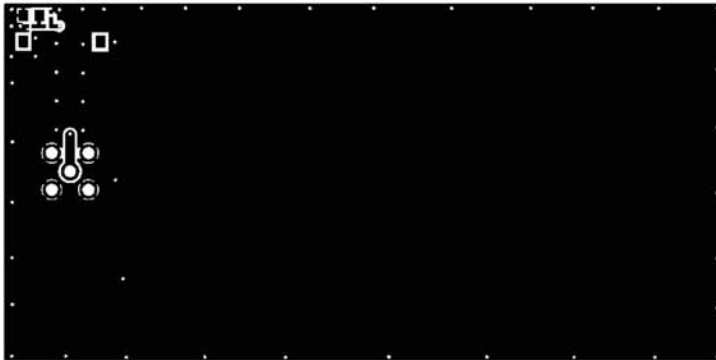

Evaluation board outline

The evaluation board has a matching circuit implemented next to the antenna. This is aimed to enable optimization possibilities for the user. The component positions are sized for 0402 (1005 metric) SMD components.

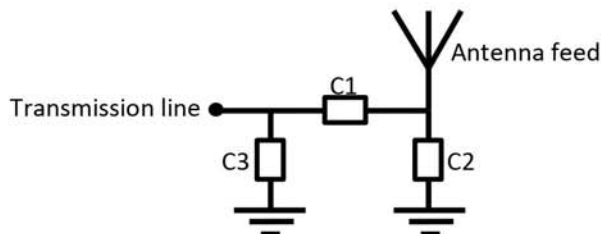

Matching circuit

The antenna needs a matching circuit to adjust the resonant frequency balance. When delivered, the evaluation board is tuned for optimum balance at the 2.4 GHz band. The component values for this setup is $C1 = 1.5\text{nH}$, $C2 = 0.5\text{pF}$, $C3 = \text{N/A}$. However, it is common that the resonant frequency will shift during implementation in an arbitrary device. Therefore this matching may be changed for compensation of such effects. This is further described in chapter 9.

9. Antenna tuning and impedance matching

The antenna should have nominal tuning in most applications when $C1 = 0 \text{ Ohm}$ (measured with coaxial cable on the evaluation board). However the user may like to elaborate with the tuning if the implementation causes a resonant frequency shift. This part shows two examples of how a simple frequency tuning can be implemented.

Tune 50 MHz down

$C1 = 2.7 \text{ nH}$ (Murata LQW15AN2N7C00)
 $C2 = 0.75 \text{ pF}$ (Murata GRM1555C1HR75CZ01)
 $C3 = \text{N/A}$

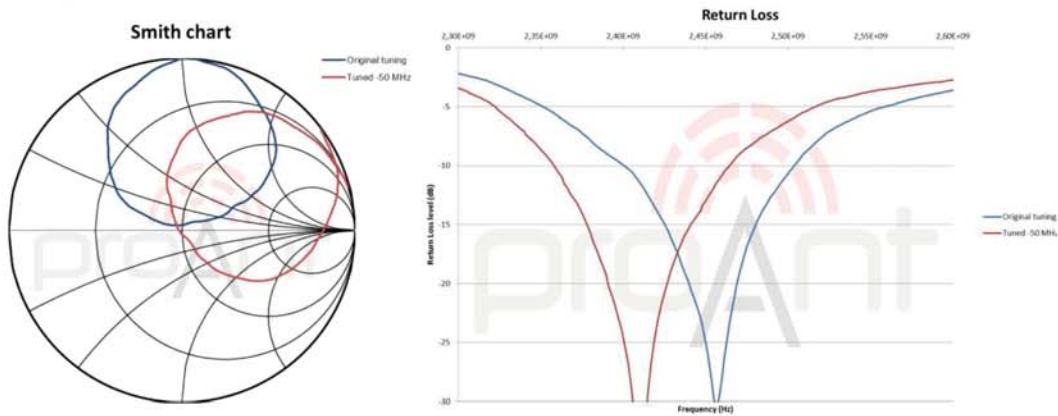

Tune 50 MHz up

$C1 = 1.0 \text{ nH}$ (Murata LQP15MN1N0W02)
 $C2 = \text{N/A}$
 $C3 = 1.0 \text{ pF}$ (Murata GRM1555C1H1R0CZ01)

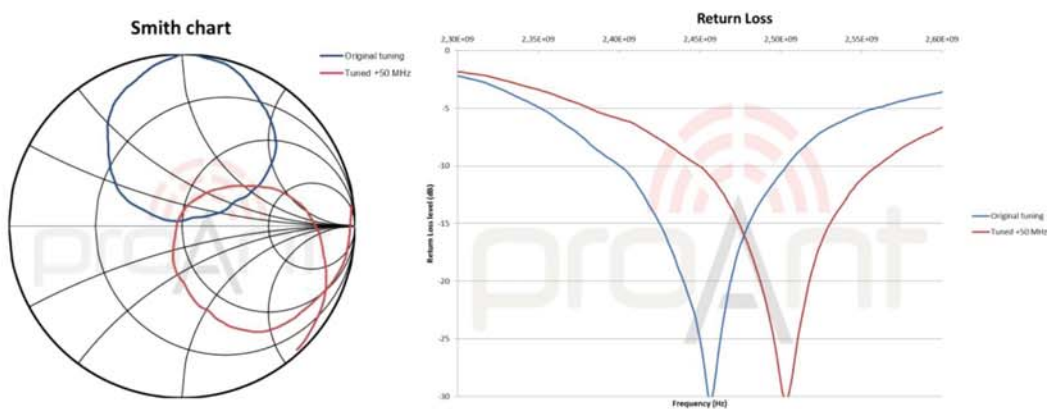

10. General implementation guidelines

The antenna can be positioned in many ways, although there are some positions which are more beneficial. Below picture shows a typical PCB with six possible antenna positions. The positions have been arranged according to the best general fit.

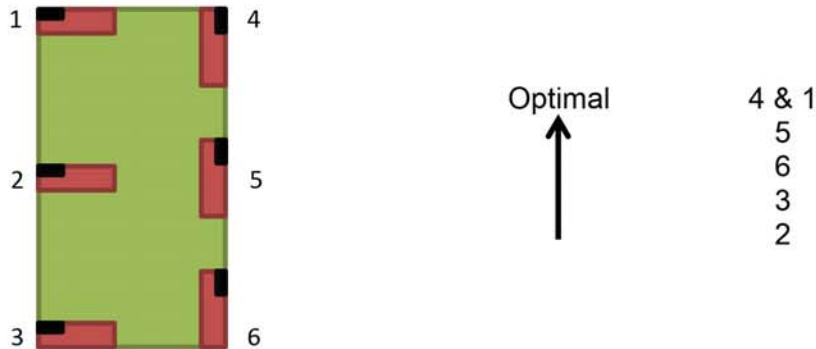

■ = feed section (pin 1 & pin 2)

The antenna should be aligned with the PCB edge if possible. It is also important to align pin 1 & 2 along the outer side of the PCB, and even more preferably close to a corner. This fact makes position 2, 3 and 6 difficult to define, why these positions are less optimal.

The OnBoard SMD 2400 antenna enables that small electrical components are mounted inside the antenna keep-out block. This may have an impact on the antenna tuning and radiated performance, but is fully possible if there is limited space on the PCB.

Another general aspect on surface mounted antennas is regarding the PCB population. If other electrical components are positioned in the surrounding area of the antenna, some impact on the antenna tuning and radiated performance may be expected. It is recommended that such components are distributed below a topographical slope that starts on PCB level at the antenna keep-out block, and slowly increases the height.

It shall also be highlighted that plastic and metal parts in the near proximity of antennas may influence the antenna tuning and/or performance. This aspect should be noted as a general guideline for all antennas. The effects are difficult to estimate without detailed information, but it is common that a plastic housing above the antenna shifts the resonant frequency down. It is recommended to measure the antenna in the actual device after implementation.

11. Package dimensions

The antenna is delivered on tape and reel according to following specifications. The quantity per 13" reel is 1000 pcs.

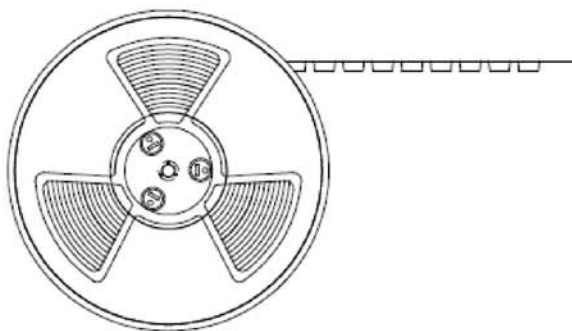
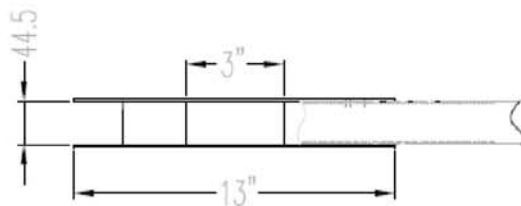
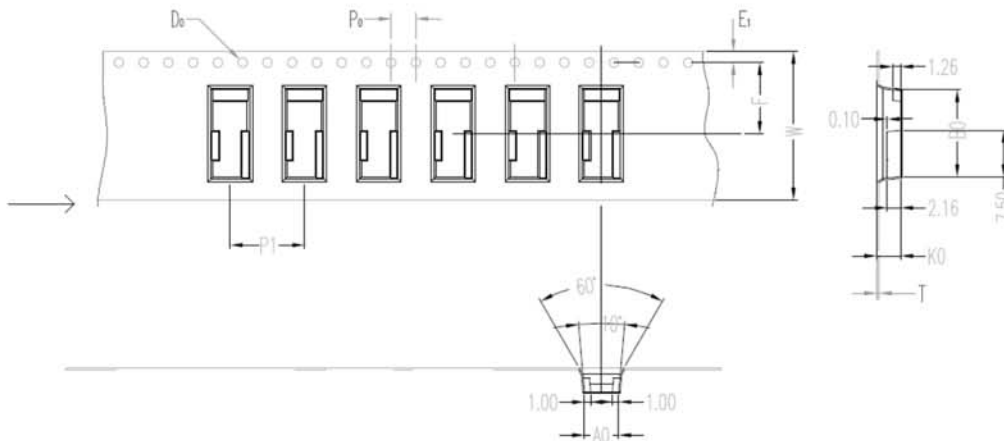

A_0	5.53 ± 0.1
B_0	14.05 ± 0.1
D_0	$\phi 1.5 \begin{smallmatrix} +0.10 \\ -0.00 \end{smallmatrix}$
E_1	1.75 ± 0.1
F	11.5 ± 0.15
K_0	3.83 ± 0.1
P_0	4.0 ± 0.1
P_1	$12. \pm 0.1$
P_2	2.0 ± 0.15
S_0	
T	0.35 ± 0.05
W	24.0 ± 0.3

12. Part marking

The top marking of the antenna is arranged according to the following illustration.

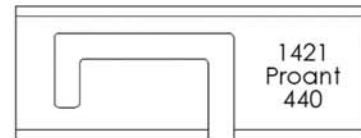
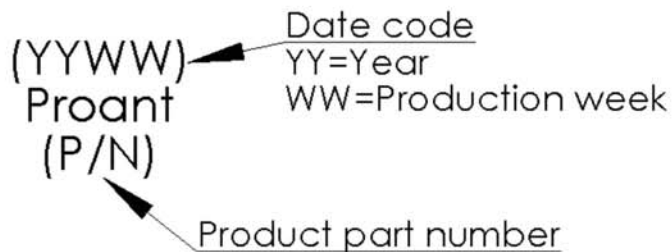

Example top marking

13. Disclaimer

The information given in this application note shall in no event be regarded as a guarantee of conditions or characteristics. With respect to any examples or hints given herein, any typical values stated herein and/or any information regarding the application of the device, Proant AB hereby disclaims any and all warranties and liabilities of any kind, including without limitation, warranties of non-infringement of intellectual property rights of any third party.

14. Ordering information

For information on sales, delivery terms and conditions and prices, please visit the Proant website (www.proant.se) for a complete list of distributors.

Proant offers consultation with design-in of the OnBoard SMD 2400 antenna, as well as design of matching network and transmission lines. Proant has all necessary capabilities for antenna design including anechoic chamber and prototype workshop. Please send your requests to info@proant.se.