

Approval Sheet



Part Name	Dual band PCB Antenna	DESCRIPTION
Part No.	APDR-600WT	
Model	F600(Wifi)	
Revision	A	
Customer	DRTECH	
Supplier	PINCRAFT ENG.	

Mechanical Engineer	RF Engineer	RF Manager	Engineering Department Manager	Quality Manager
	<div style="border: 1px solid black; width: 200px; height: 30px; margin: 0 auto;"></div>			
JM.BAEK	KM.LEE	YP.PARK	SW.BANG	
2015-10-01	2015-10-01	2015-10-01	2015-10-01	

Pincraft Engineering Inc.

Address: (5thFI, Meatan-Dong) 184, Samsung-ro

Yeongtong-gu, Suwon-si, Gyeonggi-do, Korea

Mobile Tel / phone(Korea) +82-31-211-3007 / +82-10-7176-7860

CONTENTS

1. Revision History.....	4
2. Feature And Applications	5
3. CODE NO.	5
4. Test Method	5
4.1 Test Method of Production.....	5
4.2 The measurement of Frequency and VSWR.....	6
4.3 The measurement of Gain and Radiation Patterns.....	6
4.4 Test Jig VSWR	7
5. Electrical Specifications	8
5.1 FREQUENCY BAND.....	8
5.2 TEST SPEC ON SET.....	8
5.3 VSWR data (S11 of SET condition)	9
5.4 VSWR data (S11 of JIG condition)	10
5.5 3D Gain & Radiation Patterns.....	11
5.6 2D Radiation Patterns.....	13
6. Antenna Dimensions.....	16
6.1 Top Antenna Dimensions.	16
7. Antenna Image	18
7.1 Top Antenna Image.....	18
8. Coaxial Micro-Plug	19
9. 출하검사 테스트	23
9.1 출하검사 스펙.....	23
9.1 Top Antenna VSWR.....	24
10. PACKAGING.....	25

◆ Development Issue (개발단계 주요 ISSUE 사항)

ISSUE DATE	ISSUE	REMARK
2015.07.07	승인원 제작	Rev 1.0
2015.10.01	승인원 수정	Rev 1.1

1. REVISION HISTORY

No.	Date	Before	After	Revision	Rev

2. Feature And Applications

This PCB antenna is applied to 2.4/5 GHz wifi band applications

3. CODE NO.

CODE NO. :

CUSTOMER PART NO. :

4.2 The measurement of Frequency and VSWR

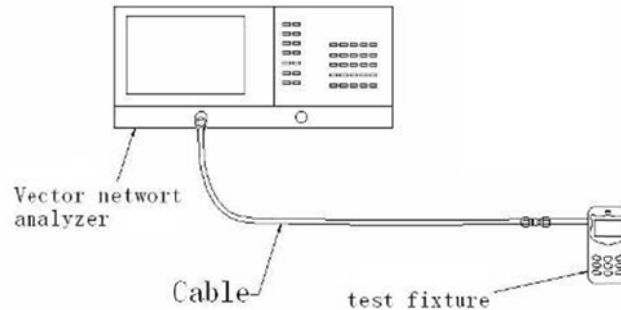

<Measurement Method>

- 1) As seen the above, network analyzer is set up for S11 measurement.
- 2) The measurement frequency range is to set up from 1.5 GHz to 6.5 GHz.
- 3) Perform S11 one port full calibration.
- 4) Measure the VSRW of Wifi frequency range.

4.3 The measurement of Gain and Radiation Patterns

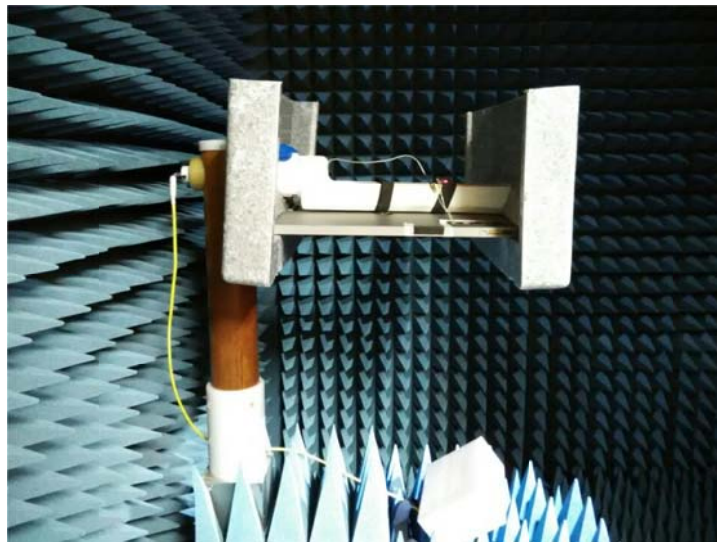

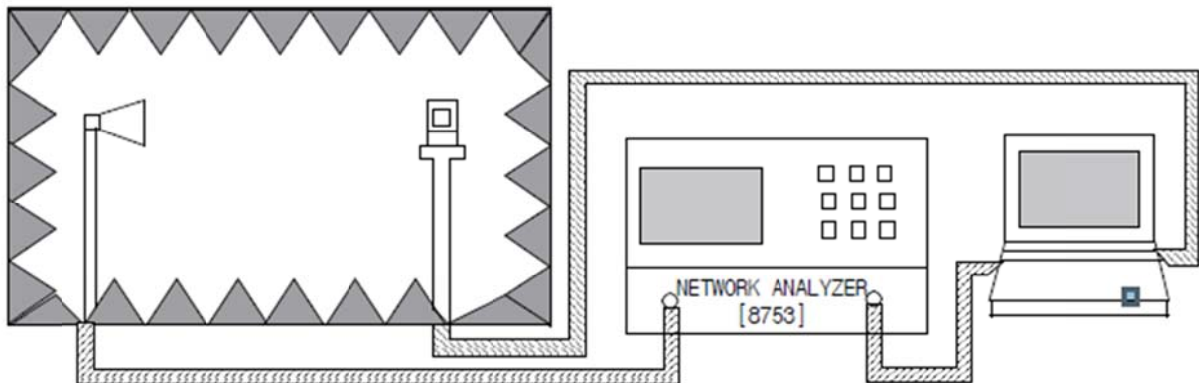

<Measurement Method>

- 1) As seen the above, network analyzer is to set up in Anechoic chamber.
- 2) As seen the beneath, for the measurement planes as Azimuth, Elevation1, and Elevation2, measure Gain data of vertical polarization and horizontal polarization for each plane.

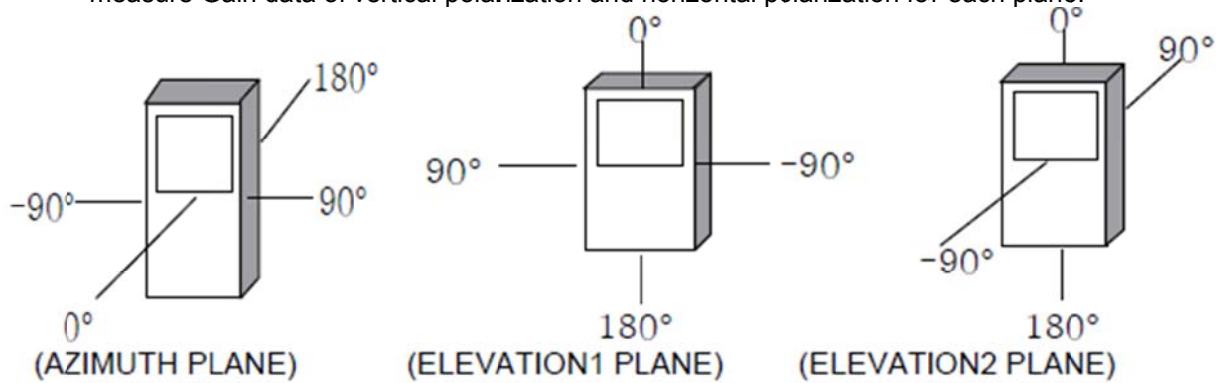

4.4 Test Jig VSWR

The antenna is tested while mounted on the test jig. Test fixture should be positioned at a distance of 20Cm away from network analyzer at least.

"VSWR deviation can be occurred by the variation of N/A(network analyzer), RF Jig and so on, therefore each Markers(frequency) on the VSWR should be adjusted by the value of the Master sample."

5. ELECTRICAL SPECIFICATIONS

5.1 FREQUENCY BAND

2.4~2.5 GHz/ 5.1~5.9GHz WIFI

5.2 TEST SPEC ON SET

- * All items are measured in room temperature (25°C).
- * All items are measured at customer set condition.

5.2.1 Top Antenna

Frequency(set)	2400MHz	2500MHz	5150MHz	5850MHz
SET V.S.W.R	1.3±0.3	3.8±0.3	1.2±0.3	1.4±0.3
3D Gain average	-11±0.5	-12.2±0.5	-6.4±0.5	-5.9±0.5
Impedance	50Ω			

5.3 VSWR data (S11 of SET condition)

5.3.1 Top Antenna VSWR



5.4 VSWR data (S11 of JIG condition)

5.4.1 Top Antenna VSWR & Data

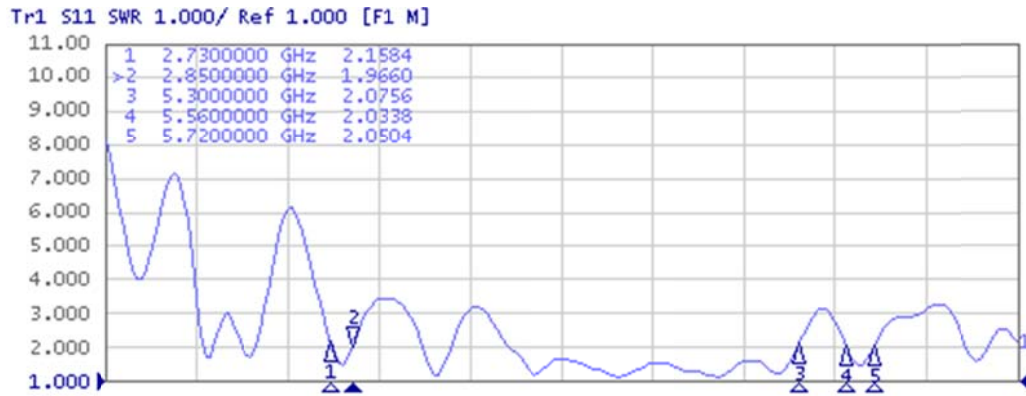

5.5 3D Gain & Radiation Patterns

5.5.1 Top Antenna 3D Gain

Antenna Pattern & Gain Report

Manufacturer	Company Name
Model Name	Filename
Tester Name	Airlink
Test Date	2015-06-24 오후 4:24:28
IF BW	100 Hz
Port Power	0.00 dBm
Meas Step	15°



Frequency	Efficiency	Average Gain			Max Gain			Max Position	Directivity
		Ver	Hor	Total	Ver	Hor	Total		
2400.000000 MHz	7.9 %	-14.8 dBi	-13.4 dBi	-11.0 dBi	-7.3 dBi	-7.8 dBi	-5.5 dBi	Theta15/Pie195	5.50 dB
2425.000000 MHz	7.9 %	-14.7 dBi	-13.5 dBi	-11.0 dBi	-7.0 dBi	-7.8 dBi	-5.6 dBi	Theta15/Pie195	5.38 dB
2450.000000 MHz	7.7 %	-14.6 dBi	-13.8 dBi	-11.1 dBi	-6.7 dBi	-7.7 dBi	-5.7 dBi	Theta30/Pie180	5.46 dB
2475.000000 MHz	7.1 %	-14.7 dBi	-14.4 dBi	-11.5 dBi	-6.9 dBi	-8.0 dBi	-6.0 dBi	Theta75/Pie165	5.52 dB
2500.000000 MHz	6.1 %	-15.2 dBi	-15.2 dBi	-12.2 dBi	-7.9 dBi	-8.5 dBi	-6.6 dBi	Theta75/Pie165	5.62 dB
5150.000000 MHz	23.0 %	-8.5 dBi	-10.5 dBi	-6.4 dBi	-1.1 dBi	-1.5 dBi	0.6 dBi	Theta15/Pie120	6.95 dB
5250.000000 MHz	23.5 %	-8.5 dBi	-10.3 dBi	-6.3 dBi	-0.7 dBi	-1.3 dBi	0.7 dBi	Theta15/Pie270	7.02 dB
5350.000000 MHz	25.0 %	-8.1 dBi	-10.2 dBi	-6.0 dBi	-0.6 dBi	-0.9 dBi	1.7 dBi	Theta15/Pie105	7.73 dB
5470.000000 MHz	27.0 %	-7.7 dBi	-10.0 dBi	-5.7 dBi	0.1 dBi	-0.2 dBi	2.1 dBi	Theta15/Pie105	7.82 dB
5600.000000 MHz	16.1 %	-9.8 dBi	-12.5 dBi	-7.9 dBi	-1.9 dBi	-3.2 dBi	-0.6 dBi	Theta15/Pie270	7.29 dB
5725.000000 MHz	16.9 %	-9.8 dBi	-11.9 dBi	-7.7 dBi	-2.1 dBi	-3.4 dBi	-1.2 dBi	Theta15/Pie90	6.52 dB
5800.000000 MHz	22.9 %	-8.6 dBi	-10.4 dBi	-6.4 dBi	-1.4 dBi	-1.8 dBi	0.5 dBi	Theta15/Pie105	6.90 dB
5850.000000 MHz	26.0 %	-8.1 dBi	-9.8 dBi	-5.9 dBi	-0.5 dBi	-1.3 dBi	1.1 dBi	Theta15/Pie105	6.93 dB

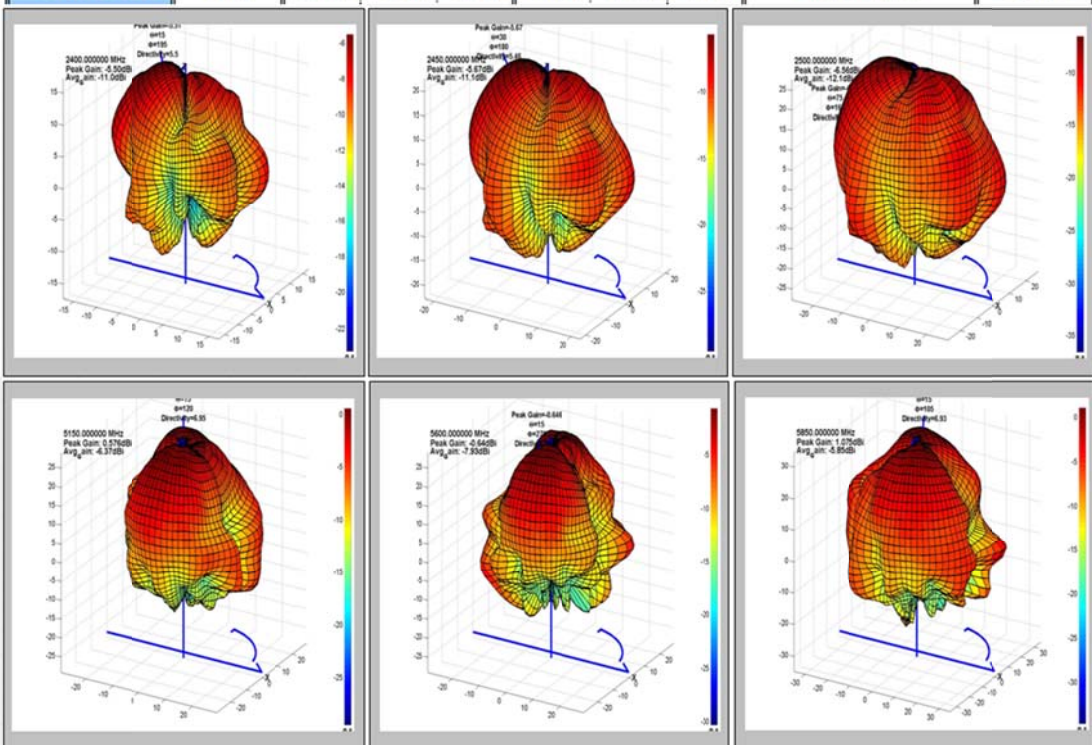

5.6 2D Radiation Patterns

5.6.1 Top Antenna 2D

(a) Azimuth plane (H-plane)

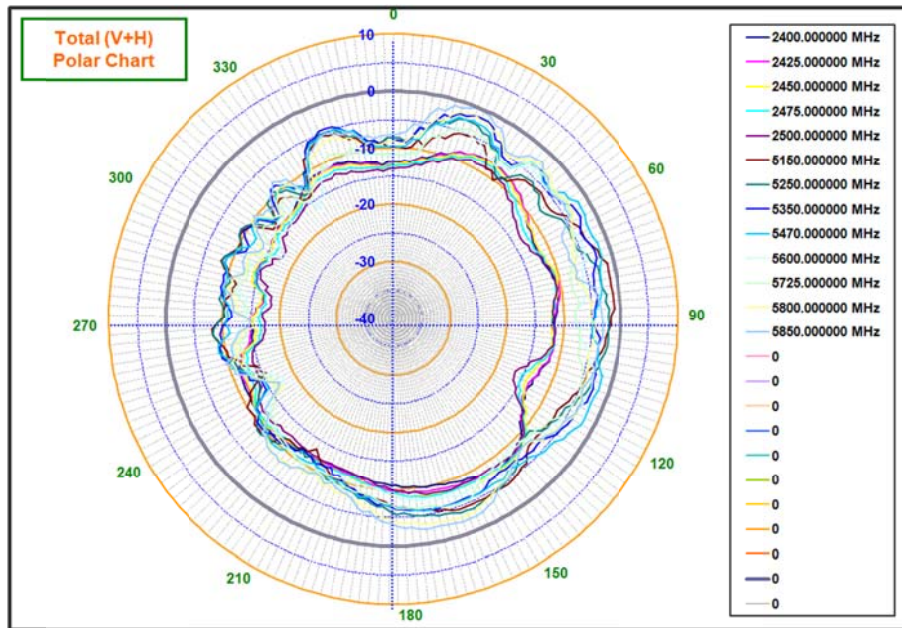

(b) Elevation plane (E1)

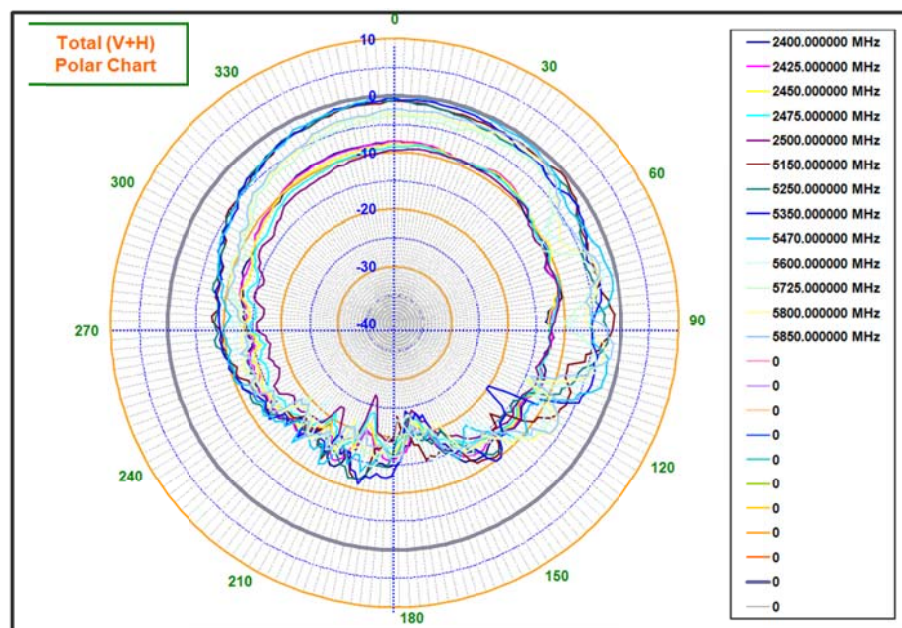

(c) Elevation plane (E2)

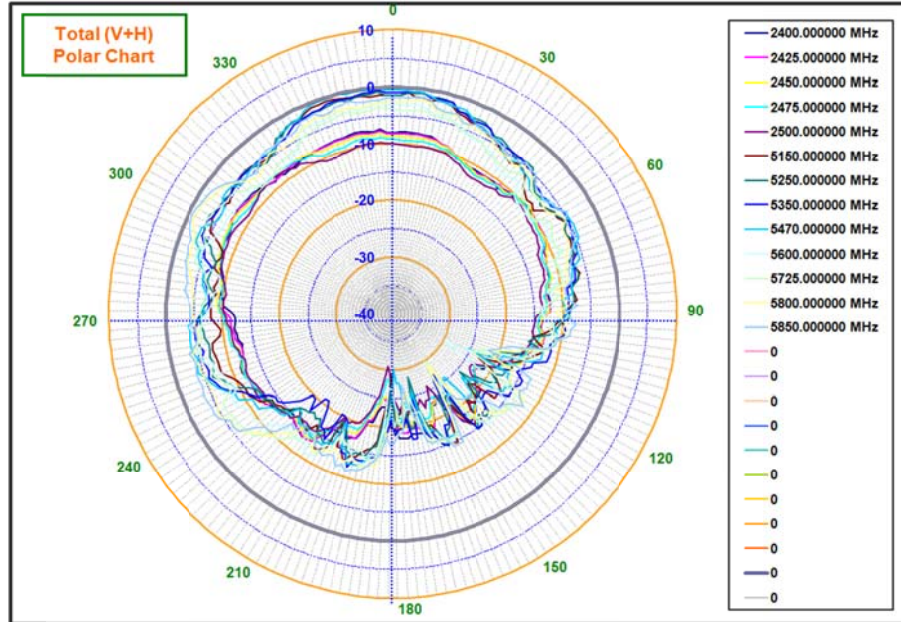

6. Antenna Dimensions.

6.1 Top Antenna Dimensions.

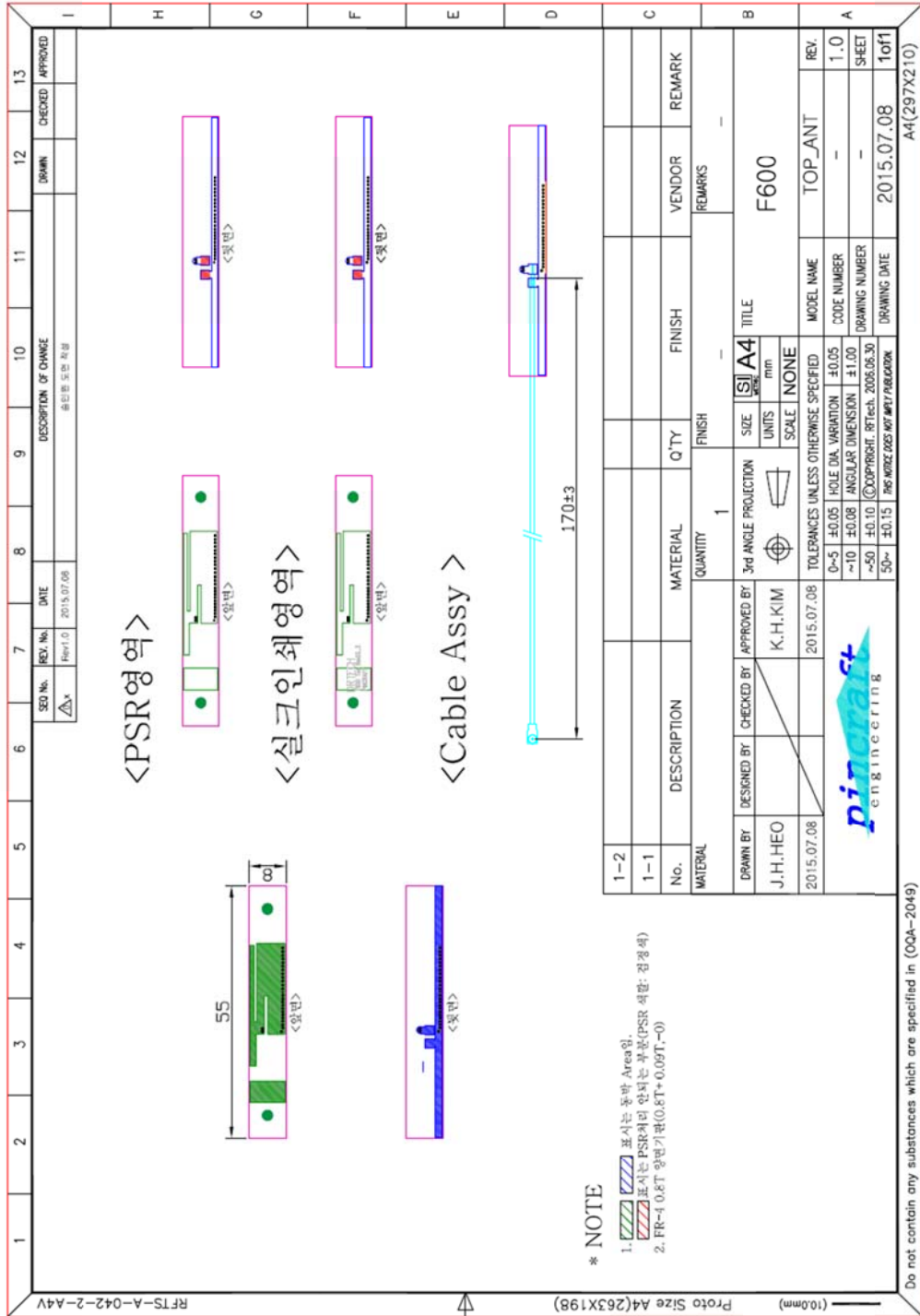

7. Antenna Image.

7.1 Top Antenna Image



8. Coaxial Micro-Plug

The GigaLane's **Coaxial Micro-Plugs (CMP)** and **Receptacles (CMJ)** are specially designed for Space Reduction on Circuit Boards and for Vertical Mounting on RF Boards. They have the excellent RF performance on the right angle transitions **up to 6 GHz**.

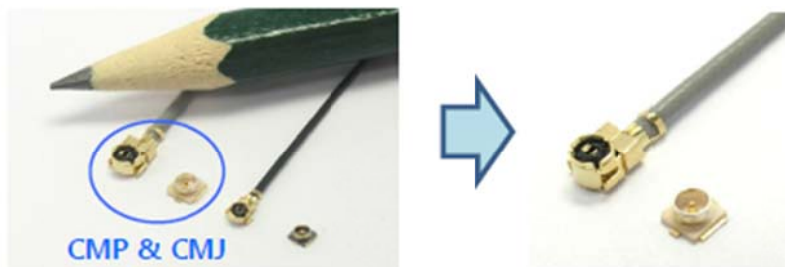

Features

- DC to 6 GHz (VSWR <1.5 Max.)
- Cable assembly of 0.81mm, 1.13mm, 1.30mm, 1.37mm
- Cable Mated heights of 1.80 mm and 2.50 mm
- Connector Mated heights of 1.25 mm and 1.3 mm
- Fully compatible with Hirose U.FL and I-PEX MHF series
- Vertical mounting on receptacle (SMT)

Mated height & Dimensions

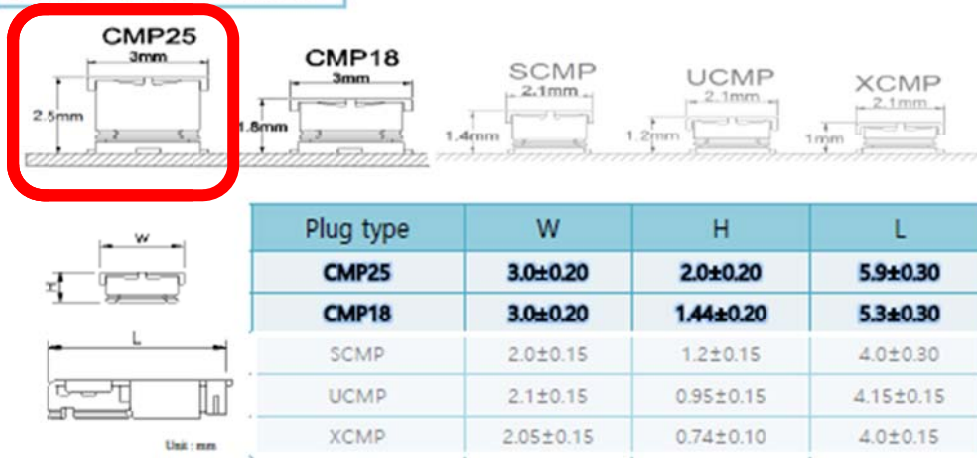

CMP Cable Assembly

Plug Type	Mating Height	Cable Type (Dia.)				
		0.64mm	0.81mm	1.13mm	1.30mm	1.37mm
CMP	2.5mm		○	○	○	○
CMP	1.8mm		○	○		
SCMP	1.4mm	○	○			
UCMP	1.2mm	○	○			
XCMP	1.0mm	○				
color		B,BL,W,R	W,BL	B,W,G	G	B,G

* color : B (Black) / W (White) / G (Gray) / BL (Blue) / R (Red)

Plugs Caution

※ Do not apply an excessive load to the cable after the connectors are mated. Please refer to the permissible load right.

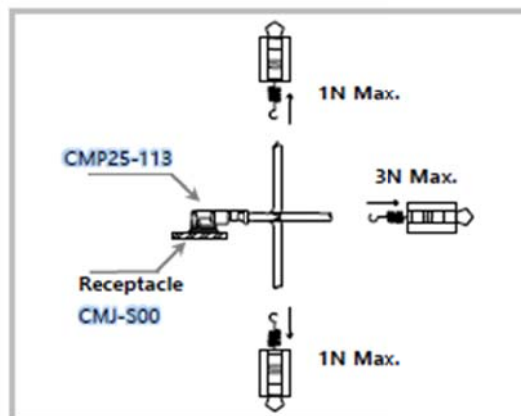

■ Single-Ended Cable Assembly

Case 4) Single Type

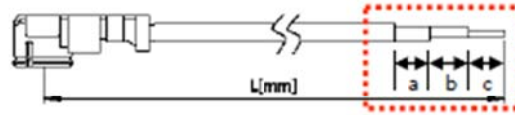

CMP25(G)-G113-150mm(a/b/c)

① ② ③ ④ ⑤ ⑥

① : Plug Type	② : Plug Height	③ : Cable Color	④ : Cable Select
<ul style="list-style-type: none"> • CMP25,18 	<ul style="list-style-type: none"> • 25(G) : 2.5mm (CMP only) • 18(G) : 1.8mm (CMP only) 	<ul style="list-style-type: none"> • W : White • G : Gray • B : Black • BL : Blue 	<ul style="list-style-type: none"> • 081 (Dia : 0.81 mm) • 113 (Dia : 1.13 mm) • 130 (Dia : 1.30 mm) • 137 (Dia : 1.37 mm)
⑤ : Cable Length	⑥ : Strip Condition		
<ul style="list-style-type: none"> • Customized • Min. Length : 30mm 	<ul style="list-style-type: none"> • Ground/Insulator/Signal • Length Unit : mm 		

Product Specifications

Item	Specifications	Conditions
Impedance	50 ohm ± 2	TDR Measurement
Insulation Resistance	500 MΩ min.	100V DC
VSWR	CMP25(G)-G113-CMP25(G)-100mm	1.5 Max. up to 6 GHz
	CMP25(G)-G130-CMP25(G)-100mm	
	CMP25(G)-B137-CMP25(G)-100mm	
	CMP18(G)-W081-CMP18(G)-100mm	
	CMP18(G)-G113-CMP18(G)-100mm	
Un-mating Force	CMP25, CMP18 6 N min.	Measured by a push-pull gauge
Durability	Contact Resistance Center : 20 m Ohms max. Outer : 10 m Ohms max.	30 cycle
Humidity (Steady State)	<ul style="list-style-type: none"> ✓ No damage, cracks or parts dislocation ✓ Insulation resistance 100M Ohms min (high humidity condition) ✓ Insulation resistance 500M Ohms min (dry condition) 	96 hours (40 °C) humidity : 95%

Performance - 1



CMP25(G)-G113-CMP25(G)-100mm

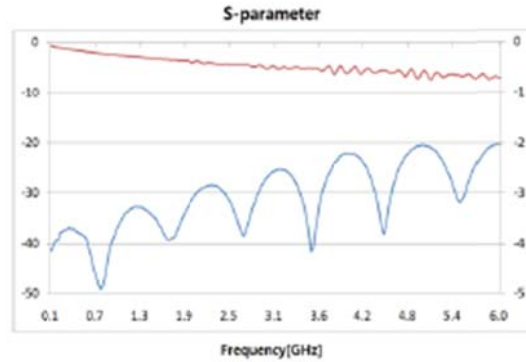

- Frequency : 0.1 ~ 6 GHz
- Test Equipment : E5071C
- Test Configuration : full 2-port calibration
- Cable Length : 100 mm

Performance - 1

■ Test Configuration

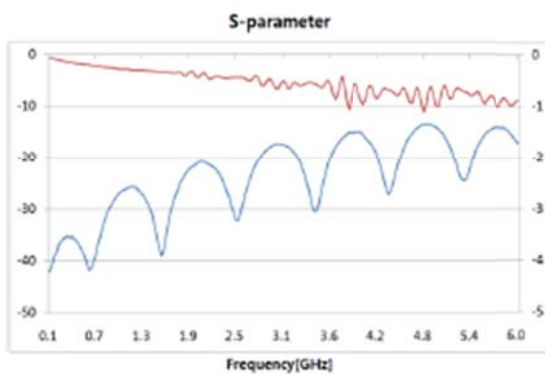
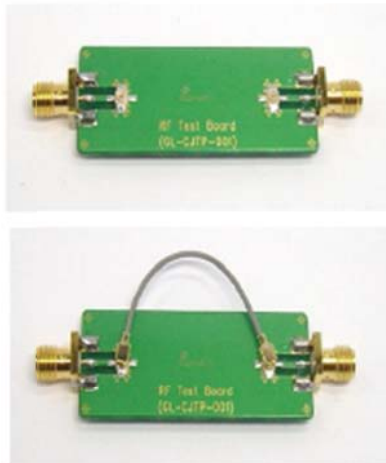

9. 출하검사 테스트



9.1 출하검사 스펙

9.1.1 Top Antenna

Frequency(set)	2730 MHz	2850 MHz	5300 MHz	5560 MHz	5720 MHz
SET V.S.W.R	2.06 ± 0.3	1.96 ± 0.3	2.03 ± 0.3	2.06 ± 0.3	2.06 ± 0.3
Impedance	50Ω				

9.2 Top Antenna VSWR Data

pincraft engineering

RF parameter CPK test Report					
Customer: DRTECH					
Part Name: F600	Revision No.:			Insp. By:	
Part No.:	Date:2015-10-01			Eqt No.:	
Material:	Dim. NO:			Cavity No.:	
Frequency(MHz)	2.73Ghz	2.85Ghz	5.30 Ghz	5.56 Ghz	5.72 Ghz
VSWR	2.06	1.96	2.03	2.06	2.06
Upper tolerance :	0.30	0.30	0.30	0.30	0.30
Lower tolerance :	0.30	0.30	0.30	0.30	0.30
USL:	2.36	2.26	2.33	2.36	2.36
LSL:	1.76	1.66	1.73	1.76	1.76
Insp. Equi.	VNA				
MEAS. NUM	Fact Data	Fact Data	Fact Data	Fact Data	Fact Data
1	1.97	2.00	2.18	2.09	2.26
2	2.09	1.92	1.80	2.14	1.82
3	2.14	2.00	1.87	1.98	1.86
4	2.06	2.03	2.17	2.06	2.12
5	2.06	1.91	1.93	2.03	1.94
6	2.08	1.95	2.07	2.01	2.14
7	1.96	1.94	1.95	2.11	1.96
8	2.04	2.00	2.33	2.03	2.29
9	2.15	1.96	2.07	2.03	2.05
10	2.08	1.92	1.95	2.09	2.14
MAX	2.15	2.03	2.33	2.14	2.29
MIN	1.96	1.91	1.80	1.98	1.82
MEAN	2.06	1.96	2.03	2.06	2.06
STDEV	0.06	0.04	0.16	0.05	0.16
CP	1.61	2.39	0.62	2.01	0.62
CPK1	1.60	2.36	0.61	2.03	0.63
cpk2	1.63	2.41	0.62	1.99	0.62
cpk	1.60	2.36	0.61	1.99	0.62

Checked by:

Prepared by:

10. PACKAGING

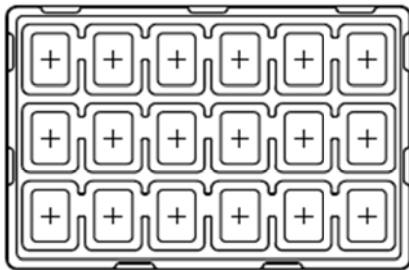
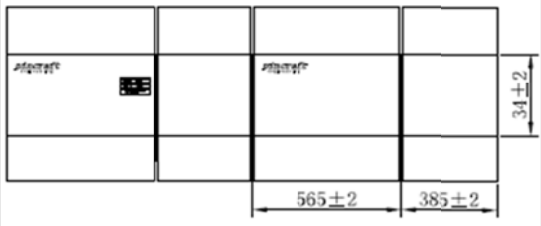
PINCRAFT ENGINEERING Inc. Packing Spec.																	
Customer: DR TECH		Project: F600		Number: -													
Issued:																	
Packing dimensions	Number	Part name	Spec	Q'ty	product draw												
		PP tray	550*370*13mm/case	30/900													
		BOX	565*385*340mm	1/900													
		VINYL	600*400*14mm	1/900													
Operation step	<ol style="list-style-type: none"> 1. Prepare the packaging material in the work place. 2. Packaging, one put 1 PCS, 30 PCS tray, tray 180° staggered stacked, each group of 900PCS. 3. 1 set each, a total of 900 PCS. After full box, with transparent tape sealing. 4. The right place each tray need to paste the model label. 5. Request packaging before operation, be sure to carefully review each layer tray products, Prevent shipment shortage weight. 				Tags												
Points of Attention	<ol style="list-style-type: none"> 1. Operator should wear gloves. 2. Note that the number of packing, not more loaded and less loaded. Mantissa box shall be marked (ie, upper left side of the carton labeled green 'mantissa' tags to distinguish.) 3. Cartons can not be stacked too high (three or less) to prevent stress deformation. 																
Drawing show	Pallet Size:		BOX size:														
																	
	<table border="1" style="width: 100%; border-collapse: collapse; margin: 10px 0;"> <tr> <td style="width: 50%; padding: 5px;">Company Name</td> <td style="width: 50%; padding: 5px;">Pincraft Engineering Inc.</td> </tr> <tr> <td style="padding: 5px;">Products Name</td> <td style="padding: 5px;">F600 (ANT)</td> </tr> <tr> <td style="padding: 5px;">Pincraft Code</td> <td style="padding: 5px;">-</td> </tr> <tr> <td style="padding: 5px;">DR TECH Code</td> <td style="padding: 5px;">-</td> </tr> <tr> <td style="padding: 5px;">Q'ty</td> <td style="padding: 5px;">1,900</td> </tr> <tr> <td style="padding: 5px;">Producing date</td> <td style="padding: 5px;">__ year __ month __ date</td> </tr> </table> <p style="font-size: small; margin-top: 5px;">Attention: must be well protected against dampness, shock, press and handle with care</p>					Company Name	Pincraft Engineering Inc.	Products Name	F600 (ANT)	Pincraft Code	-	DR TECH Code	-	Q'ty	1,900	Producing date	__ year __ month __ date
Company Name	Pincraft Engineering Inc.																
Products Name	F600 (ANT)																
Pincraft Code	-																
DR TECH Code	-																
Q'ty	1,900																
Producing date	__ year __ month __ date																