



# CANADA Radio Test Report

## IC ID: 6608A-RF100XTX

This report concerns (check one) :  Original Grant  Class II Change

**Issued Date :** Nov. 20, 2008

**Project No. :** 0811C008

**Equipment :** Temperature and humidity transmitter

**Model Name :** 00611TX

**Applicant :** Chaney Instrument Co.

**Address :** Rm 1102-3,Enterprise Square One,Tower 3,  
No.9,Sheung Yuet Road,Kowloon bay, Kowloon,  
Hong Kong,China

**Tested by:**

Neutron Engineering Inc. EMC Laboratory

**Date of Test:**

Nov. 03, 2008 ~ Nov. 20, 2008

Testing Engineer : Jeff Yang  
(Jeff Yang)

Technical Manager : Vic Chiu  
(Vic Chiu)

Authorized Signatory : Steven Lu  
(Steven Lu)

### NEUTRON ENGINEERING INC.

No. 132-1, Lane 329, Sec. 2, Palain Rd.,  
Shijr City, Taipei, Taiwan

TEL : (02) 2646-5426 FAX : (02) 2646-6815





**Declaration**

**Neutron** represents to the client that testing is done in accordance with standard procedures as applicable and that test instruments used has been calibrated with the standards traceable to National Measurement Laboratory (NML) of R.O.C., or National Institute of Standards and Technology (NIST) of U.S.A.

**Neutron's** reports apply only to the specific samples tested under conditions. It is manufacture's responsibility to ensure that additional production units of this model are manufactured with the identical electrical and mechanical components. **Neutron** shall have no liability for any declarations, inferences or generalizations drawn by the client or others from **Neutron** issued reports.

**Neutron's** reports must not be used by the client to claim product endorsement by the authorities or any agency of the Government.

This report is the confidential property of the client. As a mutual protection to the clients, the public and **Neutron-self**, extracts from the test report shall not be reproduced except in full with **Neutron's** authorized written approval.

**Neutron's** laboratory quality assurance procedures are in compliance with the **ISO Guide 17025** requirements, and accredited by the conformity assessment authorities listed in this test report.

**Limitation**

For the use of the authority's logo is limited unless the Test Standard(s)/Scope(s)/Item(s) mentioned in this test report is (are) included in the conformity assessment authorities acceptance respective.



<b>Table of Contents</b>	<b>Page</b>
1 . CERTIFICATION	5
2 . SUMMARY OF TEST RESULTS	6
2.1 TEST FACILITY	7
2.2 MEASUREMENT UNCERTAINTY	7
3 . GENERAL INFORMATION	8
3.1 GENERAL DESCRIPTION OF EUT	8
3.2 DESCRIPTION OF TEST MODES	9
3.3 BLOCK DIGRAM SHOWING THE CONFIGURATION OF SYSTEM TESTED	10
3.4 DESCRIPTION OF SUPPORT UNITS	11
4 . EMC EMISSION TEST	12
4.1 CONDUCTED EMISSION MEASUREMENT	12
4.1.1 POWER LINE CONDUCTED EMISSION LIMITS	12
4.1.2 MEASUREMENT INSTRUMENTS LIST	12
4.1.3 TEST PROCEDURE	13
4.1.4 DEVIATION FROM TEST STANDARD	13
4.1.5 TEST SETUP	13
4.1.6 EUT OPERATING CONDITIONS	13
4.1.7 TEST RESULTS	14
4.2 RADIATED EMISSION MEASUREMENT	15
4.2.1. FIELD STRENGTH OF FUNDAMENTAL EMISSIONS MEASUREMENT LIMIT	15
4.2.2. MEASURING INSTRUMENTS AND SETTING	15
4.2.3 RADIATED EMISSIONS MEASUREMENT	16
4.2.4. DWELL TIME OF PERIODIC OPERATION MEASUREMENT	18
4.2.5. MEASUREMENT INSTRUMENTS LIST	20
4.2.6. TEST PROCEDURE	20
4.2.7. DEVIATION FROM TEST STANDARD	20
4.2.8. TEST SETUP	21
4.2.9. EUT OPERATING CONDITIONS	21
4.3. TEST RESULTS (BETWEEN 30 – 1000 MHz)	22
4.4 TEST RESULTS (ABOVE 1000 MHz)	26
5. 20dB SPECTRUM BANDWIDTH MEASUREMENT	30
5.1.MEASURING INSTRUMENTS AND SETTING	30
5.2.TEST PROCEDURES	30
5.3. TEST SETUP LAYOUT	30
5.4. TEST DEVIATION	30



<b>Table of Contents</b>	<b>Page</b>
5.5. EUT OPERATION DURING TEST	30
5.6. TEST RESULT	31
6. TIMING TESTING	32
6.1. MEASURING INSTRUMENTS AND SETTING	32
6.2. TEST PROCEDURES	32
6.3. TEST SETUP LAYOUT	32
6.4. TEST DEVIATION	32
6.5. EUT OPERATION DURING TEST	32
6.6. TEST RESULT	33
7. EUT TEST PHOTO	35



## 1. CERTIFICATION

Equipment: Temperature and humidity transmitter

Trade Name : ACURITE

Model Name. : 00611TX

Applicant: Chaney Instrument Co.

Date of Test: Nov. 03, 2008 ~ Nov. 20, 2008

Test Item: ENGINEERING SAMPLE

Standards: FCC Part15, Subpart C(15.231)/ ANSI C63.4 : 2003; Canada RSS-210:2007

The above equipment has been tested and found compliance with the requirement of the relative standards by Neutron Engineering Inc. EMC Laboratory.

The test data, data evaluation, and equipment configuration contained in our test report (Ref No. NEI-ICP-1-0811C008) were obtained utilizing the test procedures, test instruments, test sites that has been accredited by the Authority of NVLAP and TAF according to the ISO-17025 quality assessment standard and technical standard(s).



**2. SUMMARY OF TEST RESULTS**

Test procedures according to the technical standards:

<b>FCC Part15, Subpart C (15.231)</b>			
<b>Standard Section</b>	<b>Test Item</b>	<b>Judgment</b>	<b>Remark</b>
15.207	Conducted Emission	-	Note(1)
15.209 & 15.231(e)	Radiated Spurious Emission	PASS	
15.231(c)	20dB Occupied Bandwidth Measurement	PASS	

**NOTE:**

(1) "N/A" denotes test is not applicable in this Test Report



**2.1 TEST FACILITY**

The test facilities used to collect the test data in this report is **C01/OS02** at the location of No.132-1, Lane 329, Sec. 2, Palian Road, Shijr City, Taipei, Taiwan.  
Neutron's test firm number is 4428

**2.2 MEASUREMENT UNCERTAINTY**

The reported uncertainty of measurement  $y \pm U$ , where expended uncertainty **U** is based on a standard uncertainty multiplied by a coverage factor of **k=2**, providing a level of confidence of approximately **95 %**.

**A. Conducted Measurement :**

Test Site	Method	Measurement Frequency Range	U , (dB)	NOTE
C01	ANSI	150 KHz ~ 30MHz	1.94	

**B. Radiated Measurement :**

Test Site	Method	Measurement Frequency Range	Ant. H / V	U , (dB)	NOTE
OS-01	ANSI	30MHz ~ 200MHz	V	3.82	
		30MHz ~ 200MHz	H	3.60	
		200MHz ~ 1,000MHz	V	3.86	
		200MHz ~ 1,000MHz	H	3.94	
OS-02	ANSI	30MHz ~ 200MHz	V	2.48	
		30MHz ~ 200MHz	H	2.16	
		200MHz ~ 1,000MHz	V	2.50	
		200MHz ~ 1,000MHz	H	2.66	



**3. GENERAL INFORMATION**

**3.1 GENERAL DESCRIPTION OF EUT**

Equipment	Temperature and humidity transmitter	
Trade Name	ACURITE	
Model Name.	00611TX	
OEM Brand/Model Name	N/A	
Model Difference	N/A	
Product Description	The EUT is a Temperature and humidity transmitter.	
	Product Type	Low Power Communication Device
	Operation Frequency:	433.92 MHz
	Modulation Type:	ASK
	Number Of Channel	1CH
	Antenna Designation:	Integral antenna
	Output Power:	58.01 dBuV/m (AV Max.)
Based on the application, features, or specification exhibited in User's Manual, the EUT is considered as an ITE/Computing Device. More details of EUT technical specification, please refer to the User's Manual.		
Channel List	Please refer to the Note 2.	
Power Source	DC Voltage supplied from 2*AA size Battery(TX Sample)	
Power Rating	DC 3.0V (TX Sample)	
Connecting I/O Port(s)	Please refer to the User's Manual	

**Note:**

1. For a more detailed features description, please refer to the manufacturer's specifications or the User's Manual.

- 2.

Frequency Band	Channel No.	Frequency
	1	433.92MHz





**3.2 DESCRIPTION OF TEST MODES**

To investigate the maximum EMI emission characteristics generated from EUT, the test system was pre-scanning tested based on the consideration of following EUT operation mode or test configuration mode which possible have effect on EMI emission level. Each of these EUT operation mode(s) or test configuration mode(s) mentioned above was evaluated respectively.

Pretest Mode	Description
Mode 1	TX CH 433.92MHz

For Conducted Test	
Final Test Mode	Description
	" N/A" denotes test is not applicable in this Test Report

For Radiated Test	
Final Test Mode	Description
Mode 1	TX CH 433.92MHz

Note:

- (1) The test sample used the new battery
- (2) The EUT is considered a portable unit; it was pre-tested on the positioned of each 3 axis. The worst case was found positioned on Z-plane. Therefore only the test data of this Z-plane was used for radiated emission measurement test.

EUT Orthogonal Axis :

"X" - denotes Laid on Table ; "Y" - denotes Vertical Stand ; "Z" - denotes Side Stand



3.3 BLOCK DIGRAM SHOWING THE CONFIGURATION OF SYSTEM TESTED

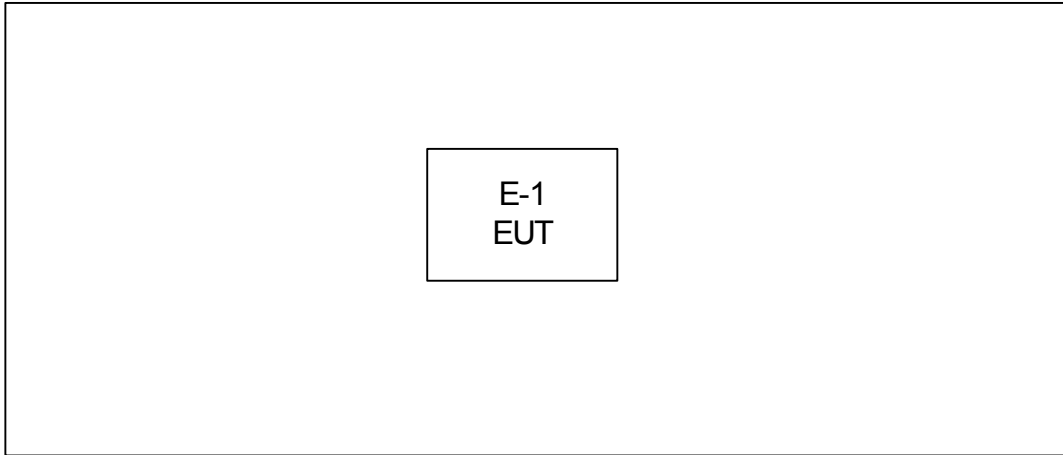



**3.4 DESCRIPTION OF SUPPORT UNITS**

The EUT has been tested as an independent unit together with other necessary accessories or support units. The following support units or accessories were used to form a representative test configuration during the tests.

Item	Equipment	Mfr/Brand	Model/Type No.	FCC ID	Series No.	Note
E-1	Temperature and humidity transmitter	ACURITE	00611TX	RNERF100XTX	N/A	EUT

Item	Shielded Type	Ferrite Core	Length	Note

**Note:**

- (1) The support equipment was authorized by Declaration of Confirmation.
- (2) For detachable type I/O cable should be specified the length in cm in 『Length』 column.



**4. EMC EMISSION TEST**

**4.1 CONDUCTED EMISSION MEASUREMENT**

**4.1.1 POWER LINE CONDUCTED EMISSION LIMITS (Frequency Range 150KHz-30MHz)**

FREQUENCY (MHz)	Class A (dBuV)		Class B (dBuV)		Standard
	Quasi-peak	Average	Quasi-peak	Average	
0.15 -0.5	79.00	66.00	66 - 56 *	56 - 46 *	CISPR
0.50 -5.0	73.00	60.00	56.00	46.00	CISPR
5.0 -30.0	73.00	60.00	60.00	50.00	CISPR

0.15 -0.5	79.00	66.00	66 - 56 *	56 - 46 *	FCC
0.50 -5.0	73.00	60.00	56.00	46.00	FCC
5.0 -30.0	73.00	60.00	60.00	50.00	FCC

Note:

- (1) The tighter limit applies at the band edges.
- (2) The limit of " \* " marked band means the limitation decreases linearly with the logarithm of the frequency in the range.

**4.1.2 MEASUREMENT INSTRUMENTS LIST**

Item	Kind of Equipment	Manufacturer	Type No.	Serial No.	Calibrated until
1	LISN	EMCO	3816/2	00042991	Jan. 24, 2009
2	LISN	EMCO	3816/2	00042990	Jan. 24, 2009
3	Pulse Limiter	Electro-Metrics	EM-7600	112644	Nov. 27, 2008
4	50Ω Terminator	N/A	N/A	N/A	May.13, 2009
5	Test Cable	N/A	C01	N/A	Nov. 27, 2008
6	EMI Test Receiver	R&S	ESCI	100082	Mar. 07, 2009

Remark: " N/A" denotes No Model Name. , Serial No. or No Calibration specified.

The following table is the setting of the receiver

Receiver Parameters	Setting
Attenuation	10 dB
Start Frequency	0.15 MHz
Stop Frequency	30 MHz
IF Bandwidth	9 kHz

#### 4.1.3 TEST PROCEDURE

- The EUT was placed 0.4 meters from the horizontal ground plane with EUT being connected to the power mains through a line impedance stabilization network (LISN). All other support equipments powered from additional LISN(s). The LISN provide 50 Ohm/ 50uH of coupling impedance for the measuring instrument.
- Interconnecting cables that hang closer than 40 cm to the ground plane shall be folded back and forth in the center forming a bundle 30 to 40 cm long.
- I/O cables that are not connected to a peripheral shall be bundled in the center. The end of the cable may be terminated, if required, using the correct terminating impedance. The overall length shall not exceed 1 m.
- LISN at least 80 cm from nearest part of EUT chassis.
- For the actual test configuration, please refer to the related Item –EUT Test Photos.

#### 4.1.4 DEVIATION FROM TEST STANDARD

No deviation

#### 4.1.5 TEST SETUP

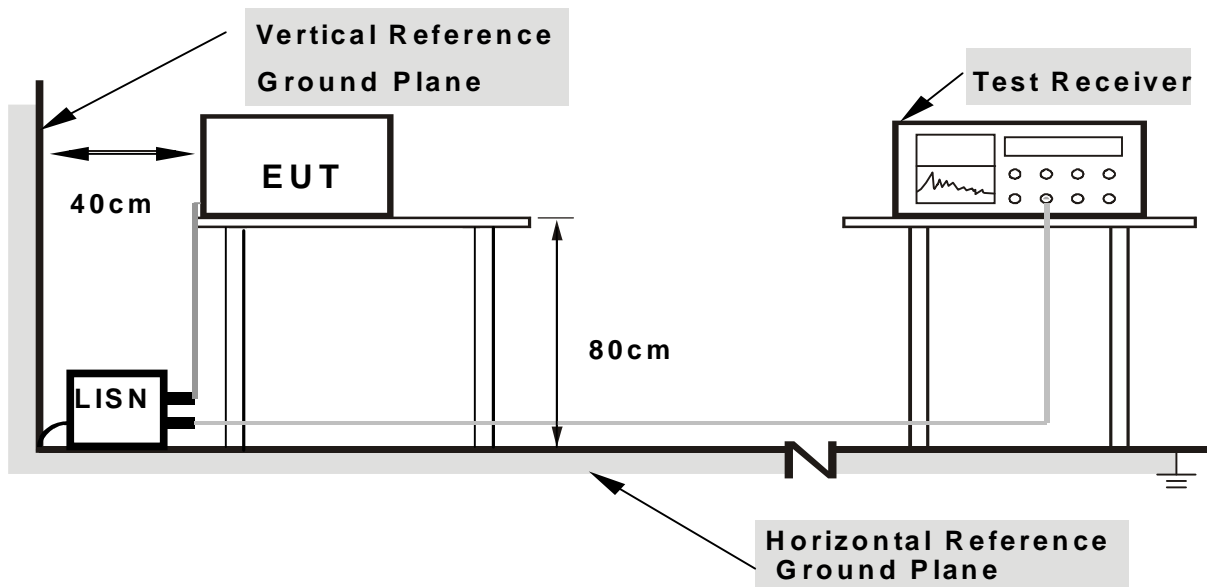

**Note: 1. Support units were connected to second LISN.**

**2. Both of LISNs (AMN) are 80 cm from EUT and at least 80 cm from other units and other metal planes**

#### 4.1.6 EUT OPERATING CONDITIONS

The EUT was configured for testing in a typical fashion (as a customer would normally use it). The EUT has been programmed to continuously transmit during test. This operating condition was tested and used to collect the included data.



4.1.7 TEST RESULTS

EUT :	Temperature and humidity transmitter	Model Name. :	00611TX
Temperature :	26 °C	Relative Humidity :	58 %
Pressure :	1010 hPa	Test Power :	DC 3.0V
Test Mode :	" N/A" denotes test is not applicable in this Test Report		

Remark

- (1) All readings are QP Mode value unless otherwise stated AVG in column of "Note". If the QP Mode Measured value compliance with the QP Limits and lower than AVG Limits, the EUT shall be deemed to meet both QP & AVG Limits and then only QP Mode was measured, but AVG Mode didn't perform. In this case, a " \* " marked in AVG Mode column of Interference Voltage Measured.
- (2) Measuring frequency range from 150KHz to 30MHz.
- (3) " N/A" denotes test is not applicable in this Test Report



**4.2 RADIATED EMISSION MEASUREMENT**

**4.2.1. FIELD STRENGTH OF FUNDAMENTAL EMISSIONS MEASUREMENT LIMIT**

Frequency Band (MHz)	Fundamental Emissions Limit (uV/m) at 3m
40.66-40.70	1000
70-130	500
130-174	500-1500(**)
174-260	1500
260-470	1500-5000(**)
Above 470	5000

\*\*1. Linear interpolations, the formulas for calculating the maximum permitted fundamental field strengths are as follows:

- (1) for the band 130 - 174 MHz,  $\mu\text{V/m}$  at 3 meters =  $22.72727 \times (\text{operating frequency, MHz}) - 2454.545$ ;
- (2) for the band 260 - 470 MHz,  $\mu\text{V/m}$  at 3 meters =  $16.6667 \times (\text{operating frequency, MHz}) - 2833.3333$ .

So the field strength of emission limits have been calculated in below table.

Carrier Frequency (MHz)	Fundamental Emissions Limit (dBuV/m) at 3m
433.92 MHz	72.87 (Average)
433.92 MHz	92.87 (Peak)

**4.2.2. MEASURING INSTRUMENTS AND SETTING (FIELD STRENGTH OF FUNDAMENTAL EMISSIONS)**

Receiver Parameter	Setting
Attenuation	Auto
Center Frequency	Fundamental Frequency
RBW	120 kHz
Detector	Peak / Average



**4.2.3 RADIATED EMISSIONS MEASUREMENT**

Devices complying with 47 CFR FCC part 15 subpart C, section 15.231(e). The field strength of emissions from intentional radiators at 3 meters operated under this Section shall not exceed the following:

Frequency Band (MHz)	Spurious Emissions Limit (uV/m) at 3m
40.66-40.70	100
70-130	50
130-174	50-150(**)
174-260	150
260-470	150-500(**)
Above 470	500

\*\*1. Linear interpolations, the formulas for calculating the maximum permitted fundamental field strengths are as follows:

(1) for the band 130 - 174 MHz,  $\mu\text{V/m}$  at 3 meters =  $22.72727 \times (\text{operating frequency, MHz}) - 2454.545$ ;

(2) for the band 260 - 470 MHz,  $\mu\text{V/m}$  at 3 meters =  $16.6667 \times (\text{operating frequency, MHz}) - 2833.3333$ .

(3) The maximum permitted unwanted emissions level is 20 dB below the maximum permitted fundamental level. In addition field strength of any emissions which appear inside of the restriction band shall not exceed the general radiated emissions limits in Section 15.209(a).

Frequencies (MHz)	Field Strength (microrvolts/meter)	Measurement Distance (meters)
0.009~0.490	2400/F(KHz)	300
0.490~1.705	24000/F(KHz)	30
1.705~30.0	30	30
30~88	100	3
88~216	150	3
216~960	200	3
Above 960	500	3

Receiver Parameter	Setting
Attenuation	Auto
Start ~ Stop Frequency	9kHz~150kHz / RB 200Hz for QP
Start ~ Stop Frequency	150kHz~30MHz / RB 9kHz for QP
Start ~ Stop Frequency	30MHz~1000MHz / RB 120kHz for QP





Spectrum Parameter	Setting
Attenuation	Auto
Start Frequency	1000 MHz
Stop Frequency	10th carrier harmonic
RB / VB (emission in restricted band)	1MHz / 1MHz for Peak, AV Mode with Dwell time
RB / VB (other emission)	100KHz / 100KHz for peak

Dwell time=ON/ON+OFF

ON:(0.26ms\*25+0.45ms\*33+0.64ms\*4)=23.91msec

ON+OFF:(total time):100msec

Dwell time:23.91%

AV=PK+20 log(Dwell time)

AV=PK-12.43

**Note:**

If measures duty cycle with normal sample, the transmit time of the sample is too short (40ms) to catch signal , so we test with the continuous transmit sample, then you can see the test data of 100ms on test report

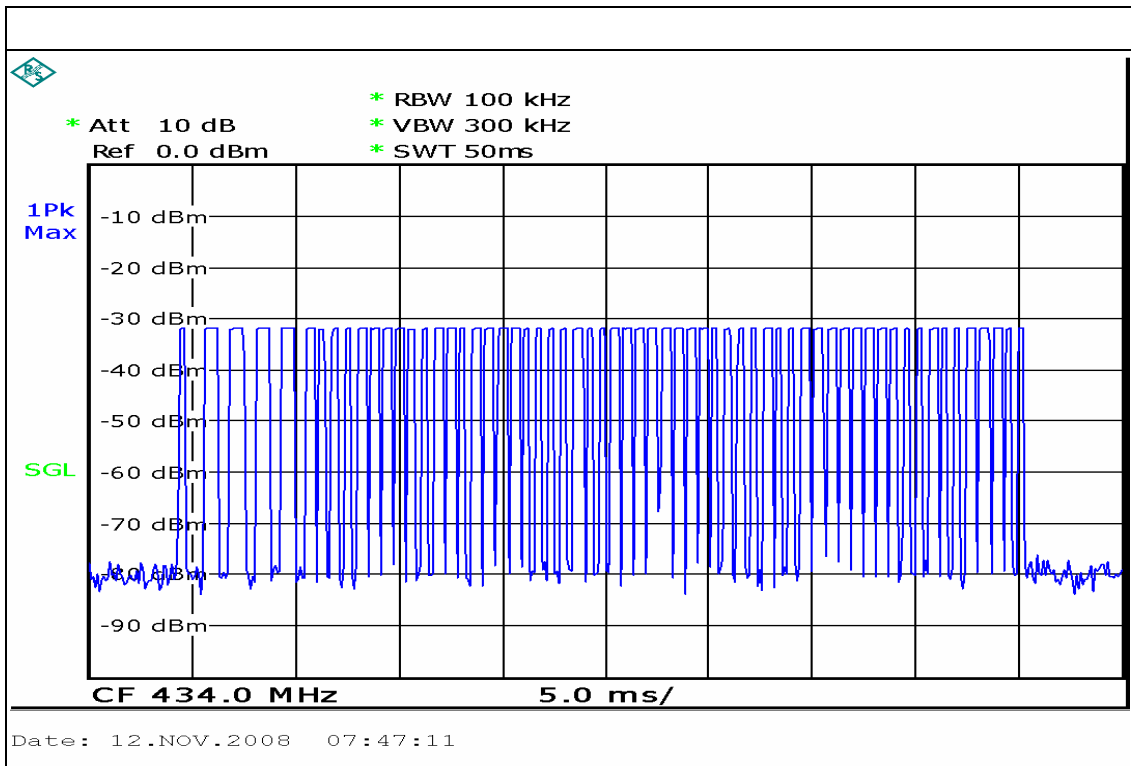



4.2.4. DWELL TIME OF PERIODIC OPERATION MEASUREMENT

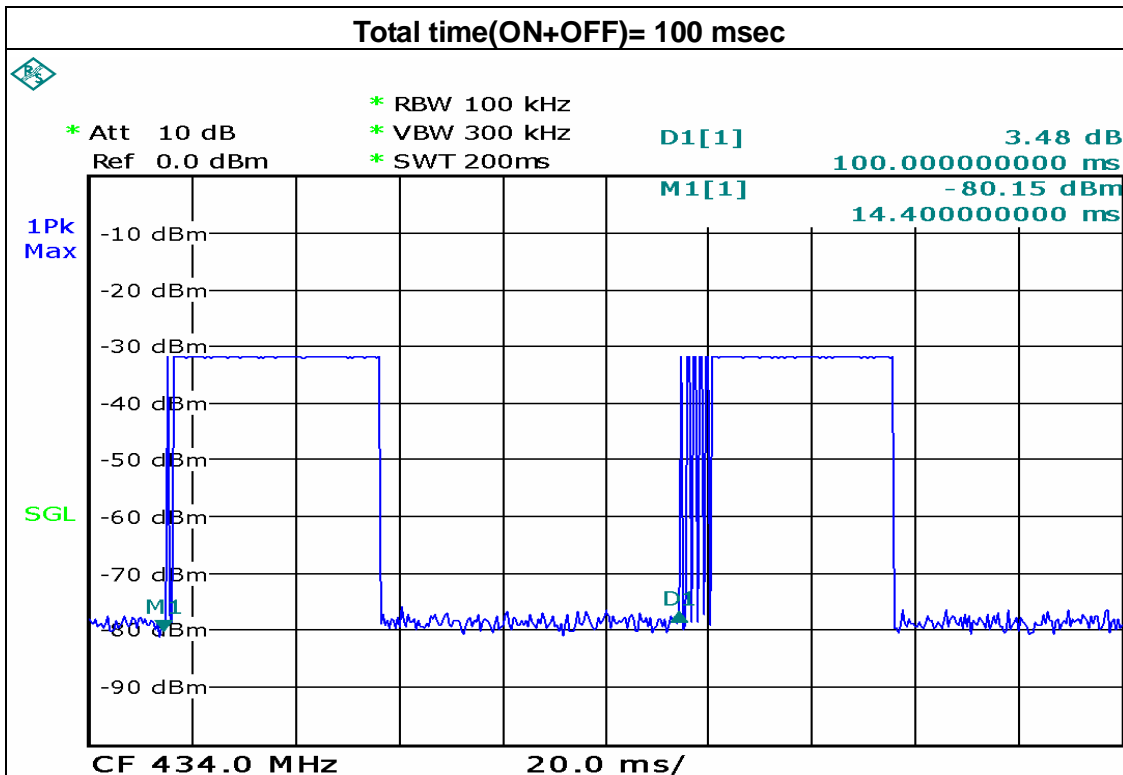

Date: 12.NOV.2008 07:46:29

**Actually ON time= 0.45\*33=14.85msec**

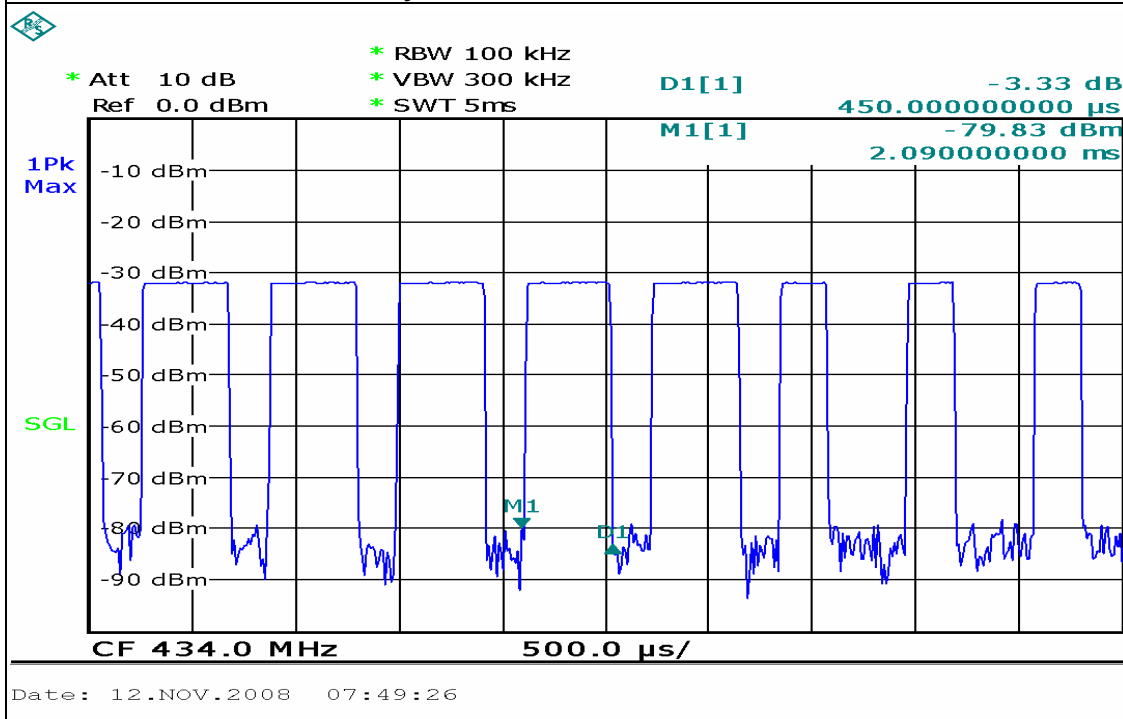

Date: 12.NOV.2008 07:49:26

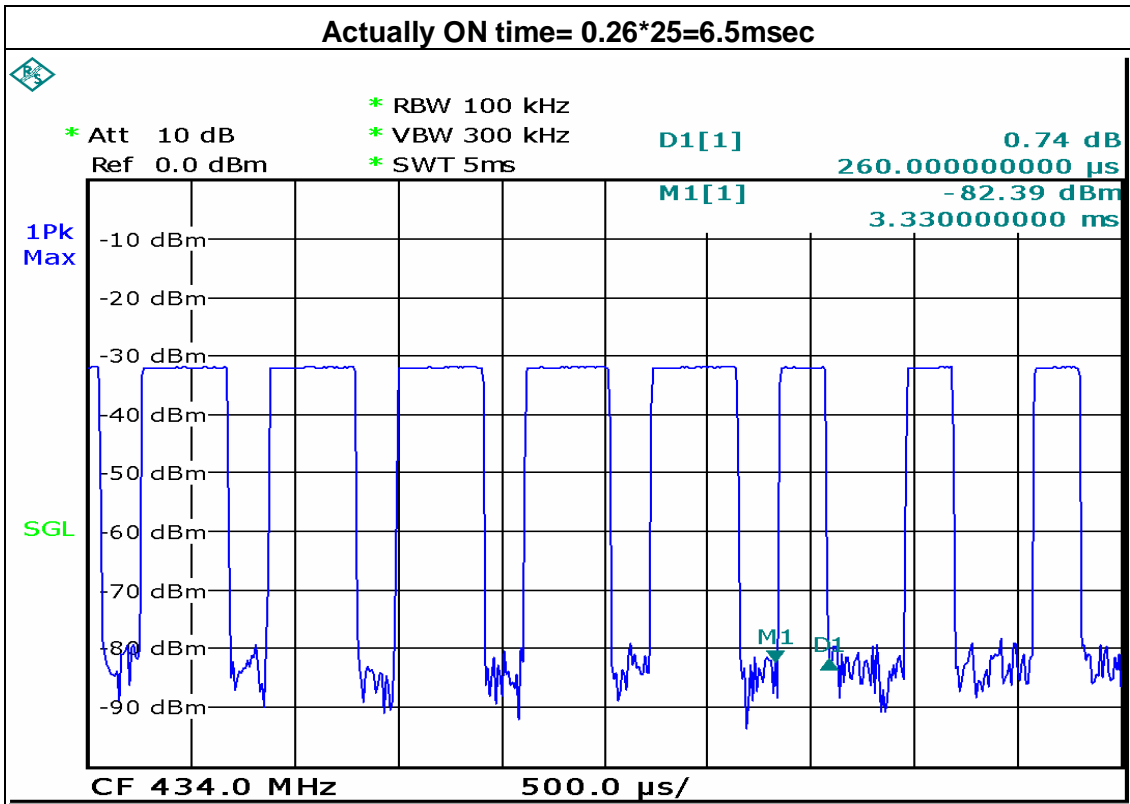

Date: 12.NOV.2008 07:49:57

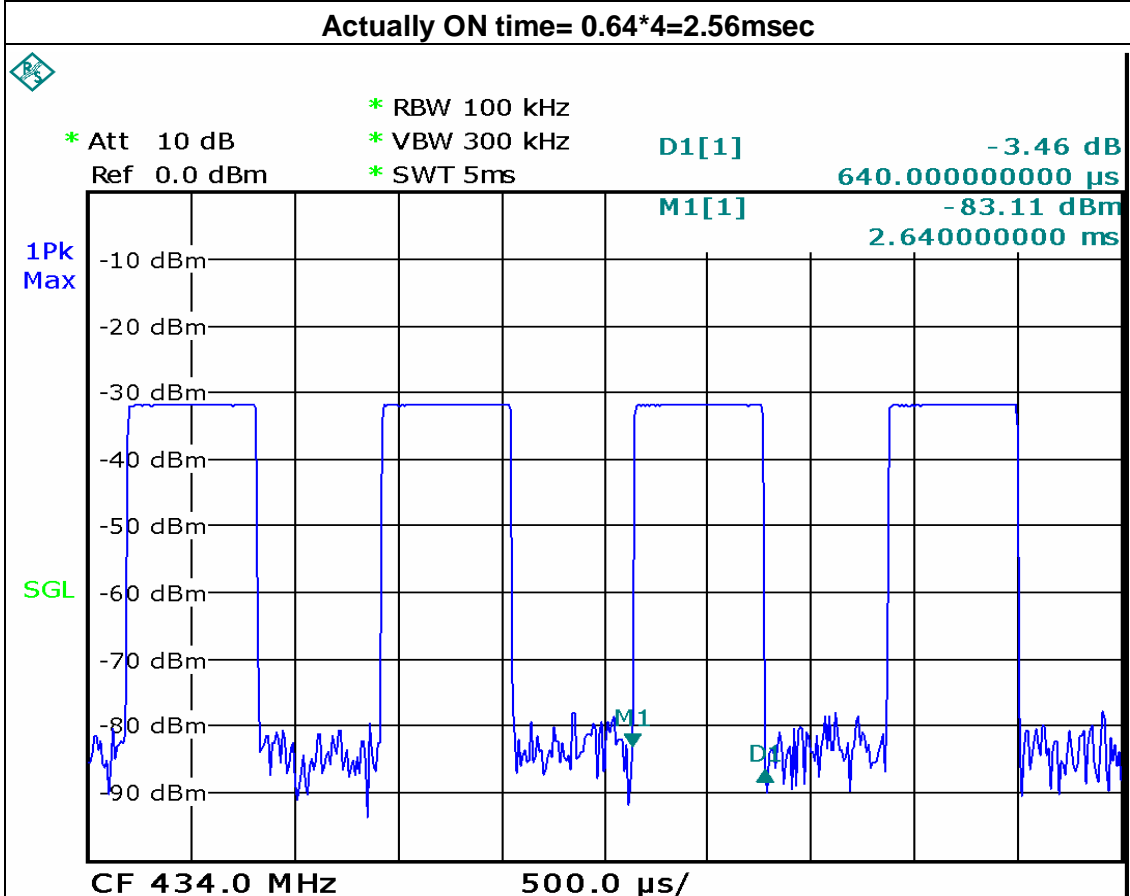

Date: 12.NOV.2008 07:50:37



**4.2.5. MEASUREMENT INSTRUMENTS LIST**

Item	Kind of Equipment	Manufacturer	Type No.	Serial No.	Calibrated until
1	Log-Bicon Antenna	Schwarzbeck	VULB 9160	3058	Nov. 27, 2008
2	Test Cable	N/A	10M_OS02	N/A	Nov. 27, 2008
3	Test Cable	N/A	OS02-1/-2/-3	N/A	Nov. 27, 2008
4	Pre-Amplifier	Anritsu	MH648A	M09961	Nov. 27, 2008
5	EMI Test Receiver	R&S	ESCI	100082	Jan. 30, 2009
6	Antenna Mast	Chance Most	CMTB-1.5	N/A	N/A
7	Turn Table	Chance Most	CMTB-1.5	N/A	N/A
8	Spectrum Analyzer	R&S	FSP_40	100129	Jan. 07, 2009
9	Horn Antenna	Schwarzbeck	BBHA9120D	9120D-325	Oct. 23, 2009
10	Horn Antenna	Schwarzbeck	BBHA9170	9170187	Oct. 23, 2009
11	Microwave Pre_amplifier	Agilent	8449B	3008A01714	Mar. 09, 2009
12	Microflex Cable	United Microwave	57793	1m	Mar. 09, 2009
13	Microflex Cable	United Microwave	A30A30-5006	10M	Jul. 06, 2009

Remark: " N/A" denotes No Model Name. / Serial No. and No Calibration specified.

**4.2.6. TEST PROCEDURE**

- a. The measuring distance of at 3 m shall be used for measurements at frequency up to 1GHz. For frequencies above 1GHz, any suitable measuring distance may be used.
- b. The EUT was placed on the top of a rotating table 0.8 meters above the ground at a 3m meter open area test site. The table was rotated 360 degrees to determine the position of the highest radiation.
- c. The height of the equipment or of the substitution antenna shall be 0.8 m; the height of the test antenna shall vary between 1 m to 4 m. Both horizontal and vertical polarizations of the antenna are set to make the measurement.
- d. The initial step in collecting conducted emission data is a spectrum analyzer peak detector mode pre-scanning the measurement frequency range. Significant peaks are then marked and then Quasi Peak detector mode re-measured.
- e. If the Peak Mode measured value compliance with and lower than Quasi Peak Mode Limit, the EUT shall be deemed to meet QP Limits and then no additional QP Mode measurement performed.
- f. For the actual test configuration, please refer to the related Item –EUT Test Photos.

**4.2.7. DEVIATION FROM TEST STANDARD**

No deviation

#### 4.2.8. TEST SETUP

(A) Radiated Emission Test Set-Up, Frequency Below 1000MHz

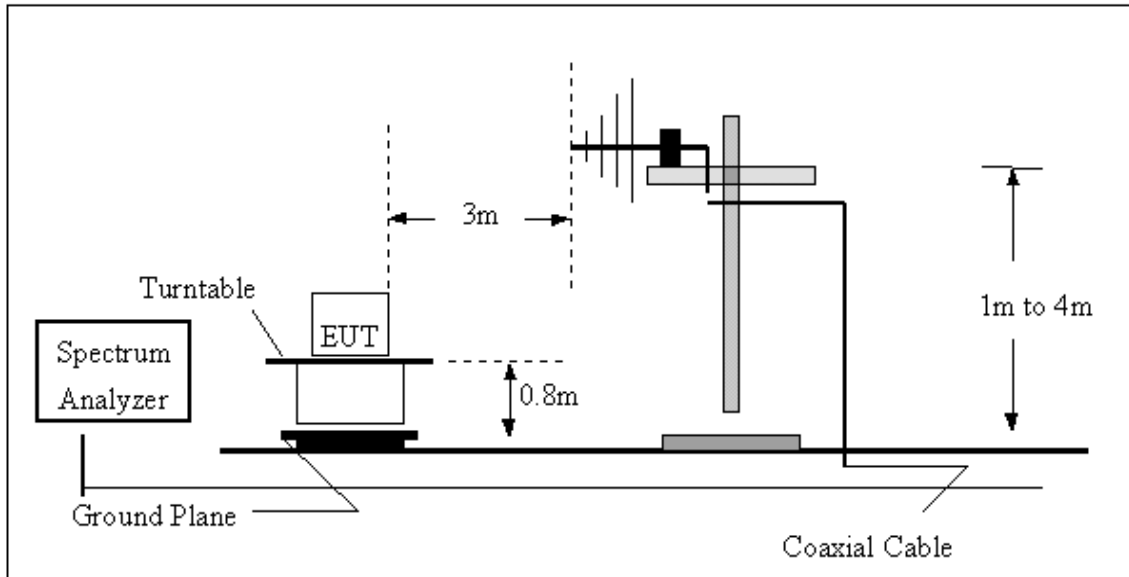

(B) Radiated Emission Test Set-Up Frequency Above 1 GHz

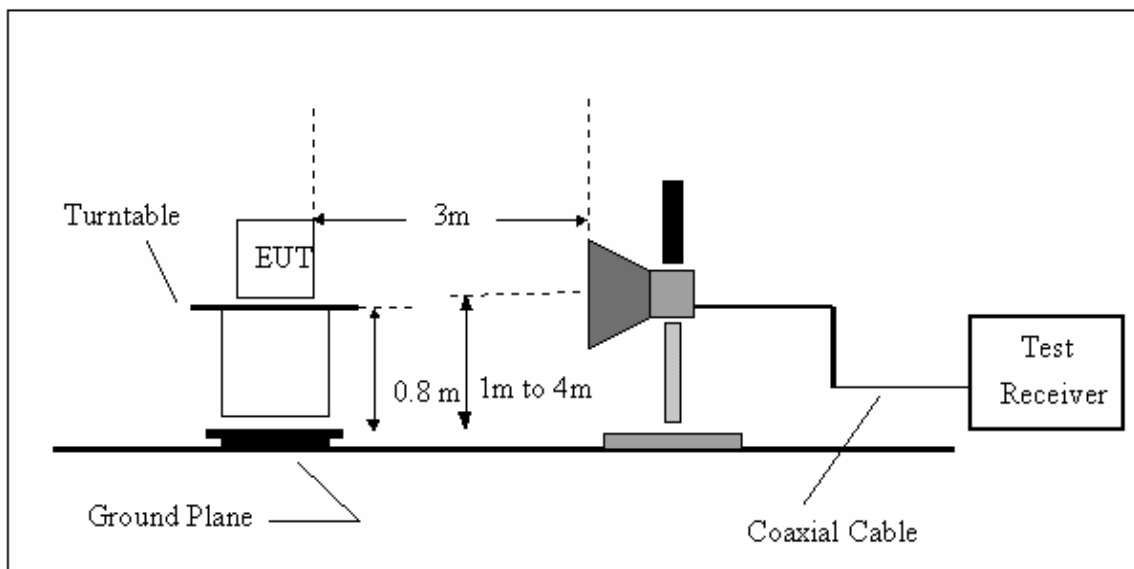

#### 4.2.9. EUT OPERATING CONDITIONS

The EUT tested system was configured as the statements of **4.1.6** Unless otherwise a special operating condition is specified in the follows during the testing.



4.3. TEST RESULTS (BETWEEN 30 – 1000 MHz)

EUT :	Temperature and humidity transmitter	Model Name. :	00611TX
Temperature :	26 °C	Relative Humidity :	60%
Pressure :	1010hPa	Test Power :	DC 3.0V
Test Mode :	TX Mode(Fundamental & Spurious)		
<b>About the duty cycle correction factor calculated, please refer to the page 17~19</b>			

Freq. (MHz)	Ant.Pol. H/V	Reading		Ant./CF CF(dB)	Act.		Limit		Result
		Peak (dBuV)	AV (dBuV)		Peak (dBuV/m)	AV (dBuV/m)	Peak (dBuV/m)	AV (dBuV/m)	
<b>433.96</b>	<b>V</b>	<b>70.44</b>	<b>58.01</b>	<b>-10.37</b>	<b>60.07</b>	<b>47.64</b>	<b>92.87</b>	<b>72.87</b>	<b>Z/F</b>
867.92	V	55.02	42.59	-1.65	53.37	40.94	72.87	52.87	Z/H

Remark :

- (1) All readings are Peak unless otherwise stated QP in column of 『Note 』 . Peak denotes that the Peak reading compliance with the QP Limits and then QP Mode measurement didn't perform .
- (2) Measuring frequency range from 30MHz to 1000MHz or the 10th harmonic of highest fundamental frequency . “F” denotes fundamental frequency; “ H” denotes spurious frequency. “E” denotes band edge frequency.
- (3) Radiated emissions measured in frequency range from 30 MHz to 1000 MHz were made with an instrument using Peak detector mode or QP detector mode of the emission .
- (4) Data of measurement within this frequency range shown “ - ” in the table above means the reading of emissions are attenuated more than 20dB below the permissible limits or the field strength is too small to be measured.
- (5) The average value of fundamental frequency is:  
Average = Peak value + 20log(Duty cycle) ∙ Final AV=PK-12.43



Orthogonal Axis : Z  
TX 433.92 MHz (Fundamental frequency, Vertical)

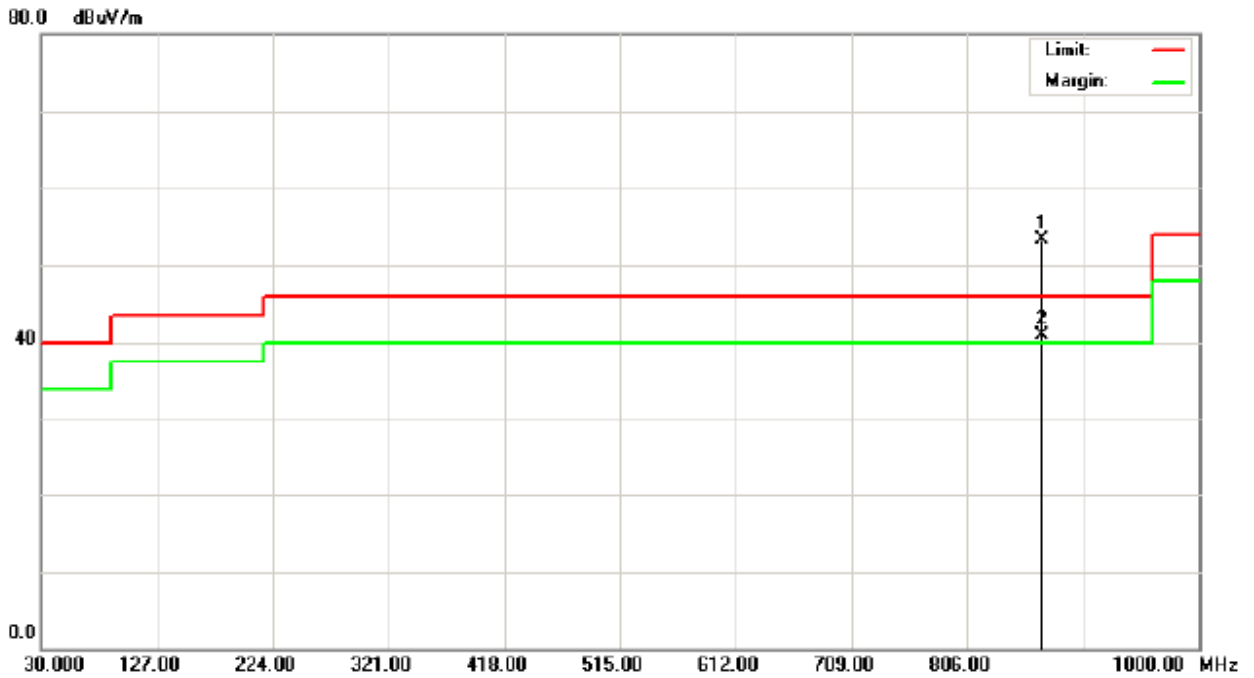
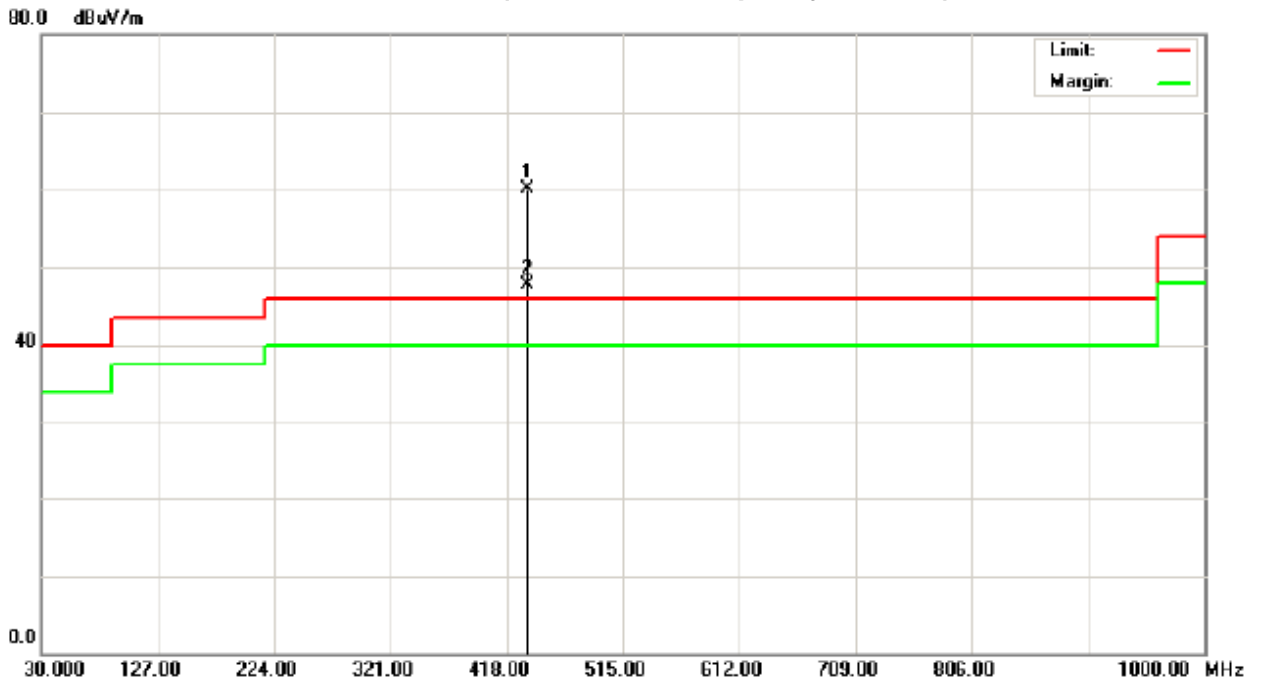



EUT :	Temperature and humidity transmitter	Model Name. :	00611TX
Temperature :	26 °C	Relative Humidity :	60 %
Pressure :	1010hPa	Test Power :	DC 3.0V
Test Mode :	TX Mode(Fundamental & Spurious)		

**About the duty cycle correction factor calculated, please refer to the page 17~19**

Freq. (MHz)	Ant.Pol. H/V	Reading		Ant./CF CF(dB)	Act.		Limit		Result
		Peak (dBuV)	AV (dBuV)		Peak (dBuV/m)	AV (dBuV/m)	Peak (dBuV/m)	AV (dBuV/m)	
<b>433.95</b>	<b>H</b>	<b>80.81</b>	<b>68.38</b>	<b>-10.37</b>	<b>70.44</b>	<b>58.01</b>	<b>92.87</b>	<b>72.87</b>	<b>Z/F</b>
867.92	H	55.68	43.25	-1.65	54.03	41.60	72.87	52.87	Z/F

**Remark :**

- (1) All readings are Peak unless otherwise stated QP in column of 『Note』 . Peak denotes that the Peak reading compliance with the QP Limits and then QP Mode measurement didn't perform .
- (2) Measuring frequency range from 30MHz to 1000MHz or the 10th harmonic of highest fundamental frequency . "F" denotes fundamental frequency; " H" denotes spurious frequency. "E" denotes band edge frequency.
- (3) Radiated emissions measured in frequency range from 30 MHz to 1000 MHz were made with an instrument using Peak detector mode or QP detector mode of the emission .
- (4) Data of measurement within this frequency range shown " - " in the table above means the reading of emissions are attenuated more than 20dB below the permissible limits or the field strength is too small to be measured.
- (5) The average value of fundamental frequency is:  
Average = Peak value + 20log(Duty cycle) ∙ Final AV=PK-12.43





Orthogonal Axis : Z  
TX 433.92 MHz (Fundamental frequency,Horizontal)

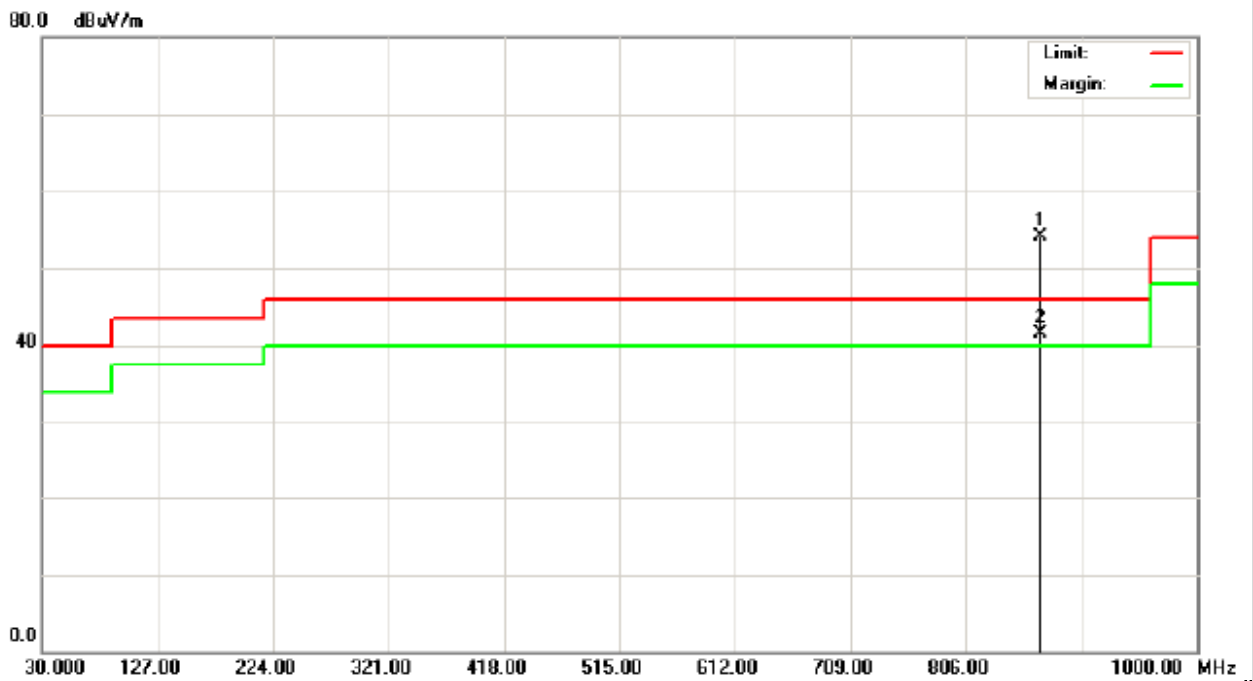
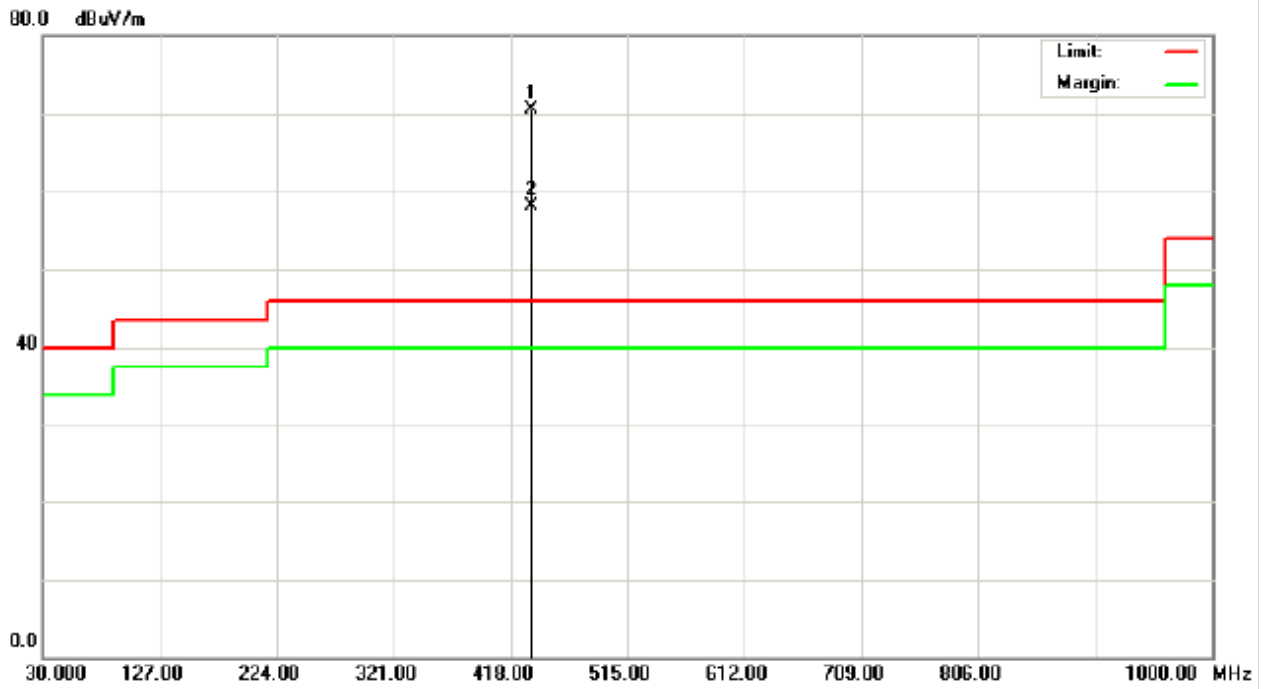



4.4 TEST RESULTS (ABOVE 1000 MHz)

EUT :	Temperature and humidity transmitter	Model Name. :	00611TX
Temperature :	26 °C	Relative Humidity :	60 %
Pressure :	1010hPa	Test Power :	DC 3.0V
Test Mode :	TX CH 433.92 MHz		

**About the duty cycle correction factor calculated, please refer to the page 17~19**

Freq. (MHz)	Ant.Pol. H/V	Reading		Ant./CF CF(dB)	Act.		Limit		Note
		Peak (dBuV)	AV (dBuV)		Peak (dBuV/m)	AV (dBuV/m)	Peak (dBuV/m)	AV (dBuV/m)	
1299.68	V	48.35	35.92	-6.02	42.33	29.90	74.00	54.00	Z/H

Remark :

- (1) All readings are Peak unless otherwise stated QP in column of 『Note』 . Peak denotes that the Peak reading compliance with the QP Limits and then QP Mode measurement didn't perform .
- (2) Measuring frequency range from 30MHz to 1000MHz or the 10th harmonic of highest fundamental frequency . "F" denotes fundamental frequency; "H" denotes spurious frequency. "E" denotes band edge frequency. (This judgment method includes the Band Edge Requirement.)
- (3) Radiated emissions measured in frequency range above 1000MHz were made with an instrument using Peak detector mode and AV detector mode of the emission .
- (4) The average value of fundamental frequency is:  
Average = Peak value + 20log(Duty cycle) · Final AV=PK-12.43
- (5) Data of measurement within this frequency range shown " \* " in the table above means the reading of emissions are attenuated more than 20dB below the permissible limits or the field strength is too small to be measured.
- (6) A preamp and high pass filter were used for this test in order to provide sufficient measurement sensitivity.
- (7) EUT Orthogonal Axis :  
"X" - denotes Laid on Table ; "Y" - denotes Vertical Stand ; "Z" - denotes Side Stand
- (8) During the measurements above 1 GHz it is taken care of that the EUT is always within the 3 dB cone of radiation BW of the used antenna

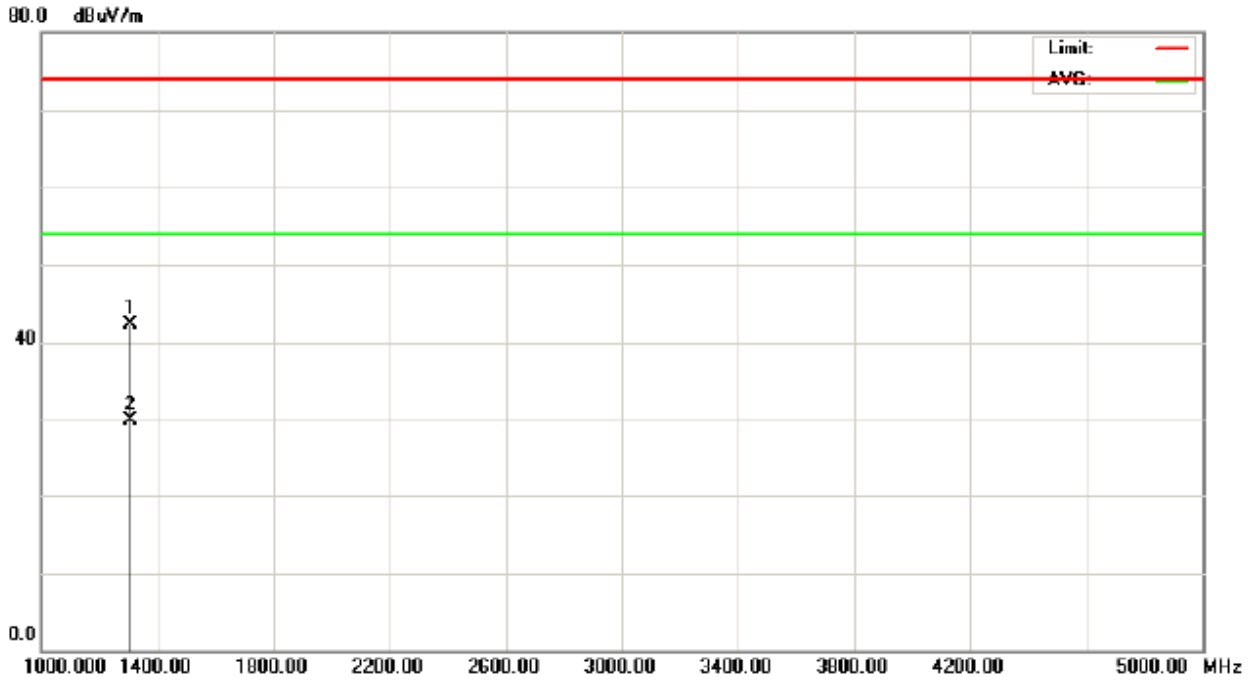



EUT :	Temperature and humidity transmitter	Model Name. :	00611TX
Temperature :	26 °C	Relative Humidity :	60 %
Pressure :	1010hPa	Test Power :	DC 3.0V
Test Mode :	TX CH 433.92 MHz		

**About the duty cycle correction factor calculated, please refer to the page 17~19**

Freq. (MHz)	Ant.Pol. H/V	Reading		Ant./CF CF(dB)	Act.		Limit		Note
		Peak (dBuV)	AV (dBuV)		Peak (dBuV/m)	AV (dBuV/m)	Peak (dBuV/m)	AV (dBuV/m)	
1299.68	H	53.35	40.92	-6.02	47.33	34.90	74.00	54.00	Z/H

**Remark :**

- (1) All readings are Peak unless otherwise stated QP in column of 『 Note 』 . Peak denotes that the Peak reading compliance with the QP Limits and then QP Mode measurement didn't perform .
- (2) Measuring frequency range from 30MHz to 1000MHz or the 10th harmonic of highest fundamental frequency . "F" denotes fundamental frequency; "H" denotes spurious frequency. "E" denotes band edge frequency. (This judgment method includes the Band Edge Requirement.)
- (3) Radiated emissions measured in frequency range above 1000MHz were made with an instrument using Peak detector mode and AV detector mode of the emission .
- (4) The average value of fundamental frequency is:  
Average = Peak value + 20log(Duty cycle) , Final AV=PK-12.43
- (5) Data of measurement within this frequency range shown " \* " in the table above means the reading of emissions are attenuated more than 20dB below the permissible limits or the field strength is too small to be measured.
- (6) A preamp and high pass filter were used for this test in order to provide sufficient measurement sensitivity.
- (7) EUT Orthogonal Axis :  
"X" - denotes Laid on Table ; "Y" - denotes Vertical Stand ; "Z" - denotes Side Stand
- (8) During the measurements above 1 GHz it is taken care of that the EUT is always within the 3 dB cone of radiation BW of the used antenna

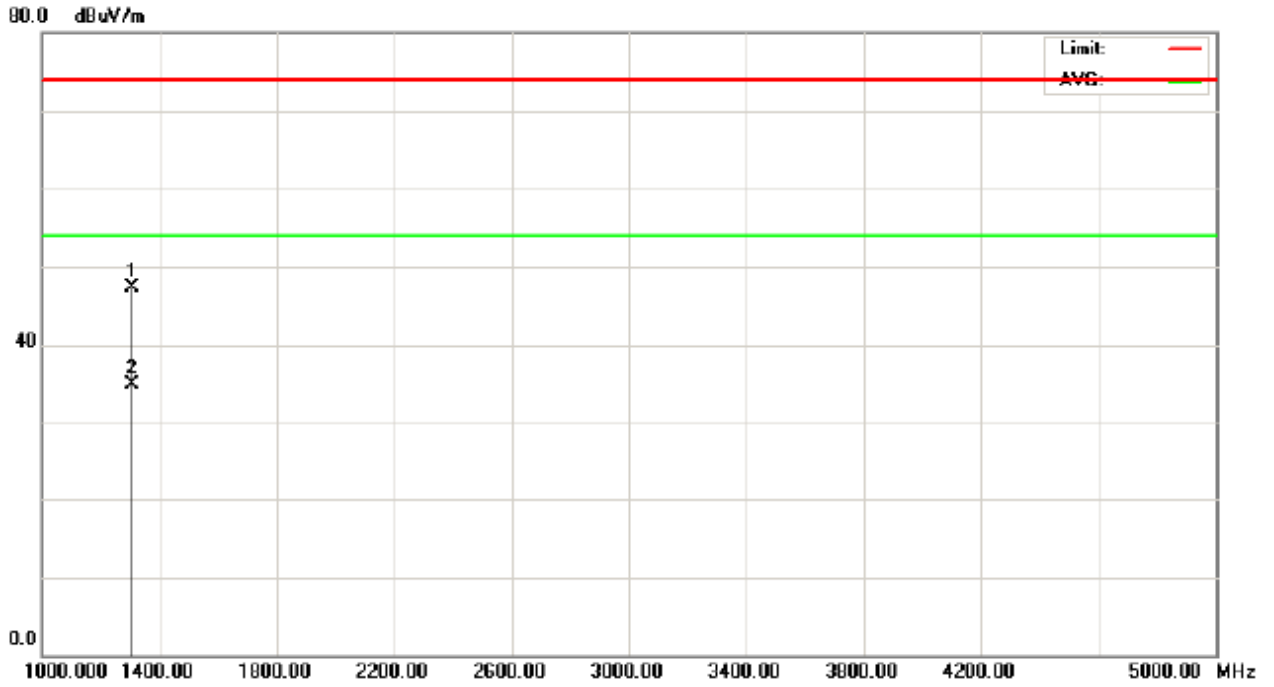

## 5. 20dB SPECTRUM BANDWIDTH MEASUREMENT

Limit

The bandwidth of the emissions shall be no wider than 0.25% of the center frequency for devices operating above 70 MHz and below 900 MHz. So the emission bandwidth limits have been calculated in below table.

Fundamental Frequency	20dB Bandwidth Limits (kHz)
433.92 MHz	108.48

### 5.1. MEASURING INSTRUMENTS AND SETTING

Please refer to section 5 in this report. The following table is the setting of the Spectrum Analyzer.

Spectrum Parameters	Setting
Attenuation	Auto
Span Frequency	> 20dB Bandwidth
RB	10 kHz
VB	10 kHz
Detector	Peak
Trace	Max Hold
Sweep Time	Auto

### 5.2. TEST PROCEDURES

1. The transmitter output (antenna port) was connected to the spectrum analyser in peak hold mode.
2. The resolution bandwidth of 10 kHz and the video bandwidth of 10 kHz were used.
3. Measured the spectrum width with power higher than 20dB below carrier.

### 5.3. TEST SETUP LAYOUT

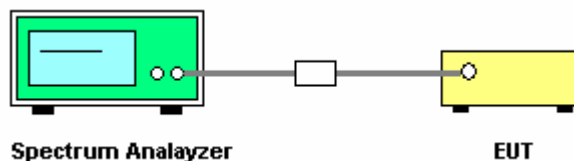

### 5.4. TEST DEVIATION

There is no deviation with the original standard.

### 5.5. EUT OPERATION DURING TEST

The EUT was programmed to be in continuously transmitting mode.



**5.6. TEST RESULT**

EUT :	Temperature and humidity transmitter	Model Name. :	00611TX
Temperature :	26°C	Relative Humidity :	60 %
Pressure :	1020 hPa	Test Power :	DC 3.0V
Test Mode :	TX CH 01		

Test Channel	Frequency (MHz)	20 dBc Bandwidth (KHz)	99% occupied Bandwidth(KHz)	Result
CH01	433.92	45.51	92.61	PASS

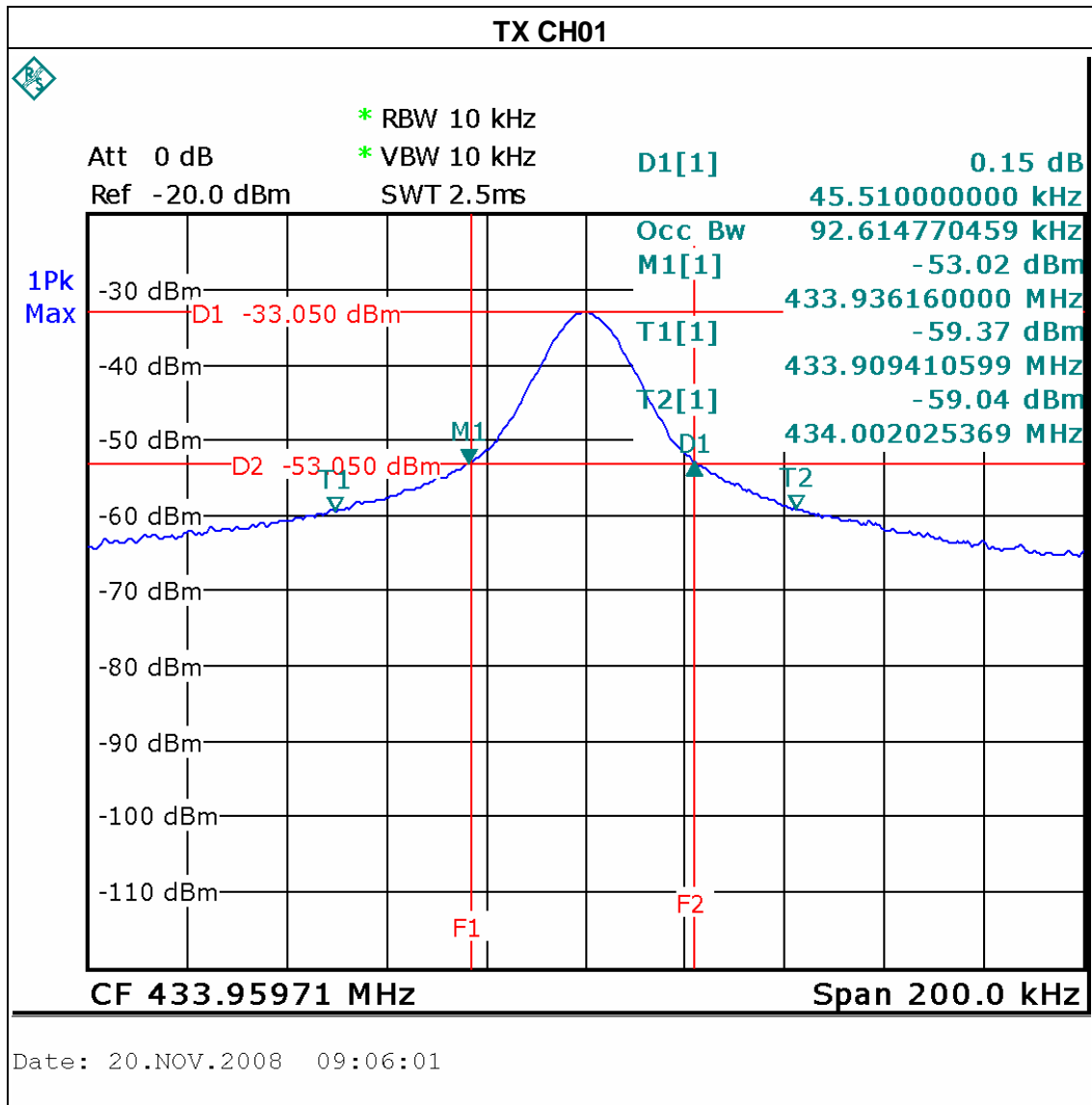

## 6. TIMING TESTING

Limit

In addition, devices operated under the provisions of this paragraph shall be provided with a means for automatically limiting operation so that the duration of each transmission shall not be greater than one second and the silent period between transmissions shall be at least 30 times the duration of the transmission but in no case less than 10 seconds.

### 6.1. MEASURING INSTRUMENTS AND SETTING

Please refer to section 6 in this report. The following table is the setting of the Spectrum Analyzer.

Spectrum Parameters	Setting
Attenuation	Auto
Span Frequency	Zero Span
RB	100KHz
VB	100KHz
Detector	Peak
Trace	Max Hold
Sweep Time	20 seconds

### 6.2. TEST PROCEDURES

1. The transmitter output (antenna port) was connected to the spectrum analyser in peak hold mode.
2. The resolution bandwidth of 0.1MHz and the video bandwidth of 0.1MHz were used.

### 6.3. TEST SETUP LAYOUT

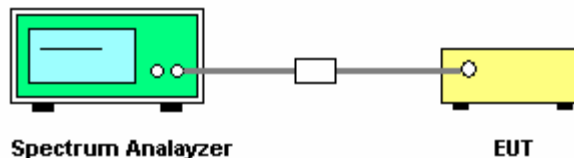

### 6.4. TEST DEVIATION

There is no deviation with the original standard.

### 6.5. EUT OPERATION DURING TEST

The EUT was programmed to be in normal mode.





6.6. TEST RESULT

EUT :	Temperature and humidity transmitter	Model Name. :	00611TX
Temperature :	26°C	Relative Humidity :	60 %
Pressure :	1020 hPa	Test Power :	DC 3.0V
Test Mode :	TX CH 01		

Test Channel	Frequency (MHz)	Transmission time (msec)	Silent period (seconds)	Result
CH01	433.92	16.73	> 10	PASS

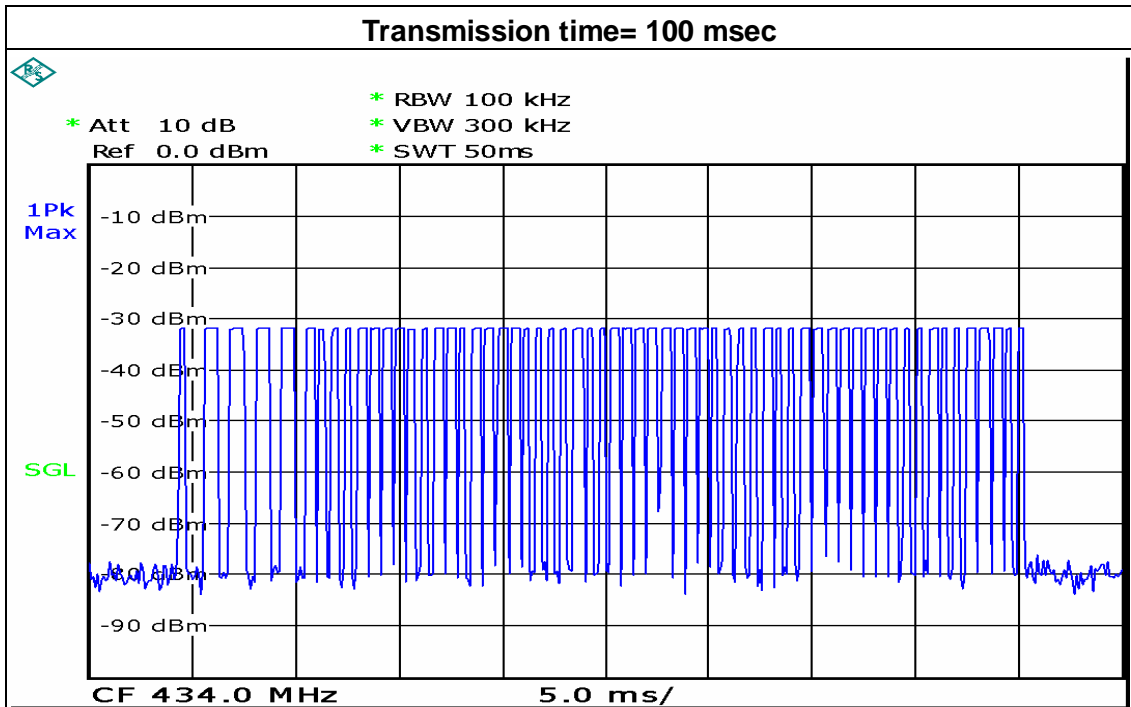

Date: 12.NOV.2008 07:47:11

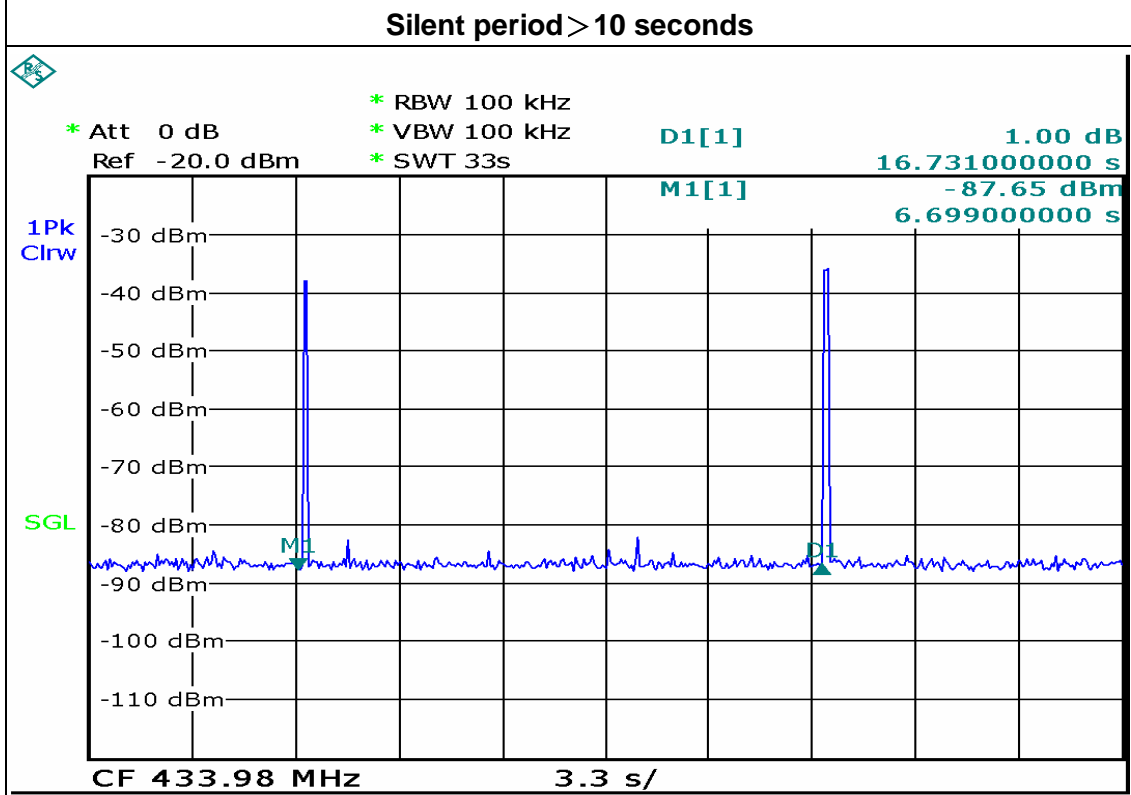

Date: 19.NOV.2008 07:53:31



**7. EUT TEST PHOTO**

**Radiated Measurement Photos  
TX Mode ~Orthogonal Axis : Z**

