



FCC RF Test Report

APPLICANT : Foxconn International Holdings Ltd.
EQUIPMENT : Data Card
BRAND NAME : AMBIT
MODEL NAME : NF2
MARKETING NAME : M.2 module
FCC ID : RYQ-NF2
STANDARD : FCC 47 CFR Part 2, 22(H), 24(E), 27(L)
CLASSIFICATION : PCS Licensed Transmitter (PCB)

The product was received on May 21, 2013 and completely tested on Jun. 10, 2013. We, SPORTON INTERNATIONAL INC., would like to declare that the tested sample has been evaluated in accordance with the procedures given in ANSI / TIA / EIA-603-C-2004 and shown compliance with the applicable technical standards.

The test results in this report apply exclusively to the tested model / sample. Without written approval of SPORTON INTERNATIONAL INC., the test report shall not be reproduced except in full.

Reviewed by: Joseph Lin / Supervisor

Approved by: Jones Tsai / Manager



SPORTON INTERNATIONAL INC.

No. 52, Hwa Ya 1st Rd., Hwa Ya Technology Park, Kwei-Shan Hsiang, Tao Yuan Hsien, Taiwan, R.O.C.



TABLE OF CONTENTS

REVISION HISTORY..... 3

SUMMARY OF TEST RESULT 4

1 GENERAL DESCRIPTION 5

 1.1 Applicant..... 5

 1.2 Manufacturer 5

 1.3 Feature of Equipment Under Test..... 5

 1.4 Product Specification of Equipment Under Test 6

 1.5 Modification of EUT 6

 1.6 Frequency Tolerance, and Emission Designator 7

 1.7 Testing Site..... 7

 1.8 Applied Standards 8

2 TEST CONFIGURATION OF EQUIPMENT UNDER TEST 9

 2.1 Test Mode..... 9

 2.2 Connection Diagram of Test System 11

 2.3 Support Unit used in test configuration and system 11

 2.4 Measurement Results Explanation Example 12

3 TEST RESULT 13

 3.1 Conducted Output Power Measurement..... 13

 3.2 Peak-to-Average Ratio 15

 3.3 Occupied Bandwidth and 26dB Bandwidth Measurement..... 31

 3.4 Band Edge Measurement..... 55

 3.5 Conducted Spurious Emission Measurement 70

 3.6 Field Strength of Spurious Radiation Measurement 89

 3.7 Frequency Stability Measurement..... 105

4 LIST OF MEASURING EQUIPMENTS..... 110

5 UNCERTAINTY OF EVALUATION 111

APPENDIX A. PHOTOGRAPHS OF EUT

APPENDIX B. SETUP PHOTOGRAPHS



SUMMARY OF TEST RESULT

| Report Section | FCC Rule | IC Rule | Description | Limit | Result | Remark |
|----------------|--|---|---|------------------------|--------|--|
| 3.1 | §2.1046 | RSS-132 (5.4) RSS-133 (6.4) RSS-139 (6.4) | Conducted Output Power | Reporting Only | PASS | - |
| 3.2 | §24.232(d) §27.50(d)(5) | RSS-132 (5.4) RSS-133(6.4) RSS-139 (6.4) | Peak-to-Average Ratio | < 13 dB | PASS | - |
| 3.3 | §2.1049 §22.917(a) §24.238(b) §27.53(g) | RSS-GEN(4.6.1) RSS-133(6.5) RSS-139 (6.5) | Occupied Bandwidth | Reporting Only | PASS | - |
| 3.4 | §2.1051 §22.917(a) §24.238(a) §27.53(g) | RSS-132 (5.5) RSS-133 (6.5) RSS-139 (6.5) | Band Edge Measurement | < 43+10log10(P[Watts]) | PASS | - |
| 3.5 | §2.1051 §22.917(a) §24.238(a) §27.53(g) | RSS-132 (5.5) RSS-133 (6.5) RSS-139 (6.5) | Conducted Emission | < 43+10log10(P[Watts]) | PASS | - |
| 3.6 | §2.1053 §22.917(a) §24.238(a) §27.53(g) | RSS-132 (5.5) RSS-133 (6.5) RSS-139 (6.5) | Field Strength of Spurious Radiation | < 43+10log10(P[Watts]) | PASS | Under limit 17.39 dB at 2509 MHz |
| 3.7 | §2.1055 §22.355 §24.235 §27.54 | RSS-132 (5.3) RSS-133 (6.3) RSS-139 (6.3) | Frequency Stability for Temperature & Voltage | < 2.5 ppm | PASS | - |



1 General Description

1.1 Applicant

Foxconn International Holdings Ltd.

No. 4, Mingsheng St., Tu-Cheng Dist., New Taipei City 23679, Taiwan

1.2 Manufacturer

Foxconn International Holdings Ltd.

No. 4, Mingsheng St., Tu-Cheng Dist., New Taipei City 23679, Taiwan

1.3 Feature of Equipment Under Test

| Product Feature | |
|---------------------------------|---------------------------|
| Equipment | Data Card |
| Brand Name | AMBIT |
| Model Name | NF2 |
| Marketing Name | M.2 module |
| FCC ID | RYQ-NF2 |
| EUT supports Radios application | GSM/EGPRS/WCDMA/HSPA/LTE/ |
| HW Version | PR3.2 |
| SW Version | FIH7160_MODEM_01.1326.00 |
| EUT Stage | Production Unit |

Remark: The above EUT's information was declared by manufacturer. Please refer to the specifications or user's manual for more detailed description.

1.4 Product Specification of Equipment Under Test

| Product Specification subjective to this standard | |
|---|--|
| Tx Frequency | GSM850: 824.2 MHz ~ 848.8 MHz GSM1900: 1850.2 MHz ~ 1909.8MHz WCDMA Band V: 826.4 MHz ~ 846.6 MHz WCDMA Band IV : 1712.4 MHz ~ 1752.6 MHz WCDMA Band II: 1852.4 MHz ~ 1907.6 MHz |
| Rx Frequency | GSM850: 869.2 MHz ~ 893.8 MHz GSM1900: 1930.2 MHz ~ 1989.8 MHz WCDMA Band V: 871.4 MHz ~ 891.6 MHz WCDMA Band IV : 2112.4 MHz ~ 2152.6 MHz WCDMA Band II : 1932.4 MHz ~ 1987.6 MHz |
| Maximum Output Power to Antenna | GSM850 : 32.92 dBm GSM1900 : 29.80 dBm WCDMA Band V : 23.66 dBm WCDMA Band IV : 23.75 dBm WCDMA Band II : 24.16 dBm |
| Type of Modulation | GPRS: GMSK EDGE: GMSK / 8PSK WCDMA: QPSK (Uplink) HSDPA: QPSK (Uplink) HSUPA: QPSK (Uplink) |

1.5 Modification of EUT

No modifications are made to the EUT during all test items.

1.6 Frequency Tolerance, and Emission Designator

| FCC Rule | System | Type of Modulation | Frequency Tolerance (% , Hz, ppm) | Emission Designator |
|----------|----------------------------|--------------------|-----------------------------------|---------------------|
| Part 22 | GSM850 GPRS class 8 | GMSK | 0.02 ppm | 246KGXW |
| Part 22 | GSM850 EDGE class 8 | 8PSK | 0.02 ppm | 250KG7W |
| Part 22 | WCDMA Band V RMC 12.2kbps | QPSK | 0.01 ppm | 4M14F9W |
| Part 24 | GSM1900 GPRS class 8 | GMSK | 0.01 ppm | 248KGXW |
| Part 24 | GSM1900 EDGE class 8 | 8PSK | 0.01 ppm | 254KG7W |
| Part 24 | WCDMA Band II RMC 12.2kbps | QPSK | 0.01 ppm | 4M10F9W |
| Part 27 | WCDMA Band IV RMC 12.2kbps | QPSK | 0.01 ppm | 5M08F9W |

1.7 Testing Site

| | | | |
|---------------------------|---|-----------|--------------------------------|
| Test Site | SPORTON INTERNATIONAL INC. | | |
| Test Site Location | No. 52, Hwa Ya 1 st Rd., Hwa Ya Technology Park, Kwei-Shan Hsiang, Tao Yuan Hsien, Taiwan, R.O.C. TEL: +886-3-327-3456 FAX: +886-3-328-4978 | | |
| Test Site No. | Sporton Site No. | | FCC/IC Registration No. |
| | TH02-HY | 03CH07-HY | 722060/4086B-1 |



1.8 Applied Standards

According to the specifications of the manufacturer, the EUT must comply with the requirements of the following standards:

- ♦ 47 CFR Part 2, 22(H), 24(E), 27(L)
- ♦ ANSI / TIA / EIA-603-C-2004

Remark:

1. All test items were verified and recorded according to the standards and without any deviation during the test.
2. This EUT has also been tested and complied with the requirements of FCC Part 15, Subpart B, recorded in a separate test report.

2 Test Configuration of Equipment Under Test

2.1 Test Mode

During all testing, EUT is in link mode with base station emulator at maximum power level. The spurious emission measurements were carried out in semi-anechoic chamber with 3-meter test range

Frequency range investigated for radiated emission is as follows:

1. 30 MHz to 9000 MHz for GSM850 and WCDMA Band V.
2. 30 MHz to 18000 MHz for WCDMA Band IV.
3. 30 MHz to 19000 MHz for GSM1900 and WCDMA Band II.

| Test Modes | | |
|---------------|--|--|
| Band | Radiated TCs | Conducted TCs |
| GSM 850 | <ul style="list-style-type: none"> ■ GPRS class 8 Link ■ EDGE class 8 Link | <ul style="list-style-type: none"> ■ GPRS class 8 Link ■ EDGE class 8 Link |
| GSM 1900 | <ul style="list-style-type: none"> ■ GPRS class 8 Link ■ EDGE class 8 Link | <ul style="list-style-type: none"> ■ GPRS class 8 Link ■ EDGE class 8 Link |
| WCDMA Band V | <ul style="list-style-type: none"> ■ RMC 12.2kbps Link | <ul style="list-style-type: none"> ■ RMC 12.2kbps Link |
| WCDMA Band IV | <ul style="list-style-type: none"> ■ RMC 12.2kbps Link | <ul style="list-style-type: none"> ■ RMC 12.2kbps Link |
| WCDMA Band II | <ul style="list-style-type: none"> ■ RMC 12.2kbps Link | <ul style="list-style-type: none"> ■ RMC 12.2kbps Link |

Note: The maximum power levels are GPRS multi-slot class 8 mode for GMSK link, EDGE multi-slot class 8 mode for 8PSK link, RMC 12.2kbps mode for WCDMA band V, RMC 12.2kbps mode for WCDMA band IV, and RMC 12.2kbps mode for WCDMA band II, only these modes were used for all tests.

The conducted power tables are as follows:

| Conducted Power (*Unit: dBm) | | | | | | |
|------------------------------|--------|-------|-------|---------|-------|--------|
| Band | GSM850 | | | GSM1900 | | |
| Channel | 128 | 189 | 251 | 512 | 661 | 810 |
| Frequency | 824.2 | 836.4 | 848.8 | 1850.2 | 1880 | 1909.8 |
| GPRS class 8 | 32.77 | 32.89 | 32.92 | 29.78 | 29.80 | 29.72 |
| GPRS class 10 | 32.64 | 32.70 | 32.75 | 29.77 | 29.79 | 29.71 |
| GPRS class 11 | 32.04 | 32.28 | 32.38 | 28.96 | 28.99 | 28.93 |
| GPRS class 12 | 30.66 | 31.03 | 31.06 | 27.66 | 27.70 | 27.65 |
| EGPRS class 8 | 26.96 | 26.87 | 26.90 | 25.95 | 26.06 | 26.20 |
| EGPRS class 10 | 26.93 | 26.84 | 26.86 | 25.94 | 26.04 | 26.18 |
| EGPRS class 11 | 25.97 | 25.87 | 25.94 | 25.21 | 25.31 | 25.50 |
| EGPRS class 12 | 24.67 | 24.58 | 24.61 | 24.03 | 24.15 | 24.26 |

| Conducted Power (*Unit: dBm) | | | | | | | | | |
|------------------------------|--------------|-------|-------|---------------|-------|--------|---------------|--------|--------|
| Band | WCDMA Band V | | | WCDMA Band II | | | WCDMA Band IV | | |
| Tx Channel | 4132 | 4182 | 4233 | 9262 | 9400 | 9538 | 1312 | 1413 | 1513 |
| Rx Channel | 4357 | 4407 | 4458 | 9662 | 9800 | 9938 | 1537 | 1638 | 1738 |
| Frequency | 826.4 | 836.4 | 846.6 | 1852.4 | 1880 | 1907.6 | 1712.4 | 1732.6 | 1752.6 |
| RMC 12.2K | 23.50 | 23.44 | 23.66 | 24.16 | 23.97 | 23.98 | 23.56 | 23.75 | 23.57 |
| HSDPA Subtest-1 | 23.48 | 23.42 | 23.65 | 24.15 | 23.96 | 23.97 | 23.50 | 23.74 | 23.52 |
| HSDPA Subtest-2 | 23.46 | 23.41 | 23.63 | 24.05 | 23.93 | 23.98 | 23.46 | 23.20 | 23.12 |
| HSDPA Subtest-3 | 22.41 | 22.38 | 22.47 | 22.96 | 22.77 | 22.78 | 22.71 | 22.70 | 23.09 |
| HSDPA Subtest-4 | 22.40 | 22.37 | 22.46 | 22.95 | 22.76 | 22.77 | 22.81 | 22.60 | 22.78 |
| HSUPA Subtest-1 | 22.36 | 22.29 | 22.19 | 23.08 | 22.72 | 22.94 | 23.08 | 23.14 | 23.03 |
| HSUPA Subtest-2 | 20.25 | 20.18 | 20.03 | 21.75 | 21.52 | 21.56 | 21.05 | 21.02 | 20.85 |
| HSUPA Subtest-3 | 21.21 | 21.10 | 21.08 | 22.23 | 22.05 | 22.18 | 21.98 | 22.04 | 21.91 |
| HSUPA Subtest-4 | 20.25 | 20.17 | 20.10 | 21.69 | 21.39 | 21.40 | 21.30 | 21.25 | 21.15 |
| HSUPA Subtest-5 | 22.86 | 22.80 | 22.72 | 23.68 | 23.14 | 23.38 | 23.56 | 23.70 | 23.55 |

2.2 Connection Diagram of Test System

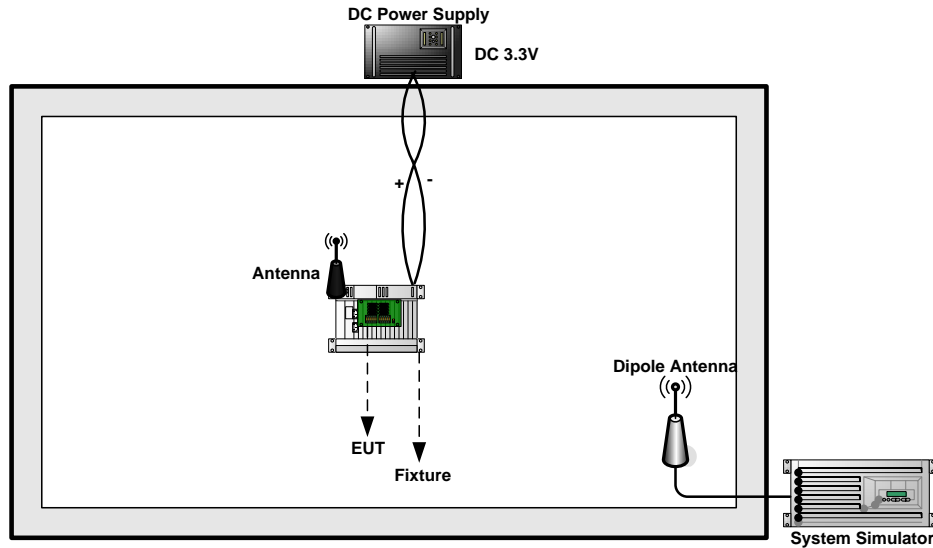

2.3 Support Unit used in test configuration and system

| Item | Equipment | Trade Name | Model No. | FCC ID | Data Cable | Power Cord |
|------|------------------|------------|-------------------|--------|------------|-------------------|
| 1. | Power Supply | GWINSTEK | PSS-2002 | N/A | N/A | Unshielded, 1.8 m |
| 2. | System Simulator | R&S | CMU200 | N/A | N/A | Unshielded, 1.8 m |
| 3. | Fixture | INTEL | NGFF Card Carrier | N/A | N/A | N/A |



2.4 Measurement Results Explanation Example

For all conducted test items:

The offset level is set in the spectrum analyzer to compensate the RF cable loss and attenuator factor between EUT conducted output port and spectrum analyzer. With the offset compensation, the spectrum analyzer reading level is exactly the EUT RF output level.

The spectrum analyzer offset is derived from RF cable loss and attenuator factor.

Offset = RF cable loss + attenuator factor.

Following shows an offset computation example with cable loss 4.2 dB and 10dB attenuator.

Example :

$$\begin{aligned} \text{Offset(dB)} &= \text{RF cable loss(dB)} + \text{attenuator factor(dB)}. \\ &= 4.2 + 10 = 14.2 \text{ (dB)} \end{aligned}$$

3 Test Result

3.1 Conducted Output Power Measurement

3.1.1 Description of the Conducted Output Power

A base station simulator was used to establish communication with the EUT. Its parameters were set to transmit the maximum power on the EUT. The measured power in the radio frequency on the transmitter output terminals shall be reported.

3.1.2 Measuring Instruments

See list of measuring instruments of this test report.

3.1.3 Test Procedures

1. The transmitter output port was connected to base station.
2. The RF output of EUT was connected to the spectrum analyzer by RF cable and attenuator. The path loss was compensated to the results for each measurement.
3. Set EUT at maximum power through base station.
4. Select lowest, middle, and highest channels for each band and different modulation.
5. Measure the maximum burst average power for GSM, EDGE.
6. Measure maximum average power for WCDMA.

3.1.4 Test Setup

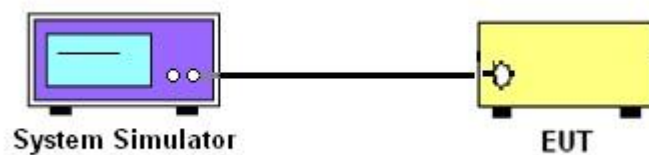



3.1.5 Test Result of Conducted Output Power

| Cellular Band | | | | | | | | | |
|-------------------------|-----------------------|-----------|------------|-----------------------|-----------|------------|-----------------------------|------------|-------------|
| Modes | GSM850 (GPRS class 8) | | | GSM850 (EDGE class 8) | | | WCDMA Band V (RMC 12.2kbps) | | |
| Channel | 128 (Low) | 189 (Mid) | 251 (High) | 128 (Low) | 189 (Mid) | 251 (High) | 4132 (Low) | 4182 (Mid) | 4233 (High) |
| Frequency (MHz) | 824.2 | 836.4 | 848.8 | 824.2 | 836.4 | 848.8 | 826.4 | 836.4 | 846.6 |
| Conducted Power (dBm) | 32.77 | 32.89 | 32.92 | 26.96 | 26.87 | 26.90 | 23.50 | 23.44 | 23.66 |
| Conducted Power (Watts) | 1.89 | 1.95 | 1.96 | 0.50 | 0.49 | 0.49 | 0.22 | 0.22 | 0.23 |

| PCS Band | | | | | | | | | |
|-------------------------|------------------------|-----------|------------|------------------------|-----------|------------|------------------------------|------------|-------------|
| Modes | GSM1900 (GPRS class 8) | | | GSM1900 (EDGE class 8) | | | WCDMA Band II (RMC 12.2kbps) | | |
| Channel | 512 (Low) | 661 (Mid) | 810 (High) | 512 (Low) | 661 (Mid) | 810 (High) | 9262 (Low) | 9400 (Mid) | 9538 (High) |
| Frequency (MHz) | 1850.2 | 1880 | 1909.8 | 1850.2 | 1880 | 1909.8 | 1852.4 | 1880 | 1907.6 |
| Conducted Power (dBm) | 29.78 | 29.80 | 29.72 | 25.95 | 26.06 | 26.20 | 24.16 | 23.97 | 23.98 |
| Conducted Power (Watts) | 0.95 | 0.95 | 0.94 | 0.39 | 0.40 | 0.42 | 0.26 | 0.25 | 0.25 |

| AWS Band | | | |
|-------------------------|------------------------------|------------|-------------|
| Modes | WCDMA Band IV (RMC 12.2kbps) | | |
| Channel | 1312(Low) | 1413 (Mid) | 1513 (High) |
| Frequency (MHz) | 1712.4 | 1732.6 | 1752.6 |
| Conducted Power (dBm) | 23.56 | 23.75 | 23.57 |
| Conducted Power (Watts) | 0.23 | 0.24 | 0.23 |

Note: maximum burst average power for GPRS, and maximum average power for WCDMA.

3.2 Peak-to-Average Ratio

3.2.1 Description of the PAR Measurement

The peak-to-average ratio (PAR) of the transmission may not exceed 13 dB.

3.2.2 Measuring Instruments

See list of measuring instruments of this test report.

3.2.3 Test Procedures

1. The EUT was connected to Spectrum Analyzer and System Simulator via power divider.
2. For GSM/EGPRS operating modes:
 - a. Set EUT in maximum power output.
 - b. Set the RBW = 1MHz, VBW = 3MHz, Peak detector in spectrum analyzer for first trace.
 - c. Set the RBW = 1MHz, VBW = 3MHz, RMS detector in spectrum analyzer for second trace.
 - d. The wanted burst signal is triggered by spectrum analyzer, and measured respectively the peak level and Mean level without burst-off time, after system simulator synchronized with the spectrum analyzer.
3. For UMTS operating modes:
 - a. Set the CCDF (Complementary Cumulative Distribution Function) option in spectrum analyzer.
 - b. The highest RF powers were measured and recorded the maximum PAPR level associated with a probability of 0.1 %.
4. Record the deviation as Peak to Average Ratio.

3.2.4 Test Setup

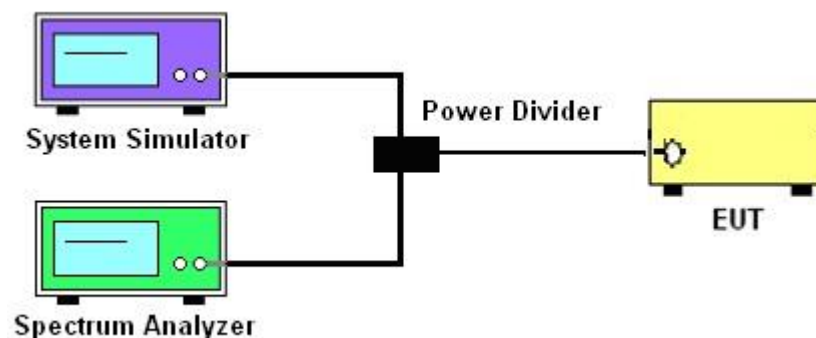

3.2.5 Test Result of Peak-to-Average Ratio

| Cellular Band | | | | | | | | | |
|----------------------------|-----------------------|-----------|------------|-----------------------|-----------|------------|-----------------------------|------------|-------------|
| Modes | GSM850 (GPRS class 8) | | | GSM850 (EDGE class 8) | | | WCDMA Band V (RMC 12.2kbps) | | |
| Channel | 128 (Low) | 189 (Mid) | 251 (High) | 128 (Low) | 189 (Mid) | 251 (High) | 4132 (Low) | 4182 (Mid) | 4233 (High) |
| Frequency (MHz) | 824.2 | 836.4 | 848.8 | 824.2 | 836.4 | 848.8 | 826.4 | 836.4 | 846.6 |
| Peak-to-Average Ratio (dB) | 0.38 | 0.37 | 0.34 | 2.52 | 2.47 | 2.38 | 1.88 | 2.48 | 2.16 |

| PCS Band | | | | | | | | | |
|----------------------------|------------------------|-----------|------------|------------------------|-----------|------------|------------------------------|------------|-------------|
| Modes | GSM1900 (GPRS class 8) | | | GSM1900 (EDGE class 8) | | | WCDMA Band II (RMC 12.2kbps) | | |
| Channel | 512 (Low) | 661 (Mid) | 810 (High) | 512 (Low) | 661 (Mid) | 810 (High) | 9262 (Low) | 9400 (Mid) | 9538 (High) |
| Frequency (MHz) | 1850.2 | 1880 | 1909.8 | 1850.2 | 1880 | 1909.8 | 1852.4 | 1880 | 1907.6 |
| Peak-to-Average Ratio (dB) | 0.23 | 0.23 | 0.22 | 2.26 | 2.34 | 2.40 | 2.88 | 2.00 | 2.44 |

| AWS Band | | | |
|----------------------------|------------------------------|------------|-------------|
| Modes | WCDMA Band IV (RMC 12.2kbps) | | |
| Channel | 1312(Low) | 1413 (Mid) | 1513 (High) |
| Frequency (MHz) | 1712.4 | 1732.6 | 1752.6 |
| Peak-to-Average Ratio (dB) | 1.80 | 2.84 | 1.88 |



3.2.6 Test Result (Plots) of Peak-to-Average Ratio

| | | | |
|--------|---------|-------------|--------------------------|
| Band : | GSM 850 | Test Mode : | GPRS class 8 Link (GMSK) |
|--------|---------|-------------|--------------------------|

Peak-to-Average Ratio on Channel 128 (824.2 MHz)

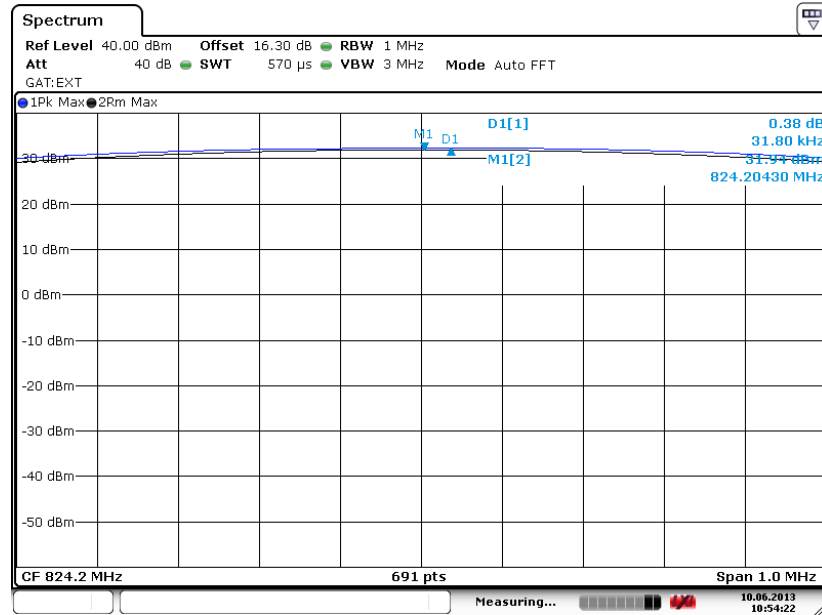

Date: 10.JUN.2013 10:54:21

Peak-to-Average Ratio on Channel 189 (836.4 MHz)

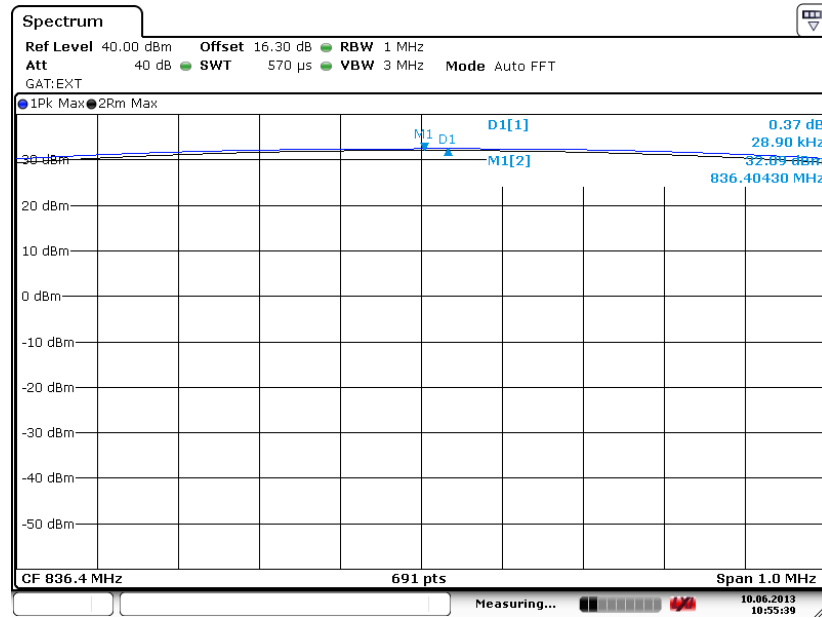

Date: 10.JUN.2013 10:55:39



Peak-to-Average Ratio on Channel 251 (848.8 MHz)

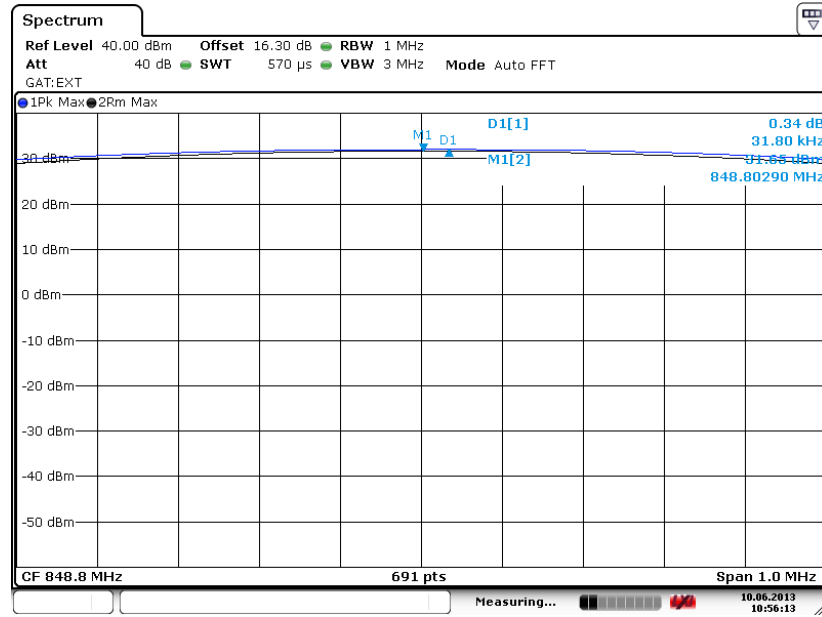

Date: 10.JUN.2013 10:56:12



| | | | |
|--------|---------|-------------|--------------------------|
| Band : | GSM 850 | Test Mode : | EDGE class 8 Link (8PSK) |
|--------|---------|-------------|--------------------------|

Peak-to-Average Ratio on Channel 128 (824.2 MHz)

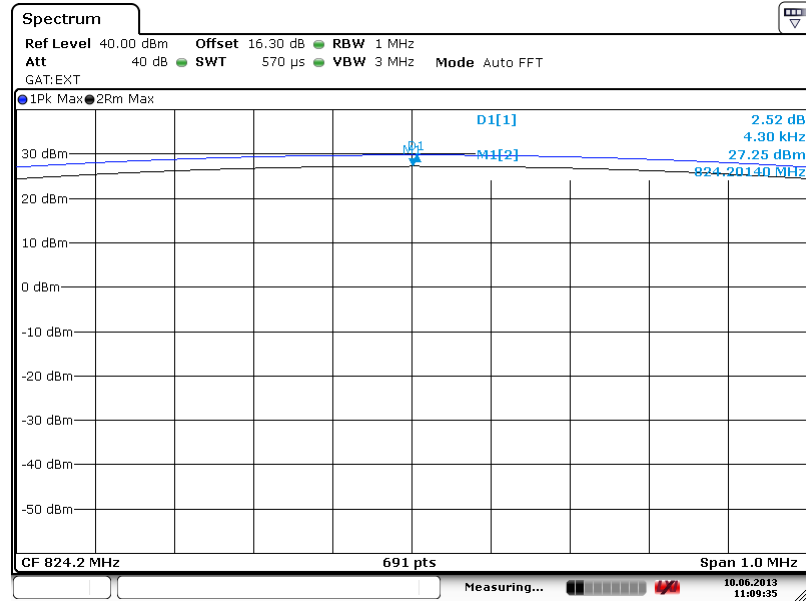

Date: 10.JUN.2013 11:09:36

Peak-to-Average Ratio on Channel 189 (836.4 MHz)

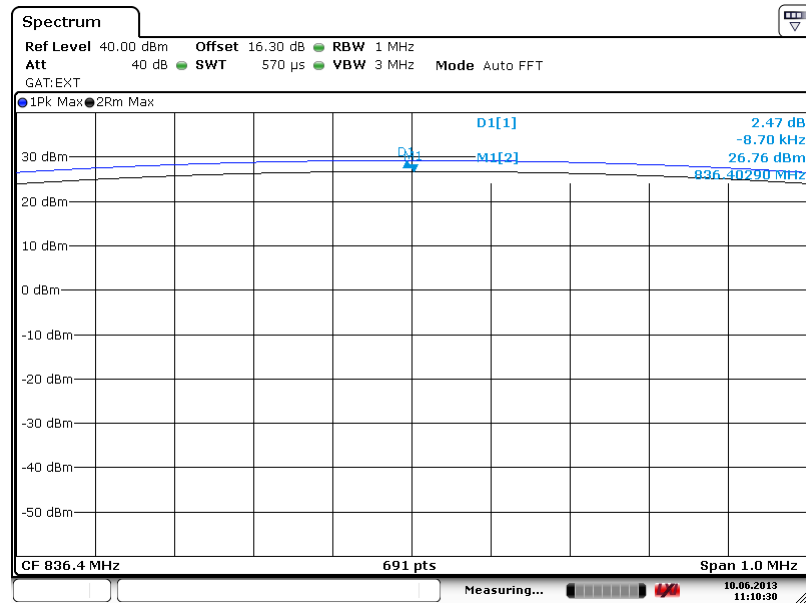

Date: 10.JUN.2013 11:10:31



Peak-to-Average Ratio on Channel 251 (848.8 MHz)

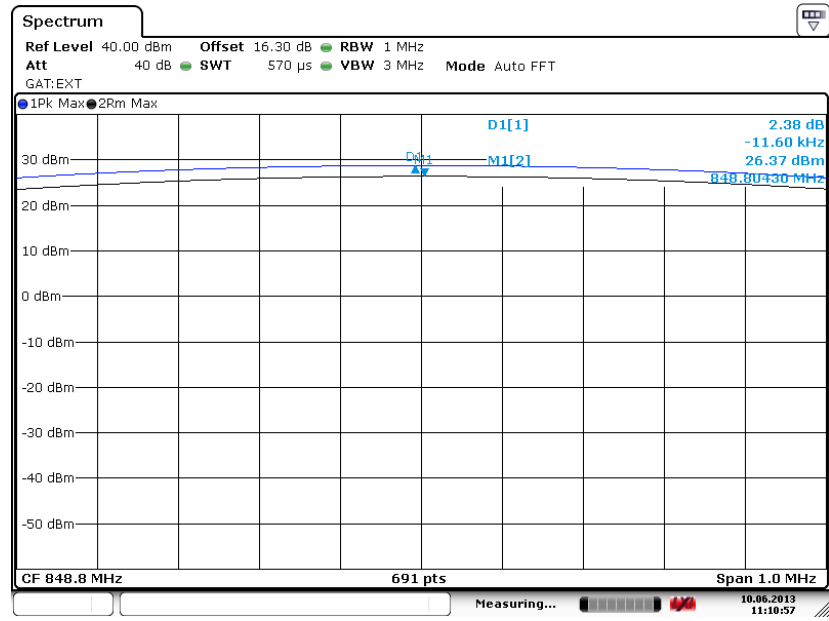

Date: 10.JUN.2013 11:10:58



| | | | |
|--------|----------|-------------|--------------------------|
| Band : | GSM 1900 | Test Mode : | GPRS class 8 Link (GMSK) |
|--------|----------|-------------|--------------------------|

Peak-to-Average Ratio on Channel 512 (1850.2 MHz)

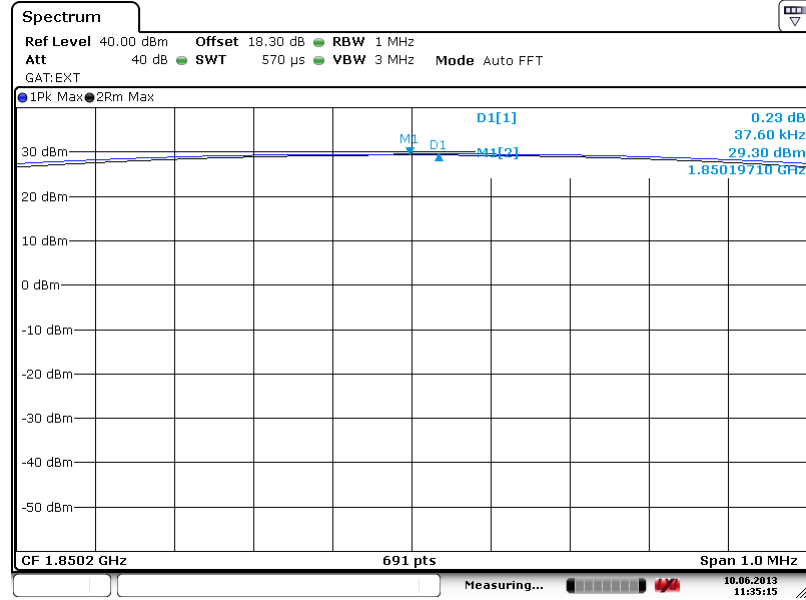

Peak-to-Average Ratio on Channel 661 (1880.0 MHz)

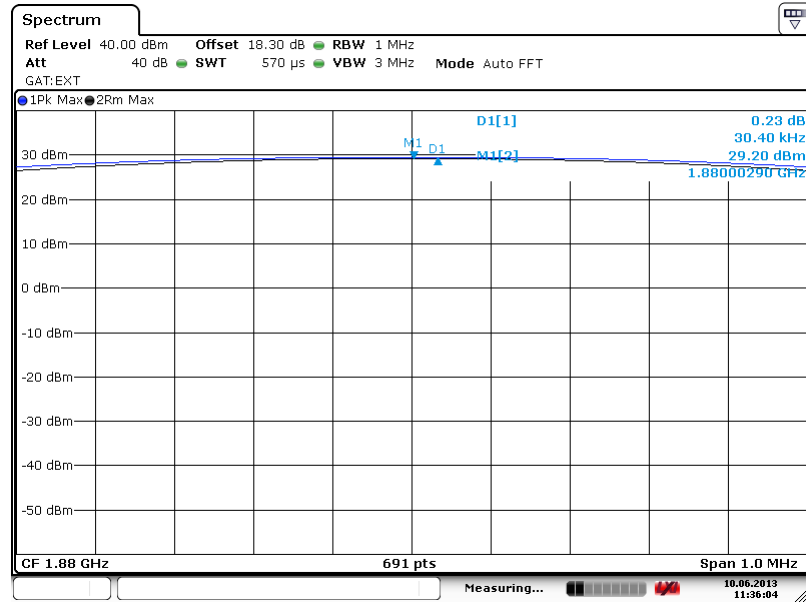



Peak-to-Average Ratio on Channel 810 (1909.8 MHz)

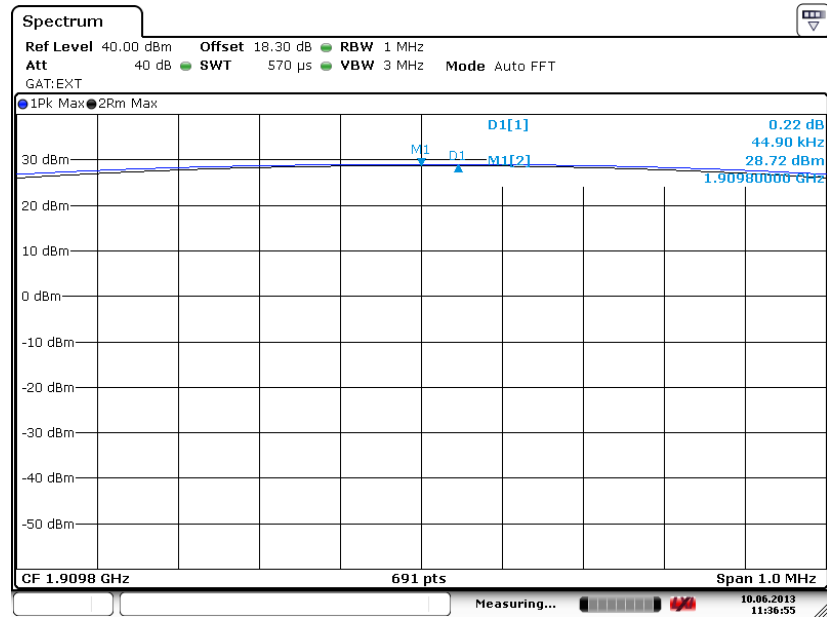

Date: 10.JUN.2013 11:36:55



| | | | |
|--------|----------|-------------|--------------------------|
| Band : | GSM 1900 | Test Mode : | EDGE class 8 Link (8PSK) |
|--------|----------|-------------|--------------------------|

Peak-to-Average Ratio on Channel 512 (1850.2 MHz)

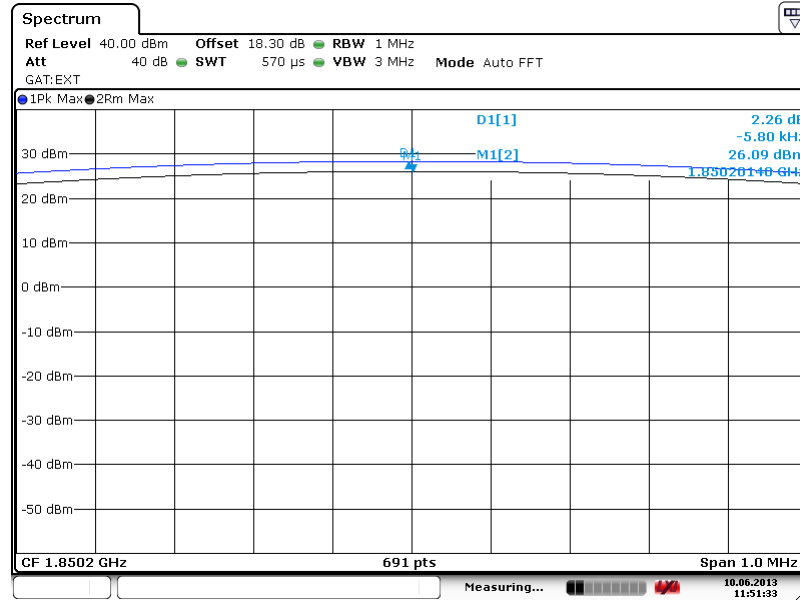

Peak-to-Average Ratio on Channel 661 (1880.0 MHz)

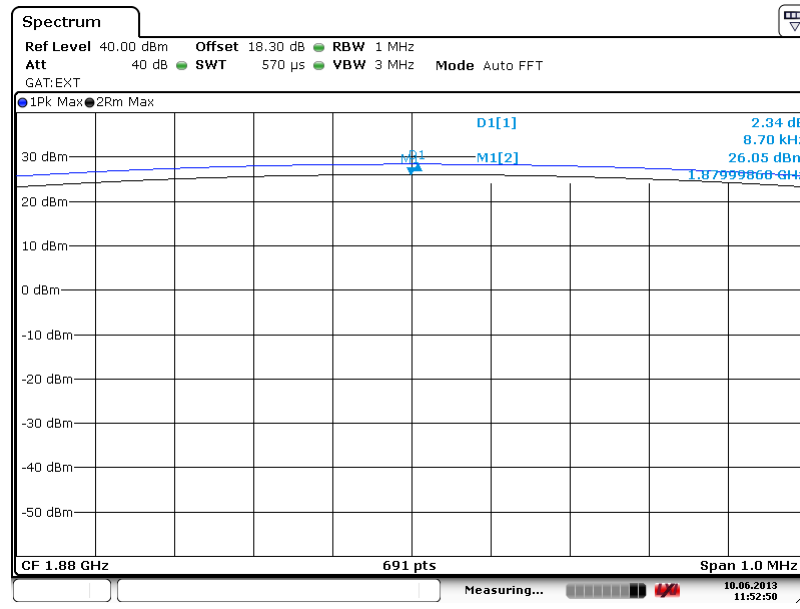



Peak-to-Average Ratio on Channel 810 (1909.8 MHz)

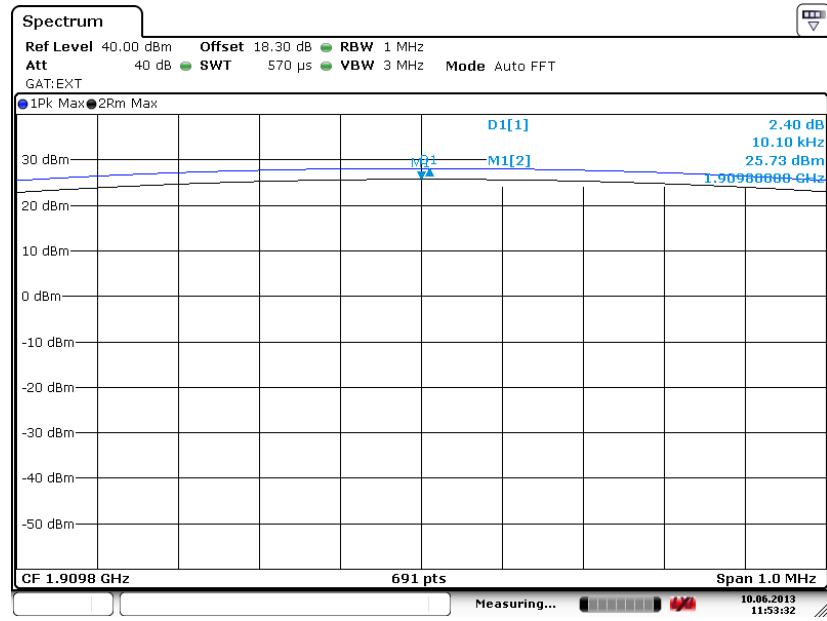

Date: 10.JUN.2013 11:53:32



| | | | |
|---------------|--------------|--------------------|--------------------------|
| Band : | WCDMA Band V | Test Mode : | RMC 12.2kbps Link (QPSK) |
|---------------|--------------|--------------------|--------------------------|

Peak-to-Average Ratio on Channel 4132 (826.4 MHz)

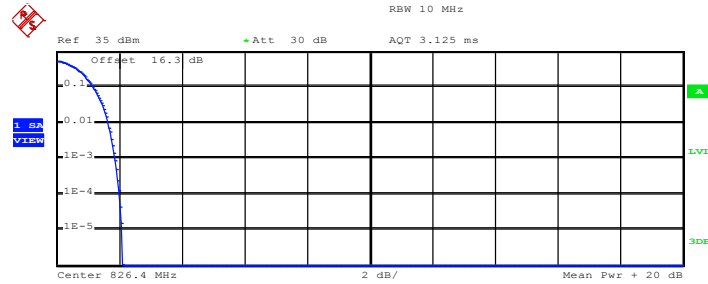

Complementary Cumulative Distribution Function (100000 samples)

Trace 1
Mean 23.77 dBm
Peak 25.87 dBm
Crest 2.10 dB

| | |
|-------|---------|
| 10 % | 1.16 dB |
| 1 % | 1.64 dB |
| .1 % | 1.88 dB |
| .01 % | 2.00 dB |

Date: 9.JUN.2013 10:22:38

Peak-to-Average Ratio on Channel 4182 (836.4 MHz)

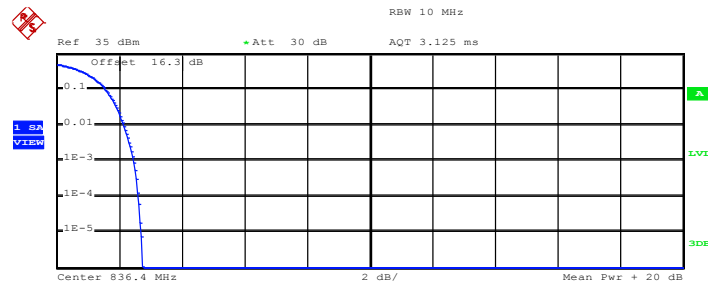

Complementary Cumulative Distribution Function (100000 samples)

Trace 1
Mean 23.41 dBm
Peak 26.15 dBm
Crest 2.74 dB

| | |
|-------|---------|
| 10 % | 1.56 dB |
| 1 % | 2.16 dB |
| .1 % | 2.48 dB |
| .01 % | 2.64 dB |

Date: 9.JUN.2013 10:23:02



Peak-to-Average Ratio on Channel 4233 (846.6 MHz)

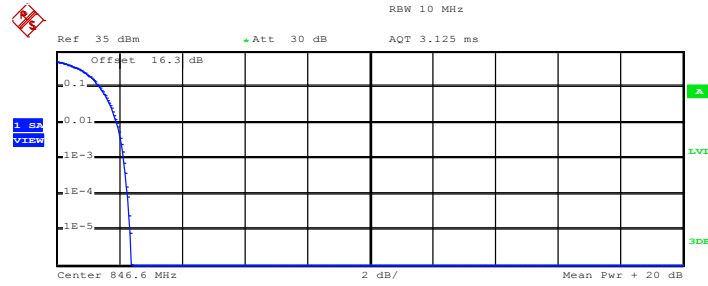

Complementary Cumulative Distribution Function (100000 samples)

Trace 1

Mean 23.35 dBm
Peak 25.73 dBm
Crest 2.38 dB

10 % 1.40 dB
1 % 1.92 dB
.1 % 2.16 dB
.01 % 2.28 dB

Date: 9.JUN.2013 10:23:28



| | | | |
|---------------|---------------|--------------------|--------------------------|
| Band : | WCDMA Band IV | Test Mode : | RMC 12.2kbps Link (QPSK) |
|---------------|---------------|--------------------|--------------------------|

Peak-to-Average Ratio on Channel 1312 (1712.4 MHz)

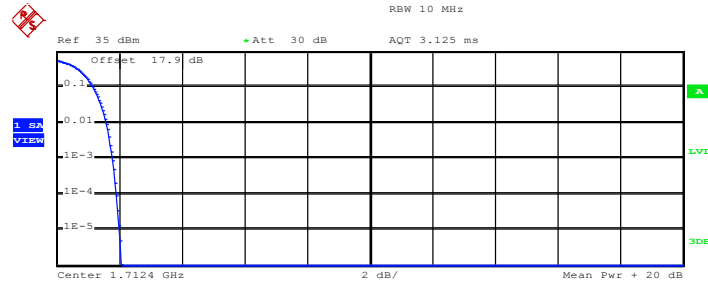

Complementary Cumulative Distribution Function (100000 samples)

Trace 1

| | |
|-------|-----------|
| Mean | 20.06 dBm |
| Peak | 22.13 dBm |
| Crest | 2.07 dB |
| 10 % | 1.16 dB |
| 1 % | 1.60 dB |
| .1 % | 1.80 dB |
| .01 % | 1.92 dB |

Date: 9.JUN.2013 10:31:02

Peak-to-Average Ratio on Channel 1413 (1732.6 MHz)

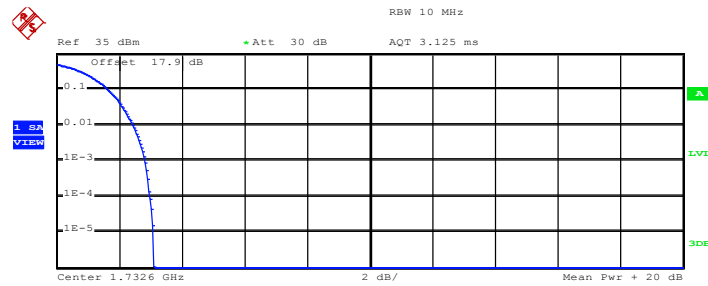

Complementary Cumulative Distribution Function (100000 samples)

Trace 1

| | |
|-------|-----------|
| Mean | 20.80 dBm |
| Peak | 23.89 dBm |
| Crest | 3.10 dB |
| 10 % | 1.64 dB |
| 1 % | 2.44 dB |
| .1 % | 2.84 dB |
| .01 % | 3.00 dB |

Date: 9.JUN.2013 10:31:35



Peak-to-Average Ratio on Channel 1513 (1752.6 MHz)

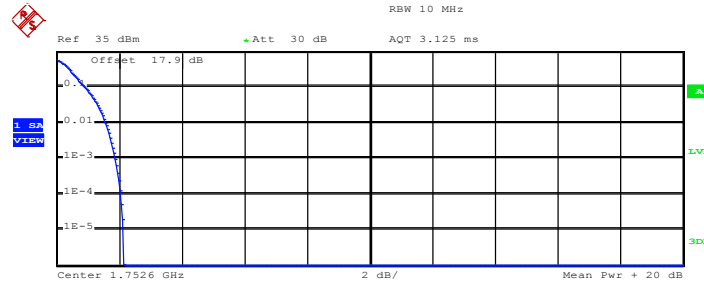

Complementary Cumulative Distribution Function (100000 samples)

Trace 1

Mean 20.05 dBm
Peak 22.20 dBm
Crest 2.15 dB

10 % 0.92 dB
1 % 1.56 dB
.1 % 1.88 dB
.01 % 2.04 dB

Date: 9.JUN.2013 10:32:02



| | | | |
|---------------|---------------|--------------------|--------------------------|
| Band : | WCDMA Band II | Test Mode : | RMC 12.2kbps Link (QPSK) |
|---------------|---------------|--------------------|--------------------------|

Peak-to-Average Ratio on Channel 9262 (1852.4 MHz)

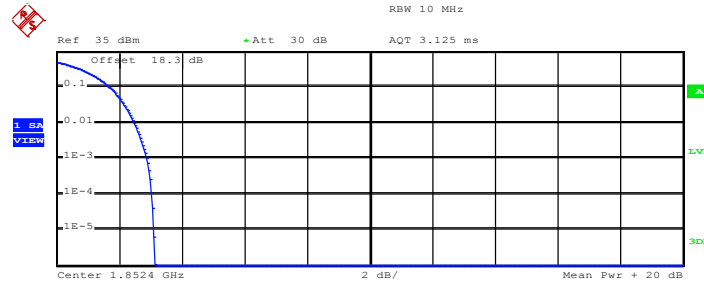

Complementary Cumulative Distribution Function (100000 samples)

Trace 1

| | |
|-------|-----------|
| Mean | 24.40 dBm |
| Peak | 27.56 dBm |
| Crest | 3.16 dB |
| 10 % | 1.72 dB |
| 1 % | 2.48 dB |
| .1 % | 2.88 dB |
| .01 % | 3.04 dB |

Date: 9.JUN.2013 10:12:17

Peak-to-Average Ratio on Channel 9400 (1880.0 MHz)

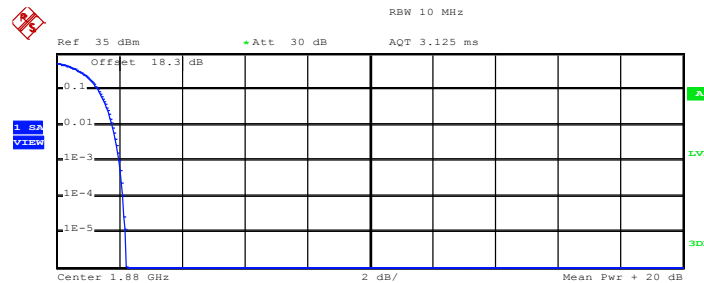

Complementary Cumulative Distribution Function (100000 samples)

Trace 1

| | |
|-------|-----------|
| Mean | 23.57 dBm |
| Peak | 25.80 dBm |
| Crest | 2.23 dB |
| 10 % | 1.32 dB |
| 1 % | 1.80 dB |
| .1 % | 2.00 dB |
| .01 % | 2.12 dB |

Date: 9.JUN.2013 10:12:45



Peak-to-Average Ratio on Channel 9538 (1907.6 MHz)

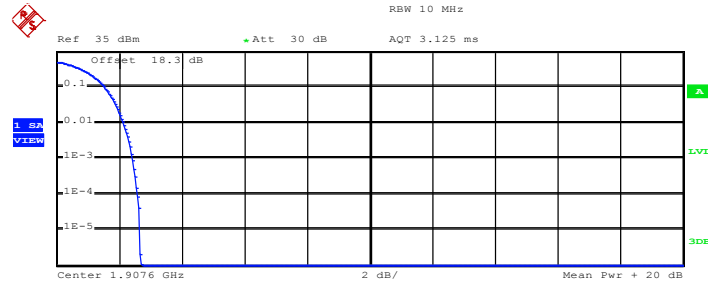

Complementary Cumulative Distribution Function (100000 samples)

Trace 1

Mean 22.98 dBm
Peak 25.66 dBm
Crest 2.68 dB

10 % 1.56 dB
1 % 2.12 dB
.1 % 2.44 dB
.01 % 2.60 dB

Date: 9.JUN.2013 10:13:07

3.3 Occupied Bandwidth and 26dB Bandwidth Measurement

3.3.1 Description of Occupied Bandwidth and 26dB Bandwidth Measurement

The occupied bandwidth is the width of a frequency band such that, below the lower and above the upper frequency limits, the mean powers emitted are each equal to a specified percentage 0.5% of the total mean transmitted power.

The emission bandwidth is defined as the width of the signal between two points, located at the 2 sides of the carrier frequency, outside of which all emissions are attenuated at least 26 dB below the transmitter power.

3.3.2 Measuring Instruments

See list of measuring instruments of this test report.

3.3.3 Test Procedures

1. The EUT was connected to Spectrum Analyzer and Base Station via power divider.
2. The RF output of EUT was connected to the spectrum analyzer by RF cable and attenuator. The path loss was compensated to the results for each measurement.
3. The 99% occupied bandwidth were measured, set RBW= 1% of span, VBW= 3*RBW, sample detector, trace maximum hold.
4. The 26dB bandwidth were measured, set RBW= 1% of EBW, VBW= 3*RBW, peak detector, trace maximum hold.

3.3.4 Test Setup

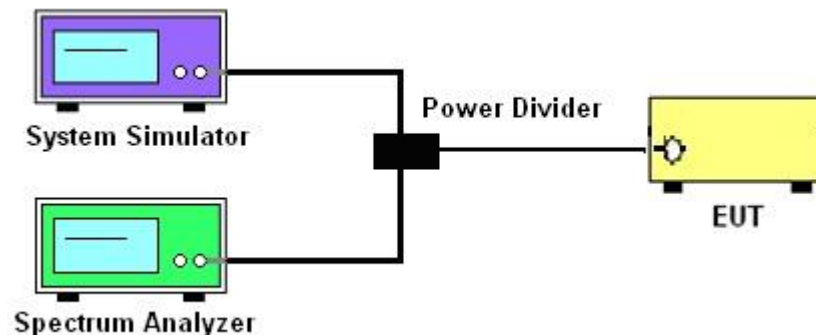

3.3.5 Test Result of Occupied Bandwidth and 26dB Bandwidth

| Cellular Band | | | | | | |
|-----------------|-----------------------|-----------|------------|-----------------------|-----------|------------|
| Modes | GSM850 (GPRS class 8) | | | GSM850 (EDGE class 8) | | |
| Channel | 128 (Low) | 189 (Mid) | 251 (High) | 128 (Low) | 189 (Mid) | 251 (High) |
| Frequency (MHz) | 824.2 | 836.4 | 848.8 | 824.2 | 836.4 | 848.8 |
| 99% OBW (kHz) | 246.00 | 244.00 | 242.00 | 248.00 | 242.00 | 250.00 |
| 26dB BW (kHz) | 318.00 | 314.00 | 312.00 | 304.00 | 288.00 | 290.00 |

| PCS Band | | | | | | |
|-----------------|------------------------|-----------|------------|------------------------|-----------|------------|
| Modes | GSM1900 (GPRS class 8) | | | GSM1900 (EDGE class 8) | | |
| Channel | 512 (Low) | 661 (Mid) | 810 (High) | 512 (Low) | 661 (Mid) | 810 (High) |
| Frequency (MHz) | 1850.2 | 1880 | 1909.8 | 1850.2 | 1880 | 1909.8 |
| 99% OBW (kHz) | 242.00 | 244.00 | 248.00 | 254.00 | 248.00 | 246.00 |
| 26dB BW (kHz) | 316.00 | 314.00 | 310.00 | 314.00 | 310.00 | 312.00 |

| Cellular Band | | | |
|-----------------|-----------------------------|------------|-------------|
| Modes | WCDMA Band V (RMC 12.2kbps) | | |
| Channel | 4132 (Low) | 4182 (Mid) | 4233 (High) |
| Frequency (MHz) | 826.4 | 836.4 | 846.6 |
| 99% OBW (MHz) | 4.14 | 4.10 | 4.14 |
| 26dB BW (MHz) | 4.80 | 4.70 | 4.76 |

| AWS Band | | | |
|-----------------|------------------------------|------------|-------------|
| Modes | WCDMA Band IV (RMC 12.2kbps) | | |
| Channel | 1312(Low) | 1413 (Mid) | 1513 (High) |
| Frequency (MHz) | 1712.4 | 1732.6 | 1752.6 |
| 99% OBW (MHz) | 4.20 | 4.10 | 5.08 |
| 26dB BW (MHz) | 4.94 | 4.68 | 7.36 |



| PCS Band | | | |
|-----------------|------------------------------|------------|-------------|
| Modes | WCDMA Band II (RMC 12.2kbps) | | |
| Channel | 9262 (Low) | 9400 (Mid) | 9538 (High) |
| Frequency (MHz) | 1852.4 | 1880 | 1907.6 |
| 99% OBW (MHz) | 4.08 | 4.10 | 4.10 |
| 26dB BW (MHz) | 4.64 | 4.72 | 4.68 |



3.3.6 Test Result (Plots) of Occupied Bandwidth and 26dB Bandwidth

| | | | |
|--------|---------|-------------|--------------------------|
| Band : | GSM 850 | Test Mode : | GPRS class 8 Link (GMSK) |
|--------|---------|-------------|--------------------------|

99% Occupied Bandwidth Plot on Channel 128 (824.2 MHz)

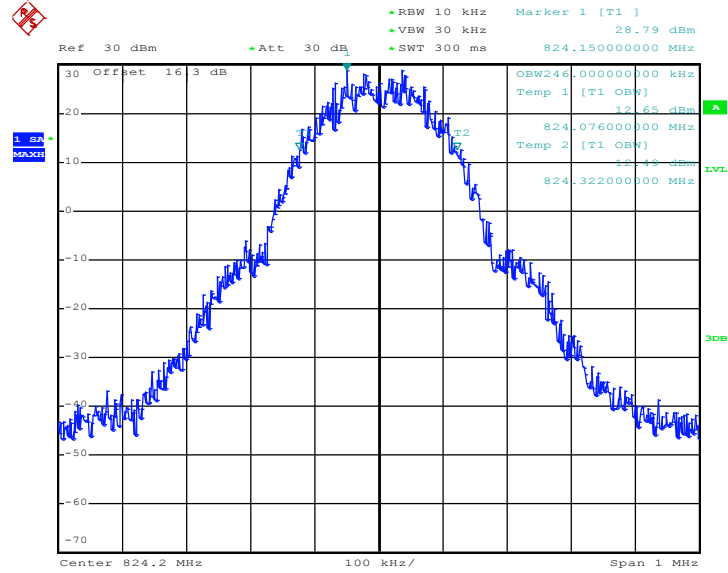

Date: 9.JUN.2013 08:26:32

26dB Bandwidth Plot on Channel 128 (824.2 MHz)

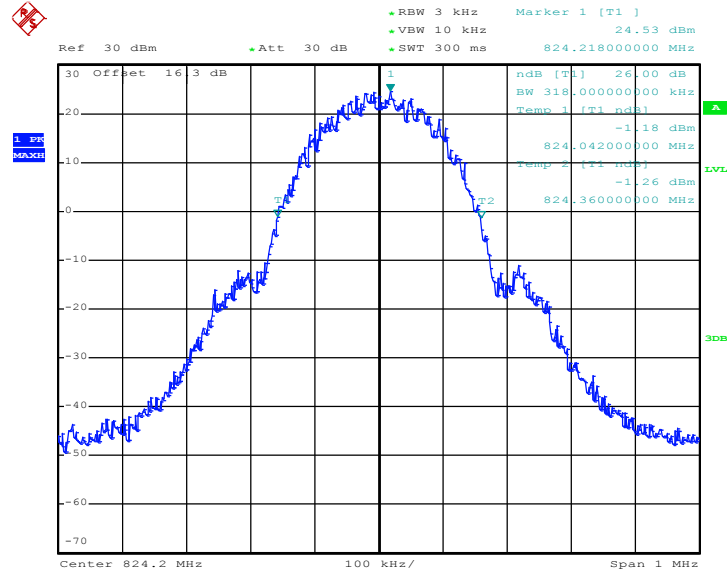

Date: 9.JUN.2013 08:25:14



99% Occupied Bandwidth Plot on Channel 189 (836.4 MHz)

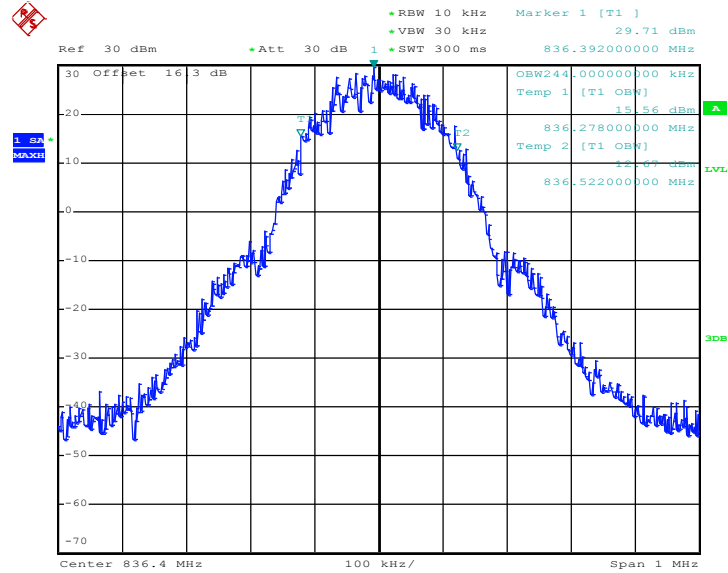

Date: 9.JUN.2013 08:26:58

26dB Bandwidth Plot on Channel 189 (836.4 MHz)

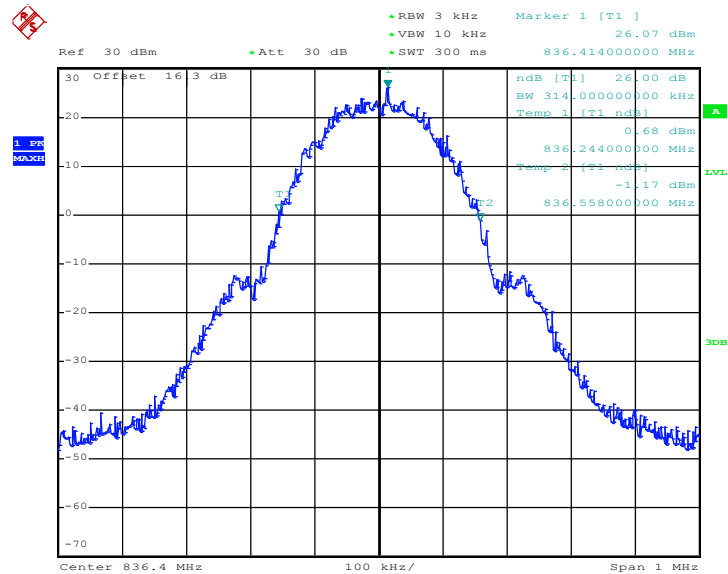

Date: 9.JUN.2013 08:25:40



99% Occupied Bandwidth Plot on Channel 251 (848.8 MHz)

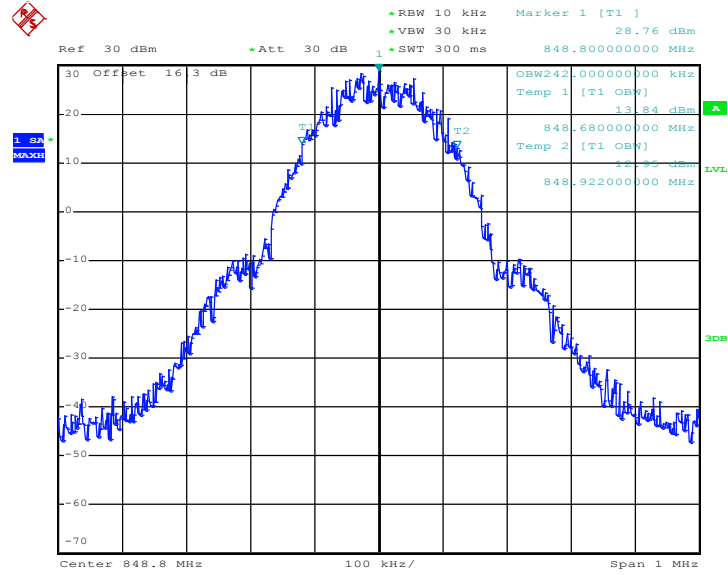

Date: 9.JUN.2013 08:27:24

26dB Bandwidth Plot on Channel 251 (848.8 MHz)

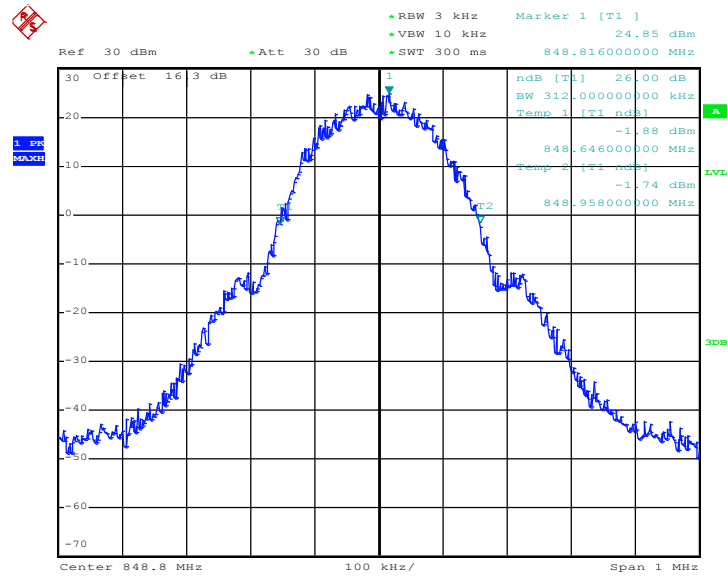

Date: 9.JUN.2013 08:26:06



| | | | |
|--------|---------|-------------|--------------------------|
| Band : | GSM 850 | Test Mode : | EDGE class 8 Link (8PSK) |
|--------|---------|-------------|--------------------------|

99% Occupied Bandwidth Plot on Channel 128 (824.2 MHz)

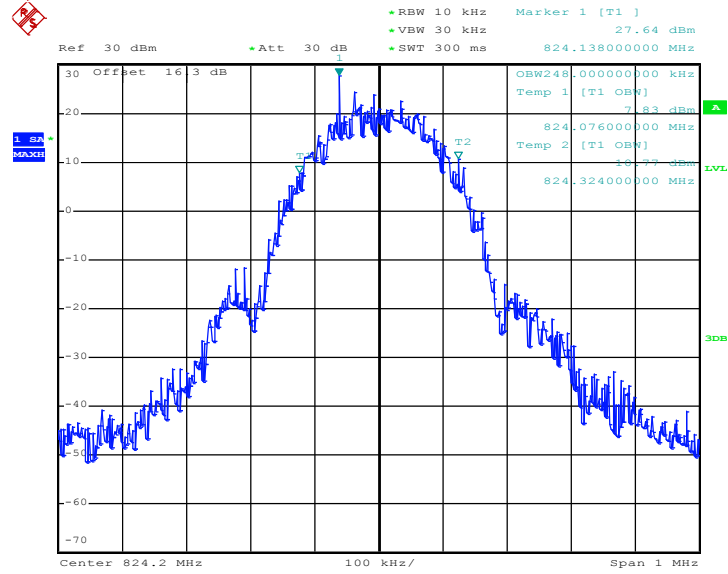

Date: 9.JUN.2013 15:22:39

26dB Bandwidth Plot on Channel 128 (824.2 MHz)

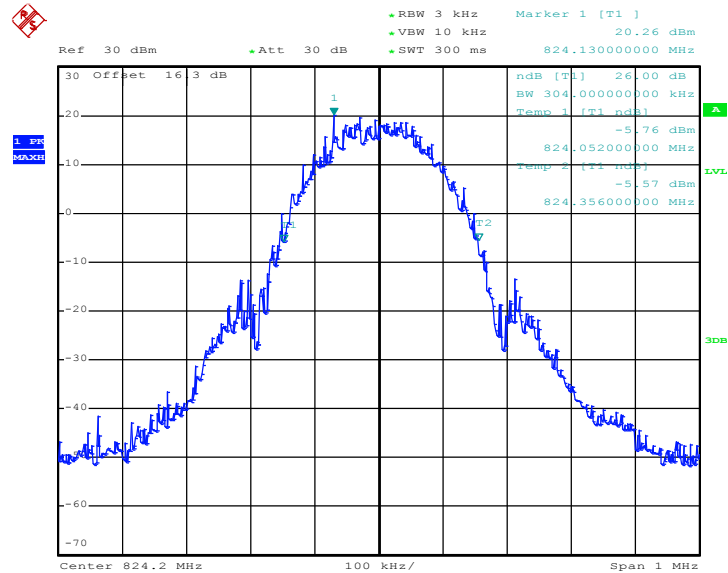

Date: 9.JUN.2013 15:18:58



99% Occupied Bandwidth Plot on Channel 189 (836.4 MHz)

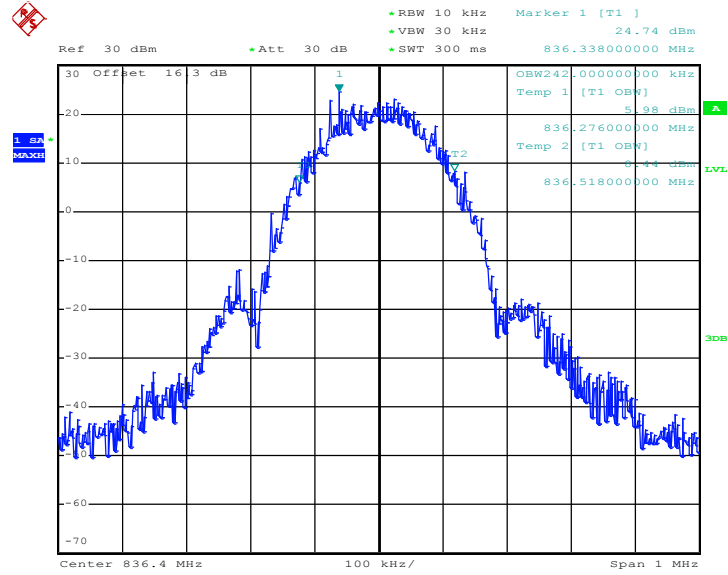

Date: 9.JUN.2013 15:23:05

26dB Bandwidth Plot on Channel 189 (836.4 MHz)

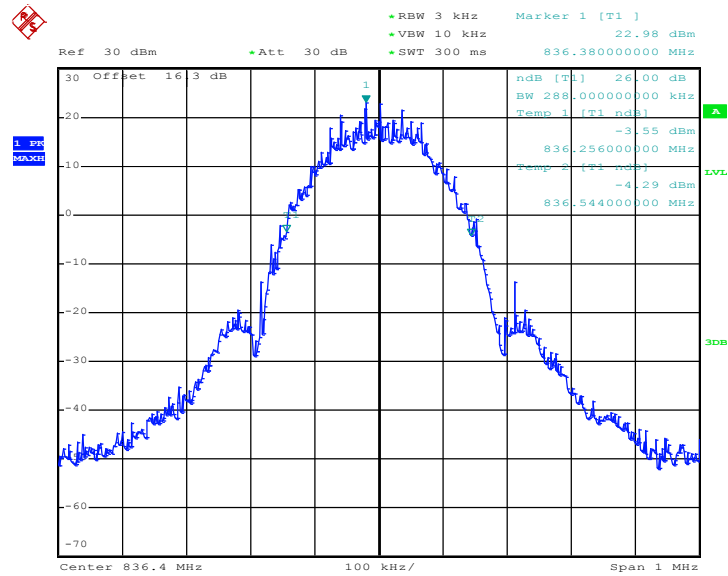

Date: 9.JUN.2013 15:19:24



99% Occupied Bandwidth Plot on Channel 251 (848.8 MHz)

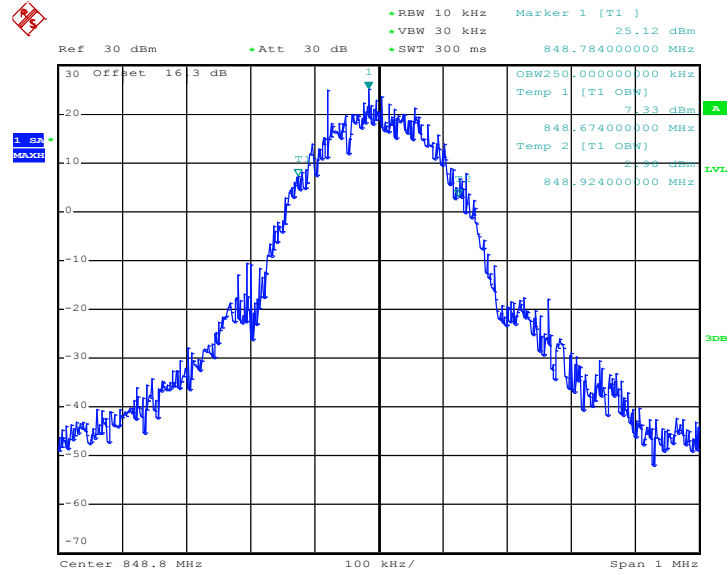

Date: 9.JUN.2013 15:23:31

26dB Bandwidth Plot on Channel 251 (848.8 MHz)

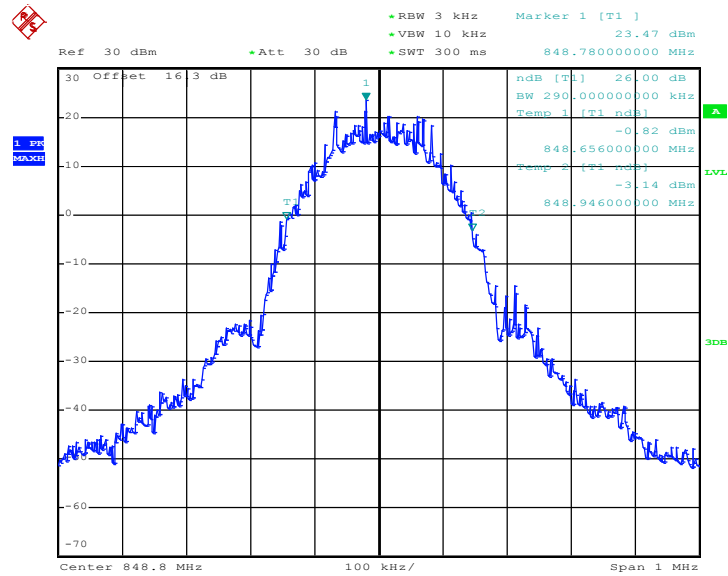

Date: 9.JUN.2013 15:19:50



| | | | |
|--------|----------|-------------|--------------------------|
| Band : | GSM 1900 | Test Mode : | GPRS class 8 Link (GMSK) |
|--------|----------|-------------|--------------------------|

99% Occupied Bandwidth Plot on Channel 512 (1850.2 MHz)

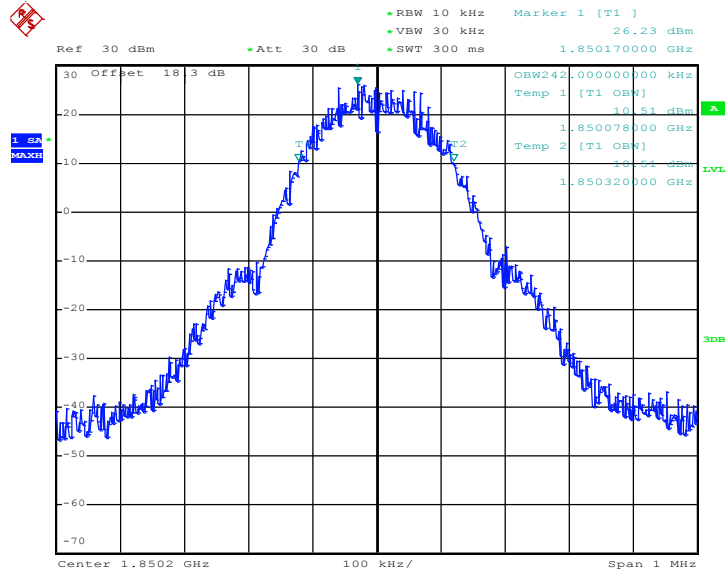

Date: 9.JUN.2013 09:01:10

26dB Bandwidth Plot on Channel 512 (1850.2 MHz)

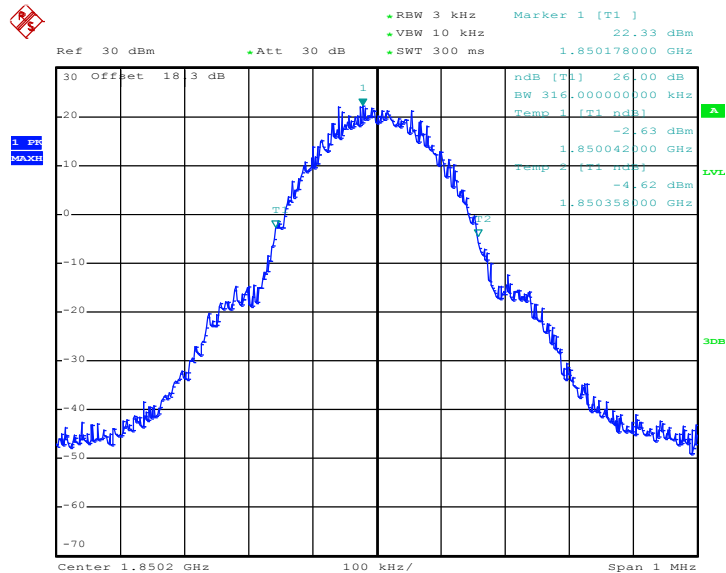

Date: 9.JUN.2013 08:59:51



99% Occupied Bandwidth Plot on Channel 661 (1880.0 MHz)

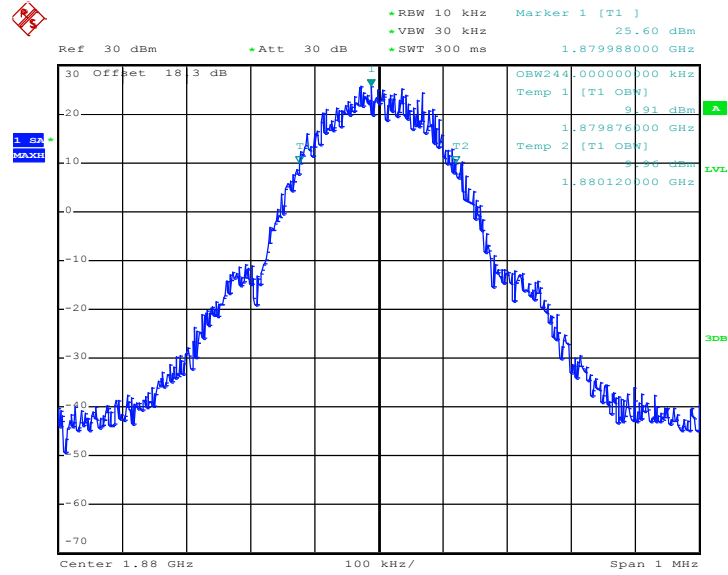

Date: 9.JUN.2013 09:01:36

26dB Bandwidth Plot on Channel 661 (1880.0 MHz)

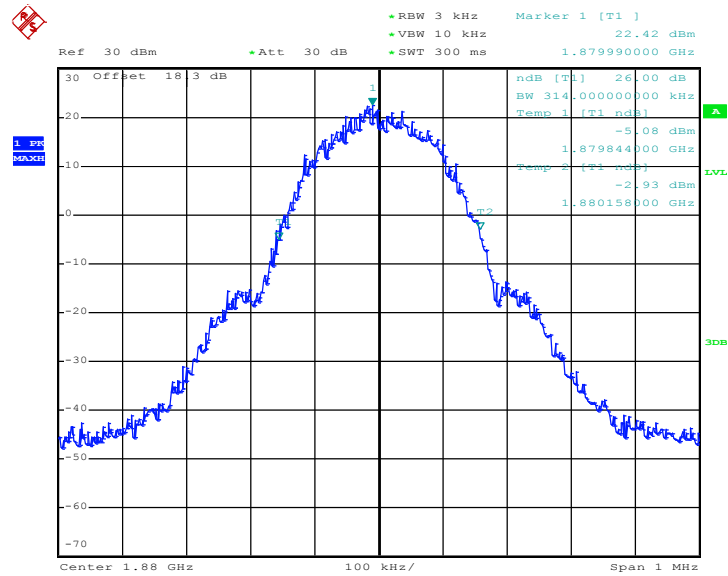

Date: 9.JUN.2013 09:00:18



99% Occupied Bandwidth Plot on Channel 810 (1909.8 MHz)

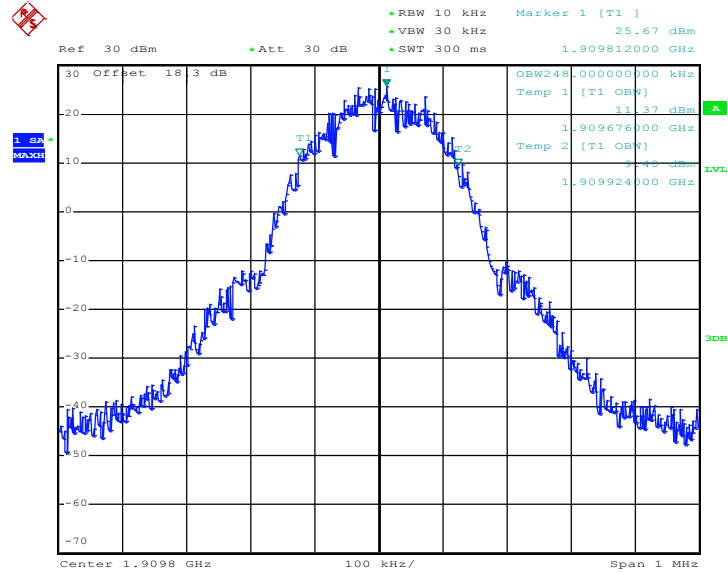

Date: 9.JUN.2013 09:02:02

26dB Bandwidth Plot on Channel 810 (1909.8 MHz)

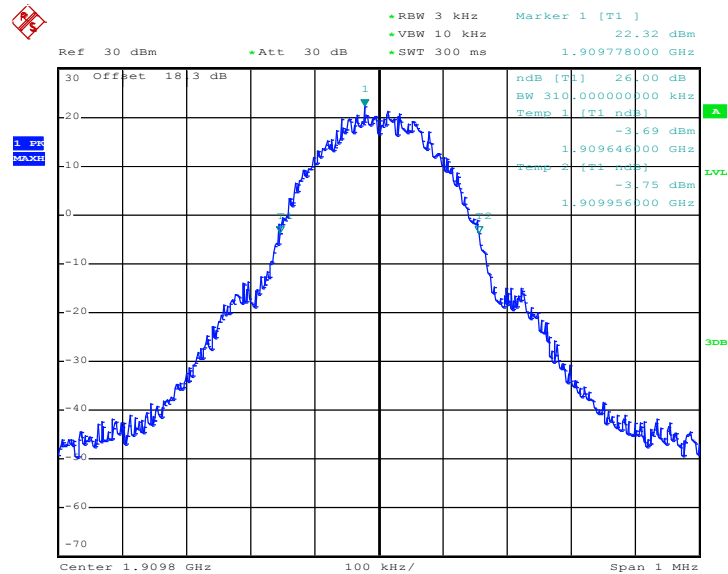

Date: 9.JUN.2013 09:00:44



| | | | |
|--------|----------|-------------|--------------------------|
| Band : | GSM 1900 | Test Mode : | EDGE class 8 Link (8PSK) |
|--------|----------|-------------|--------------------------|

99% Occupied Bandwidth Plot on Channel 512 (1850.2 MHz)

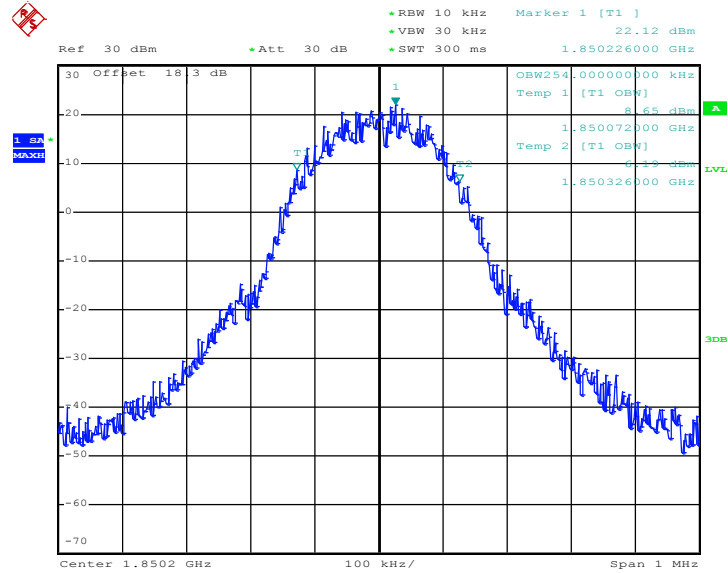

Date: 9.JUN.2013 09:46:47

26dB Bandwidth Plot on Channel 512 (1850.2 MHz)

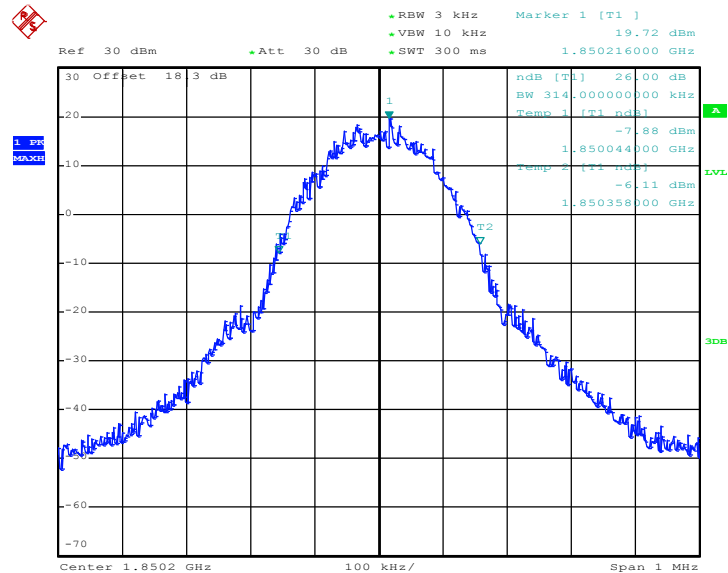

Date: 9.JUN.2013 09:45:29



99% Occupied Bandwidth Plot on Channel 661 (1880.0 MHz)

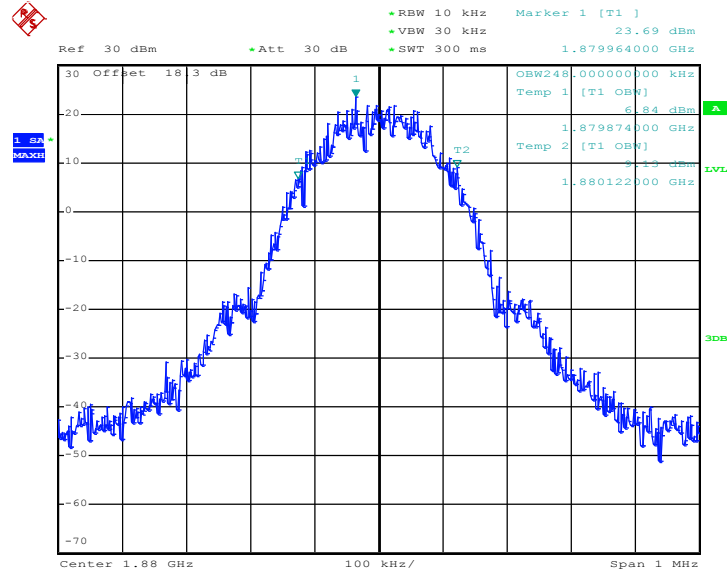

Date: 9.JUN.2013 09:47:13

26dB Bandwidth Plot on Channel 661 (1880.0 MHz)

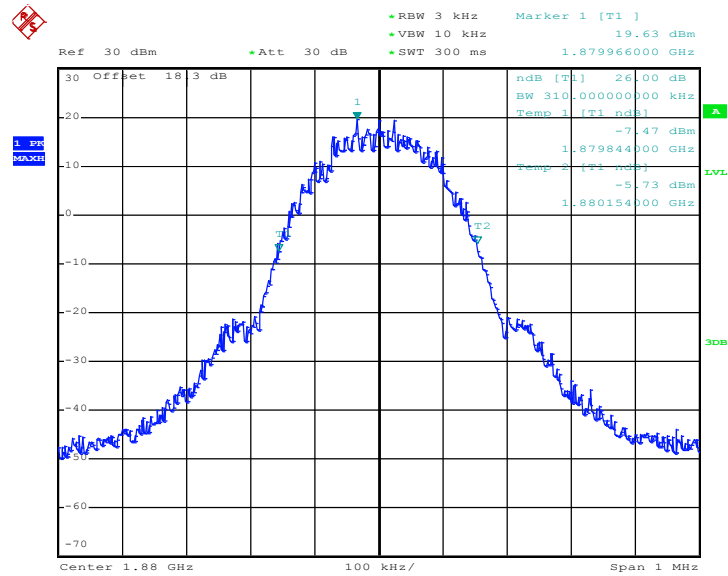

Date: 9.JUN.2013 09:45:55



99% Occupied Bandwidth Plot on Channel 810 (1909.8 MHz)

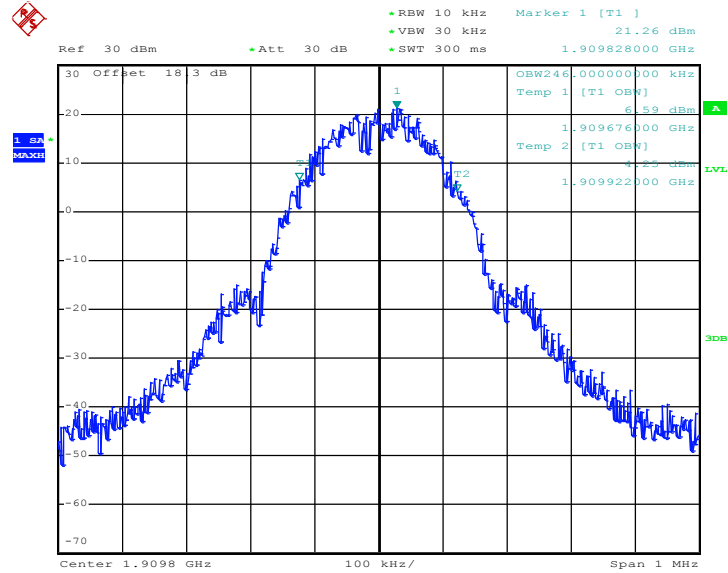

Date: 9.JUN.2013 09:47:39

26dB Bandwidth Plot on Channel 810 (1909.8 MHz)

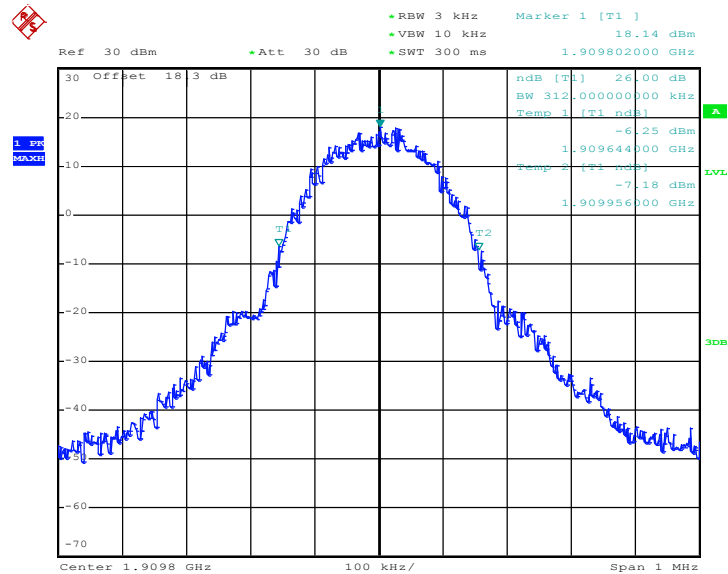

Date: 9.JUN.2013 09:46:21



| | | | |
|--------|--------------|-------------|--------------------------|
| Band : | WCDMA Band V | Test Mode : | RMC 12.2kbps Link (QPSK) |
|--------|--------------|-------------|--------------------------|

99% Occupied Bandwidth Plot on Channel 4132 (826.4 MHz)

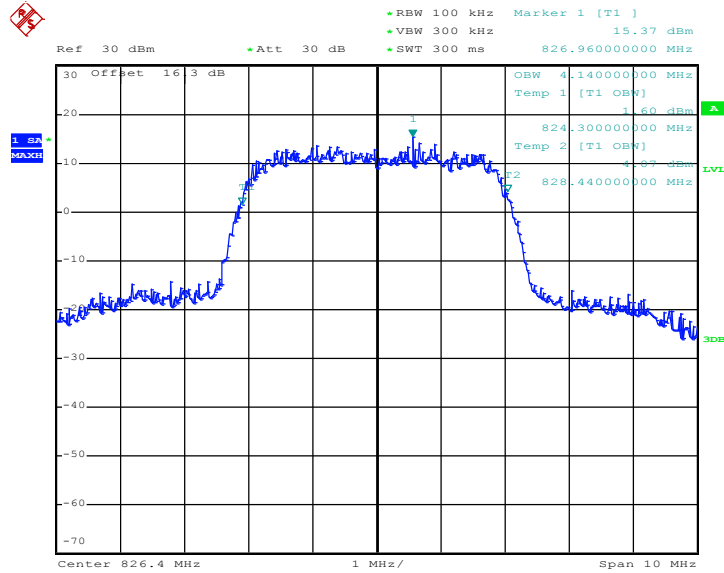

Date: 9.JUN.2013 10:26:59

26dB Bandwidth Plot on Channel 4132 (826.4 MHz)

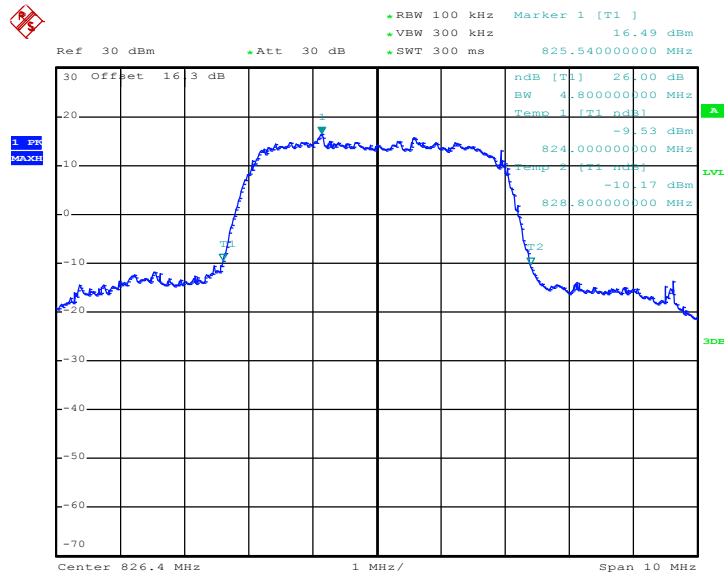

Date: 9.JUN.2013 10:25:38



99% Occupied Bandwidth Plot on Channel 4182 (836.4 MHz)

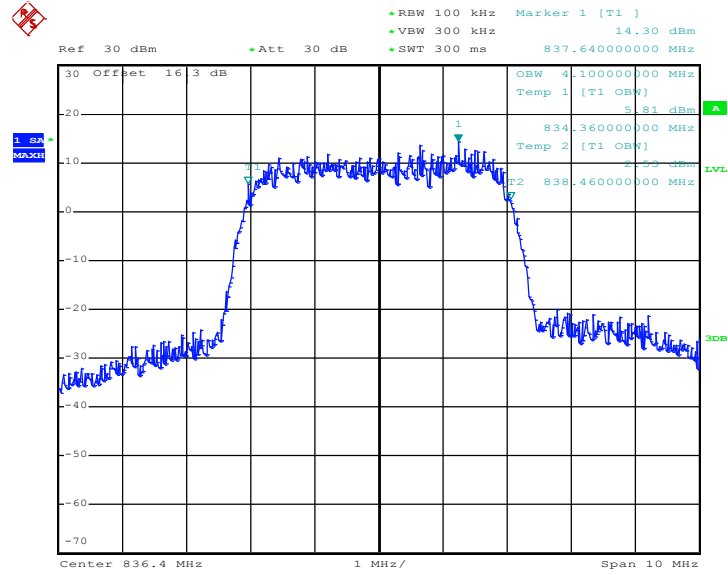

Date: 9.JUN.2013 10:27:26

26dB Bandwidth Plot on Channel 4182 (836.4 MHz)

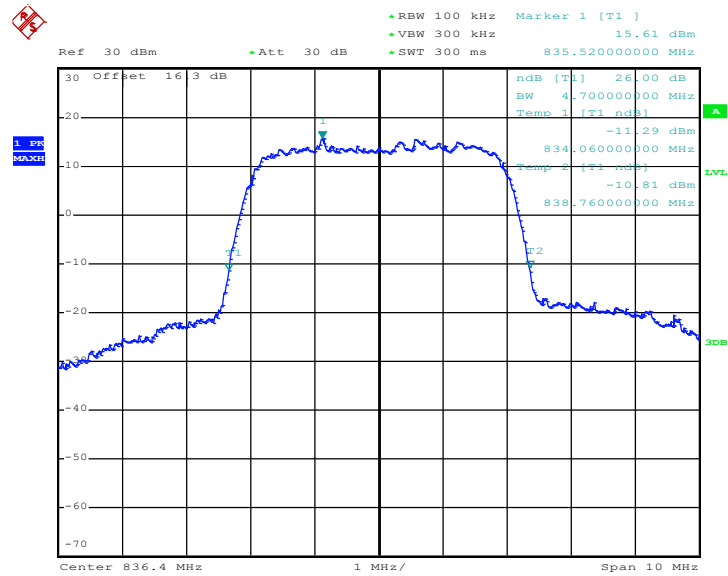

Date: 9.JUN.2013 10:26:05



99% Occupied Bandwidth Plot on Channel 4233 (846.6 MHz)

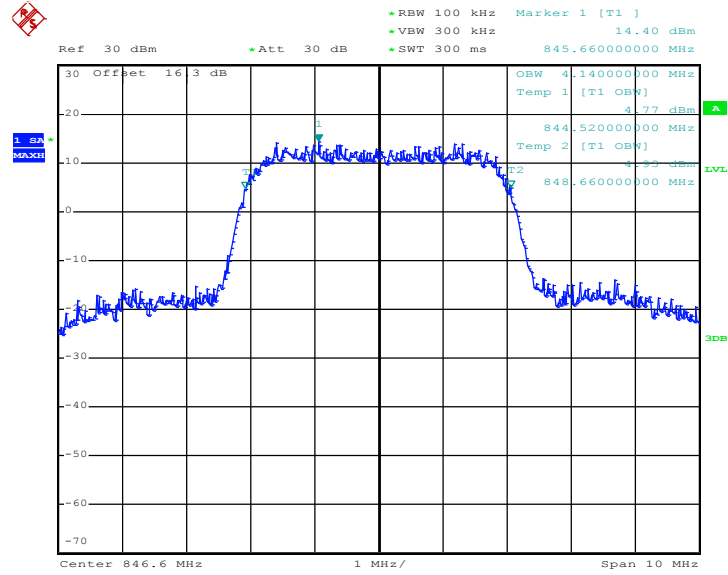

Date: 9.JUN.2013 10:27:52

26dB Bandwidth Plot on Channel 4233 (846.6 MHz)

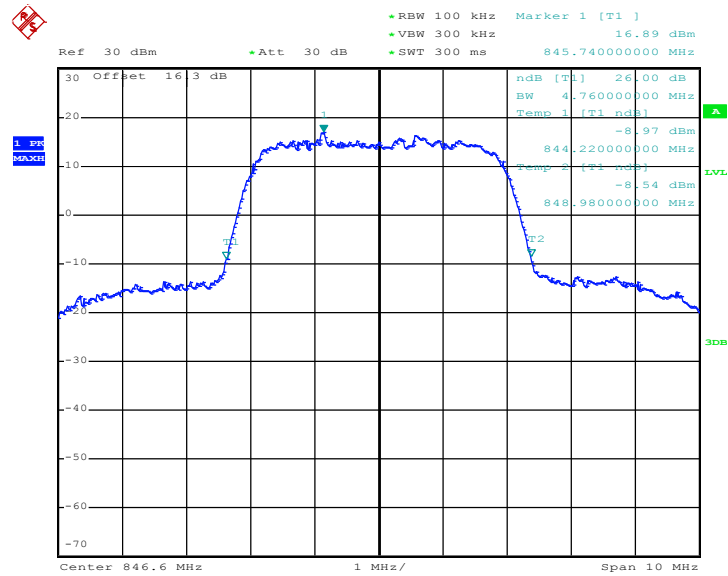

Date: 9.JUN.2013 10:26:32



| | | | |
|---------------|---------------|--------------------|--------------------------|
| Band : | WCDMA Band IV | Test Mode : | RMC 12.2kbps Link (QPSK) |
|---------------|---------------|--------------------|--------------------------|

99% Occupied Bandwidth Plot on Channel 1312 (1712.4 MHz)

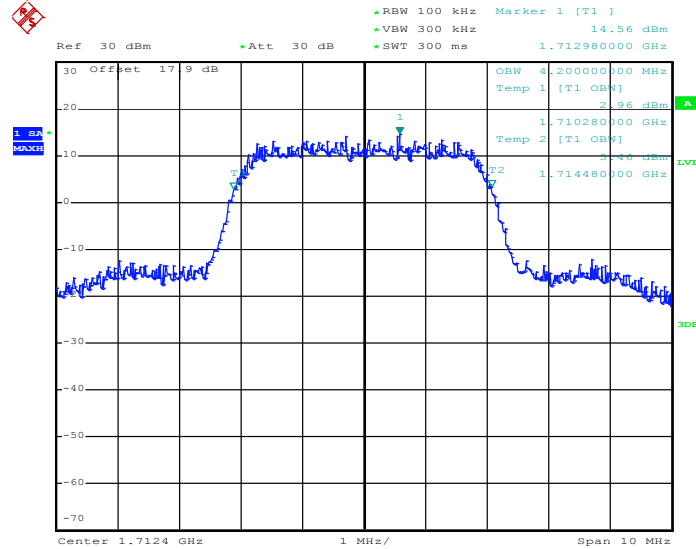

Date: 9.JUN.2013 10:35:31

26dB Bandwidth Plot on Channel 1312 (1712.4 MHz)

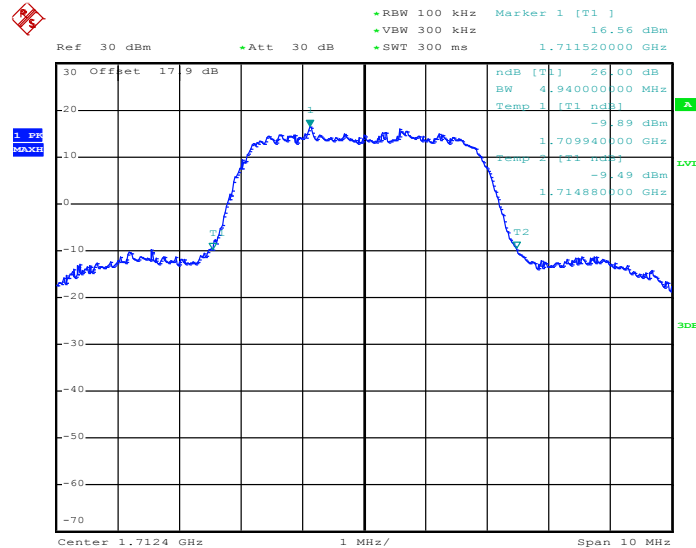

Date: 9.JUN.2013 10:34:11



99% Occupied Bandwidth Plot on Channel 1413 (1732.6 MHz)

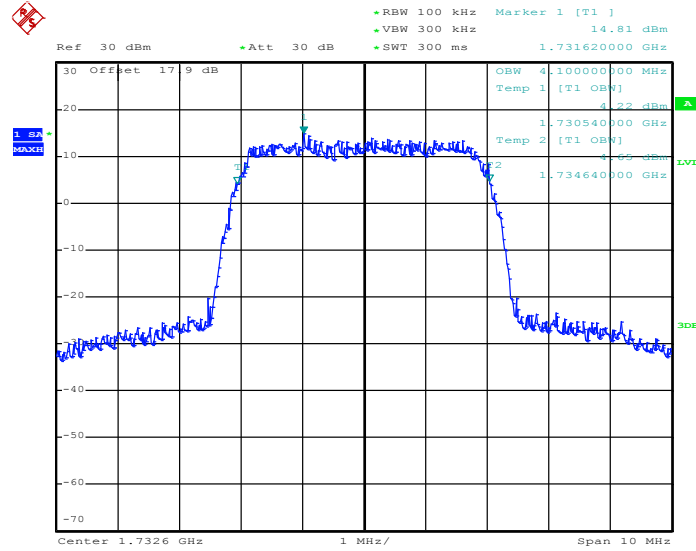

Date: 9.JUN.2013 10:35:57

26dB Bandwidth Plot on Channel 1413 (1732.6 MHz)

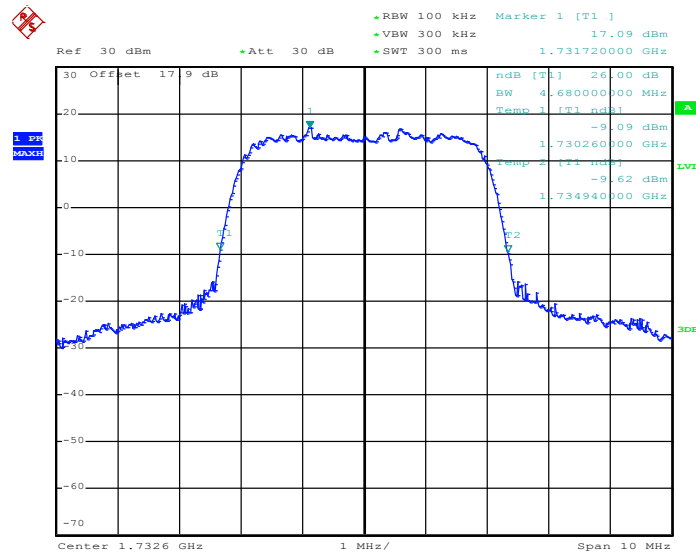

Date: 9.JUN.2013 10:34:37



99% Occupied Bandwidth Plot on Channel 1513 (1752.6 MHz)

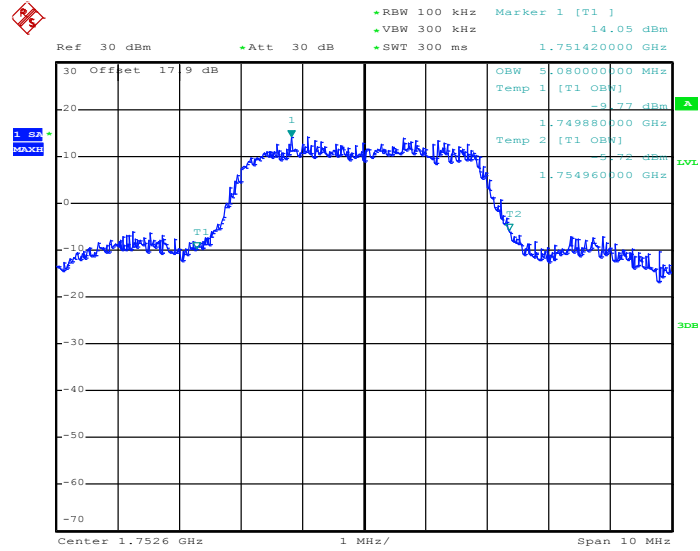

Date: 9.JUN.2013 10:36:22

26dB Bandwidth Plot on Channel 1513 (1752.6 MHz)

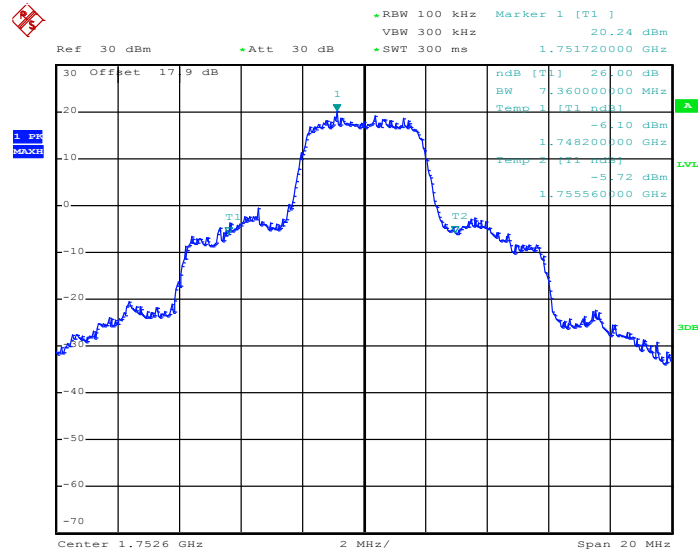

Date: 12.JUL.2013 11:29:01



| | | | |
|--------|---------------|-------------|--------------------------|
| Band : | WCDMA Band II | Test Mode : | RMC 12.2kbps Link (QPSK) |
|--------|---------------|-------------|--------------------------|

99% Occupied Bandwidth Plot on Channel 9262 (1852.4 MHz)

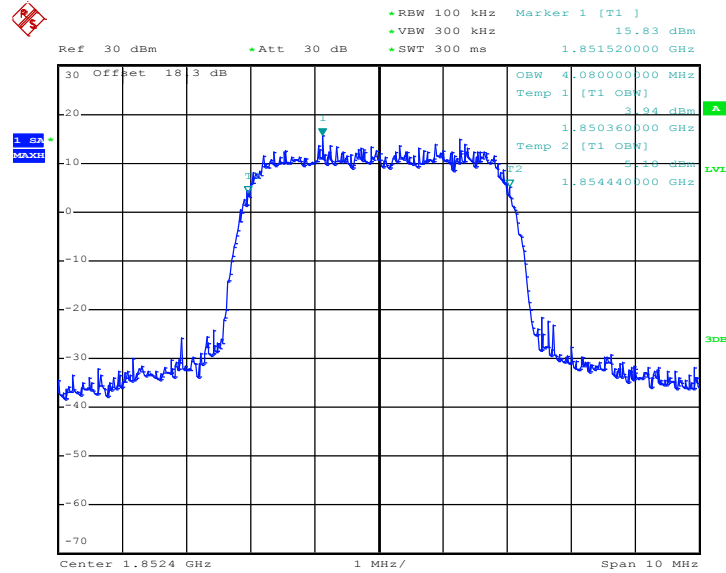

Date: 9.JUN.2013 10:17:18

26dB Bandwidth Plot on Channel 9262 (1852.4 MHz)

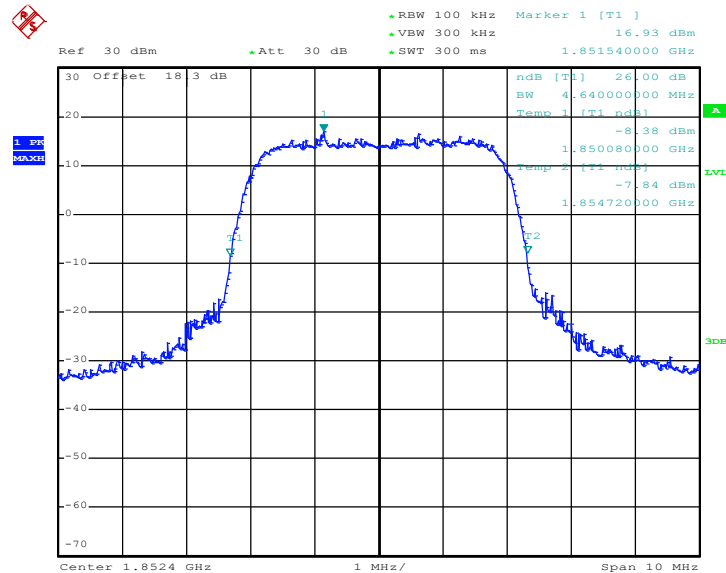

Date: 9.JUN.2013 10:15:58



99% Occupied Bandwidth Plot on Channel 9400 (1880.0 MHz)

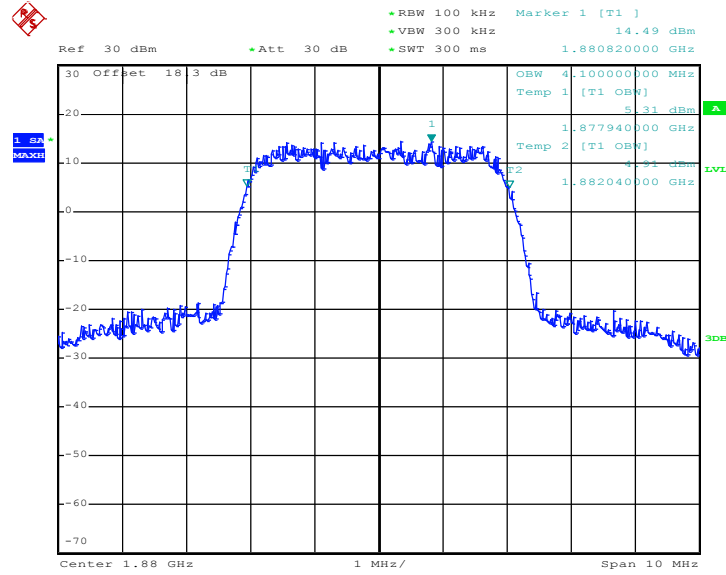

Date: 9.JUN.2013 10:17:44

26dB Bandwidth Plot on Channel 9400 (1880.0 MHz)

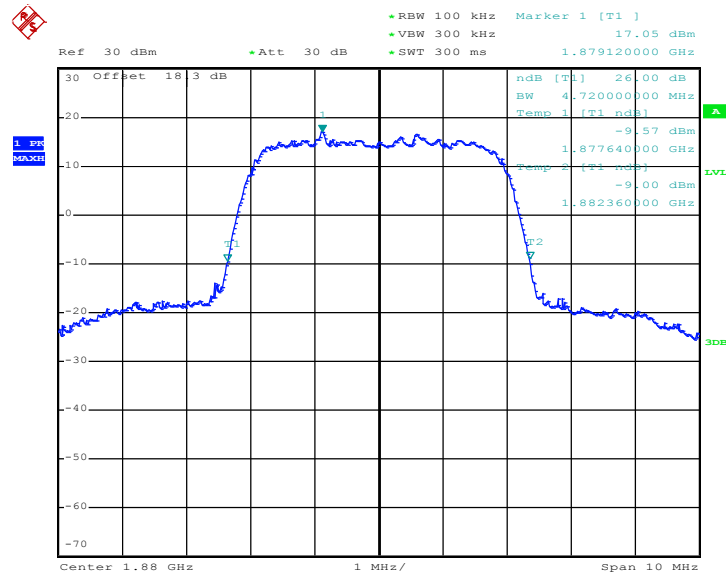

Date: 9.JUN.2013 10:16:25



99% Occupied Bandwidth Plot on Channel 9538 (1907.6 MHz)

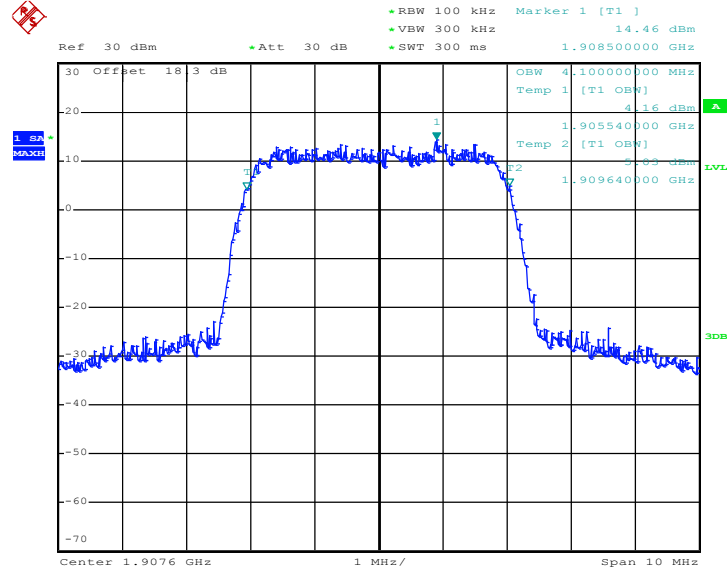

Date: 9.JUN.2013 10:18:10

26dB Bandwidth Plot on Channel 9538 (1907.6 MHz)

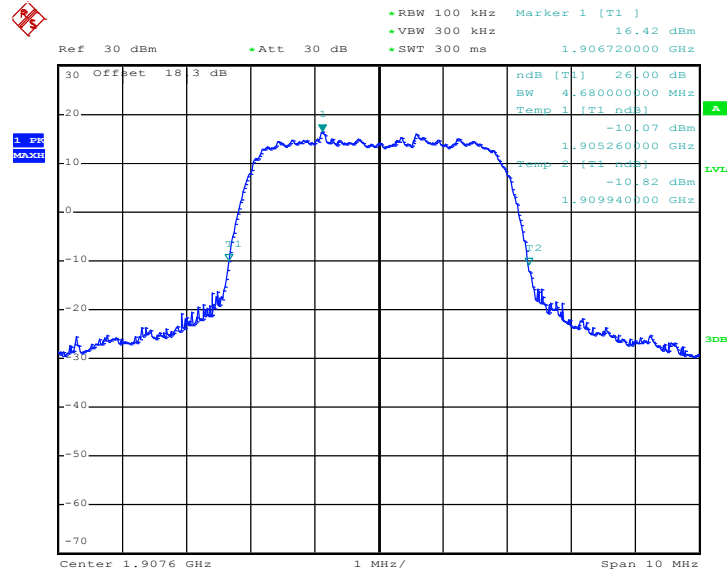

Date: 9.JUN.2013 10:16:52

3.4 Band Edge Measurement

3.4.1 Description of Band Edge Measurement

The power of any emission outside of the authorized operating frequency ranges must be lower than the transmitter power (P) by a factor of at least $43 + 10 \log (P)$ dB.

3.4.2 Measuring Instruments

See list of measuring instruments of this test report.

3.4.3 Test Procedures

1. The EUT was connected to Spectrum Analyzer and Base Station via power divider.
2. The RF output of EUT was connected to the spectrum analyzer by RF cable and attenuator. The path loss was compensated to the results for each measurement.
3. The band edges of low and high channels for the highest RF powers were measured. Setting RBW as roughly $BW/100$.
4. The RF fundamental frequency should be excluded against the limit line in the operating frequency band.
5. The limit line is derived from $43 + 10\log(P)$ dB below the transmitter power P(Watts)
 $= P(W) - [43 + 10\log(P)] \text{ (dB)}$
 $= [30 + 10\log(P)] \text{ (dBm)} - [43 + 10\log(P)] \text{ (dB)}$
 $= -13\text{dBm}.$

3.4.4 Test Setup

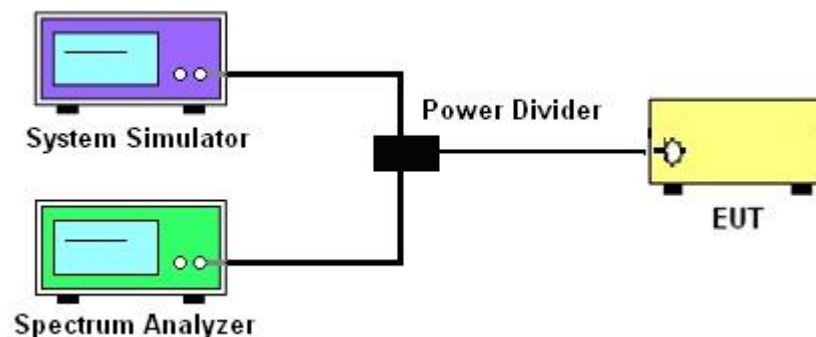

3.4.5 Test Result (Plots) of Conducted Band Edge

| | | | |
|---------------------|------------|--------------------------|--------------------------|
| Band : | GSM850 | Test Mode : | GPRS class 8 Link (GMSK) |
| Correction Factor : | 0.25 dB | Maximum 26dB Bandwidth : | 0.318MHz |
| Band Edge : | -16.63 dBm | Measurement Value : | -16.88 dBm |

Lower Band Edge Plot on Channel 128 (824.2 MHz)

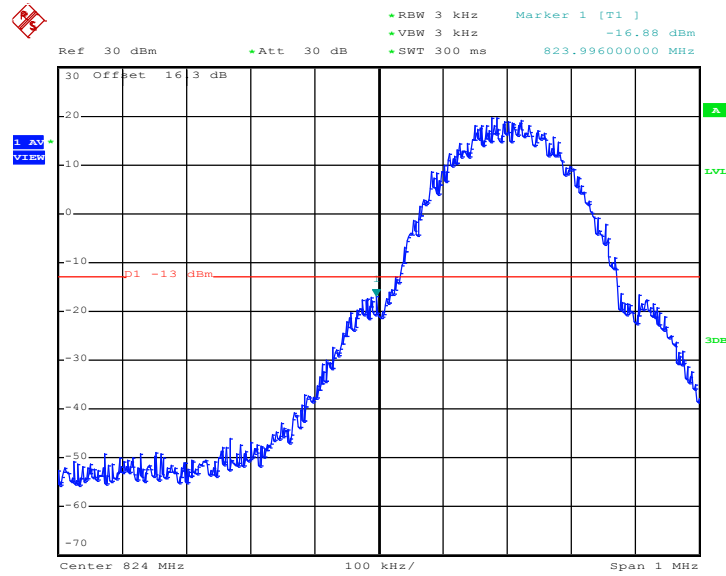

Date: 9.JUN.2013 08:27:51

1. Correction Factor(dB)= 10log(1% Emission BW/RBW)
 2. Band Edge= Measurement Value + Correction Factor(dB)
 2. Band Edge= Measurement Value + Correction Factor(dB)
- For example, -16.88 dBm + 0.25 dB = -16.63 dBm



| | | | |
|---------------------|-----------|--------------------------|--------------------------|
| Band : | GSM850 | Test Mode : | GPRS class 8 Link (QPSK) |
| Correction Factor : | 0.25 dB | Maximum 26dB Bandwidth : | 0.318MHz |
| Band Edge : | -17.18dBm | Measurement Value : | -17.43dBm |

Higher Band Edge Plot on Channel 251 (848.8 MHz)

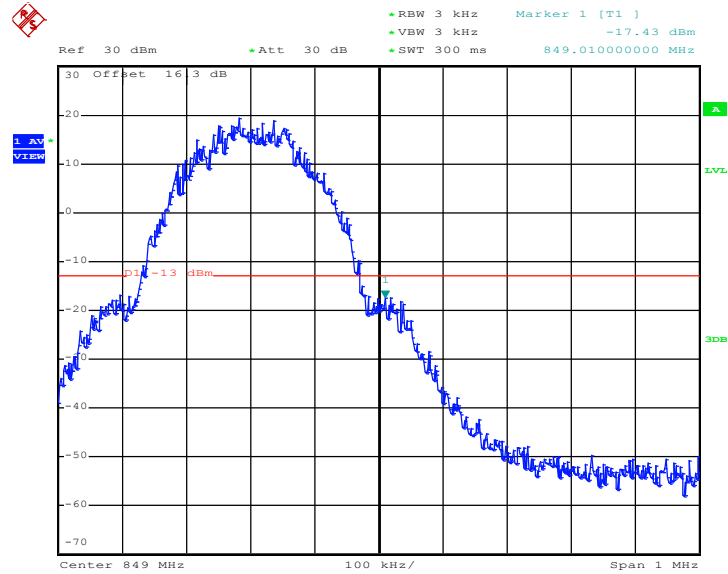

Date: 9.JUN.2013 08:28:17

1. Correction Factor(dB)= $10\log(1\% \text{ Emission BW/RBW})$
2. Band Edge= Measurement Value + Correction Factor(dB)



| | | | |
|---------------------|-----------|--------------------------|--------------------------|
| Band : | GSM850 | Test Mode : | EDGE class 8 Link (8PSK) |
| Correction Factor : | 0.06dB | Maximum 26dB Bandwidth : | 0.304MHz |
| Band Edge : | -19.53dBm | Measurement Value : | -19.59dBm |

Lower Band Edge Plot on Channel 128 (824.2 MHz)

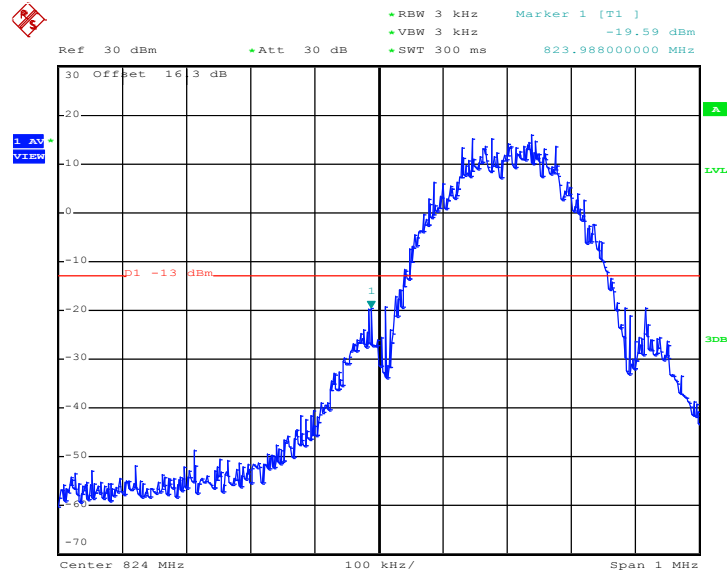

Date: 9.JUN.2013 15:21:35

1. Correction Factor(dB)= $10\log(1\% \text{ Emission BW/RBW})$
2. Band Edge= Measurement Value + Correction Factor(dB)



| | | | |
|----------------------------|-----------|---------------------------------|--------------------------|
| Band : | GSM850 | Test Mode : | EDGE class 8 Link (8PSK) |
| Correction Factor : | 0.06dB | Maximum 26dB Bandwidth : | 0.304MHz |
| Band Edge : | -19.14dBm | Measurement Value : | -19.20dBm |

Higher Band Edge Plot on Channel 251 (848.8 MHz)

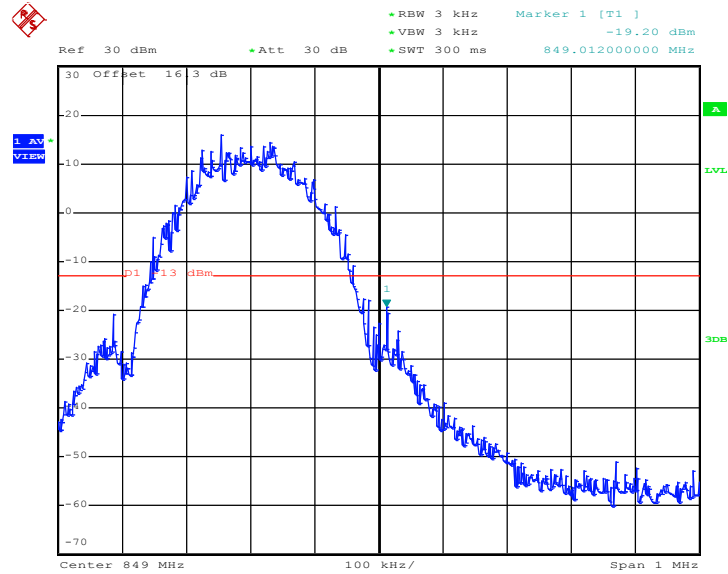

Date: 9.JUN.2013 15:22:01

1. Correction Factor(dB)= $10\log(1\% \text{ Emission BW/RBW})$
2. Band Edge= Measurement Value + Correction Factor(dB)



| | | | |
|---------------------|-----------|--------------------------|--------------------------|
| Band : | GSM1900 | Test Mode : | GPRS class 8 Link (GMSK) |
| Correction Factor : | 0.23dB | Maximum 26dB Bandwidth : | 0.316MHz |
| Band Edge : | -18.68dBm | Measurement Value : | -18.91dBm |

Lower Band Edge Plot on Channel 512 (1850.2 MHz)

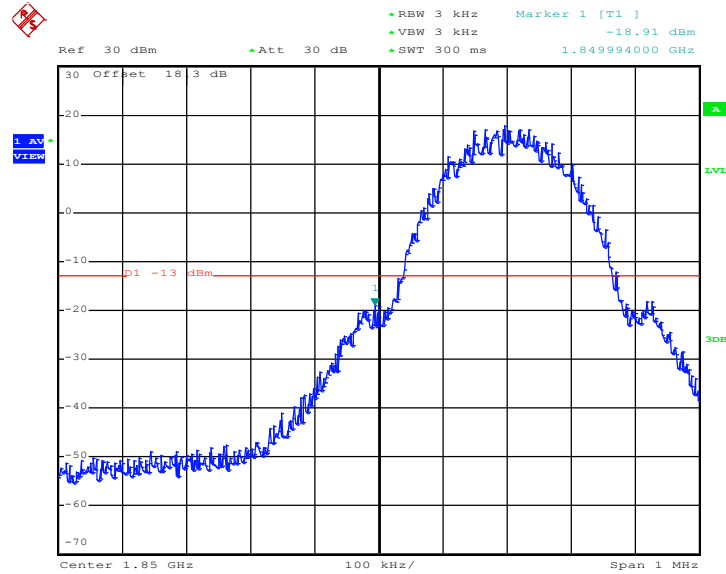

Date: 9.JUN.2013 09:05:44

1. Correction Factor(dB)= $10\log(1\% \text{ Emission BW/RBW})$
2. Band Edge= Measurement Value + Correction Factor(dB)



| | | | |
|---------------------|-----------|--------------------------|--------------------------|
| Band : | GSM1900 | Test Mode : | GPRS class 8 Link (GMSK) |
| Correction Factor : | 0.23dB | Maximum 26dB Bandwidth : | 0.316MHz |
| Band Edge : | -19.18dBm | Measurement Value : | -19.41dBm |

Higher Band Edge Plot on Channel 810 (1909.8 MHz)

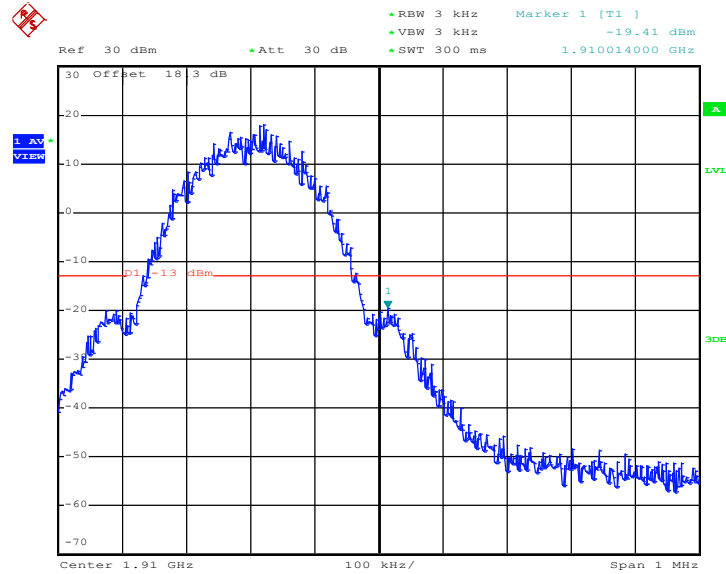

Date: 9.JUN.2013 09:02:55

1. Correction Factor(dB)= $10\log(1\% \text{ Emission BW/RBW})$
2. Band Edge= Measurement Value + Correction Factor(dB)



| | | | |
|----------------------------|-----------|---------------------------------|--------------------------|
| Band : | GSM1900 | Test Mode : | EDGE class 8 Link (8PSK) |
| Correction Factor : | 0.20dB | Maximum 26dB Bandwidth : | 0.314MHz |
| Band Edge : | -24.02dBm | Measurement Value : | -24.22dBm |

Lower Band Edge Plot on Channel 512 (1850.2 MHz)

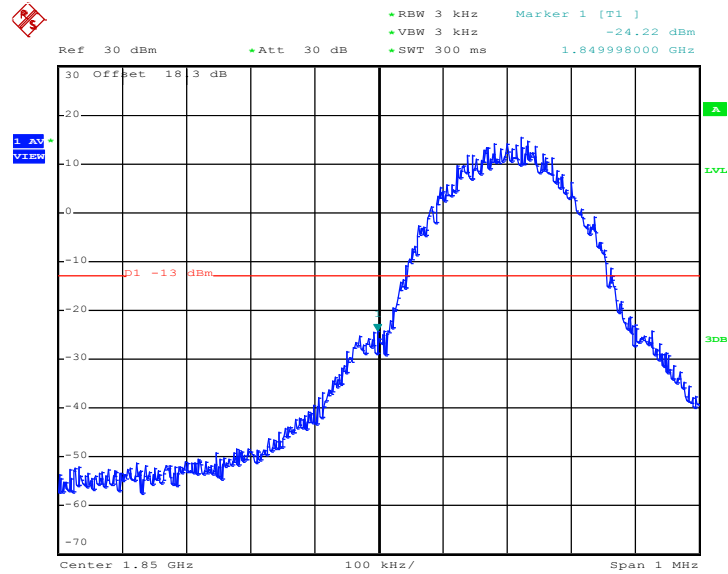

Date: 9.JUN.2013 09:50:09

1. Correction Factor(dB)= 10log(1% Emission BW/RBW)
2. Band Edge= Measurement Value + Correction Factor(dB)



| | | | |
|---------------------|-----------|--------------------------|--------------------------|
| Band : | GSM1900 | Test Mode : | EDGE class 8 Link (8PSK) |
| Correction Factor : | 0.20dB | Maximum 26dB Bandwidth : | 0.314MHz |
| Band Edge : | -24.42dBm | Measurement Value : | -24.62dBm |

Higher Band Edge Plot on Channel 810 (1909.8 MHz)

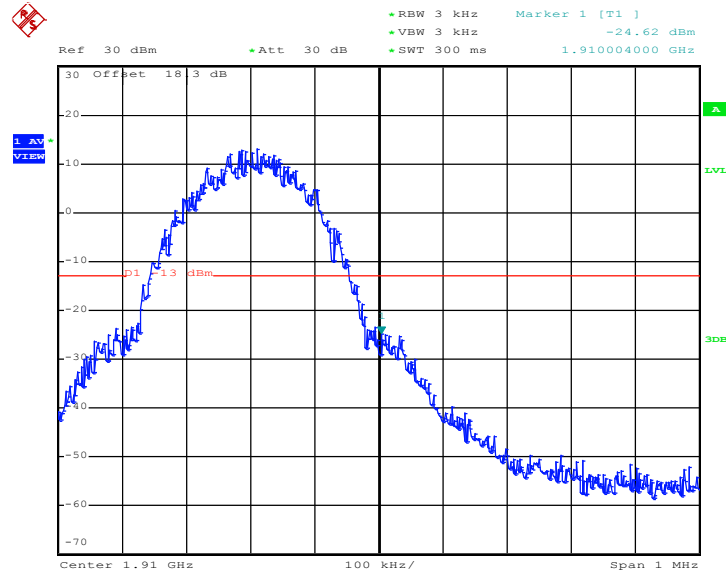

Date: 9.JUN.2013 09:48:32

1. Correction Factor(dB)= $10\log(1\% \text{ Emission BW/RBW})$
2. Band Edge= Measurement Value + Correction Factor(dB)



| | | | |
|----------------------------|--------------|---------------------------------|--------------------------|
| Band : | WCDMA Band V | Test Mode : | RMC 12.2kbps Link (QPSK) |
| Correction Factor : | -3.19dB | Maximum 26dB Bandwidth : | 4.800MHz |
| Band Edge : | -22.09dBm | Measurement Value : | -18.90dBm |

Lower Band Edge Plot on Channel 4132 (826.4 MHz)

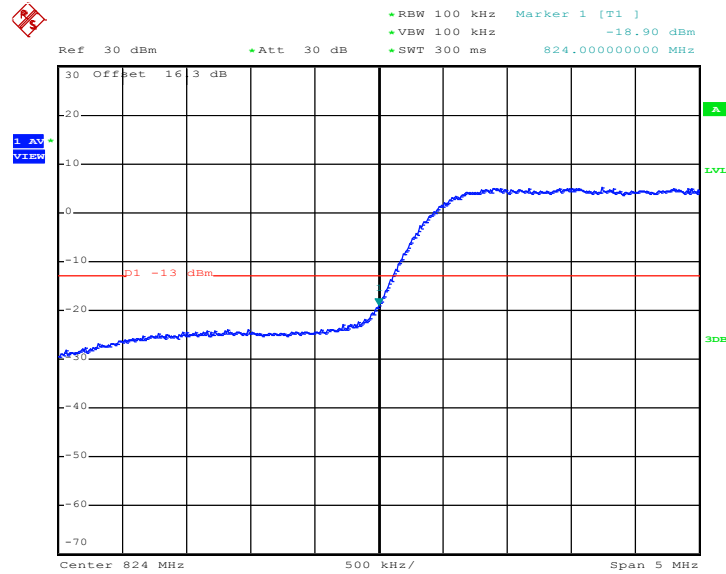

Date: 9.JUN.2013 10:28:19

1. Correction Factor(dB)= 10log(1% Emission BW/RBW)
2. Band Edge= Measurement Value + Correction Factor(dB)



| | | | |
|---------------------|--------------|--------------------------|--------------------------|
| Band : | WCDMA Band V | Test Mode : | RMC 12.2kbps Link (QPSK) |
| Correction Factor : | -3.19dB | Maximum 26dB Bandwidth : | 4.800MHz |
| Band Edge : | -22.48dBm | Measurement Value : | -19.29dBm |

Higher Band Edge Plot on Channel 4233 (846.6 MHz)

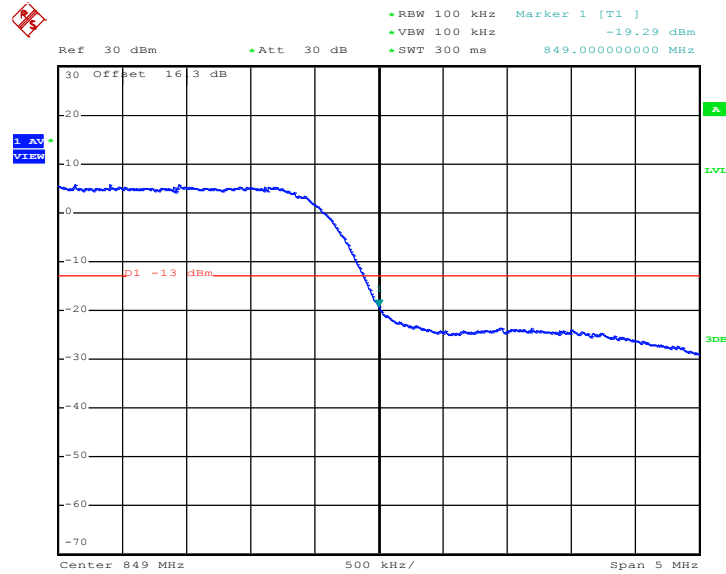

Date: 9.JUN.2013 10:28:47

1. Correction Factor(dB)= $10\log(1\% \text{ Emission BW/RBW})$
2. Band Edge= Measurement Value + Correction Factor(dB)



| | | | |
|---------------------|---------------|--------------------------|-----------------------------|
| Band : | WCDMA Band IV | Test Mode : | RMC 12.2kbps Link (QPSK) |
| Correction Factor : | -1.33dB | Maximum 26dB Bandwidth : | 7.360MHz |
| Band Edge : | -18.93 dBm | Measurement Value : | -17.60dBm |

Lower Band Edge Plot on Channel 1312 (1712.4 MHz)

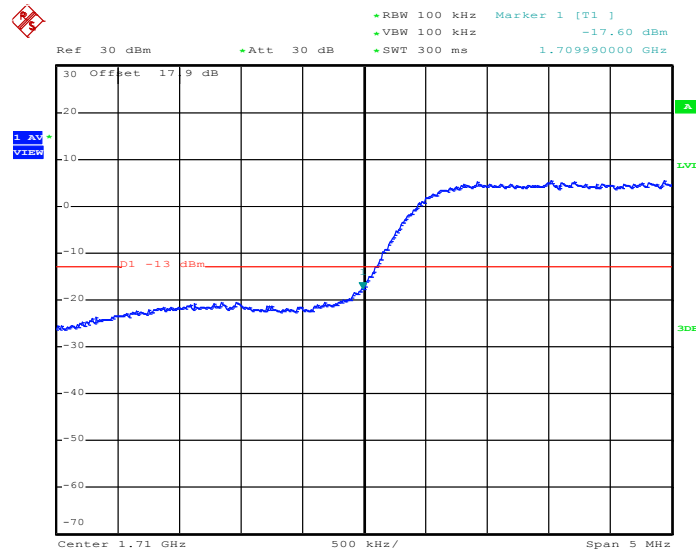

Date: 9.JUN.2013 10:36:50

1. Correction Factor(dB)= $10\log(1\% \text{ Emission BW/RBW})$
2. Band Edge= Measurement Value + Correction Factor(dB)



| | | | |
|---------------------|---------------|--------------------------|-----------------------------|
| Band : | WCDMA Band IV | Test Mode : | RMC 12.2kbps Link (QPSK) |
| Correction Factor : | -1.33dB | Maximum 26dB Bandwidth : | 7.360MHz |
| Band Edge : | -15.11 dBm | Measurement Value : | -13.78 dBm |

Higher Band Edge Plot on Channel 1513 (1752.6 MHz)

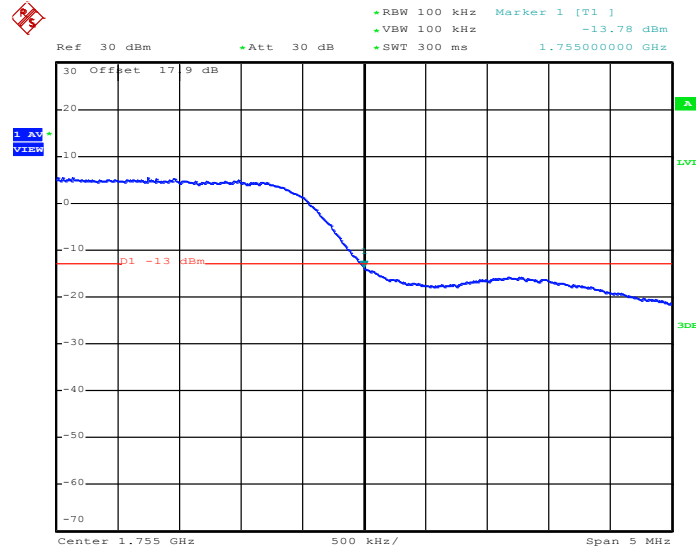

Date: 9.JUN.2013 10:37:17

1. Correction Factor(dB)= $10\log(1\% \text{ Emission BW/RBW})$
2. Band Edge= Measurement Value + Correction Factor(dB)



| | | | |
|----------------------------|---------------|---------------------------------|--------------------------|
| Band : | WCDMA Band II | Test Mode : | RMC 12.2kbps Link (QPSK) |
| Correction Factor : | -3.26dB | Maximum 26dB Bandwidth : | 4.720MHz |
| Band Edge : | -32.49dBm | Measurement Value : | -29.23dBm |

Lower Band Edge Plot on Channel 9262 (1852.4 MHz)

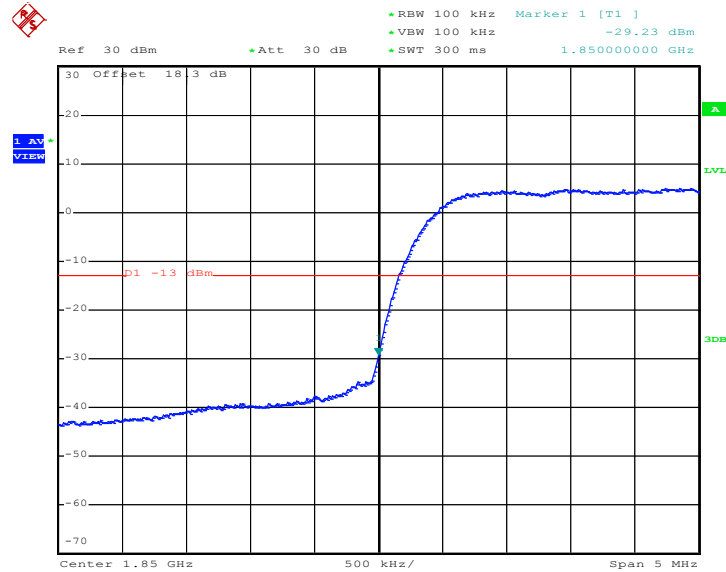

Date: 9.JUN.2013 10:18:38

1. Correction Factor(dB)= $10\log(1\% \text{ Emission BW/RBW})$
2. Band Edge= Measurement Value + Correction Factor(dB)



| | | | |
|----------------------------|---------------|---------------------------------|--------------------------|
| Band : | WCDMA Band II | Test Mode : | RMC 12.2kbps Link (QPSK) |
| Correction Factor : | -3.26dB | Maximum 26dB Bandwidth : | 4.720MHz |
| Band Edge : | -29.09dBm | Measurement Value : | -25.83dBm |

Higher Band Edge Plot on Channel 9538 (1907.6 MHz)

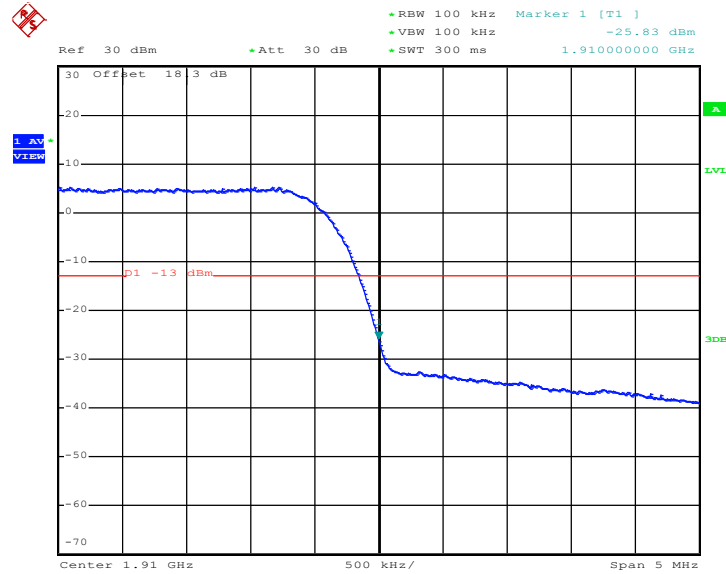

Date: 9.JUN.2013 10:19:05

1. Correction Factor(dB)= 10log(1% Emission BW/RBW)
2. Band Edge= Measurement Value + Correction Factor(dB)

3.5 Conducted Spurious Emission Measurement

3.5.1 Description of Conducted Spurious Emission Measurement

The power of any emission outside of the authorized operating frequency ranges must be lower than the transmitter power (P) by a factor of at least $43 + 10 \log (P)$ dB.

It is measured by means of a calibrated spectrum analyzer and scanned from 30 MHz up to a frequency including its 10th harmonic.

3.5.2 Measuring Instruments

See list of measuring instruments of this test report.

3.5.3 Test Procedures

1. The EUT was connected to spectrum analyzer and base station via power divider.
2. The RF output of EUT was connected to the spectrum analyzer by RF cable and attenuator. The path loss was compensated to the results for each measurement.
3. The middle channel for the highest RF power within the transmitting frequency was measured.
4. The conducted spurious emission for the whole frequency range was taken.
5. The RF fundamental frequency should be excluded against the limit line in the operating frequency band.
6. The limit line is derived from $43 + 10\log(P)$ dB below the transmitter power P(Watts)
 $= P(W) - [43 + 10\log(P)]$ (dB)
 $= [30 + 10\log(P)]$ (dBm) - $[43 + 10\log(P)]$ (dB)
 $= -13\text{dBm}$.

3.5.4 Test Setup

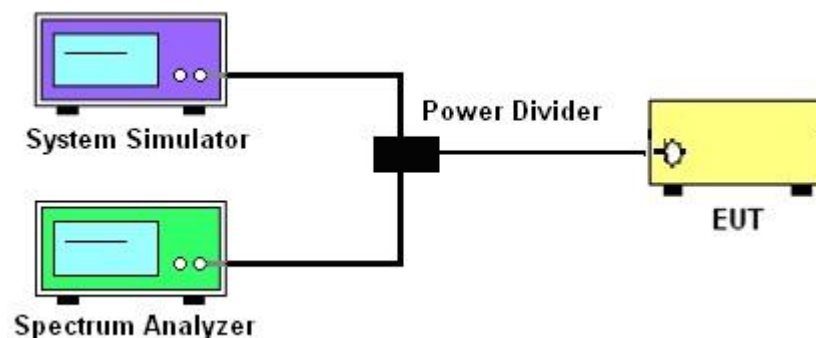



3.5.5 Test Result (Plots) of Conducted Emission

| | | | |
|-------------|--------------------------|-------------|-----------|
| Band : | GSM850 | Channel : | CH189 |
| Test Mode : | GPRS class 8 Link (GMSK) | Frequency : | 836.4 MHz |

Conducted Spurious Emission Plot between 30MHz ~ 1GHz

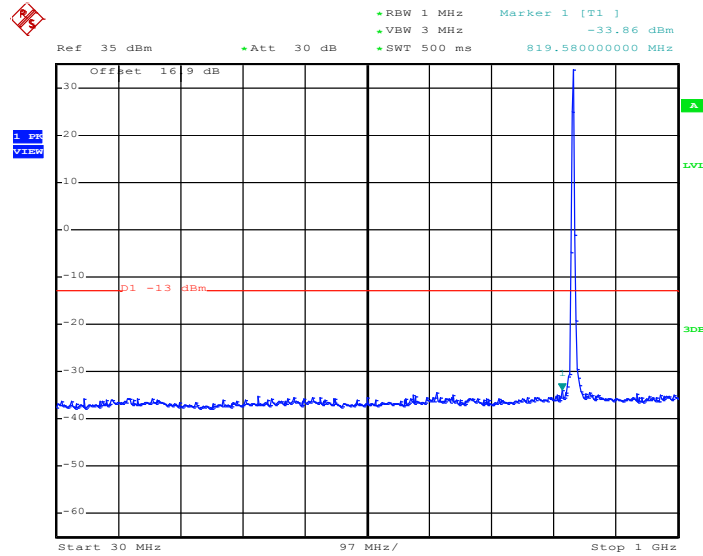

Date: 9.JUN.2013 08:23:44

Conducted Spurious Emission Plot between 1GHz ~ 3GHz

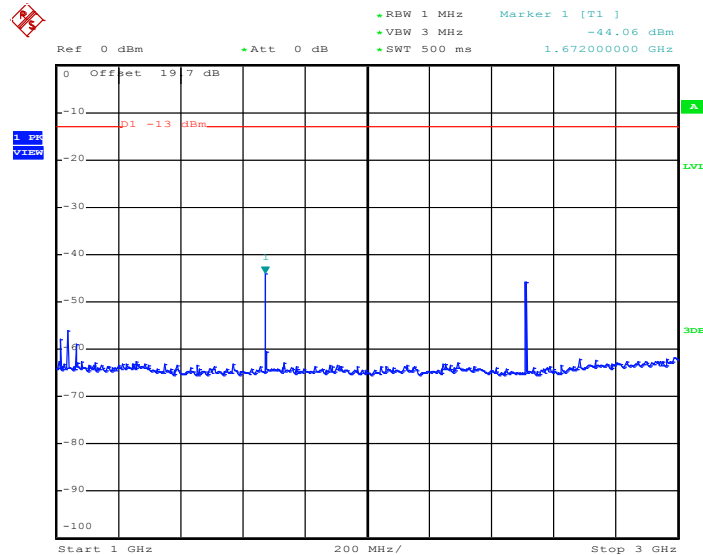

Date: 9.JUN.2013 08:24:03



Conducted Spurious Emission Plot between 3GHz ~ 7GHz

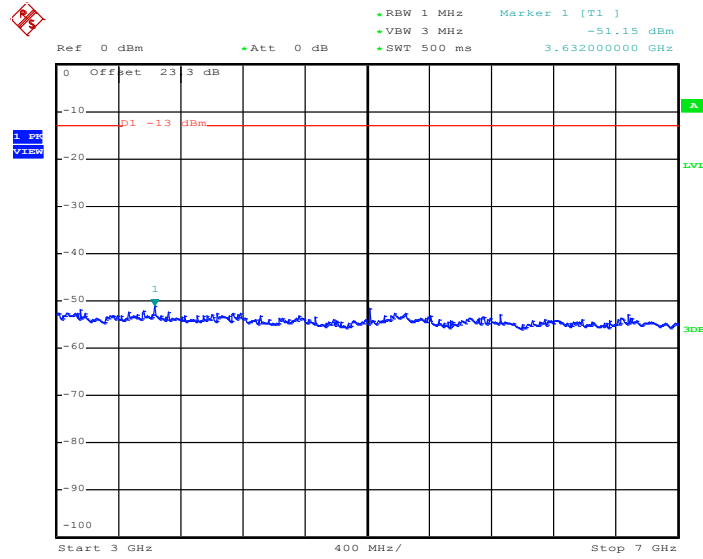

Date: 9.JUN.2013 08:24:15

Conducted Spurious Emission Plot between 7GHz ~ 9GHz

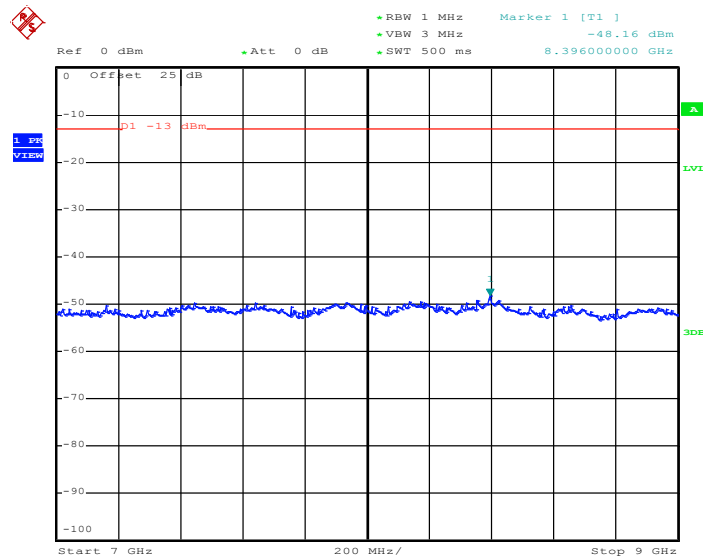

Date: 9.JUN.2013 08:24:28



| | | | |
|-------------|--------------------------|-------------|-----------|
| Band : | GSM850 | Channel : | CH189 |
| Test Mode : | EDGE class 8 Link (8PSK) | Frequency : | 836.4 MHz |

Conducted Spurious Emission Plot between 30MHz ~ 1GHz

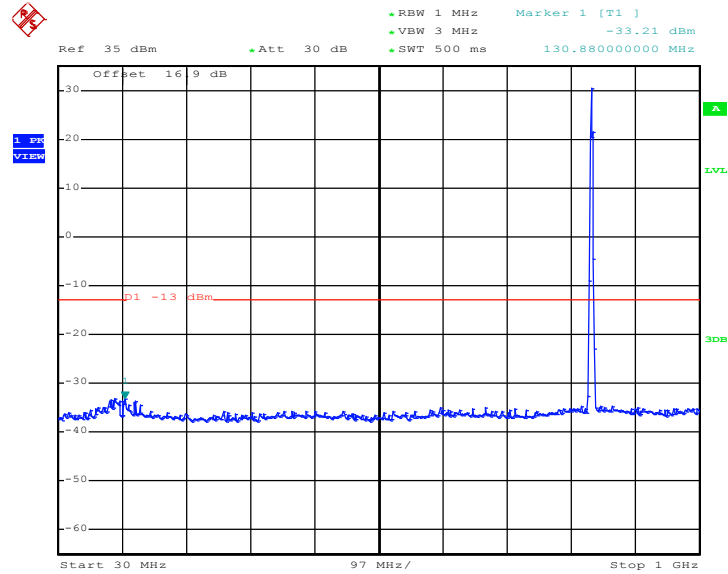

Date: 9.JUN.2013 15:17:39

Conducted Spurious Emission Plot between 1GHz ~ 3GHz

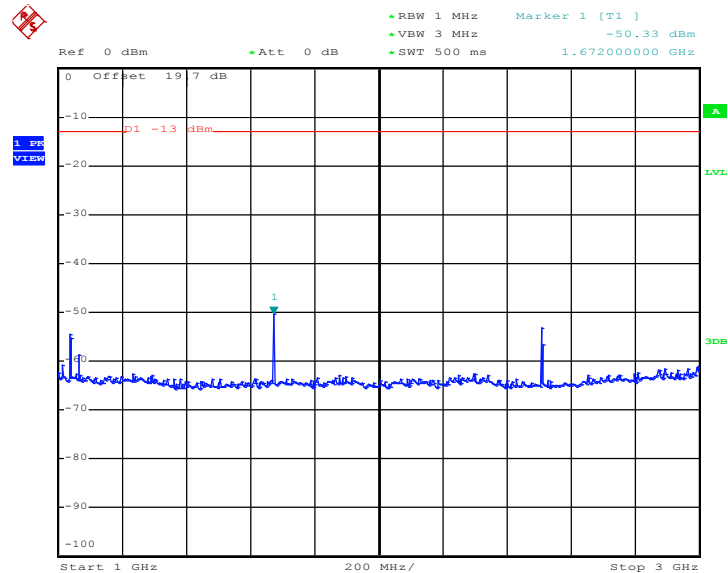

Date: 9.JUN.2013 15:17:56



Conducted Spurious Emission Plot between 3GHz ~ 7GHz

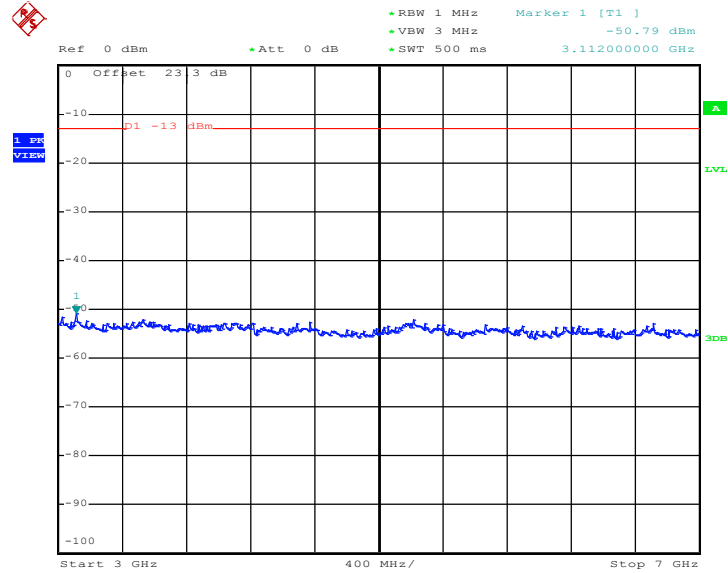

Date: 9.JUN.2013 15:18:09

Conducted Spurious Emission Plot between 7GHz ~ 9GHz

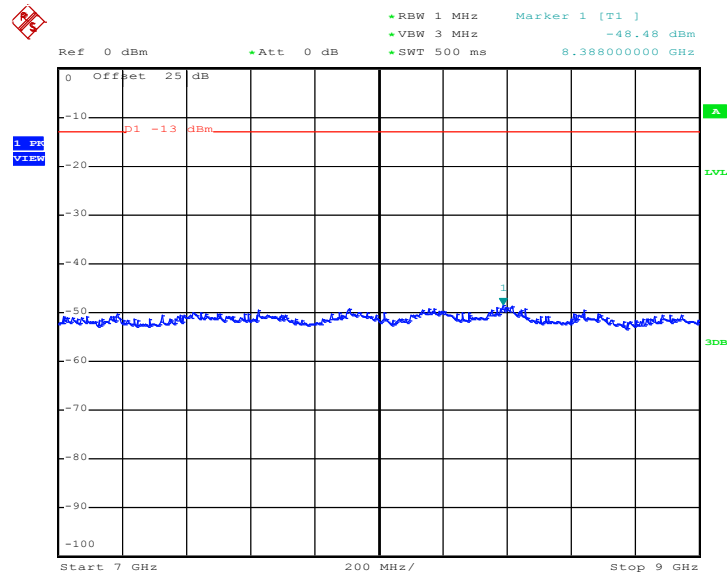

Date: 9.JUN.2013 15:18:21



| | | | |
|-------------|--------------------------|-------------|------------|
| Band : | GSM1900 | Channel : | CH661 |
| Test Mode : | GPRS class 8 Link (GMSK) | Frequency : | 1880.0 MHz |

Conducted Spurious Emission Plot between 30MHz ~ 1GHz

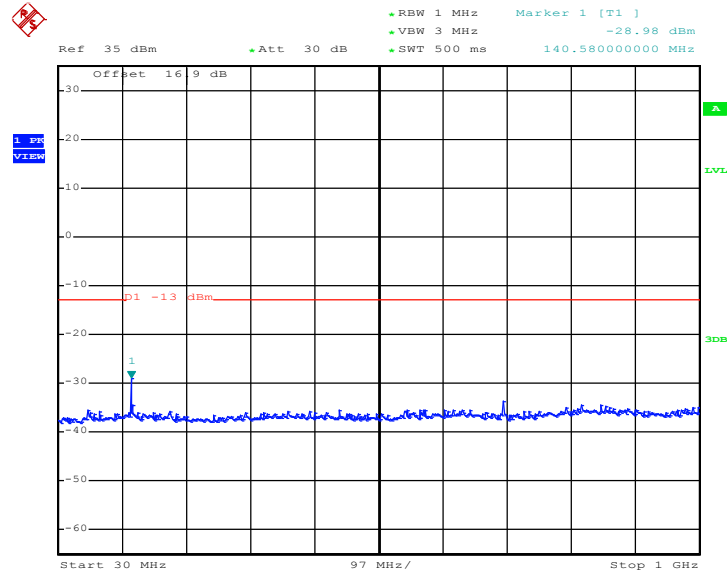

Date: 9.JUN.2013 08:57:18

Conducted Spurious Emission Plot between 1GHz ~ 3GHz

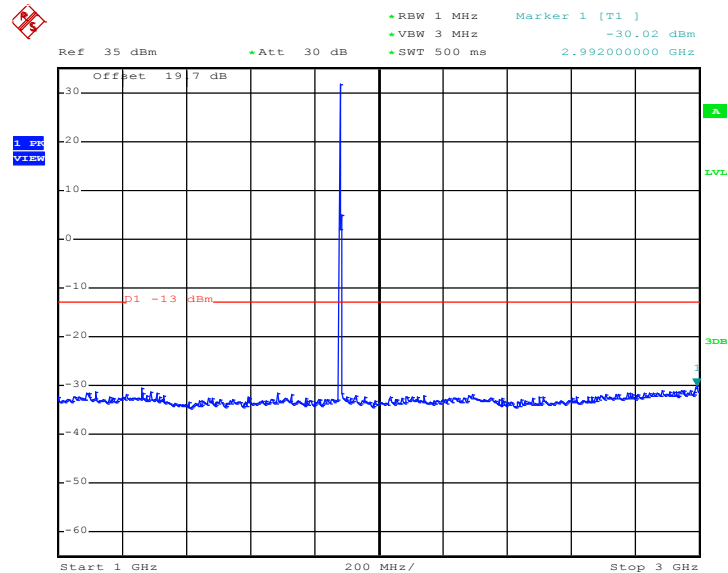

Date: 9.JUN.2013 08:57:30



Conducted Spurious Emission Plot between 3GHz ~ 7GHz

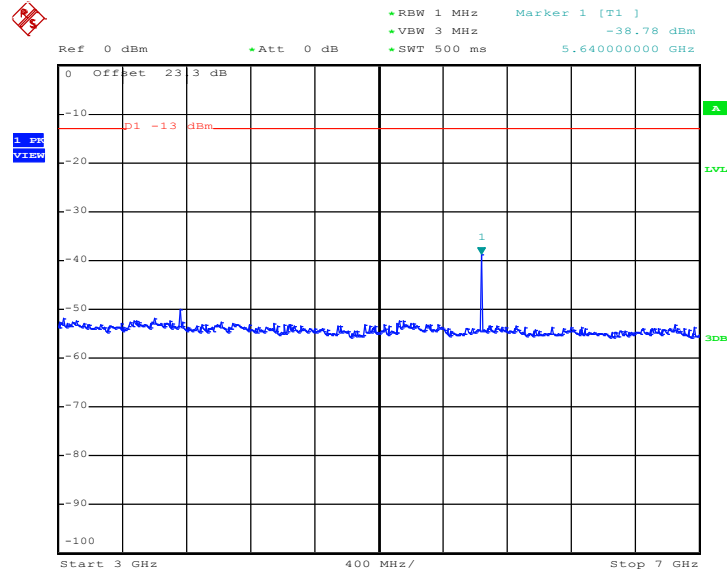

Date: 9.JUN.2013 08:57:48

Conducted Spurious Emission Plot between 7GHz ~ 13.6G

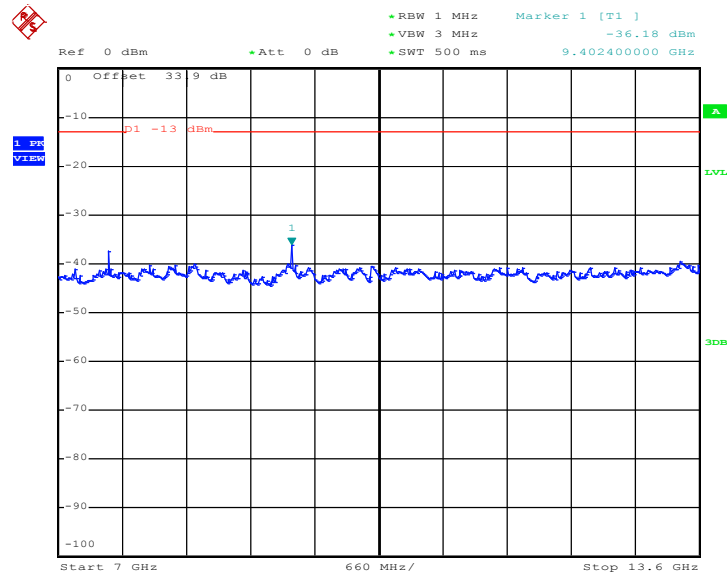

Date: 9.JUN.2013 08:58:01



Conducted Spurious Emission Plot between 13.6GHz ~ 19.1GHz

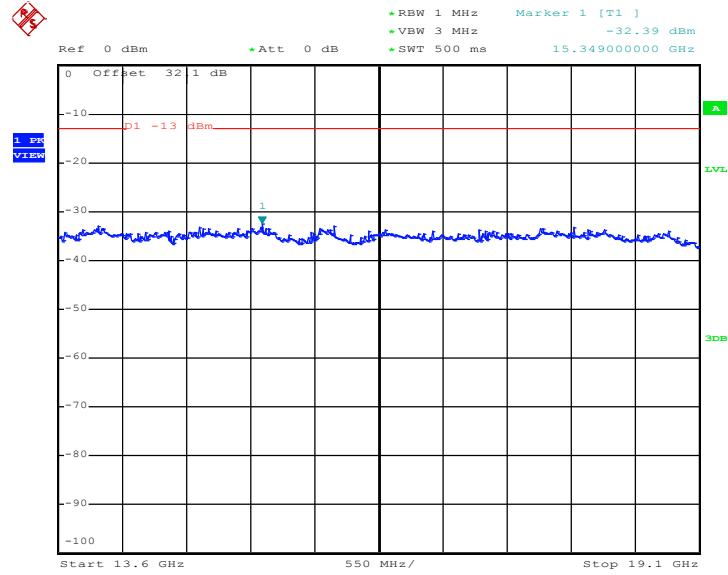

Date: 9.JUN.2013 08:58:13



| | | | |
|-------------|--------------------------|-------------|------------|
| Band : | GSM1900 | Channel : | CH661 |
| Test Mode : | EDGE class 8 Link (8PSK) | Frequency : | 1880.0 MHz |

Conducted Spurious Emission Plot between 30MHz ~ 1GHz

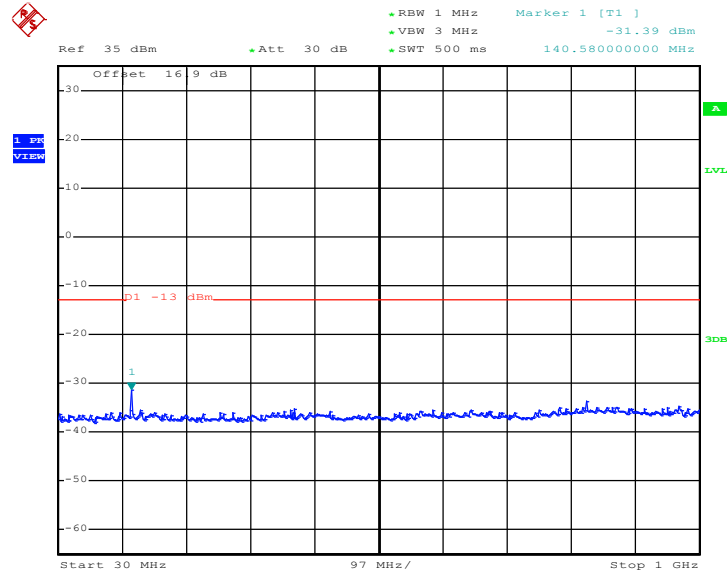

Date: 9.JUN.2013 09:43:48

Conducted Spurious Emission Plot between 1GHz ~ 3GHz

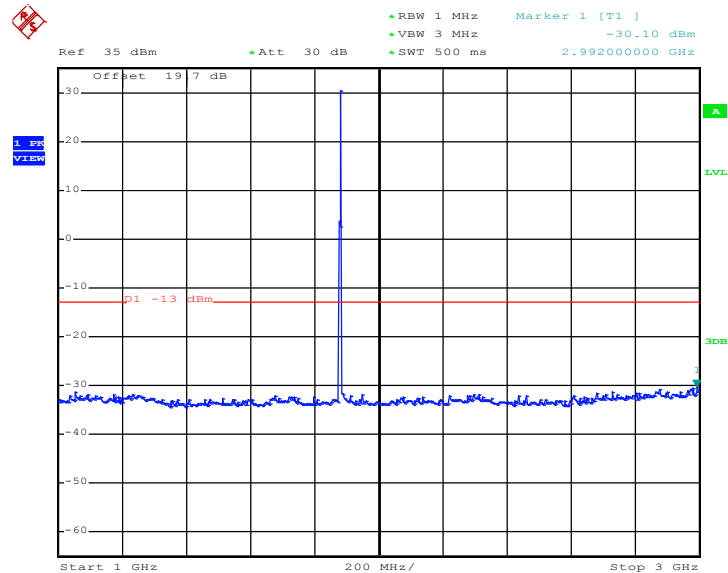

Date: 9.JUN.2013 09:44:00



Conducted Spurious Emission Plot between 3GHz ~ 7GHz

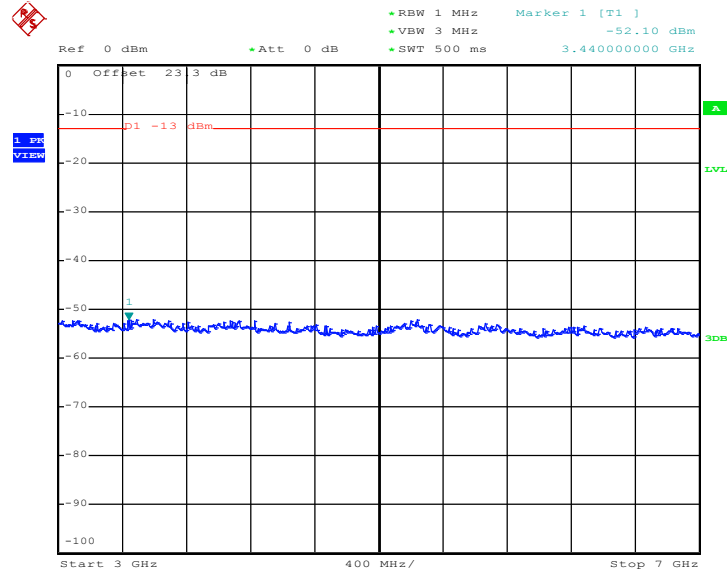

Date: 9.JUN.2013 09:44:18

Conducted Spurious Emission Plot between 7GHz ~ 13.6GHz

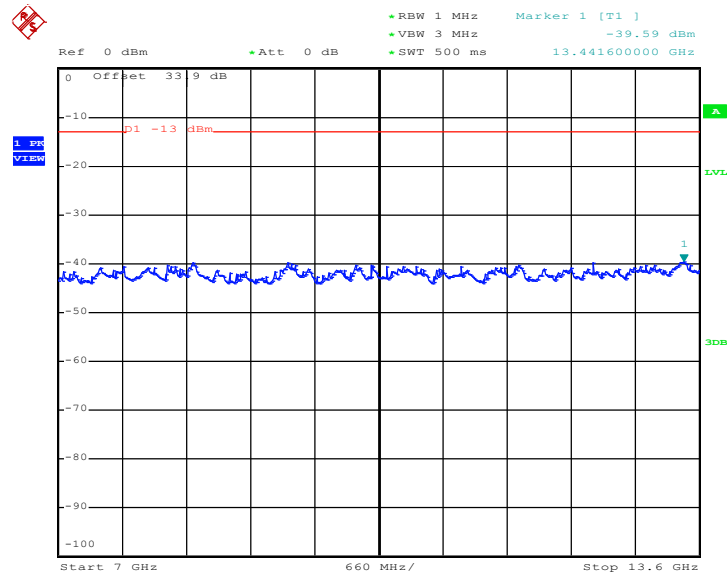

Date: 9.JUN.2013 09:44:31



Conducted Spurious Emission Plot between 13.6GHz ~ 19.1GHz

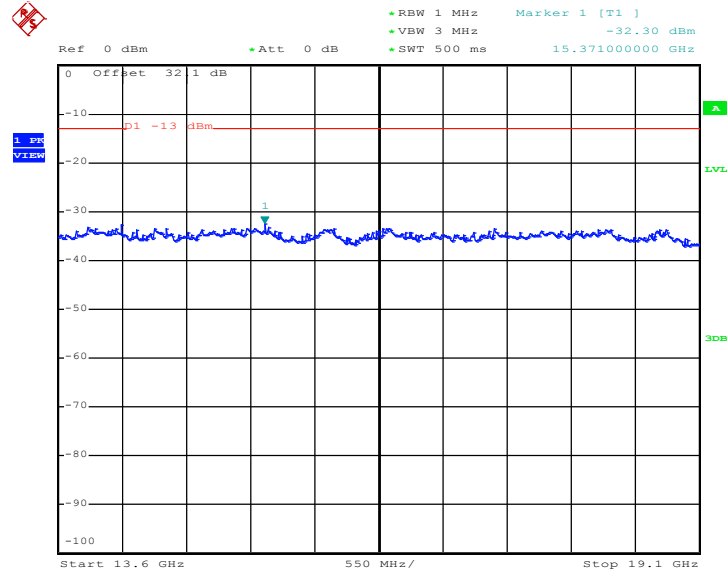

Date: 9.JUN.2013 09:44:43



| | | | |
|-------------|--------------------------|-------------|-----------|
| Band : | WCDMA Band V | Channel : | CH4182 |
| Test Mode : | RMC 12.2kbps Link (QPSK) | Frequency : | 836.4 MHz |

Conducted Spurious Emission Plot between 30MHz ~ 1GHz

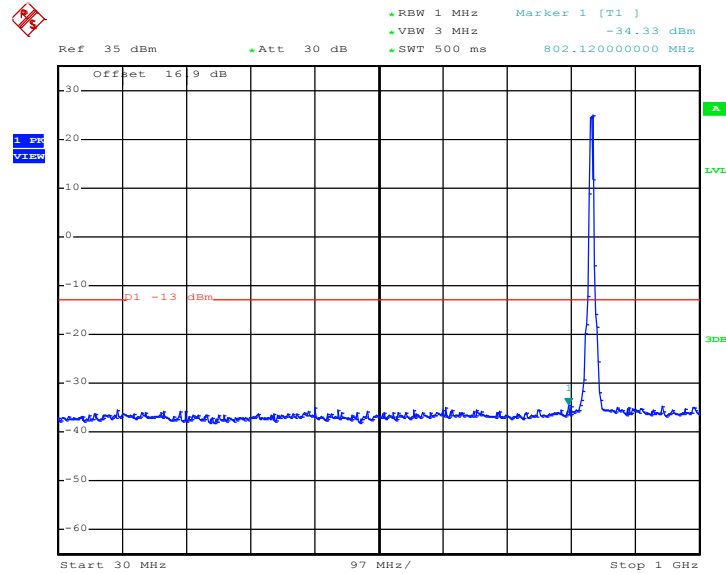

Date: 9.JUN.2013 10:24:12

Conducted Spurious Emission Plot between 1GHz ~ 3GHz

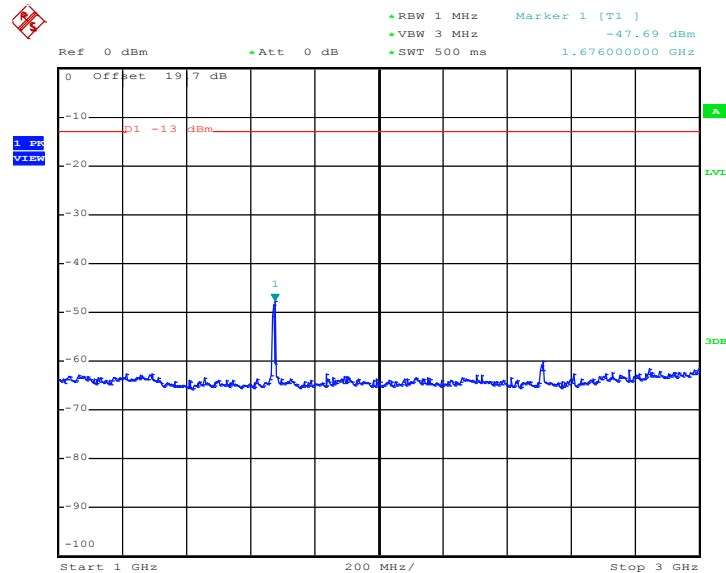

Date: 9.JUN.2013 10:24:29



Conducted Spurious Emission Plot between 3GHz ~ 7GHz

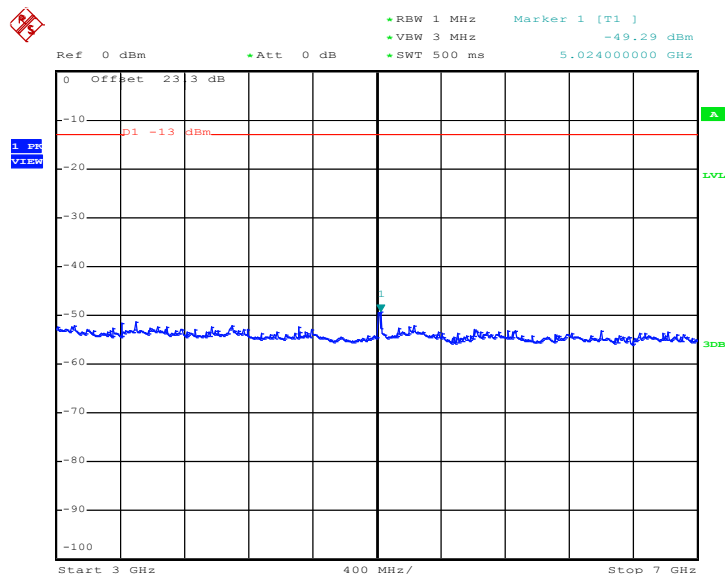

Date: 9.JUN.2013 10:24:41

Conducted Spurious Emission Plot between 7GHz ~ 9GHz

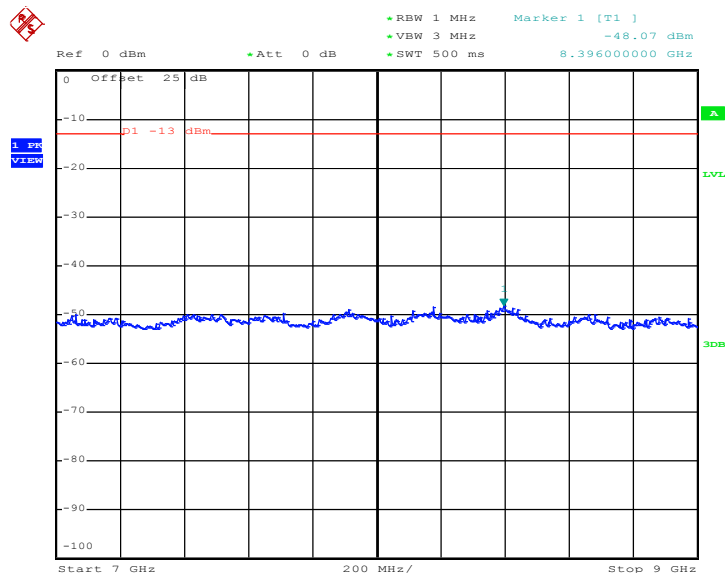

Date: 9.JUN.2013 10:24:54



| | | | |
|-------------|--------------------------|-------------|------------|
| Band : | WCDMA Band IV | Channel : | CH1413 |
| Test Mode : | RMC 12.2kbps Link (QPSK) | Frequency : | 1732.6 MHz |

Conducted Spurious Emission Plot between 30MHz ~ 1GHz

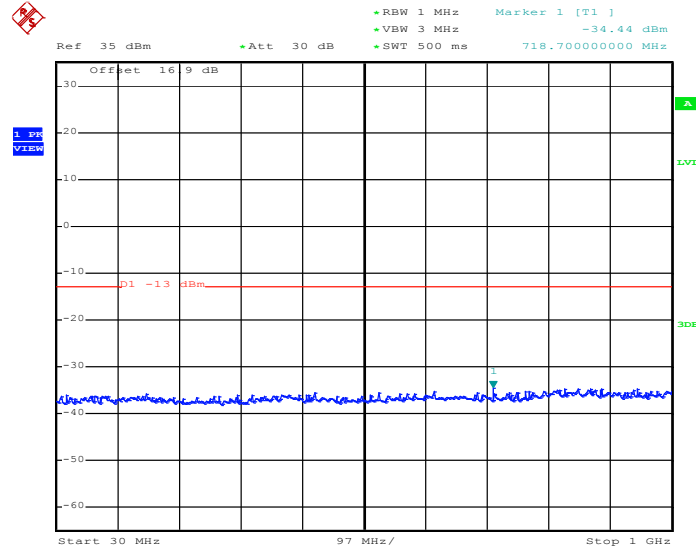

Date: 9.JUN.2013 10:32:31

Conducted Spurious Emission Plot between 1GHz ~ 3GHz

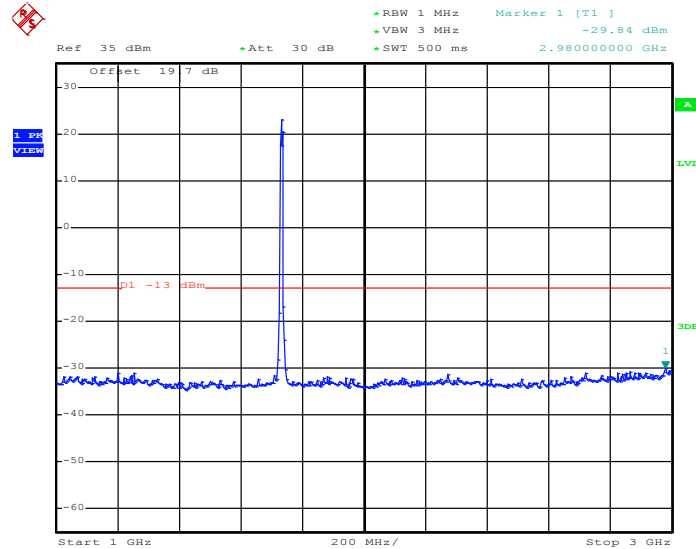

Date: 9.JUN.2013 10:32:43



Conducted Spurious Emission Plot between 3GHz ~ 7GHz

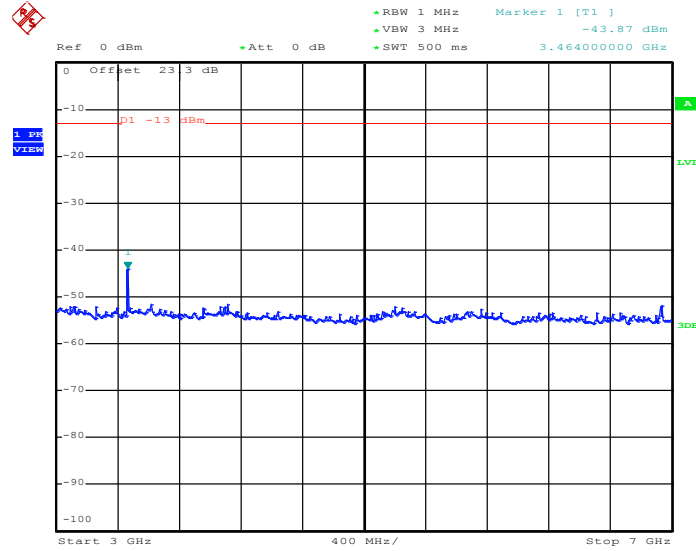

Date: 9.JUN.2013 10:32:59

Conducted Spurious Emission Plot between 7GHz ~ 13.6GHz

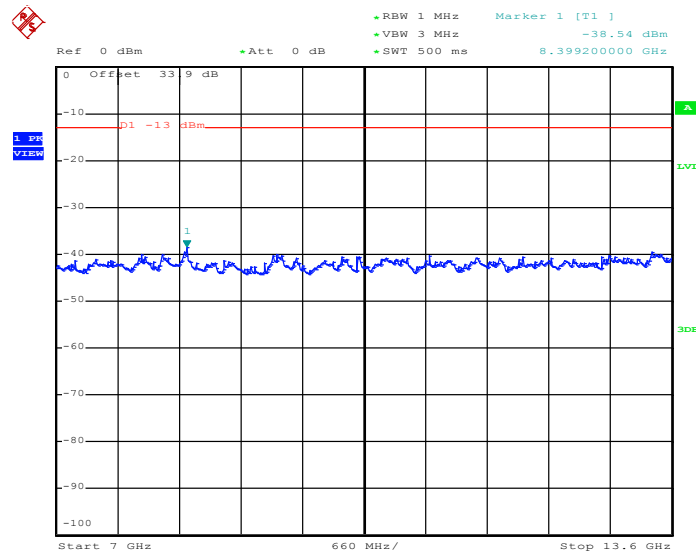

Date: 9.JUN.2013 10:33:12



Conducted Spurious Emission Plot between 13.6GHz ~ 18GHz

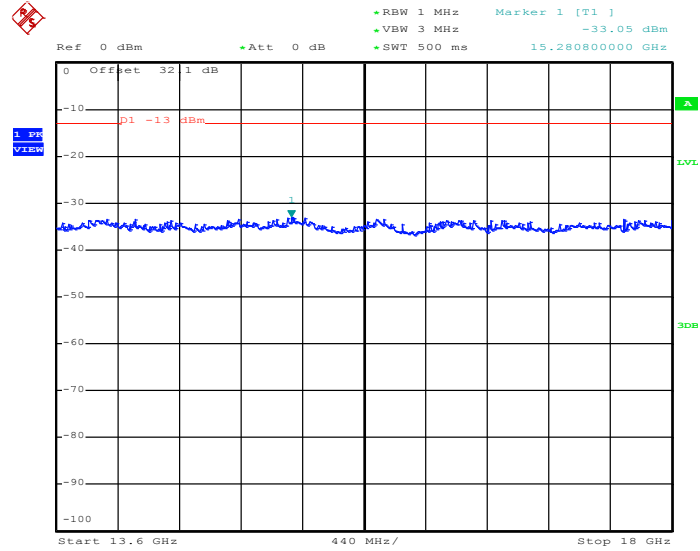

Date: 9.JUN.2013 10:33:24



| | | | |
|-------------|--------------------------|-------------|------------|
| Band : | WCDMA Band II | Channel : | CH9400 |
| Test Mode : | RMC 12.2kbps Link (QPSK) | Frequency : | 1880.0 MHz |

Conducted Spurious Emission Plot between 30MHz ~ 1GHz

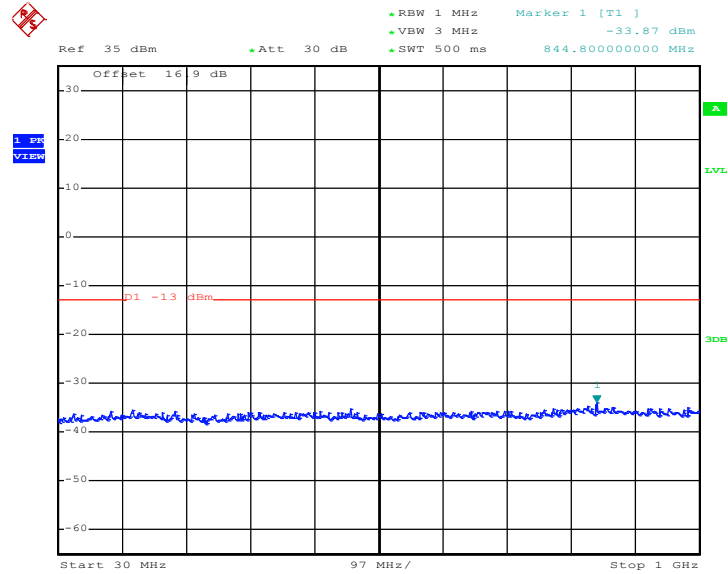

Date: 9.JUN.2013 10:13:43

Conducted Spurious Emission Plot between 1GHz ~ 3GHz

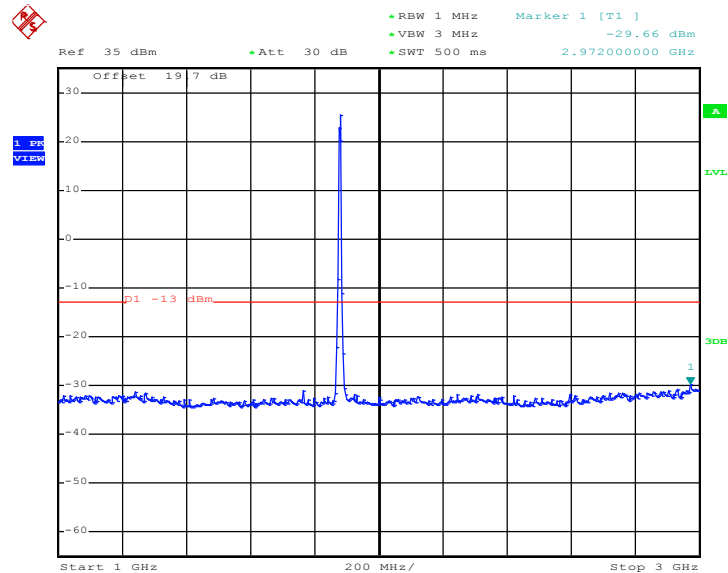

Date: 9.JUN.2013 10:14:19



Conducted Spurious Emission Plot between 3GHz ~ 7GHz

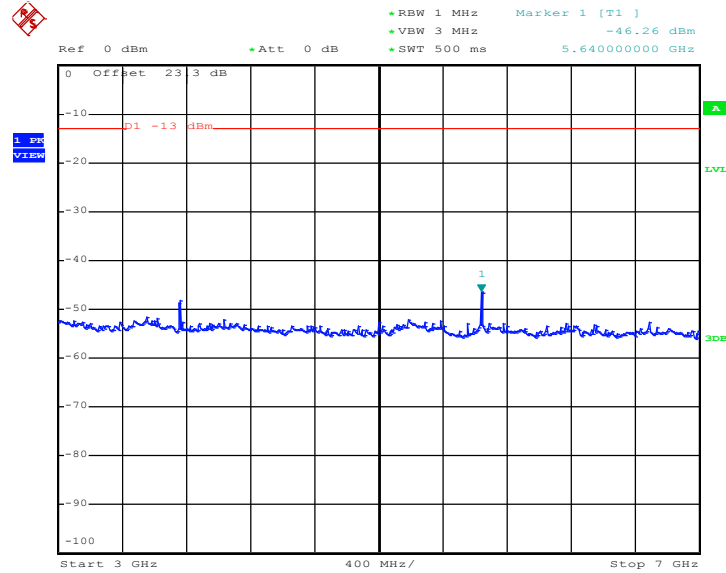

Date: 9.JUN.2013 10:14:52

Conducted Spurious Emission Plot between 7GHz ~ 13.6GHz

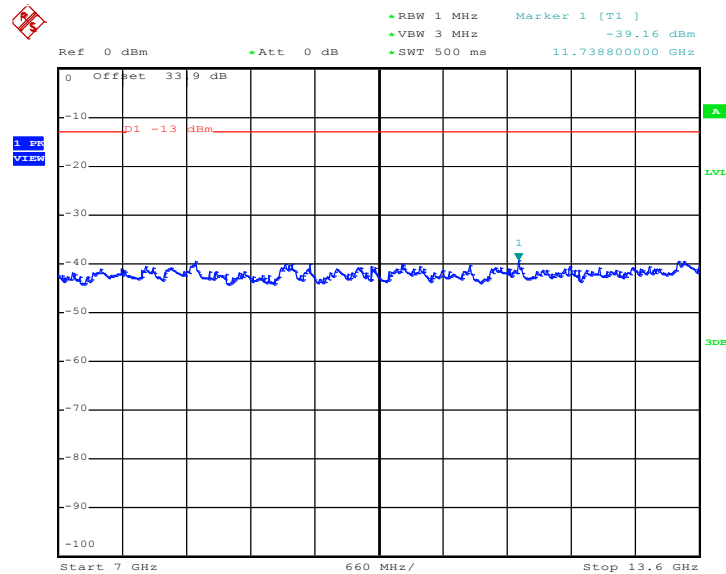

Date: 9.JUN.2013 10:15:04



Conducted Spurious Emission Plot between 13.6GHz ~ 19.1GHz

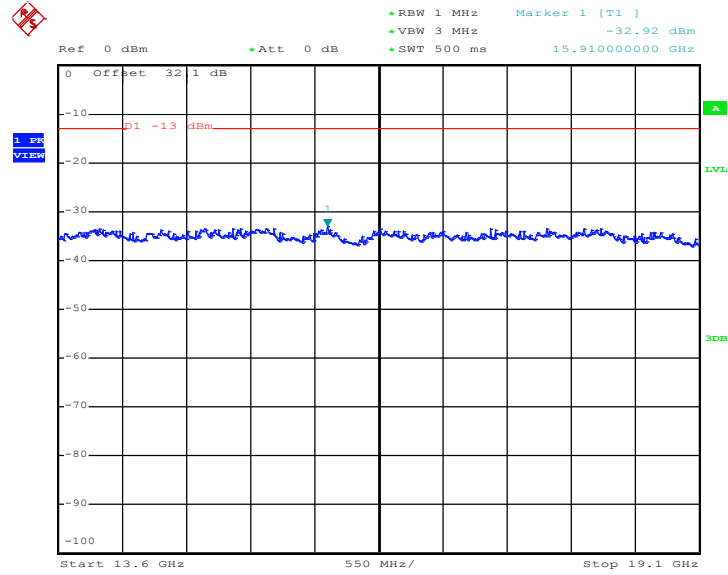

Date: 9.JUN.2013 10:15:17



3.6 Field Strength of Spurious Radiation Measurement

3.6.1 Description of Field Strength of Spurious Radiated Measurement

The power of any emission outside of the authorized operating frequency ranges must be attenuated below the transmitter power (P) by a factor of at least $43 + 10 \log(P)$ dB. The spectrum is scanned from 30 MHz up to a frequency including its 10th harmonic.

3.6.2 Measuring Instruments

See list of measuring instruments of this test report.

3.6.3 Test Procedures

1. The EUT was placed on a rotatable wooden table with 0.8 meter above ground.
2. The EUT was set 3 meters from the receiving antenna, which was mounted on the antenna tower.
3. The table was rotated 360 degrees to determine the position of the highest spurious emission.
4. The height of the receiving antenna is varied between one meter and four meters to search the maximum spurious emission for both horizontal and vertical polarizations.
5. Make the measurement with the spectrum analyzer's RBW = 1MHz, VBW = 3MHz, taking the record of maximum spurious emission.
6. A horn antenna was substituted in place of the EUT and was driven by a signal generator.
7. Tune the output power of signal generator to the same emission level with EUT maximum spurious emission.
8. Taking the record of output power at antenna port.
9. Repeat step 7 to step 8 for another polarization.
10. The RF fundamental frequency should be excluded against the limit line in the operating frequency band.
11. The limit line is derived from $43 + 10\log(P)$ dB below the transmitter power P(Watts)
= $P(W) - [43 + 10\log(P)]$ (dB)
= $[30 + 10\log(P)]$ (dBm) - $[43 + 10\log(P)]$ (dB)
= -13dBm.
12. $EIRP$ (dBm) = S.G. Power – Tx Cable Loss + Tx Antenna Gain
13. ERP (dBm) = $EIRP - 2.15$

3.6.4 Test Setup

For radiated emissions from 30MHz to 1GHz

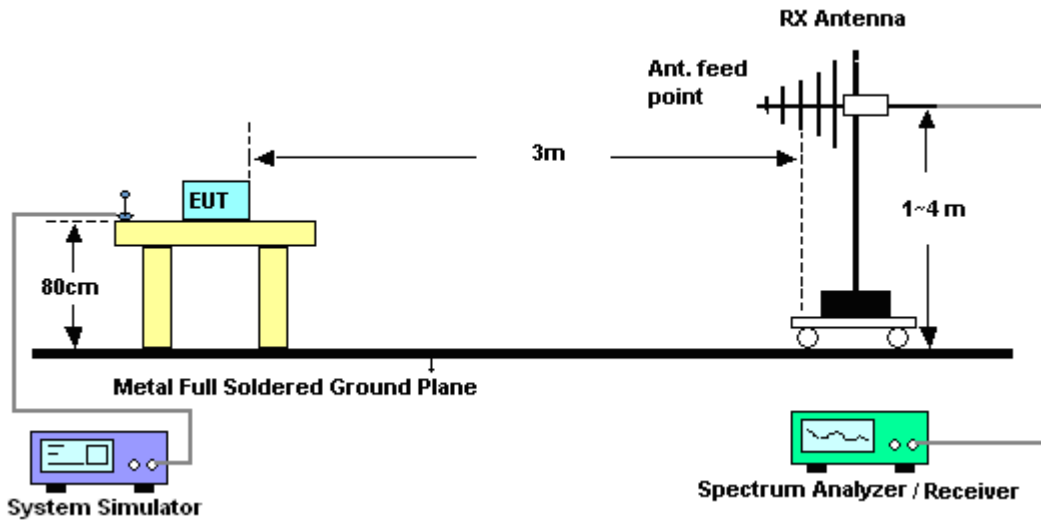

For radiated emissions above 1GHz

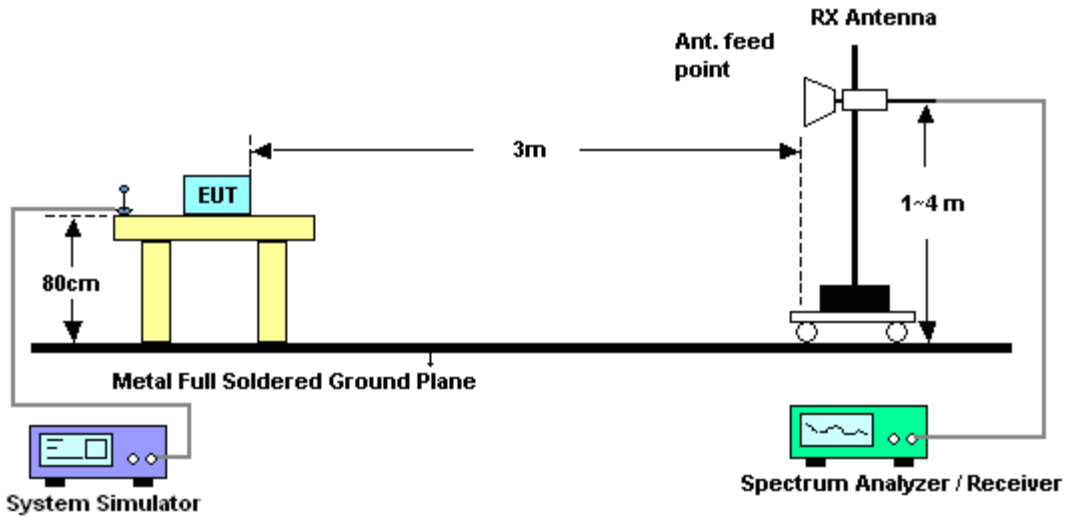



3.6.5 Test Result of Field Strength of Spurious Radiated

| | | | |
|------------------------|--|----------------------------|------------|
| Band : | GSM850 | Temperature : | 22~24°C |
| Test Mode : | GPRS class 8 Link (GMSK) | Relative Humidity : | 51~53% |
| Test Engineer : | Beer Chang | Polarization : | Horizontal |
| Remark : | Spurious emissions within 30-1000MHz were found more than 20dB below limit line. | | |

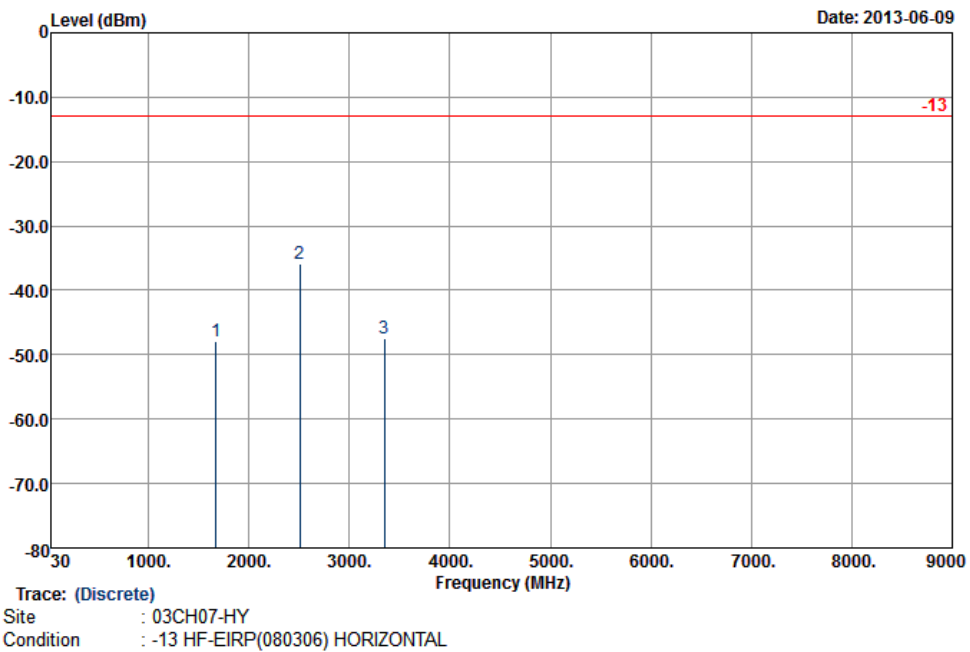

| Frequency (MHz) | ERP (dBm) | Limit (dBm) | Over Limit (dB) | SPA Reading (dBm) | S.G. Power (dBm) | TX Cable loss (dB) | TX Antenna Gain (dBi) | Polarization (H/V) | Result |
|-----------------|-----------|-------------|-----------------|-------------------|------------------|--------------------|-----------------------|--------------------|--------|
| 1672 | -47.95 | -13 | -34.95 | -56.87 | -49.67 | 1.62 | 5.49 | H | Pass |
| 2509 | -35.98 | -13 | -22.98 | -49.27 | -37.95 | 2.1 | 6.22 | H | Pass |
| 3346 | -47.42 | -13 | -34.42 | -61.52 | -50.31 | 3.03 | 8.07 | H | Pass |



| | | | |
|------------------------|--|----------------------------|----------|
| Band : | GSM850 | Temperature : | 22~24°C |
| Test Mode : | GPRS class 8 Link (GMSK) | Relative Humidity : | 51~53% |
| Test Engineer : | Beer Chang | Polarization : | Vertical |
| Remark : | Spurious emissions within 30-1000MHz were found more than 20dB below limit line. | | |

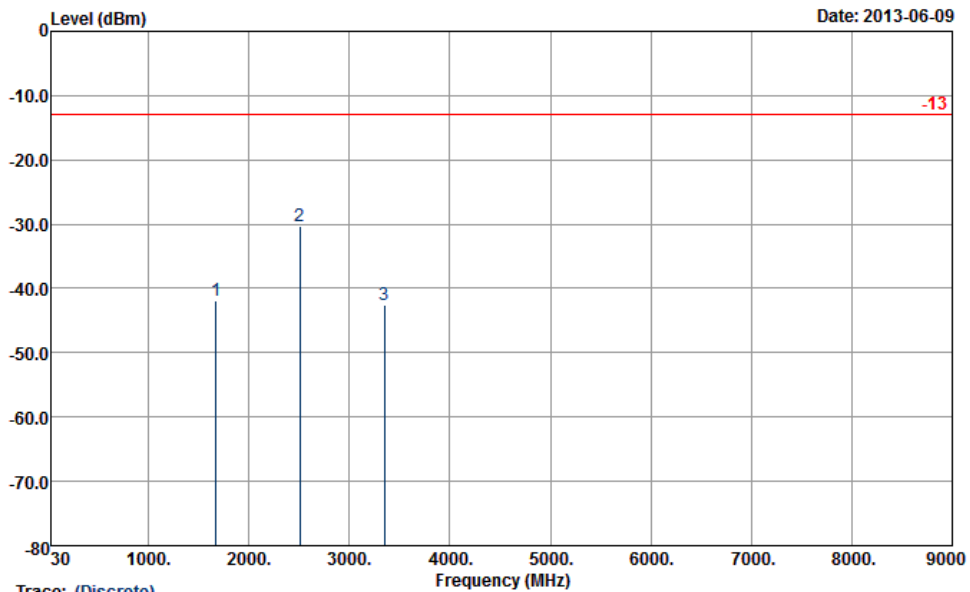

Trace: (Discrete)
 Site : 03CH07-HY
 Condition : -13 HF-EIRP(080306) VERTICAL

| Frequency (MHz) | ERP (dBm) | Limit (dBm) | Over Limit (dB) | SPA Reading (dBm) | S.G. Power (dBm) | TX Cable loss (dB) | TX Antenna Gain (dBi) | Polarization (H/V) | Result |
|-----------------|-----------|-------------|-----------------|-------------------|------------------|--------------------|-----------------------|--------------------|--------|
| 1672 | -41.89 | -13 | -28.89 | -53.05 | -43.61 | 1.62 | 5.49 | V | Pass |
| 2509 | -30.39 | -13 | -17.39 | -44.13 | -32.36 | 2.1 | 6.22 | V | Pass |
| 3346 | -42.60 | -13 | -29.60 | -58.19 | -45.49 | 3.03 | 8.07 | V | Pass |



| | | | |
|------------------------|--|----------------------------|------------|
| Band : | GSM850 | Temperature : | 22~24°C |
| Test Mode : | EDGE class 8 Link (8PSK) | Relative Humidity : | 51~53% |
| Test Engineer : | Beer Chang | Polarization : | Horizontal |
| Remark : | Spurious emissions within 30-1000MHz were found more than 20dB below limit line. | | |

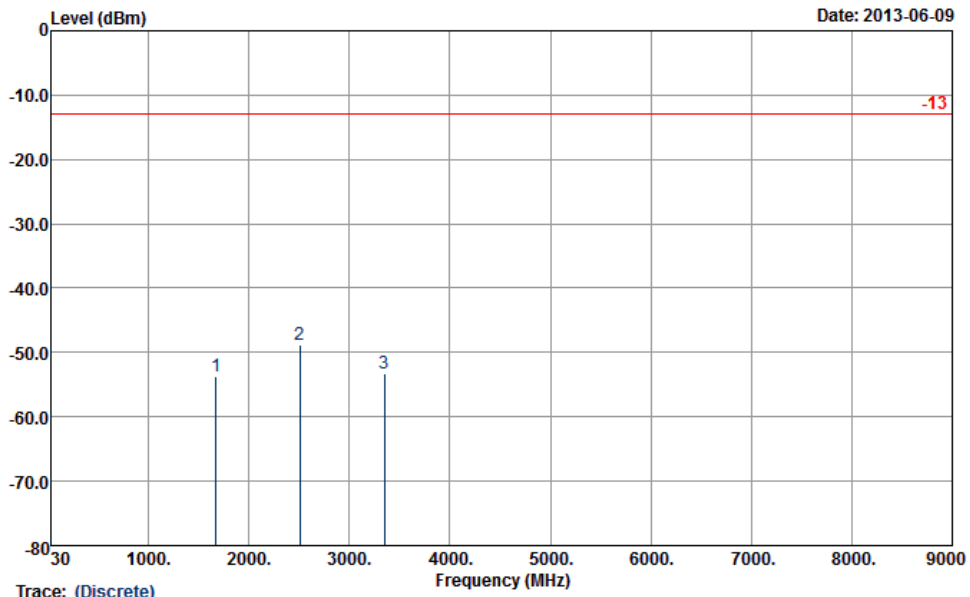

Trace: (Discrete)
 Site : 03CH07-HY
 Condition : -13 HF-EIRP(080306) HORIZONTAL

| Frequency (MHz) | ERP (dBm) | Limit (dBm) | Over Limit (dB) | SPA Reading (dBm) | S.G. Power (dBm) | TX Cable loss (dB) | TX Antenna Gain (dBi) | Polarization (H/V) | Result |
|----------------------|----------------|------------------|-------------------------|---------------------------|--------------------------|----------------------------|-------------------------------|-------------------------|--------|
| 1672 | -53.71 | -13 | -40.71 | -62.63 | -55.43 | 1.62 | 5.49 | H | Pass |
| 2509 | -48.83 | -13 | -35.83 | -62.12 | -50.8 | 2.1 | 6.22 | H | Pass |
| 3346 | -53.29 | -13 | -40.29 | -67.39 | -56.18 | 3.03 | 8.07 | H | Pass |



| | | | |
|------------------------|--|----------------------------|----------|
| Band : | GSM850 | Temperature : | 22~24°C |
| Test Mode : | EDGE class 8 Link (8PSK) | Relative Humidity : | 51~53% |
| Test Engineer : | Beer Chang | Polarization : | Vertical |
| Remark : | Spurious emissions within 30-1000MHz were found more than 20dB below limit line. | | |

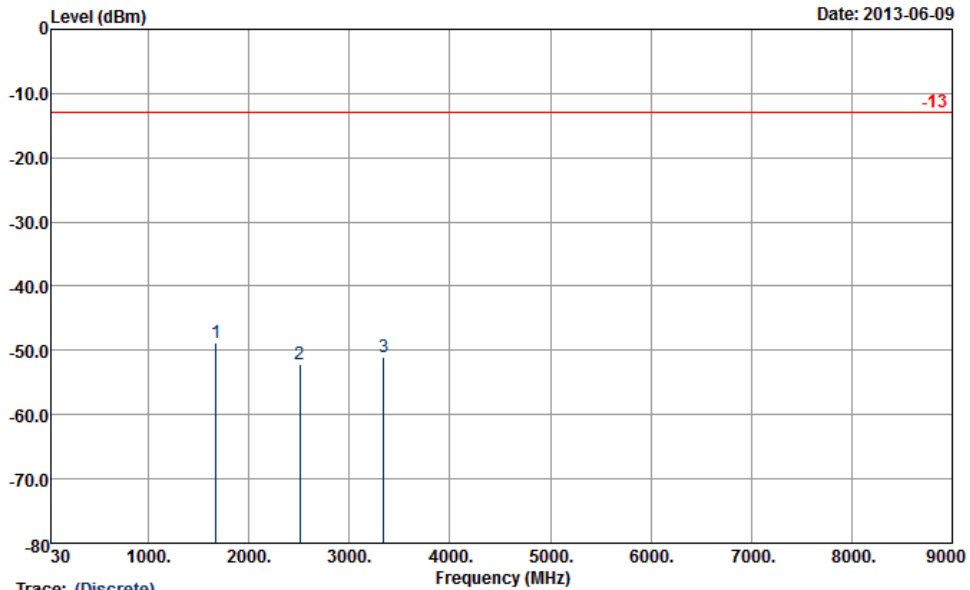

Trace: (Discrete)
 Site : 03CH07-HY
 Condition : -13 HF-EIRP(080306) VERTICAL

| Frequency (MHz) | ERP (dBm) | Limit (dBm) | Over Limit (dB) | SPA Reading (dBm) | S.G. Power (dBm) | TX Cable loss (dB) | TX Antenna Gain (dBi) | Polarization (H/V) | Result |
|----------------------|----------------|------------------|-------------------------|---------------------------|--------------------------|----------------------------|-------------------------------|-------------------------|--------|
| 1672 | -48.76 | -13 | -35.76 | -59.92 | -50.48 | 1.62 | 5.49 | V | Pass |
| 2509 | -52.18 | -13 | -39.18 | -65.92 | -54.15 | 2.1 | 6.22 | V | Pass |
| 3345 | -51.13 | -13 | -38.13 | -66.72 | -54.02 | 3.03 | 8.07 | V | Pass |



| | | | |
|------------------------|--|----------------------------|------------|
| Band : | GSM1900 | Temperature : | 22~24°C |
| Test Mode : | GPRS class 8 Link (GMSK) | Relative Humidity : | 51~53% |
| Test Engineer : | Beer Chang | Polarization : | Horizontal |
| Remark : | Spurious emissions within 30-1000MHz were found more than 20dB below limit line. | | |

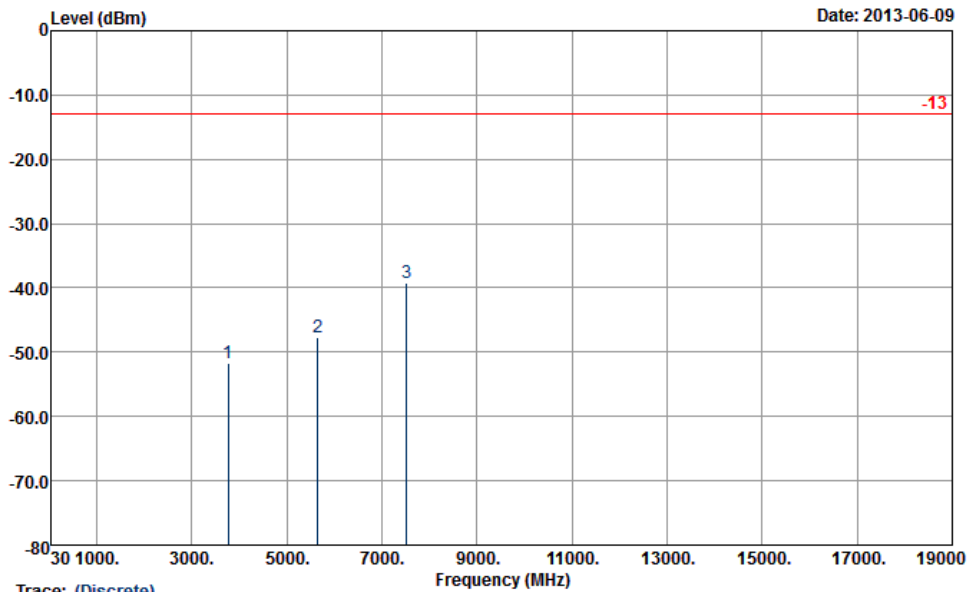

Trace: (Discrete)
 Site : 03CH07-HY
 Condition : -13 HF-EIRP(080306) HORIZONTAL

| Frequency (MHz) | EIRP (dBm) | Limit (dBm) | Over Limit (dB) | SPA Reading (dBm) | S.G. Power (dBm) | TX Cable loss (dB) | TX Antenna Gain (dBi) | Polarization (H/V) | Result |
|----------------------|-----------------|------------------|-------------------------|---------------------------|--------------------------|----------------------------|-------------------------------|-------------------------|--------|
| 3760 | -51.64 | -13 | -38.64 | -66.99 | -57.94 | 2.51 | 8.81 | H | Pass |
| 5640 | -47.67 | -13 | -34.67 | -68.43 | -55.38 | 2.99 | 10.70 | H | Pass |
| 7520 | -39.33 | -13 | -26.33 | -66.6 | -47.86 | 3.59 | 12.12 | H | Pass |



| | | | |
|------------------------|--|----------------------------|----------|
| Band : | GSM1900 | Temperature : | 22~24°C |
| Test Mode : | GPRS class 8 Link (GMSK) | Relative Humidity : | 51~53% |
| Test Engineer : | Beer Chang | Polarization : | Vertical |
| Remark : | Spurious emissions within 30-1000MHz were found more than 20dB below limit line. | | |

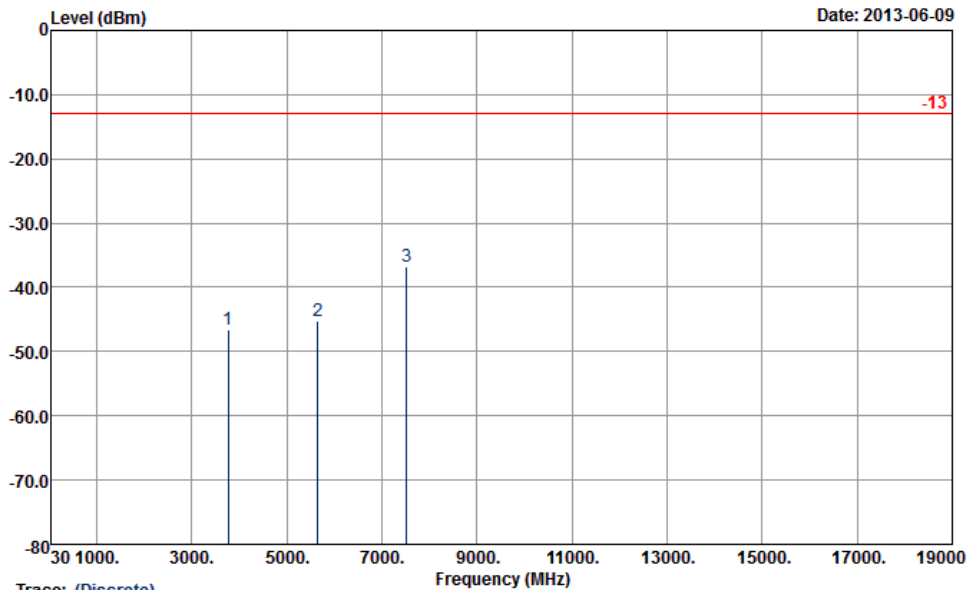

Trace: (Discrete)
 Site : 03CH07-HY
 Condition : -13 HF-EIRP(080306) VERTICAL

| Frequency (MHz) | EIRP (dBm) | Limit (dBm) | Over Limit (dB) | SPA Reading (dBm) | S.G. Power (dBm) | TX Cable loss (dB) | TX Antenna Gain (dBi) | Polarization (H/V) | Result |
|----------------------|-----------------|------------------|-------------------------|---------------------------|--------------------------|----------------------------|-------------------------------|-------------------------|--------|
| 3760 | -46.57 | -13 | -33.57 | -62.87 | -52.87 | 2.51 | 8.81 | V | Pass |
| 5640 | -45.34 | -13 | -32.34 | -65.91 | -53.05 | 2.99 | 10.70 | V | Pass |
| 7520 | -36.79 | -13 | -23.79 | -63.84 | -45.32 | 3.59 | 12.12 | V | Pass |



| | | | |
|------------------------|--|----------------------------|------------|
| Band : | GSM1900 | Temperature : | 22~24°C |
| Test Mode : | EDGE class 8 Link (8PSK) | Relative Humidity : | 51~53% |
| Test Engineer : | Beer Chang | Polarization : | Horizontal |
| Remark : | Spurious emissions within 30-1000MHz were found more than 20dB below limit line. | | |

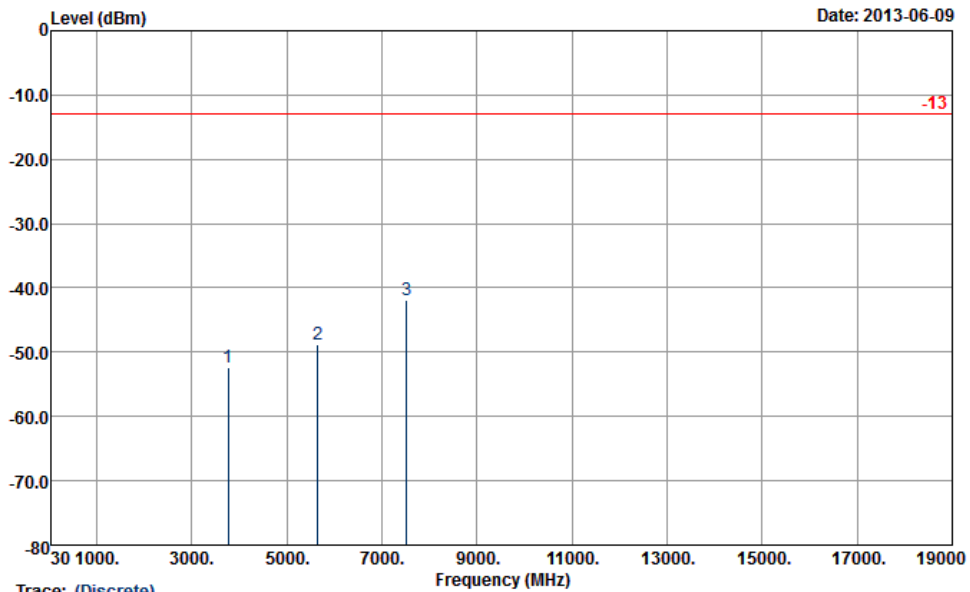

Trace: (Discrete)
 Site : 03CH07-HY
 Condition : -13 HF-EIRP(080306) HORIZONTAL

| Frequency (MHz) | EIRP (dBm) | Limit (dBm) | Over Limit (dB) | SPA Reading (dBm) | S.G. Power (dBm) | TX Cable loss (dB) | TX Antenna Gain (dBi) | Polarization (H/V) | Result |
|----------------------|-----------------|------------------|-------------------------|---------------------------|--------------------------|----------------------------|-------------------------------|-------------------------|--------|
| 3760 | -52.35 | -13 | -39.35 | -67.7 | -58.65 | 2.51 | 8.81 | H | Pass |
| 5640 | -48.87 | -13 | -35.87 | -69.63 | -56.58 | 2.99 | 10.70 | H | Pass |
| 7520 | -41.83 | -13 | -28.83 | -69.1 | -50.36 | 3.59 | 12.12 | H | Pass |



| | | | |
|------------------------|--|----------------------------|----------|
| Band : | GSM1900 | Temperature : | 22~24°C |
| Test Mode : | EDGE class 8 Link (8PSK) | Relative Humidity : | 51~53% |
| Test Engineer : | Beer Chang | Polarization : | Vertical |
| Remark : | Spurious emissions within 30-1000MHz were found more than 20dB below limit line. | | |

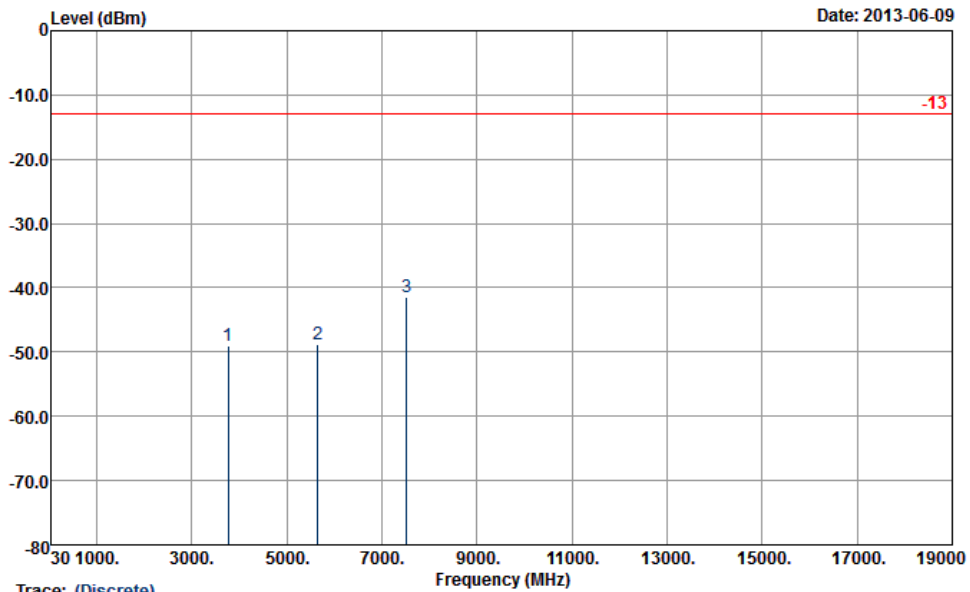

Trace: (Discrete)
 Site : 03CH07-HY
 Condition : -13 HF-EIRP(080306) VERTICAL

| Frequency (MHz) | EIRP (dBm) | Limit (dBm) | Over Limit (dB) | SPA Reading (dBm) | S.G. Power (dBm) | TX Cable loss (dB) | TX Antenna Gain (dBi) | Polarization (H/V) | Result |
|----------------------|-----------------|------------------|-------------------------|---------------------------|--------------------------|----------------------------|-------------------------------|-------------------------|--------|
| 3760 | -48.97 | -13 | -35.97 | -65.27 | -55.27 | 2.51 | 8.81 | V | Pass |
| 5640 | -48.86 | -13 | -35.86 | -69.43 | -56.57 | 2.99 | 10.70 | V | Pass |
| 7520 | -41.45 | -13 | -28.45 | -68.5 | -49.98 | 3.59 | 12.12 | V | Pass |



| | | | |
|------------------------|--|----------------------------|------------|
| Band : | WCDMA Band V | Temperature : | 22~24°C |
| Test Mode : | RMC 12.2kbps Link (QPSK) | Relative Humidity : | 51~53% |
| Test Engineer : | Beer Chang | Polarization : | Horizontal |
| Remark : | Spurious emissions within 30-1000MHz were found more than 20dB below limit line. | | |

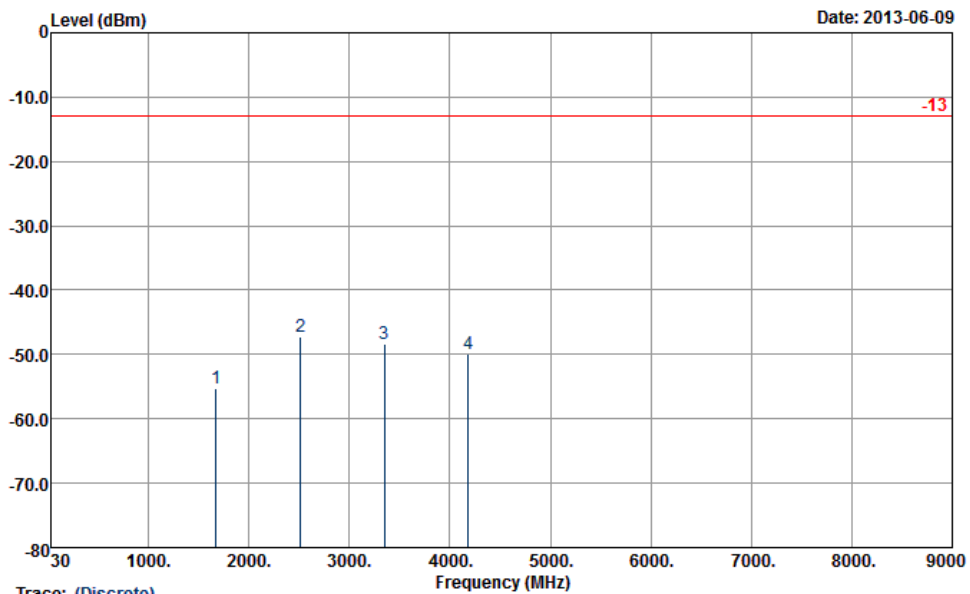

Trace: (Discrete)
 Site : 03CH07-HY
 Condition : -13 HF-EIRP(080306) HORIZONTAL

| Frequency (MHz) | ERP (dBm) | Limit (dBm) | Over Limit (dB) | SPA Reading (dBm) | S.G. Power (dBm) | TX Cable loss (dB) | TX Antenna Gain (dBi) | Polarization (H/V) | Result |
|----------------------|----------------|------------------|-------------------------|---------------------------|--------------------------|----------------------------|-------------------------------|-------------------------|--------|
| 1675 | -55.23 | -13 | -42.23 | -64.15 | -56.95 | 1.62 | 5.49 | H | Pass |
| 2512 | -47.33 | -13 | -34.33 | -60.62 | -49.3 | 2.1 | 6.22 | H | Pass |
| 3352 | -48.36 | -13 | -35.36 | -62.46 | -51.25 | 3.03 | 8.07 | H | Pass |
| 4180 | -49.87 | -13 | -36.87 | -66.12 | -54.41 | 2.52 | 9.21 | H | Pass |



| | | | |
|------------------------|--|----------------------------|----------|
| Band : | WCDMA Band V | Temperature : | 22~24°C |
| Test Mode : | RMC 12.2kbps Link (QPSK) | Relative Humidity : | 51~53% |
| Test Engineer : | Beer Chang | Polarization : | Vertical |
| Remark : | Spurious emissions within 30-1000MHz were found more than 20dB below limit line. | | |

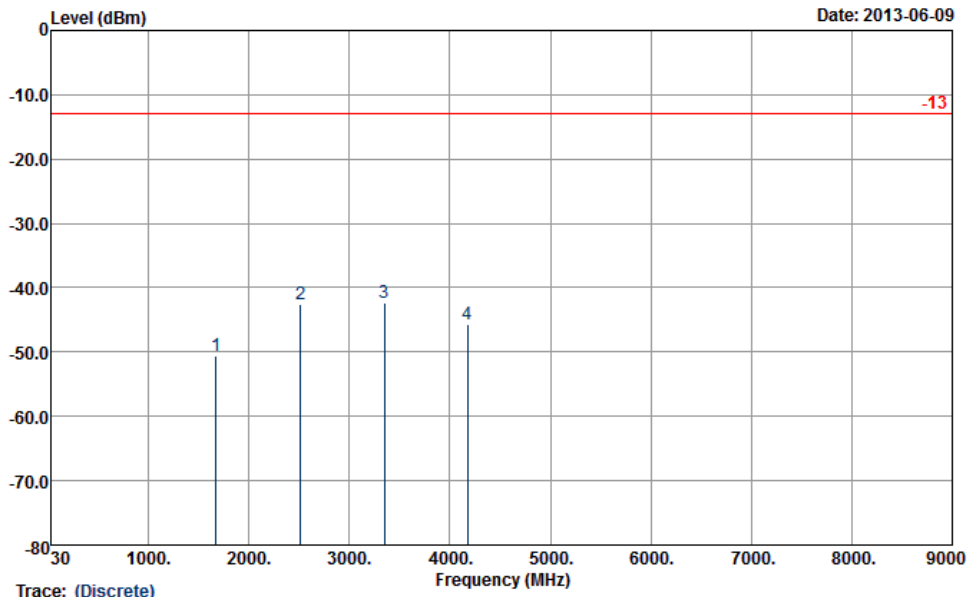

Trace: (Discrete)
 Site : 03CH07-HY
 Condition : -13 HF-EIRP(080306) VERTICAL

| Frequency (MHz) | ERP (dBm) | Limit (dBm) | Over Limit (dB) | SPA Reading (dBm) | S.G. Power (dBm) | TX Cable loss (dB) | TX Antenna Gain (dBi) | Polarization (H/V) | Result |
|----------------------|----------------|------------------|-------------------------|---------------------------|--------------------------|----------------------------|-------------------------------|-------------------------|--------|
| 1675 | -50.52 | -13 | -37.52 | -61.68 | -52.24 | 1.62 | 5.49 | V | Pass |
| 2512 | -42.61 | -13 | -29.61 | -56.35 | -44.58 | 2.1 | 6.22 | V | Pass |
| 3352 | -42.42 | -13 | -29.42 | -58.01 | -45.31 | 3.03 | 8.07 | V | Pass |
| 4175 | -45.59 | -13 | -32.59 | -62.67 | -50.13 | 2.52 | 9.21 | V | Pass |



| | | | |
|------------------------|--|----------------------------|------------|
| Band : | WCDMA Band IV | Temperature : | 22~24°C |
| Test Mode : | RMC 12.2kbps Link (QPSK) | Relative Humidity : | 51~53% |
| Test Engineer : | Beer Chang | Polarization : | Horizontal |
| Remark : | Spurious emissions within 30-1000MHz were found more than 20dB below limit line. | | |

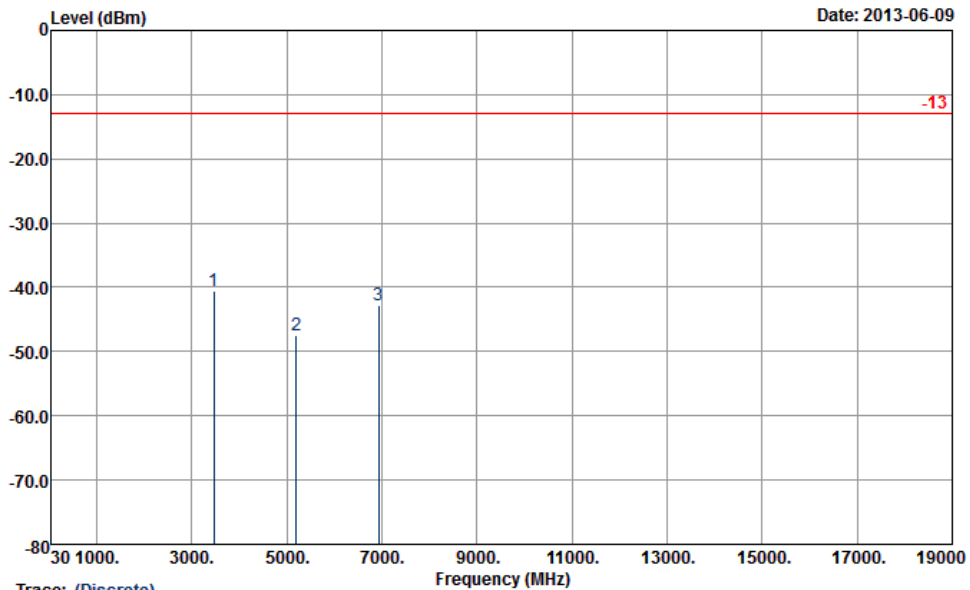

Trace: (Discrete)
 Site : 03CH07-HY
 Condition : -13 HF-EIRP(080306) HORIZONTAL

| Frequency (MHz) | EIRP (dBm) | Limit (dBm) | Over Limit (dB) | SPA Reading (dBm) | S.G. Power (dBm) | TX Cable loss (dB) | TX Antenna Gain (dBi) | Polarization (H/V) | Result |
|----------------------|-----------------|------------------|-------------------------|---------------------------|--------------------------|----------------------------|-------------------------------|-------------------------|--------|
| 3464 | -40.66 | -13 | -27.66 | -54.96 | -44.49 | 4.48 | 8.31 | H | Pass |
| 5200 | -47.51 | -13 | -34.51 | -66.3 | -52.15 | 5.332 | 9.98 | H | Pass |
| 6928 | -42.73 | -13 | -29.73 | -68.89 | -47.97 | 6.1 | 11.34 | H | Pass |



| | | | |
|------------------------|--|----------------------------|----------|
| Band : | WCDMA Band IV | Temperature : | 22~24°C |
| Test Mode : | RMC 12.2kbps Link (QPSK) | Relative Humidity : | 51~53% |
| Test Engineer : | Beer Chang | Polarization : | Vertical |
| Remark : | Spurious emissions within 30-1000MHz were found more than 20dB below limit line. | | |

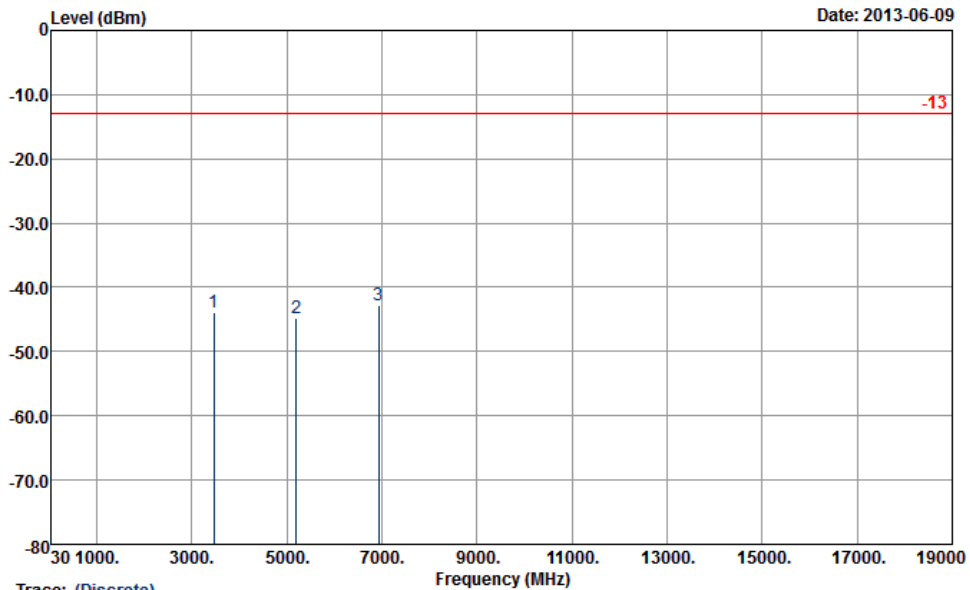

Trace: (Discrete)
 Site : 03CH07-HY
 Condition : -13 HF-EIRP(080306) VERTICAL

| Frequency (MHz) | EIRP (dBm) | Limit (dBm) | Over Limit (dB) | SPA Reading (dBm) | S.G. Power (dBm) | TX Cable loss (dB) | TX Antenna Gain (dBi) | Polarization (H/V) | Result |
|----------------------|-----------------|------------------|-------------------------|---------------------------|--------------------------|----------------------------|-------------------------------|-------------------------|--------|
| 3468 | -43.97 | -13 | -30.97 | -59.51 | -47.8 | 4.48 | 8.31 | V | Pass |
| 5196 | -44.75 | -13 | -31.75 | -63.58 | -49.39 | 5.332 | 9.98 | V | Pass |
| 6930 | -42.69 | -13 | -29.69 | -68.03 | -47.93 | 6.1 | 11.34 | V | Pass |



| | | | |
|------------------------|--|----------------------------|------------|
| Band : | WCDMA Band II | Temperature : | 22~24°C |
| Test Mode : | RMC 12.2kbps Link (QPSK) | Relative Humidity : | 51~53% |
| Test Engineer : | Beer Chang | Polarization : | Horizontal |
| Remark : | Spurious emissions within 30-1000MHz were found more than 20dB below limit line. | | |

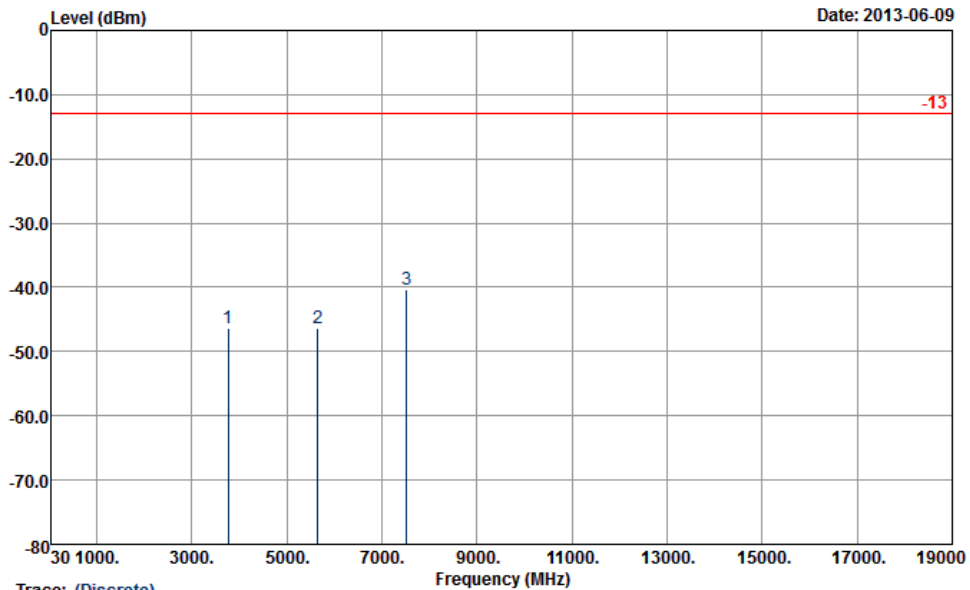

Trace: (Discrete)
 Site : 03CH07-HY
 Condition : -13 HF-EIRP(080306) HORIZONTAL

| Frequency (MHz) | EIRP (dBm) | Limit (dBm) | Over Limit (dB) | SPA Reading (dBm) | S.G. Power (dBm) | TX Cable loss (dB) | TX Antenna Gain (dBi) | Polarization (H/V) | Result |
|----------------------|-----------------|------------------|-------------------------|---------------------------|--------------------------|----------------------------|-------------------------------|-------------------------|--------|
| 3760 | -46.25 | -13 | -33.25 | -61.6 | -52.55 | 2.51 | 8.81 | H | Pass |
| 5640 | -46.33 | -13 | -33.33 | -67.09 | -54.04 | 2.99 | 10.70 | H | Pass |
| 7520 | -40.32 | -13 | -27.32 | -67.59 | -48.85 | 3.59 | 12.12 | H | Pass |



| | | | |
|------------------------|--|----------------------------|----------|
| Band : | WCDMA Band II | Temperature : | 22~24°C |
| Test Mode : | RMC 12.2kbps Link (QPSK) | Relative Humidity : | 51~53% |
| Test Engineer : | Beer Chang | Polarization : | Vertical |
| Remark : | Spurious emissions within 30-1000MHz were found more than 20dB below limit line. | | |

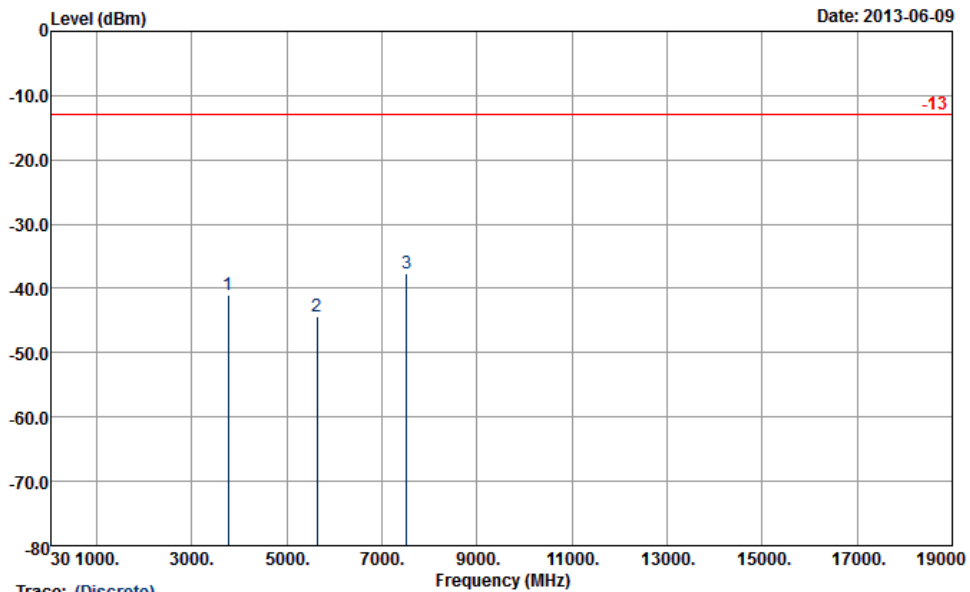

Trace: (Discrete)
 Site : 03CH07-HY
 Condition : -13 HF-EIRP(080306) VERTICAL

| Frequency (MHz) | EIRP (dBm) | Limit (dBm) | Over Limit (dB) | SPA Reading (dBm) | S.G. Power (dBm) | TX Cable loss (dB) | TX Antenna Gain (dBi) | Polarization (H/V) | Result |
|----------------------|-----------------|------------------|-------------------------|---------------------------|--------------------------|----------------------------|-------------------------------|-------------------------|--------|
| 3760 | -40.96 | -13 | -27.96 | -57.26 | -47.26 | 2.51 | 8.81 | V | Pass |
| 5636 | -44.40 | -13 | -31.40 | -64.97 | -52.11 | 2.99 | 10.70 | V | Pass |
| 7520 | -37.60 | -13 | -24.60 | -64.65 | -46.13 | 3.59 | 12.12 | V | Pass |

3.7 Frequency Stability Measurement

3.7.1 Description of Frequency Stability Measurement

The frequency stability shall be measured by variation of ambient temperature and variation of primary supply voltage to ensure that the fundamental emission stays within the authorized frequency block. The frequency stability of the transmitter shall be maintained within $\pm 0.00025\%$ ($\pm 2.5\text{ppm}$) of the center frequency.

3.7.2 Measuring Instruments

See list of measuring instruments of this test report.

3.7.3 Test Procedures for Temperature Variation

1. The EUT was set up in the thermal chamber and connected with the base station.
2. With power OFF, the temperature was decreased to -30°C and the EUT was stabilized before testing. Power was applied and the maximum change in frequency was recorded within one minute.
3. With power OFF, the temperature was raised in 10°C step up to 50°C . The EUT was stabilized at each step for at least half an hour. Power was applied and the maximum frequency change was recorded within one minute.
4. If the EUT cannot be turned on at -30°C , the testing lowest temperature will be raised in 10°C step until the EUT can be turned on.

3.7.4 Test Procedures for Voltage Variation

1. The EUT was placed in a temperature chamber at $25\pm 5^{\circ}\text{C}$ and connected with the base station.
2. The power supply voltage to the EUT was varied from BEP to 115% of the nominal value measured at the input to the EUT.
3. The variation in frequency was measured for the worst case.

3.7.5 Test Setup

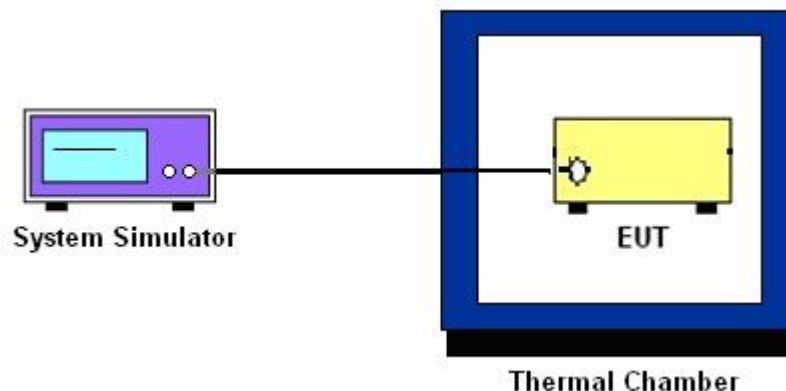



3.7.6 Test Result of Temperature Variation

| | | | |
|---------------|---------|-------------|-----------|
| Band : | GSM 850 | Channel : | 189 |
| Limit (ppm) : | 2.5 | Frequency : | 836.4 MHz |

| Temperature (°C) | GPRS class 8 | | EDGE class 8 | | Result |
|------------------|-----------------|-----------------|-----------------|-----------------|--------|
| | Freq. Dev. (Hz) | Deviation (ppm) | Freq. Dev. (Hz) | Deviation (ppm) | |
| -30 | 15 | 0.02 | -13 | -0.02 | PASS |
| -20 | 13 | 0.02 | -14 | -0.02 | |
| -10 | 14 | 0.02 | -10 | -0.01 | |
| 0 | 16 | 0.02 | -8 | -0.01 | |
| 10 | 13 | 0.02 | -9 | -0.01 | |
| 20 | 16 | 0.02 | 8 | 0.01 | |
| 30 | 14 | 0.02 | 10 | 0.01 | |
| 40 | 20 | 0.02 | 9 | 0.01 | |
| 50 | 15 | 0.02 | 17 | 0.02 | |

| | | | |
|---------------|----------|-------------|------------|
| Band : | GSM 1900 | Channel : | 661 |
| Limit (ppm) : | 2.5 | Frequency : | 1880.0 MHz |

| Temperature (°C) | GPRS class 8 | | EDGE class 8 | | Result |
|------------------|-----------------|-----------------|-----------------|-----------------|--------|
| | Freq. Dev. (Hz) | Deviation (ppm) | Freq. Dev. (Hz) | Deviation (ppm) | |
| -30 | 25 | 0.01 | 23 | 0.01 | PASS |
| -20 | 18 | 0.01 | 20 | 0.01 | |
| -10 | 20 | 0.01 | 22 | 0.01 | |
| 0 | 21 | 0.01 | 19 | 0.01 | |
| 10 | 22 | 0.01 | 15 | 0.01 | |
| 20 | 13 | 0.01 | 20 | 0.01 | |
| 30 | 26 | 0.01 | 21 | 0.01 | |
| 40 | 19 | 0.01 | 20 | 0.01 | |
| 50 | 26 | 0.01 | 23 | 0.01 | |



| | | | |
|----------------------|--------------|--------------------|-----------|
| Band : | WCDMA Band V | Channel : | 4182 |
| Limit (ppm) : | 2.5 | Frequency : | 836.4 MHz |

| Temperature (°C) | RMC 12.2kbps | | Result |
|------------------|-----------------|-----------------|--------|
| | Freq. Dev. (Hz) | Deviation (ppm) | |
| -30 | 5 | 0.01 | PASS |
| -20 | -5 | -0.01 | |
| -10 | 4 | 0.00 | |
| 0 | 6 | 0.01 | |
| 10 | 8 | 0.01 | |
| 20 | 7 | 0.01 | |
| 30 | 9 | 0.01 | |
| 40 | 10 | 0.01 | |
| 50 | 7 | 0.01 | |

| | | | |
|----------------------|---------------|--------------------|------------|
| Band : | WCDMA Band IV | Channel : | 1413 |
| Limit (ppm) : | 2.5 | Frequency : | 1732.6 MHz |

| Temperature (°C) | RMC 12.2kbps | | Result |
|------------------|-----------------|-----------------|--------|
| | Freq. Dev. (Hz) | Deviation (ppm) | |
| -30 | -7 | 0.00 | PASS |
| -20 | -10 | -0.01 | |
| -10 | -8 | 0.00 | |
| 0 | -6 | 0.00 | |
| 10 | 13 | 0.01 | |
| 20 | -12 | -0.01 | |
| 30 | -8 | 0.00 | |
| 40 | -11 | -0.01 | |
| 50 | -12 | -0.01 | |



| | | | |
|---------------|---------------|-------------|----------|
| Band : | WCDMA Band II | Channel : | 9400 |
| Limit (ppm) : | 2.5 | Frequency : | 1880 MHz |

| Temperature (°C) | RMC 12.2kbps | | Result |
|------------------|-----------------|-----------------|--------|
| | Freq. Dev. (Hz) | Deviation (ppm) | |
| -30 | -11 | -0.01 | PASS |
| -20 | -12 | -0.01 | |
| -10 | -8 | 0.00 | |
| 0 | -14 | -0.01 | |
| 10 | 9 | 0.00 | |
| 20 | 21 | 0.01 | |
| 30 | 10 | 0.01 | |
| 40 | 9 | 0.00 | |
| 50 | 10 | 0.01 | |



3.7.7 Test Result of Voltage Variation

| Band & Channel | Mode | Voltage (Volt) | Freq. Dev. (Hz) | Deviation (ppm) | Limit (ppm) | Result |
|-------------------------|-----------------|----------------|-----------------|-----------------|-------------|--------|
| GSM 850 CH189 | GPRS class 8 | 3.3 | 13 | 0.02 | 2.5 | PASS |
| | | 3.0 | 15 | 0.02 | | |
| | | 3.6 | 16 | 0.02 | | |
| | EDGE class 8 | 3.3 | 8 | 0.01 | | |
| | | 3.0 | 9 | 0.01 | | |
| | | 3.6 | -10 | -0.01 | | |
| GSM 1900 CH661 | GPRS class 8 | 3.3 | 22 | 0.01 | | |
| | | 3.0 | 26 | 0.01 | | |
| | | 3.6 | 13 | 0.01 | | |
| | EDGE class 8 | 3.3 | 16 | 0.01 | | |
| | | 3.0 | 18 | 0.01 | | |
| | | 3.6 | 15 | 0.01 | | |
| WCDMA Band V CH4182 | RMC 12.2kbps | 3.3 | 5 | 0.01 | | |
| | | 3.0 | 6 | 0.01 | | |
| | | 3.6 | 8 | 0.01 | | |
| WCDMA Band IV CH1413 | RMC 12.2kbps | 3.3 | -8 | 0.00 | | |
| | | 3.0 | -6 | 0.00 | | |
| | | 3.6 | -10 | -0.01 | | |
| WCDMA Band II CH9400 | RMC 12.2kbps | 3.3 | -10 | -0.01 | | |
| | | 3.0 | 8 | 0.00 | | |
| | | 3.6 | 13 | 0.01 | | |

Note: Normal Voltage = 3.3V.



4 List of Measuring Equipments

| Instrument | Manufacturer | Model No. | Serial No. | Characteristics | Calibration Date | Test Date | Due Date | Remark |
|---------------------------|-----------------|---------------|-------------|-----------------|------------------|-------------------------------|---------------|-----------------------|
| System Simulator | R&S | CMU200 | 117995 | N/A | Jul. 30, 2012 | Jun. 09, 2013 ~ Jun. 10, 2013 | Jul. 29, 2013 | Conducted (TH02-HY) |
| Spectrum Analyzer | Rohde & Schwarz | FSP40 | 100055 | 9kHz~40GHz | Jun. 07, 2013 | Jun. 09, 2013 ~ Jun. 10, 2013 | Jun. 06, 2014 | Conducted (TH02-HY) |
| Thermal Chamber | Ten Billion | TTH-D3SP | TBN-930701 | N/A | Jul. 23, 2012 | Jun. 09, 2013 ~ Jun. 10, 2013 | Jul. 22, 2013 | Conducted (TH02-HY) |
| Spectrum Analyzer | Rohde & Schwarz | FSP30 | 101067 | 9K~30G | Nov. 30, 2012 | Jun. 09, 2013 | Nov. 29, 2013 | Radiation (03CH07-HY) |
| Bilog Antenna | Schaffner | CBL6111C | 2726 | 30M~1G | Oct. 06, 2012 | Jun. 09, 2013 | Oct. 05, 2013 | Radiation (03CH07-HY) |
| Double Ridge Horn Antenna | ESCO | 3117 | 75962 | 1G~18G | Aug. 22, 2012 | Jun. 09, 2013 | Aug. 21, 2013 | Radiation (03CH07-HY) |
| Preamplifier | COM-POWER | PA-103A | 161241 | 30M~1G | Feb. 26, 2013 | Jun. 09, 2013 | Feb. 25, 2014 | Radiation (03CH07-HY) |
| Preamplifier | Agilent | 8449B | 3008A02362 | 1G~26.5G | Dec. 01, 2012 | Jun. 09, 2013 | Nov. 30, 2013 | Radiation (03CH07-HY) |
| Turn Table | ChainTek | ChainTek 3000 | N/A | 0 ~ 360 degree | N/A | Jun. 09, 2013 | N/A | Radiation (03CH07-HY) |
| Antenna Mast | ChainTek | ChainTek 3000 | N/A | N/A | N/A | Jun. 09, 2013 | N/A | Radiation (03CH07-HY) |
| SHF-EHF Horn Antenna | SCHWARZBECK | BBHA 9170 | BBHA9170251 | 18G~40G | Sep. 28, 2012 | Jun. 09, 2013 | Sep. 27, 2013 | Radiation (03CH07-HY) |



5 Uncertainty of Evaluation

Uncertainty of Radiated Emission Measurement (30 MHz ~ 1000 MHz)

| | |
|---|------|
| Measuring Uncertainty for a Level of Confidence of 95% ($U = 2Uc(y)$) | 2.54 |
|---|------|

Uncertainty of Radiated Emission Measurement (1 GHz ~ 40 GHz)

| | |
|---|------|
| Measuring Uncertainty for a Level of Confidence of 95% ($U = 2Uc(y)$) | 4.72 |
|---|------|



Appendix A. Photographs of EUT

Please refer to Sporton report number EP352141 as below.