

User Manual

Router

with

802.11g 54 Mbps, 108Mbps Wireless LAN

and

4-port Switch

FCC Compliance

NOTE: This equipment has been tested and found to comply with the limits for a Class B digital device, pursuant to Part 15 of the FCC Rules. These limits are designed to provide reasonable protection against harmful interference in a residential installation. This equipment generates, uses and can radiate radio frequency energy and, if not installed and used in accordance with the instructions, may cause harmful interference to radio communications. However, there is no guarantee that interference will not occur in a particular installation. If this equipment does cause harmful interference to radio or television reception, which can be determined by turning the equipment off and on, the user is encouraged to try to correct the interference by one or more of the following measures:

- Reorient or relocate the receiving antenna.
- Increase the separation between the equipment and receiver.
- Connect the equipment into an outlet on a circuit different from that to which the receiver is connected.
- Consult the dealer or an experienced radio/TV technician for help.

Any changes or modifications not expressly approved by the party responsible for compliance could void the user's authority to operate the equipment.

No special accessory is required to enable the equipment to comply with the emission limits.

In order to comply with FCC RF Exposure requirements, the AP880G(i-connect Wireless Router) must be installed and operated in such a way so as to maintain a minimum 20 cm separation distance between the antenna and all persons, during normal operations.

Contents

INTRODUCTION.....	1
THE PRODUCT	1
PRODUCT FEATURES	1
BASIC IP NETWORKING	2
WIRELESS LAN	3
GETTING STARTED	5
BOX CONTENTS	5
CONNECTING THE ROUTER	5
QUICK START CONFIGURATION (FOR DSL MODEMS)	7
WEB CONFIGURATION	8
QUICK CONFIGURATION.....	9
STATUS	10
STATISTICS	11
LAN & DHCP CONFIGURATION	12
WAN CONFIGURATION	14
PPP CONFIGURATION	14
BRIDGE	16
WIRELESS	18
NAT	22
DMZ CONFIGURATION	23
SNTP CONFIGURATION	24
PORT FORWARDING	25
FILTER	27
WEB SECURITY CONFIGURATION.....	29
ADMIN USERNAME AND PASSWORD	30
FIRMWARE UPDATE	31
SAVE CONFIGURATION	34
PC CONFIGURATION	35
DHCP IP ADDRESS	35
FACTORY RESET.....	37

INTRODUCTION

The Product

The product is based on the IEEE **802.11g** standard, which is the latest **54Mbps** Wireless LAN (WLAN) standard. This standard is five times faster than the widely deployed **WiFi** (802.11b) products that are found in homes, airport and public wireless hotspots. Because 802.11g uses the same **2.4GHz** frequency band, the product is fully interoperable with existing WiFi cards and devices.

Having two wireless protocols in one product ensure that your investments are protected, while enabling you to enjoy the fastest Wireless LAN speed.

The product is a combination of 3 devices:

- a. Wireless LAN Access Point (AP) compliant to 802.11b and 802.11g standards.
- b. 4-port Auto MDI/MDIX Switch
- c. Router with NAT, DHCP Server built-in.

The product is an all-in-one device that allows multiple PCs to share a common broadband (ADSL/Cable) modem. It can serve up to 4 Ethernet-PCs and many WLAN-notebooks. The built-in NAT and DHCP Servers ensure almost plug-and-play convenience for your home network. Advanced features such as Firewall, DMZ, WPA Encryption and 802.1x Authentication make this a product equally suitable for your office needs.

Product Features

- Fully compatibility with **IEEE 802.11g** WLAN standard
- Wireless data rate of up to **54Mbps**
- **2.4GHz** license-free frequency band
- **Router** shares the broadband modem among multiple PCs and laptops.
- **4 Auto MDI/MDIX 10/100** Ethernet ports, 1 WAN port
- Full backward compatibility with **802.11b** standard (WiFi 11Mbps)
- **802.1x** Authentication. Used with a RADIUS server to check and verify the identity of WLAN users.
- **WEP** (Wired Equivalent Privacy). A simple WLAN encryption standard to protect wireless data from sniffers.
- **WPA** (WiFi Protected Access). An improved WLAN encryption standard where the secret key changes automatically at regular intervals.
 - ▶ **TKIP** (Temporal Key Integrity Protocol). When used with a corporate RADIUS server, the WLAN encryption key is changed regularly. Used for high security enterprise networks.
 - ▶ **Pre Shared Key**. For the home user without a RADIUS server. A new key is generated each time the PC connects.
- **Firewall** protects your network from the Internet.
- Built-in **NAT** and **DHCP** Servers greatly simplify the network setup.
- Intuitive Web-based configuration
- **Access Control List** provides added security

Basic IP Networking

IP = Internet Protocol

IP stands for Internet Protocol. In an IP network, every device has a **unique** IP Address (For example: 192.168.1.35) to identify itself. There are two ways of assigning an IP address to a PC or Router: Static and Automatic (DHCP). Static IP addresses are keyed-in manually, while Dynamic IPs are distributed by a DHCP Server.

Ports

Every packet of traffic is identified by its Source and Destination Addresses, which would ensure that the packet arrives at the correct destination. A Port Number is also embedded in each packet; to identify which software application that generated and uses that packet. Therefore, if the Router blocks a certain port number, it denies the particular software from using the connection.

Static IP Address

Static IP addressing ensures that the device will always have the same IP address. Static addressing is commonly used for your servers.

Dynamic IP Address

A dynamic IP address is one that is automatically assigned to a PC. These IP addresses are “dynamic” because they are only temporarily leased to the PC when it connects to the network. This is the most convenient and common way of managing IP addresses in a network. The Server that manages this pool of IP addresses is called the DHCP Server. The product has a DHCP Server built-in to simplify the network management.

DHCP (Dynamic Host Configuration Protocol)

The PC obtaining an IP address from the Server is called the DHCP Client. If there is already a DHCP Server running on your network, you must disable one of the two DHCP servers. Running more than one DHCP server together will cause network problems!

What is a Router?

A router is a network device that connects two networks together, to let them communicate. All the PCs in your home or office would be considered to be in one network: the Local Area Network (**LAN**). The Internet (including the ADSL modem) is considered to be another network: the Wide Area Network (**WAN**). The Router serves 2 purposes:

- Connect all the PCs in the LAN together, allowing them to communicate with one another. (File sharing, Printer sharing etc.)
- Connect all the PCs in the LAN to the Internet, allowing them to simultaneously surf the web and access e-mails.

The Router is connected to 2 networks at the same time. Therefore, it has two IP addresses: one for the LAN, and one for the WAN. The Router's LAN IP address can be configured, but it is best to use the default settings. The WAN port is a DHCP client by default.

Wireless LAN

A Wireless LAN (WLAN) is a computer network that transmits and receives data with radio signals instead of using cables. WLANs have become common in homes, offices, airports and public Hotspots. WLAN can support the same applications and software that run on a wired network (LAN). Besides supporting the same software and functions, WLAN brings greater convenience and eliminates the need to lay Ethernet cables in a home or office.

The Router is based on the finalised **802.11g** standard. The IEEE 802.11g standard is an improvement on the 802.11b (WiFi) standard. It increases the data rate up to 54 Mbps within the 2.4GHz band. As the 802.11b standard is also using the 2.4GHz frequency band, the product is fully backward compatible with the older 802.11b devices. WiFi cards can be used to connect to the Router at 11Mbps.

The Router can even support 108Mbps WLAN if the user is using a recommended Turbo-capable Cardbus.

The Router is also known as the Wireless Access Point (**AP**). The PC using the Cardbus is known as the **Client**. WLAN networking involves a few additional parameters to be configured:

SSID

The SSID is the “network name” for the WLAN network. The SSID is any name, and can be any set of characters or numbers, and must be configured on both the AP and Client. The Client sniffs the radio frequencies for an AP with the same SSID with itself. The client locks onto the AP and they are “**associated**”.

To enable plug-and-play convenience, most client cards can sniff the frequencies to extract the available SSIDs to let the user choose from. Alternatively, setting the client’s SSID to “ANY” can allow it to connect to most APs regardless of the AP’s SSID setting.

Encryption

WLAN traffic can be captured by anybody to be read! The solution is to use encryption to make the traffic appear as random characters to the eavesdropper. Both the AP and client must use the same encryption standard and key to enable them to decode the “rubbish”. If the encryption settings are mismatched, the client and AP cannot associate. WEP (Wired Equivalent Privacy) is the most common WLAN encryption standard.

MAC Address Control

Every client card has a unique MAC Address. This MAC Address can be input into the AP (Router), such that the AP only allows this pool of MAC Addresses to use the WLAN.

Channel

There are a total of 13 channels in the 2.4GHz band. Depending on regulation, not all the frequencies may be available in every country. Frequency is configured on the AP only. The client searches for the AP and locks onto that AP’s channel.

Signal Strength

Radio signals drop in power over a distance. Even if all the settings are correct, a low signal strength makes association impossible. The usable distance between the AP and client can range from a few meters indoor to 200m outdoors maximum. When setting up the AP, make sure that you:

- Keep the distance from the AP to the clients as short as possible.

-
- Make sure that the WLAN signals do not have to pass through too many concrete walls and metal structures to reach the client.
 - Make sure that APs are located far away from one another to avoid interference.

Interference

Interference happens when 2 APs with the same channels are placed near to one another. The speed of the network drops and the signal strength fluctuates wildly.

Roaming

Association happens when the SSID, Encryption and MAC Address Control settings are correct between the AP and client. If 2 APs with these same settings are located in the same area, the client would choose to associate to the one which gives it a better signal strength. The client would roam over to the 2nd AP when he moves nearer to it. The client switches AP and frequency as he does so.

GETTING STARTED

Box Contents

Kindly check the contents of the box:

- 802.11g Wireless Router
- DC Adapter
- Ethernet cable
- CD Manual
- Quick Start Guide

Connecting the Router

The router is connected to the WAN and LAN networks.

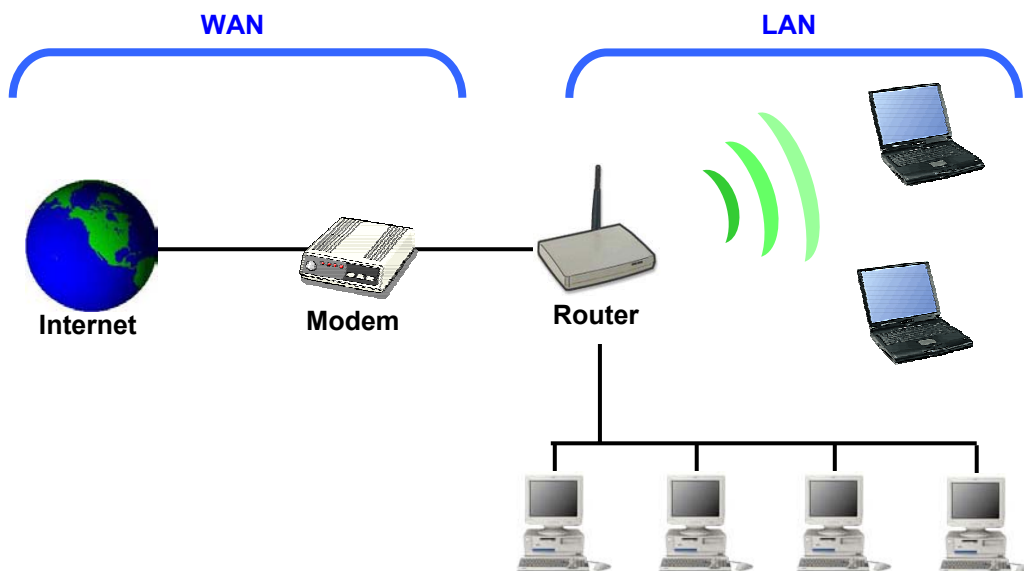

The cables are all connected to the back-panel of the Router. The PCs and Modem are connected to the Router via Ethernet cables.

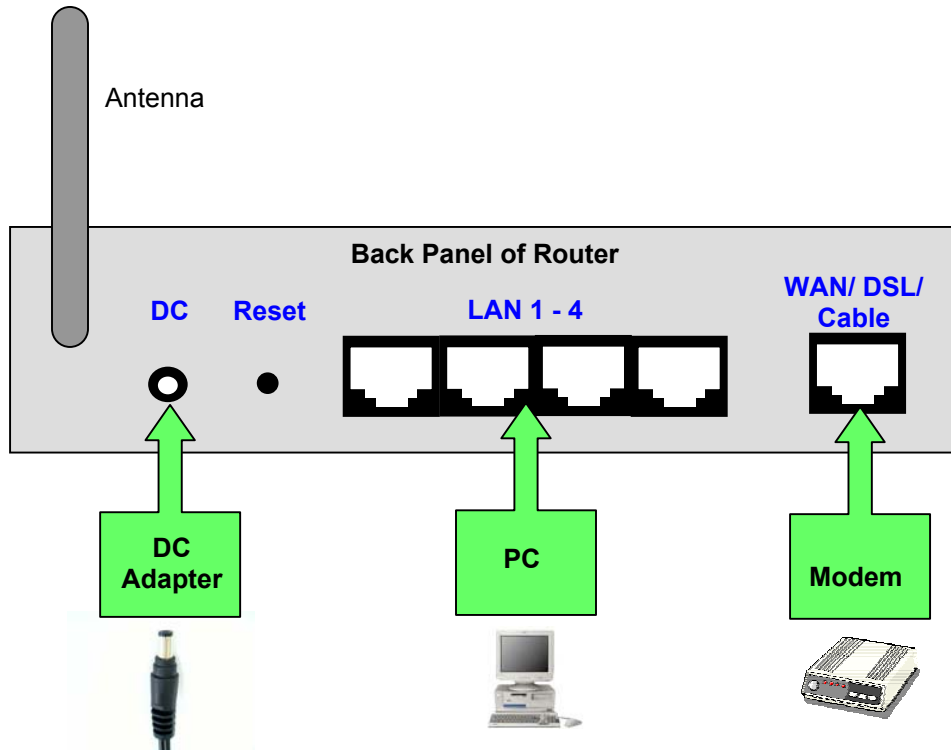

Quick Start Configuration (For DSL Modems)

This section is a quick-start guide applicable to most users. This assumes that the user is connecting the WAN port to a ADSL modem.

1. Connect the network as shown previously.



Switch on the Modem **BEFORE** you switch on the Router. **Every** time.



- Check that the WAN light on the Router lights up.
- If your PC is connected via **Ethernet cable**, check that the corresponding LAN LED lights up on the Router.
- If your PC is **wireless**, check the PC's card utility to make sure that the signal strength is good.

2. Open a Web browser (Internet Explorer, Netscape etc.)
3. Type the Router's LAN IP (**10.0.0.1**) address into the browser's Address field.

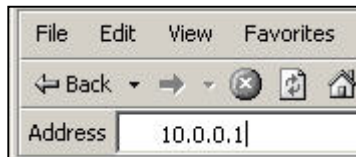

4. The Quick Configuration page opens up.

Quick Configuration

DHCP Client

ADSL Modem / PPPoE Configuration

Username: john@isp

Password: XXXXXXXXXXXXXXXXXXXX

5. Enable **ADSL Modem/PPPoE**.
6. Key in the ADSL Username and Password provided by your ISP.
7. Press **Apply**.
8. Reboot the Router.



WEB CONFIGURATION

In every Router Web Configuration page, the left panel is the navigation menu containing the main sections. The right-side frame is where the detailed configuration is done.

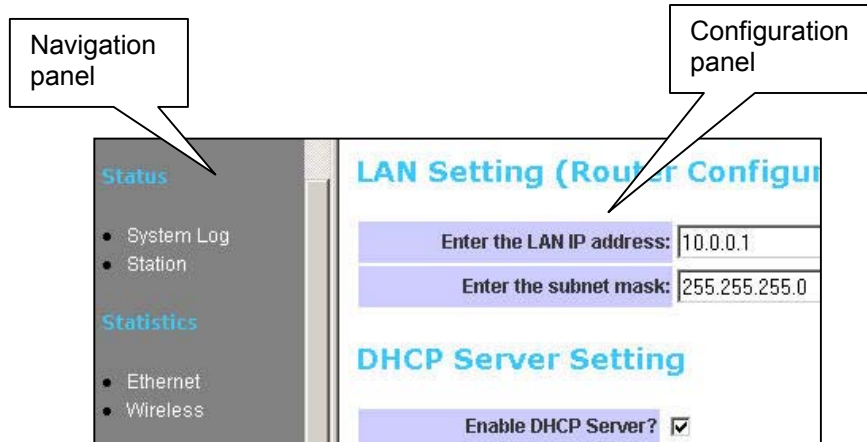

Remember that after every configuration change, it is necessary to:

- Click **Apply** on the page.
- **Reboot** the Router.



The changes take effect only AFTER Reboot.

Quick Configuration

This page contains the most important settings to get the Router functioning in either a home/small office environment. Basically, this page specifies what the WAN port is connected to.

Quick Configuration

DHCP Client

ADSL Modem / PPPoE Configuration

Username:

Password:

Static IP

WAN Static IP:

WAN Subnet Mask:

WAN Gateway:

DNS:

Note : Please reboot for the settings to take effect

DHCP Client: By default, or when you boot up the Router for the first time, the WAN port is in DHCP Client mode. The WAN port will obtain an IP Address from an upstream DHCP Server or Cable modem.

ADSL Modem / PPPoE: Select this option if the WAN is connected to an ADSL Modem. Key in your ISP-provided Username and Password.

Static IP: This setting is for advanced users only. You assign a Static IP to the WAN port.

PPPoE Connection

Connection Status : PPPoE not enabled

Connect/Disconnect: The buttons allow you to manually Connect/Disconnect the ADSL connection. The status of the ADSL connection is also shown.



If **ADSL Modem/PPPoE** is selected, the Router automatically dials the connection at every power up.

Status

System Log

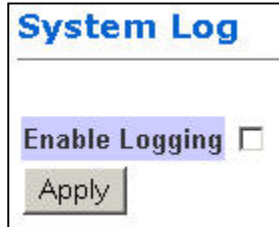

System Log

Enable Logging

Apply

This page shows the system log of the Router. You can Enable/Disable the logging.

Station

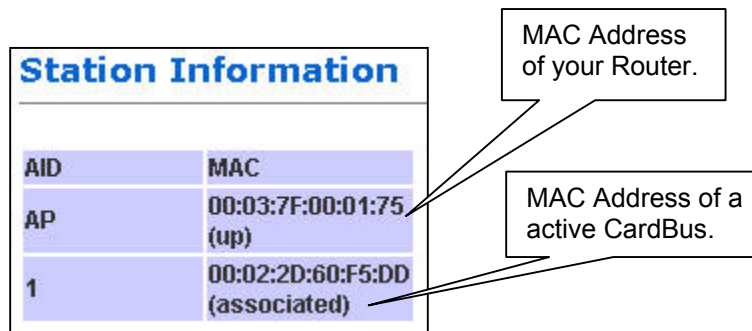

AID	MAC
AP	00:03:7F:00:01:75 (up)
1	00:02:2D:60:F5:DD (associated)

MAC Address of your Router.

MAC Address of a active CardBus.

The Station page shows the status and MAC Addresses of the WLAN network.

Statistics

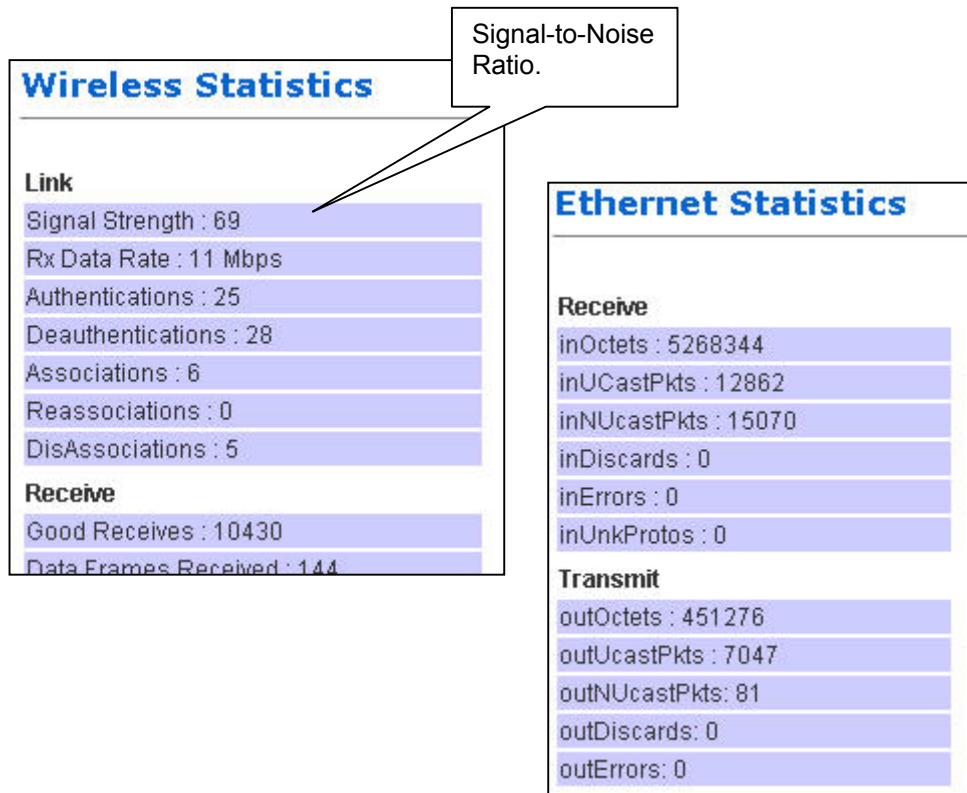

Ethernet and Wireless Statistics show the statistics of the traffic handled by the Router. The Signal Strength parameter shows the Signal-to-Noise ratio of the Wireless link. The higher the number, the better the link.

LAN & DHCP Configuration

This page is for the configuration of the Router's internal (LAN) IP Address and the properties of the built-in DHCP Server. Take note that the built-in DHCP Server distributes IP Addresses to **both** the LAN ports and the WLAN clients.

LAN Setting

LAN & DHCP Configuration

LAN Setting (Router Configuration)

Enter the LAN IP address:	<input type="text" value="10.0.0.1"/>
Enter the subnet mask:	<input type="text" value="255.255.255.0"/>

LAN IP address: This is where you assign a local IP address to your router's LAN port. The factory default value is 10.0.0.1. It is not recommended to change the LAN address for no reason.

Subnet Mask: This is where you assign the corresponding subnet mask. The default subnet mask is 255.255.255.0.

(Note: When you change the LAN Setting of the Router, you need to reset/renew the Local computer IP address.)

DHCP Server Setting

DHCP Server Setting

Enable DHCP Server?	<input checked="" type="checkbox"/>
DHCP address pool selection:	<input checked="" type="checkbox"/> System Allocated (check) <input type="checkbox"/> User Defined (uncheck)
DHCP address pool (For User Defined only)	
Start Address:	<input type="text" value="10.0.0.10"/>
End Address:	<input type="text" value="10.0.0.50"/>
Lease Time:	<input type="text" value="1"/> days <input type="text" value="0"/> hours <input type="text" value="0"/> minutes <input type="text" value="0"/> seconds

Enable DHCP Setting: Tick to enable the built-in DHCP (Dynamic Host Configuration Protocol) Server. When enabled, the Router will provide IP addresses to the computers connected to the router.

DHCP address pool selection: If this is selected, router will assign IP address automatically from the pre-defined pool. If de-selected, you would have to define the range of the pool manually.

DHCP address pool (For User Defined only), Start Address: This is the start address of the DHCP pool. The router will assign this to the first computer connected to the router.

(Note: This setting will only take effect when User defined is selected under DHCP address pool selection.)

DHCP address pool (For User Defined only), End Address: This is the end address that the router will assign to the computers connected to the router.

(Note: This setting will only take effect when User defined is selected under DHCP address pool selection.)

Lease Time: The amount of time a network computer will be allowed to connect with the DHCP Server. By default, the lease time is 1 week.

(Note: This setting will only take effect when User defined is selected under DHCP address pool selection.)

WAN Configuration

This page allows you to configure how the WAN is connected. For ADSL modem users, you have to use **PPP**. If you connect the WAN to an existing Ethernet network, you have to set either **Static WAN** or **DHCP Client**. The new Router is in DHCP Client mode.

Quick Configuration page would actually take care of your WAN settings. This **WAN Configuration** page is for advanced users to fine-tune their network.

PPP Configuration

This section lets you configure the PPP dial-up settings. This part is configured if you connect the WAN port to a ADSL modem.

WAN Configuration

PPP configuration (optional)

Enable PPPoE	<input type="checkbox"/>
Obtained IP	PPPoE not enabled / Disconnected
Username:	<input type="text"/>
Password:	<input type="password"/>
MTU	<input type="text" value="1492"/>
Auto disconnect from ISP when there is no data transfer?	<input type="text" value="0"/> seconds (Maximum allo
Enable auto reconnect to ISP when launching web browser?	<input type="checkbox"/>

Enable PPPoE: If you are using a ADSL modem, you have to enable PPPoE.

Obtained IP: This displays the IP of your WAN as given by the ADSL modem.

Username: Enter the username given by your Internet Service Provider.

Password: Enter the password given by your Internet Service Provider.

MTU: Maximum Transmission Unit indicates that packets larger than this size will be fragmented before the transmission. Use the default 1492.

Auto disconnect from ISP when there is no data transfer?: Allows you to set a specific period of time to disconnect from the Internet Service Provider. The factory default is 0, which means it will never disconnect from Internet Service Provider.

Enable auto reconnect to ISP when launching web browser?: Router will auto-connect to Internet Service Provider when user launches web browser on his PC.

Static WAN Configuration

This section lets you configure Static WAN IP settings.

Static WAN configuration (optional)	
WAN Static IP:	172.20.192.125
WAN Subnet Mask:	255.255.252.0
WAN Gateway:	172.20.195.254
DNS:	155.69.5.225

WAN Static IP: Enter the static IP address.

WAN Subnet Mask: Enter the subnet mask.

WAN Gateway: Enter the WAN Gateway IP.

DNS: Enter the DNS Server IP Address.



When in DHCP client mode, these 4 columns show the IP settings obtained from the network.

DHCP Client

This section lets you configure the WAN port as a DHCP Client. This is the Factory Default mode.

DHCP Client	
Enable DHCP Client?	<input type="checkbox"/>
Status:	Not enabled

Enable DHCP Client?: Select to enable WAN as a DHCP Client.

Status: This shows the status of the WAN port, whether it has obtained a IP lease or not.

Apply and Reset

After making the necessary changes, make sure you hit Apply and Reset.

Apply	Reset
-------	-------

Ensure that you do this for every updated page.

Bridge

The Router can also be used as a Wireless Bridge. This is used when it is not advisable to lay an Ethernet line over a distance. Two routers can be set up to connect over this distance, acting as the wired backbone.

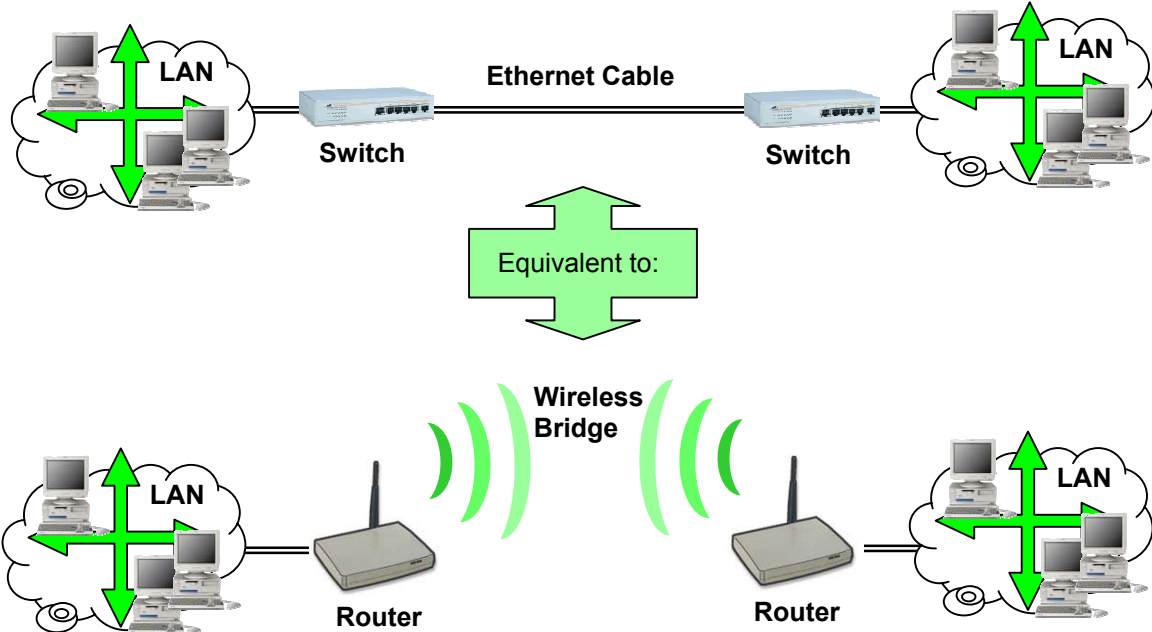

To establish the Bridge link,

1. Connect your PC to Router1's LAN port. Do not connect anything to the WAN.
2. Get Router2's MAC Address from Router2's Station Information.

Station Information	
AID	MAC
AP	00:03:7F:00:01:75 (up)
1	00:02:2D:60:F5:DD (associated)

1. Log in to Router2's Station Information to read the Router's MAC Address here.

3. Key Router2's MAC Address into Router1.

Bridge Links	
Add/Delete Link	
MAC Address:	<input type="text"/>
Existing Links	00:02:2D:60:F5:DD
	<input type="button" value="Add"/> <input type="button" value="Delete"/>

2. Enter Router2's MAC into Router1's Bridge Link.

-
4. Change Router1's LAN IP and subnet so that it can exist in LAN1.
 5. Make sure that LAN1 and LAN2 are also in the same subnet!
 6. Disable Router1's DHCP Server.
 7. Apply and Reboot.
 8. Connect the LAN port of Router1 to LAN1.
 9. Repeat the process for Router2.

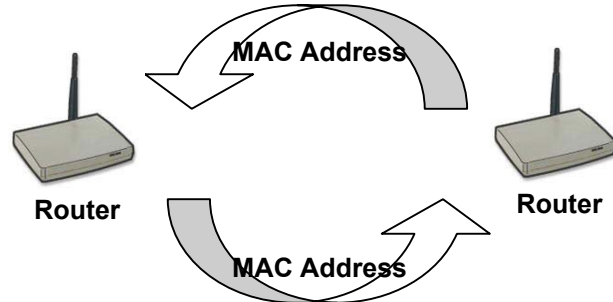

10. Ensure that the SSID and Channel are the same for both Routers.

Wireless

This page lets you configure the Wireless settings.
There are 3 sections: Radio, Security, Advanced.

Radio Settings

Wireless	
Radio	
SSID	<input type="text" value="11g"/>
Channel	<input type="text" value="11"/> (From 1 to 13)
Hide SSID	<input type="checkbox"/>
Turbo Mode	<input type="checkbox"/>
MAC Address Filtering	MAC Address Filter Table

SSID: Service Set Identifier. It is a sequence of characters that uniquely names a Wireless LAN. This name allows PCs to connect to the correct Wireless Access Point when multiple Access Points (or Wireless Routers) operate in the same location.

Channel: The radio channel number.

Hide SSID: When this is ticked, the router will not broadcast the SSID. Unwelcome PCs will not be able to scan for the SSID of this Router, and they can only associate if they know exactly what is the SSID.

Turbo Mode: When this mode is enabled, the Router would communicate with the CardBus at 108Mbps instead of 54Mbps. Turbo mode MUST also be enabled on the CardBus.



Take note of the effects of the following combinations.

Router	CardBus	Connection Speed
Non-turbo	11b	11Mbps
Non-turbo	11g	54Mbps
Non-turbo	Turbo	No connection!
Turbo	11b	11Mbps
Turbo	11g	54Mbps
Turbo	Turbo	108Mbps
Router	802.11b Card	Connection Speed
Non-turbo	11b	11Mbps
Turbo	11b	No connection!



Turbo setting comes with some limitations. In Turbo mode,

- All the devices automatically use Channel 6. Therefore, implementing multiple cells is not possible with Turbo mode.
- The network is more sensitive to interference. Wireless Access Points operating nearby, regardless of channel, can cause interference to the Turbo network.

To enable **MAC Address Filtering**, click on the link [MAC Address Filter Table](#). Only valid computers (whose MAC addresses are in the MAC address table) would be allowed to access the router.



Enable MAC Access Control: Tick the box to enable MAC Address Filtering.

MAC Address Add/Delete: Enter the MAC Address in the format 00:11:22:33:44:55 to be Added or Deleted from the table.

Allowed MAC Addresses: Displays the MAC Addresses currently allowed.

Currently Associated Stations: Lists the MAC Addresses of the currently connected Cards. The first MAC Address belongs to the Router, just for information. You can copy the cards' MAC Addresses from this list to paste into the "Add" or "Delete" list.

Access Control List

Add/Delete ACL

Enable MAC Access Control

MAC Address:

Allowed MAC Addresses

Currently Associated Stations

AID	MAC
AP	00:03:7F:00:01:75 (up)
1	00:02:2D:60:F5:DD (associated)

Update: Click Update to enable the new Table.



Security

This section allows you to configure wireless encryption to prevent unwelcome parties from reading your traffic. Authentication can also be configured to block outsiders from accessing your network.

Security		
Security Mode:	<input checked="" type="checkbox"/> Enable Encryption	
Authentication:	<input checked="" type="radio"/> Open-system <input type="radio"/> Shared-key	
Hexadecimal Key Entry	<input type="checkbox"/> (Uncheck for ASCII key entry)	
Shared Key 1 <input checked="" type="radio"/>	<input type="text" value="1234567890abcabc"/>	152 bit (32 hex digits/16 ascii keys) ▾
Shared Key 2 <input type="radio"/>	<input type="text"/>	None ▾
Shared Key 3 <input type="radio"/>	<input type="text"/>	None ▾
Shared Key 4 <input type="radio"/>	<input type="text"/>	None ▾

Security Mode. Enable Encryption: Tick the box to enable the following suite of Encryption and Authentication features.

Open-System: When chosen, the Key is not used for authentication. It is only used for encryption. Open-System uses Static Keys for encryption. Static (Shared) Keys are never changed, and a hacker can crack the key after a period of time.

Shared-Key: When chosen, the encryption Key is also used for authentication between the Router and Client. Note that this system is also using Static Keys.



Open-System and Shared-Key work like the WEP system in 802.11b networks. In fact, 802.11b (11Mbps) cards can turn on WEP and work with the Router using either Open-System or Shared-Key. Some cards do not support Shared-Key. Use Open-System for simple management.

Hexadecimal Key Entry: Tick this box if you want to enter the Keys in hexadecimal format. Otherwise, enter in ASCII format. ASCII is also called Alphanumeric in some systems. Use the same key format for the Router and Client!



Hexadecimal Characters:
0,1,2,3,4,5,6,7,8,9 and a,b,c,d,e,f

ASCII Characters:
0,1,2,.....8,9 and
a,b,c,d,.....x,y,z

None ▾
None
64 bit (10 hex digits/ 5 ascii keys)
128 bit (26 hex digits/13 ascii keys)
152 bit (32 hex digits/16 ascii keys) ▾

Shared Key 1-4: For Open-System and Shared-Key, the Key is to be entered in the boxes. The **SAME Key** must be entered in both the Router and Client. Take note that there is a different Key length for a different number of encryption bits. 152 bits is the most secure, but make sure that your Client card supports it. The last point to take note is that if you use Key 4 on the Router, you must also use Key 4 on the Client, for example. The same logic applies for Keys 1-3.

In summary, the Keys must be

- The same
- The same length
- The same number of bits chosen
- The same format (Hex or ASCII)
- The same location (1-4)

Advanced Settings

This section is for the configuration of some of the Advanced Settings.

Advanced Settings	
Short Preamble	<input checked="" type="checkbox"/>
Radius Server IP Address	<input type="text" value="192.168.1.25"/>
Radius Shared Secret	<input type="text" value="abc"/>
Key Source	<input checked="" type="checkbox"/> Local <input type="checkbox"/> Remote

Short Preamble: Tick the box to use Short Preamble in the Wireless LAN packet headers. Most manufacturers implement long preambles. Even if there is a mismatch between the Router and the card, they can still connect well and the mismatch may not be noticeable to most users. Do not change this setting without seeking advice.

RADIUS Server IP Address: Enter the IP Address of the RADIUS Server (for 802.1x authentication purposes). This is used only when you have a RADIUS Server and want to use it for authentication. Almost all homes and many offices do not have a RADIUS Server. These 3 settings are for advanced users only.

RADIUS Shared Secret: Enter the Shared Secret of the RADIUS Server. (Only if 802.1x protocol is used.)

Key Source: Specify the location of the key storage. (Only if 802.1x is used.)

NAT

This page lets you configure your NAT (Network Address Translation).

NAT Configuration

Enable NAT?

Apply

Enable NAT?: Tick to enable NAT. NAT allows the sharing of one broadband connection between multiple PCs. This setting is for advanced users only.



For almost all purposes, **ENABLE** the NAT.

DMZ Configuration

The **DMZ** (De-Militarized Zone) Configuration page lets you map a local computer to this zone. By default, the Router protects the PCs from the Internet. The local PCs can access the Internet (WAN) but not vice versa. Local PCs are hidden behind the NAT and Firewall. DMZ is used when you want to expose that PC to the Internet. For example, you want to set up a Web Server or Game Server such that outsiders can access from the Internet.

DMZ Configuration

Enable DMZ?	<input checked="" type="checkbox"/>
DMZ Host IP	<input type="text" value="10.0.0.10"/>

Note: Port Forwarding has precedence over DMZ

Enable DMZ?: Tick to enable DMZ.

DMZ Host IP: Enter the local computer's (Web or Game Server) IP address.



All the ports of the PC in the DMZ would be exposed to the Internet. The DMZ can be understood as a form of Port Forwarding where ALL the ports are forwarded! DMZ is commonly used for hosting a Web Server.

For example, let's say your Web Server in the DMZ has IP Address 10.0.0.10, and the Router's WAN has a IP Address of 222.222.222.222. To see your web page, a person on the Internet only has to key in <http://222.222.222.222> in his web browser!

Note that Port Forwarding has precedence over DMZ. That means, if there were a conflict between them, the Router would use the rule in Port Forwarding.

SNTP Configuration

This page allows you to configure the Router to automatically synchronize its time. SNTP (Simple Network Time Protocol) is a standard that allows devices to synchronize their time according to SNTP Servers on the Internet.

SNTP Configuration

Enable SNTP	<input checked="" type="checkbox"/>
SNTP Server IP Address:	<input type="text" value="128.100.102.201"/>
Time Zone:	<input type="text" value="+8"/>

Click **Apply** to update changes

Enable SNTP: Click to enable the SNTP feature.

SNTP Server IP Address: Enter the IP Address of the SNTP Server on the Internet that you want to use for synchronization.

Time Zone: Enter your local time zone.

Your **System Log** would be displayed with real-time provided by the SNTP feature. This setting is for Advanced Users.

Port Forwarding

This page allows you to configure Port Forwarding. This feature is used when you need to set up Servers in the LAN. Traffic initiated from the WAN (Internet) is normally blocked. Port forwarding allows the specific type of traffic to pass through the Router to reach the Server in the LAN. Examples of these Servers are Web Servers and Game Servers.

PAT Configuration

Add New Rule

ID	Public Port	Private Port	Port Type	Host IP Address	
<input type="text"/>	<input type="text"/>	<input type="text"/>	<input checked="" type="radio"/> TCP <input type="radio"/> UDP	<input type="text"/>	<input type="button" value="Add This Rule"/>

Existing Rules

ID	Public Port	Private Port	Port Type	Host IP Address
----	-------------	--------------	-----------	-----------------

Remove Rule

ID	<input type="text"/>	<input type="button" value="Remove"/>
----	----------------------	---------------------------------------

Note: Port Forwarding has precedence over DMZ

Add new rule: This is where you specify the port to be map on the local computer.

ID: To append a serial number (0-19) to the particular Rule, so as to ease management.

Public Port: Refers to the port value on the WAN side.

Private Port: Refers to the port value on the LAN side.

Port Type: Select the type of protocol to be forwarded.

Host IP Address: Enter the IP address of the Local Server.

(**Tips:** Usually both Public Port and Private Port values are the same.)

Click **Add This Rule** button to add the rule.

Existing rules: This is the list of existing rules that have been specified on the router.

Remove rule: This is where you remove rules from the Router.

ID: Enter the ID number and click on the Remove button. The Rule is removed.

Common application port values:

Application	Port values	Type
FTP	21	TCP
Web Server	80	TCP
Telnet	23	TCP



While all the ports of the PC in the DMZ are exposed to the Internet, Port Forwarding only allows the ports that you specified to be opened up. DMZ can be understood as a form of Port Forwarding where **ALL** the ports are forwarded.

DMZ is usually easier to set up, but Port Forwarding is more secure. For the user accessing from the Internet, DMZ and Port Forwarding are basically similar in function.

Filter

This page is for the configuration of filters to block unwanted traffic from WAN (Internet).

Filter Management	
Enable filtering (WAN)	<input checked="" type="checkbox"/>
Blocked Services	
FTP	<input type="checkbox"/>
Telnet	<input type="checkbox"/>
HTTP	<input checked="" type="checkbox"/>
ICMP	<input type="checkbox"/>
Netbios	<input type="checkbox"/>
User defined port	<input type="text" value="0"/>

Enable filtering: Tick to enable the filtering features on this page.

Blocked Services: Tick beside the Service to block this Service from the Router.

FTP: Tick to disable FTP services (for firmware upgrade) from the Internet.

Telnet: Tick to disable telnet (a form of configuration tool) from the Internet.

HTTP: Tick to disable Web configuration by users in the Internet.

ICMP: Tick to disable Ping (a network troubleshooting tool) from the Internet.

NetBIOS: Tick to block NETBIOS (for Workgroup and File Sharing, etc) from the Internet.

User defined port: Configure a Service to be blocked even though it is not listed. Key in the specific port number.



If you have a PC connected to the WAN side, you can key in the WAN IP in your browser and access the Router's configuration pages!

For security reasons, you may want to block HTTP (web) in the Filter.

Protocol Filter (Wireless)	
AppleTalk	<input type="checkbox"/>
IPX	<input type="checkbox"/>
Broadcast/Multicast Filter (Wireless)	
Enable	<input checked="" type="checkbox"/>
Broadcast Threshold	<input type="text" value="100"/>
Multicast Threshold	<input type="text" value="100"/>

Protocol Filter. AppleTalk: Block AppleTalk Protocol between WAN and WLAN.

Protocol Filter. IPX: Block IPX Protocol between WAN and WLAN.

Enable: Tick to enable Packet Filtering by volume. These 2 settings are used to protect the limited WLAN bandwidth.

Broadcast Threshold: Enter the number of Broadcast packets (in Packets/second) to be allowed to travel between WAN and WLAN. Typical values can be 100.

Multicast Threshold: Enter the number of Multicast packets (in Packets/second) to be allowed to travel between WAN and WLAN. Typical values can be 100.

Web Security Configuration

This page allows you to configure Administrator's security for the Router.

Web Security Configuration

Enable Web Security

Enable Web Security: Tick the box and the Router would challenge every access to its Configuration Webpage. This feature prevents unauthorized configuration of your Router.



By default, you are not challenged when you try to access the Configuration pages. That means anyone with the correct WLAN settings can actually access the Router and change its settings!
You are recommended to turn this feature on, and give yourself a Administrator's Username and Password.

Admin Username and Password

These 2 pages allow you to change the Administrator's Username and Password.

Admin Username Configuration

Please enter the old username, and the new username.

Old Username

New Username

Admin Password Configuration

Please enter the old password, and the new password.
Your password should contain least 8 characters and do not use '&'.

Old Password

New Password

Retype Password

Every attempt to access the configuration pages of the router would be challenged, and the Administrator's Username and Password have to be used.



The default username is **admin**.

The default password is also **admin**.

After every **Factory Reset**, the Router reverts to this combination.

Firmware Update

This page allows you to update the firmware (software) of the Router. New firmwares are issued to improve the performance and add features to the product.

The Router is the FTP (File Transfer Protocol) client and your PC has to run a FTP Server using a simple utility software.

Step 1. Unzip Firmware Files

1. Create a directory in your **C Drive** hard disk and name it **firmware**.

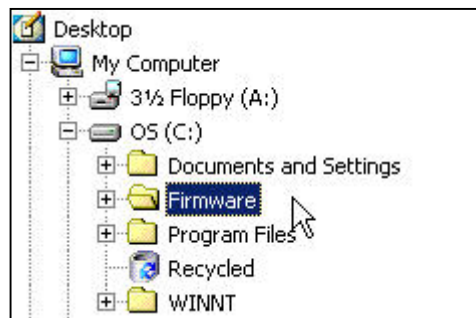

2. Unzip the firmware files and save them into your new directory **c:\firmware**

Step 2. Set up FTP Server

1. Run the software called WFTPD32.



2. Click Users/rights.

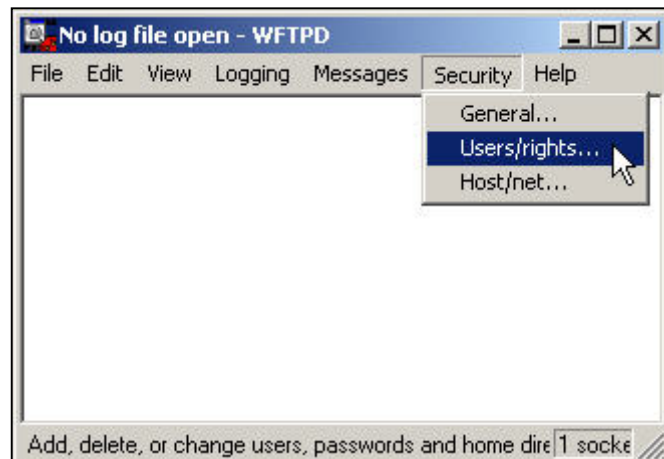

-
-
3. We have to **Create** a new user that has the name and password "**admin**".



-
-
-
4. Enter the User Name as **admin**.



-
-
-
-
5. Enter the password twice as **admin**.

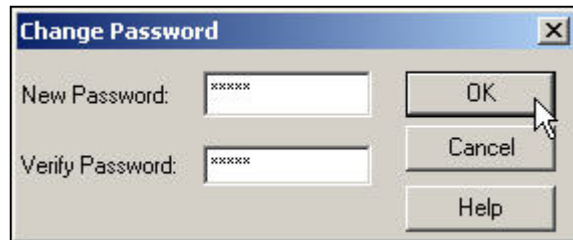

-
-
-
-
-
6. Type in **c:\firmware** as the Home Directory.
7. Click **Done**.

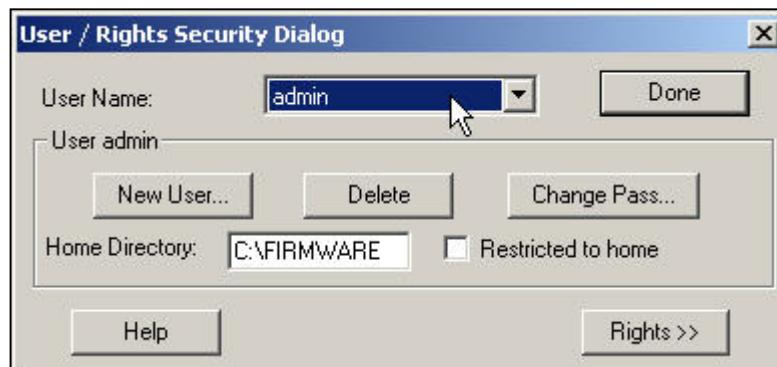

The FTP Server is now set up on your PC. You can proceed to Step 3.

The account has already been set up. In future, you would only need to do Step 1 and 2 and select the account **admin**, instead of default or anonymous.

Step 3. Update Firmware

1. Leave the original settings on the page intact. They have been pre-configured for you.
2. If you have accidentally changed the settings, configure using the picture below. The FTP Password is **admin**.

The screenshot shows the 'Firmware Update' page. At the top, it displays 'Current firmware version.' and 'Binary version : ap-5002-1.09'. Below this are five input fields: 'FTP Username' (admin), 'FTP Password' (admin), 'Image path' (c:\firmware\), 'Image name' (ap36c.sys), and 'FTP Server IP Address' (10.0.0.10). A note next to the IP address says '(Your IP is : 10.0.0.10)'. Below the fields is a 'Save' button with the text 'Click the Save to save the settings process.' and a callout '3. Click.'. Below the 'Save' button is an 'Update' button with the text 'Click the Update to start uploading of firmware. Please ensure that you have *BE SURE TO WAIT AND NOT TO ACCESS THE ROUTER UNTIL FIRMWARE IS UPDATED' and a callout '4. Click.'. There are also callouts '1. Read here.' pointing to the 'Current firmware version.' and '2. Enter here.' pointing to the 'FTP Password' field.

3. Enter your PC's IP Address. To help you, the Router suggests it to you on the web page.
4. **Save** the settings.
5. Click **Update** and wait at least 40 seconds rebooting the Router.

Your firmware has been updated. After reboot, check that the version number has indeed changed.

Save Configuration

This page allows you to save a “Good” Configuration into the Router’s memory.

Save Last Known Good Configuration

You're about to backup settings to known good configuration.

Backup Configuration

Please check the box and click "Confirm" proceed.

After you have successfully configured the Router, you can save this “Good Config” into memory. You can retrieve this “Good Config” later, if you have messed up some settings and do not know what was the previous working setting. If you have even forgotten the password to get into the configuration pages, you would have to do a Factory Reset to the Router.

There are 3 levels of configuration settings in the Router.

	Saved/Updated by:	Loaded when:
Running Config	Every time you make a change and click Apply, it is saved into Running Config. The changes take effect after a power on/off. 	Every power up.
Good Config	Manually saving the settings in “Save Last Known Good Configuration”.	Manually restoring it in the “Restore Settings” page.
Factory Default	There is no way to change the Factory Default settings!	When you press the Reset button at the back of the Router for 10 seconds.



Most users would not need this “Good Config” feature.

Just remember to **Apply** and **Reboot** every time you make a change.

PC CONFIGURATION

The Router's function is to connect multiple PCs to the Internet. In addition to configuring the Router, the PCs' IP settings would also need to be configured.

It is easiest to use DHCP client for the PCs. This is also the default whenever you:

- a. Install a new Wireless PCMCIA/Cardbus card, or
- b. When you plug a Ethernet cable into your PC for the first time.

Fortunately, in default mode, the Router's DHCP Server is on. This means that when you buy a new Router and install a new Wireless Card, the IP settings on the PC are already correct!

In the event that you need to troubleshoot the IP settings, the easiest method is:

- a. Perform a Hardware Reset to the Router, and
- b. Perform a following to configure Automatic IP (DHCP Client) on the PC.

DHCP IP Address

The steps outlined are applicable for Windows PCs. The GUI for Windows 98SE and ME may look slightly different, but the steps are the same.

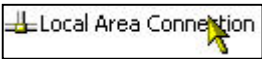
1. Connect the PC to the Router. This can be via Ethernet or Wireless. Do not connect any other networking devices! Do not connect the modem to the PC!
2. Go to **Start >> Settings >> Control Panel >> Network and Dial-Up Connections**
3. Double-click Local Area Connection. 

4. Click on Properties.

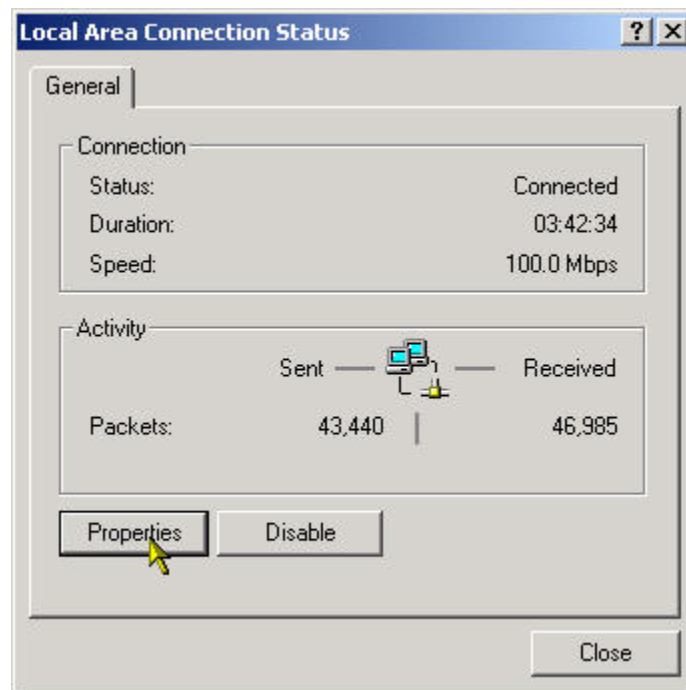

-
5. In the box, click on Internet Protocol (TCP/IP). Make sure there is a tick in the box for TCP/IP.



6. Use automatic for both the settings. Click OK and close all windows.

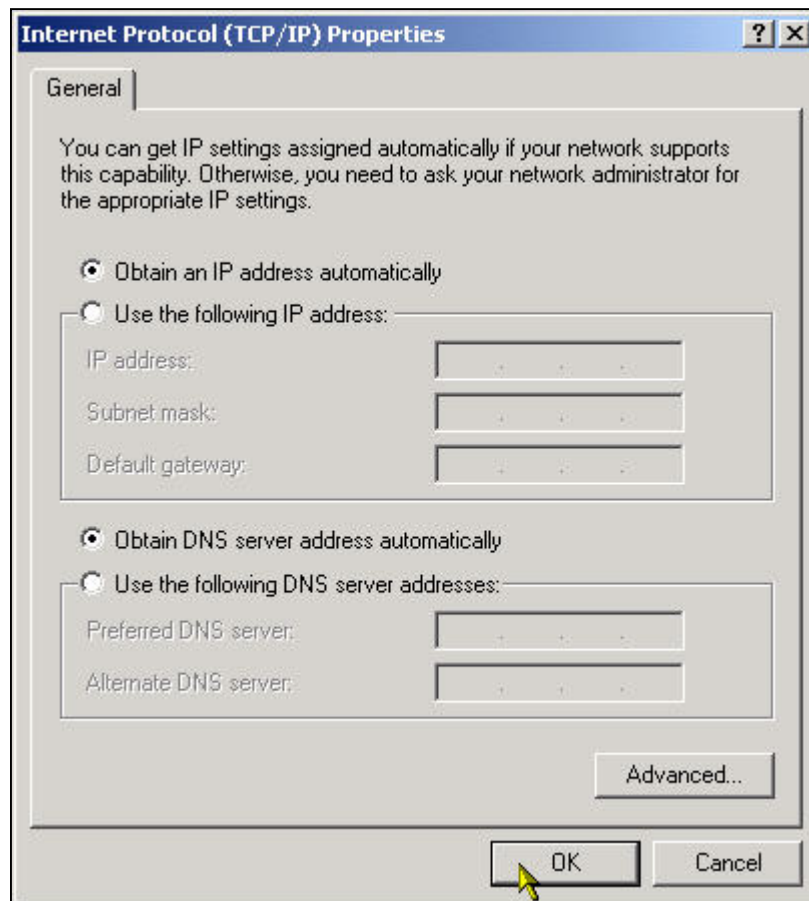

7. Windows 98SE and ME may prompt you for a reboot.

DHCP Client has been set up on your PC. Make sure you do a Factory Reset to the Router and configure your broadband account again.

FACTORY RESET

When you have wrongly configured the Router and wish to start all over again, you can perform a Factory Reset to restore the Router to its original state. Simply use a paper clip or any pointed object to press in the hole for 5-10 seconds and release.

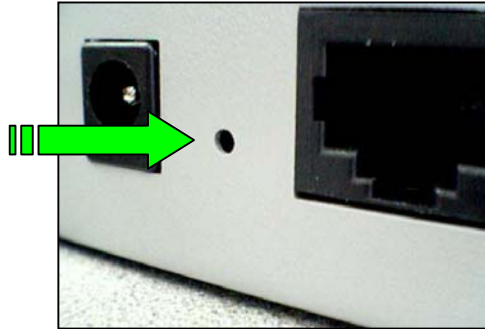

The Router would be reset to its original Factory Default configuration:

Router's Feature	Factory Default
WAN	WAN is a DHCP client
LAN IP (including WLAN)	10.0.0.1
DHCP Server (including WLAN)	On. Lease starts from 10.0.0.2
System Log	Off
SSID	11g
Channel	11
Turbo mode	Off
MAC Address Control	Off
Encryption	Off
NAT	On
DMZ	Off
Port Forwarding	Off
Filtering	Off. (No block)
Administrator's Security	Off. (No password needed)