



Test report No. : 4790323504B-US-R0-V0
Page : 1 of 43
Issued date : 2022/3/22
FCC ID : RLY21GMD01

RADIO TEST REPORT

Product : ALPHA Dongle
Model Name : ALPHAMD-BKBWW
FCC ID : RLY21GMD01
Test Regulation : FCC 47 CFR Part 15 Subpart C (Section 15.247)
Received Date : 2022/2/24
Test Date : 2022/3/8~ 2022/3/15
Issued Date : 2022/3/22

Applicant : ADATA Technology Co., Ltd.
2F., No.258, Lian Cheng Rd., Chung Ho Dist., New Taipei
City 235, Taiwan (R.O.C.)

Issued By : Underwriters Laboratories Taiwan Co., Ltd.
Building B and Building E, No. 372-7, Sec. 4, Zhongxing Rd.,
Zhudong Township, Hsinchu County, Taiwan



The results reported herein have been performed in accordance with the laboratory's terms of accreditation. This report shall not be reproduced except in full without the written approval of the Laboratory. The results in this report are responsible of the test sample(s) provided by the client only and are not to be used to indicate applicability to other similar products.

Underwriters Laboratories Taiwan Co., Ltd.

Building B and Building E, No. 372-7, Sec. 4, Zhongxing Rd., Zhudong Township, Hsinchu County, Taiwan
Telephone :+886-2-7737-3000
Facsimile (FAX) :+886-3-583-7948

Doc No: 17-EM-F0876 / 6.0



Table of Contents

1. Attestation of Test Results	4
2. Summary of Test Results	5
3. Test Methodology and Reference Procedures.....	6
4. Facilities and Accreditation	6
5. Measurement Uncertainty	7
6. Equipment under Test	8
6.1. Description of EUT	8
6.2. Channel List	9
6.3. Test Condition.....	9
6.4. Description of Available Antennas	9
6.5. Test Mode Applicability and Tested Channel Detail.....	11
6.6. Duty cycle	12
7. Test Equipment.....	13
8. Description of Test Setup.....	15
9. Test Results.....	17
9.1. 6dB Bandwidth	17
9.2. Conducted Output Power	19
9.3. Power Spectral Density	21
9.4. Conducted Out of Band Emission.....	23
9.5. Radiated Spurious Emission	27
9.6. AC Power Line Conducted Emission	40

Underwriters Laboratories Taiwan Co., Ltd.

Building B and Building E, No. 372-7, Sec. 4, Zhongxing Rd., Zhudong Township, Hsinchu County, Taiwan

Telephone :+886-2-7737-3000

Facsimile (FAX) :+886-3-583-7948

Doc No: 17-EM-F0876 / 6.0



1. Attestation of Test Results

APPLICANT: ADATA Technology Co., Ltd.
2F., No.258, Lian Cheng Rd., Chung Ho Dist., New Taipei City 235,
Taiwan (R.O.C.)

EUT DESCRIPTION: ALPHA Dongle

BRAND: XPG

MODEL: ALPHAMD-BKBWW

SAMPLE STAGE: Engineering Verification Test sample

DATE of TESTED: 2022/3/8~ 2022/3/15

APPLICABLE STANDARDS	
STANDARD	Test Results
FCC 47 CFR PART 15 Subpart C (Section 15.247)	PASS

Underwriters Laboratories Taiwan Co., Ltd. tested the above equipment in accordance with the requirements set forth in the above standards. All indications of Pass/Fail in this report are opinions expressed by Underwriters Laboratories Taiwan Co., Ltd. based on interpretations and/or observations of test results. Measurement Uncertainties were not taken into account and are published for informational purposes only. The test results show that the equipment tested is capable of demonstrating compliance with the requirements as documented in this report.

Note: The results documented in this report apply only to the tested sample, under the conditions and modes of operation as described herein. This document may not be altered or revised in any way unless done so by Underwriters Laboratories Taiwan Co., Ltd. and all revisions are duly noted in the revisions section. Any alteration of this document not carried out by Underwriters Laboratories Taiwan Co., Ltd. will constitute fraud and shall nullify the document. This report must not be used by the client to claim product certification, approval, or endorsement by NVLAP, NIST, any agency of the Federal Government, or any agency of any government.

Prepared By:

Sally Lu
Project Handler

Date : 2022/3/22

Approved and Authorized By:

Kent Liu
Senior Project Engineer

Date : 2022/3/22

Underwriters Laboratories Taiwan Co., Ltd.

Building B and Building E, No. 372-7, Sec. 4, Zhongxing Rd., Zhudong Township, Hsinchu County, Taiwan
Telephone : +886-2-7737-3000
Facsimile (FAX) : +886-3-583-7948



2. Summary of Test Results

Summary of Test Results		
FCC Clause	Test Items	Result
15.247(a)(2)	6dB Bandwidth	PASS
15.247(b)	Conducted Output Power	PASS
15.247(e)	Power Spectral Density	PASS
15.247(d)	Antenna Port Emission	PASS
15.205 / 15.209 / 15.247(d)	Radiated Emissions and Band Edge Measurement	PASS
15.207	AC Power Conducted Emission	PASS
15.203	Antenna Requirement	PASS

Underwriters Laboratories Taiwan Co., Ltd.

Building B and Building E, No. 372-7, Sec. 4, Zhongxing Rd., Zhudong Township, Hsinchu County, Taiwan

Telephone :+886-2-7737-3000

Facsimile (FAX) :+886-3-583-7948

Doc No: 17-EM-F0876 / 6.0



3. Test Methodology and Reference Procedures

The tests documented in this report were performed in accordance with 47 CFR FCC Part 2, KDB558074 D01 Meas Guidance v05r02, KDB414788 D01 Radiated Test Site v01r01, ANSI C63.10-2013.

4. Facilities and Accreditation

Test Location	Underwriters Laboratories Taiwan Co., Ltd.
Address	Building B and Building E, No. 372-7, Sec. 4, Zhongxing Rd., Zhudong Township, Hsinchu County, Taiwan
Accreditation Certificate	Underwriters Laboratories Taiwan Co., Ltd. is accredited by TAF, Laboratory Code 3398.

Underwriters Laboratories Taiwan Co., Ltd.

Building B and Building E, No. 372-7, Sec. 4, Zhongxing Rd., Zhudong Township, Hsinchu County, Taiwan

Telephone :+886-2-7737-3000

Facsimile (FAX) :+886-3-583-7948



5. Measurement Uncertainty

For statement of conformity, accuracy method (Section 8.2.4 and 8.2.5 of ISO Guide 98-4) was applied as decision rule for measurement in this test report.

The following uncertainties have been calculated to provide a confidence level of 95 % using a coverage factor $k=2$.

Measurement	Frequency	Uncertainty
Conducted disturbance at mains terminals ports	150kHz ~ 30MHz	± 3.1 dB
RF Conducted	9 kHz - 40GHz	± 1.9 dB
Radiated disturbance below 30MHz	9 kHz - 30 MHz	± 1.9 dB
Radiated disturbance below 1 GHz	30MHz ~ 1GHz	± 5.4 dB
Radiated disturbance above 1 GHz	1GHz ~ 40GHz	± 4.7 dB

Underwriters Laboratories Taiwan Co., Ltd.

Building B and Building E, No. 372-7, Sec. 4, Zhongxing Rd., Zhudong Township, Hsinchu County, Taiwan

Telephone : +886-2-7737-3000

Facsimile (FAX) : +886-3-583-7948

Doc No: 17-EM-F0876 / 6.0



6. Equipment under Test

6.1. Description of EUT

Product	ALPHA Dongle
Brand Name	XPG
Model Name	ALPHAMD-BKBWW
Operating Frequency	2403MHz ~ 2475MHz
Modulation	GFSK
Transfer Rate	Up to 2 Mbps
Number of Channel	5
Maximum Output Power	4.15 dBm
Normal Voltage	5Vdc from USB
Sample ID	4737134

Note:

1. The above EUT information is declared by manufacturer and for more detailed features description, please refer the manufacturer's or user's manual.

Underwriters Laboratories Taiwan Co., Ltd.

Building B and Building E, No. 372-7, Sec. 4, Zhongxing Rd., Zhudong Township, Hsinchu County, Taiwan

Telephone :+886-2-7737-3000

Facsimile (FAX) :+886-3-583-7948

Doc No: 17-EM-F0876 / 6.0



6.2. Channel List

5 channels are provided to this EUT:

Channel	Frequency (MHz)
1	2403
2	2423
3	2440
4	2461
5	2475

6.3. Test Condition

Test Item	Test Site No.	Environmental Condition	Input Power	Test Date	Tested by
Antenna Port Conducted Measurement	SR4	22~25°C/ 67.7~69%RH	5Vdc from USB	2022/03/15~ 2022/03/15	WaterNil Guan
Radiated Spurious Emission	966-2	22~24°C/ 62~68%RH	5Vdc from USB	2022/03/10~ 2022/03/11	WaterNil Guan
AC power Line Conducted Emission	SR1	24~24°C/ 67.7~69%RH	5Vdc from USB	2022/03/08~ 2022/03/08	WaterNil Guan

FCC Test Firm Registration Number: 498077

6.4. Description of Available Antennas

Ant. No.	Transmitter Circuit	Brand Name	Model Name	Ant. Type	Maximum Gain (dBi)
1	Chain (0)	WoodStone	2.4GHZ ANTENNA	PCB	-2.68

Underwriters Laboratories Taiwan Co., Ltd.

Building B and Building E, No. 372-7, Sec. 4, Zhongxing Rd., Zhudong Township, Hsinchu County, Taiwan

Telephone :+886-2-7737-3000

Facsimile (FAX) :+886-3-583-7948

Doc No: 17-EM-F0876 / 6.0

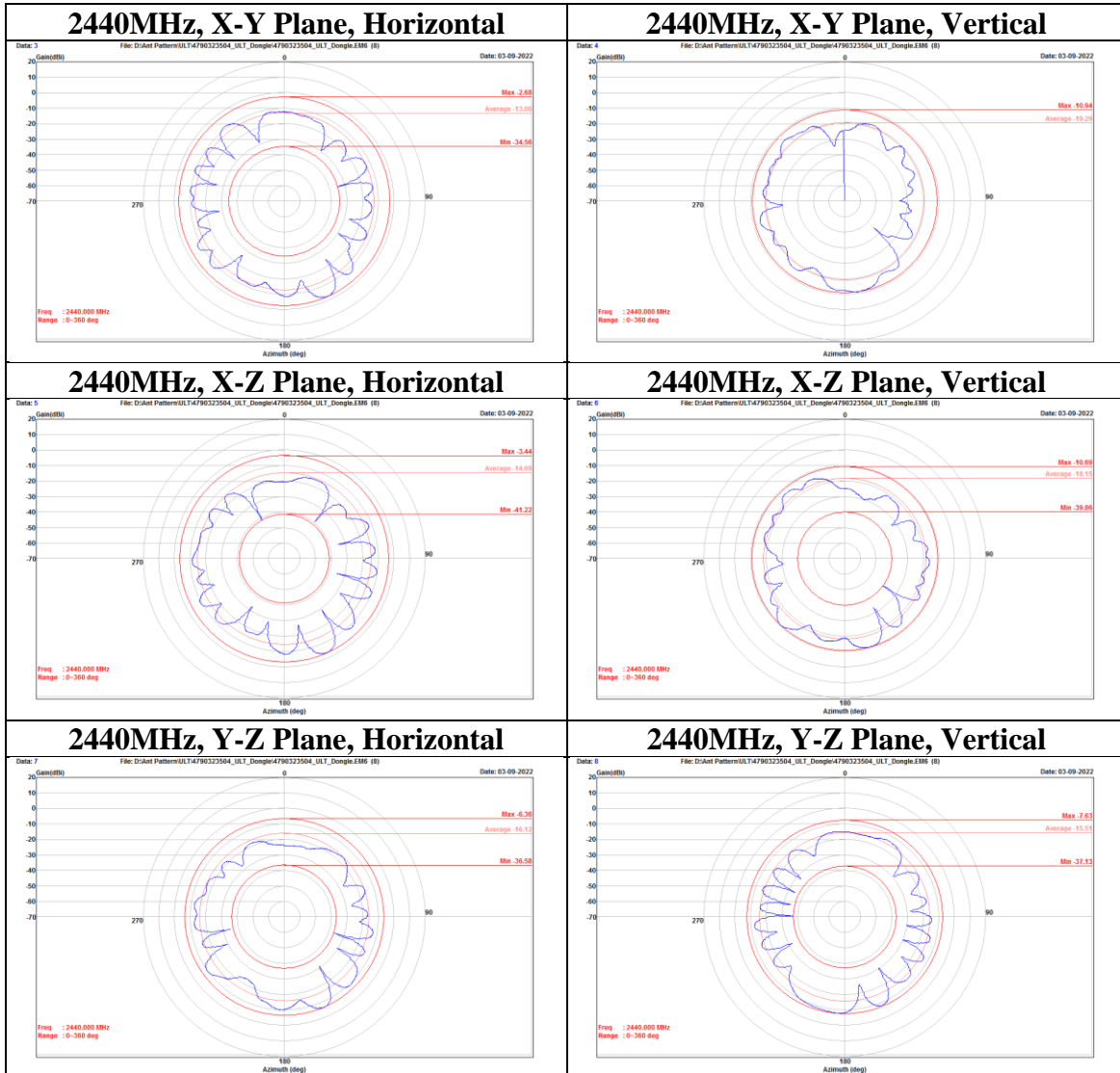

Note: The above antenna information detailed features description, please refer the manufacturer's specification or user's manual.



6.5. Test Mode Applicability and Tested Channel Detail

- The fundamental of the EUT was investigated in three orthogonal axes X-Y/Y-Z/X-Z, it was determined that X-Y plane was worst-case. Therefore, all final radiated testing was performed with the EUT in X-Y plane.
- For Antenna Port Conducted Measurement, this item includes all test value of each mode, but only includes spectrum plot of worst value of each mode.
- For below 30MHz testing, investigation was done on three antenna orientations (parallel, perpendicular, and ground-parallel), parallel and perpendicular are the worst orientations, therefore testing was performed on these two orientations only.
- For below 1 GHz radiated emission and AC power line conducted emission have performed all modes of operation were investigated and the worst-case emissions are reported.
- Pre-Scan has been conducted to determine the worst-case mode from all possible combinations between available modulations, data rates and antenna ports (if EUT with antenna diversity architecture).

Test Item	Modulation Type	Available Channel	Test Channel	Data Rate
Radiated Emissions	GFSK	1 to 5	1,3,5	SRD
Radiated Emissions (Below 1GHz)	GFSK	1 to 5	5	SRD
AC Power Line Conducted Emission	GFSK	1 to 5	5	SRD
Antenna Port Conducted Measurement	GFSK	1 to 5	1,3,5	SRD

Underwriters Laboratories Taiwan Co., Ltd.

Building B and Building E, No. 372-7, Sec. 4, Zhongxing Rd., Zhudong Township, Hsinchu County, Taiwan

Telephone :+886-2-7737-3000

Facsimile (FAX) :+886-3-583-7948

Doc No: 17-EM-F0876 / 6.0



6.6. Duty cycle

Mode	On Time (ms)	On+Off Time (ms)	Duty Cycle	Duty Factor (dB)	VBW Set (above 1GHz)
SRD	0.185	0.625	0.30	5.29	10kHz

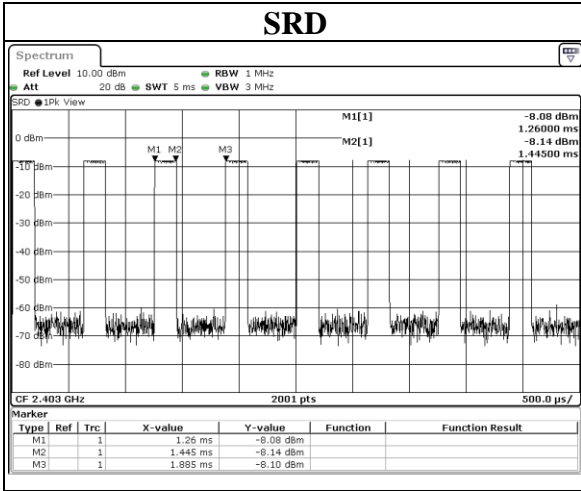

Underwriters Laboratories Taiwan Co., Ltd.

Building B and Building E, No. 372-7, Sec. 4, Zhongxing Rd., Zhudong Township, Hsinchu County, Taiwan

Telephone : +886-2-7737-3000

Facsimile (FAX) : +886-3-583-7948



7. Test Equipment

Test Equipment List					
Equipment	Manufacturer	Model No.	Serial No.	Cal. Date	Expired date
Radiated Spurious Emission					
Spectrum Analyzer	Keysight	N9010A	MY56070827	2021/11/9	2022/11/8
EMI Test Receiver	Rohde & Schwarz	ESR7	101754	2021/12/10	2022/12/9
Loop Antenna	ETS lindgren	6502	00213440	2021/12/23	2022/12/22
Trilog-Broadband Antenna with 5dB Attenuator	Schwarzbeck & EMCI	VULB 9168 & N-6-05	774 & AT-N0538	2022/2/8	2023/2/7
Horn Antenna (1-18 GHz)	Schwarzbeck	BBHA 9120 D	01690	2021/12/13	2022/12/12
Horn Antenna (18-40 GHz)	Schwarzbeck	BBHA 9170	781	2021/12/17	2022/12/16
Preamplifier (30-1000 MHz)	EMCI	EMC330E	980405	2021/6/8	2022/6/7
Preamplifier (1-18 GHz)	EMCI	EMC051835BE	980406	2022/2/16	2023/2/15
Preamplifier (18-40GHz)	EMCI	EMC184040SEE	980426	2021/5/19	2022/5/18
Cables	Hanyitek	K1K50-UP0264-K1K50-2500	170214-4 & 170425-2	2021/12/3	2022/12/2
Cables	Hanyitek	K1K50-UP0264-K1K50-2500	170214-1 & 170214-2	2021/12/3	2022/12/2

Underwriters Laboratories Taiwan Co., Ltd.

Building B and Building E, No. 372-7, Sec. 4, Zhongxing Rd., Zhudong Township, Hsinchu County, Taiwan

Telephone :+886-2-7737-3000

Facsimile (FAX) :+886-3-583-7948

Doc No: 17-EM-F0876 / 6.0



Test report No. : 4790323504B-US-R0-V0
Page : 14 of 43
Issued date : 2022/3/22
FCC ID : RLY21GMD01

Test Equipment List					
Equipment	Manufacturer	Model No.	Serial No.	Cal. Date	Expired date
Antenna Port Conducted Measurement					
Spectrum Analyzer	Rohde & Schwarz	FSV40	101490	2021/9/7	2022/9/6
Pulse Power Sensor	Anritsu	MA2411B	1531202	2021/12/22	2022/12/21
Power Meter	Anritsu	ML2495A	1645002	2021/12/22	2022/12/21
AC power Line Conducted Emission					
EMI Test Receiver	Rohde & Schwarz	ESR7	101753	2021/11/15	2022/11/14
Two-Line V-Network	Rohde & Schwarz	ENV216	102136	2021/8/30	2022/8/29
Impuls-Begrenzer Pulse Limiter	Rohde & Schwarz	ESH3-Z2	102219-Qt	2021/8/26	2022/8/25
Cables	TITAN	CFD200	T0732ACFD20 020A300-2	2021/4/7	2022/4/6

UL Software		
Description	Name	Version
Radiated measurement	e3	6.191211 (V6)
Conducted measurement	RF Conducted Test Tools	ver 2.4.0.620b
AC power Line Conducted Emission	EZ_EMG	UL-3A1.2

Underwriters Laboratories Taiwan Co., Ltd.

Building B and Building E, No. 372-7, Sec. 4, Zhongxing Rd., Zhudong Township, Hsinchu County, Taiwan

Telephone :+886-2-7737-3000

Facsimile (FAX) :+886-3-583-7948

Doc No: 17-EM-F0876 / 6.0



Test report No. : 4790323504B-US-R0-V0
Page : 15 of 43
Issued date : 2022/3/22
FCC ID : RLY21GMD01

8. Description of Test Setup

Support Equipment

ID	Equipment	Brand Name	Model Name	S/N	Remark
A	Laptop	Lenovo	T460	PC0FWU5Y	Provide by lab

I/O Cables

ID	Equipment	Brand Name	Model Name	Length (m)	Remark
1	USB Cable	fujiei	Z08145	1	Provide by lab

Underwriters Laboratories Taiwan Co., Ltd.

Building B and Building E, No. 372-7, Sec. 4, Zhongxing Rd., Zhudong Township, Hsinchu County, Taiwan

Telephone :+886-2-7737-3000

Facsimile (FAX) :+886-3-583-7948

Doc No: 17-EM-F0876 / 6.0



Test Setup

Controlled using a bespoke application (Bus Hound 6.01) on a test Notebook. The application was used to enable a continuous transmission mode and to select the test channels, data rates, modulation schemes and power setting as required.

Setup Diagram for Test

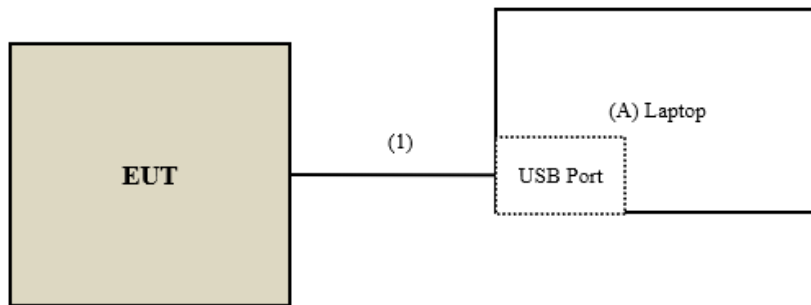

Under Table

Remote Site

Underwriters Laboratories Taiwan Co., Ltd.

Building B and Building E, No. 372-7, Sec. 4, Zhongxing Rd., Zhudong Township, Hsinchu County, Taiwan

Telephone :+886-2-7737-3000

Facsimile (FAX) :+886-3-583-7948

Doc No: 17-EM-F0876 / 6.0



9. Test Results

9.1. 6dB Bandwidth

Requirements

The minimum 6 dB bandwidth shall be at least 500 kHz.

Test procedure

- Set resolution bandwidth (RBW) = 100kHz
- Set the video bandwidth (VBW) $\geq 3 \times$ RBW, Detector = Peak.
- Trace mode = max hold.
- Sweep = auto couple.
- Measure the maximum width of the emission that is constrained by the frequencies associated with the two amplitude points (upper and lower) that are attenuated by 6 dB relative to the maximum level measured in the fundamental emission.

Test Setup

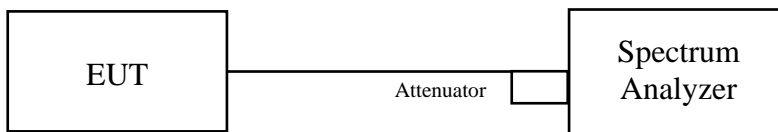

The loss between RF output port of the EUT and the input port of the Spectrum Analyzer has been taken into consideration.

Underwriters Laboratories Taiwan Co., Ltd.

Building B and Building E, No. 372-7, Sec. 4, Zhongxing Rd., Zhudong Township, Hsinchu County, Taiwan

Telephone :+886-2-7737-3000

Facsimile (FAX) :+886-3-583-7948

Doc No: 17-EM-F0876 / 6.0



Test Data

Mode	CH	Freq (MHz)	6dB BW (MHz)	Limit (MHz)	Result
SRD	1	2403	0.629	0.5	Pass
SRD	3	2440	0.625	0.5	Pass
SRD	5	2475	0.632	0.5	Pass

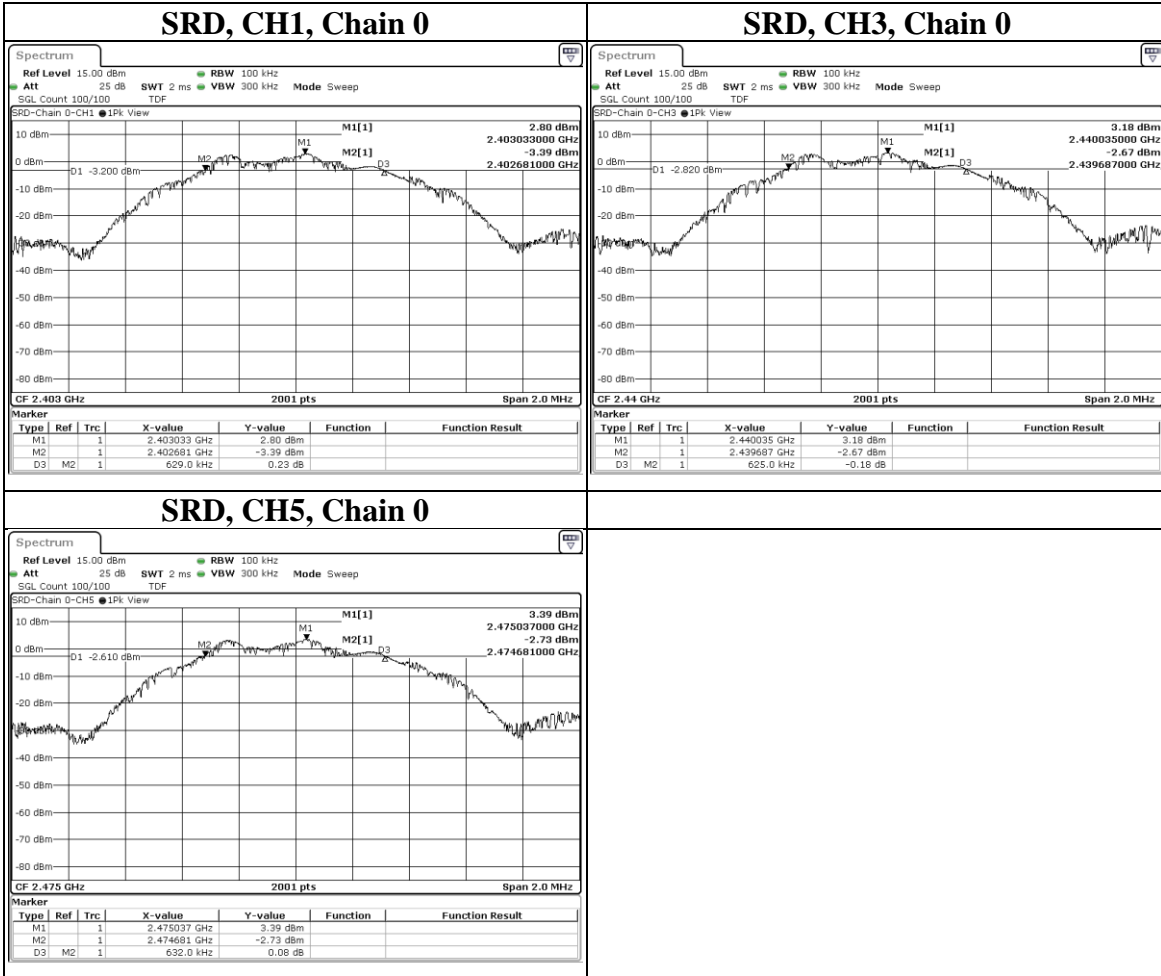

Underwriters Laboratories Taiwan Co., Ltd.

Building B and Building E, No. 372-7, Sec. 4, Zhongxing Rd., Zhudong Township, Hsinchu County, Taiwan

Telephone : +886-2-7737-3000

Facsimile (FAX) : +886-3-583-7948

Doc No: 17-EM-F0876 / 6.0



9.2. Conducted Output Power

Requirements

For systems using digital modulation in the 2400-2483.5 MHz bands: 1 Watt.

Test Procedure

A peak power sensor was used on the output port of the EUT. A power meter was used to read the response of the peak power sensor. Record the power level.

Test Setup

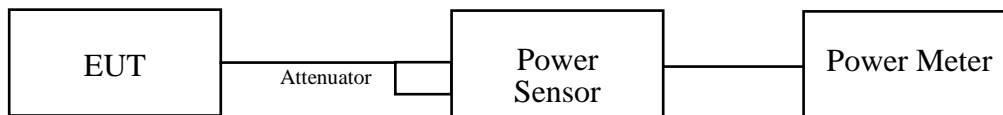

The loss between RF output port of the EUT and the input port of the Power Meter has been taken into consideration.



Test Data

Peak Power

Channel	Frequency (MHz)	Peak Power (mW)	Peak Power (dBm)	Limit (dBm)	Pass/Fail
1	2403	2.323	3.66	30	PASS
3	2440	2.489	3.96	30	PASS
5	2475	2.6	4.15	30	PASS

Average Power (Reference Only)

Channel	Frequency (MHz)	Average Power (mW)	Average Power (dBm)
1	2403	2.286	3.59
3	2440	2.449	3.89
5	2475	2.559	4.08

Underwriters Laboratories Taiwan Co., Ltd.

Building B and Building E, No. 372-7, Sec. 4, Zhongxing Rd., Zhudong Township, Hsinchu County, Taiwan

Telephone :+886-2-7737-3000

Facsimile (FAX) :+886-3-583-7948

Doc No: 17-EM-F0876 / 6.0



9.3. Power Spectral Density

Requirements

The Maximum of Power Spectral Density Measurement is 8dBm in any 3 kHz.

Test procedure

- a. Set analyzer center frequency to DTS channel center frequency.
- b. Set the span to 1.5 times the DTS bandwidth.
- c. Set the RBW to: $3 \text{ kHz} \leq \text{RBW} \leq 100 \text{ kHz}$.
- d. Set the VBW $\geq 3 \times \text{RBW}$.
- e. Detector = peak.
- f. Sweep time = auto couple.
- g. Trace mode = max hold.
- h. Allow trace to fully stabilize.
- i. Use the peak marker function to determine the maximum amplitude level within the RBW.

Test Setup

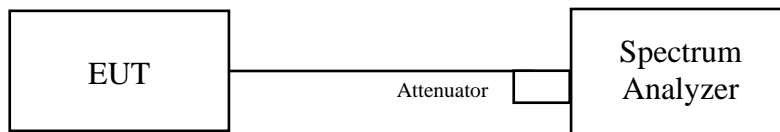

The loss between RF output port of the EUT and the input port of the Spectrum Analyzer has been taken into consideration.

Underwriters Laboratories Taiwan Co., Ltd.

Building B and Building E, No. 372-7, Sec. 4, Zhongxing Rd., Zhudong Township, Hsinchu County, Taiwan

Telephone :+886-2-7737-3000

Facsimile (FAX) :+886-3-583-7948

Doc No: 17-EM-F0876 / 6.0



Test Data

Mode	CH	Freq (MHz)	PSD (dBm/3kHz)	Limit (dBm/3kHz)	Result
SRD	1	2403	-7.33	8	Pass
SRD	3	2440	-6.88	8	Pass
SRD	5	2475	-7.03	8	Pass

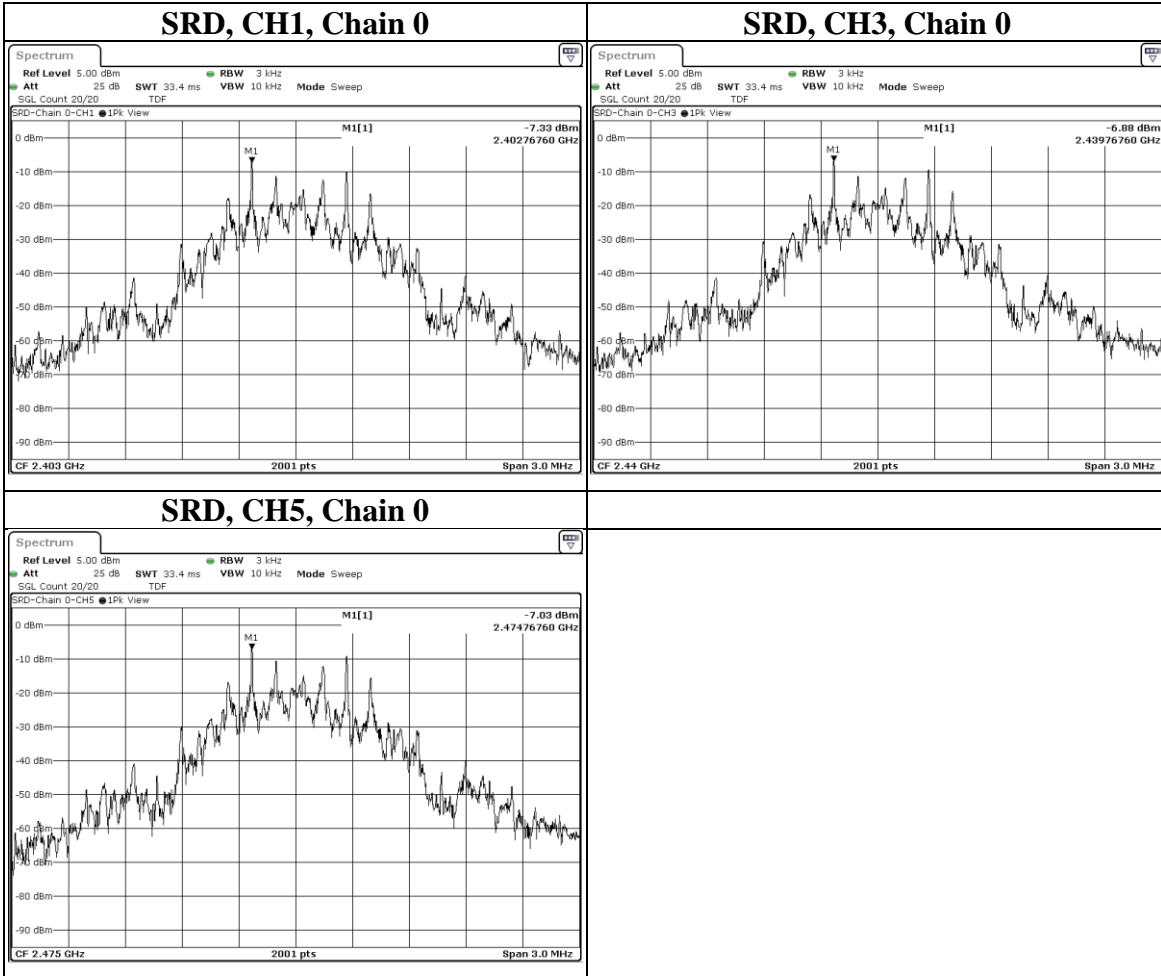

Underwriters Laboratories Taiwan Co., Ltd.

Building B and Building E, No. 372-7, Sec. 4, Zhongxing Rd., Zhudong Township, Hsinchu County, Taiwan

Telephone : +886-2-7737-3000

Facsimile (FAX) : +886-3-583-7948



9.4. Conducted Out of Band Emission

Requirements

In any 100 kHz bandwidth outside the frequency band in which the spread spectrum or digitally modulated intentional radiator is operating, the radio frequency power that is produced by the intentional radiator shall be at least 20 dB below that in the 100 kHz bandwidth within the band that contains the highest level of the desired power, based on either an RF conducted or a radiated measurement, provided the transmitter demonstrates compliance with the peak conducted power limits. If the transmitter complies with the conducted power limits based on the use of RMS averaging over a time interval, as permitted under paragraph (b) (3) of this section, the attenuation required under this paragraph shall be 30 dB instead of 20 dB. Attenuation below the general limits specified in §15.209 (a) is not required.

Test procedure

Measurement Procedure REF

- Set the RBW = 100 kHz.
- Set the VBW \geq 300 kHz.
- Set the span to 1.5 times the DTS bandwidth.
- Detector = peak.
- Sweep time = auto couple.
- Trace mode = max hold.
- Allow trace to fully stabilize.
- Use the peak marker function to determine the maximum power level in any 100 kHz band segment within the fundamental EBW.

Measurement Procedure OOBE

- Set RBW = 100 kHz.
- Set VBW \geq 300 kHz.
- Detector = peak.
- Sweep = auto couple.
- Trace Mode = max hold.
- Allow trace to fully stabilize.
- Use the peak marker function to determine the maximum amplitude level.

Test Setup

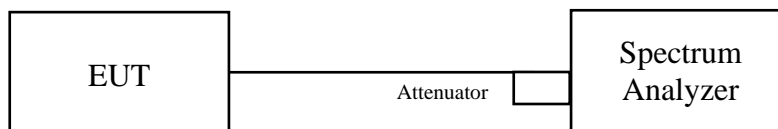

The loss between RF output port of the EUT and the input port of the Spectrum Analyzer has been taken into consideration.

Underwriters Laboratories Taiwan Co., Ltd.

Building B and Building E, No. 372-7, Sec. 4, Zhongxing Rd., Zhudong Township, Hsinchu County, Taiwan
Telephone : +886-2-7737-3000
Facsimile (FAX) : +886-3-583-7948



Test Data

SRD, CH1, Chain 0, Reference

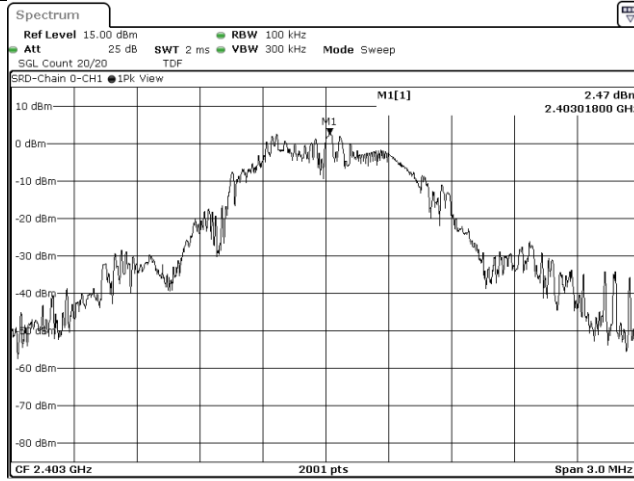

SRD, CH1, Chain 0, Conducted Emission

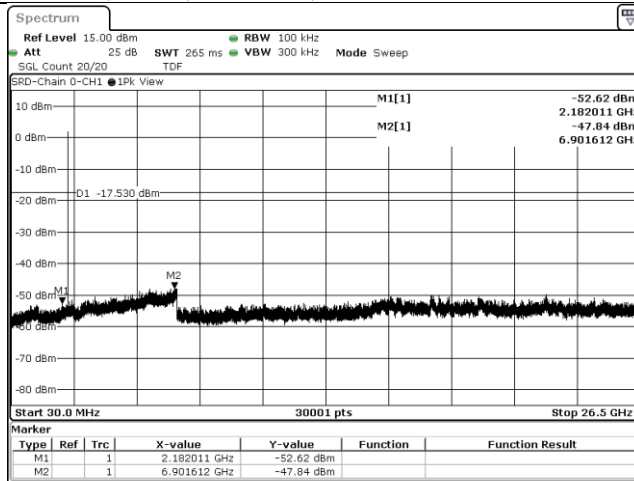

SRD, CH1, Chain 0, Bandedge

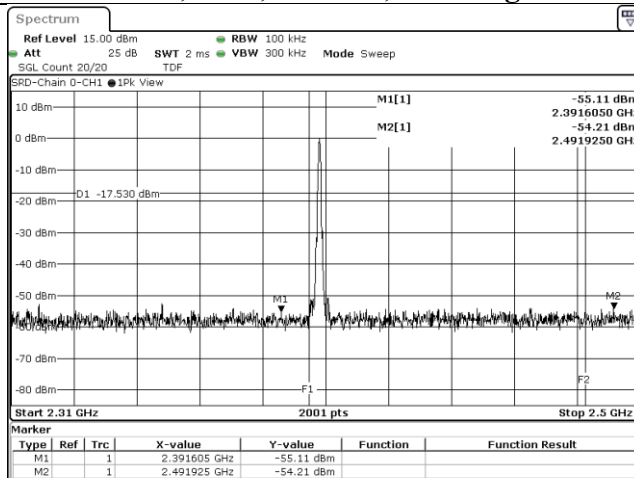

Underwriters Laboratories Taiwan Co., Ltd.

Building B and Building E, No. 372-7, Sec. 4, Zhongxing Rd., Zhudong Township, Hsinchu County, Taiwan

Telephone : +886-2-7737-3000

Facsimile (FAX) : +886-3-583-7948



SRD, CH3, Chain 0, Reference

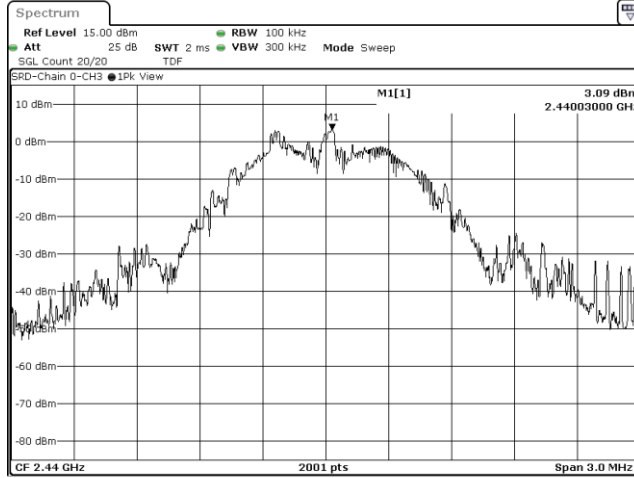

SRD, CH3, Chain 0, Conducted Emission

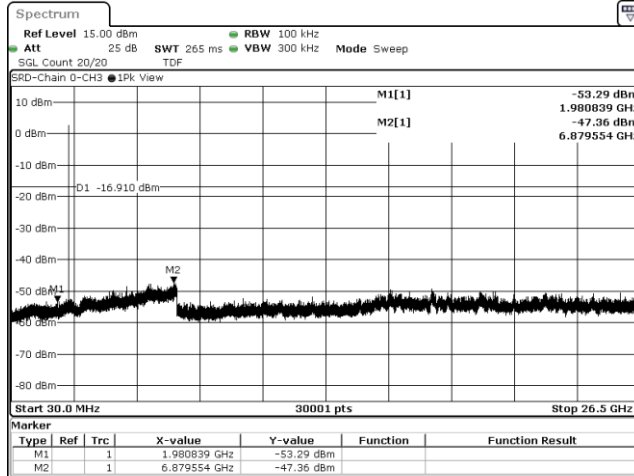

SRD, CH3, Chain 0, Bandedge

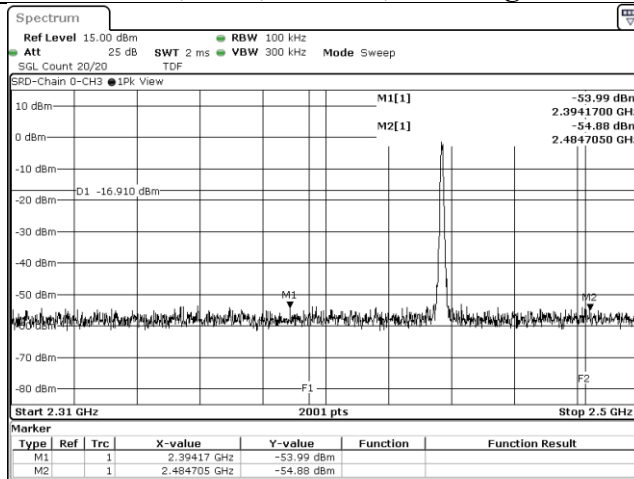

Underwriters Laboratories Taiwan Co., Ltd.

Building B and Building E, No. 372-7, Sec. 4, Zhongxing Rd., Zhudong Township, Hsinchu County, Taiwan

Telephone : +886-2-7737-3000

Facsimile (FAX) : +886-3-583-7948



SRD, CH5, Chain 0, Reference

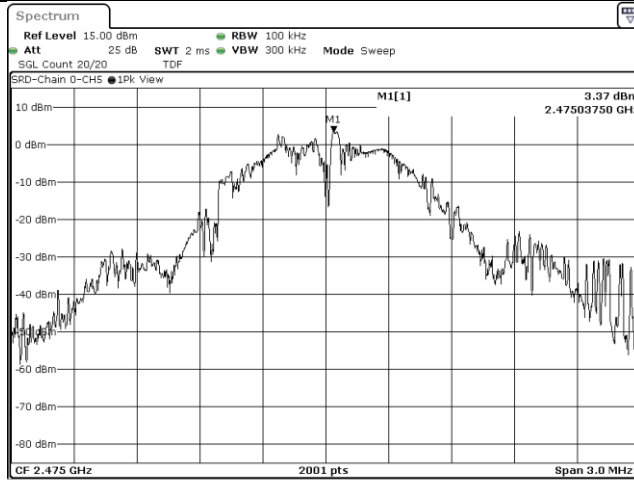

SRD, CH5, Chain 0, Conducted Emission

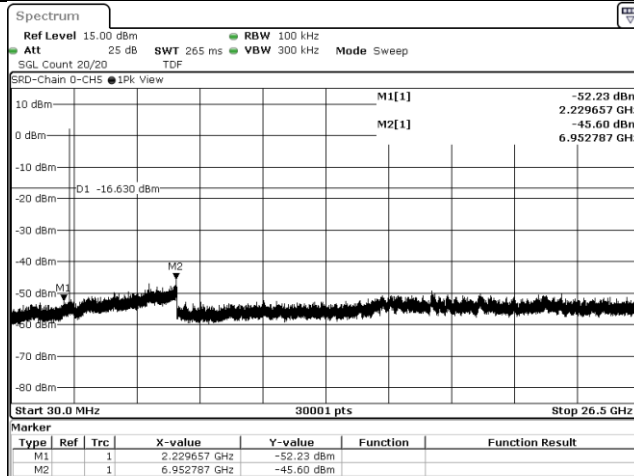

SRD, CH5, Chain 0, Bandedge

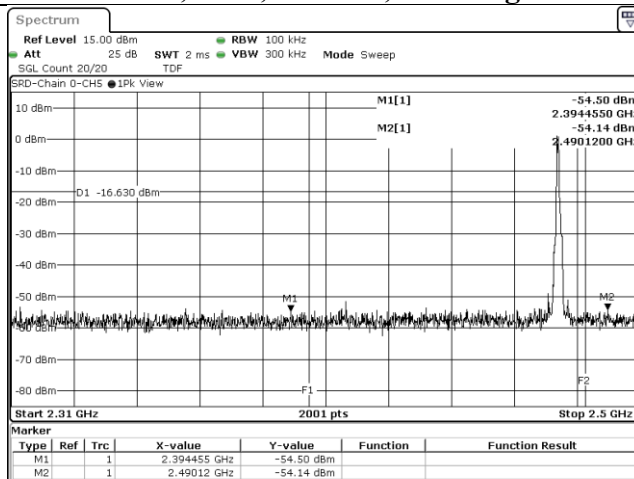

Underwriters Laboratories Taiwan Co., Ltd.

Building B and Building E, No. 372-7, Sec. 4, Zhongxing Rd., Zhudong Township, Hsinchu County, Taiwan

Telephone : +886-2-7737-3000

Facsimile (FAX) : +886-3-583-7948



9.5. Radiated Spurious Emission

Requirements

Radiated emissions which fall in the restricted bands must comply with the radiated emission limits specified as below table. Other emissions shall be at least 20dB below the highest level of the desired power:

Frequency(MHz)	Field strength (microvolts/meter)	Measurement distance (meters)
0.009-0.490	2400/F(kHz)	300
0.490-1.705	24000/F(kHz)	30
1.705-30.0	30	30
30-88	100	3
88-216	150	3
216-960	200	3
Above 960	500	3

NOTE:

1. The lower limit shall apply at the transition frequencies.
2. Emission level (dBuV/m) = 20 log Emission level (uV/m).
3. For frequencies above 1000MHz, the field strength limits are based on average detector, however, the peak field strength of any emission shall not exceed the maximum permitted average limits, specified above by more than 20dB under any condition of modulation.

Underwriters Laboratories Taiwan Co., Ltd.

Building B and Building E, No. 372-7, Sec. 4, Zhongxing Rd., Zhudong Township, Hsinchu County, Taiwan

Telephone :+886-2-7737-3000

Facsimile (FAX) :+886-3-583-7948

Doc No: 17-EM-F0876 / 6.0



Test Procedures

[For 9 kHz ~ 30 MHz]

- a. The EUT was placed on the top of a rotating table 0.8 meters above the ground at a 3 meter chamber room. The table was rotated 360 degrees to determine the position of the highest radiation.
- b. The EUT was set 3 meters away from the interference-receiving antenna, which was mounted on the top of a variable-height antenna tower.
- c. Parallel, perpendicular, and ground-parallel orientations of the antenna are set to make the measurement.
- d. For each suspected emission, the EUT was arranged to its worst case and the rotatable table was turned from 0 degrees to 360 degrees to find the maximum reading.
- e. For measurement below 30MHz, the initial step in collecting conducted emission data is a spectrum analyzer peak detector mode pre-scanning the measurement frequency range. Significant peaks are then marked and then Quasi Peak detector mode re-measured. If the emission level of the EUT measured by the peak detector is lower than the applicable limit, the peak emission level will be reported. Otherwise, the emission measurement will be repeated using the quasi-peak detector and reported.

NOTE:

1. The resolution bandwidth and video bandwidth of test receiver/spectrum analyzer is 9kHz at frequency below 30MHz.

[For above 30 MHz]

- a. The EUT was placed on the top of a rotating table 0.8 meters (for 30MHz ~ 1GHz) / 1.5 meters (for above 1GHz) above the ground at 3 meter chamber room for test. The table was rotated 360 degrees to determine the position of the highest radiation.
- b. The EUT was set 3 meters away from the interference-receiving antenna, which was mounted on the top of a variable-height antenna tower.
- c. The height of antenna is varied from one meter to four meters above the ground to determine the maximum value of the field strength. Both horizontal and vertical polarizations of the antenna are set to make the measurement.
- d. For each suspected emission, the EUT was arranged to its worst case and then the antenna was tuned to heights from 1 meter to 4 meters and the rotatable table was turned from 0 degrees to 360 degrees to find the maximum reading.
- e. For measurement below 1GHz, the initial step in collecting conducted emission data is a spectrum analyzer peak detector mode pre-scanning the measurement frequency range. Significant peaks are then marked and then Quasi Peak detector mode re-measured. If the emission level of the EUT measured by the peak detector is lower than the applicable limit, the peak emission level will be reported. Otherwise, the emission measurement will be repeated using the quasi-peak detector and reported.
- f. The test-receiver system was set to peak and average detects function and specified bandwidth with maximum hold mode when the test frequency is above 1 GHz. If the peak reading value also meets average limit, measurement with the average detector is unnecessary.

Underwriters Laboratories Taiwan Co., Ltd.

Building B and Building E, No. 372-7, Sec. 4, Zhongxing Rd., Zhudong Township, Hsinchu County, Taiwan

Telephone :+886-2-7737-3000

Facsimile (FAX) :+886-3-583-7948

Doc No: 17-EM-F0876 / 6.0



Note:

- a. The resolution bandwidth and video bandwidth of test receiver/spectrum analyzer is 120kHz for Quasi-peak detection (QP) at frequency below 1GHz.
- b. The resolution bandwidth of test receiver/spectrum analyzer is 1 MHz and the video bandwidth is 3 MHz for Peak detection (PK) at frequency above 1GHz.
- c. The resolution bandwidth of test receiver/spectrum analyzer is 1MHz and the video bandwidth is $\geq 1/T$ (Duty cycle $< 98\%$) or 10Hz (Duty cycle $\geq 98\%$) for Average detection (AV) at frequency above 1GHz.

Configuration	Average	
	RBW	VBW
SRD	1MHz	Refer to section 6.6 for duty cycle.

- d. All modes of operation were investigated (includes all external accessories) and the worst-case emissions are reported, the other emission levels were low against the limit.
- e. Test data of Result value (dBuV/m) = Reading value (dBuV/m) + Correction Factor (dB/m).
- f. Test data of Margin(dB) = Result value (dBuV/m) - Limit value (dBuV/m).
- g. Test data of Correction Factor (dB/m) = Antenna Factor (dBuV/m) + Cable Loss (dB) - Preamp Factor (dB).
- h. Test data of Notation "@" = Fundamental Frequency
- i. Test data of Notation "*" = The peak result under 20 dB above and complies with AVG limit, AVG result is deemed to comply with AVG limit.

Underwriters Laboratories Taiwan Co., Ltd.

Building B and Building E, No. 372-7, Sec. 4, Zhongxing Rd., Zhudong Township, Hsinchu County, Taiwan

Telephone :+886-2-7737-3000

Facsimile (FAX) :+886-3-583-7948

Doc No: 17-EM-F0876 / 6.0

Test Setup

<Frequency Range 9 kHz ~ 30 MHz>

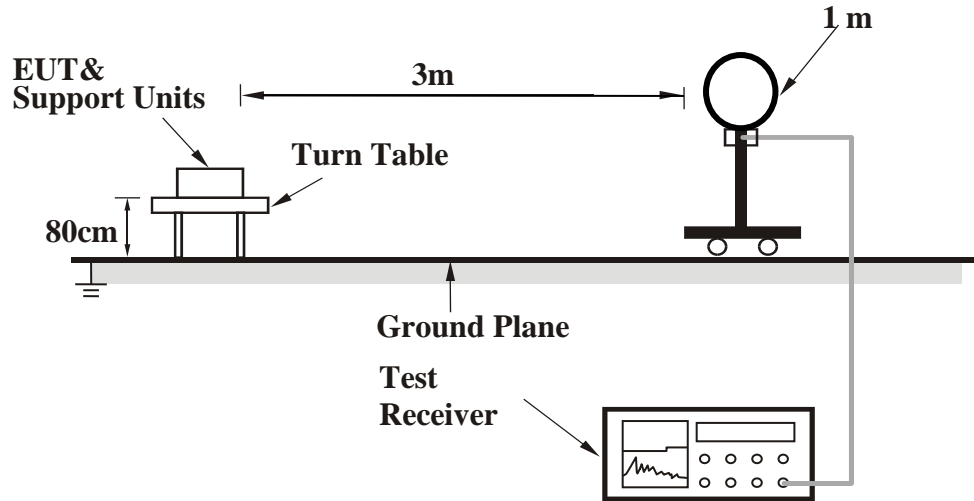

<Frequency Range 30 MHz ~ 1 GHz >

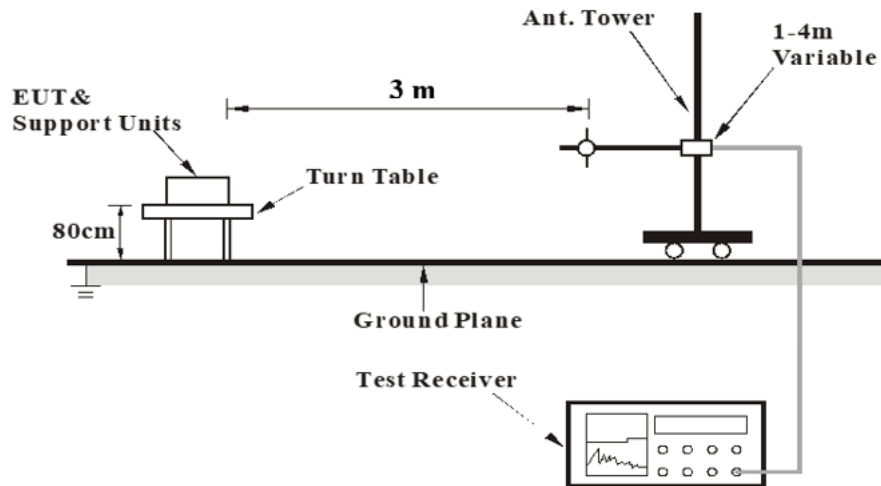



<Frequency Range above 1 GHz>

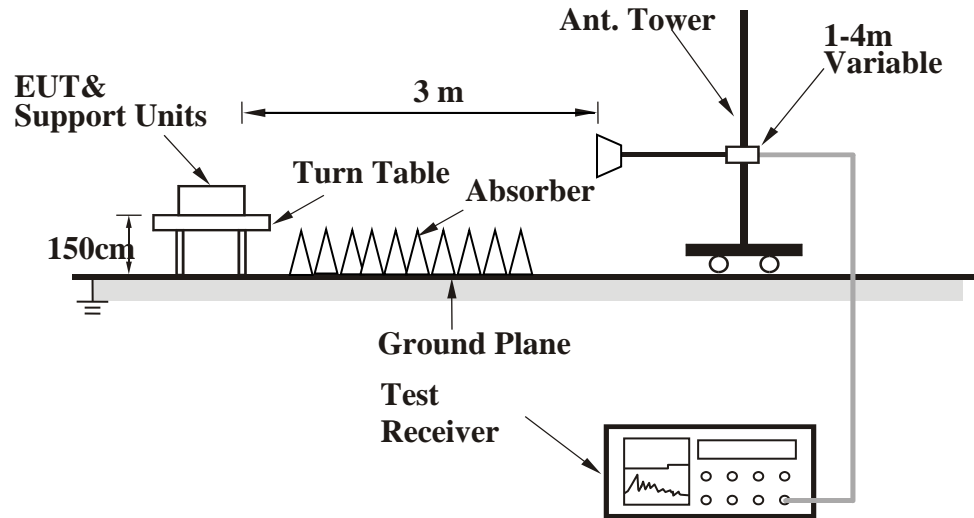

For the actual test configuration, please refer to the Setup Configurations.

Underwriters Laboratories Taiwan Co., Ltd.

Building B and Building E, No. 372-7, Sec. 4, Zhongxing Rd., Zhudong Township, Hsinchu County, Taiwan

Telephone : +886-2-7737-3000

Facsimile (FAX) : +886-3-583-7948

Doc No: 17-EM-F0876 / 6.0



Test Data

Above 1 GHz

Mode	SRD	Channel	1
------	-----	---------	---

Polarization	Notation	Frequency	Reading	Correct	Result	Limit	Margin	Remark
		(MHz)	(dBuV)	(dB/m)	(dBuV/m)	(dBuV/m)	(dB)	
Horizontal		2334.13	41.19	15.88	57.07	74	-16.93	PK
		2365.1	31.02	15.87	46.89	54	-7.11	AVG
	@	2403	78.83	15.81	94.64	N/A	N/A	PK
	@	2403	77.96	15.81	93.77	N/A	N/A	AVG
	*	4806	41.52	2.33	43.85	74	-30.15	PK
Vertical		2345.91	40.77	15.9	56.67	74	-17.33	PK
		2351.61	30.5	15.9	46.4	54	-7.6	AVG
	@	2403	70.65	15.81	86.46	N/A	N/A	AVG
	@	2403	71.62	15.81	87.43	N/A	N/A	PK
	*	4806	36.76	2.33	39.09	74	-34.91	PK

Underwriters Laboratories Taiwan Co., Ltd.

Building B and Building E, No. 372-7, Sec. 4, Zhongxing Rd., Zhudong Township, Hsinchu County, Taiwan

Telephone :+886-2-7737-3000

Facsimile (FAX) :+886-3-583-7948

Doc No: 17-EM-F0876 / 6.0

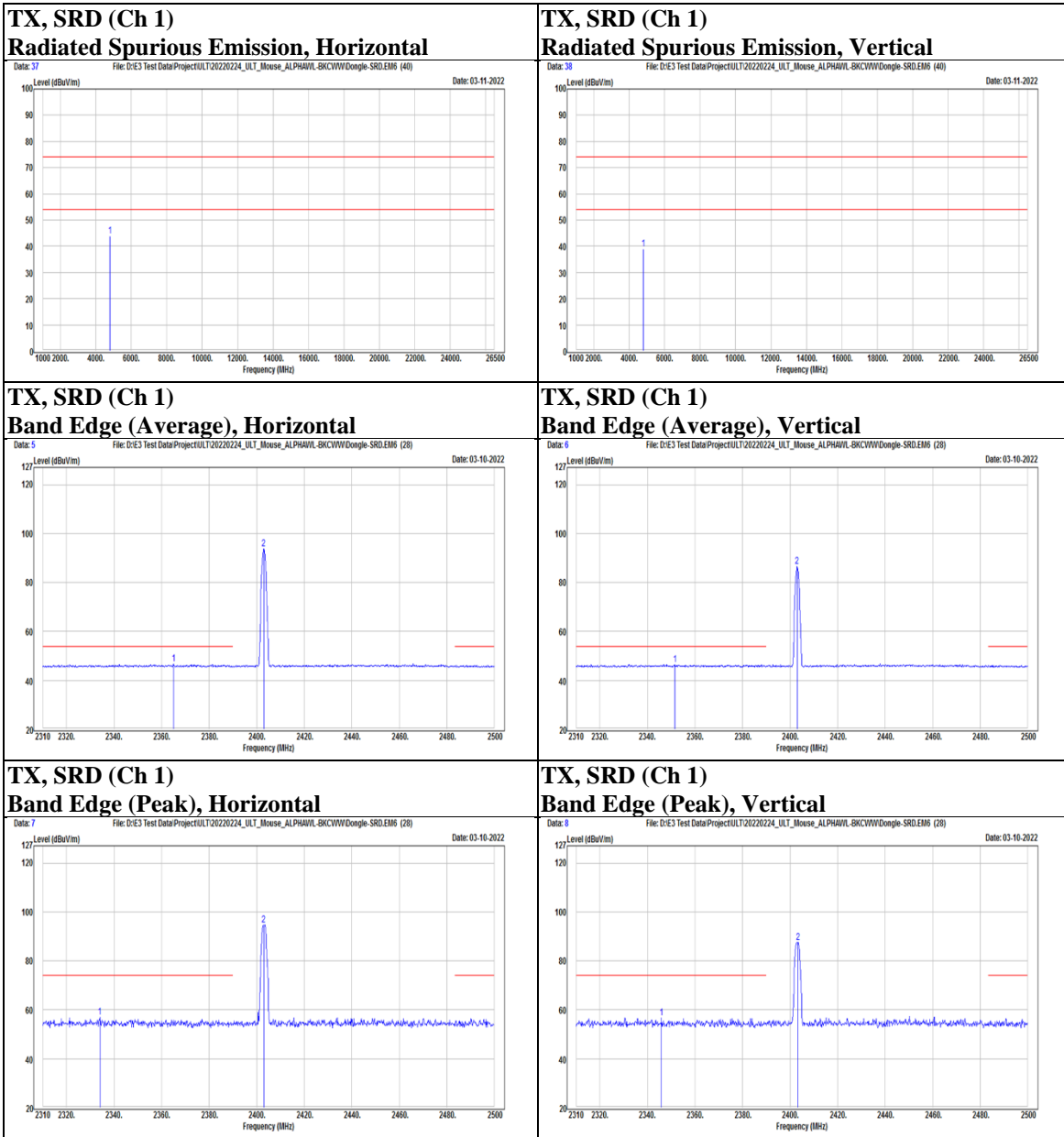

Underwriters Laboratories Taiwan Co., Ltd.

Building B and Building E, No. 372-7, Sec. 4, Zhongxing Rd., Zhudong Township, Hsinchu County, Taiwan

Telephone : +886-2-7737-3000

Facsimile (FAX) : +886-3-583-7948



Test report No. : 4790323504B-US-R0-V0
Page : 34 of 43
Issued date : 2022/3/22
FCC ID : RLY21GMD01

Mode	SRD	Channel	3
------	-----	---------	---

Polarization	Notation	Frequency	Reading	Correct	Result	Limit	Margin	Remark
		(MHz)	(dBuV)	(dB/m)	(dBuV/m)	(dBuV/m)	(dB)	
Horizontal		2310.19	40.94	15.84	56.78	74	-17.22	PK
		2337.55	30.72	15.89	46.61	54	-7.39	AVG
	@	2440	79.87	15.94	95.81	N/A	N/A	PK
	@	2440	78.35	15.94	94.29	N/A	N/A	AVG
		2483.66	30.42	15.68	46.1	54	-7.9	AVG
		2497.53	40.71	15.57	56.28	74	-17.72	PK
	*	4880	43.19	2.41	45.6	74	-28.4	PK
Vertical		2343.63	30.57	15.9	46.47	54	-7.53	AVG
		2346.1	40.66	15.9	56.56	74	-17.44	PK
	@	2440	72.05	15.94	87.99	N/A	N/A	PK
	@	2440	71.3	15.94	87.24	N/A	N/A	AVG
		2497.91	41.01	15.57	56.58	74	-17.42	PK
		2498.29	30.83	15.57	46.4	54	-7.6	AVG
	*	4880	36.89	2.41	39.3	74	-34.7	PK

Underwriters Laboratories Taiwan Co., Ltd.

Building B and Building E, No. 372-7, Sec. 4, Zhongxing Rd., Zhudong Township, Hsinchu County, Taiwan

Telephone :+886-2-7737-3000

Facsimile (FAX) :+886-3-583-7948

Doc No: 17-EM-F0876 / 6.0

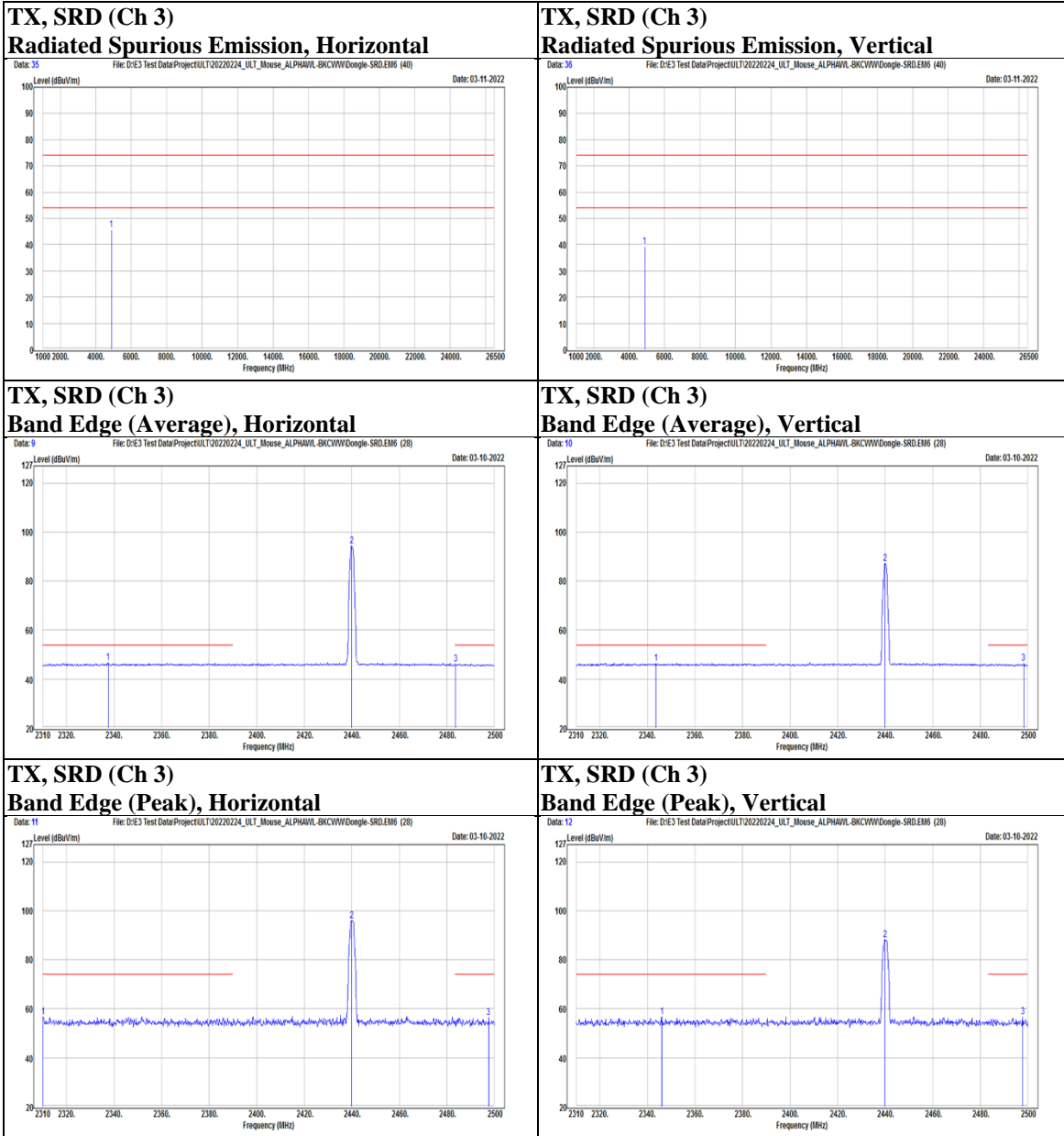



Test report No. : 4790323504B-US-R0-V0
Page : 36 of 43
Issued date : 2022/3/22
FCC ID : RLY21GMD01

Mode	SRD	Channel	5
------	-----	---------	---

Polarization	Notation	Frequency	Reading	Correct	Result	Limit	Margin	Remark
		(MHz)	(dBuV)	(dB/m)	(dBuV/m)	(dBuV/m)	(dB)	
Horizontal		2357.5	30.6	15.89	46.49	54	-7.51	AVG
	@	2475	79.62	15.76	95.38	N/A	N/A	PK
	@	2475	79.77	15.76	95.53	N/A	N/A	AVG
		2492.59	40.7	15.61	56.31	74	-17.69	PK
		2495.82	30.62	15.58	46.2	54	-7.8	AVG
	*	4950	43.31	2.38	45.69	74	-28.31	PK
Vertical		2359.4	30.63	15.88	46.51	54	-7.49	AVG
	@	2475	72.46	15.76	88.22	N/A	N/A	PK
	@	2475	72.07	15.76	87.83	N/A	N/A	AVG
		2487.84	30.64	15.65	46.29	54	-7.71	AVG
		2496.96	40.15	15.57	55.72	74	-18.28	PK
	*	4950	38.07	2.38	40.45	74	-33.55	PK

Underwriters Laboratories Taiwan Co., Ltd.

Building B and Building E, No. 372-7, Sec. 4, Zhongxing Rd., Zhudong Township, Hsinchu County, Taiwan

Telephone :+886-2-7737-3000

Facsimile (FAX) :+886-3-583-7948

Doc No: 17-EM-F0876 / 6.0

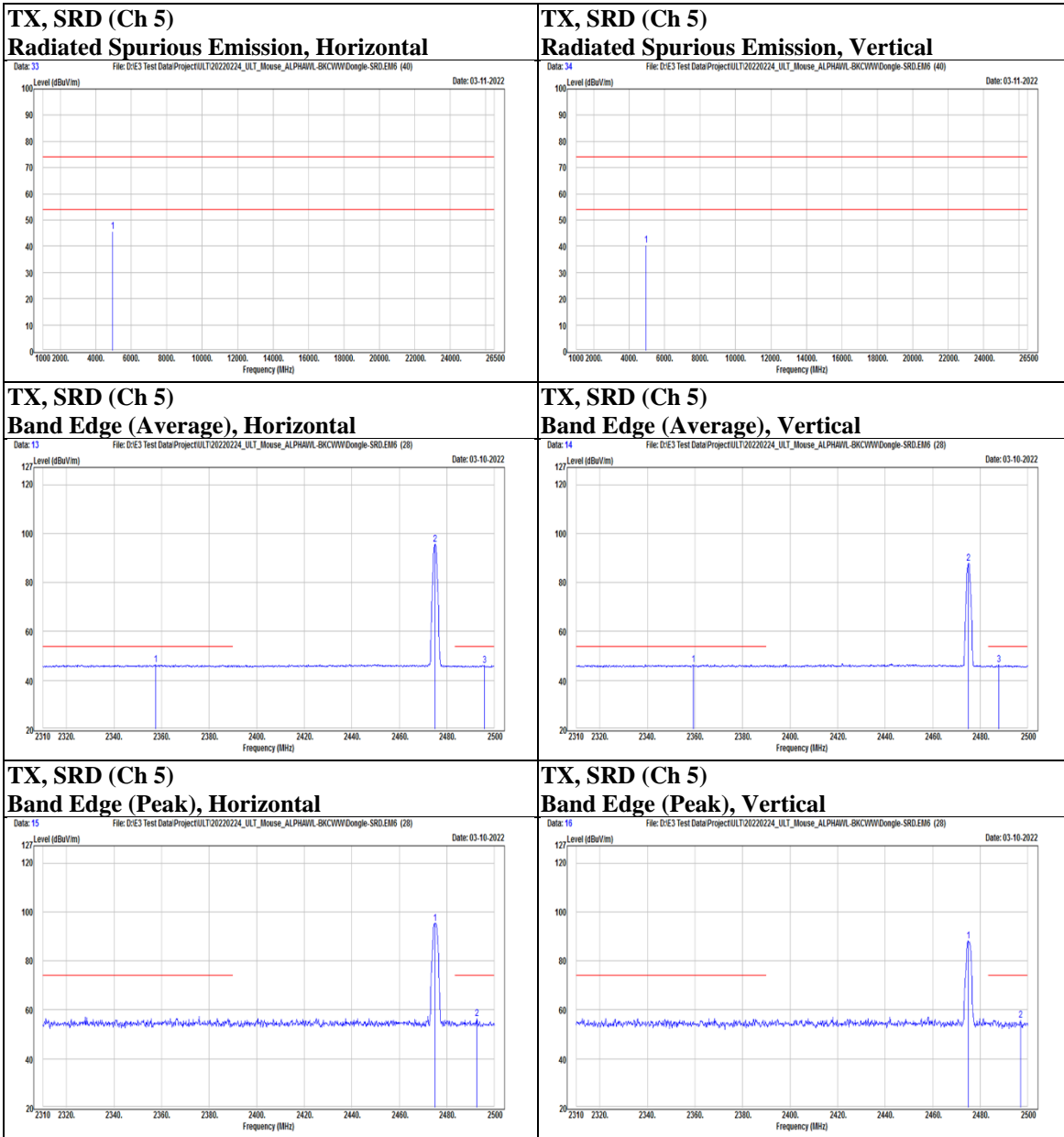



Below 1 GHz

Mode	SRD	Channel	5
------	-----	---------	---

Polarization	Notation	Frequency	Reading	Correct	Result	Limit	Margin	Remark
		(MHz)	(dBuV)	(dB/m)	(dBuV/m)	(dBuV/m)	(dB)	
Horizontal		84.32	41.08	-17.33	23.75	40	-16.25	PK
		162.89	41.36	-11.1	30.26	43.5	-13.24	PK
		204.6	44.58	-14	30.58	43.5	-12.92	PK
		296.75	35.06	-10.13	24.93	46	-21.07	PK
		336.52	34.95	-8.84	26.11	46	-19.89	PK
		480.08	32.93	-5.26	27.67	46	-18.33	PK
Vertical		78.5	37.74	-16.03	21.71	40	-18.29	PK
		162.89	41.12	-11.1	30.02	43.5	-13.48	PK
		296.75	35.08	-10.13	24.95	46	-21.05	PK
		359.8	34.02	-8.3	25.72	46	-20.28	PK
		427.7	32.61	-6.32	26.29	46	-19.71	PK
		520.82	32.37	-4.1	28.27	46	-17.73	PK

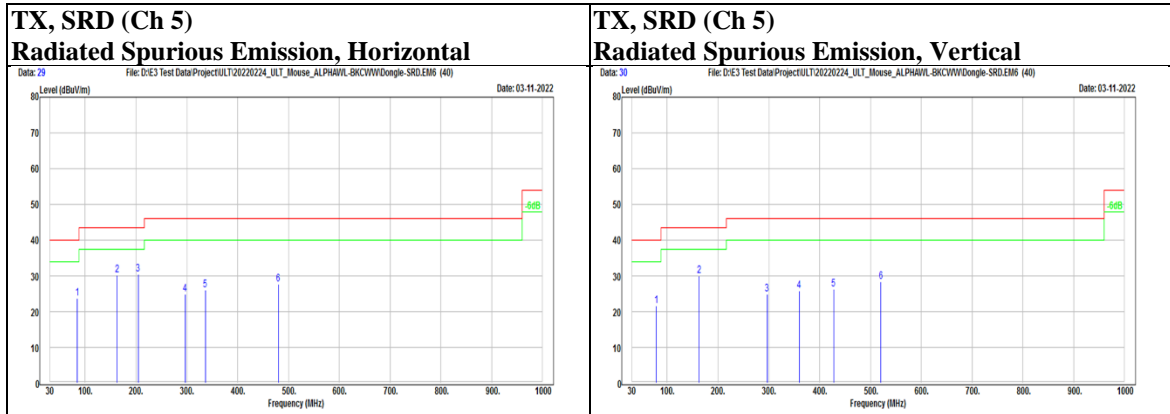

Underwriters Laboratories Taiwan Co., Ltd.

Building B and Building E, No. 372-7, Sec. 4, Zhongxing Rd., Zhudong Township, Hsinchu County, Taiwan

Telephone : +886-2-7737-3000

Facsimile (FAX) : +886-3-583-7948



9 kHz ~ 30 MHz Data:

For 9 kHz to 30 MHz radiated emission have performed all modes of operation were investigated. The amplitude of spurious emissions attenuated more than 20 dB below the permissible value is not required to be report.

No non-compliance noted:

KDB 414788 D01 OATS and Chamber Correlation Justification

- Base on FCC 15.31 (f) (2): measurements may be performed at a distance closer than that specified in the regulations; however, an attempt should be made to avoid making measurements in the near field.

- OATs and chamber correlation testing had been performed and chamber measured test results is the worst case test result.

Although these tests were performed other than open area test site, adequate comparison measurements were confirmed against 30m open area test site. Therefore sufficient tests were made to demonstrate that the alternative site produces results that correlate with the ones of tests made in an open field based on KDB 414788.

Underwriters Laboratories Taiwan Co., Ltd.

Building B and Building E, No. 372-7, Sec. 4, Zhongxing Rd., Zhudong Township, Hsinchu County, Taiwan

Telephone :+886-2-7737-3000

Facsimile (FAX) :+886-3-583-7948

Doc No: 17-EM-F0876 / 6.0



9.6. AC Power Line Conducted Emission

Requirements

Frequency (MHz)	Conducted limit (dB μ V)	
	Quasi-peak	Average
0.15 - 0.5	66 - 56	56 - 46
0.50 - 5.0	56	46
5.0 - 30	60	50

Note:

1. The lower limit shall apply at the transition frequencies.
2. The limit decreases in line with the logarithm of the frequency in the range of 0.15 to 0.50MHz.

Test Procedures

- a. The EUT was placed 0.4 meters from the conducting wall of the shielded room with EUT being connected to the power mains through a line impedance stabilization network (LISN). Other support units were connected to the power mains through another LISN. The two LISNs provide 50 ohm/ 50uH of coupling impedance for the measuring instrument.
- b. Both lines of the power mains connected to the EUT were checked for maximum conducted interference.
- c. The frequency range from 150kHz to 30MHz was searched. Emission levels under (Limit - 20dB) was not recorded.

NOTE:

1. The resolution bandwidth and video bandwidth of test receiver is 9kHz for quasi-peak detection (QP) and average detection (AV) at frequency 0.15MHz-30MHz.
2. All modes of operation were investigated (includes all external accessories) and the worst-case emissions are reported, the other emission levels were low against the limit.
3. Test data of Result value (dBuV) = Reading value (dBuV) + Correction Factor (dB).
4. Test data of Margin(dB) = Result value (dBuV) - Limit value (dBuV).
5. Test data of Correction Factor (dB) = Insertion loss(dB) + Cable loss(dB).

Underwriters Laboratories Taiwan Co., Ltd.

Building B and Building E, No. 372-7, Sec. 4, Zhongxing Rd., Zhudong Township, Hsinchu County, Taiwan

Telephone :+886-2-7737-3000

Facsimile (FAX) :+886-3-583-7948

Doc No: 17-EM-F0876 / 6.0



Test Setup

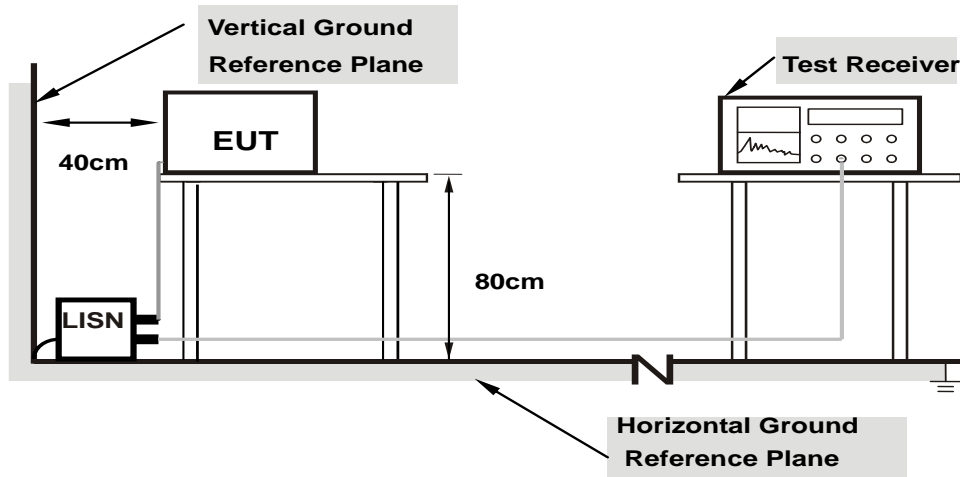

Note: 1.Support units were connected to second LISN.

For the actual test configuration, please refer to the Setup Configurations.

Underwriters Laboratories Taiwan Co., Ltd.

Building B and Building E, No. 372-7, Sec. 4, Zhongxing Rd., Zhudong Township, Hsinchu County, Taiwan

Telephone :+886-2-7737-3000

Facsimile (FAX) :+886-3-583-7948

Doc No: 17-EM-F0876 / 6.0



Test Data

Mode	SRD_TX2475	Channel	5
------	------------	---------	---

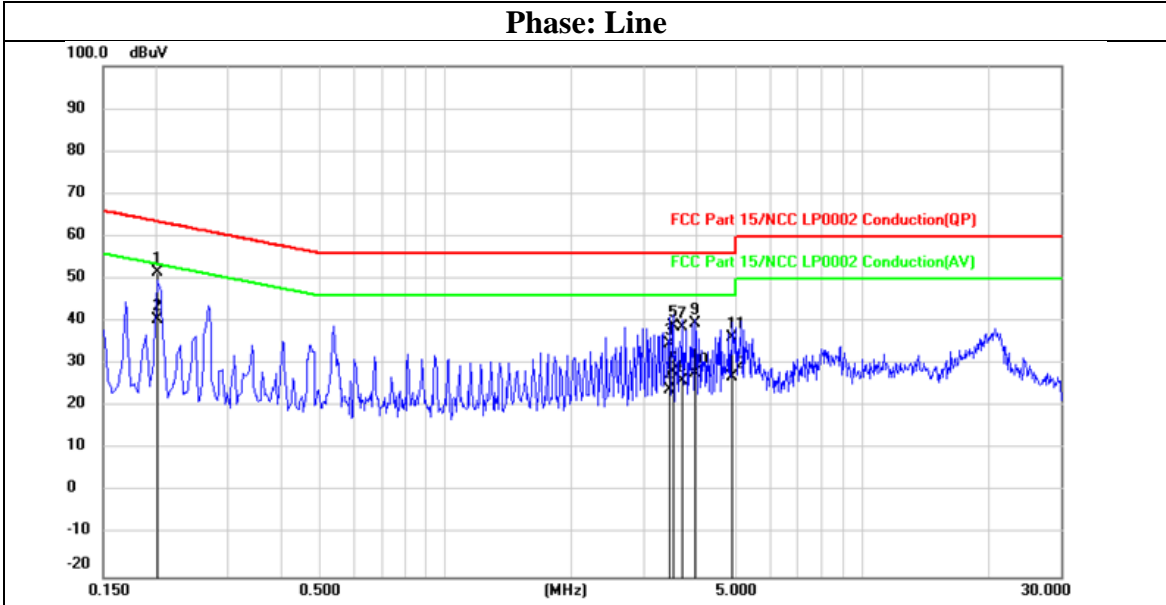

No.	Frequency (MHz)	Reading (dBuV)	Correct (dB)	Result (dBuV)	Limit (dBuV)	Margin (dB)	Remark
1	0.2020	32.08	19.48	51.56	63.53	-11.97	QP
2	0.2020	21.08	19.48	40.56	53.53	-12.97	AVG
3	3.4380	15.21	19.55	34.76	56.00	-21.24	QP
4	3.4380	4.40	19.55	23.95	46.00	-22.05	AVG
5	3.5100	19.40	19.55	38.95	56.00	-17.05	QP
6	3.5100	8.69	19.55	28.24	46.00	-17.76	AVG
7	3.7140	19.24	19.56	38.80	56.00	-17.20	QP
8	3.7140	6.64	19.56	26.20	46.00	-19.80	AVG
9	3.9820	20.01	19.57	39.58	56.00	-16.42	QP
10	3.9820	8.40	19.57	27.97	46.00	-18.03	AVG
11	4.8580	16.54	19.59	36.13	56.00	-19.87	QP
12	4.8580	7.42	19.59	27.01	46.00	-18.99	AVG

Underwriters Laboratories Taiwan Co., Ltd.

Building B and Building E, No. 372-7, Sec. 4, Zhongxing Rd., Zhudong Township, Hsinchu County, Taiwan

Telephone :+886-2-7737-3000

Facsimile (FAX) :+886-3-583-7948



Mode	SRD_TX2475	Channel	5
------	------------	---------	---

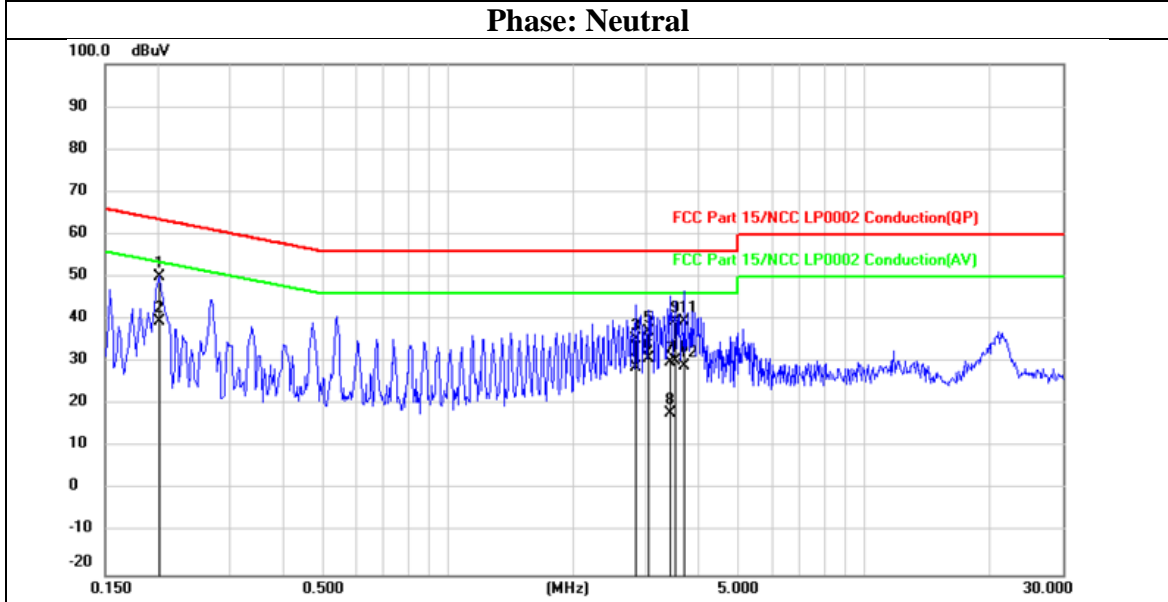

No.	Frequency (MHz)	Reading (dBuV)	Correct (dB)	Result (dBuV)	Limit (dBuV)	Margin (dB)	Remark
1	0.2020	30.49	19.48	49.97	63.53	-13.56	QP
2	0.2020	19.99	19.48	39.47	53.53	-14.06	AVG
3	2.8380	15.92	19.53	35.45	56.00	-20.55	QP
4	2.8380	9.22	19.53	28.75	46.00	-17.25	AVG
5	3.0380	17.67	19.54	37.21	56.00	-18.79	QP
6	3.0380	11.27	19.54	30.81	46.00	-15.19	AVG
7	3.4340	10.44	19.54	29.98	56.00	-26.02	QP
8	3.4340	-1.63	19.54	17.91	46.00	-28.09	AVG
9	3.5100	19.93	19.55	39.48	56.00	-16.52	QP
10	3.5100	10.77	19.55	30.32	46.00	-15.68	AVG
11	3.7140	19.91	19.56	39.47	56.00	-16.53	QP
12	3.7140	9.45	19.56	29.01	46.00	-16.99	AVG

END OF REPORT

Underwriters Laboratories Taiwan Co., Ltd.

Building B and Building E, No. 372-7, Sec. 4, Zhongxing Rd., Zhudong Township, Hsinchu County, Taiwan

Telephone :+886-2-7737-3000

Facsimile (FAX) :+886-3-583-7948

Doc No: 17-EM-F0876 / 6.0