



FCC RADIO TEST REPORT

FCC ID: RKZICARTA2

Product : iCarta 2 Bluetooth Stereo Speaker with
bathtissue holder

Trade Name : AFT

Model Name : iCarta 2

Serial Model : N/A

Report No. : NTEK-2013NT0107029F

Prepared for

Atech Flash Technology, Inc.

46045 Warm Springs Blvd, Fremont, California, United States

Prepared by

Shenzhen NTEK Testing Technology Co., Ltd.

1/F, Building E, Fenda Science Park, Sanwei Community, Xixiang Street
Bao'an District, Shenzhen P.R. China

Tel.: +86-0755-61156588 Fax.: +86-0755-61156599

Website: www.ntek.org.cn

TEST RESULT CERTIFICATION

Applicant's name : Atech Flash Technology, Inc.
Address : 46045 Warm Springs Blvd, Fremont, California, United States
Manufacturer's Name : Atech Flash Technology, Inc.
Address : 46045 Warm Springs Blvd, Fremont, California, United States

Product description

Product name..... : iCarta 2 Bluetooth Stereo Speaker with bathtissue holder
Model and/or type reference : iCarta 2
Serial Model : N/A

Standards : FCC Part15.247

Test procedure ANSI C63.4-2003, DA 00-705

This device described above has been tested by NTEK, and the test results show that the equipment under test (EUT) is in compliance with the FCC requirements. And it is applicable only to the tested sample identified in the report.

This report shall not be reproduced except in full, without the written approval of NTEK, this document may be altered or revised by NTEK, personal only, and shall be noted in the revision of the document.

Date of Test :
Date (s) of performance of tests : 28 Dec. 2012 ~05 Jan. 2013
Date of Issue..... : 06 Jan. 2013
Test Result..... : **Pass**

Testing Engineer : Apple Huang
(Apple Huang)
Technical Manager : Tom Zhang
(Tom Zhang)
Authorized Signatory : Bovey Yang
(Bovey Yang)

Table of Contents

	Page
1 . SUMMARY OF TEST RESULTS	6
1.1 TEST FACILITY	7
1.2 MEASUREMENT UNCERTAINTY	7
2 . GENERAL INFORMATION	8
2.1 GENERAL DESCRIPTION OF EUT	8
2.2 DESCRIPTION OF TEST MODES	10
2.3 TABLE OF PARAMETERS OF TEXT SOFTWARE SETTING	10
2.4 BLOCK DIGRAM SHOWING THE CONFIGURATION OF SYSTEM TESTED	11
2.5 DESCRIPTION OF SUPPORT UNITS(CONDUCTED MODE)	12
2.6 EQUIPMENTS LIST FOR ALL TEST ITEMS	13
3 . EMC EMISSION TEST	14
3.1 CONDUCTED EMISSION MEASUREMENT	14
3.1.1 POWER LINE CONDUCTED EMISSION LIMITS	14
3.1.2 TEST PROCEDURE	15
3.1.3 DEVIATION FROM TEST STANDARD	15
3.1.4 TEST SETUP	15
3.1.5 EUT OPERATING CONDITIONS	15
3.1.6 TEST RESULTS	16
3.2 RADIATED EMISSION MEASUREMENT	18
3.2.1 RADIATED EMISSION LIMITS	18
3.2.2 TEST PROCEDURE	19
3.2.3 DEVIATION FROM TEST STANDARD	19
3.2.4 TEST SETUP	20
3.2.5 EUT OPERATING CONDITIONS	21
3.2.6 TEST RESULTS (BELOW 30 MHZ)	22
3.2.7 TEST RESULTS (BETWEEN 30M – 1000 MHZ)	23
3.2.8 TEST RESULTS (ABOVE 1000 MHZ)	25
3.2.9 TEST RESULTS (RESTRICTED BANDS REQUIREMENTS)	43
4 . NUMBER OF HOPPING CHANNEL	55
4.1 APPLIED PROCEDURES / LIMIT	55
4.1.1 TEST PROCEDURE	55
4.1.2 DEVIATION FROM STANDARD	55
4.1.3 TEST SETUP	55
4.1.4 EUT OPERATION CONDITIONS	55
4.1.5 TEST RESULTS	56
5 . AVERAGE TIME OF OCCUPANCY	57

Table of Contents

	Page
5.1 APPLIED PROCEDURES / LIMIT	57
5.1.1 TEST PROCEDURE	57
5.1.2 DEVIATION FROM STANDARD	57
5.1.3 TEST SETUP	58
5.1.4 EUT OPERATION CONDITIONS	58
5.1.5 TEST RESULTS	59
6 . HOPPING CHANNEL SEPARATION MEASUREMENT	65
6.1 APPLIED PROCEDURES / LIMIT	65
6.1.1 TEST PROCEDURE	65
6.1.2 DEVIATION FROM STANDARD	65
6.1.3 TEST SETUP	65
6.1.4 EUT OPERATION CONDITIONS	65
6.1.5 TEST RESULTS	66
7 . BANDWIDTH TEST	72
7.1 APPLIED PROCEDURES / LIMIT	72
7.1.1 TEST PROCEDURE	72
7.1.2 DEVIATION FROM STANDARD	72
7.1.3 TEST SETUP	72
7.1.4 EUT OPERATION CONDITIONS	72
7.1.5 TEST RESULTS	73
8 . PEAK OUTPUT POWER TEST	79
8.1 APPLIED PROCEDURES / LIMIT	79
8.1.1 TEST PROCEDURE	79
8.1.2 DEVIATION FROM STANDARD	79
8.1.3 TEST SETUP	79
8.1.4 EUT OPERATION CONDITIONS	79
8.1.5 TEST RESULTS	80
9 . EQUAL HOPPING FREQUENCY USE	86
9.1 APPLIED PROCEDURES / LIMIT	86
9.1.1 TEST RESULTS	86
10 . RECEIVER INPUT BANDWIDTH	87
10.1 APPLIED PROCEDURES / LIMIT	87
10.1.1 TEST RESULTS	87
11 . RECEIVER HOPPING CAPABILITY	87
11.1 APPLIED PROCEDURES / LIMIT	87
11.1.1 TEST RESULTS	88
12 . EUT TEST PHOTO	89

Table of Contents

Page

APPENDIX-PHOTOGRAPHS OF EUT CONSTRUCTIONAL DETAILS

1. SUMMARY OF TEST RESULTS

Test procedures according to the technical standards:

FCC Part15 (15.247) , Subpart C			
Standard Section	Test Item	Judgment	Remark
15.207	Conducted Emission	PASS	
15.247(a)(1)	Hopping Channel Separation	PASS	
15.247(b)(1)	Peak Output Power	PASS	
15.247(c)	Radiated Spurious Emission	PASS	
15.247(a)(iii)	Number of Hopping Frequency	PASS	
15.247(a)(iii)	Dwell Time	PASS	
15.247(a)(1)	Bandwidth	PASS	
15.205	Band Edge Emission	PASS	
15.203	Antenna Requirement	PASS	

NOTE:

(1) "N/A" denotes test is not applicable in this Test Report

1.1 TEST FACILITY

NTEK Testing Technology Co., Ltd

Add. : 1/F, Building E, Fenda Science Park, Sanwei Community, Xixiang Street, Bao'an District, Shenzhen P.R. China.

FCC Registration No.:238937; IC Registration No.:9270A-1

CNAS Registration No.:L5516

1.2 MEASUREMENT UNCERTAINTY

The reported uncertainty of measurement $y \pm U$, where expanded uncertainty U is based on a standard uncertainty multiplied by a coverage factor of $k=2$, providing a level of confidence of approximately **95 %**.

No.	Item	Uncertainty
1	Conducted Emission Test	$\pm 1.38\text{dB}$
2	RF power,conducted	$\pm 0.16\text{dB}$
3	Spurious emissions,conducted	$\pm 0.21\text{dB}$
4	All emissions,radiated(<1G)	$\pm 4.68\text{dB}$
5	All emissions,radiated(>1G)	$\pm 4.89\text{dB}$
6	Temperature	$\pm 0.5^\circ\text{C}$
7	Humidity	$\pm 2\%$

2. GENERAL INFORMATION

2.1 GENERAL DESCRIPTION OF EUT

Equipment	iCarta 2 Bluetooth Stereo Speaker with bathtissue holder	
Trade Name	AFT	
Model Name	iCarta 2	
Serial Model	N/A	
Model Difference	N/A	
Product Description	The EUT is a iCarta 2 Bluetooth Stereo Speaker with bathtissue holder	
	Operation Frequency:	2402~2480 MHz
	Modulation Type:	BT(1Mbps): GFSK BT EDR(2Mbps): 114-DQPSK BT EDR(3Mbps): 8-DPSK
	Bit Rate of Transmitter	1Mbps/2Mbps/3Mbps
	Number Of Channel	79 CH
	Antenna Designation:	Please see Note 3.
	Output Power(Conducted):	BT(1Mbps): 0.435dBm BT EDR(2Mbps): -0.135dBm BT EDR(3Mbps): -0.363dBm
	Based on the application, features, or specification exhibited in User's Manual, the EUT is considered as an ITE/Computing Device. More details of EUT technical specification, please refer to the User's Manual.	
Channel List	Please refer to the Note 2.	
Adapter	N/A	
Battery	1.5V*4cell "AA" alkaline battery	
Connecting I/O Port(s)	Please refer to the User's Manual	

Note:

1. For a more detailed features description, please refer to the manufacturer's specifications or the User's Manual.

2.

Channel List					
Channel	Frequency (MHz)	Channel	Frequency (MHz)	Channel	Frequency (MHz)
00	2402	27	2429	54	2456
01	2403	28	2430	55	2457
02	2404	29	2431	56	2458
03	2405	30	2432	57	2459
04	2406	31	2433	58	2460
05	2407	32	2434	59	2461
06	2408	33	2435	60	2462
07	2409	34	2436	61	2463
08	2410	35	2437	62	2464
09	2411	36	2438	63	2465
10	2412	37	2439	64	2466
11	2413	38	2440	65	2467
12	2414	39	2441	66	2468
13	2415	40	2442	67	2469
14	2416	41	2443	68	2470
15	2417	42	2444	69	2471
16	2418	43	2445	70	2472
17	2419	44	2446	71	2473
18	2420	45	2447	72	2474
19	2421	46	2448	73	2475
20	2422	47	2449	74	2476
21	2423	48	2450	75	2477
22	2424	49	2451	76	2478
23	2425	50	2452	77	2479
24	2426	51	2453	78	2480
25	2427	52	2454		
26	2428	53	2455		

3.

Table for Filed Antenna

Ant	Brand	Model Name	Antenna Type	Connector	Gain (dBi)	NOTE
1	N/A	N/A	PCB Antenna	N/A	0.53	BT Antenna

2.2 DESCRIPTION OF TEST MODES

To investigate the maximum EMI emission characteristics generates from EUT, the test system was pre-scanning tested base on the consideration of following EUT operation mode or test configuration mode which possible have effect on EMI emission level. Each of these EUT operation mode(s) or test configuration mode(s) mentioned above was evaluated respectively.

Pretest Mode	Description
Mode 1	CH00
Mode 2	CH39
Mode 3	CH78
Mode 4	Running

For Conducted Emission	
Final Test Mode	Description
Mode 4	Running

For Radiated Emission	
Final Test Mode	Description
Mode 1	CH00
Mode 2	CH39
Mode 3	CH78

Note:

- (1) The measurements are performed at the highest, middle, lowest available channels.
- (2) The EUT use new battery.
- (3)The data rate was set in 1Mbps for radiated emission due to the highest RF output power.

2.3 TABLE OF PARAMETERS OF TEXT SOFTWARE SETTING

During testing channel & power controlling software provided by the customer was used to control the operating channel as well as the output power level. The RF output power selection is for the setting of RF output power expected by the customer and is going to be fixed on the firmware of the final end product power parameters of FHSS

Test software Version	Test program: bluetool 1.4.4.9		
Frequency	2402 MHz	2441 MHz	2480 MHz
Parameters(1Mbps/2Mbps/3Mbps)	DEF	DEF	DEF

2.4 BLOCK DIGRAM SHOWING THE CONFIGURATION OF SYSTEM TESTED

Radiated Spurious Emission Test

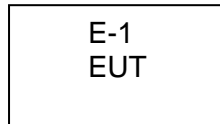

Conducted Measurement

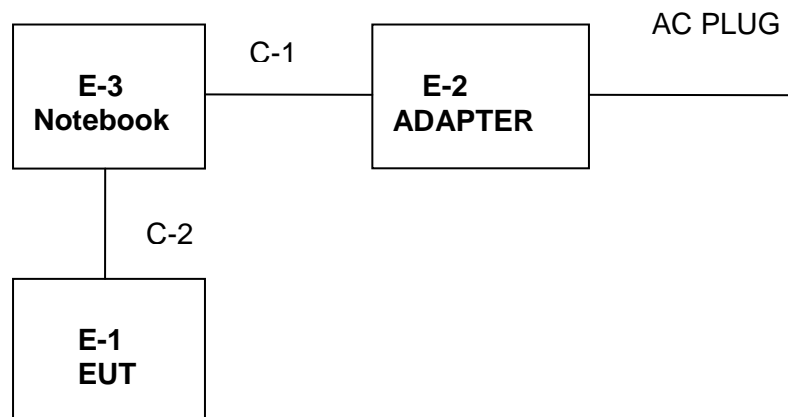

2.5 DESCRIPTION OF SUPPORT UNITS(CONDUCTED MODE)

The EUT has been tested as an independent unit together with other necessary accessories or support units. The following support units or accessories were used to form a representative test configuration during the tests.

Item	Equipment	Mfr/Brand	Model/Type No.	Series No.	Note
E-1	iCarta 2 Bluetooth Stereo Speaker with bathtissue holder	AFT	iCarta 2	N/A	EUT
E-2	Adapter	IBM	08K8202	E-2	
E-3	Notebook	IBM	2366	E-3	

Item	Shielded Type	Ferrite Core	Length	Note
C-1	NO	NO	0.8M	
C-2	NO	NO	0.5M	

Note:

- (1) The support equipment was authorized by Declaration of Confirmation.
- (2) For detachable type I/O cable should be specified the length in cm in 『Length』 column.
- (3) “YES” is means “shielded” “with core”; “NO” is means “unshielded” “without core”.

2.6 EQUIPMENTS LIST FOR ALL TEST ITEMS

Radiation Test equipment

Item	Kind of Equipment	Manufacturer	Type No.	Serial No.	Calibrated until
1	Spectrum Analyzer	Agilent	E4407B	160400005	Jul. 06. 2013
2	Test Receiver	R&S	ESPI	101318	Jul. 06. 2013
3	Bilog Antenna	TESEQ	CBL6111D	31216	Jul. 06. 2013
4	50Ω Coaxial Switch	Anritsu	MP59B	6200264416	Jul. 06. 2013
5	Spectrum Analyzer	ADVANTEST	R3132	150900201	Jul. 06. 2013
6	Horn Antenna	EM	EM-AH-10180	2011071402	Jul. 06. 2013
7	Horn Ant	Schwarzbeck	BBHA 9170	9170-181	Jul. 06. 2013
8	Amplifier	EM	EM-30180	060538	Jul. 06. 2013
9	Loop Antenna	ARA	PLA-1030/B	1029	Jul. 06. 2013
10	Power Meter	R&S	NRVS	100696	Jul. 06. 2013
11	Power Sensor (AV)	R&S	URV5-Z4	0395.1619.0 5	Jul. 06., 2013

Conduction Test equipment

Item	Kind of Equipment	Manufacturer	Type No.	Serial No.	Calibrated until
1	Test Receiver	R&S	ESCI	101160	Jul. 06. 2013
2	LISN	R&S	ENV216	101313	Jul. 06. 2013
3	LISN	EMCO	3816/2	00042990	Jul. 06. 2013
4	50Ω Coaxial Switch	Anritsu	MP59B	6200264417	Jul. 06. 2013
5	Passive Voltage Probe	R&S	ESH2-Z3	100196	Jul. 06. 2013
6	Absorbing clamp	R&S	MOS-21	100423	Jul. 06. 2013

3. EMC EMISSION TEST

3.1 CONDUCTED EMISSION MEASUREMENT

3.1.1 POWER LINE CONDUCTED EMISSION Limits (Frequency Range 150KHz-30MHz)

FREQUENCY (MHz)	Class A (dBuV)		Class B (dBuV)		Standard
	Quasi-peak	Average	Quasi-peak	Average	
0.15 -0.5	79.00	66.00	66 - 56 *	56 - 46 *	CISPR
0.50 -5.0	73.00	60.00	56.00	46.00	CISPR
5.0 -30.0	73.00	60.00	60.00	50.00	CISPR

0.15 -0.5	79.00	66.00	66 - 56 *	56 - 46 *	FCC
0.50 -5.0	73.00	60.00	56.00	46.00	FCC
5.0 -30.0	73.00	60.00	60.00	50.00	FCC

Note:

- (1) The tighter limit applies at the band edges.
- (2) The limit of " * " marked band means the limitation decreases linearly with the logarithm of the frequency in the range.

The following table is the setting of the receiver

Receiver Parameters	Setting
Attenuation	10 dB
Start Frequency	0.15 MHz
Stop Frequency	30 MHz
IF Bandwidth	9 kHz

3.1.2 TEST PROCEDURE

- a. The EUT was placed 0.4 meters from the horizontal ground plane with EUT being connected to the power mains through a line impedance stabilization network (LISN). All other support equipments powered from additional LISN(s). The LISN provide 50 Ohm/ 50uH of coupling impedance for the measuring instrument.
- b. Interconnecting cables that hang closer than 40 cm to the ground plane shall be folded back and forth in the center forming a bundle 30 to 40 cm long.
- c. I/O cables that are not connected to a peripheral shall be bundled in the center. The end of the cable may be terminated, if required, using the correct terminating impedance. The overall length shall not exceed 1 m.
- d. LISN at least 80 cm from nearest part of EUT chassis.
- e. For the actual test configuration, please refer to the related Item –EUT Test Photos.

3.1.3 DEVIATION FROM TEST STANDARD

No deviation

3.1.4 TEST SETUP

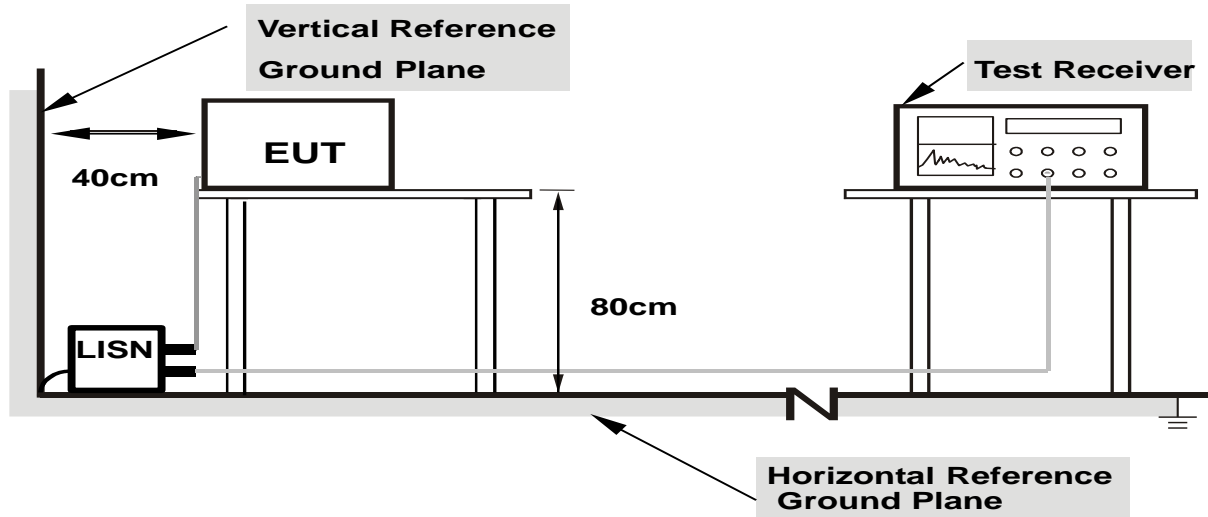

- Note:**
- 1.Support units were connected to second LISN.
 - 2.Both of LISNs (AMN) are 80 cm from EUT and at least 80 from other units and other metal planes

3.1.5 EUT OPERATING CONDITIONS

The EUT was configured for testing in a typical fashion (as a customer would normally use it). The EUT has been programmed to continuously transmit during test. This operating condition was tested and used to collect the included data.

3.1.6 TEST RESULTS

EUT :	iCarta 2 Bluetooth Stereo Speaker with bathtissue holder	Model Name :	iCarta 2
Temperature :	26 °C	Relative Humidity :	54%
Pressure :	1010hPa	Phase :	L
Test Voltage :	DC5V from PC AC 120V/60Hz	Test Mode :	Mode 4

Frequency (MHz)	Meter Reading (dBμV)	Factor (dB)	Emission Level (dBμV)	Limits (dBμV)	Margin (dB)	Detector Type
0.1819	48.11	10.06	58.17	64.39	-6.22	QP
0.1819	30.86	10.06	40.92	54.39	-13.47	AVG
0.786	36.9	10.22	47.12	56	-8.88	QP
0.974	29.44	10.16	39.6	46	-6.4	AVG
1.734	35.95	10.22	46.17	56	-9.83	QP
1.842	30.82	10.23	41.05	46	-4.95	AVG

Remark:

1. All readings are Quasi-Peak and Average values.
2. Factor = Insertion Loss + Cable Loss.

100.0 dBμV

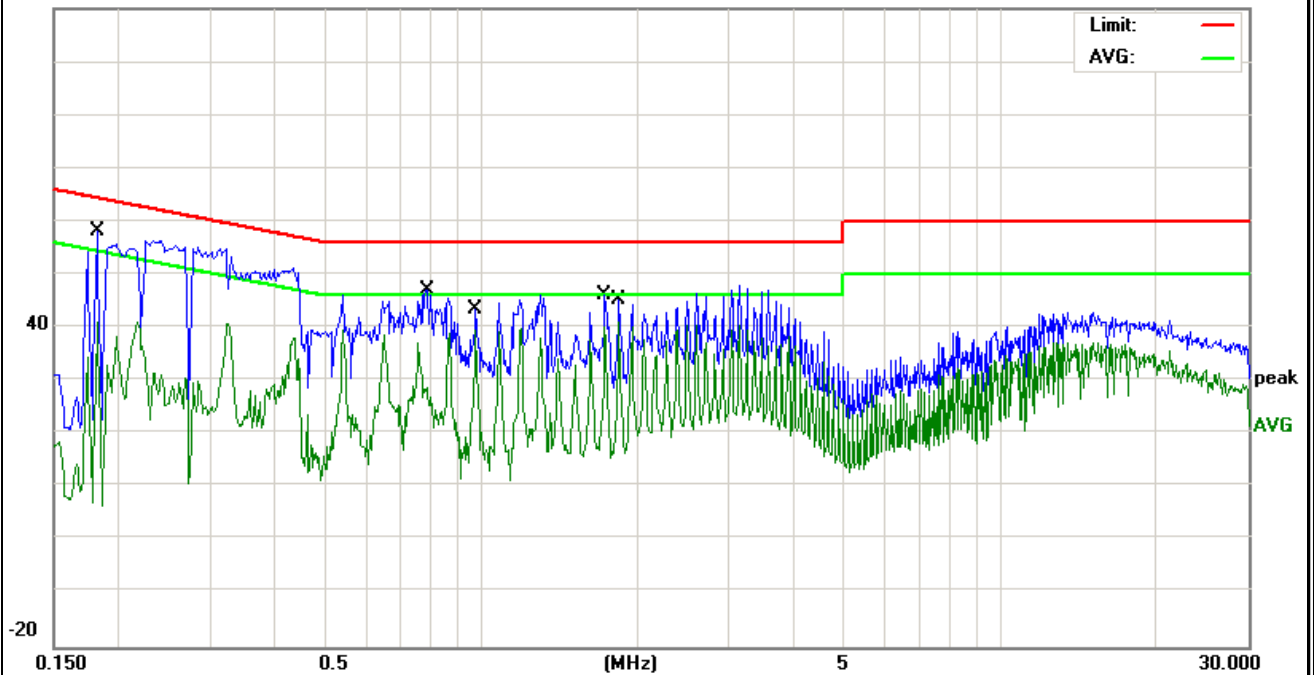

EUT :	iCarta 2 Bluetooth Stereo Speaker with bathtissue holder	Model Name :	iCarta 2
Temperature :	26 °C	Relative Humidity :	54%
Pressure :	1010hPa	Phase :	N
Test Voltage :	DC5V from PC AC 120V/60Hz	Test Mode :	Mode 4

Frequency (MHz)	Meter Reading (dBμV)	Factor (dB)	Emission Level (dBμV)	Limits (dBμV)	Margin (dB)	Detector Type
0.1819	48.87	9.79	58.66	64.39	-5.73	QP
0.218	35.72	9.8	45.52	52.89	-7.37	AVG
0.438	40.29	10.11	50.4	57.1	-6.7	QP
0.542	31.22	10.2	41.42	46	-4.58	AVG
2.386	29.73	10.26	39.99	46	-6.01	AVG
2.602	37.52	10.27	47.79	56	-8.21	QP

Remark:

1. All readings are Quasi-Peak and Average values.
2. Factor = Insertion Loss + Cable Loss.

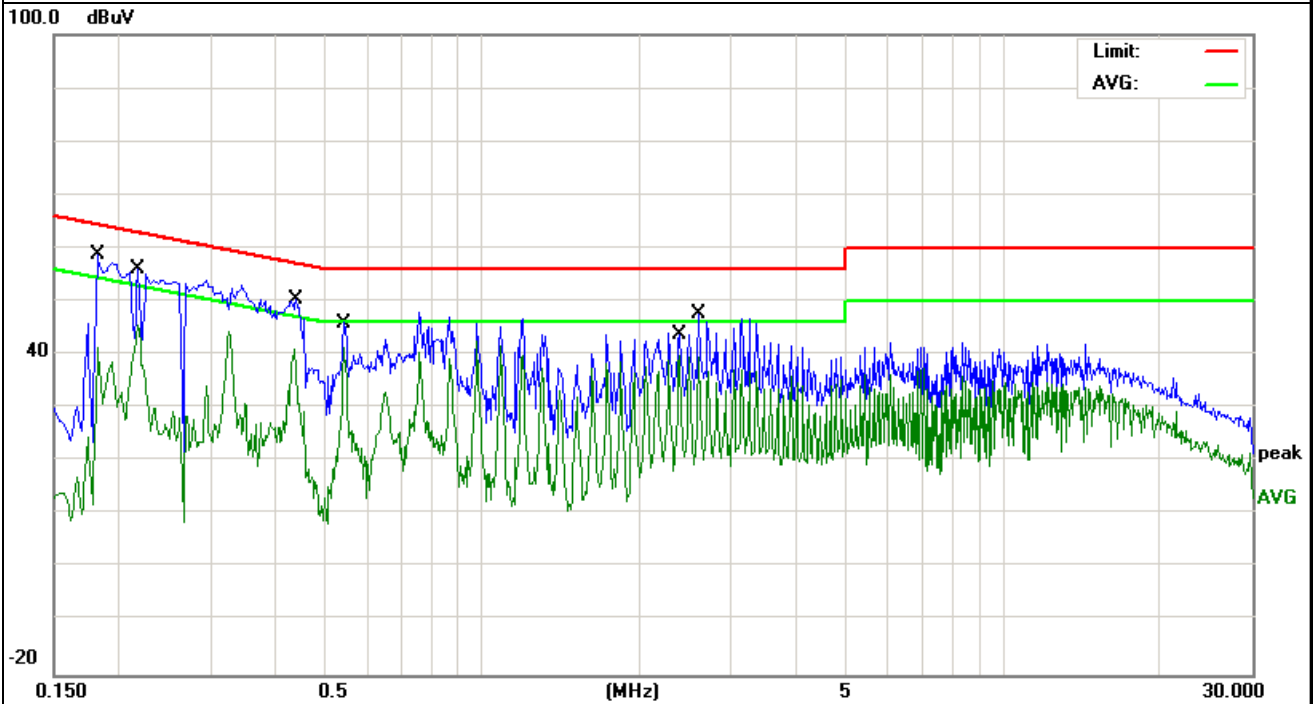

3.2 RADIATED EMISSION MEASUREMENT

3.2.1 RADIATED EMISSION LIMITS (Frequency Range 9kHz-1000MHz)

20dBc in any 100 kHz bandwidth outside the operating frequency band. In case the emission fall within the restricted band specified on 15.205(a), then the 15.209(a) limit in the table below has to be followed.

Frequencies (MHz)	Field Strength (micorvolts/meter)	Measurement Distance (meters)
0.009~0.490	2400/F(KHz)	300
0.490~1.705	24000/F(KHz)	30
1.705~30.0	30	30
30~88	100	3
88~216	150	3
216~960	200	3
Above 960	500	3

LIMITS OF RADIATED EMISSION MEASUREMENT (Above 1000MHz)

FREQUENCY (MHz)	Class A (dBuV/m) (at 3M)		Class B (dBuV/m) (at 3M)	
	PEAK	AVERAGE	PEAK	AVERAGE
Above 1000	80	60	74	54

Notes:

- (1) The limit for radiated test was performed according to FCC PART 15C.
- (2) The tighter limit applies at the band edges.
- (3) Emission level (dBuV/m)=20log Emission level (uV/m).

FREQUENCY RANGE OF RADIATED MEASUREMENT (For unintentional radiators)

Highest frequency generated or Upper frequency of measurement used in the device or on which the device operates or tunes (MHz)	Range (MHz)
Below 1.705	30
1.705 – 108	1000
108 – 500	2000
500 – 1000	5000
Above 1000	10 th harmonic of the highest frequency or 40 GHz, whichever is lower

Spectrum Parameter	Setting
Attenuation	Auto
Start Frequency	1000 MHz
Stop Frequency	10th carrier harmonic
RB / VB (emission in restricted band)	1 MHz / 1 MHz for Peak, 1 MHz / 10Hz for Average

Receiver Parameter	Setting
Attenuation	Auto
Start ~ Stop Frequency	9kHz~150kHz / RB 200Hz for QP
Start ~ Stop Frequency	150kHz~30MHz / RB 9kHz for QP
Start ~ Stop Frequency	30MHz~1000MHz / RB 120kHz for QP

3.2.2 TEST PROCEDURE

- a. The measuring distance of at 3 m shall be used for measurements at frequency up to 1GHz. For frequencies above 1GHz, any suitable measuring distance may be used.
- b. The EUT was placed on the top of a rotating table 0.8 meters above the ground at a 3 meter open area test site. The table was rotated 360 degrees to determine the position of the highest radiation.
- c. The height of the equipment or of the substitution antenna shall be 0.8 m; the height of the test antenna shall vary between 1 m to 4 m. Both horizontal and vertical polarizations of the antenna are set to make the measurement.
- d. The initial step in collecting conducted emission data is a spectrum analyzer peak detector mode pre-scanning the measurement frequency range. Significant peaks are then marked and then Quasi Peak detector mode re-measured.
- e. If the Peak Mode measured value compliance with and lower than Quasi Peak Mode Limit, the EUT shall be deemed to meet QP Limits and then no additional QP Mode measurement performed.
- f. For the actual test configuration, please refer to the related Item –EUT Test Photos.

Note:

Both horizontal and vertical antenna polarities were tested and performed pretest to three orthogonal axis. The worst case emissions were reported

3.2.3 DEVIATION FROM TEST STANDARD

No deviation

3.2.4 TEST SETUP

(A) Radiated Emission Test-Up Frequency Below 30MHz

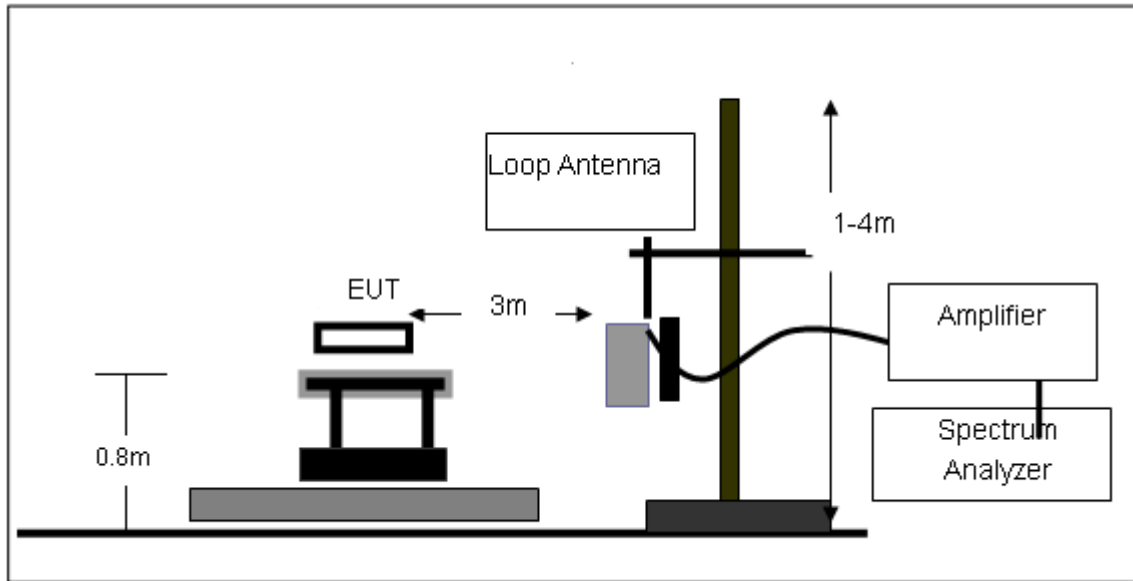

(B) Radiated Emission Test-Up Frequency 30MHz~1GHz

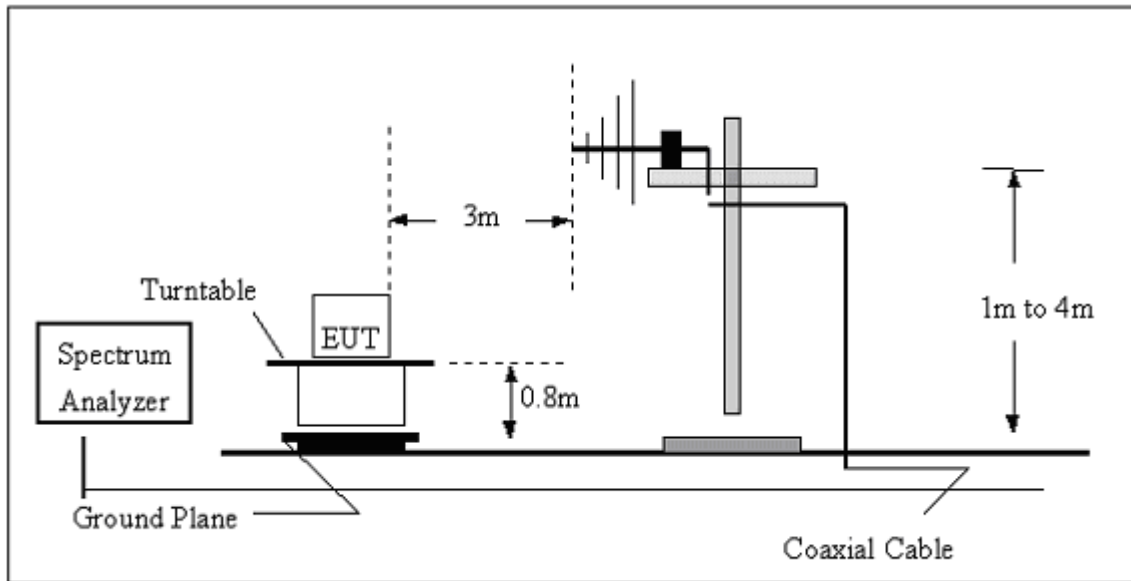

(C) Radiated Emission Test-Up Frequency Above 1GHz

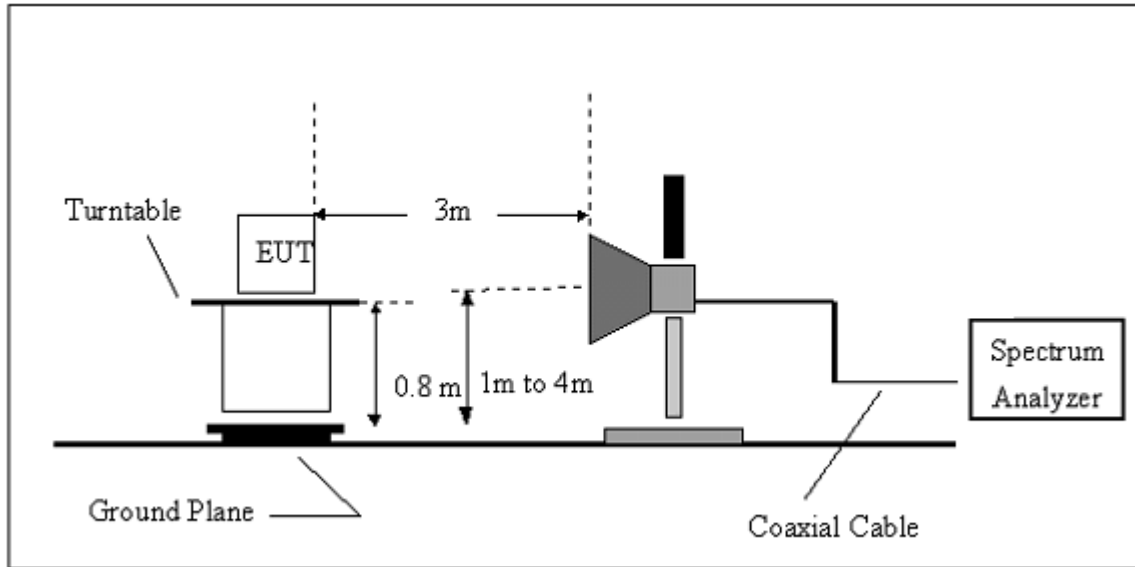

3.2.5 EUT OPERATING CONDITIONS

The EUT tested system was configured as the statements of 2.4 Unless otherwise a special operating condition is specified in the follows during the testing.

3.2.6 TEST RESULTS (BELOW 30 MHZ)

EUT :	iCarta 2 Bluetooth Stereo Speaker with bathtissue holder	Model Name :	iCarta 2
Temperature :	20 °C	Relative Humidity :	48%
Pressure :	1010 hPa	Polarization :	---
Test Voltage :	DC 6.0V by battery		
Test Mode :	TX		

Freq.	Reading	Limit	Margin	State
(MHz)	(dBuV/m)	(dBuV/m)	(dB)	P/F
--	--	--	--	PASS
--	--	--	--	PASS

NOTE:

The amplitude of spurious emissions which are attenuated by more than 20dB below the permissible value has no need to be reported.

Distance extrapolation factor = $20 \log(\text{specific distance}/\text{test distance})(\text{dB})$;

Limit line = specific limits(dBuv) + distance extrapolation factor.

3.2.7 TEST RESULTS (BETWEEN 30M – 1000 MHZ)

EUT :	iCarta 2 Bluetooth Stereo Speaker with bathtissue holder	Model Name :	iCarta 2
Temperature :	20 °C	Relative Humidity :	48%
Pressure :	1010 hPa	Polarization :	Horizontal
Test Voltage :	DC 6.0V by battery		
Test Mode :	TX		

Frequency (MHz)	Meter Reading (dBµV)	Factor (dB)	Emission Level (dBµV/m)	Limits (dBµV/m)	Margin (dB)	Detector Type
44.9004	14.27	10.63	24.9	40	-15.1	QP
54.8348	16.01	6.33	22.34	40	-17.66	QP
190.405	24.16	9.01	33.17	43.5	-10.33	QP

Remark:
 Factor = Antenna Factor + Cable Loss – Pre-amplifier.
 All interfaces was connected, and BT TX mode was link.

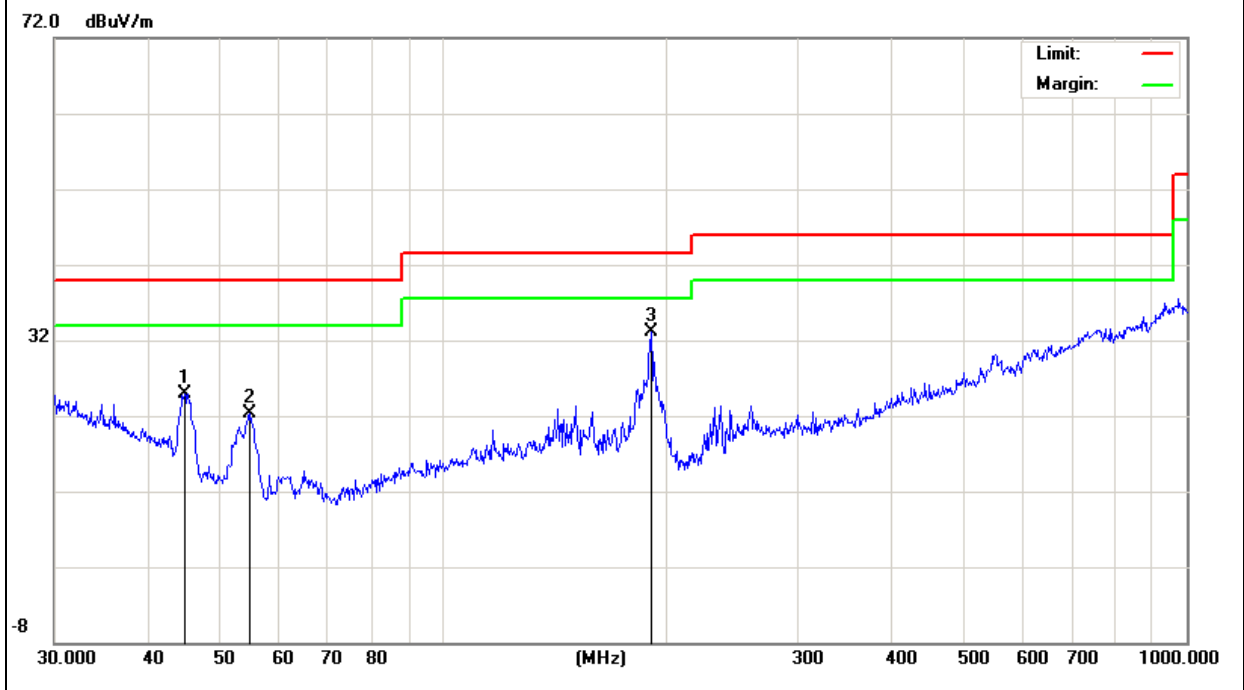

EUT :	iCarta 2 Bluetooth Stereo Speaker with bathtissue holder	Model Name :	iCarta 2
Temperature :	20 °C	Relative Humidity :	48%
Pressure :	1010 hPa	Polarization :	Vertical
Test Voltage :	DC 6.0V by battery		
Test Mode :	TX		

Frequency (MHz)	Meter Reading (dBµV)	Factor (dB)	Emission Level (dBµV/m)	Limits (dBµV/m)	Margin (dB)	Detector Type
55.0274	10.47	6.27	16.74	40	-23.26	QP
198.5879	19.23	8.99	28.22	43.5	-15.28	QP
249.425	13.98	13.4	27.38	46	-18.62	QP

Remark:
 Factor = Antenna Factor + Cable Loss – Pre-amplifier.
 All interfaces was connected, and BT TX mode was link.

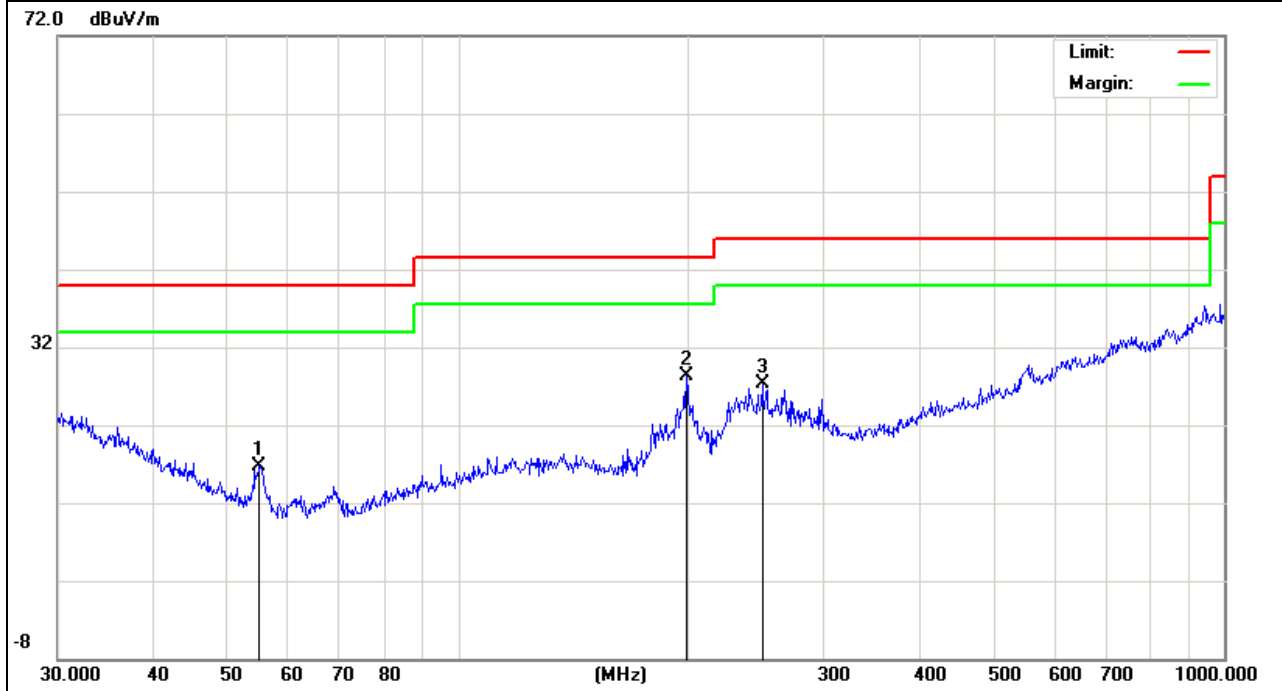

3.2.8 TEST RESULTS (ABOVE 1000 MHZ)

EUT :	iCarta 2 Bluetooth Stereo Speaker with bathtissue holder	Model Name :	iCarta 2
Temperature :	20 °C	Relative Humidity :	48%
Pressure :	1010 hPa	Test Voltage :	DC 6.0V
Test Mode :	TX 2402MHz – CH 00(1Mbps)	Polarization :	Horizontal

Frequency (MHz)	Meter Reading (dBµV)	Factor (dB)	Emission Level (dBµV/m)	Limits (dBµV/m)	Margin (dB)	Detector Type
4804.256	63.01	-3.64	59.37	74	-14.63	peak
4804.256	48.59	-3.64	44.95	54	-9.05	AVG
7206.117	54.57	-0.95	53.62	74	-20.38	peak
7206.117	44.28	-0.95	43.33	54	-10.67	AVG

Remark:

Factor = Antenna Factor + Cable Loss – Pre-amplifier.

No emission detected above 18GHz

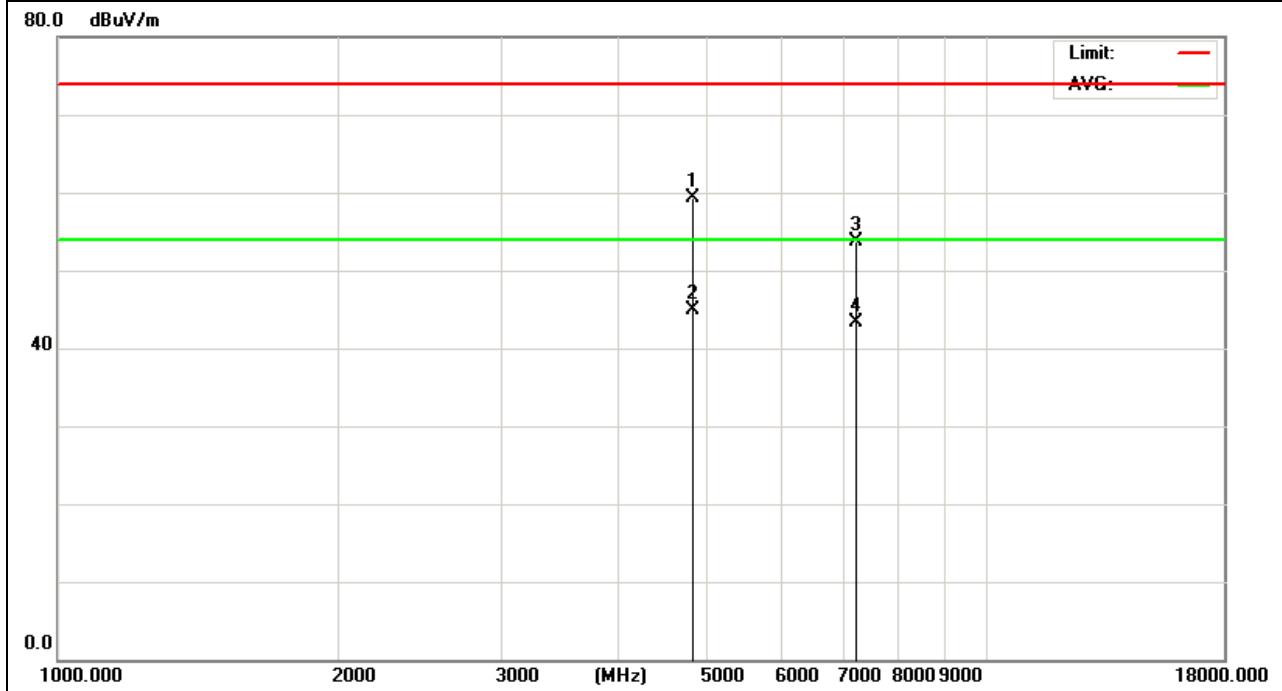

EUT :	iCarta 2 Bluetooth Stereo Speaker with bathtissue holder	Model Name :	iCarta 2
Temperature :	20 °C	Relative Humidity :	48%
Pressure :	1010 hPa	Test Voltage :	DC 6.0V
Test Mode :	TX 2402MHz – CH 00(1Mbps)	Polarization :	Vertical

Frequency (MHz)	Meter Reading (dBµV)	Factor (dB)	Emission Level (dBµV/m)	Limits (dBµV/m)	Margin (dB)	Detector Type
4804.132	65.91	-3.64	62.27	74	-11.73	peak
4804.132	51.97	-3.64	48.33	54	-5.67	AVG
7206.884	58.32	-0.96	57.36	74	-16.64	peak
7206.884	47.54	-0.96	46.58	54	-7.42	AVG

Remark:
 Factor = Antenna Factor + Cable Loss – Pre-amplifier.
 No emission detected above 18GHz

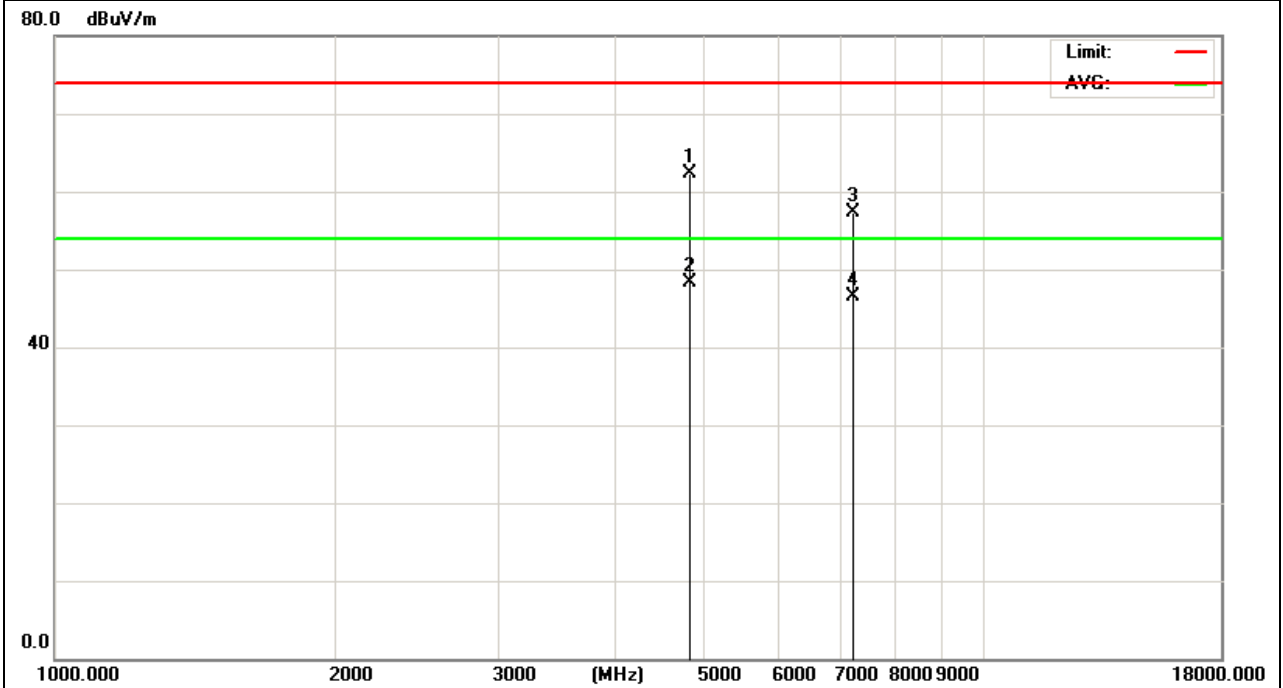

EUT :	iCarta 2 Bluetooth Stereo Speaker with bathtissue holder	Model Name :	iCarta 2
Temperature :	20 °C	Relative Humidity :	48%
Pressure :	1010 hPa	Test Voltage :	DC 6.0V
Test Mode :	TX 2441MHz – CH 39(1Mbps)	Polarization :	Vertical

Frequency (MHz)	Meter Reading (dBµV)	Factor (dB)	Emission Level (dBµV/m)	Limits (dBµV/m)	Margin (dB)	Detector Type
4882.625	69.47	-3.67	65.8	74	-8.2	peak
4882.625	49.74	-3.67	46.07	54	-7.93	AVG
7323.547	59.21	-0.82	58.39	74	-15.61	peak
7323.547	47.68	-0.82	46.86	54	-7.14	AVG

Remark:
 Factor = Antenna Factor + Cable Loss – Pre-amplifier.
 No emission detected above 18GHz

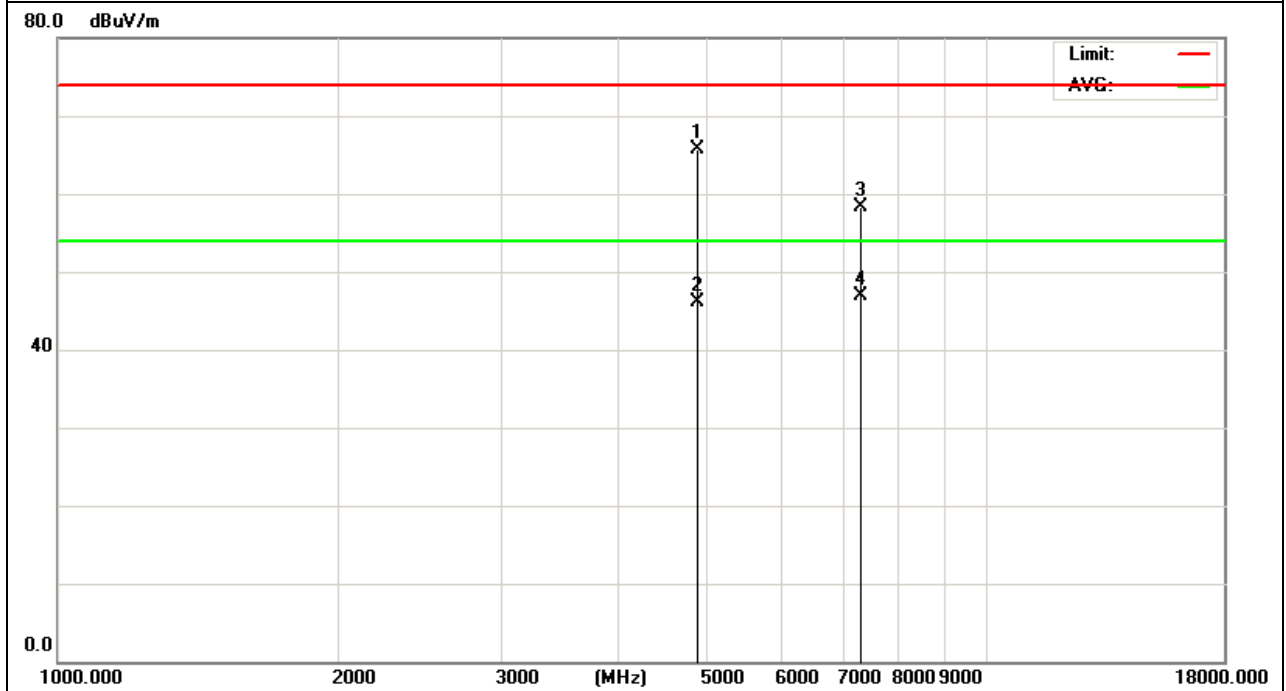

EUT :	iCarta 2 Bluetooth Stereo Speaker with bathtissue holder	Model Name :	iCarta 2
Temperature :	20 °C	Relative Humidity :	48%
Pressure :	1010 hPa	Test Voltage :	DC 6.0V
Test Mode :	TX 2441MHz – CH 39(1Mbps)	Polarization :	Horizontal

Frequency (MHz)	Meter Reading (dBµV)	Factor (dB)	Emission Level (dBµV/m)	Limits (dBµV/m)	Margin (dB)	Detector Type
4882.223	60.7	-3.67	57.03	74	-16.97	peak
4882.223	49.55	-3.67	45.88	54	-8.12	AVG
7323.153	57.57	-0.82	56.75	74	-17.25	peak
7323.153	45.45	-0.82	44.63	54	-9.37	AVG

Remark:
 Factor = Antenna Factor + Cable Loss – Pre-amplifier.
 No emission detected above 18GHz

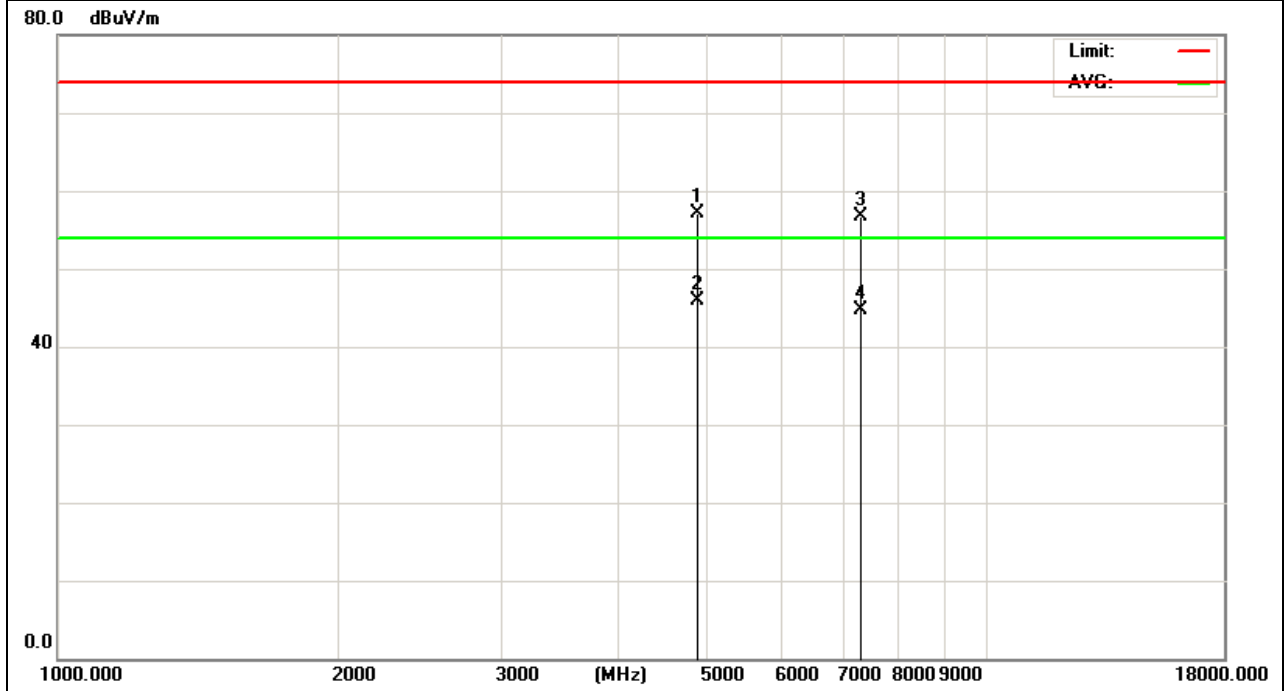

EUT :	iCarta 2 Bluetooth Stereo Speaker with bathtissue holder	Model Name :	iCarta 2
Temperature :	20 °C	Relative Humidity :	48%
Pressure :	1010 hPa	Test Voltage :	DC 6.0V
Test Mode :	TX 2480MHz – CH 78(1Mbps)	Polarization :	Horizontal

Frequency (MHz)	Meter Reading (dBµV)	Factor (dB)	Emission Level (dBµV/m)	Limits (dBµV/m)	Margin (dB)	Detector Type
4960.41	59.53	-3.59	55.94	74	-18.06	peak
4960.41	49.35	-3.59	45.76	54	-8.24	AVG
7440.435	53.79	-0.68	53.11	74	-20.89	peak
7440.435	45.3	-0.68	44.62	54	-9.38	AVG

Remark:
 Factor = Antenna Factor + Cable Loss – Pre-amplifier.
 No emission detected above 18GHz

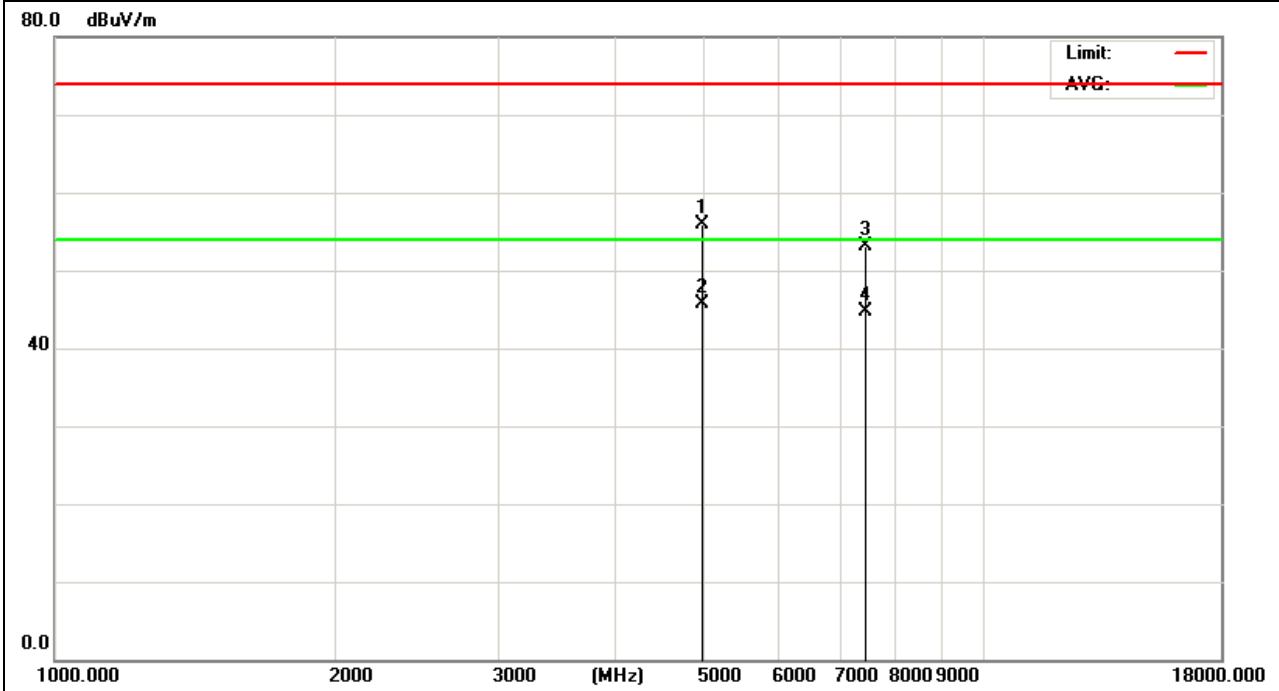

EUT :	iCarta 2 Bluetooth Stereo Speaker with bathtissue holder	Model Name :	iCarta 2
Temperature :	20 °C	Relative Humidity :	48%
Pressure :	1010 hPa	Test Voltage :	DC 6.0V
Test Mode :	TX 2480MHz – CH 78(1Mbps)	Polarization :	Vertical

Frequency (MHz)	Meter Reading (dBµV)	Factor (dB)	Emission Level (dBµV/m)	Limits (dBµV/m)	Margin (dB)	Detector Type
4960.237	63.53	-3.59	59.94	74	-14.06	peak
4960.237	50.98	-3.59	47.39	54	-6.61	AVG
7440.658	56.24	-0.68	55.56	74	-18.44	peak
7440.658	44.79	-0.68	44.11	54	-9.89	AVG

Remark:
 Factor = Antenna Factor + Cable Loss – Pre-amplifier.
 No emission detected above 18GHz

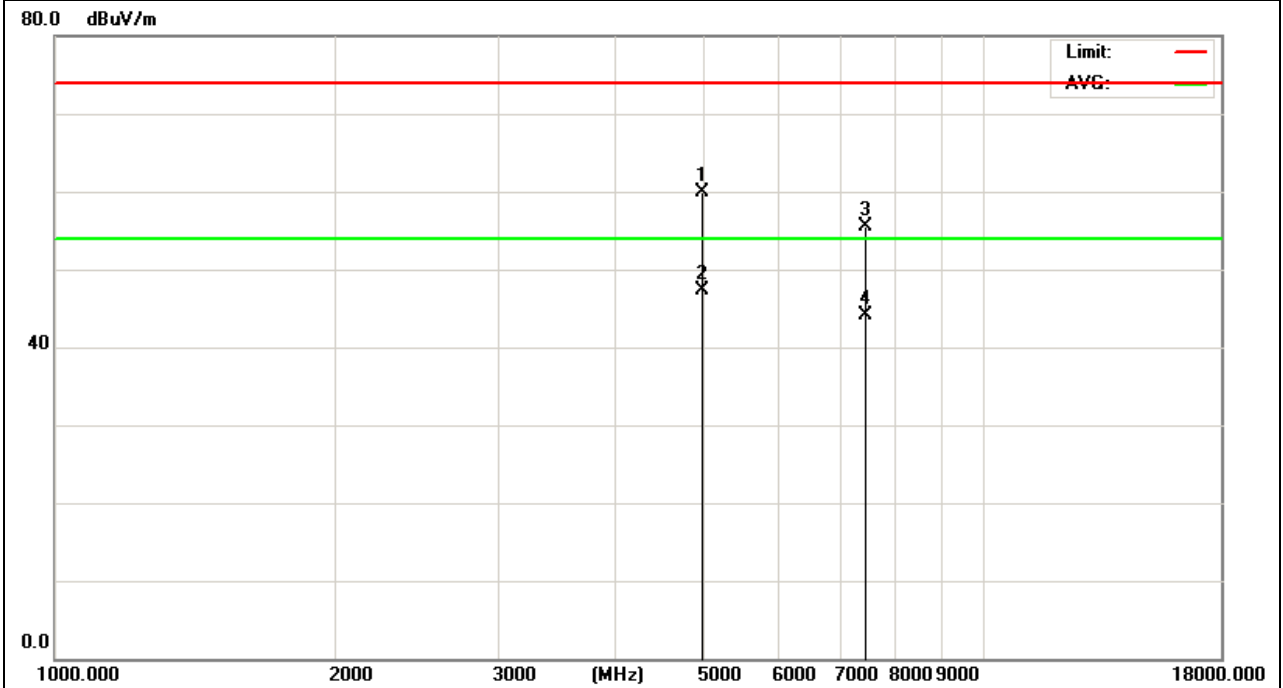

EUT :	iCarta 2 Bluetooth Stereo Speaker with bathtissue holder	Model Name :	iCarta 2
Temperature :	20 °C	Relative Humidity :	48%
Pressure :	1010 hPa	Test Voltage :	DC 6.0V
Test Mode :	TX 2402MHz – CH 00(2Mbps)	Polarization :	Horizontal

Frequency (MHz)	Meter Reading (dBµV)	Factor (dB)	Emission Level (dBµV/m)	Limits (dBµV/m)	Margin (dB)	Detector Type
4804.259	61.9	-3.64	58.26	74	-15.74	peak
4804.259	50.96	-3.64	47.32	54	-6.68	AVG
7206.038	56.64	-0.95	55.69	74	-18.31	peak
7206.038	47.2	-0.95	46.25	54	-7.75	AVG

Remark:
 Factor = Antenna Factor + Cable Loss – Pre-amplifier.
 No emission detected above 18GHz

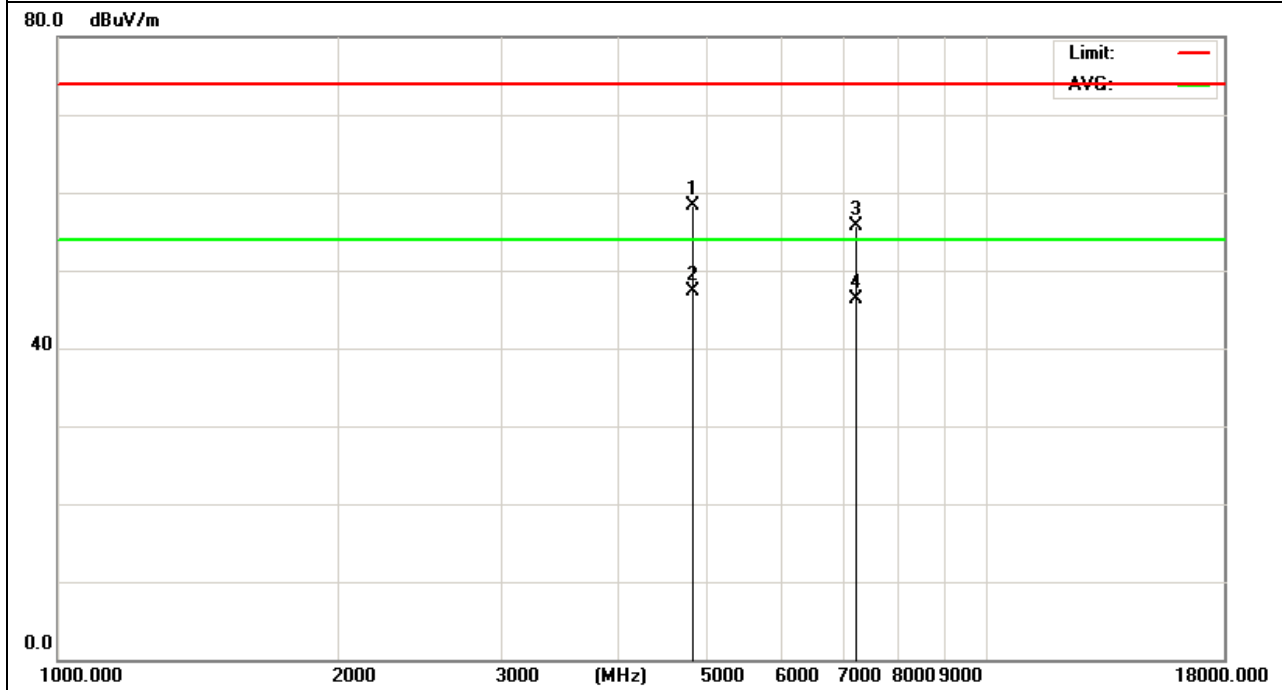

EUT :	iCarta 2 Bluetooth Stereo Speaker with bathtissue holder	Model Name :	iCarta 2
Temperature :	20 °C	Relative Humidity :	48%
Pressure :	1010 hPa	Test Voltage :	DC 6.0V
Test Mode :	TX 2402MHz – CH 00(2Mbps)	Polarization :	Vertical

Frequency (MHz)	Meter Reading (dBµV)	Factor (dB)	Emission Level (dBµV/m)	Limits (dBµV/m)	Margin (dB)	Detector Type
4804.259	63.56	-3.64	59.92	74	-14.08	peak
4804.259	49.72	-3.64	46.08	54	-7.92	AVG
7206.362	54.43	-0.95	53.48	74	-20.52	peak
7206.362	45.68	-0.95	44.73	54	-9.27	AVG

Remark:
 Factor = Antenna Factor + Cable Loss – Pre-amplifier.
 No emission detected above 18GHz

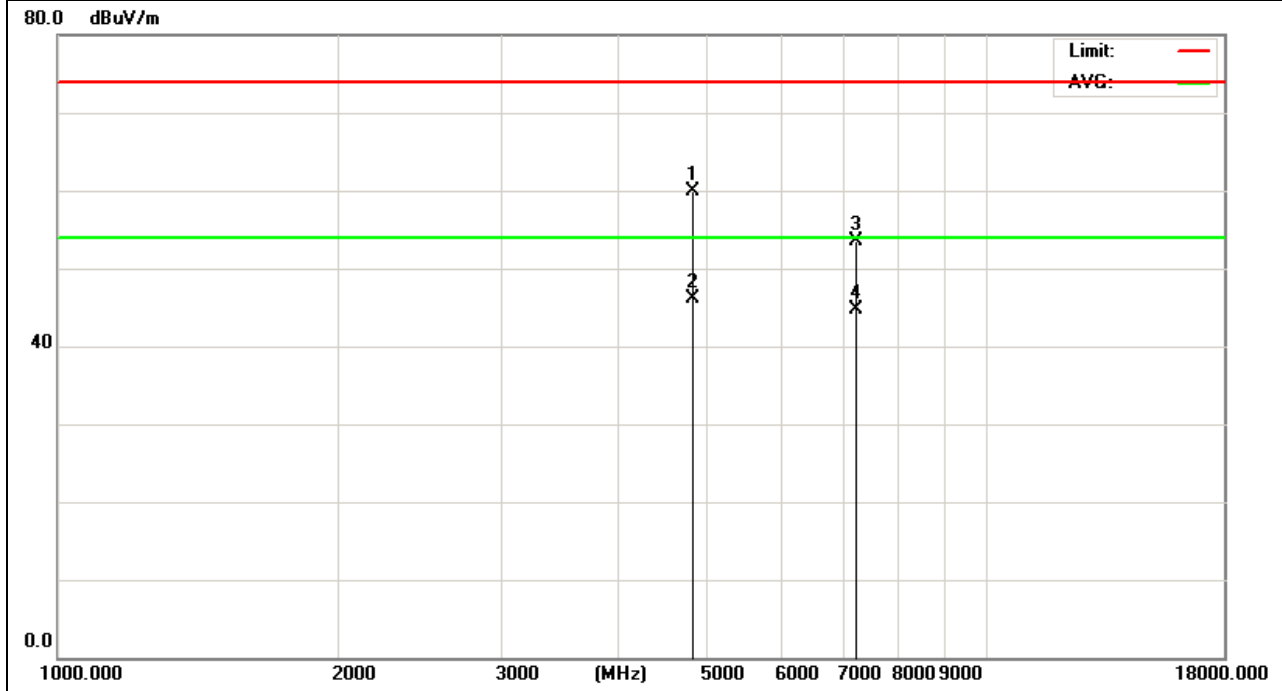

EUT :	iCarta 2 Bluetooth Stereo Speaker with bathtissue holder	Model Name :	iCarta 2
Temperature :	20 °C	Relative Humidity :	48%
Pressure :	1010 hPa	Test Voltage :	DC 6.0V
Test Mode :	TX 2441MHz – CH 39(2Mbps)	Polarization :	Horizontal

Frequency (MHz)	Meter Reading (dBµV)	Factor (dB)	Emission Level (dBµV/m)	Limits (dBµV/m)	Margin (dB)	Detector Type
4882.21	59.51	-3.67	55.84	74	-18.16	peak
4882.21	46.6	-3.67	42.93	54	-11.07	AVG
7323.338	54.35	-0.82	53.53	74	-20.47	peak
7323.338	44.53	-0.82	43.71	54	-10.29	AVG

Remark:
 Factor = Antenna Factor + Cable Loss – Pre-amplifier.
 No emission detected above 18GHz

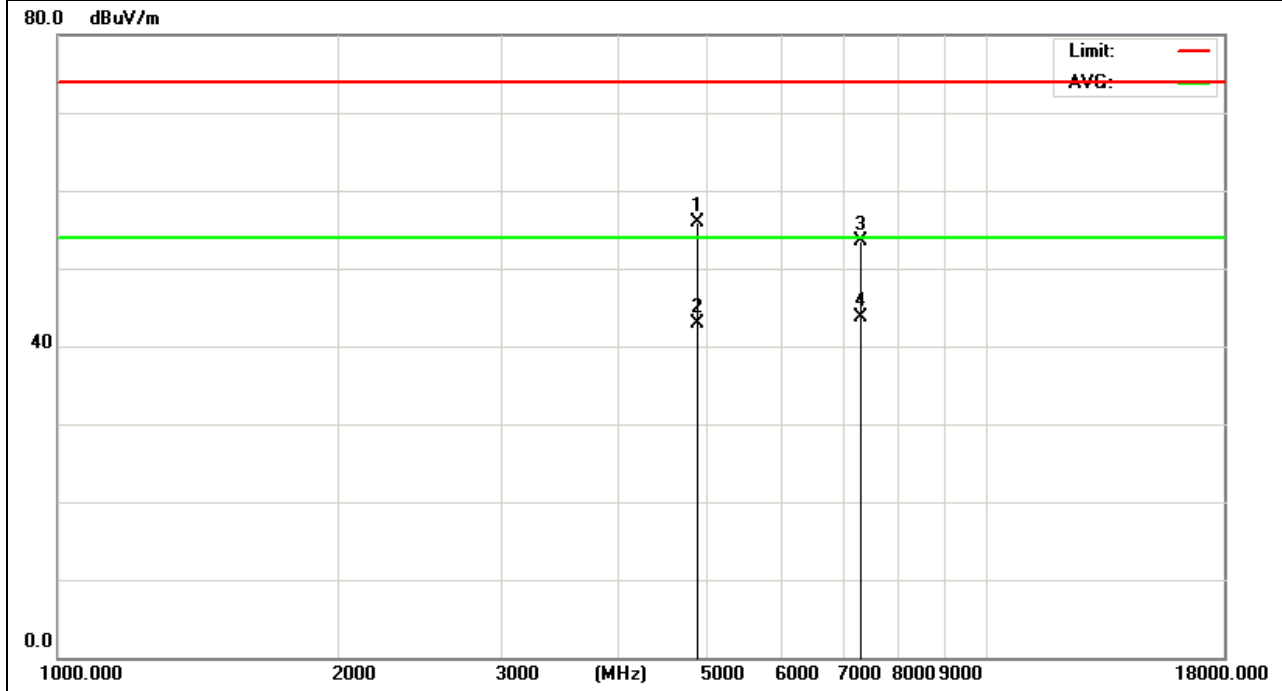

EUT :	iCarta 2 Bluetooth Stereo Speaker with bathtissue holder	Model Name :	iCarta 2
Temperature :	20 °C	Relative Humidity :	48%
Pressure :	1010 hPa	Test Voltage :	DC 6.0V
Test Mode :	TX 2441MHz – CH 39(2Mbps)	Polarization :	Vertical

Frequency (MHz)	Meter Reading (dBµV)	Factor (dB)	Emission Level (dBµV/m)	Limits (dBµV/m)	Margin (dB)	Detector Type
4882.319	62.19	-3.67	58.52	74	-15.48	peak
4882.319	49.64	-3.67	45.97	54	-8.03	AVG
7323.115	57.46	-0.82	56.64	74	-17.36	peak
7323.115	46.98	-0.82	46.16	54	-7.84	AVG

Remark:
 Factor = Antenna Factor + Cable Loss – Pre-amplifier.
 No emission detected above 18GHz

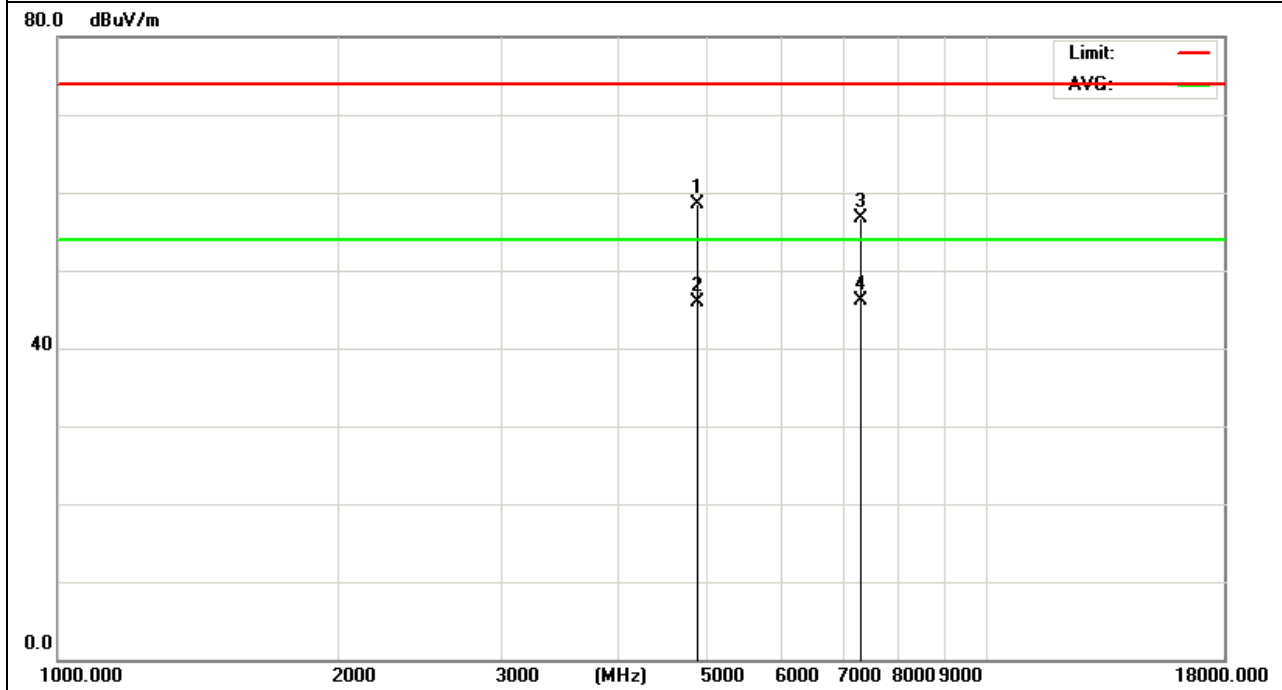

EUT :	iCarta 2 Bluetooth Stereo Speaker with bathtissue holder	Model Name :	iCarta 2
Temperature :	20 °C	Relative Humidity :	48%
Pressure :	1010 hPa	Test Voltage :	DC 6.0V
Test Mode :	TX 2480MHz – CH 78(2Mbps)	Polarization :	Horizontal

Frequency (MHz)	Meter Reading (dBµV)	Factor (dB)	Emission Level (dBµV/m)	Limits (dBµV/m)	Margin (dB)	Detector Type
4960.56	62.63	-3.6	59.03	74	-14.97	peak
4960.56	49.58	-3.6	45.98	54	-8.02	AVG
7440.105	53.75	-0.68	53.07	74	-20.93	peak
7440.105	44.69	-0.68	44.01	54	-9.99	AVG

Remark:
 Factor = Antenna Factor + Cable Loss – Pre-amplifier.
 No emission detected above 18GHz

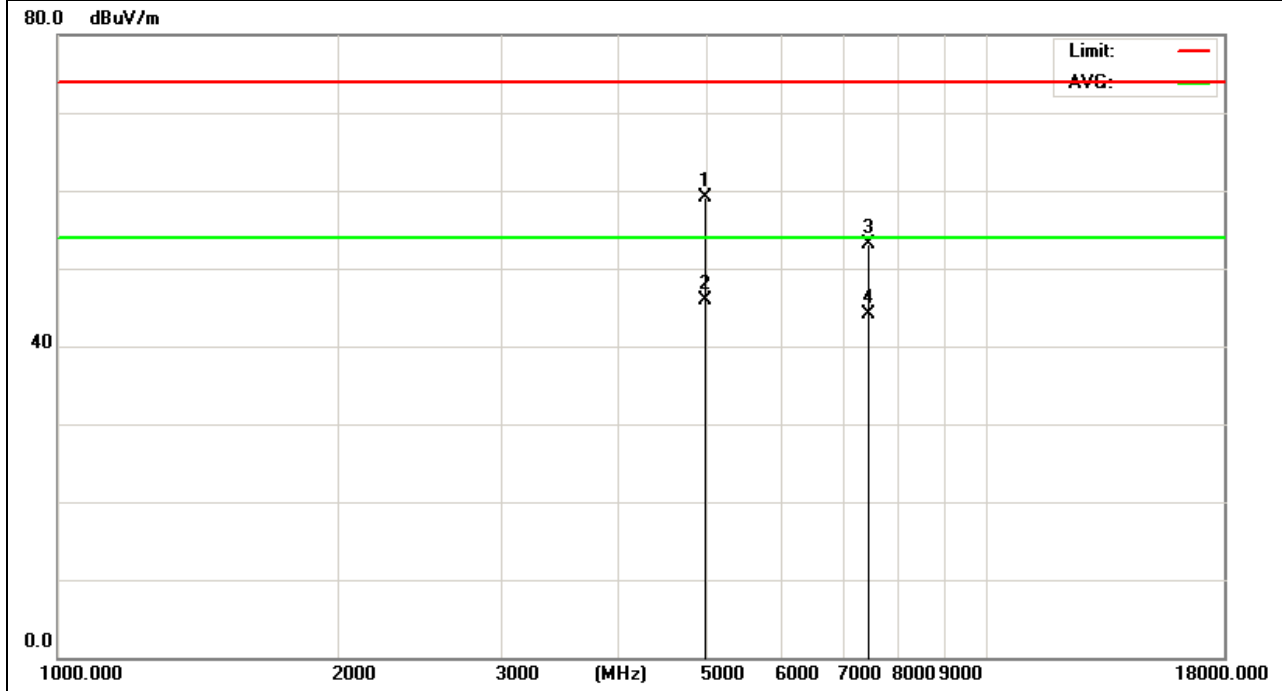

EUT :	iCarta 2 Bluetooth Stereo Speaker with bathtissue holder	Model Name :	iCarta 2
Temperature :	20 °C	Relative Humidity :	48%
Pressure :	1010 hPa	Test Voltage :	DC 6.0V
Test Mode :	TX 2480MHz – CH 78(2Mbps)	Polarization :	Vertical

Frequency (MHz)	Meter Reading (dBµV)	Factor (dB)	Emission Level (dBµV/m)	Limits (dBµV/m)	Margin (dB)	Detector Type
4960.173	62.42	-3.59	58.83	74	-15.17	peak
4960.173	50.46	-3.59	46.87	54	-7.13	AVG
7440.241	54.73	-0.68	54.05	74	-19.95	peak
7440.241	44.8	-0.68	44.12	54	-9.88	AVG

Remark:
 Factor = Antenna Factor + Cable Loss – Pre-amplifier.
 No emission detected above 18GHz

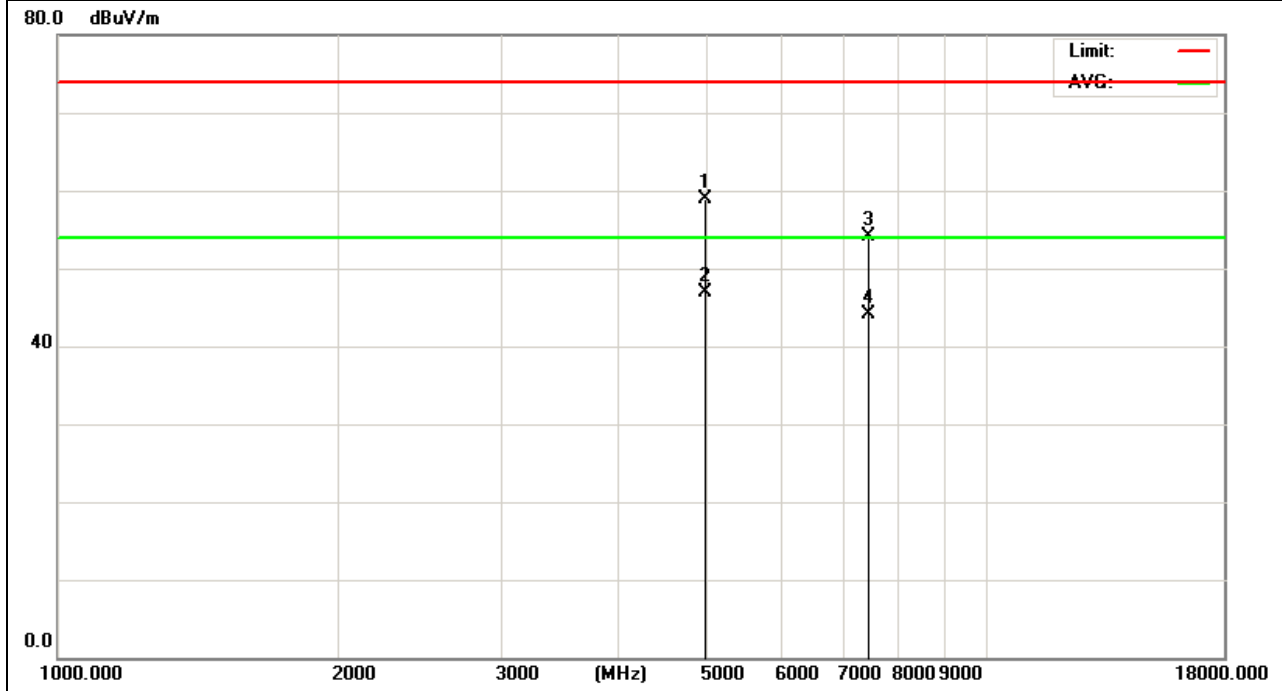

EUT :	iCarta 2 Bluetooth Stereo Speaker with bathtissue holder	Model Name :	iCarta 2
Temperature :	20 °C	Relative Humidity :	48%
Pressure :	1010 hPa	Test Voltage :	DC 6.0V
Test Mode :	TX 2402MHz – CH00 (3Mbps)	Polarization :	Horizontal

Frequency (MHz)	Meter Reading (dBµV)	Factor (dB)	Emission Level (dBµV/m)	Limits (dBµV/m)	Margin (dB)	Detector Type
4804.236	61.71	-3.64	58.07	74	-15.93	peak
4804.236	49.95	-3.64	46.31	54	-7.69	AVG
7206.322	54.79	-0.95	53.84	74	-20.16	peak
7206.322	44.37	-0.95	43.42	54	-10.58	AVG

Remark:
 Factor = Antenna Factor + Cable Loss – Pre-amplifier.
 No emission detected above 18GHz

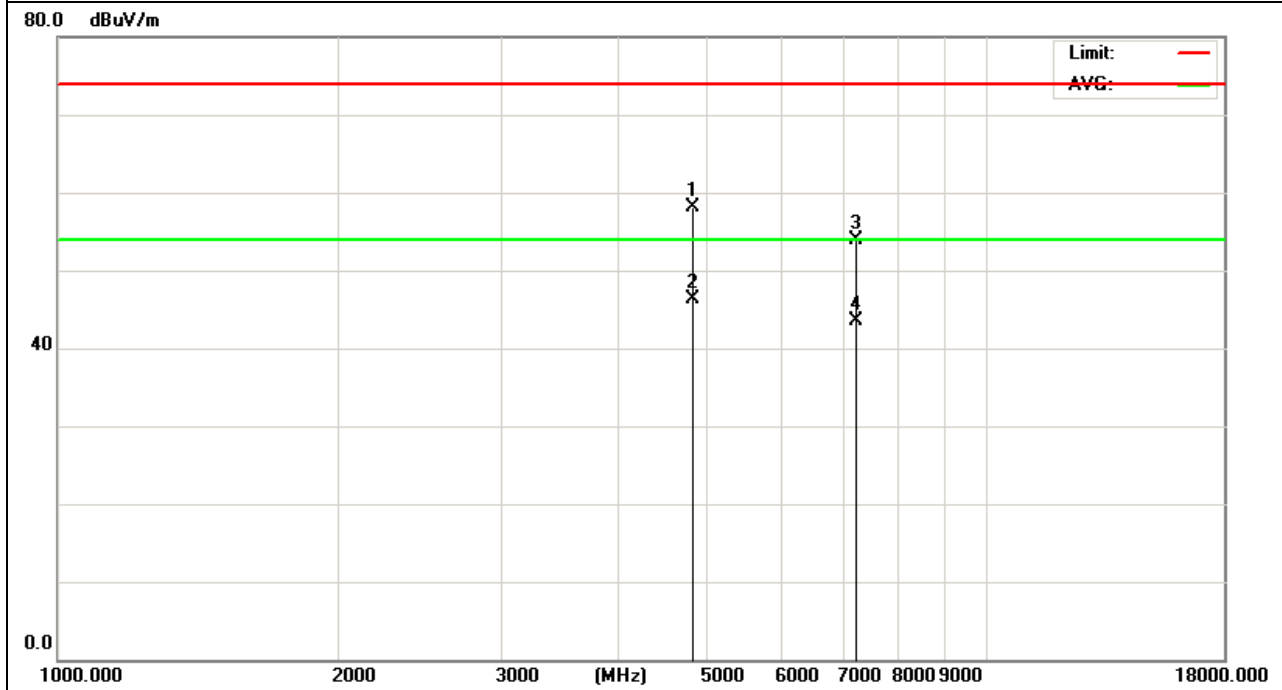

EUT :	iCarta 2 Bluetooth Stereo Speaker with bathtissue holder	Model Name :	iCarta 2
Temperature :	20 °C	Relative Humidity :	48%
Pressure :	1010 hPa	Test Voltage :	DC 6.0V
Test Mode :	TX 2402MHz – CH00 (3Mbps)	Polarization :	Vertical

Frequency (MHz)	Meter Reading (dBµV)	Factor (dB)	Emission Level (dBµV/m)	Limits (dBµV/m)	Margin (dB)	Detector Type
4804.372	60.81	-3.64	57.17	74	-16.83	peak
4804.372	51.58	-3.64	47.94	54	-6.06	AVG
7206.146	56.49	-0.95	55.54	74	-18.46	peak
7206.146	45.57	-0.95	44.62	54	-9.38	AVG

Remark:
 Factor = Antenna Factor + Cable Loss – Pre-amplifier.
 No emission detected above 18GHz

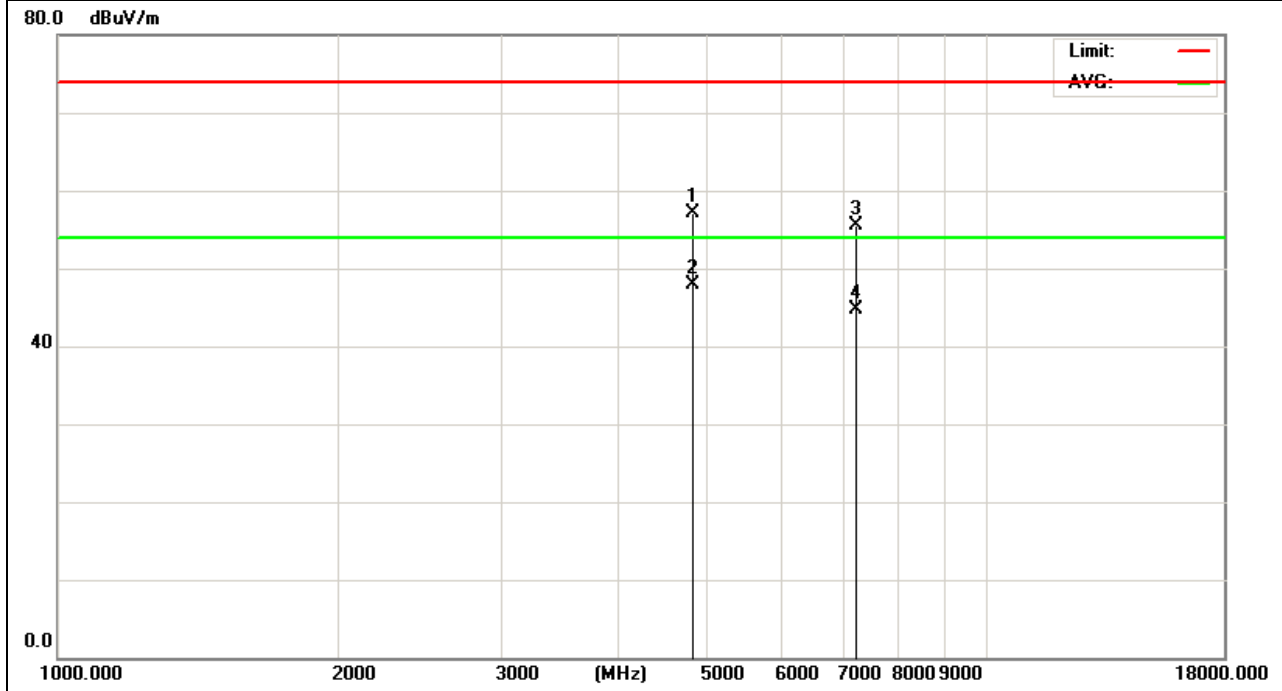

EUT :	iCarta 2 Bluetooth Stereo Speaker with bathtissue holder	Model Name :	iCarta 2
Temperature :	20 °C	Relative Humidity :	48%
Pressure :	1010 hPa	Test Voltage :	DC 6.0V
Test Mode :	TX 2441MHz – CH39(3Mbps)	Polarization :	Horizontal

Frequency (MHz)	Meter Reading (dBµV)	Factor (dB)	Emission Level (dBµV/m)	Limits (dBµV/m)	Margin (dB)	Detector Type
4882.384	62.5	-3.67	58.83	74	-15.17	peak
4882.384	49.66	-3.67	45.99	54	-8.01	AVG
7323.448	53.87	-0.82	53.05	74	-20.95	peak
7323.448	44.33	-0.82	43.51	54	-10.49	AVG

Remark:
 Factor = Antenna Factor + Cable Loss – Pre-amplifier.
 No emission detected above 18GHz

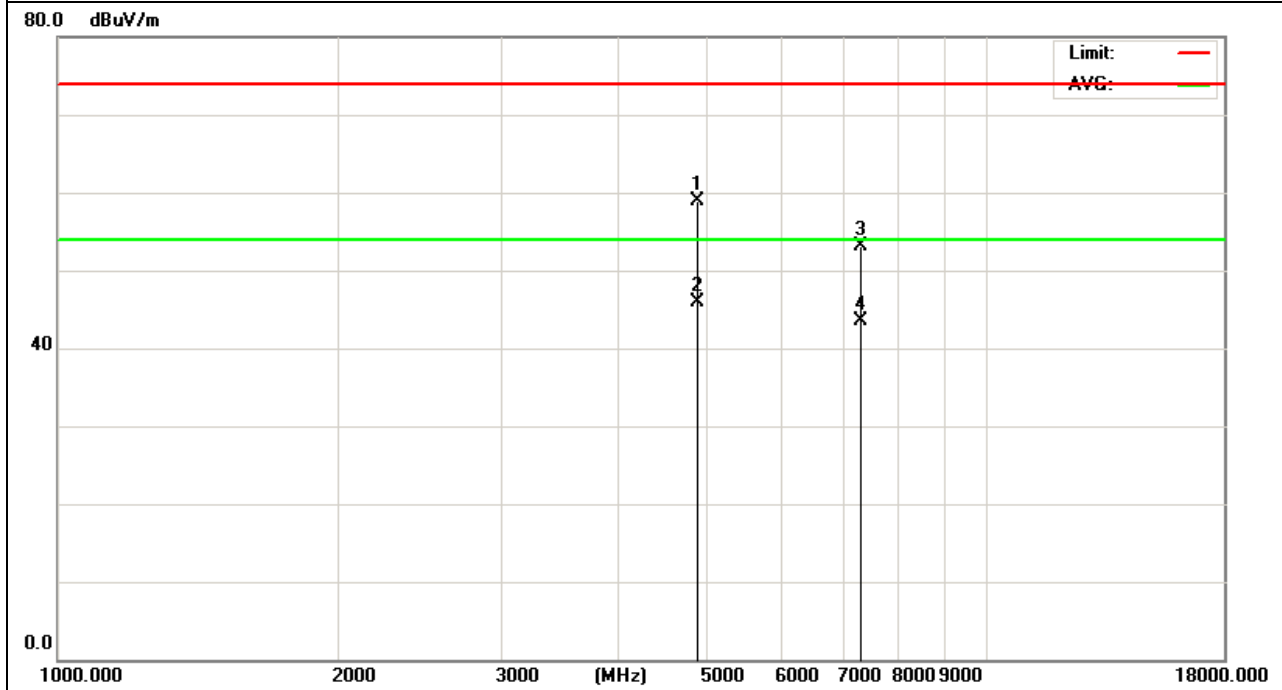

EUT :	iCarta 2 Bluetooth Stereo Speaker with bathtissue holder	Model Name :	iCarta 2
Temperature :	20 °C	Relative Humidity :	48%
Pressure :	1010 hPa	Test Voltage :	DC 6.0V
Test Mode :	TX 2441MHz – CH39 (3Mbps)	Polarization :	Vertical

Frequency (MHz)	Meter Reading (dBµV)	Factor (dB)	Emission Level (dBµV/m)	Limits (dBµV/m)	Margin (dB)	Detector Type
4882.642	61.46	-3.67	57.79	74	-16.21	peak
4882.642	47.58	-3.67	43.91	54	-10.09	AVG
7323.213	54.46	-0.82	53.64	74	-20.36	peak
7323.213	42.95	-0.82	42.13	54	-11.87	AVG

Remark:
 Factor = Antenna Factor + Cable Loss – Pre-amplifier.
 No emission detected above 18GHz

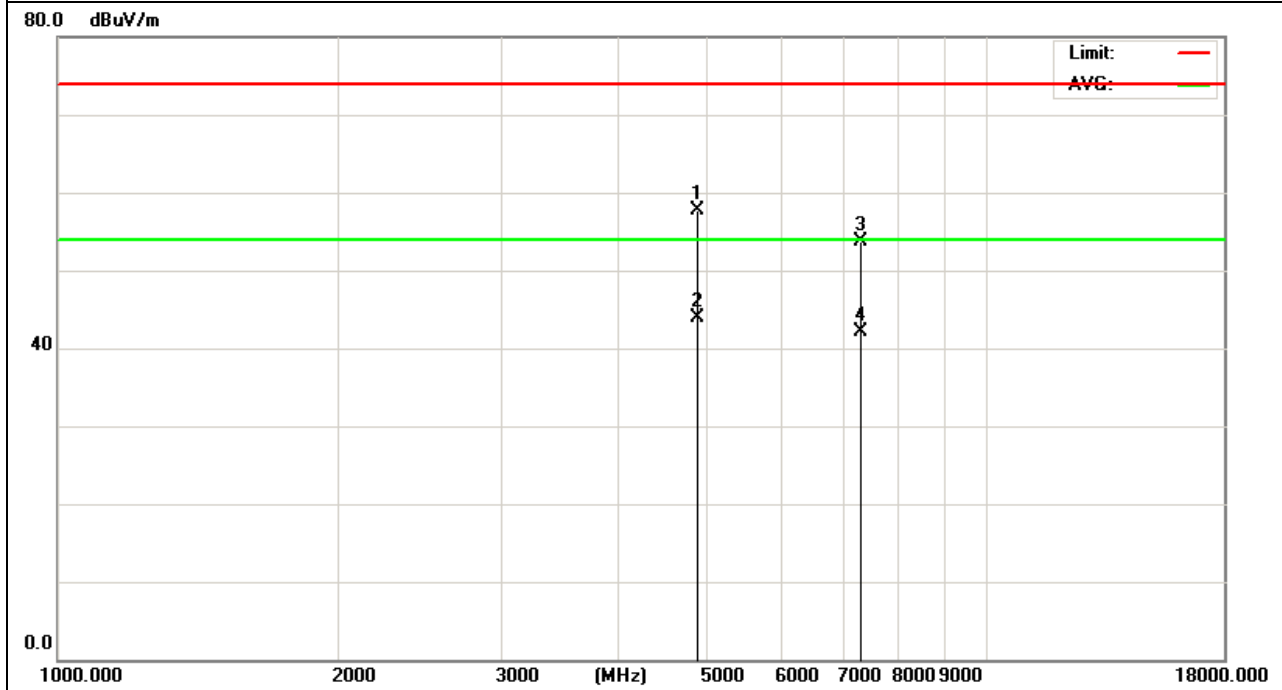

EUT :	iCarta 2 Bluetooth Stereo Speaker with bathtissue holder	Model Name :	iCarta 2
Temperature :	20 °C	Relative Humidity :	48%
Pressure :	1010 hPa	Test Voltage :	DC 6.0V
Test Mode :	TX 2480MHz – CH78 (3Mbps)	Polarization :	Horizontal

Frequency (MHz)	Meter Reading (dBµV)	Factor (dB)	Emission Level (dBµV/m)	Limits (dBµV/m)	Margin (dB)	Detector Type
4960.372	61.47	-3.59	57.88	74	-16.12	peak
4960.372	50.65	-3.59	47.06	54	-6.94	AVG
7440.254	54.74	-0.68	54.06	74	-19.94	peak
7440.254	44.84	-0.68	44.16	54	-9.84	AVG

Remark:
 Factor = Antenna Factor + Cable Loss – Pre-amplifier.
 No emission detected above 18GHz

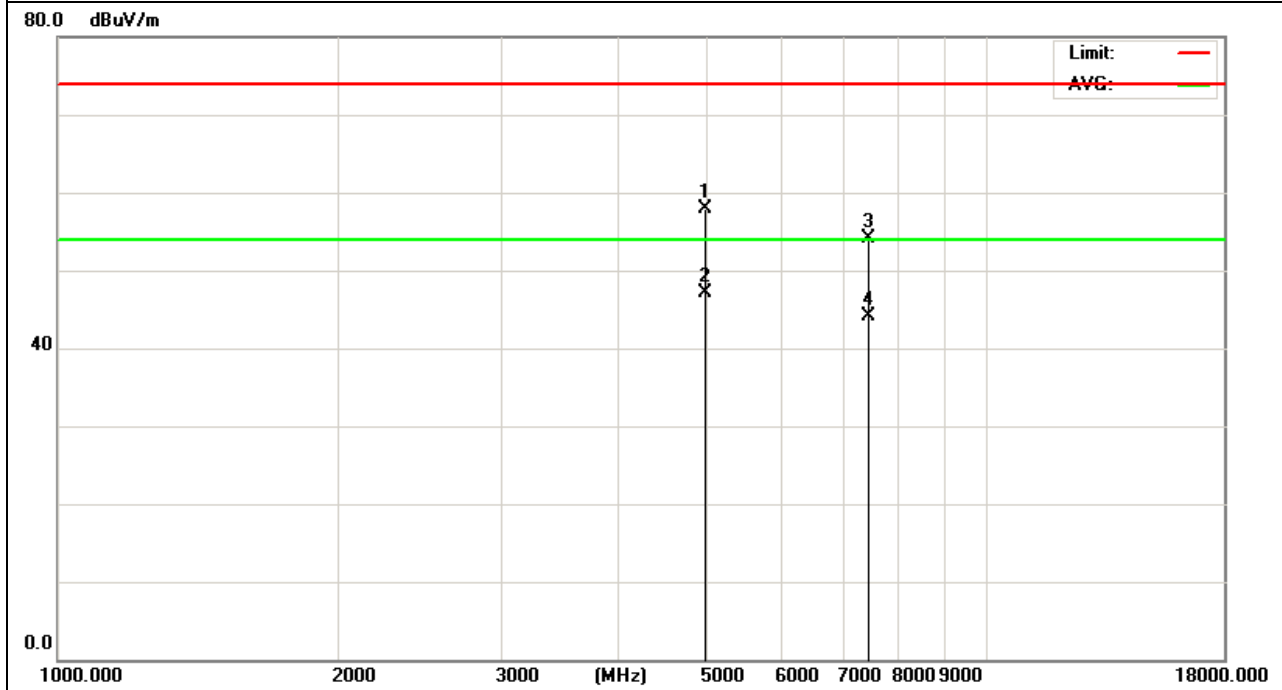

EUT :	iCarta 2 Bluetooth Stereo Speaker with bathtissue holder	Model Name :	iCarta 2
Temperature :	20 °C	Relative Humidity :	48%
Pressure :	1010 hPa	Test Voltage :	DC 6.0V
Test Mode :	TX 2480MHz – CH78 (3Mbps)	Polarization :	Vertical

Frequency (MHz)	Meter Reading (dBµV)	Factor (dB)	Emission Level (dBµV/m)	Limits (dBµV/m)	Margin (dB)	Detector Type
4960.241	62.92	-3.59	59.33	74	-14.67	peak
4960.241	51.89	-3.59	48.3	54	-5.7	AVG
7440.864	59.06	-0.68	58.38	74	-15.62	peak
7440.864	45.15	-0.68	44.47	54	-9.53	AVG

Remark:
 Factor = Antenna Factor + Cable Loss – Pre-amplifier.
 No emission detected above 18GHz

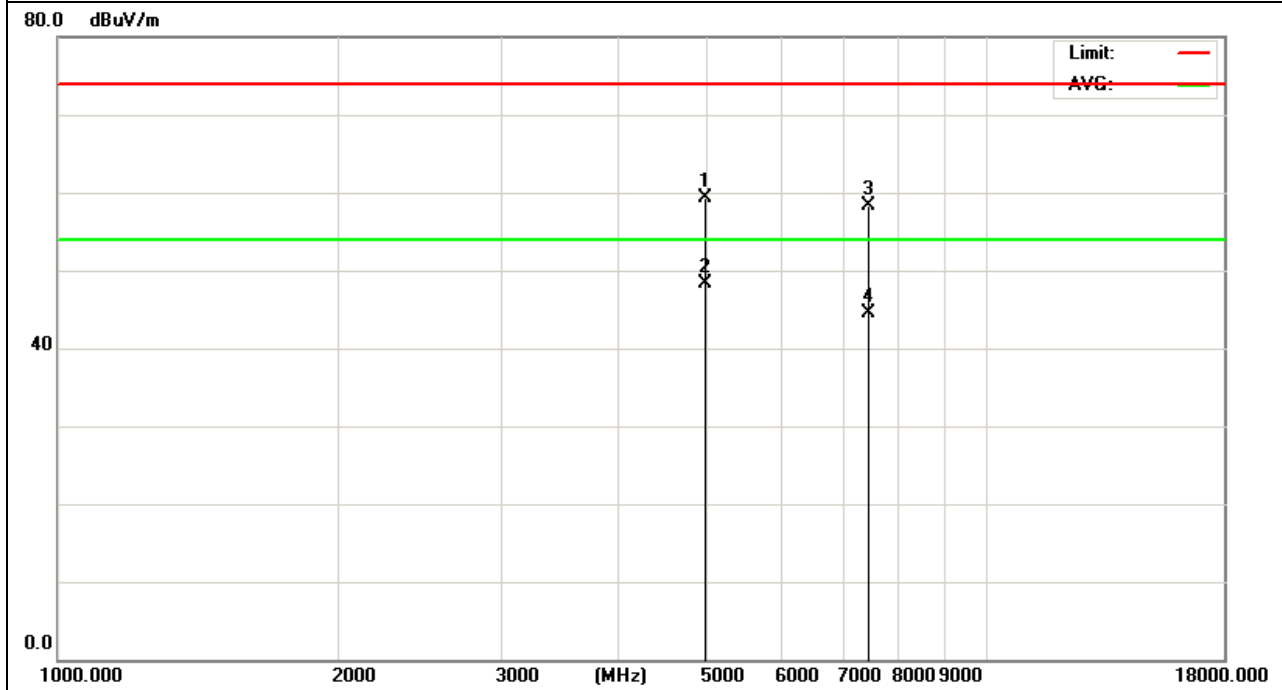

3.2.9 TEST RESULTS (RESTRICTED BANDS REQUIREMENTS)

EUT :	iCarta 2 Bluetooth Stereo Speaker with bathtissue holder	Model Name :	iCarta 2
Temperature :	20 °C	Relative Humidity :	48%
Pressure :	1010 hPa	Test Voltage :	DC 6.0V
Test Mode :	TX /2402MHz-1Mbps	Polarization :	Vertical

Frequency (MHz)	Meter Reading (dBµV)	Factor (dB)	Emission Level (dBµV/m)	Limits (dBµV/m)	Margin (dB)	Detector Type
2400	68.09	-12.99	55.1	74	-18.9	peak
2400	57.21	-12.99	44.22	54	-9.78	AVG

Remark:
Factor = Antenna Factor + Cable Loss – Pre-amplifier.

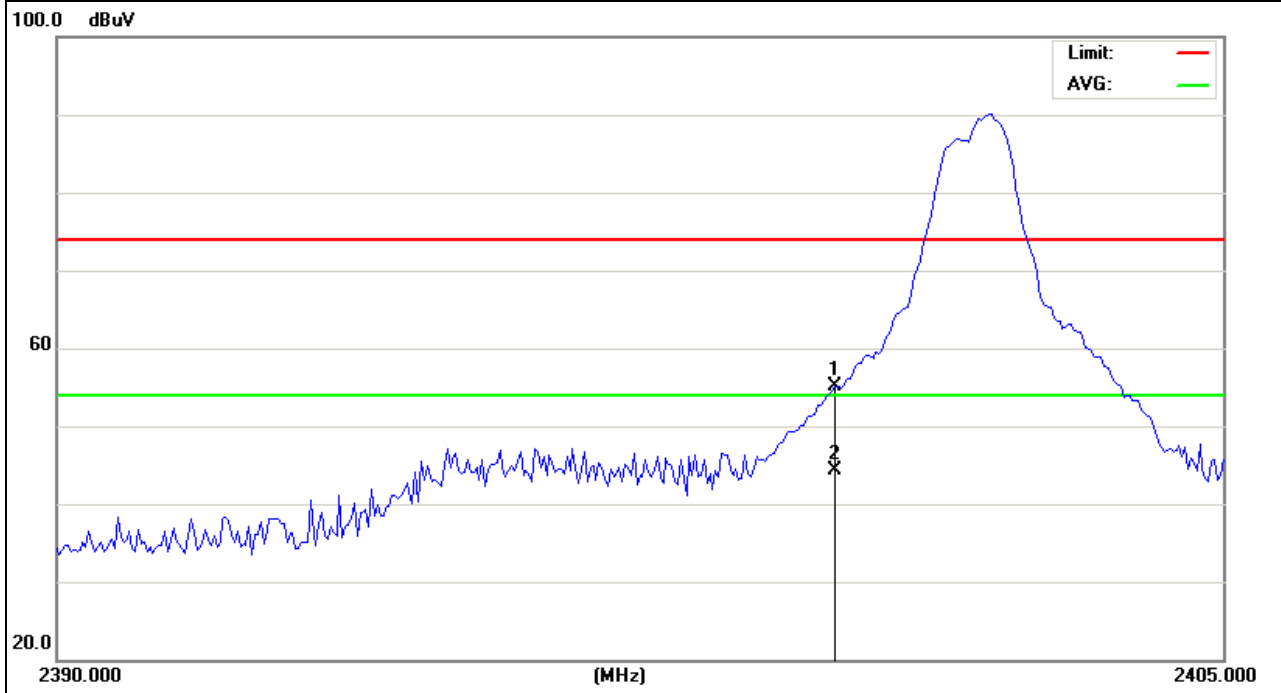

EUT :	iCarta 2 Bluetooth Stereo Speaker with bathtissue holder	Model Name :	iCarta 2
Temperature :	20 °C	Relative Humidity :	48%
Pressure :	1010 hPa	Test Voltage :	DC 6.0V
Test Mode :	TX /2402MHz-1Mbps	Polarization :	Horizontal

Frequency (MHz)	Meter Reading (dBµV)	Factor (dB)	Emission Level (dBµV/m)	Limits (dBµV/m)	Margin (dB)	Detector Type
2400	68.09	-12.99	55.1	74	-18.9	peak
2400	57.21	-12.99	44.22	54	-9.78	AVG

Remark:
 Factor = Antenna Factor + Cable Loss – Pre-amplifier.

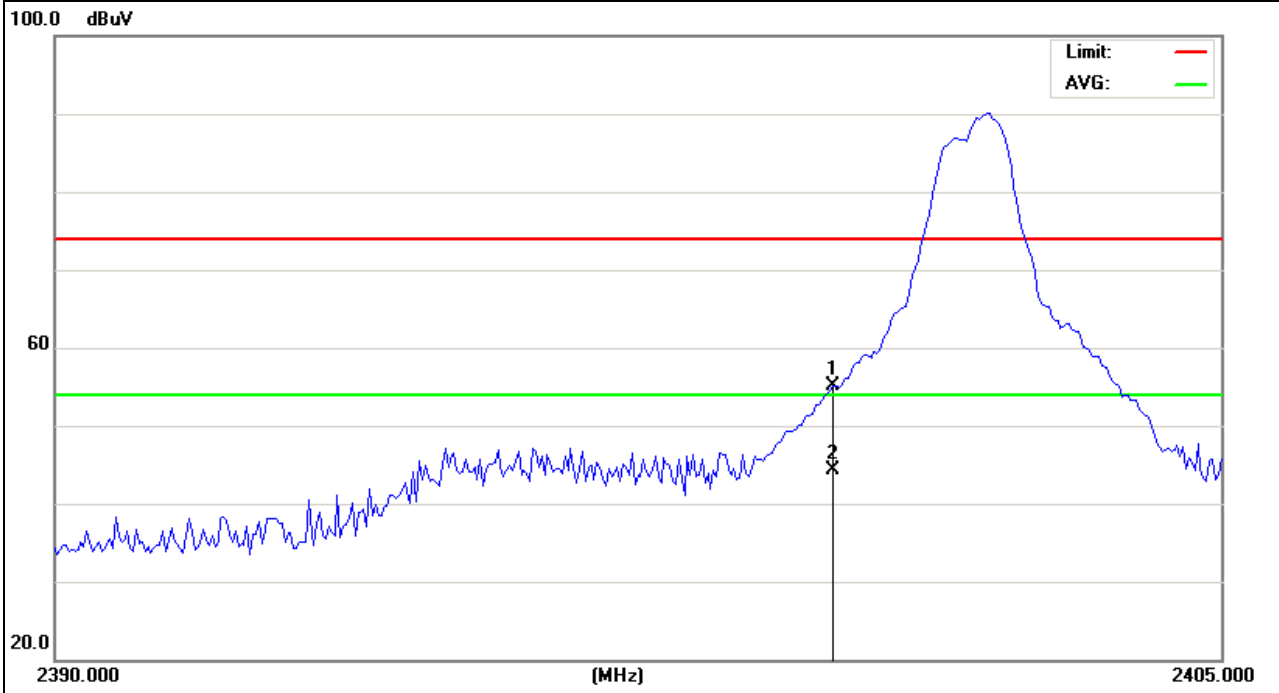

EUT :	iCarta 2 Bluetooth Stereo Speaker with bathtissue holder	Model Name :	iCarta 2
Temperature :	20 °C	Relative Humidity :	48%
Pressure :	1010 hPa	Test Voltage :	DC 6.0V
Test Mode :	TX /2480MHz-1Mbps	Polarization :	Vertical

Frequency (MHz)	Meter Reading (dBµV)	Factor (dB)	Emission Level (dBµV/m)	Limits (dBµV/m)	Margin (dB)	Detector Type
2483.5	48.06	-12.78	35.28	74	-38.72	peak

Remark:
 Factor = Antenna Factor + Cable Loss – Pre-amplifier.

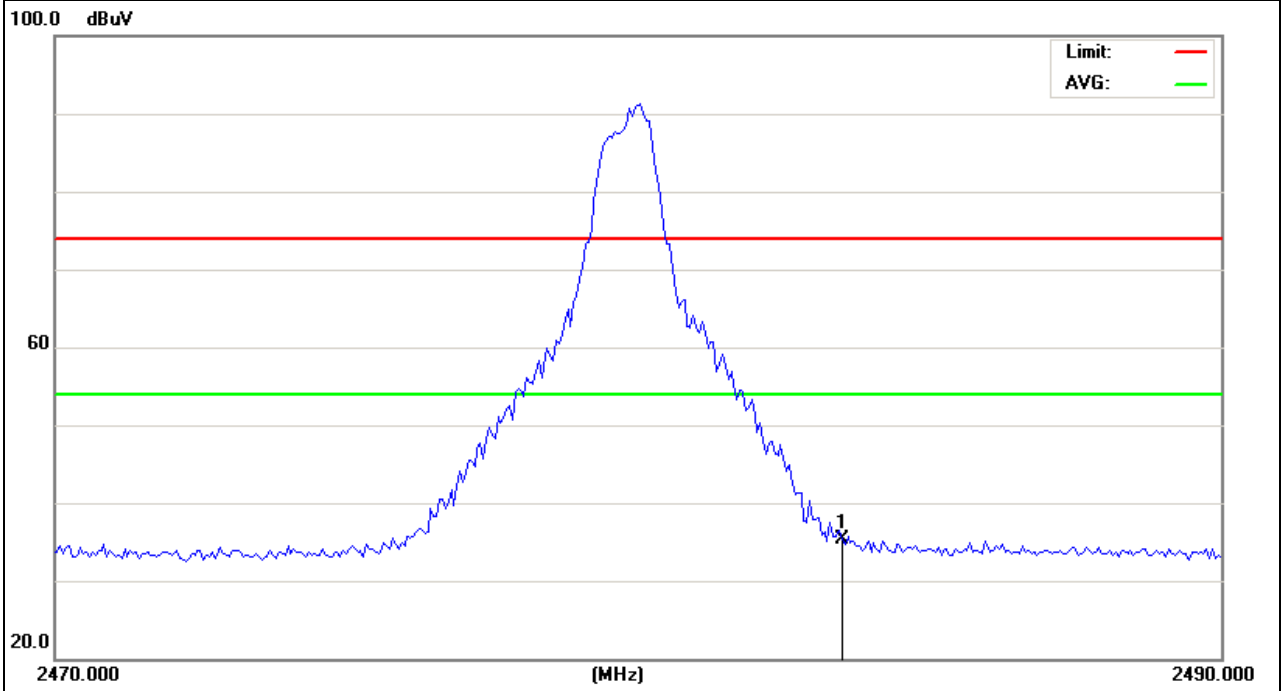

EUT :	iCarta 2 Bluetooth Stereo Speaker with bathtissue holder	Model Name :	iCarta 2
Temperature :	20 °C	Relative Humidity :	48%
Pressure :	1010 hPa	Test Voltage :	DC 6.0V
Test Mode :	TX /2480MHz-1Mbps	Polarization :	Horizontal

Frequency (MHz)	Meter Reading (dBμV)	Factor (dB)	Emission Level (dBμV/m)	Limits (dBμV/m)	Margin (dB)	Detector Type
2483.5	48.65	-12.78	35.87	74	-38.13	peak

Remark:
 Factor = Antenna Factor + Cable Loss – Pre-amplifier.

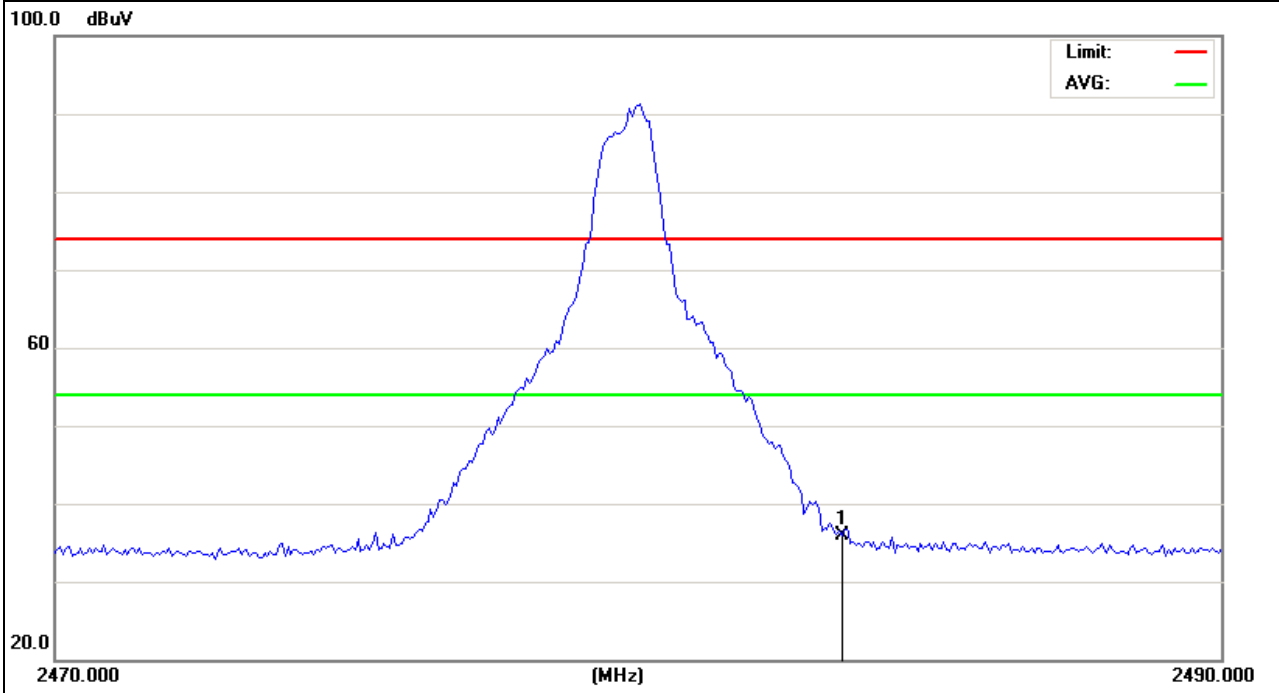

EUT :	iCarta 2 Bluetooth Stereo Speaker with bathtissue holder	Model Name :	iCarta 2
Temperature :	20 °C	Relative Humidity :	48%
Pressure :	1010 hPa	Test Voltage :	DC 6.0V
Test Mode :	TX /2402MHz-2Mbps	Polarization :	Vertical

Frequency (MHz)	Meter Reading (dBµV)	Factor (dB)	Emission Level (dBµV/m)	Limits (dBµV/m)	Margin (dB)	Detector Type
2400	68.07	-12.99	55.08	74	-18.92	peak
2400	58.74	-12.99	45.75	54	-8.25	AVG

Remark:
 Factor = Antenna Factor + Cable Loss – Pre-amplifier.

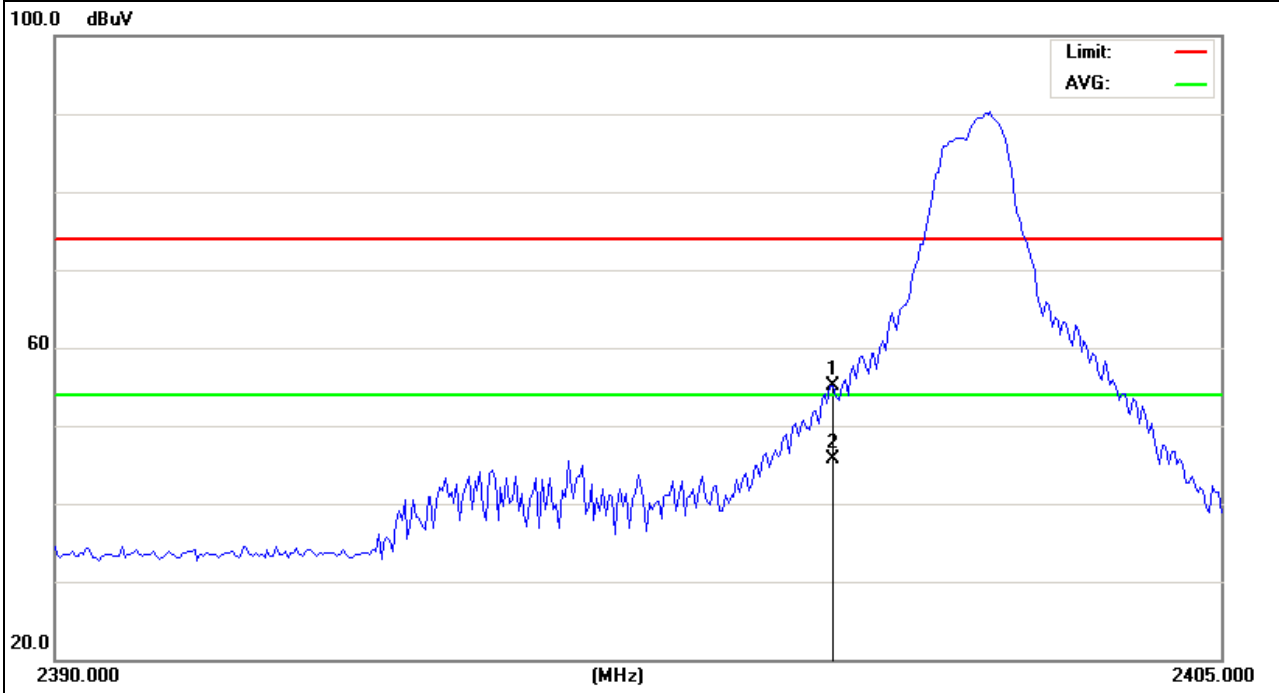

EUT :	iCarta 2 Bluetooth Stereo Speaker with bathtissue holder	Model Name :	iCarta 2
Temperature :	20 °C	Relative Humidity :	48%
Pressure :	1010 hPa	Test Voltage :	DC 6.0V
Test Mode :	TX /2402MHz-2Mbps	Polarization :	Horizontal

Frequency (MHz)	Meter Reading (dBµV)	Factor (dB)	Emission Level (dBµV/m)	Limits (dBµV/m)	Margin (dB)	Detector Type
2400	69.09	-12.99	56.1	74	-17.9	peak
2400	58.88	-12.99	45.89	54	-8.11	AVG

Remark:
 Factor = Antenna Factor + Cable Loss – Pre-amplifier.

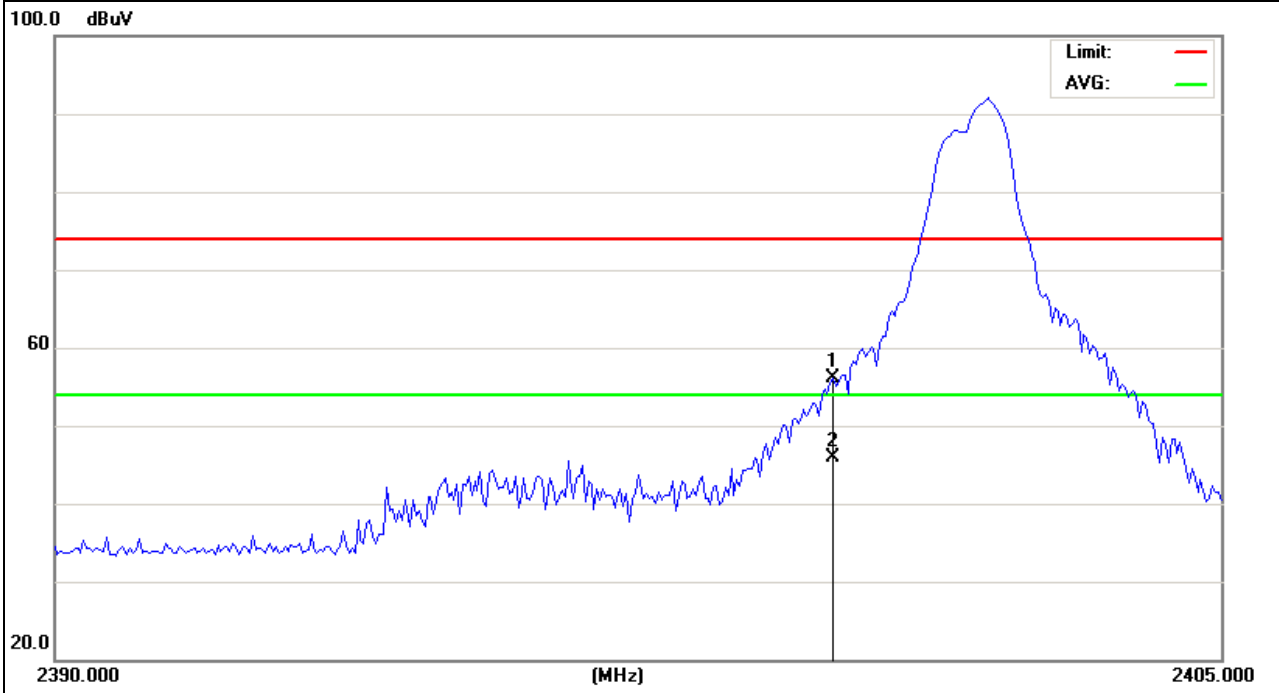

EUT :	iCarta 2 Bluetooth Stereo Speaker with bathtissue holder	Model Name :	iCarta 2
Temperature :	20 °C	Relative Humidity :	48%
Pressure :	1010 hPa	Test Voltage :	DC 6.0V
Test Mode :	TX /2480MHz-2Mbps	Polarization :	Vertical

Frequency (MHz)	Meter Reading (dBµV)	Factor (dB)	Emission Level (dBµV/m)	Limits (dBµV/m)	Margin (dB)	Detector Type
2483.5	47.85	-12.78	35.07	74	-38.93	peak

Remark:
 Factor = Antenna Factor + Cable Loss – Pre-amplifier.

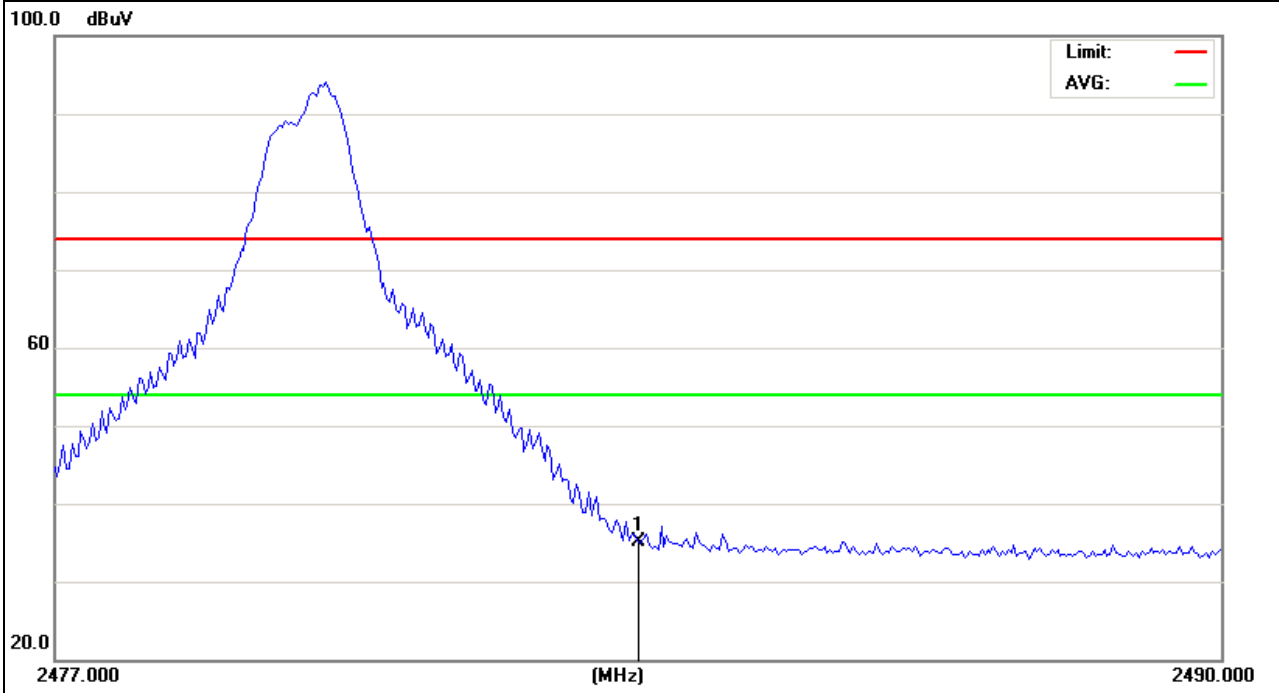

EUT :	iCarta 2 Bluetooth Stereo Speaker with bathtissue holder	Model Name :	iCarta 2
Temperature :	20 °C	Relative Humidity :	48%
Pressure :	1010 hPa	Test Voltage :	DC 6.0V
Test Mode :	TX /2480MHz-2Mbps	Polarization :	Horizontal

Frequency (MHz)	Meter Reading (dBµV)	Factor (dB)	Emission Level (dBµV/m)	Limits (dBµV/m)	Margin (dB)	Detector Type
2483.5	49.52	-12.78	36.74	74	-37.26	peak

Remark:
 Factor = Antenna Factor + Cable Loss – Pre-amplifier.

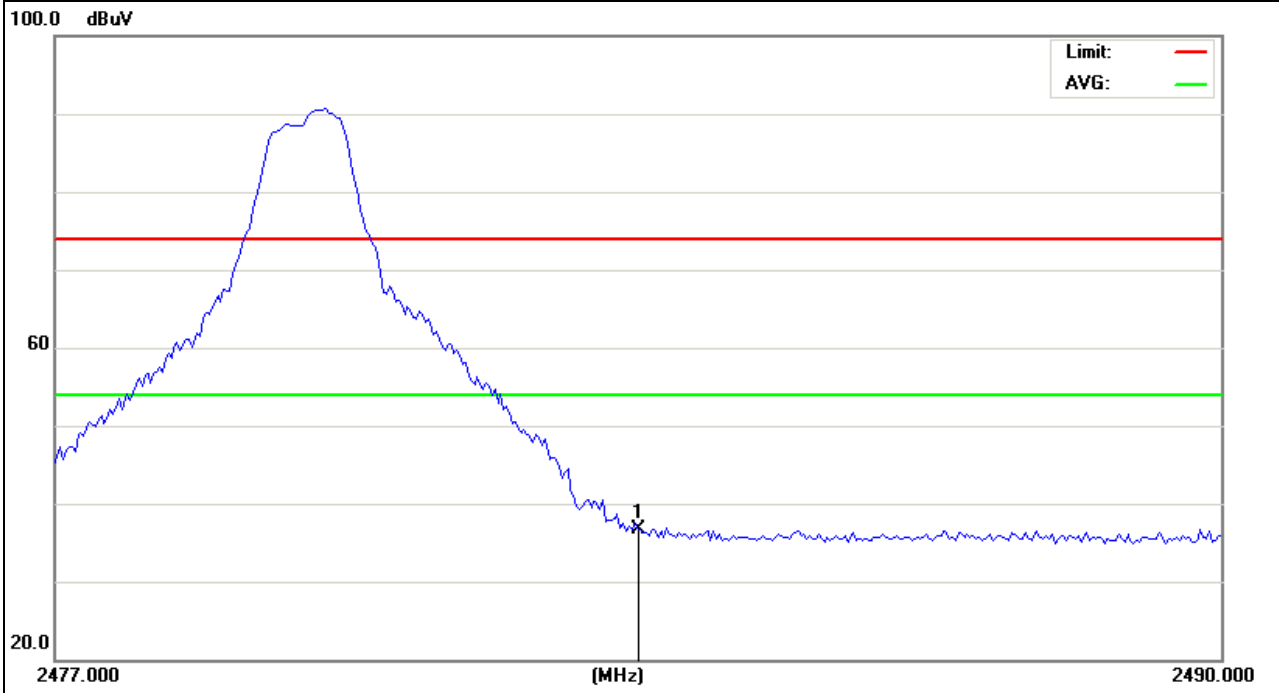

EUT :	iCarta 2 Bluetooth Stereo Speaker with bathtissue holder	Model Name :	iCarta 2
Temperature :	20 °C	Relative Humidity :	48%
Pressure :	1010 hPa	Test Voltage :	DC 6.0V
Test Mode :	TX /2402MHz-3Mbps	Polarization :	Vertical

Frequency (MHz)	Meter Reading (dBµV)	Factor (dB)	Emission Level (dBµV/m)	Limits (dBµV/m)	Margin (dB)	Detector Type
2400	68.93	-12.99	55.94	74	-18.06	peak
2400	59.12	-12.99	46.13	54	-7.87	AVG

Remark:
 Factor = Antenna Factor + Cable Loss – Pre-amplifier.

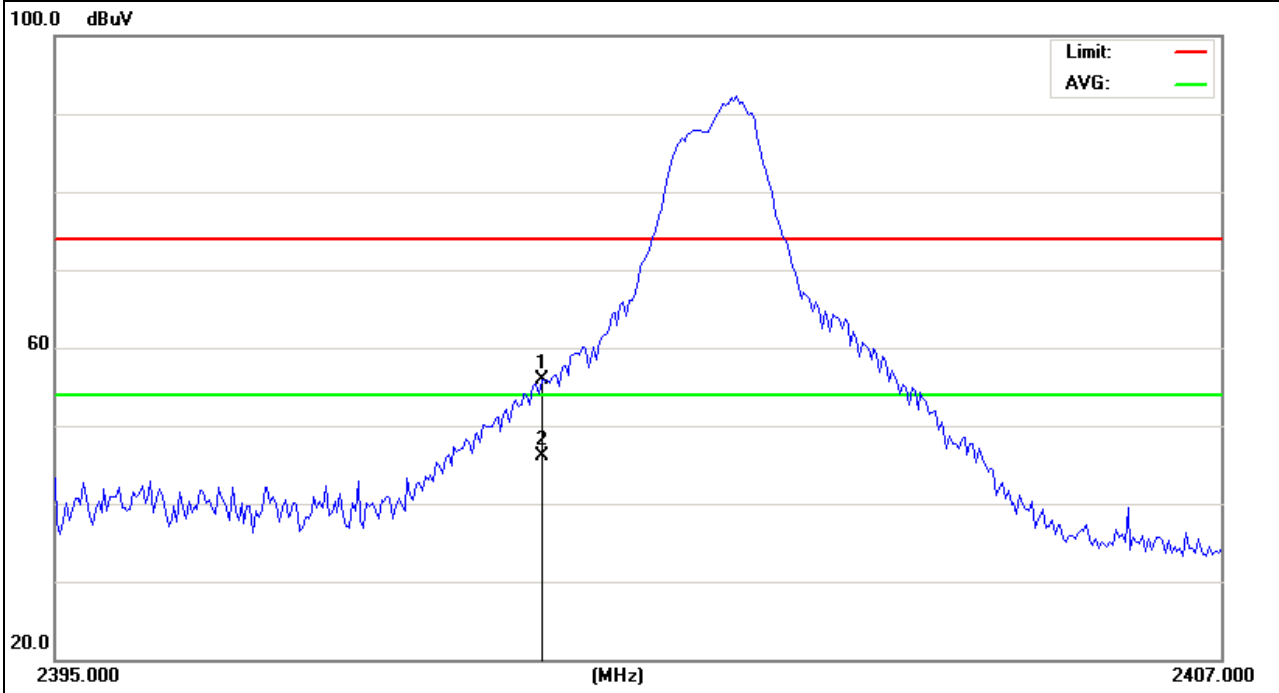

EUT :	iCarta 2 Bluetooth Stereo Speaker with bathtissue holder	Model Name :	iCarta 2
Temperature :	20 °C	Relative Humidity :	48%
Pressure :	1010 hPa	Test Voltage :	DC 6.0V
Test Mode :	TX /2402MHz-3Mbps	Polarization :	Horizontal

Frequency (MHz)	Meter Reading (dBµV)	Factor (dB)	Emission Level (dBµV/m)	Limits (dBµV/m)	Margin (dB)	Detector Type
2400	68.93	-12.99	55.94	74	-18.06	peak
2400	59.84	-12.99	46.85	54	-7.15	AVG

Remark:
 Factor = Antenna Factor + Cable Loss – Pre-amplifier.

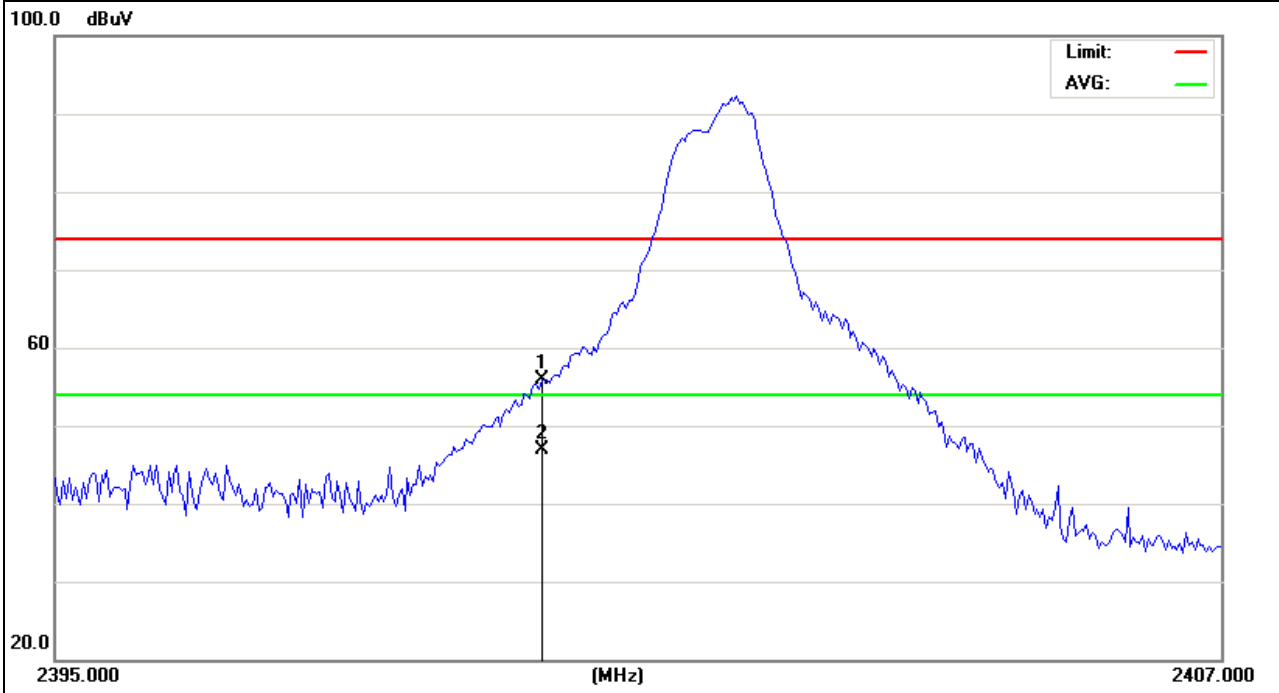

EUT :	iCarta 2 Bluetooth Stereo Speaker with bathtissue holder	Model Name :	iCarta 2
Temperature :	20 °C	Relative Humidity :	48%
Pressure :	1010 hPa	Test Voltage :	DC 6.0V
Test Mode :	TX /2480MHz-3Mbps	Polarization :	Vertical

Frequency (MHz)	Meter Reading (dBµV)	Factor (dB)	Emission Level (dBµV/m)	Limits (dBµV/m)	Margin (dB)	Detector Type
2483.5	48.33	-12.78	35.55	74	-38.45	peak

Remark:
 Factor = Antenna Factor + Cable Loss – Pre-amplifier.

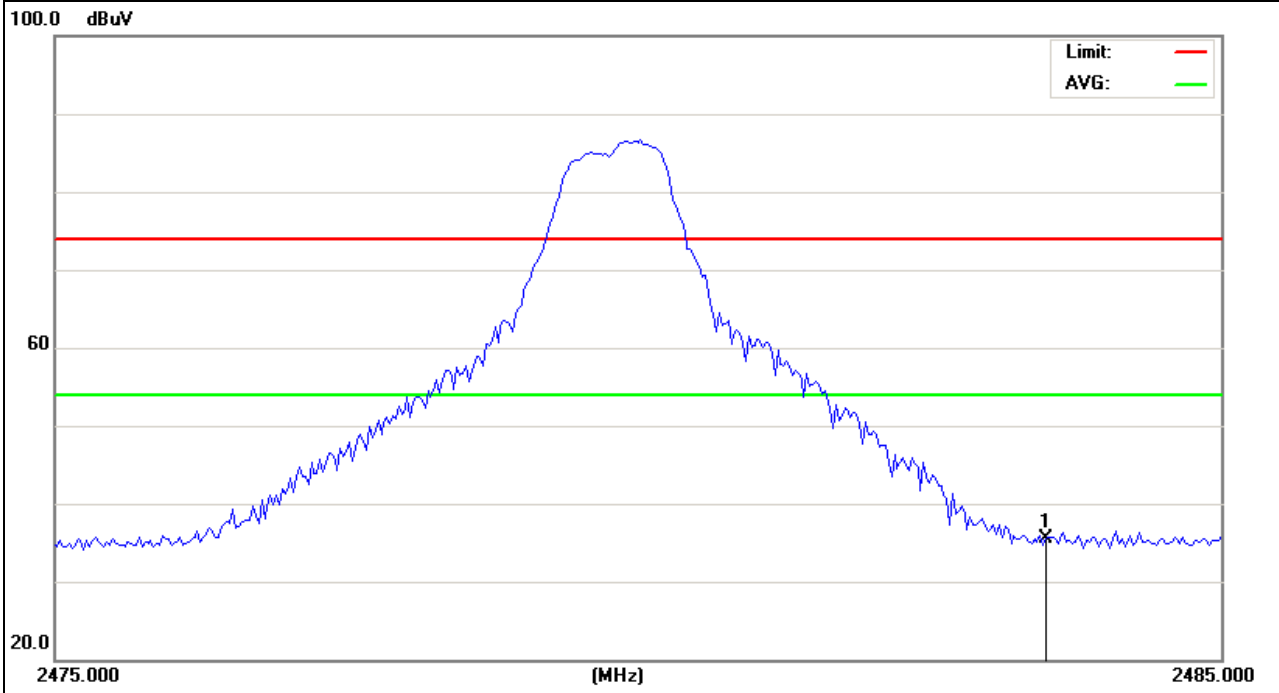

EUT :	iCarta 2 Bluetooth Stereo Speaker with bathtissue holder	Model Name :	iCarta 2
Temperature :	20 °C	Relative Humidity :	48%
Pressure :	1010 hPa	Test Voltage :	DC 6.0V
Test Mode :	TX /2480MHz-3Mbps	Polarization :	Horizontal

Frequency (MHz)	Meter Reading (dBµV)	Factor (dB)	Emission Level (dBµV/m)	Limits (dBµV/m)	Margin (dB)	Detector Type
2483.5	49.52	-12.78	36.74	74	-37.26	peak

Remark:
 Factor = Antenna Factor + Cable Loss – Pre-amplifier.

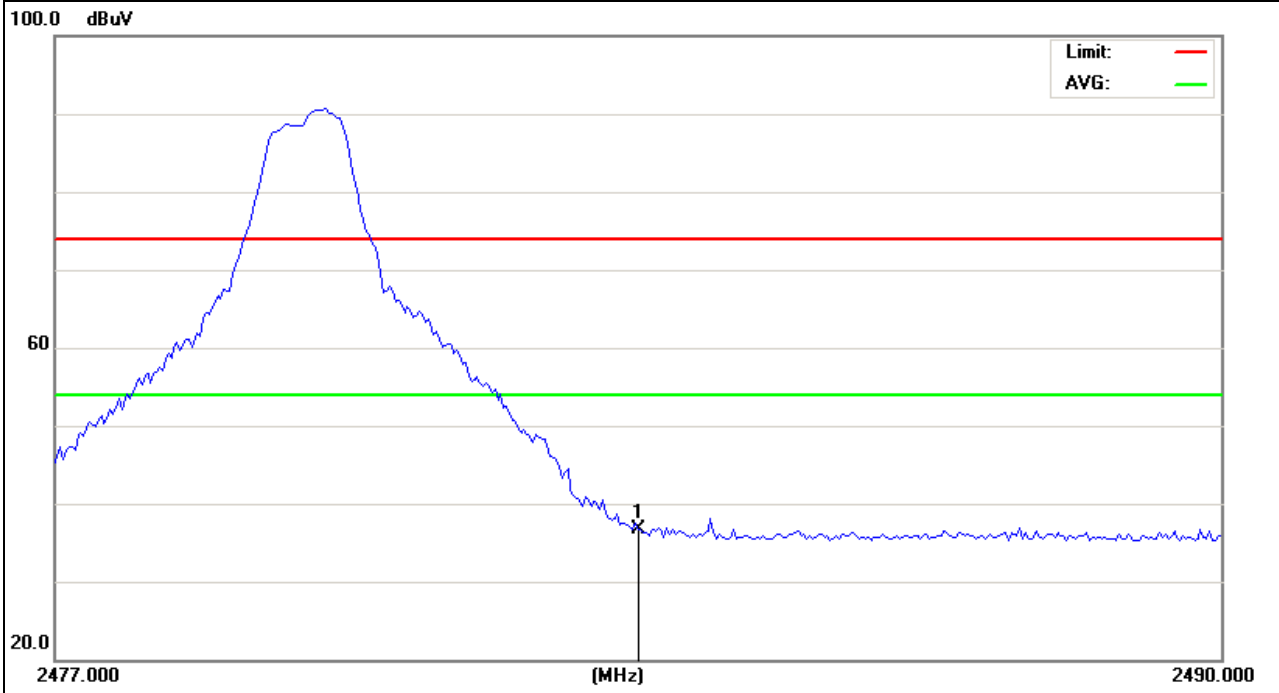

4. NUMBER OF HOPPING CHANNEL

4.1 APPLIED PROCEDURES / LIMIT

FCC Part15 (15.247) , Subpart C				
Section	Test Item	Limit	Frequency Range (MHz)	Result
15.247 (a)(1)(iii)	Number of Hopping Channel	≥15	2400-2483.5	PASS

Spectrum Parameters	Setting
Attenuation	Auto
Span Frequency	> Operating Frequency Range
RB	100 kHz
VB	100 kHz
Detector	Peak
Trace	Max Hold
Sweep Time	Auto

4.1.1 TEST PROCEDURE

- a. The EUT was directly connected to the spectrum analyzer and antenna output port as show in the block diagram below,
- b. Spectrum Setting : RBW= 100KHz, VBW=100KHz, Sweep time = Auto.

4.1.2 DEVIATION FROM STANDARD

No deviation.

4.1.3 TEST SETUP



4.1.4 EUT OPERATION CONDITIONS

The EUT tested system was configured as the statements of 2.4 Unless otherwise a special operating condition is specified in the follows during the testing.

4.1.5 TEST RESULTS

EUT :	iCarta 2 Bluetooth Stereo Speaker with bathtissue holder	Model Name :	iCarta 2
Temperature :	25 °C	Relative Humidity :	60%
Pressure :	1015 hPa	Test Voltage :	DC 6.0V
Test Mode :	Hopping Mode		

Number of Hopping Channel	79
---------------------------	----

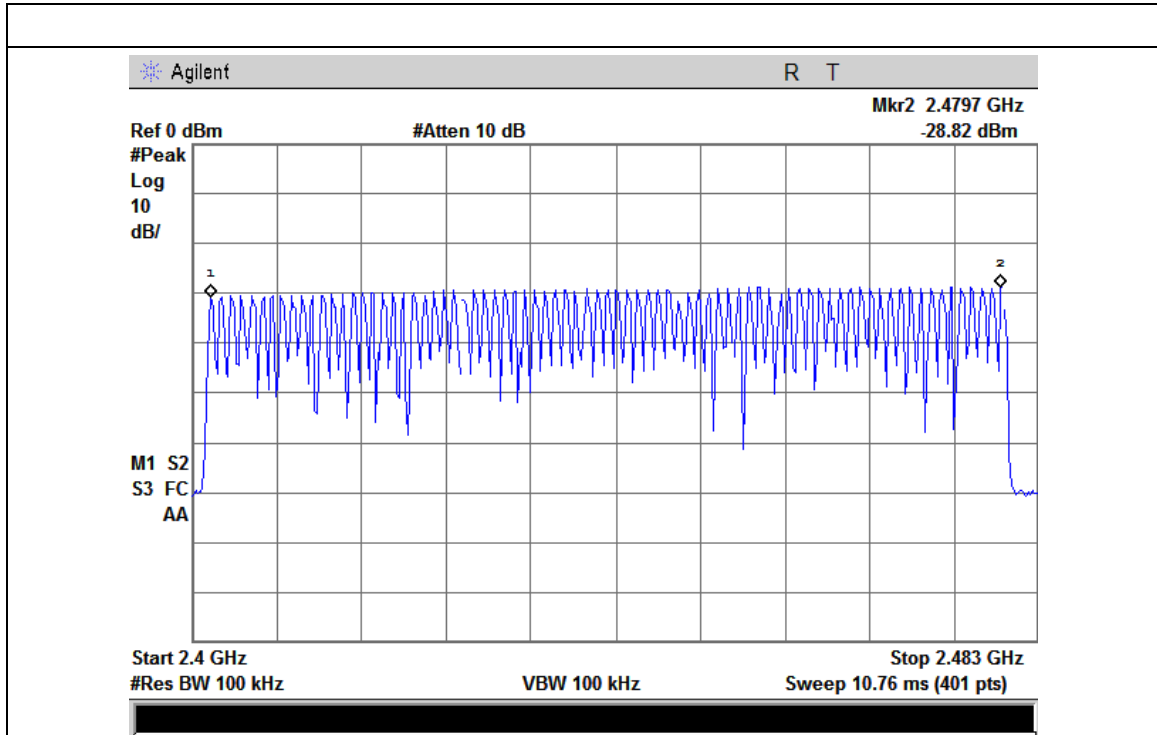

5. AVERAGE TIME OF OCCUPANCY

5.1 APPLIED PROCEDURES / LIMIT

FCC Part15 (15.247) , Subpart C				
Section	Test Item	Limit	Frequency Range (MHz)	Result
15.247 (a)(1)(iii)	Average Time of Occupancy	0.4sec	2400-2483.5	PASS

5.1.1 TEST PROCEDURE

- a. The transmitter output (antenna port) was connected to the spectrum analyzer
- b. Set RBW of spectrum analyzer to 1MHz and VBW to 1MHz.
- c. Use a video trigger with the trigger level set to enable triggering only on full pulses.
- d. Sweep Time is more than once pulse time.
- e. Set the center frequency on any frequency would be measure and set the frequency span to zero span.
- f. Measure the maximum time duration of one single pulse.
- g. Set the EUT for DH5, DH3 and DH1 packet transmitting.
- h. Measure the maximum time duration of one single pulse.
- i. A Period Time = (channel number)*0.4
 - DH1 Time Slot: Reading * (1600/2)*31.6/(channel number)
 - DH3 Time Slot: Reading * (1600/4)*31.6/(channel number)
 - DH5 Time Slot: Reading * (1600/6)*31.6/(channel number)

5.1.2 DEVIATION FROM STANDARD

No deviation.

5.1.3 TEST SETUP

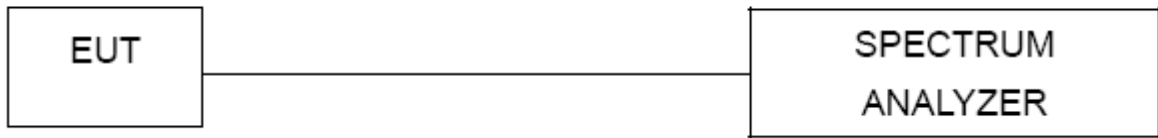

5.1.4 EUT OPERATION CONDITIONS

The EUT tested system was configured as the statements of 2.4 Unless otherwise a special operating condition is specified in the follows during the testing.

5.1.5 TEST RESULTS

EUT :	iCarta 2 Bluetooth Stereo Speaker with bathtissue holder	Model Name :	iCarta 2
Temperature :	25 °C	Relative Humidity :	60%
Pressure :	1012 hPa	Test Voltage :	DC 6.0V
Test Mode :	CH39-DH5 ,2DH5,3DH5		

Data Packet	Frequency	Pulse Duration (ms)	Dwell Time (s)	Limits (s)
DH5	2441 MHz	2.95	0.31	0.4
2DH5	2441 MHz	3.10	0.33	0.4
3DH5	2441 MHz	3.15	0.34	0.4

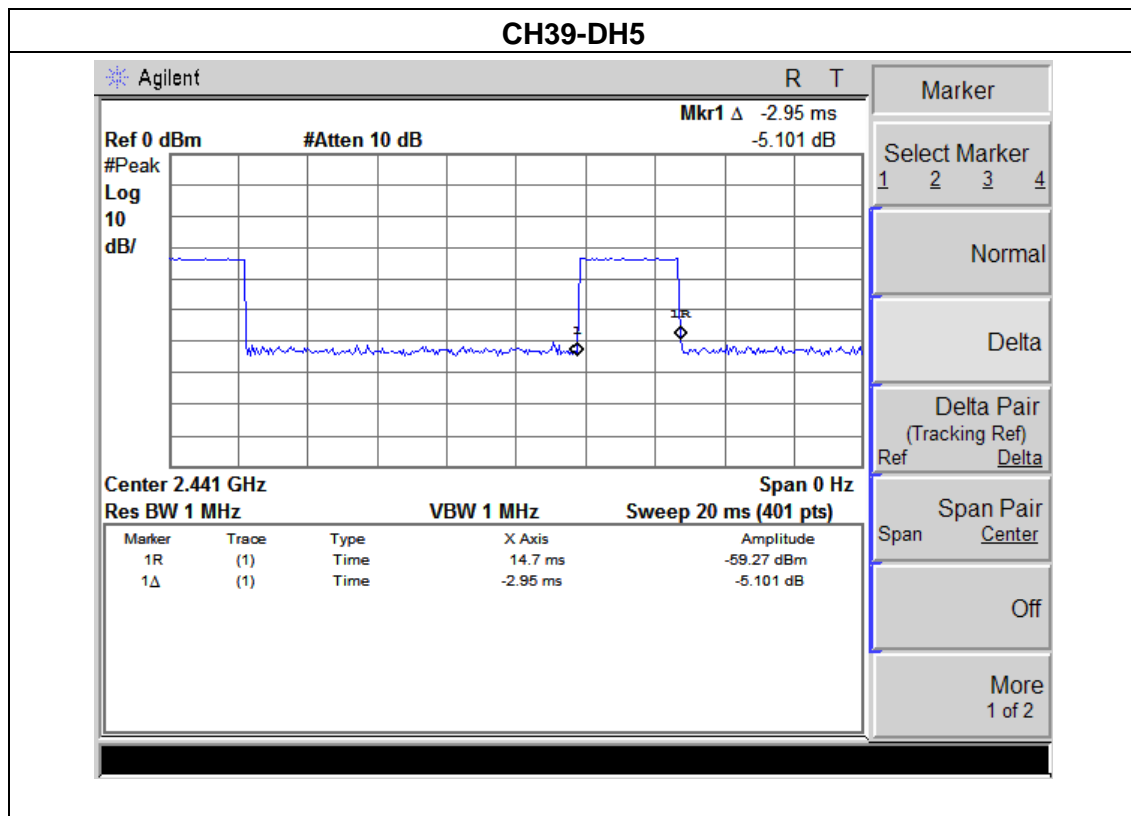

CH39-2DH5

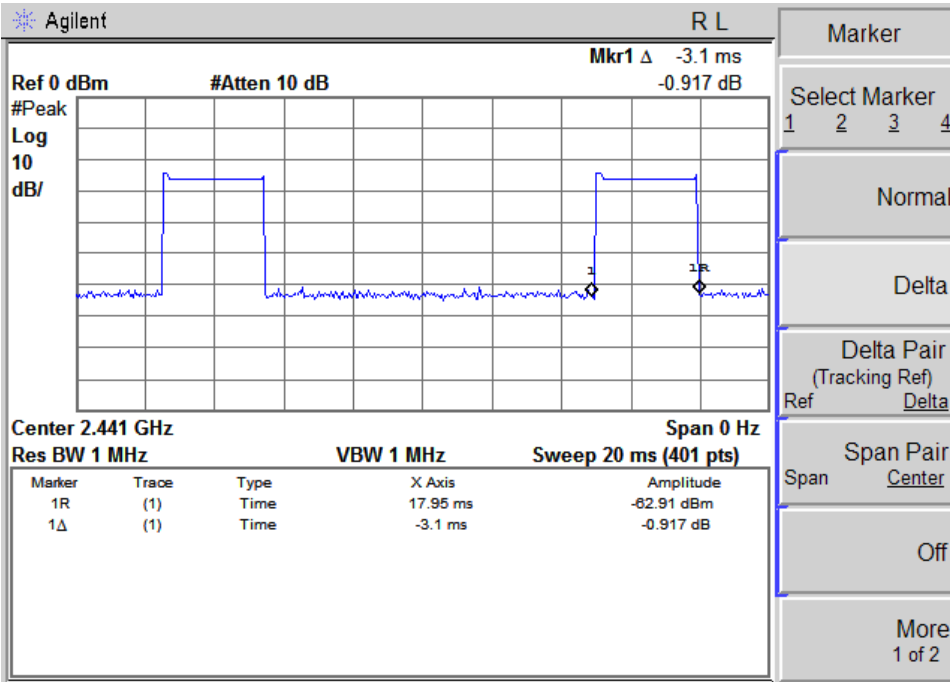

CH39-3DH5

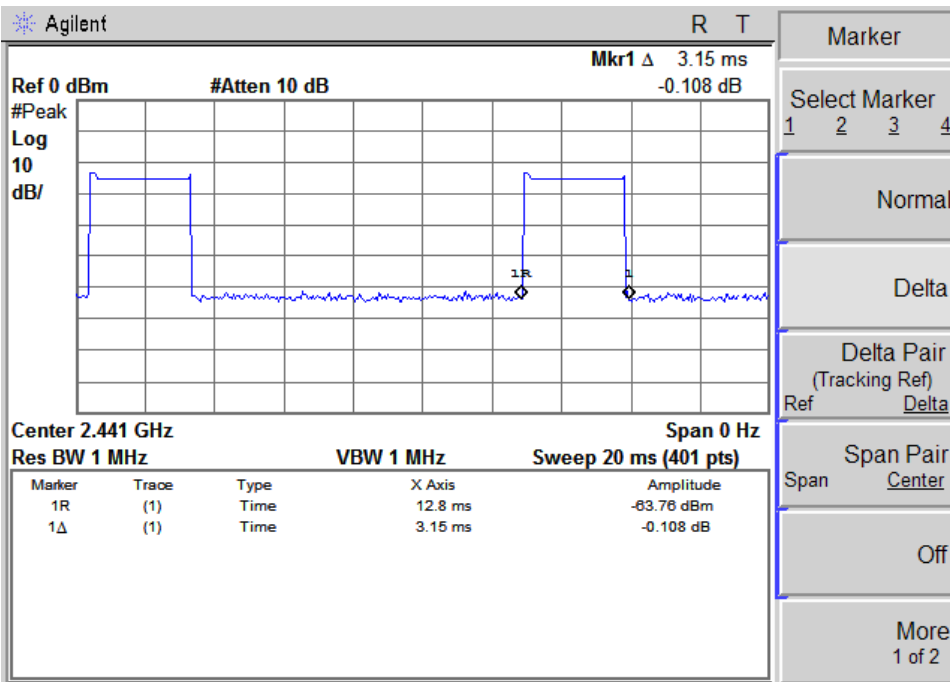

EUT :	iCarta 2 Bluetooth Stereo Speaker with bathtissue holder	Model Name :	iCarta 2
Temperature :	25 °C	Relative Humidity :	60%
Pressure :	1012 hPa	Test Voltage :	DC 6.0V
Test Mode :	CH39-DH3,2DH3,3DH3		

Data Packet	Frequency	Pulse Duration (ms)	Dwell Time (s)	Limits (s)
DH3	2441 MHz	1.75	0.19	0.4
2DH3	2441 MHz	1.80	0.19	0.4
3DH3	2441 MHz	1.80	0.19	0.4

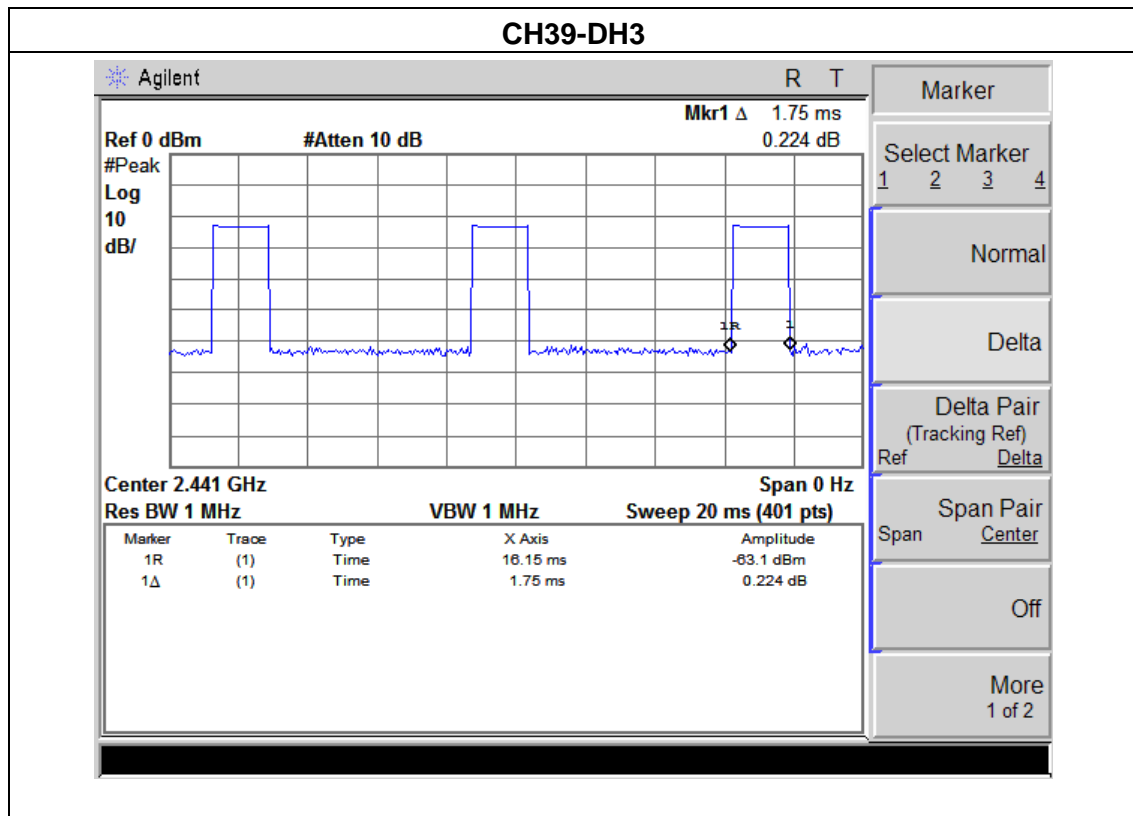

CH39-2DH3

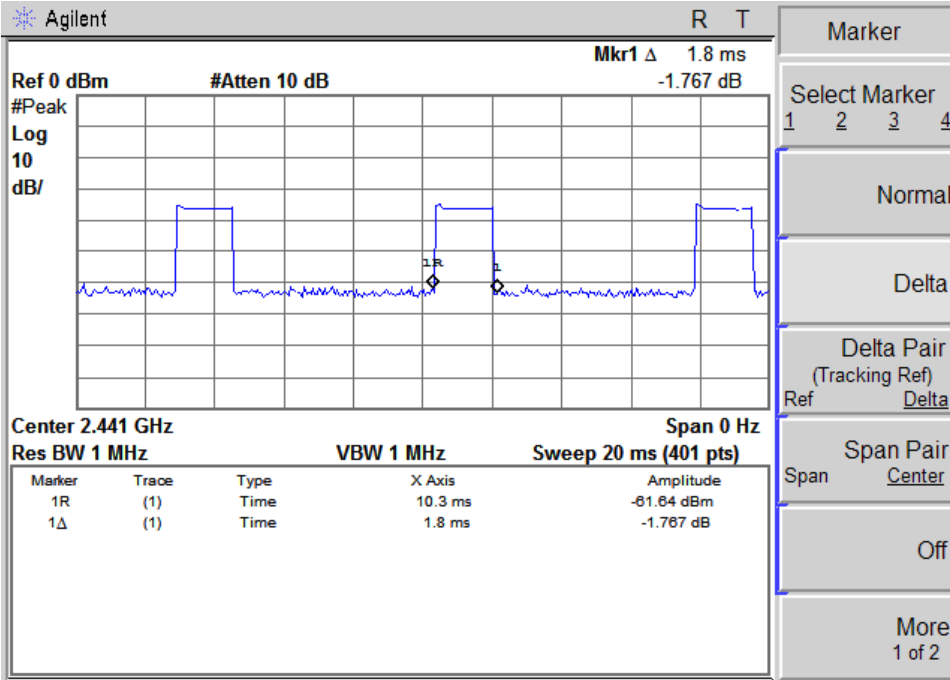

CH39-3DH3

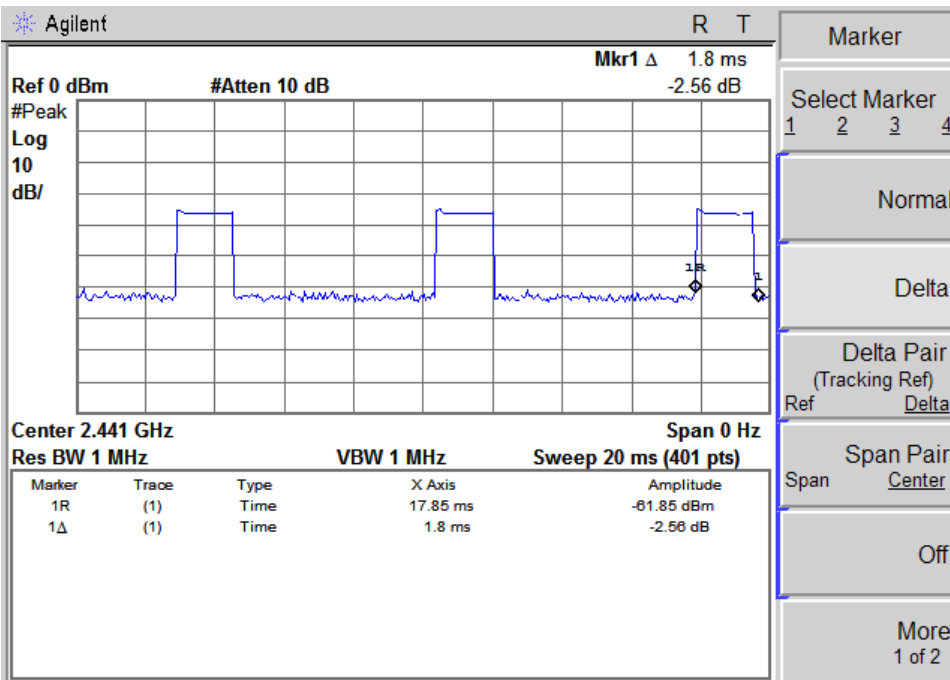

EUT :	iCarta 2 Bluetooth Stereo Speaker with bathtissue holder	Model Name :	iCarta 2
Temperature :	25 °C	Relative Humidity :	60%
Pressure :	1012 hPa	Test Voltage :	DC 6.0V
Test Mode :	CH39-DH1,2DH1,3DH1		

Data Packet	Frequency	Pulse Duration (ms)	Dwell Time (s)	Limits (s)
DH1	2441 MHz	0.46	0.05	0.4
2DH1	2441 MHz	0.45	0.05	0.4
3DH1	2441 MHz	0.45	0.05	0.4

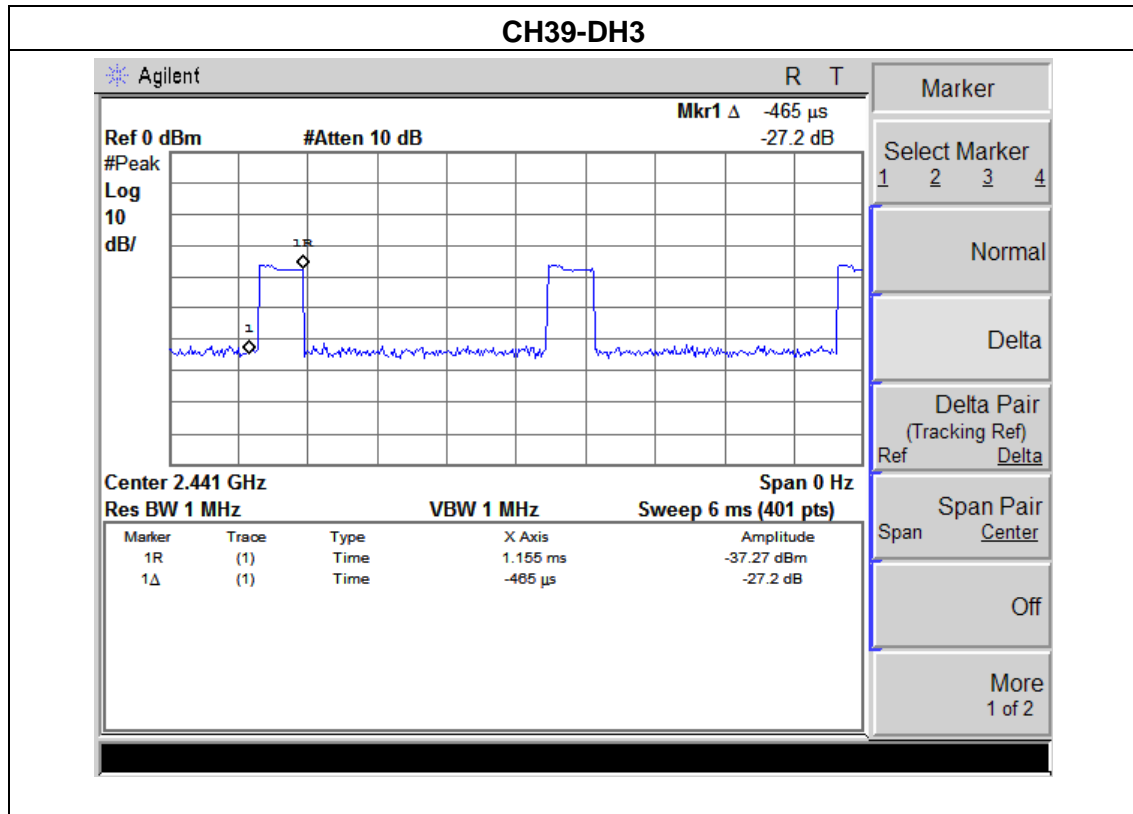

CH39-2DH3

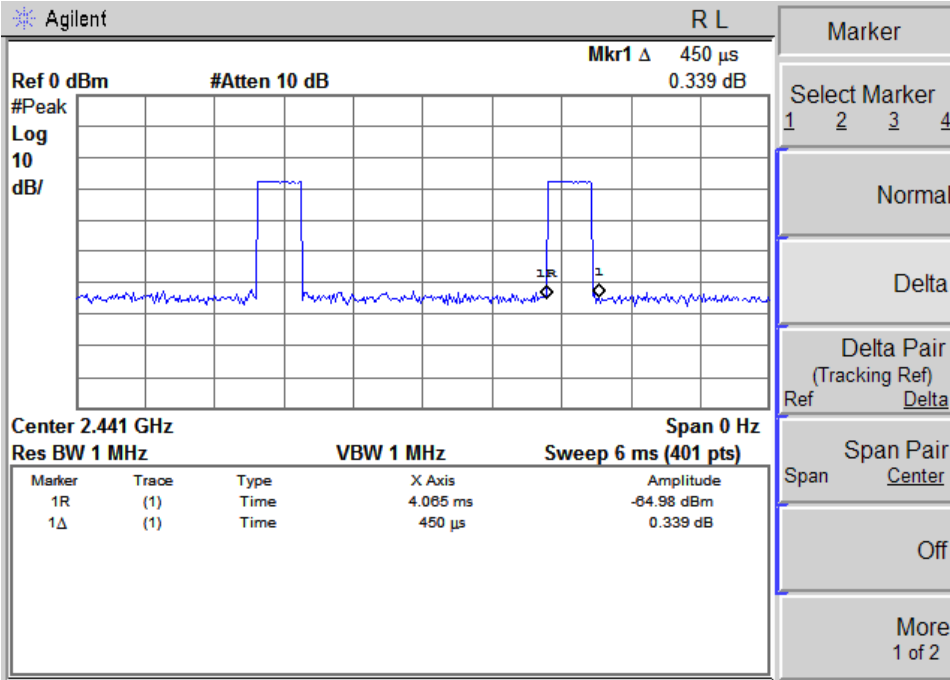

CH39-3DH3

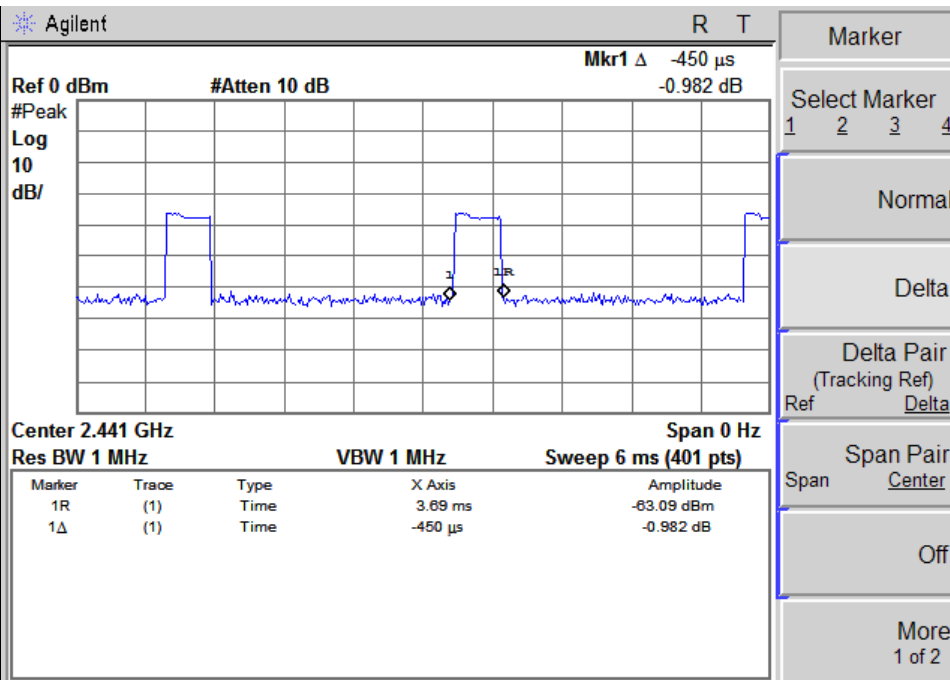

6. HOPPING CHANNEL SEPARATION MEASUREMENT

6.1 APPLIED PROCEDURES / LIMIT

Frequency hopping systems operating in the 2400-2483.5 MHz band may have hopping channel carrier frequencies that are separated by 25 kHz or two-thirds of the 20 dB bandwidth of the hopping channel, whichever is greater.

Spectrum Parameter	Setting
Attenuation	Auto
Span Frequency	> Measurement Bandwidth or Channel Separation
RB	100 kHz (Channel Separation)
VB	300 kHz (Channel Separation)
Detector	Peak
Trace	Max Hold
Sweep Time	Auto

6.1.1 TEST PROCEDURE

- a. The transmitter output (antenna port) was connected to the spectrum analyser in peak hold mode.
- b. The resolution bandwidth of 100 kHz and the video bandwidth of 300 kHz were utilised for channel separation measurement.

6.1.2 DEVIATION FROM STANDARD

No deviation.

6.1.3 TEST SETUP

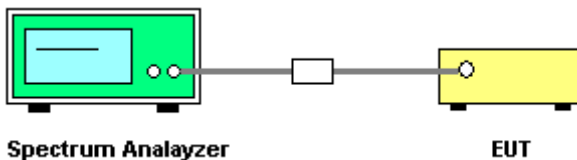

6.1.4 EUT OPERATION CONDITIONS

The EUT was programmed to be in continuously transmitting mode.

6.1.5 TEST RESULTS

EUT :	iCarta 2 Bluetooth Stereo Speaker with bathtissue holder	Model Name :	iCarta 2
Temperature :	25 °C	Relative Humidity :	60%
Pressure :	1012 hPa	Test Voltage :	DC 6.0V
Test Mode :	CH00 / CH39 /CH78 (1Mbps Mode)		

Frequency	Ch. Separation (MHz)	Result
2402 MHz	1.020	Complies
2441 MHz	1.010	Complies
2480 MHz	1.020	Complies

Ch. Separation Limits: >20dB bandwidth or >2/3 of 20dB bandwidth

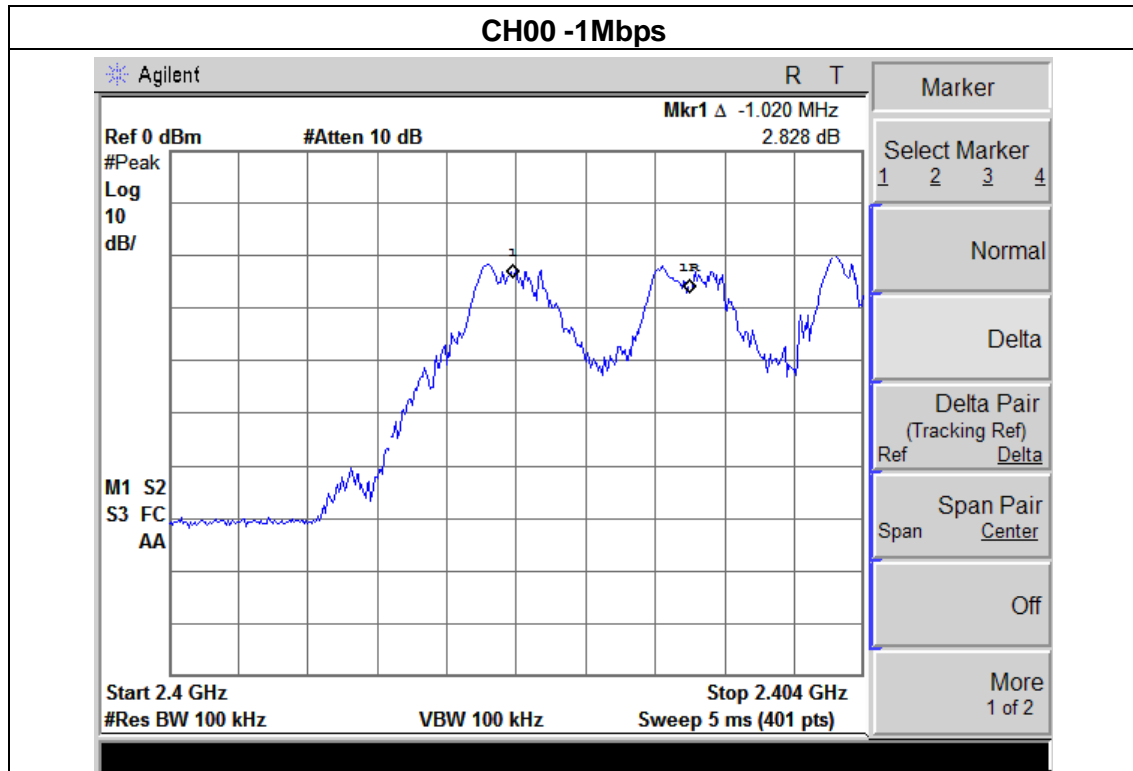

CH39 -1Mbps

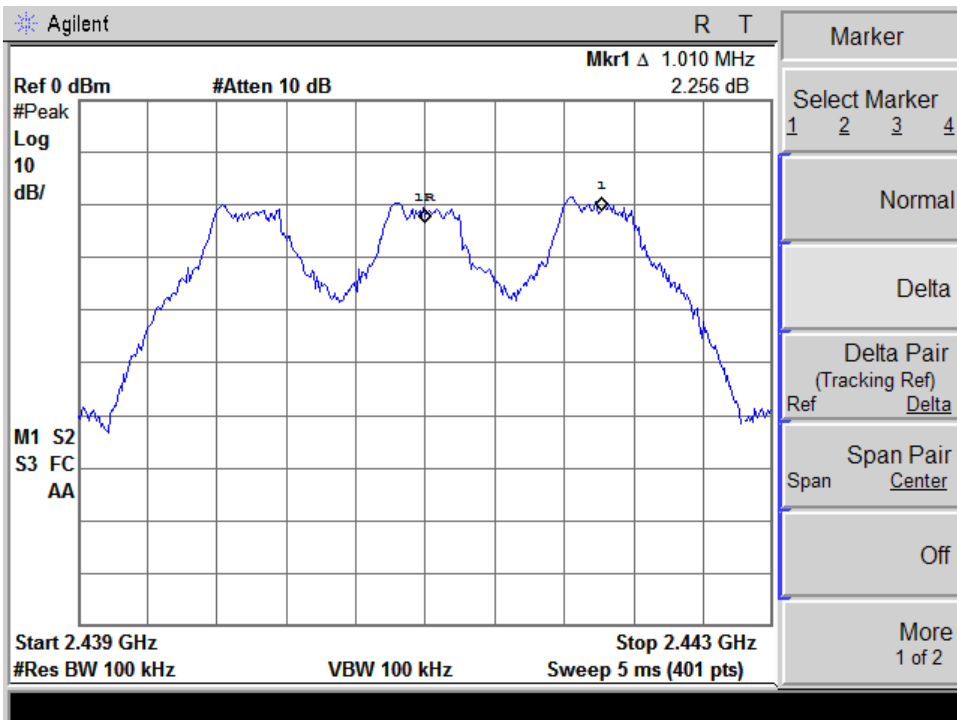

CH78 -1Mbps

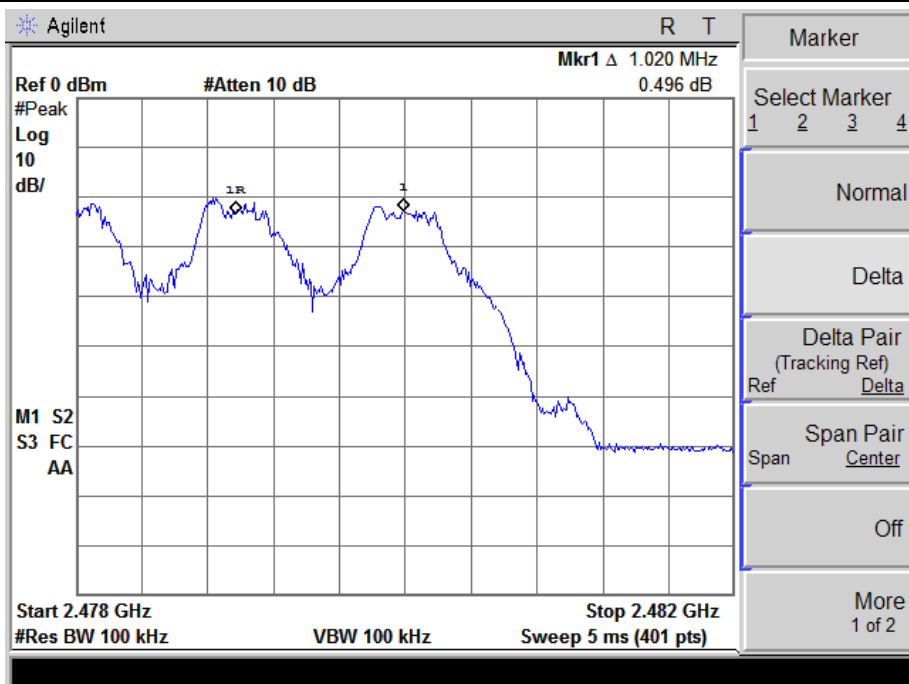

EUT :	iCarta 2 Bluetooth Stereo Speaker with bathtissue holder	Model Name :	iCarta 2
Temperature :	25 °C	Relative Humidity :	60%
Pressure :	1012 hPa	Test Voltage :	DC 6.0V
Test Mode :	CH00 / CH39 /CH78 (2Mbps Mode)		

Frequency	Ch. Separation (MHz)	Result
2402 MHz	1.010	Complies
2441 MHz	1.050	Complies
2480 MHz	1.010	Complies

Ch. Separation Limits: >20dB bandwidth or >2/3 of 20dB bandwidth

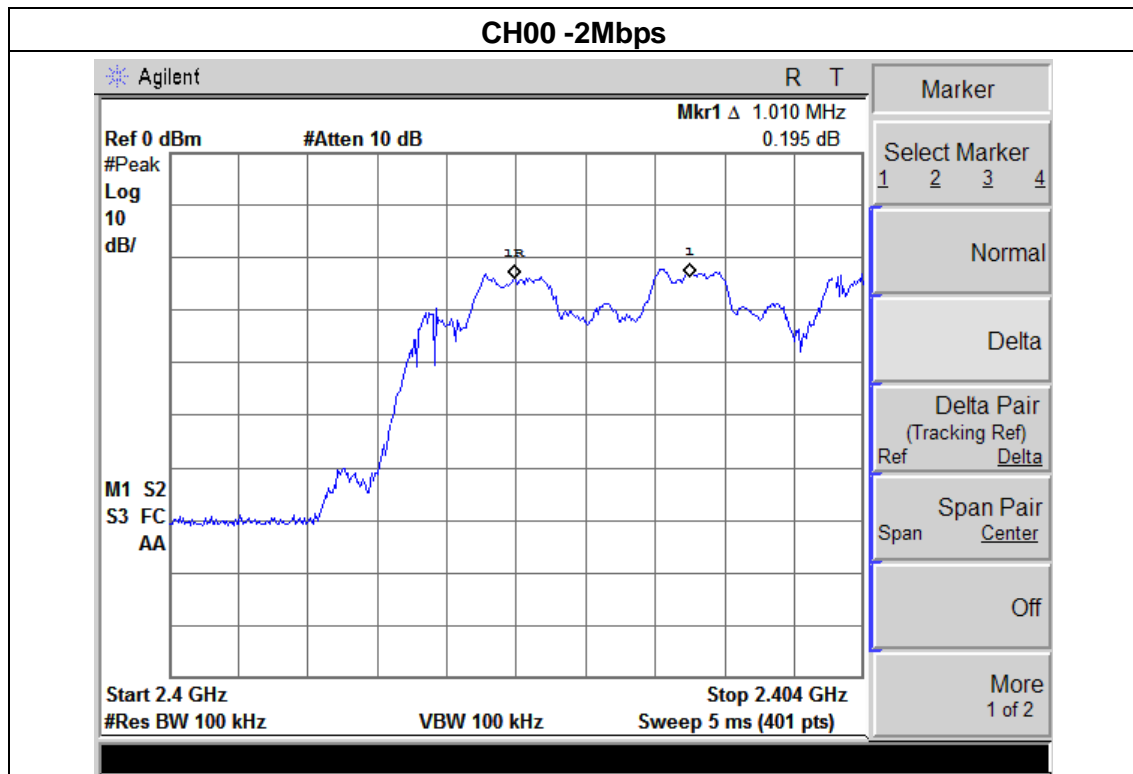

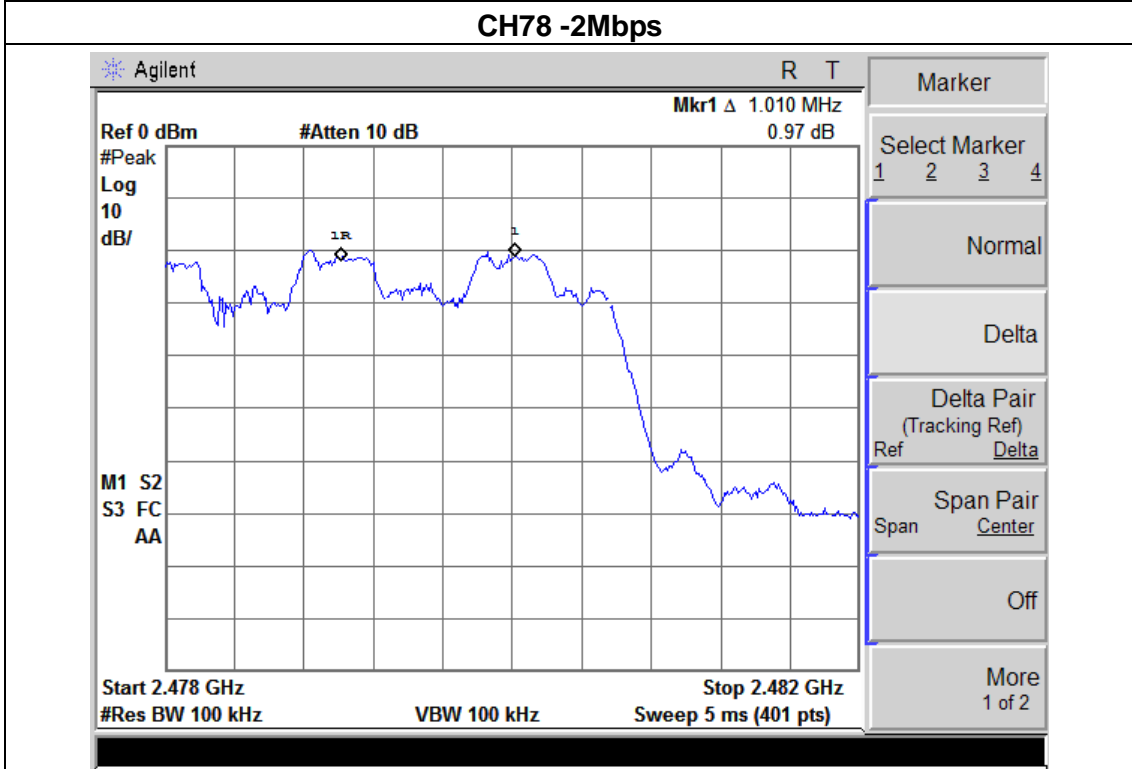
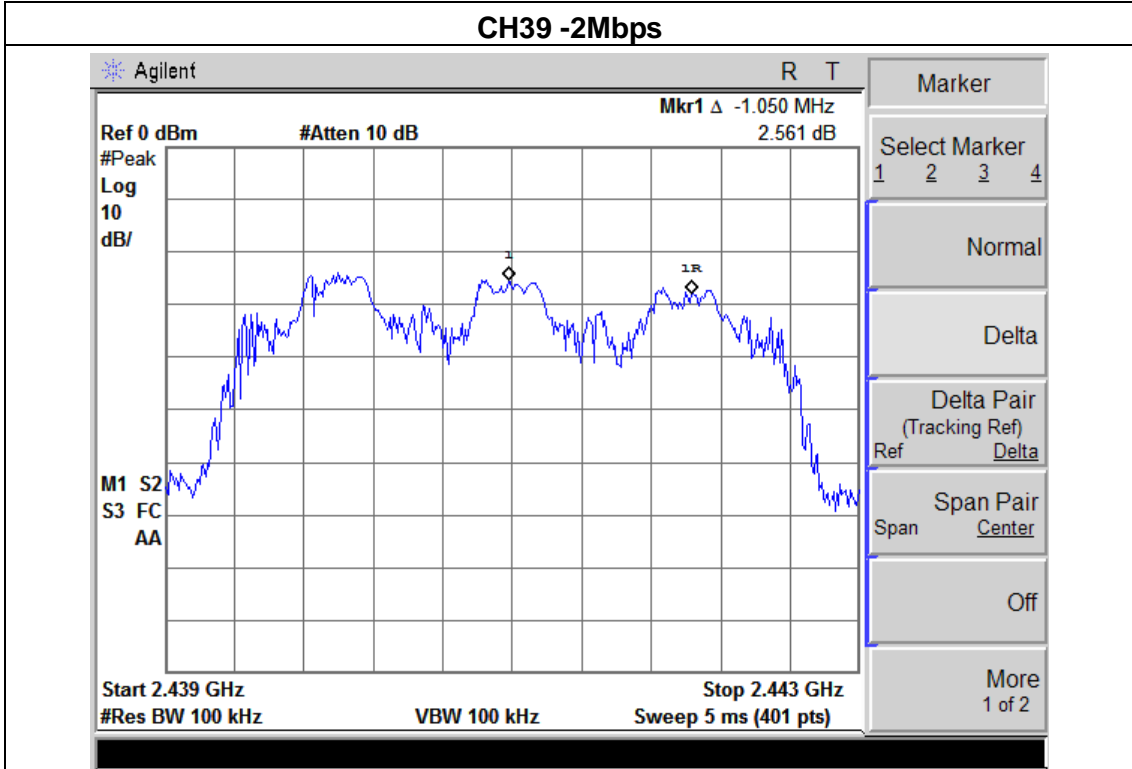

EUT :	iCarta 2 Bluetooth Stereo Speaker with bathtissue holder	Model Name :	iCarta 2
Temperature :	25 °C	Relative Humidity :	60%
Pressure :	1012 hPa	Test Voltage :	DC 6.0V
Test Mode :	CH00 / CH39 /CH78 (3Mbps Mode)		

Frequency	Ch. Separation (MHz)	Result
2402 MHz	1.030	Complies
2441 MHz	1.010	Complies
2480 MHz	1.000	Complies

Ch. Separation Limits: >20dB bandwidth or >2/3 of 20dB bandwidth

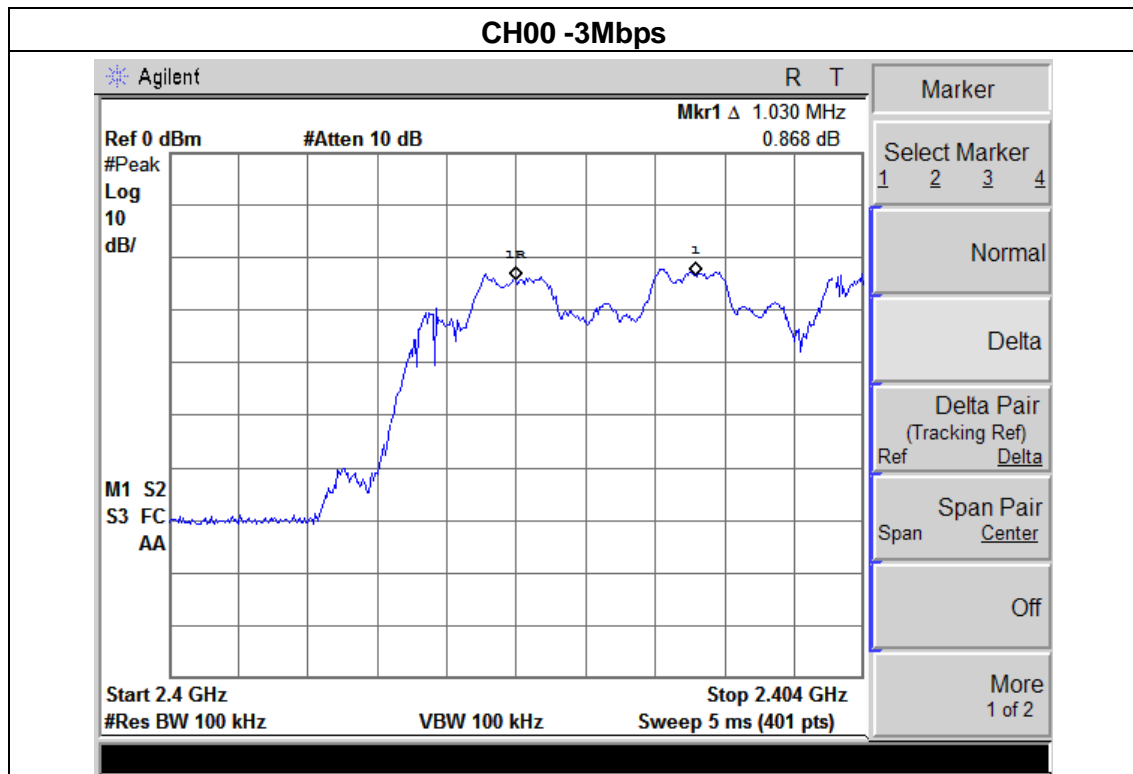

CH39 -3Mbps

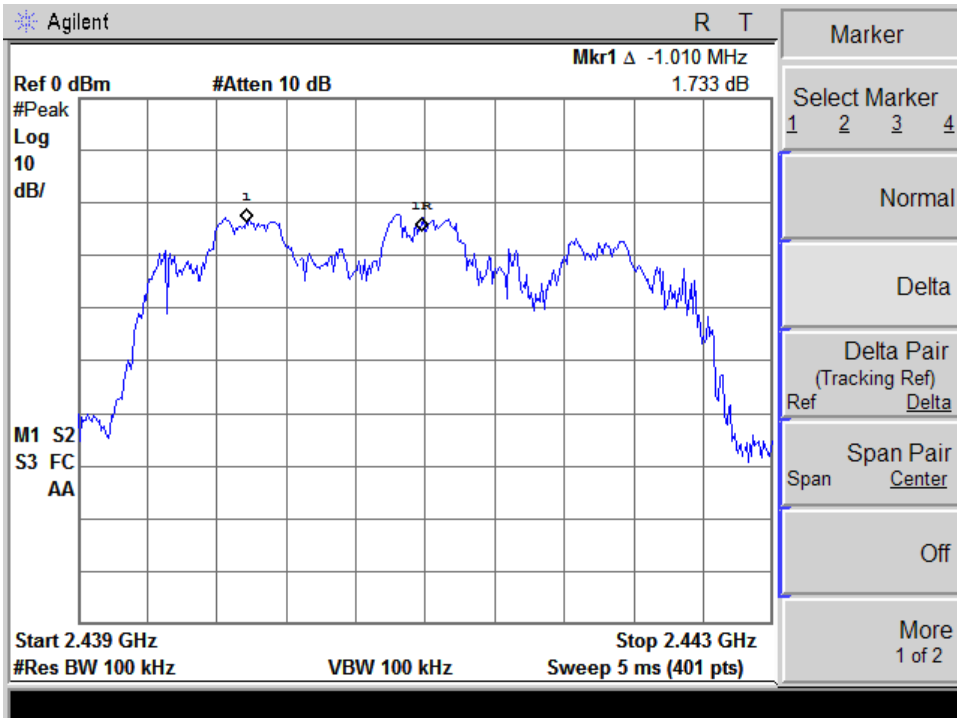

CH78 -3Mbps

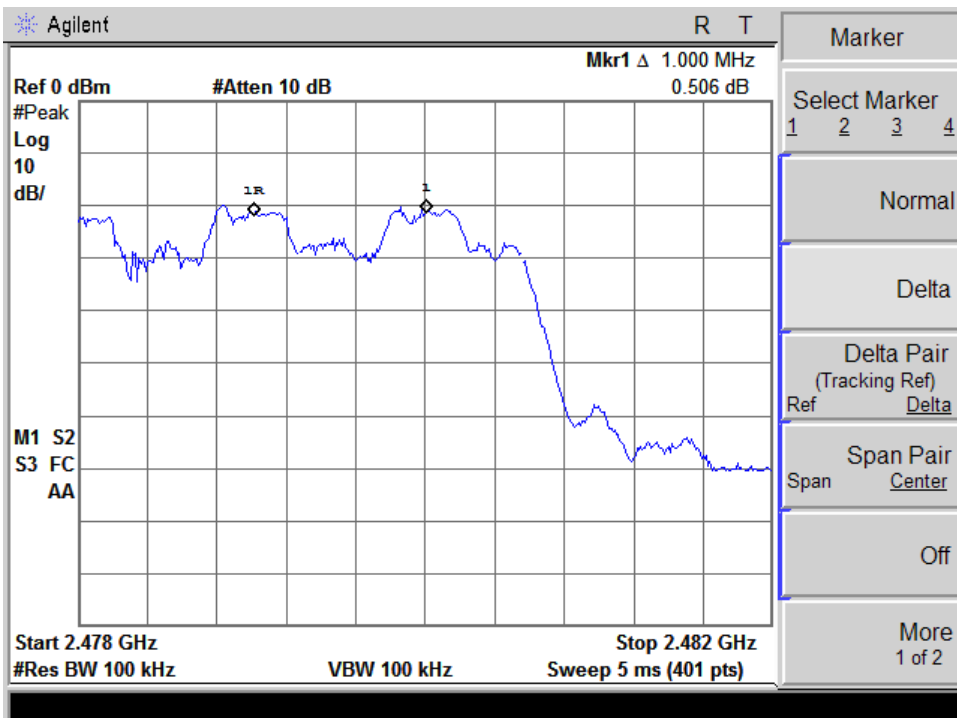

7. BANDWIDTH TEST

7.1 APPLIED PROCEDURES / LIMIT

FCC Part15 (15.247) , Subpart C				
Section	Test Item	Limit	Frequency Range (MHz)	Result
15.247 (a)(1)	Bandwidth	(20dB bandwidth)	2400-2483.5	PASS

Spectrum Parameter	Setting
Attenuation	Auto
Span Frequency	> Measurement Bandwidth or Channel Separation
RB	30 kHz
VB	100 kHz
Detector	Peak
Trace	Max Hold
Sweep Time	Auto

7.1.1 TEST PROCEDURE

- a. The EUT was directly connected to the spectrum analyzer and antenna output port as show in the block diagram below,
- b. Spectrum Setting : RBW= 100KHz, VBW=100KHz, Sweep time = Auto.

7.1.2 DEVIATION FROM STANDARD

No deviation.

7.1.3 TEST SETUP



7.1.4 EUT OPERATION CONDITIONS

The EUT tested system was configured as the statements of 2.4 Unless otherwise a special operating condition is specified in the follows during the testing.

7.1.5 TEST RESULTS

EUT :	iCarta 2 Bluetooth Stereo Speaker with bathtissue holder	Model Name :	iCarta 2
Temperature :	25 °C	Relative Humidity :	60%
Pressure :	1012 hPa	Test Voltage :	DC 6.0V
Test Mode :	CH00 / CH39 /C78(1Mbps)		

Frequency	20dB Bandwidth (kHz)	Result
2402 MHz	811.21	PASS
2441 MHz	765.78	PASS
2480 MHz	828.75	PASS

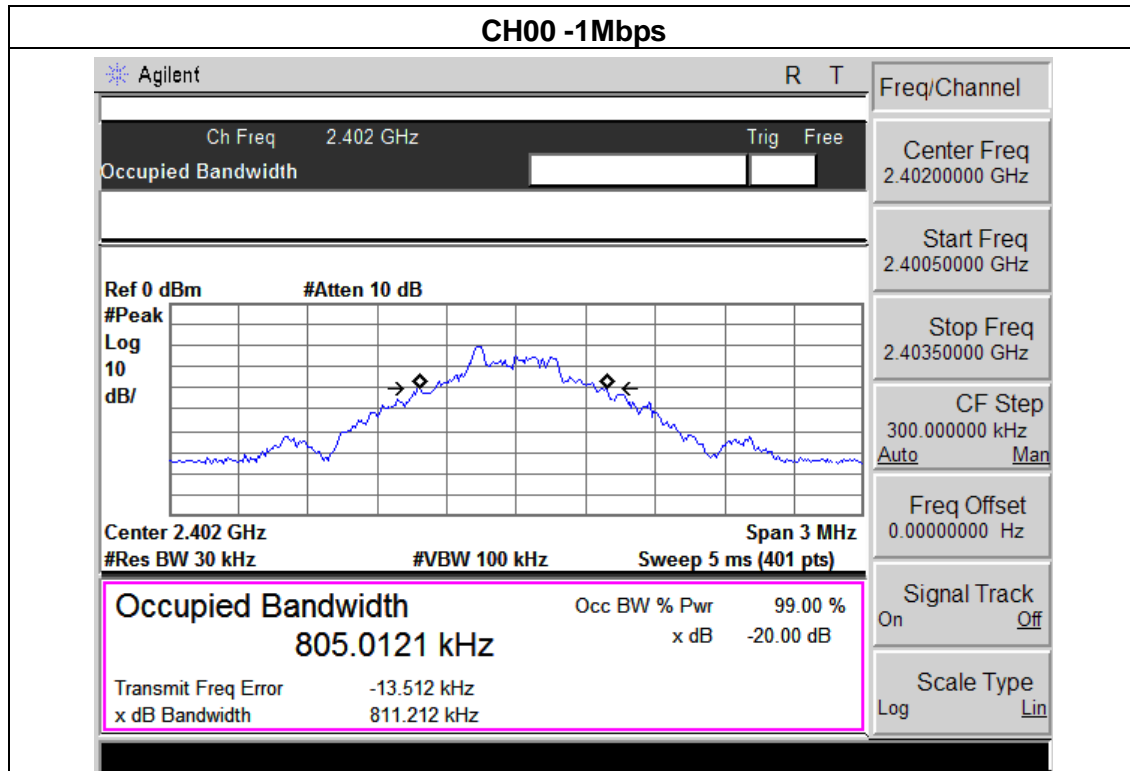

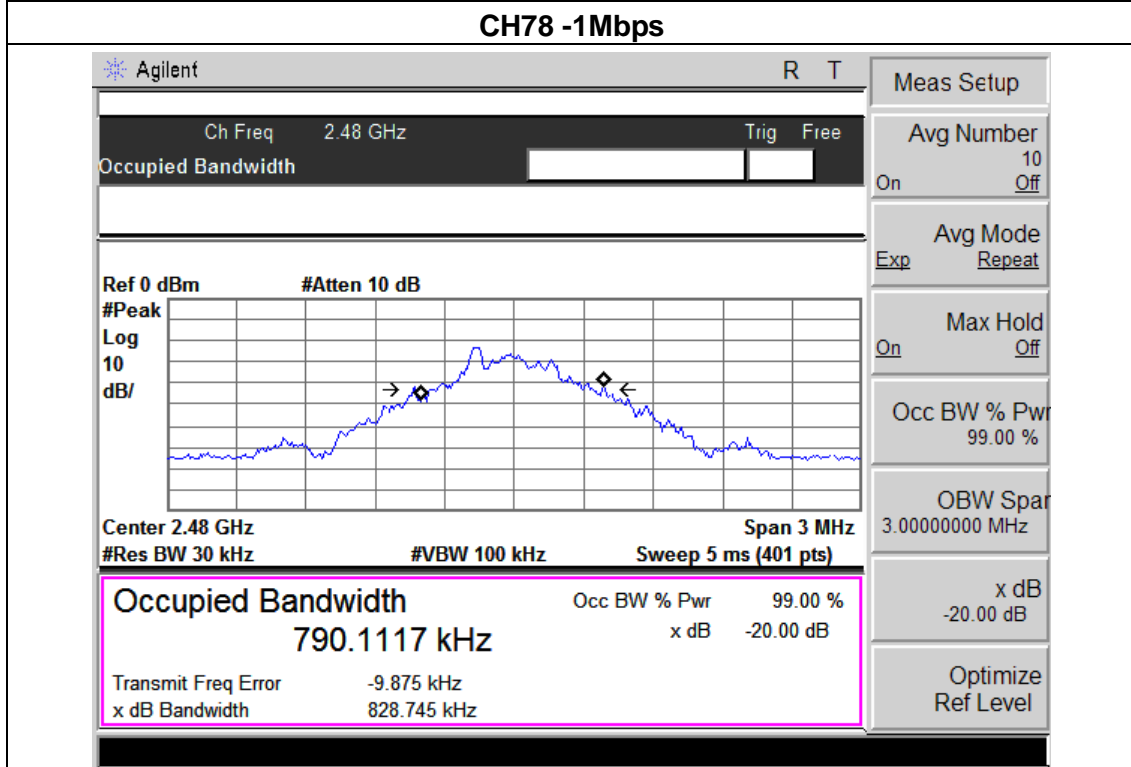
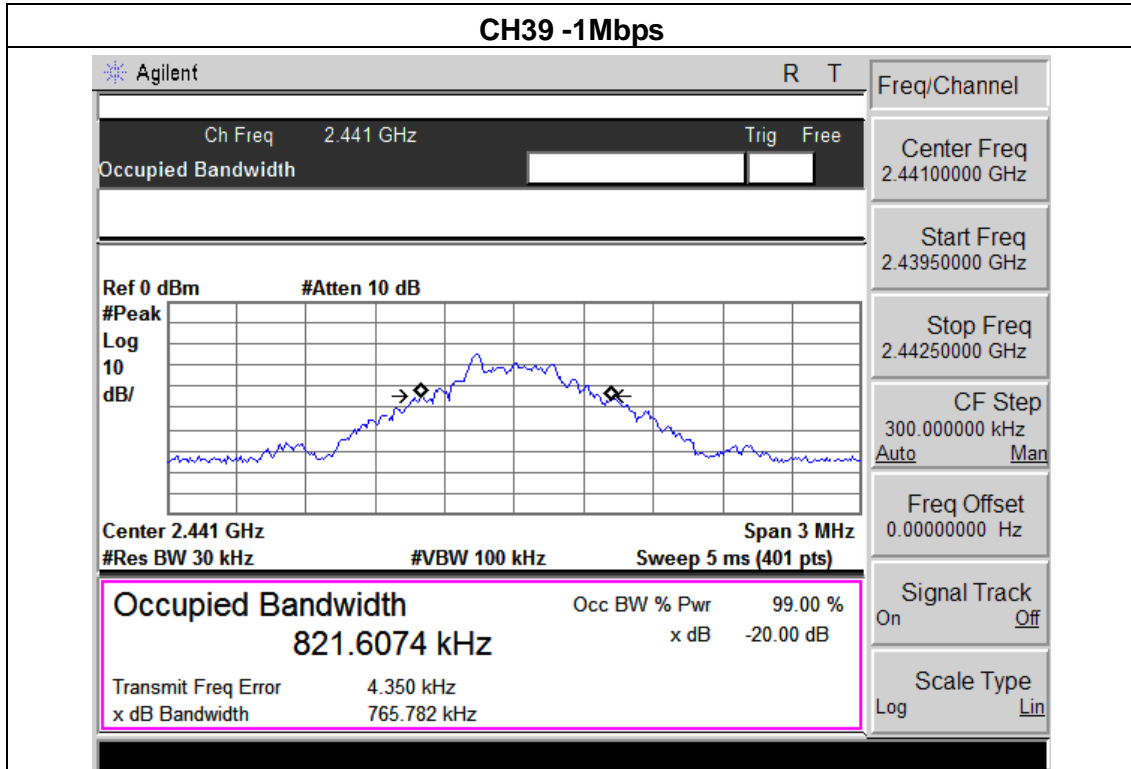

EUT :	iCarta 2 Bluetooth Stereo Speaker with bathtissue holder	Model Name :	iCarta 2
Temperature :	25 °C	Relative Humidity :	60%
Pressure :	1012 hPa	Test Voltage :	DC 6.0V
Test Mode :	CH00 / CH39 /C78(2Mbps)		

Frequency	20dB Bandwidth (kHz)	Result
2402 MHz	1.126	PASS
2441 MHz	1.124	PASS
2480 MHz	1.129	PASS

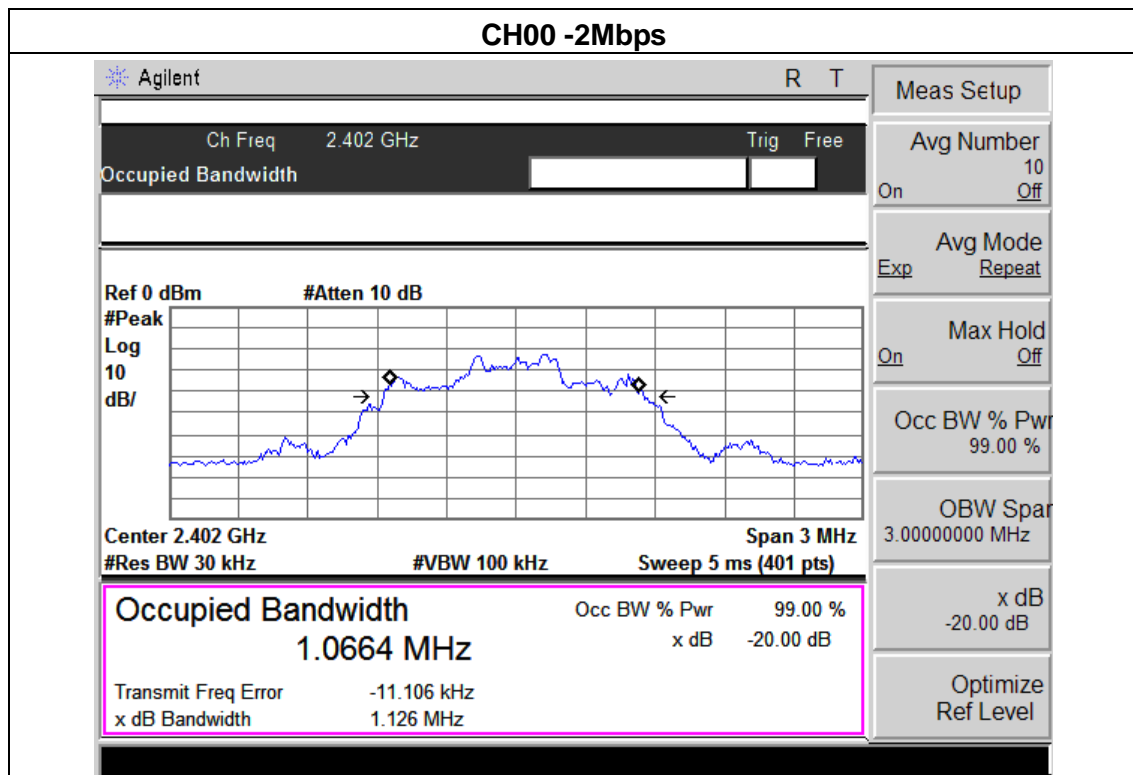

CH39 -2Mbps

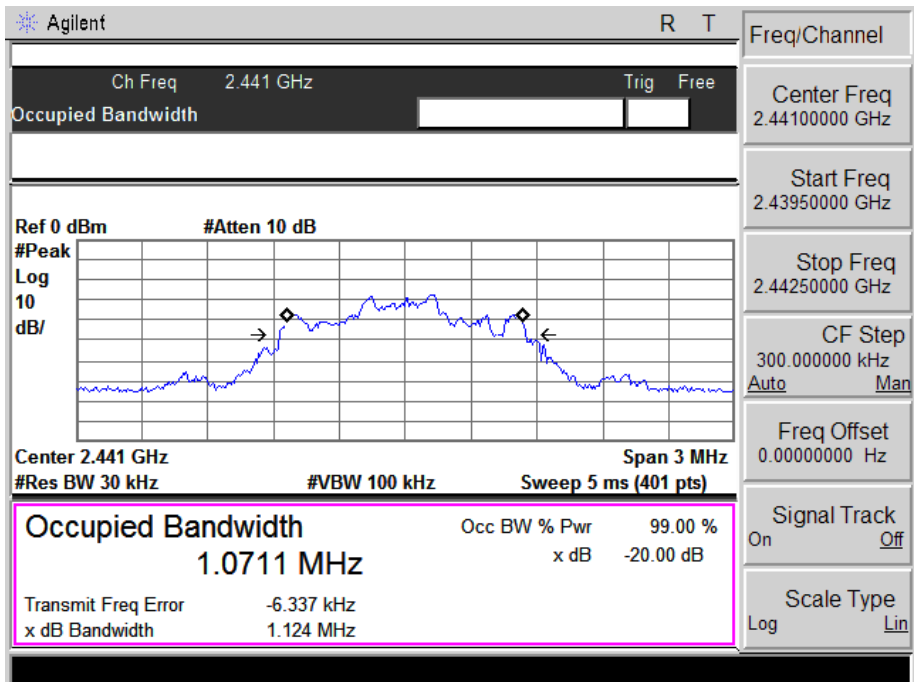

CH78 -2Mbps

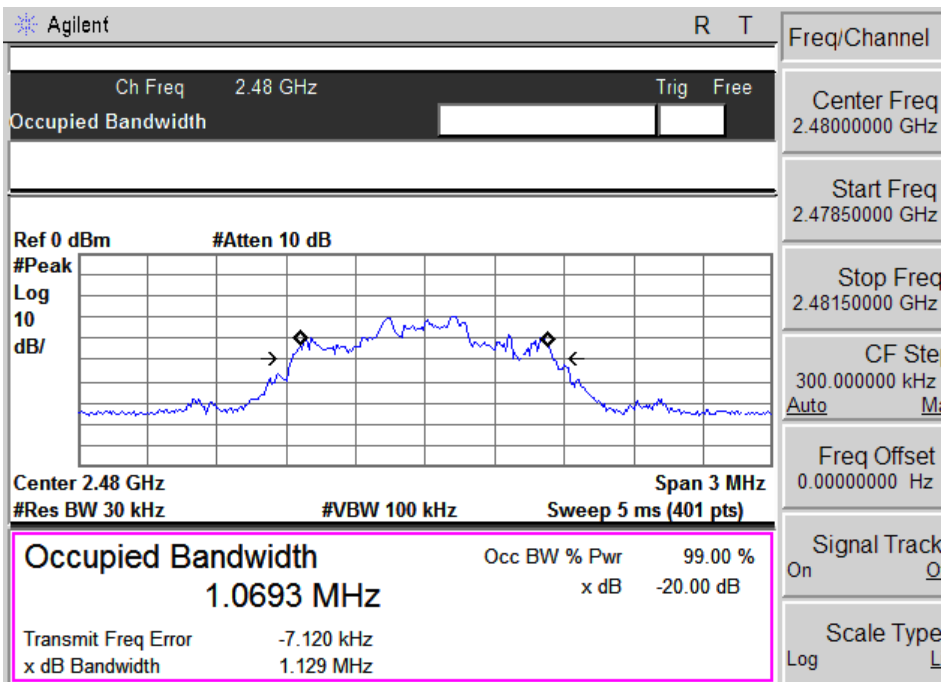

EUT :	iCarta 2 Bluetooth Stereo Speaker with bathtissue holder	Model Name :	iCarta 2
Temperature :	25 °C	Relative Humidity :	60%
Pressure :	1012 hPa	Test Voltage :	DC 6.0V
Test Mode :	CH00 / CH39 /C78(3Mbps)		

Frequency	20dB Bandwidth (kHz)	Result
2402 MHz	1.137	PASS
2441 MHz	1.115	PASS
2480 MHz	1.107	PASS

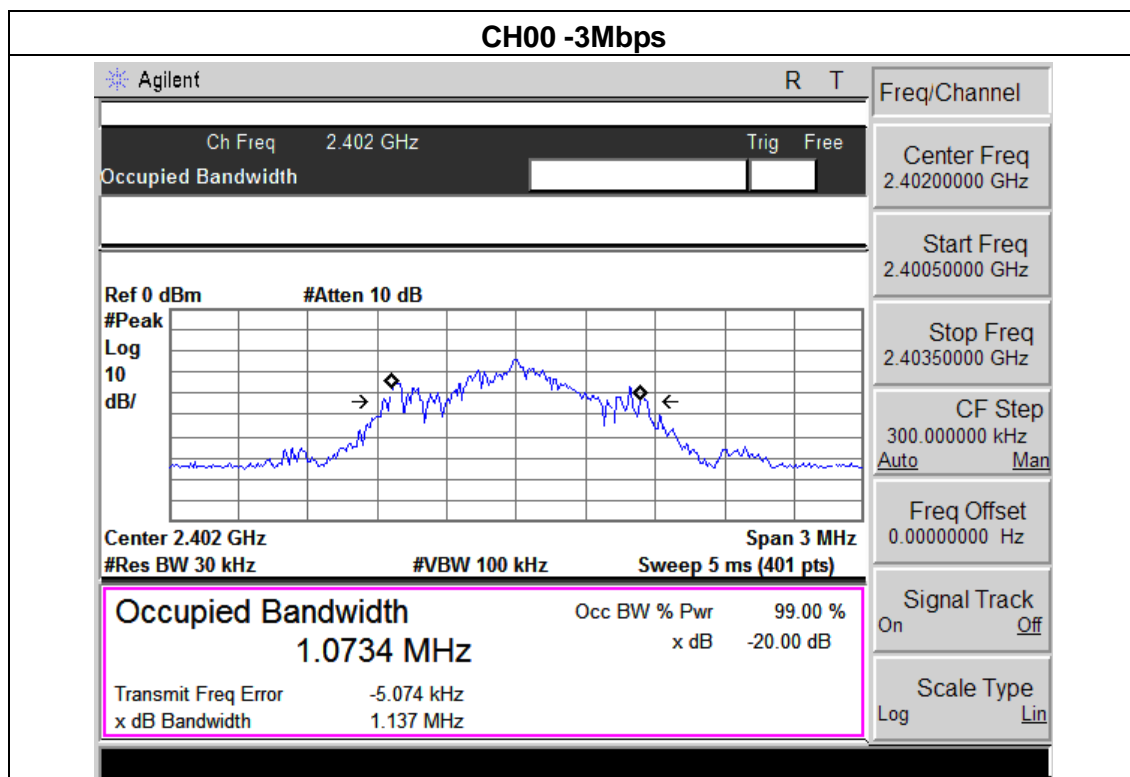

CH39 -3Mbps

Agilent R T

Ch Freq 2.441 GHz Trig Free

Occupied Bandwidth [] []

Ref 0 dBm #Atten 10 dB

#Peak

Log

10

dB/

Center 2.441 GHz Span 3 MHz

#Res BW 30 kHz #VBW 100 kHz Sweep 5 ms (401 pts)

Occupied Bandwidth Occ BW % Pwr 99.00 %

1.0109 MHz

x dB -20.00 dB

Transmit Freq Error -3.721 kHz

x dB Bandwidth 1.115 MHz

Freq/Channel

Center Freq 2.44100000 GHz

Start Freq 2.43950000 GHz

Stop Freq 2.44250000 GHz

CF Step 300.000000 kHz

Auto Man

Freq Offset 0.00000000 Hz

Signal Track On Off

Scale Type Log Lin

CH78 -3Mbps

Agilent R T

Ch Freq 2.48 GHz Trig Free

Occupied Bandwidth [] []

Ref 0 dBm #Atten 10 dB

#Peak

Log

10

dB/

Center 2.48 GHz Span 3 MHz

#Res BW 30 kHz #VBW 100 kHz Sweep 5 ms (401 pts)

Occupied Bandwidth Occ BW % Pwr 99.00 %

1.0575 MHz

x dB -20.00 dB

Transmit Freq Error -1.345 kHz

x dB Bandwidth 1.107 MHz

Meas Setup

Avg Number 10

On Off

Avg Mode Exp Repeat

Max Hold On Off

Occ BW % Pwr 99.00 %

OBW Spar 3.00000000 MHz

x dB -20.00 dB

Optimize Ref Level

8. PEAK OUTPUT POWER TEST

8.1 APPLIED PROCEDURES / LIMIT

FCC Part15 (15.247) , Subpart C				
Section	Test Item	Limit	Frequency Range (MHz)	Result
15.247 (b)(i)	Peak Output Power	0.125 w or 20.96dBm	2400-2483.5	PASS

8.1.1 TEST PROCEDURE

- a. The EUT was directly connected to the spectrum analyzer and antenna output port as show in the block diagram below,
- b. Spectrum Setting : RBW > the 20 dB bandwidth of the emission being measured
 - Span = approximately 5 times the 20 dB bandwidth, centered on a hopping channel
 - VBW ≥ RBW
 - Sweep = auto
 - Detector function = peak
 - Trace = max hold

8.1.2 DEVIATION FROM STANDARD

No deviation.

8.1.3 TEST SETUP



8.1.4 EUT OPERATION CONDITIONS

The EUT tested system was configured as the statements of 2.4 Unless otherwise a special operating condition is specified in the follows during the testing.

8.1.5 TEST RESULTS

EUT :	iCarta 2 Bluetooth Stereo Speaker with bathtissue holder	Model Name :	iCarta 2
Temperature :	25 °C	Relative Humidity :	60%
Pressure :	1012 hPa	Test Voltage :	DC 6.0V
Test Mode :	CH00/ CH39 /CH78 (1M/2M/3Mbps Mode)		

1Mbps			
Test Channel	Frequency (MHz)	Peak Output Power (dBm)	LIMIT (dBm)
CH00	2402	0.254	20.96
CH39	2441	0.435	20.96
CH78	2480	0.285	20.96
2Mbps			
CH00	2402	-0.393	20.96
CH39	2441	-0.135	20.96
CH78	2480	-0.736	20.96
3Mbps			
CH00	2402	-0.415	20.96
CH39	2441	-0.363	20.96
CH78	2480	-0.591	20.96

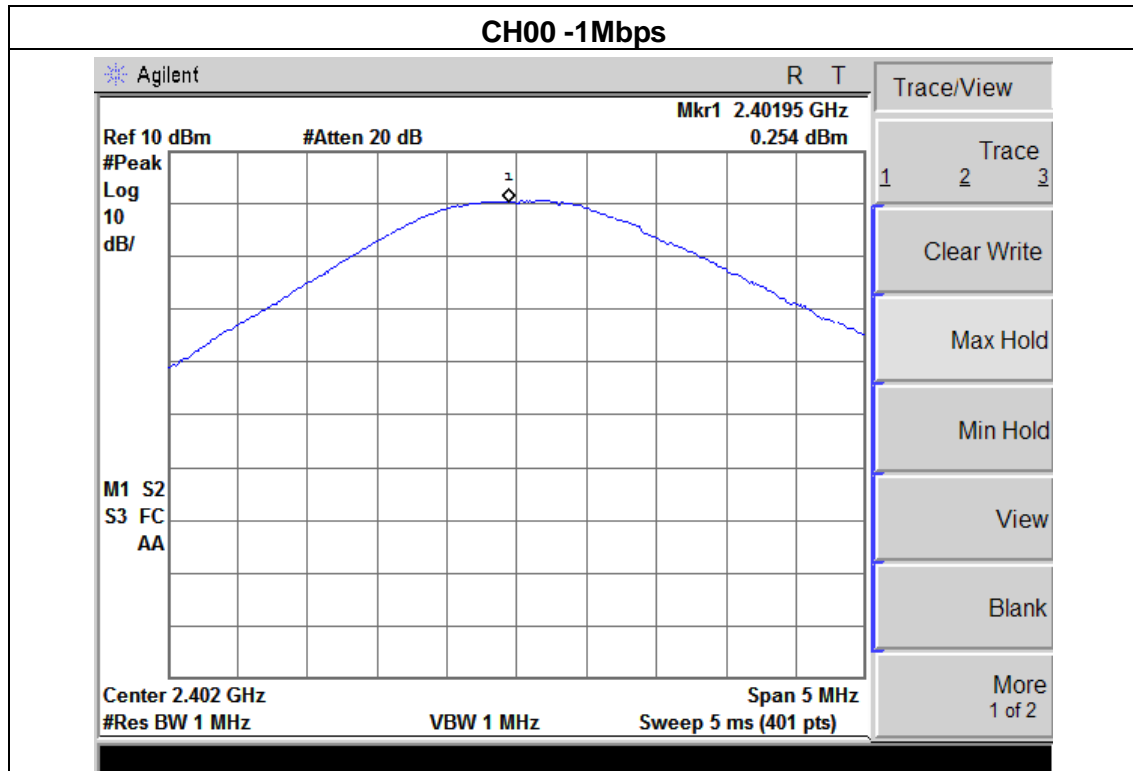

CH39 -1Mbps

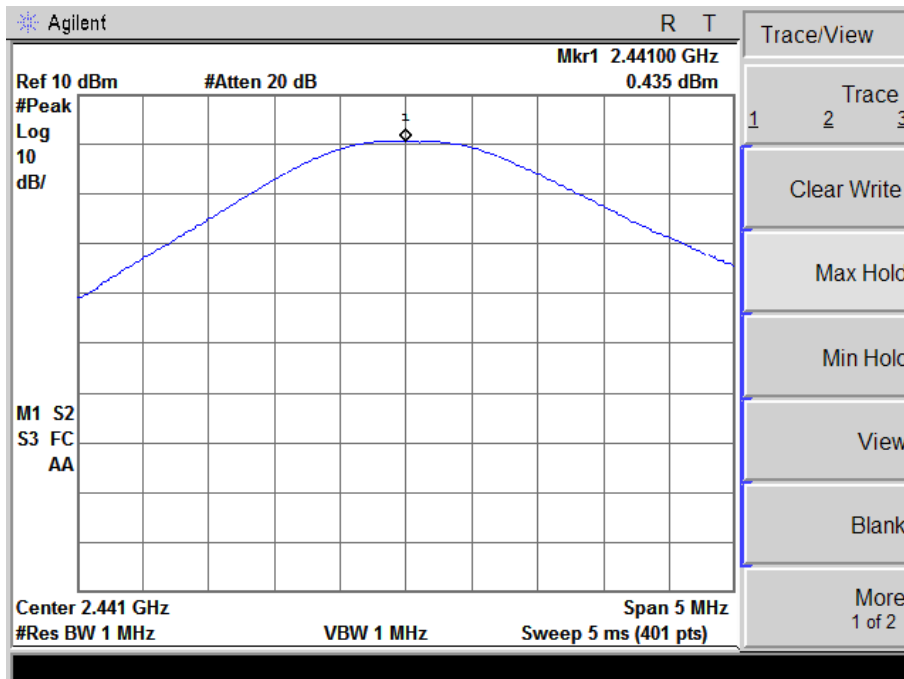

CH78 -1Mbps

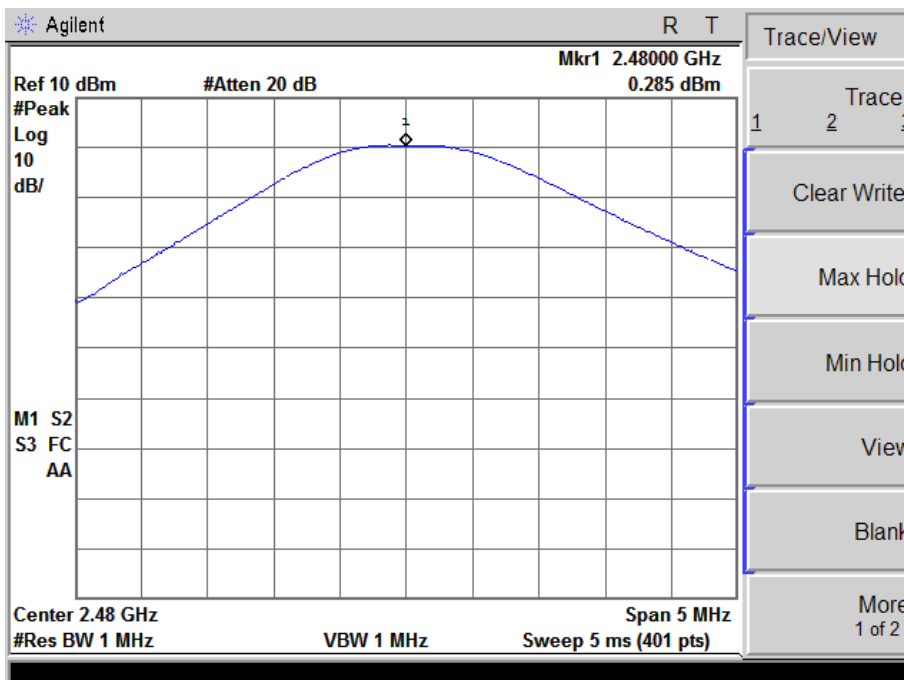

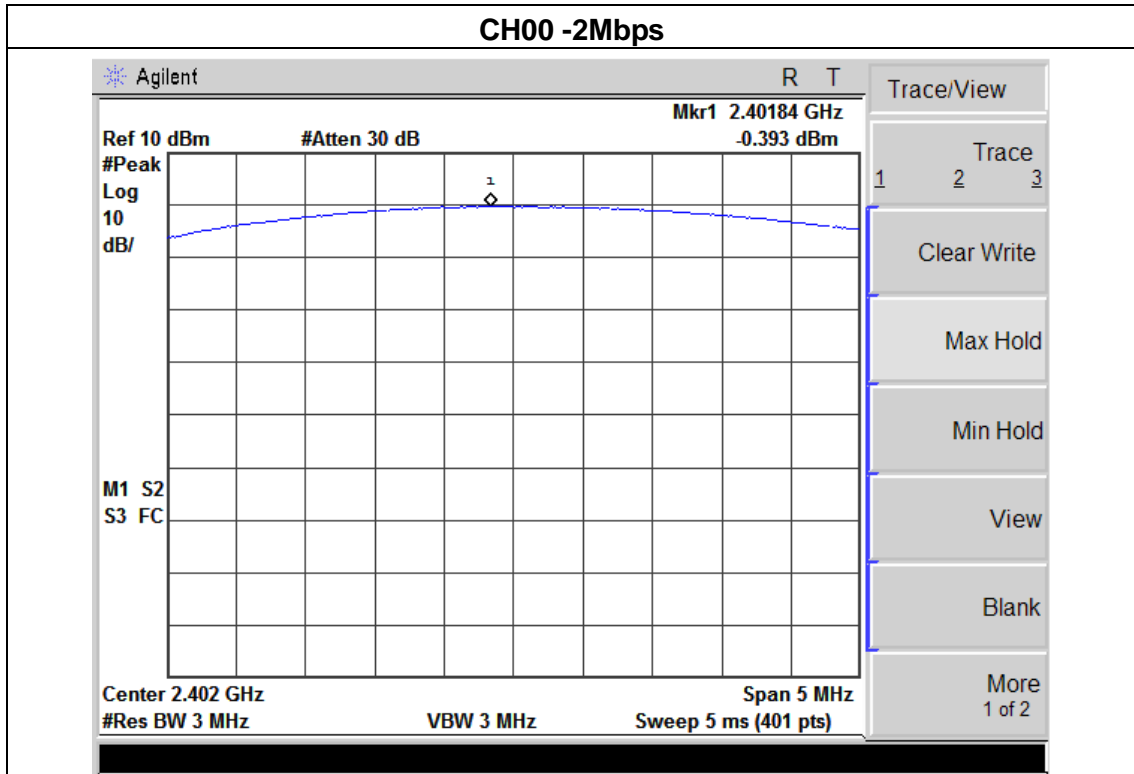

CH39 -2Mbps

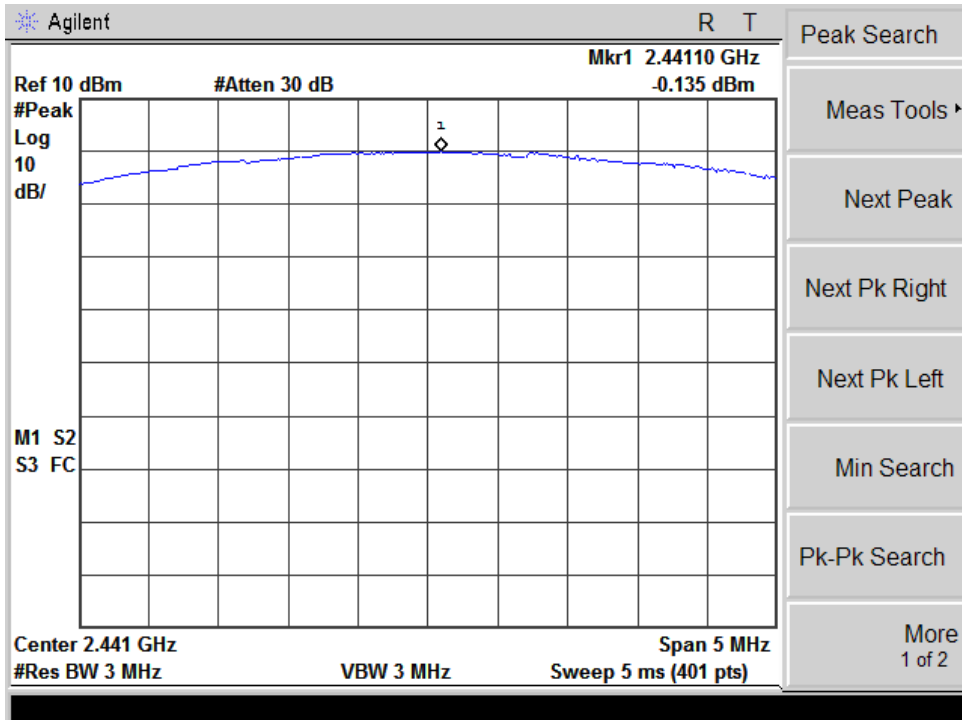

CH78 -2Mbps

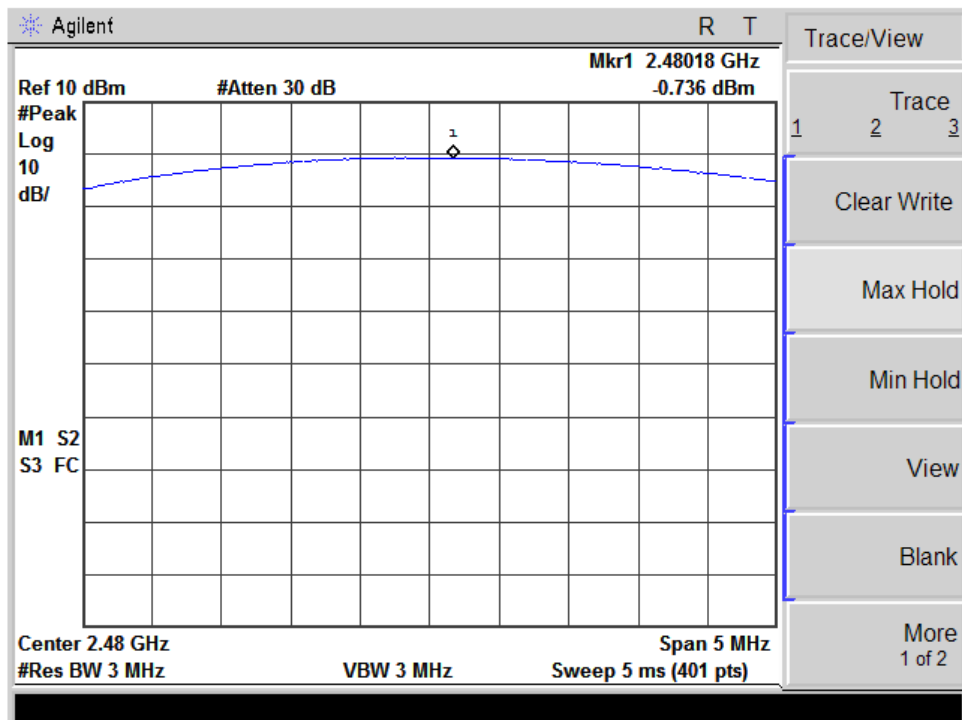

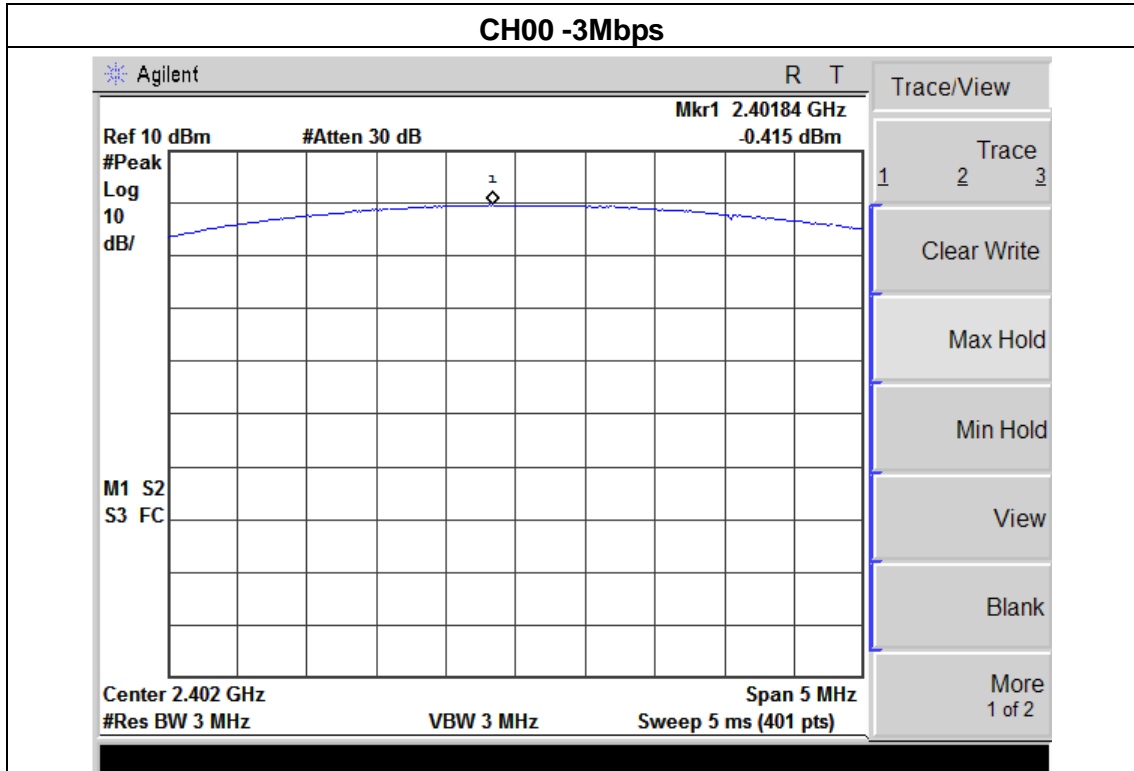

CH39 -3Mbps

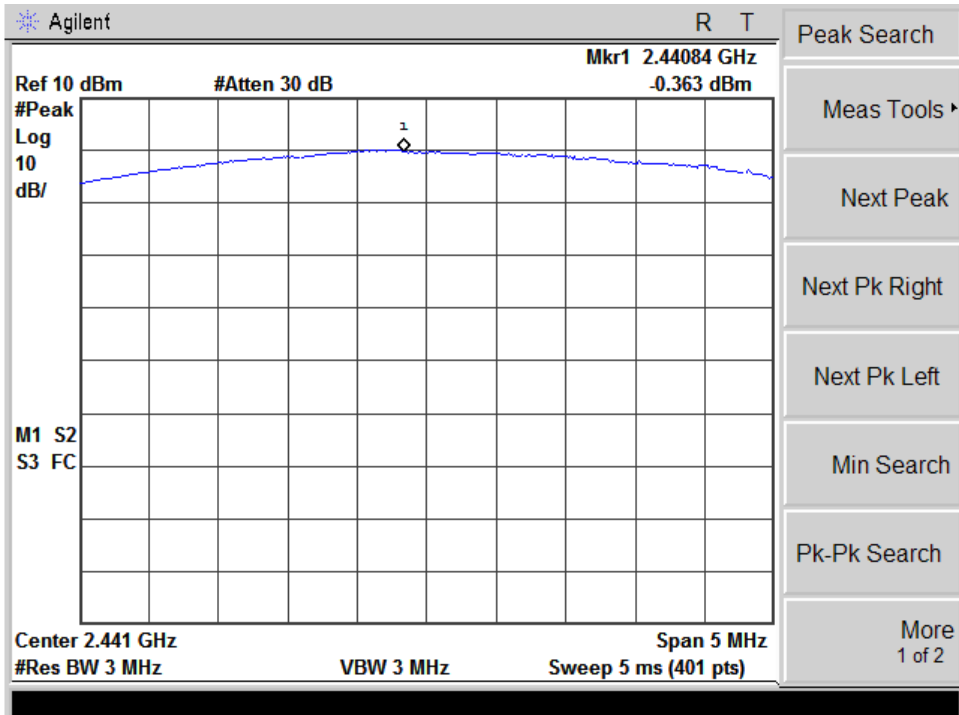

CH78 -3Mbps

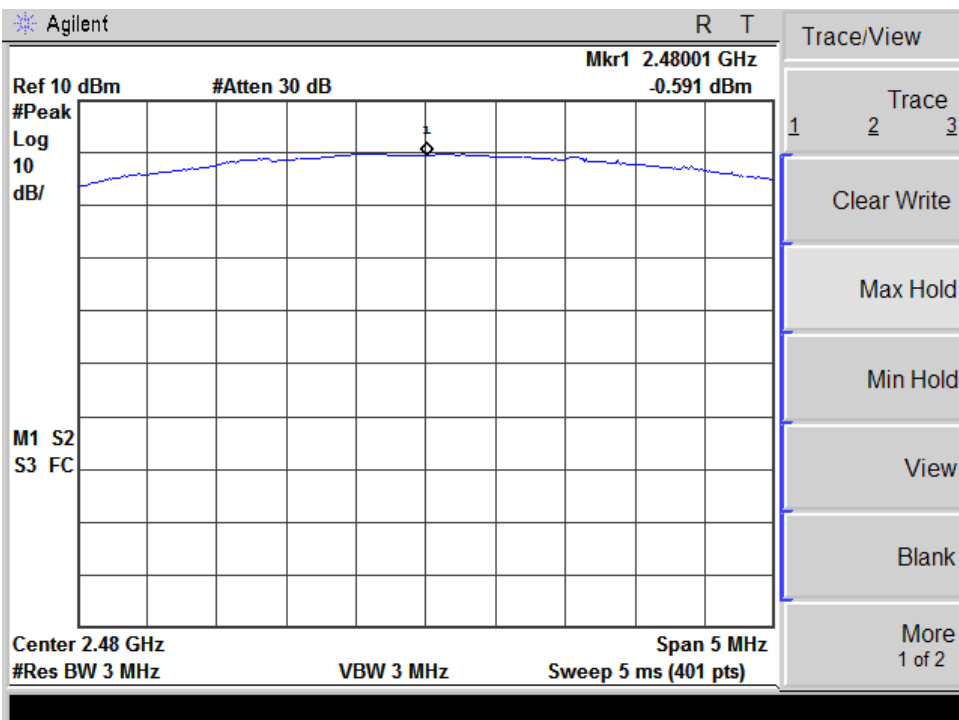

9. EQUAL HOPPING FREQUENCY USE

9.1 APPLIED PROCEDURES / LIMIT

Requirement: Each of the transmitter's hopping channels is used equally on average.

9.1.1 TEST RESULTS

Equal hopping frequency use

The EUT complies with the Bluetooth RF specifications. For details refer to the Bluetooth standard.

Pass

9.2 APPLIED PROCEDURES / LIMIT

Requirement: The hopping sequence is generated and provided with an example.

Hopping sequence

The channel is represented by a pseudo-random hopping sequence hopping through the 79 RF channels. The hopping sequence is unique for the piconet and is determined by the Bluetooth device address of the master. The X input determines the phase in the 32-hop segment, whereas Y1 and Y2 selects between master-to-slave and slave-to-master transmission. The inputs A to D determine the ordering within the segment, the inputs E and F determine the mapping onto the hop frequencies.

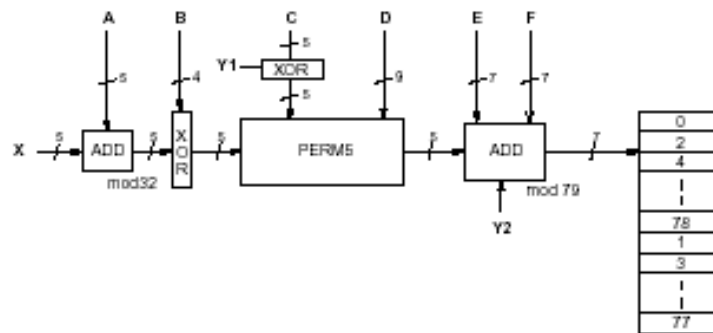

Example data:

Hop sequence {k} for CONNECTION STATE:

CLK start: 0x0000010

ULAP: 0x00000000

#ticks: 00 02 | 04 06 | 08 0a | 0c 0e | 10 12 | 14 16 | 18 1a | 1c 1e |

```

-----
0x0000010: 08 66 | 10 70 | 12 19 | 14 23 | 16 01 | 18 05 | 20 33 | 22 37 |
0x0000030: 24 03 | 26 07 | 28 35 | 30 39 | 32 72 | 34 76 | 36 25 | 38 29 |
0x0000050: 40 74 | 42 78 | 44 27 | 46 31 | 48 09 | 50 13 | 52 41 | 54 45 |
0x0000070: 56 11 | 58 15 | 60 43 | 62 47 | 32 17 | 36 19 | 34 49 | 38 51 |
0x0000090: 40 21 | 44 23 | 42 53 | 46 55 | 48 33 | 52 35 | 50 65 | 54 67 |
0x00000b0: 56 37 | 60 39 | 58 69 | 62 71 | 64 25 | 68 27 | 66 57 | 70 59 |
0x00000d0: 72 29 | 76 31 | 74 61 | 78 63 | 01 41 | 05 43 | 03 73 | 07 75 |
0x00000f0: 09 45 | 13 47 | 11 77 | 15 00 | 64 49 | 66 53 | 68 02 | 70 06 |
0x0000110: 01 51 | 03 55 | 05 04 | 07 08 | 72 57 | 74 61 | 76 10 | 78 14 |
0x0000130: 09 59 | 11 63 | 13 12 | 15 16 | 17 65 | 19 69 | 21 18 | 23 22 |
    
```

0x0000150: 33 67 | 35 71 | 37 20 | 39 24 | 25 73 | 27 77 | 29 26 | 31 30 |
0x0000170: 41 75 | 43 00 | 45 28 | 47 32 | 17 02 | 21 04 | 19 34 | 23 36 |
0x0000190: 33 06 | 37 08 | 35 38 | 39 40 | 25 10 | 29 12 | 27 42 | 31 44 |
0x00001b0: 41 14 | 45 16 | 43 46 | 47 48 | 49 18 | 53 20 | 51 50 | 55 52 |
0x00001d0: 65 22 | 69 24 | 67 54 | 71 56 | 57 26 | 61 28 | 59 58 | 63 60 |
0x00001f0: 73 30 | 77 32 | 75 62 | 00 64 | 49 34 | 51 42 | 57 66 | 59 74 |
0x0000210: 53 36 | 55 44 | 61 68 | 63 76 | 65 50 | 67 58 | 73 03 | 75 11 |
0x0000230: 69 52 | 71 60 | 77 05 | 00 13 | 02 38 | 04 46 | 10 70 | 12 78 |
0x0000250: 06 40 | 08 48 | 14 72 | 16 01 | 18 54 | 20 62 | 26 07 | 28 15 |
0x0000270: 22 56 | 24 64 | 30 09 | 32 17 | 02 66 | 06 74 | 10 19 | 14 27 |
0x0000290: 04 70 | 08 78 | 12 23 | 16 31 | 18 03 | 22 11 | 26 35 | 30 43 |
0x00002b0: 20 07 | 24 15 | 28 39 | 32 47 | 34 68 | 38 76 | 42 21 | 46 29 |
0x00002d0: 36 72 | 40 01 | 44 25 | 48 33 | 50 05 | 54 13 | 58 37 | 62 45 |
0x00002f0: 52 09 | 56 17 | 60 41 | 64 49 | 34 19 | 36 35 | 50 51 | 52 67 |
0x0000310: 38 21 | 40 37 | 54 53 | 56 69 | 42 27 | 44 43 | 58 59 | 60 75 |
0x0000330: 46 29 | 48 45 | 62 61 | 64 77 | 66 23 | 68 39 | 03 55 | 05 71 |
0x0000350: 70 25 | 72 41 | 07 57 | 09 73 | 74 31 | 76 47 | 11 63 | 13 00 |
0x0000370: 78 33 | 01 49 | 15 65 | 17 02 | 66 51 | 70 67 | 03 04 | 07 20 |
0x0000390: 68 55 | 72 71 | 05 08 | 09 24 | 74 59 | 78 75 | 11 12 | 15 28 |
0x00003b0: 76 63 | 01 00 | 13 16 | 17 32 | 19 53 | 23 69 | 35 06 | 39 22 |
0x00003d0: 21 57 | 25 73 | 37 10 | 41 26 | 27 61 | 31 77 | 43 14 | 47 30 |
0x00003f0: 29 65 | 33 02 | 45 18 | 49 34 | 19 04 | 21 08 | 23 20 | 25 24 |

10. RECEIVER INPUT BANDWIDTH

10.1 APPLIED PROCEDURES / LIMIT

Requirement: The associated receiver(s) complies with the requirement that its input bandwidth matches the bandwidth of the transmitted signal.

10.1.1 TEST RESULTS

Receiver input bandwidth

The receiver bandwidth is equal to the receiver bandwidth in the 79 hopping channel mode, which is 1 MHz. The receiver bandwidth was verified during Bluetooth RF conformance testing.

Pass

11. RECEIVER HOPPING CAPABILITY

11.1 APPLIED PROCEDURES / LIMIT

Requirement: The associated receiver has the ability to shift frequencies in synchronisation with the transmitted signals.

11.1.1 TEST RESULTS

Receiver hopping Capability

The EUT complies with the Bluetooth RF specifications. For details refer to the Bluetooth standard.

Pass

12. EUT TEST PHOTO

Radiated Measurement Photos

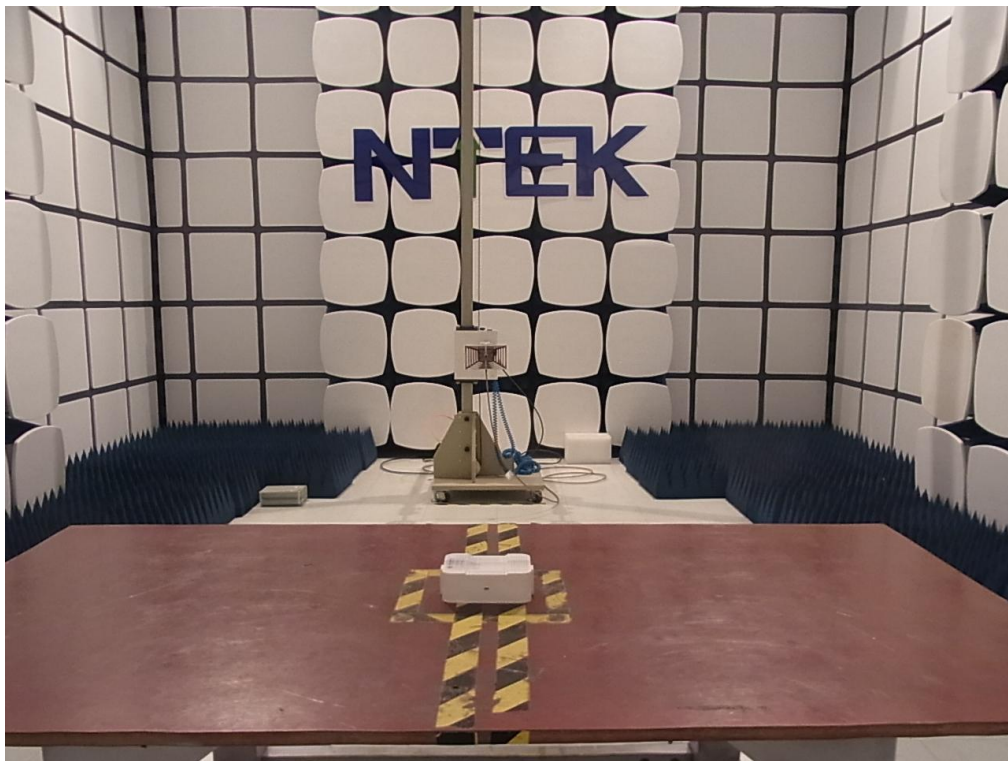
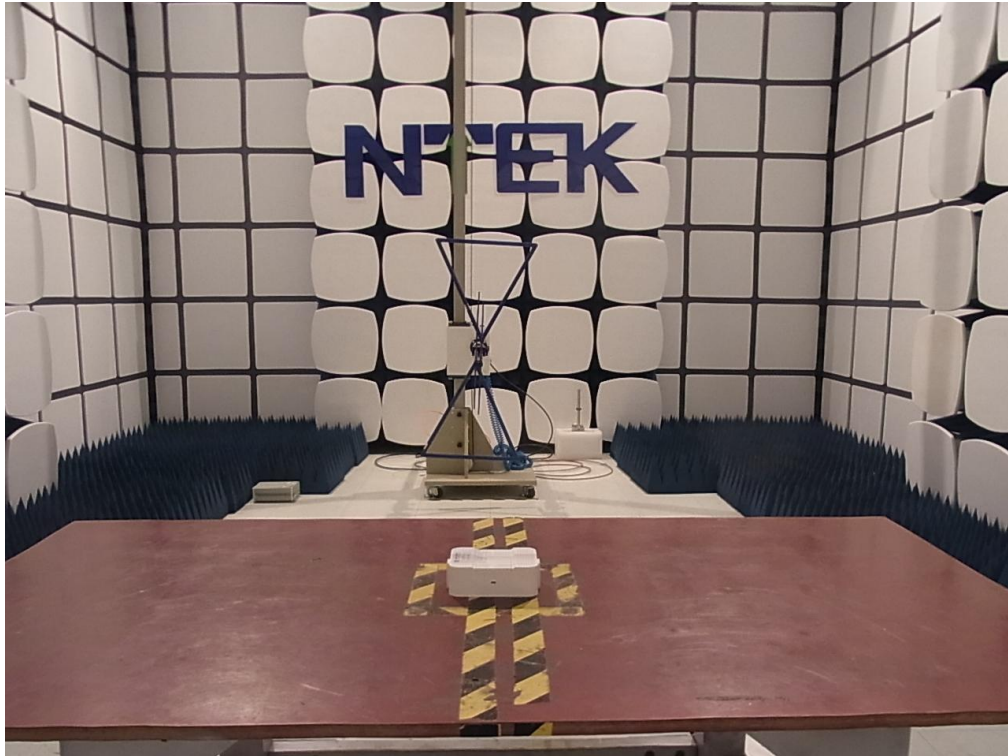

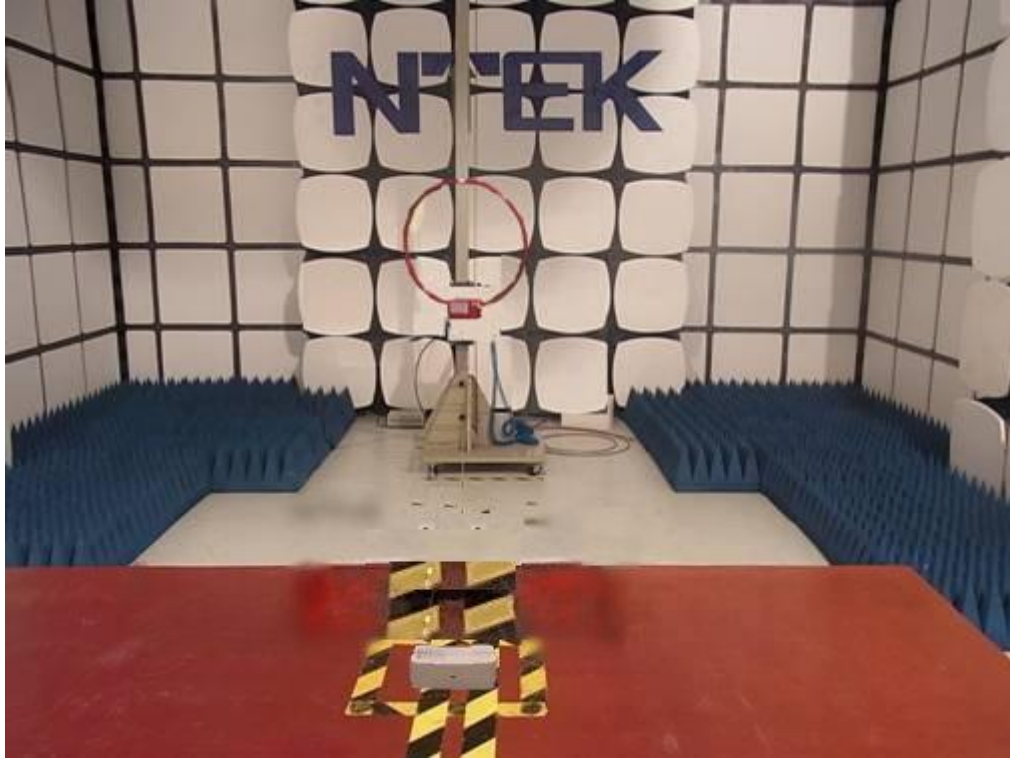

Conducted Measurement Photos

