



FCC RADIO TEST REPORT

Applicant : CASTLENET TECHNOLOGY INC.
Address : No. 14, Ln. 141, Sec. 3, Beishen Rd., Shenkeng
Dist., New Taipei City 22244, Taiwan (R.O.C.)
Equipment : D3.0 Cable Gateway
Model No. : 1. CBV384Z4-AC1600MP
2. Infinity401 N
Trade Name : CASTLENET
FCC ID : RK9-CBV384Z4C16MP

I HEREBY CERTIFY THAT :

The sample was received on Jun. 22, 2021 and the testing was completed on Aug. 23, 2021 at CerpPASS Technology Corp. The test result refers exclusively to the test presented test model / sample. Without written approval of CerpPASS Technology Corp., the test report shall not be reproduced except in full.

Approved by:

Mark Liao / Supervisor

Laboratory Accreditation:

CerpPASS Technology Corporation Test Laboratory





CONTENTS

- 1. Summary of Test Procedure and Test Results 5
 - 1.1. Applicable Standards5
- 2. Test Configuration of Equipment under Test 6
 - 2.1. Feature of Equipment under Test.....6
 - 2.2. Carrier Frequency of Channels 7
 - 2.3. Test Mode and Test Software8
 - 2.4. Description of Test System..... 10
 - 2.5. General Information of Test..... 11
 - 2.6. Measurement Uncertainty 11
- 3. Test Equipment and Ancillaries Used for Tests 12
- 4. Antenna Requirements 14
 - 4.1. Standard Applicable 14
 - 4.2. Antenna Construction and Directional Gain..... 14
- 5. Test of AC Power Line Conducted Emission 15
 - 5.1. Test Limit 15
 - 5.2. Test Procedures 15
 - 5.3. Typical Test Setup 16
 - 5.4. Test Result and Data 17
 - 5.5. Test Photographs 19
- 6. Test of Spurious Emission (Radiated) 20
 - 6.1. Test Limit 20
 - 6.2. Test Procedures 21
 - 6.3. Typical Test Setup 22
 - 6.4. Test Result and Data (9kHz ~ 30MHz)..... 23
 - 6.5. Test Result and Data (30MHz ~ 1GHz)..... 23
 - 6.6. Test Result and Data (1GHz ~ 40GHz)..... 25
 - 6.7. Restricted Bands of Operation 61
 - 6.8. Test Photographs (30MHz ~ 1GHz) 62
 - 6.9. Test Photographs (1GHz ~ 40GHz) 63
- 7. On Time, Duty Cycle and Measurement methods 65
 - 7.1. Test Limit 65
 - 7.2. Test Procedure 65
 - 7.3. Test Setup Layout 65
 - 7.4. Test Result and Data 66
 - 7.5. Measurement Methods 66
- 8. 6dB Bandwidth & 99% Occupied Bandwidth 68
 - 8.1. Test Limit 68
 - 8.2. Test Procedure 68
 - 8.3. Test Setup Layout 68
 - 8.4. Test Result and Data 69
- 9. 26dB Bandwidth & 99% Occupied Bandwidth 82
 - 9.1. Test Limit 82



- 9.2. Test Procedure82
- 9.3. Test Setup Layout82
- 9.4. Test Result and Data83
- 10. Average Power.....96
 - 10.1. Test Limit96
 - 10.2. Test Procedure97
 - 10.3. Test Setup Layout97
 - 10.4. Test Result and Data98
- 11. Power Spectral Density99
 - 11.1. Test Limit99
 - 11.2. Test Procedure99
 - 11.3. Test Setup Layout99
 - 11.4. Test Result and Data100
- 12. Radio Frequency Exposure113
 - 12.1. Applicable Standards113
 - 12.2. EUT Specification113
 - 12.3. Test Results113
 - 12.4. Calculation.....114
 - 12.5. Maximum Permissible Exposure114



History of this test report

Report No.	Issue Date	Description
21060187-TRFCC02	Aug. 31, 2021	Original



1. Summary of Test Procedure and Test Results

1.1. Applicable Standards

ANSI C63.10:2013

FCC Rules and Regulations Part 15 Subpart E §15.407

KDB 789033

FCC Rule	Description of Test	Result
15.203	Antenna Requirement	PASS
15.207(a)	AC Power Line Conducted Emission	PASS
15.407(b) 15.209	Radiated Spurious Emission	PASS
15.407(a)	26 dB & Occupied Bandwidth	PASS
15.407	6 dB Bandwidth	PASS
15.407 (a) & (a)(3)	Average Power	PASS
15.407(a)	Power Spectral Density	PASS
2.1091	Radio Frequency Exposure	PASS

*The lab has reduced the uncertainty risk factor from test equipment, environment and staff technicians which according to the standard on contract. Therefore, the test result will only be determined by standard requirement.



2. Test Configuration of Equipment under Test

2.1. Feature of Equipment under Test

Operation Frequency Range	802.11b/g/n: 2400-2483.5MHz 802.11a/n/ac: 5150-5250MHz, 5725-5850MHz
Center Frequency Range	802.11b/g/n: 2412MHz~2462MHz 802.11a/n/ac: 5180-5240MHz, 5745-5825MHz
Modulation Type	WLAN: 2.4GHz: 802.11b: CCK, DQPSK, DBPSK 802.11g/n: BPSK, QPSK, 16QAM, 64QAM 5GHz: 802.11n/a: BPSK, QPSK, 16QAM, 64QAM 802.11ac: BPSK, QPSK, 16QAM, 64QAM, 256QAM
Modulation Technology	DSSS, OFDM
Data Rate	WLAN: 2.4GHz: 802.11b: 1, 2, 5.5, 11Mbps 802.11g: 6, 9, 12, 18, 24, 36, 48, 54Mbps 802.11n: MCS0 – MCS15, HT20/40 5GHz: 802.11a: 6, 9, 12, 18, 24, 36, 48, 54Mbps 802.11n: MCS0 – MCS23, HT20/40 802.11ac: MCS0 – MCS9, VHT20/40/80
Antenna Type	Dipole Antenna
Antenna Gain	2400-2483.5MHz: ANT A: 4.41dBi, ANT C: 2.67dBi 5150-5250MHz: ANT A: 3.06dBi, ANT B: 4.23dBi, ANT C: 2.50dBi 5725-5850MHz: ANT A: 5.18dBi, ANT B: 3.56dBi, ANT C: 3.92dBi
Adapter	1.Brand: MOSO, Model: MS-V2000R120-024H0-US 2.Brand: AcBel, Model: WAM005

Note:

- 1.802.11b fix ANT A(AJ1) transmit signal.
- 2.EUT not support TPC Function.
- 3.For more details, please refer to the User's manual of the EUT.

Difference description:

Model No.	Remark
CBV384Z4-AC1600MP	For market distinction.
Infinity401 N	



2.2. Carrier Frequency of Channels

Band: 5150MHz-5250MHz

802.11a, 802.11n HT20, 802.11ac VHT20,

Channel	Frequency(MHz)	Channel	Frequency(MHz)
*36	5180	44	5220
*40	5200	*48	5240

802.11n HT40, 802.11ac VHT40,

Channel	Frequency(MHz)	Channel	Frequency(MHz)
*38	5190	*46	5230

802.11ac VHT80 ,

Channel	Frequency(MHz)
*42	5210

Band: 5725MHz -5850MHz

802.11a, 802.11n HT20, 802.11ac VHT20,

Channel	Frequency(MHz)	Channel	Frequency(MHz)
*149	5745	161	5805
153	5765	*165	5825
*157	5785		

802.11n HT40, 802.11ac VHT40,

Channel	Frequency(MHz)	Channel	Frequency(MHz)
*151	5755	*159	5795

802.11ac VHT80,

Channel	Frequency(MHz)
*155	5775

Note: Channels remarked * are selected to perform test.



2.3. Test Mode and Test Software

- a. During testing, the interface cables and equipment positions were varied according to ANSI C63.10.
- b. The complete test system included remote workstation and EUT for RF test. The remote workstation included Notebook.
- c. An executive program, " MTool ver.2.0.1.0" under Windows OS system was executed to transmit and receive data via WLAN.
- d. The following test modes were performed for the test:

Conducted Emissions from the AC mains power ports	
Test Mode	Operating Description
1	802.11a (6Mbps) , Adapter:MS-V2000R120-024H0-US
2	802.11n HT20 (6.5Mbps) , Adapter:MS-V2000R120-024H0-US
3	802.11n HT40 (13.5Mbps) , Adapter:MS-V2000R120-024H0-US
4	802.11ac VHT20 (6.5Mbps) , Adapter:MS-V2000R120-024H0-US
5	802.11ac VHT40 (13.5Mbps) , Adapter:MS-V2000R120-024H0-US
6	802.11ac VHT80 (29.3Mbps) , Adapter:MS-V2000R120-024H0-US
7	802.11a (6Mbps) , Adapter:WAM005
8	802.11n HT20 (6.5Mbps) , Adapter:WAM005
9	802.11n HT40 (13.5Mbps) , Adapter:WAM005
10	802.11ac VHT20 (6.5Mbps) , Adapter:WAM005
11	802.11ac VHT40 (13.5Mbps) , Adapter:WAM005
12	802.11ac VHT80 (29.3Mbps) , Adapter:WAM005
caused "Test Mode 4" generated the worst case, it was reported as the final data.	
Radiation Emissions (9KHz ~30MHz & 30MHz ~ 1GHz)	
Test Mode	Operating Description
1	802.11a (6Mbps) , Adapter:MS-V2000R120-024H0-US
2	802.11n HT20 (6.5Mbps) , Adapter:MS-V2000R120-024H0-US
3	802.11n HT40 (13.5Mbps) , Adapter:MS-V2000R120-024H0-US
4	802.11ac VHT20 (6.5Mbps) , Adapter:MS-V2000R120-024H0-US
5	802.11ac VHT40 (13.5Mbps) , Adapter:MS-V2000R120-024H0-US
6	802.11ac VHT80 (29.3Mbps) , Adapter:MS-V2000R120-024H0-US
7	802.11a (6Mbps) , Adapter:WAM005
8	802.11n HT20 (6.5Mbps) , Adapter:WAM005
9	802.11n HT40 (13.5Mbps) , Adapter:WAM005
10	802.11ac VHT20 (6.5Mbps) , Adapter:WAM005
11	802.11ac VHT40 (13.5Mbps) , Adapter:WAM005
12	802.11ac VHT80 (29.3Mbps) , Adapter:WAM005
caused "Test Mode 4" generated the worst case, it was reported as the final data.	



Radiation Emissions (1GHz ~ 40GHz)	
Test Mode	Operating Description
1	802.11a (6Mbps) , Adapter:MS-V2000R120-024H0-US
2	802.11n HT20 (6.5Mbps) , Adapter:MS-V2000R120-024H0-US
3	802.11n HT40 (13.5Mbps) , Adapter:MS-V2000R120-024H0-US
4	802.11ac VHT20 (6.5Mbps) , Adapter:MS-V2000R120-024H0-US
5	802.11ac VHT40 (13.5Mbps) , Adapter:MS-V2000R120-024H0-US
6	802.11ac VHT80 (29.3Mbps) , Adapter:MS-V2000R120-024H0-US
7	802.11a (6Mbps) , Adapter:WAM005
8	802.11n HT20 (6.5Mbps) , Adapter:WAM005
9	802.11n HT40 (13.5Mbps) , Adapter:WAM005
10	802.11ac VHT20 (6.5Mbps) , Adapter:WAM005
11	802.11ac VHT40 (13.5Mbps) , Adapter:WAM005
12	802.11ac VHT80 (29.3Mbps) , Adapter:WAM005

caused "Test Mode 1, 4~6" generated the worst case, they were reported as the final data.

The EUT incorporates a MIMO function

Modulation Type	TX CONFIGURATION
802.11a	3TX
802.11n HT20	3TX
802.11n HT40	3TX
802.11ac VHT20	3TX
802.11ac VHT40	3TX
802.11ac VHT80	3TX



2.4. Description of Test System

RF Conducted				
Equipment	Brand	Model	Length/Type	Power cord/Length/Type
Notebook	ASUS	P2430U	N/A	Adapter / 1.8m / NS
RJ45 Cable	N/A	N/A	1.2m / NS	N/A
Radiated Emissions				
Equipment	Brand	Model	Length/Type	Power cord/Length/Type
Notebook	DELL	Vostro 3560	N/A	Adapter / 1.8m / NS
RJ45 Cable	N/A	N/A	15m / NS	N/A
AC Power Line Conducted Emission				
Equipment	Brand	Model	Length/Type	Power cord/Length/Type
Notebook	DELL	Vostro 3560	N/A	Adapter / 1.8m / NS
RJ45 Cable	N/A	N/A	3m / NS	N/A

**2.5. General Information of Test**

Test Site	Cerpass Technology Corporation Test Laboratory Address: No.10, Ln. 2, Lianfu St., Luzhu Dist., Taoyuan City 33848, Taiwan (R.O.C.) Tel:+886-3-3226-888 Fax:+886-3-3226-881	
	FCC	TW1439, TW1079
	IC	4934E-1, 4934E-2
	VCCI	T-2205 for Telecommunication test C-4663 for Conducted emission test R-4218 for Radiated emission test G-10812, G-10813 for radiated disturbance above 1GHz
Frequency Range Investigated:	Conducted: from 150kHz to 30 MHz Radiation: from 30 MHz to 40,000MHz	
Test Distance:	The test distance of radiated emission from antenna to EUT is 3 M.	

Test Item	Test Site	Test period	Environmental Conditions	Tested By
RF Conducted	RFCON01-NK	2021/08/19~2021/08/20	25~26°C / 47~49%	Nick Guan
Radiated Emissions	3M02-NK	2021/08/18~2021/08/19	22~23°C / 43~46%	Nick Guan
AC Power Line Conducted Emission	CON01-NK	2021/08/23	27°C / 55%	Dian Chen

2.6. Measurement Uncertainty

Measurement Item	Uncertainty
AC Power Line Conduction(150K~30MHz)	±3.63dB
Radiated Spurious Emission(9KHz~30MHz)	±3.4dB
Radiated Spurious Emission(30MHz~1GHz)	±5.6dB
Radiated Spurious Emission(1GHz~40GHz)	±6.6dB
6dB Bandwidth	±4.4%
26dB Bandwidth	±4.4%
Occupied Bandwidth	±4.4%
Peak Output Power(Conducted Power Meter)	±1.1dB
Power Spectral Density	±1.8dB
Duty Cycle	±1.5%
Frequency Stability	±0.26KHz



3. Test Equipment and Ancillaries Used for Tests

Test Item	Radiated Emissions				
Test Site	Semi Anechoic Room(3M02-NK)				
Instrument	Manufacturer	Model No	Serial No	Calibration Date	Valid Date
Bilog Antenna	Schwarzbeck	VULB9168	369	2021/04/26	2022/04/25
Active Loop Antenna	EMCO	6507	40855	2021/06/10	2022/06/09
Horn Antenna	EMCO	3115	31601	2020/10/16	2021/10/15
Horn Antenna	EMCO	3116	31974	2020/09/24	2021/09/23
EMI Receiver	ROHDE & SCHWARZ	ESCI	101423	2021/06/30	2022/06/29
Spectrum Analyzer	ROHDE & SCHWARZ	FSV 40-N	102151	2021/07/14	2022/07/13
Preamplifier	EM Electronics corp.	EM330	60658	2020/10/20	2021/10/19
Preamplifier	EM Electronics corp.	EM330	60660	2021/03/18	2022/03/17
Preamplifier	Agilent	8449B	3008A01954	2021/03/22	2022/03/21
Preamplifier	EMC INSTRUMENTS	EMC184045	980065	2020/11/06	2021/11/05
Bluetooth Tester	ROHDE & SCHWARZ	CBT	101133	2021/04/19	2022/04/18
Cable-3in1(30M-1G)	HARBOUR INDUSTRIES	LL142	CCE1315	2021/04/12	2022/04/11
Cable-0.5m(1G-18G)	EMEC	EM104-SMSM-0.5M	CCE1354	2021/05/06	2022/05/05
Cable-3m(1G-18G)	EMEC	EM104-SMSM-3M	CCE1355	2021/05/06	2022/05/05
Cable-8m(1G-18G)	EMEC	EM104-SMSM-8M	CCE1356	2021/05/06	2022/05/05
Cable-0.5m(30M-40G)	HUBER SUHNER	SUCOFLEX 102	28420/2	2021/04/03	2022/04/02
Cable-3m(30M-40G)	HUBER SUHNER	SUCOFLEX 102	MY2608/2	2021/04/09	2022/04/08
Cable-0.5m(1G-40G)	Rapidtek	40GHZ 50CM	38MS-38MS50314	2021/04/08	2022/04/07
Cable-6m(9k~300M)	NA	EMC5D-BM-BM-6	130605	2020/09/18	2021/09/17
E3	AUDIX	v8.2014-8-6	RK-000529	NA	NA

Test Item	RF Conducted				
Test Site	RFCON01-NK				
Instrument	Manufacturer	Model No	Serial No	Calibration Date	Valid Date
Spectrum Analyzer	ROHDE & SCHWARZ	FSV 40-N	102151	2021/07/14	2022/07/13
Bluetooth Tester	ROHDE & SCHWARZ	CBT	101133	2021/04/19	2022/04/18
CAX Signal Analyzer	KEYSIGHT	N9000B	MY57100339	2020/12/25	2021/12/24
Attenuator	KEYSIGHT	8491B	MY39250703	2021/04/09	2022/04/08
TEMP & HUMI CHAMBER	T-MACHINE	TMJ-9712	T-12-040111	2020/08/25	2021/08/24
Power Meter	Anritsu	ML2495A	1224005	2021/04/14	2022/04/13
Power Sensor	Anritsu	MA2411B	1207295	2021/04/14	2022/04/13



Test Item	AC Power Line Conducted Emission				
Test Site	CON01-NK				
Instrument	Manufacturer	Model No	Serial No	Calibration Date	Valid Date
EMI Receiver	ROHDE & SCHWARZ	ESCI	100821	2020/09/11	2021/09/10
Line Impedance Stabilization Network	Schwarzbeck	NSLK 8127	8127-516	2020/09/26	2021/09/25
Pulse Limiter	ROHDE & SCHWARZ	ESH3-Z2	101933	2020/09/17	2021/09/16
Cable-6m(9k~300M)	NA	EMC5D-BM-BM-6	130605	2020/09/18	2021/09/17
E3	AUDIX	v8.2014-8-6	RK-000531	NA	NA



4. Antenna Requirements

4.1. Standard Applicable

For intentional device, according to FCC 47 CFR Section 15.203, an intentional radiator shall be designed to ensure that no antenna other than that furnished by the responsible party shall be used with the device.

And according to FCC 47 CFR Section 15.407 (a), if transmitting antennas of directional gain greater than 6dBi are used, the power shall be reduced by the amount in dB that the directional gain of the antenna exceeds 6dBi.

4.2. Antenna Construction and Directional Gain

Antenna Type	Dipole Antenna
Antenna Gain	5180-5240MHz: ANT A: 3.06dBi ,ANT B: 4.23dBi, ANT C: 2.50dBi 5745-5825MHz: ANT A: 5.18dBi ,ANT B: 3.56dBi, ANT C: 3.92dBi

5180MHz -5240MHz
For Power directional gain= $G_{ant} = 4.23$ (dBi) For PSD directional gain = $10 \log[(10^{G1/20} + 10^{G2/20})^2 / N_{ANT}] = 8.06$ (dBi)
5745MHz -5825MHz
For Power directional gain= $G_{ant} = 5.18$ (dBi) For PSD directional gain = $10 \log[(10^{G1/20} + 10^{G2/20})^2 / N_{ANT}] = 9.02$ (dBi)



5. Test of AC Power Line Conducted Emission

5.1. Test Limit

Conducted Emissions were measured from 150 kHz to 30 MHz with a bandwidth of 9 KHz, according to the methods defined in ANSI C63.4-2014. The EUT was placed on a nonmetallic stand in a shielded room 0.8 meters above the ground plane. The interface cables and equipment positioning were varied within limits of reasonable applications to determine the position produced maximum conducted emissions.

Frequency (MHz)	Quasi Peak (dB μ V)	Average (dB μ V)
0.15 – 0.5	66-56*	56-46*
0.5 – 5.0	56	46
5.0 – 30.0	60	50

*Decreases with the logarithm of the frequency.

5.2. Test Procedures

- The EUT was placed 0.4 meter from the conducting wall of the shielding room was kept at least 80 centimeters from any other grounded conducting surface.
- Connect EUT to the power mains through a line impedance stabilization network (LISN).
- All the support units are connecting to the other LISN.
- The LISN provides 50 ohm coupling impedance for the measuring instrument.
- The FCC states that a 50 ohm, 50 micro-Henry LISN should be used.
- Both sides of AC line were checked for maximum conducted interference.
- The frequency range from 150 kHz to 30 MHz was searched.
- Set the test-receiver system to Peak Detect Function and Specified Bandwidth with Maximum Hold Mode.



5.3. Typical Test Setup

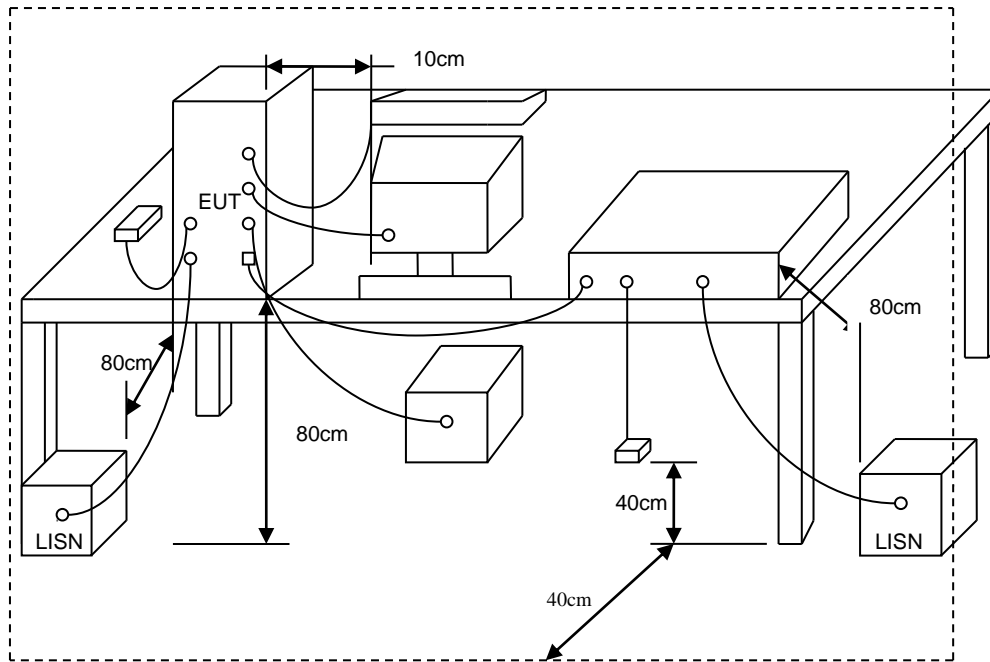



5.4. Test Result and Data

Power	: AC 120V / 60Hz	Pol/Phase	: LINE
Test Mode	: Mode 4		:

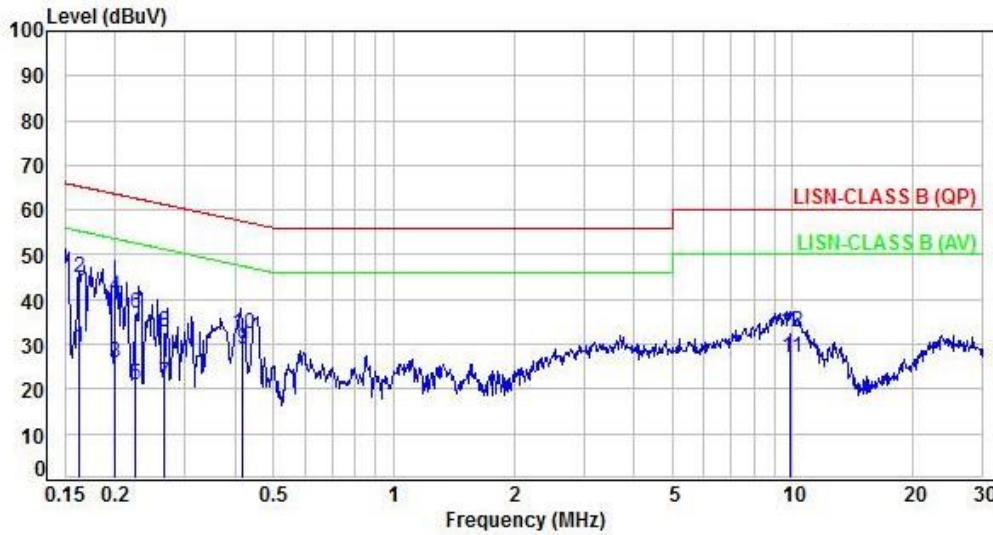

No.	Frequency (MHz)	Factor (dB)	Reading (dBuV)	Level (dBuV)	Limit (dBuV)	Margin (dB)	Detector	P/F
1	0.16	9.96	19.13	29.09	55.32	-26.23	Average	P
2	0.16	9.96	34.93	44.89	65.32	-20.43	QP	P
3	0.20	9.96	15.99	25.95	53.65	-27.70	Average	P
4	0.20	9.96	30.64	40.60	63.65	-23.05	QP	P
5	0.22	9.96	11.10	21.06	52.65	-31.59	Average	P
6	0.22	9.96	26.75	36.71	62.65	-25.94	QP	P
7	0.26	9.96	11.29	21.25	51.28	-30.03	Average	P
8	0.26	9.96	22.72	32.68	61.28	-28.60	QP	P
9	0.42	9.97	18.76	28.73	47.51	-18.78	Average	P
10	0.42	9.97	22.32	32.29	57.51	-25.22	QP	P
11	9.90	10.57	16.60	27.17	50.00	-22.83	Average	P
12	9.90	10.57	22.13	32.70	60.00	-27.30	QP	P

Note: Level=Reading+Factor
Margin=Level-Limit
Factor=(LISN or ISN or Current Probe)Factor + Cable Loss



Power	: AC 120V / 60Hz	Pol/Phase	: NEUTRAL
Test Mode	: Mode 4		

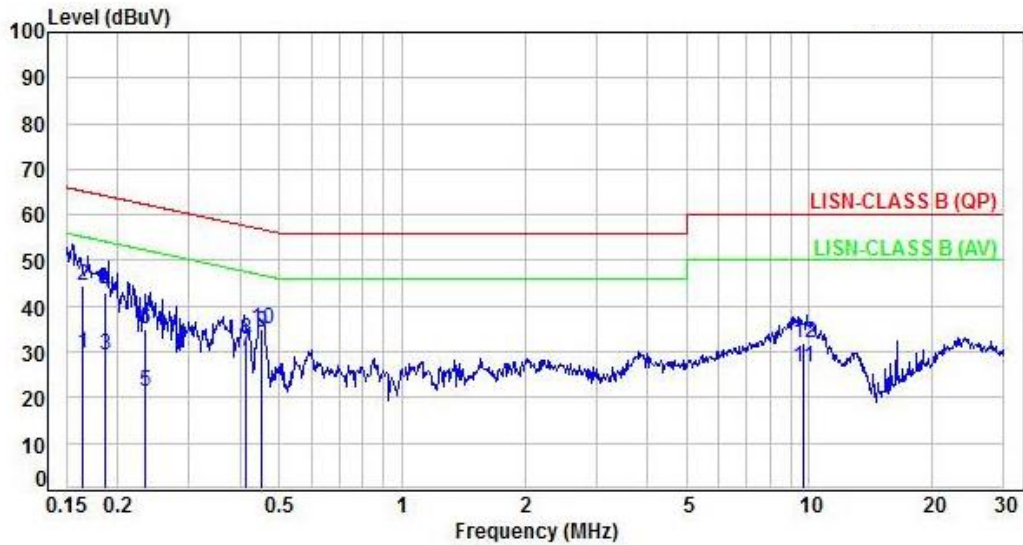

No.	Frequency (MHz)	Factor (dB)	Reading (dBuV)	Level (dBuV)	Limit (dBuV)	Margin (dB)	Detector	P/F
1	0.16	9.97	19.51	29.48	55.23	-25.75	Average	P
2	0.16	9.97	34.52	44.49	65.23	-20.74	QP	P
3	0.19	9.97	19.14	29.11	54.20	-25.09	Average	P
4	0.19	9.97	32.94	42.91	64.20	-21.29	QP	P
5	0.23	9.97	11.42	21.39	52.29	-30.90	Average	P
6	0.23	9.97	25.02	34.99	62.29	-27.30	QP	P
7	0.41	9.98	20.15	30.13	47.60	-17.47	Average	P
8	0.41	9.98	22.88	32.86	57.60	-24.74	QP	P
9	0.45	9.98	24.37	34.35	46.82	-12.47	Average	P
10	0.45	9.98	25.07	35.05	56.82	-21.77	QP	P
11	9.64	10.47	16.30	26.77	50.00	-23.23	Average	P
12	9.64	10.47	21.66	32.13	60.00	-27.87	QP	P

Note: Level=Reading+Factor
 Margin=Level-Limit
 Factor=(LISN or ISN or Current Probe)Factor + Cable Loss



6. Test of Spurious Emission (Radiated)

6.1. Test Limit

Undesirable emission limits. Except as shown in paragraph (b)(7) of this section, the maximum emissions outside of the frequency bands of operation shall be attenuated in accordance with the following limits:

- (1) For transmitters operating in the 5.15-5.25 GHz band: All emissions outside of the 5.15-5.35 GHz band shall not exceed an e.i.r.p. of -27 dBm/MHz.
- (2) For transmitters operating in the 5.25-5.35 GHz band: All emissions outside of the 5.15-5.35 GHz band shall not exceed an e.i.r.p. of -27 dBm/MHz.
- (3) For transmitters operating in the 5.47-5.725 GHz band: All emissions outside of the 5.47-5.725 GHz band shall not exceed an e.i.r.p. of -27 dBm/MHz.
- (4) For transmitters operating in the 5.725-5.85 GHz band:
All emissions shall be limited to a level of -27 dBm/MHz at 75 MHz or more above or below the band edge increasing linearly to 10 dBm/MHz at 25 MHz above or below the band edge, and from 25MHz above or below the band edge increasing linearly to a level of 15.6 dBm/MHz at 5 MHz above or below the band edge, and from 5 MHz above or below the band edge increasing linearly to a level of 27dBm/MHz at the band edge.
- (5) The emission measurements shall be performed using a minimum resolution bandwidth of 1 MHz. A lower resolution bandwidth may be employed near the band edge, when necessary, provided the measured energy is integrated to show the total power over 1 MHz.
- (6) Unwanted emissions below 1 GHz must comply with the general field strength limits set forth in §15.209. Further, any U-NII devices using an AC power line are required to comply also with the conducted limits set forth in §15.207.
- (7) The provisions of §15.205 apply to intentional radiators operating under this section.
- (8) When measuring the emission limits, the nominal carrier frequency shall be adjusted as close to the upper and lower frequency band edges as the design of the equipment permits.



6.2. Test Procedures

- a. The EUT was placed on a rotatable table top 0.8 meter above ground.
- b. The EUT was set 3 meters from the interference receiving antenna which was mounted on the top of a variable height antenna tower.
- c. The table was rotated 360 degrees to determine the position of the highest radiation.
- d. The antenna is a broadband antenna and its height is varied between one meter and four meters above ground to find the maximum value of the field strength both horizontal polarization and vertical polarization of the antenna are set to make the measurement.
- e. For each suspected emission the EUT was arranged to its worst case and then tune the antenna tower (from 1 M to 4 M) and turn table (from 0 degree to 360 degrees) to find the maximum reading.
- f. Set the test-receiver system to Peak or CISPR quasi-peak Detect Function and specified bandwidth with Maximum Hold Mode.
- g. If the emission level of the EUT in peak mode was 3 dB lower than the limit specified, then testing will be stopped and peak values of EUT will be reported, otherwise, the emissions which do not have 3 dB margin will be repeated one by one using the quasi-peak method and reported.
- h. For testing above 1GHz, the emission level of the EUT in peak mode was 20dB lower than average limit (that means the emission level in peak mode also complies with the limit in average mode), then testing will be stopped and peak values of EUT will be reported, otherwise, the emissions will be measured in average mode again and reported.
- i. "Cone of radiation" has been considered to be 3dB bandwidth of the measurement antenna.

Note:

- 1.The supporting fixture shall permit orientation of the EUT in each of three orthogonal axis positions such that emissions from the EUT are maximized.
(Y-AXIS is the worst.)
- 2.Due to the test software function limit the operation band setting(200dBuV/m). There's no corresponding limitation in the actual test item.



6.3. Typical Test Setup

Below 30MHz test setup

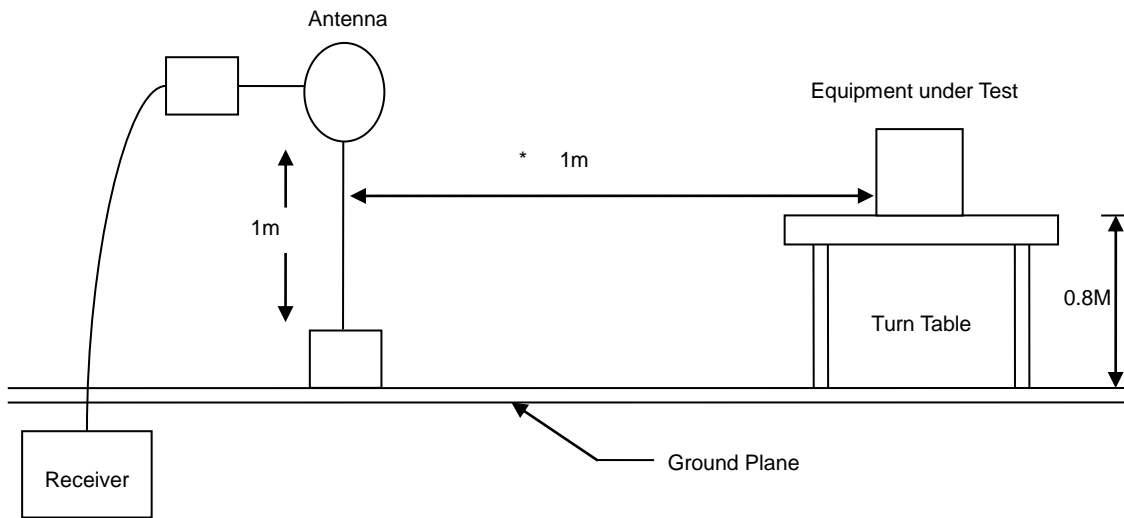

30MHz- 1GHz Test Setup

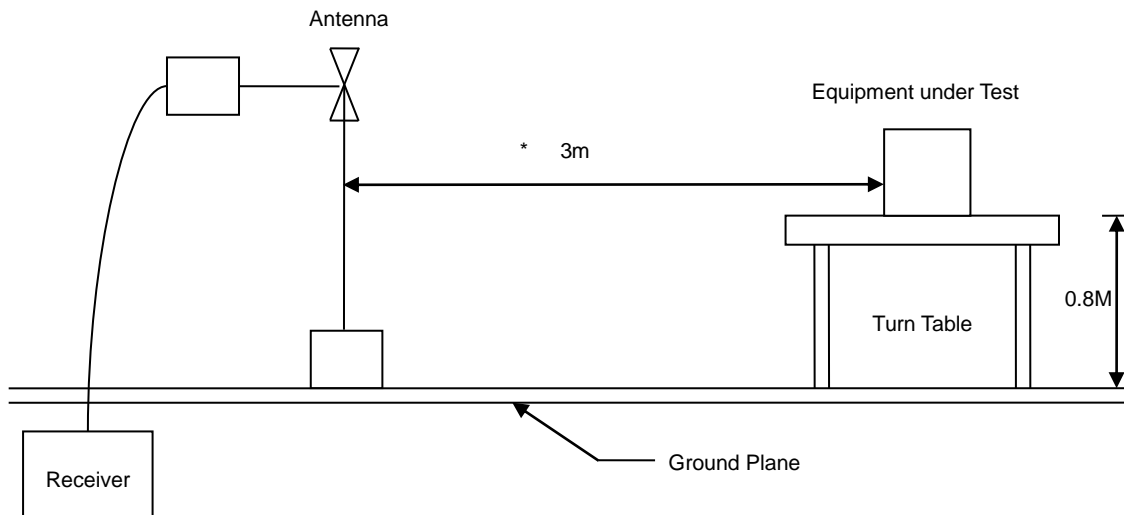

Above 1GHz Test Setup

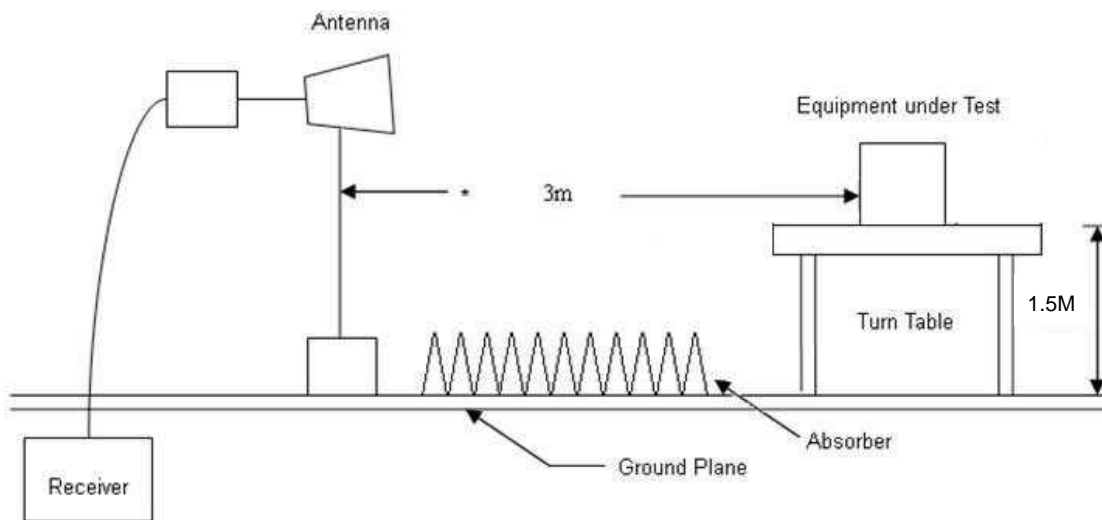



6.4. Test Result and Data (9kHz ~ 30MHz)

The 9kHz - 30MHz spurious emission is under limit 20dB more.

6.5. Test Result and Data (30MHz ~ 1GHz)

Power	: AC 120V / 60Hz	Pol/Phase	: VERTICAL
Test Mode	: Mode 4		:

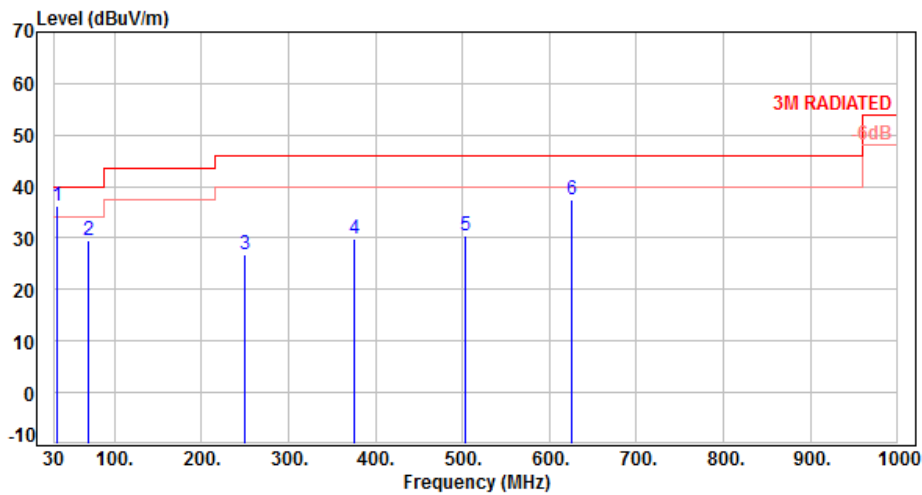

No.	Frequency (MHz)	Factor (dB)	Reading (dBuV)	Level (dBuV/m)	Limit (dBuV/m)	Margin (dB)	Detector	Height (cm)	Azimuth (deg)	P/F
1	33.88	-11.81	48.16	36.35	40.00	-3.65	QP	100	358	P
2	70.74	-13.11	42.58	29.47	40.00	-10.53	QP	100	353	P
3	249.22	-11.58	38.28	26.70	46.00	-19.30	Peak	400	0	P
4	375.32	-7.72	37.47	29.75	46.00	-16.25	Peak	400	0	P
5	503.36	-4.69	35.02	30.33	46.00	-15.67	Peak	400	0	P
6	625.58	-2.03	39.38	37.35	46.00	-8.65	Peak	400	0	P

Note: Level=Reading+Factor
Margin=Level-Limit
Factor=Antenna Factor + cable loss - Amplifier Factor



Power	: AC 120V / 60Hz	Pol/Phase	: HORIZONTAL
Test Mode	: Mode 4		:

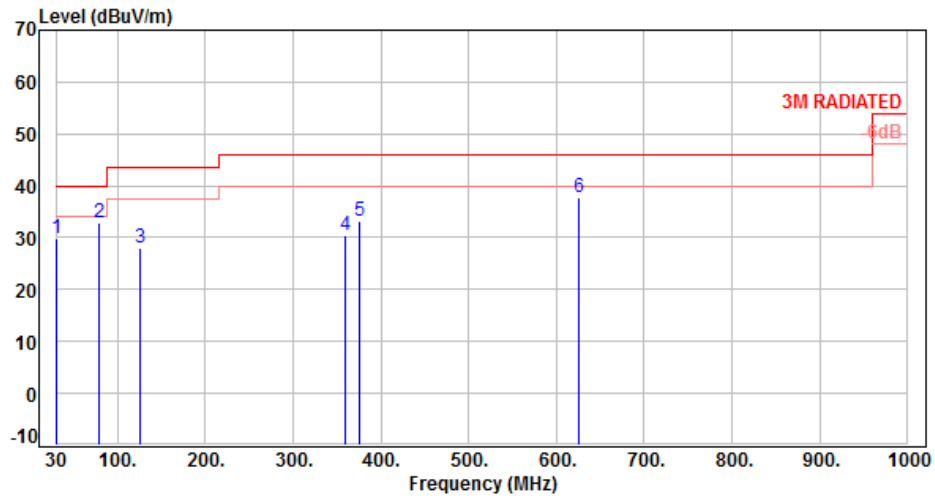

No.	Frequency (MHz)	Factor (dB)	Reading (dBuV)	Level (dBuV/m)	Limit (dBuV/m)	Margin (dB)	Detector	Height (cm)	Azimuth (deg)	P/F
1	30.00	-11.62	41.48	29.86	40.00	-10.14	Peak	400	360	P
2	78.50	-14.39	47.17	32.78	40.00	-7.22	Peak	400	360	P
3	125.06	-12.46	40.35	27.89	43.50	-15.61	Peak	400	360	P
4	359.80	-8.19	38.53	30.34	46.00	-15.66	Peak	400	360	P
5	375.32	-7.72	40.91	33.19	46.00	-12.81	Peak	400	360	P
6	625.58	-2.03	39.67	37.64	46.00	-8.36	Peak	400	360	P

Note: Level=Reading+Factor
Margin=Level-Limit
Factor=Antenna Factor + cable loss - Amplifier Factor



6.6. Test Result and Data (1GHz ~ 40GHz)

Power	: AC 120V / 60Hz	Pol/Phase	: VERTICAL
Test Mode	: Mode 1, Band 1, CH36		

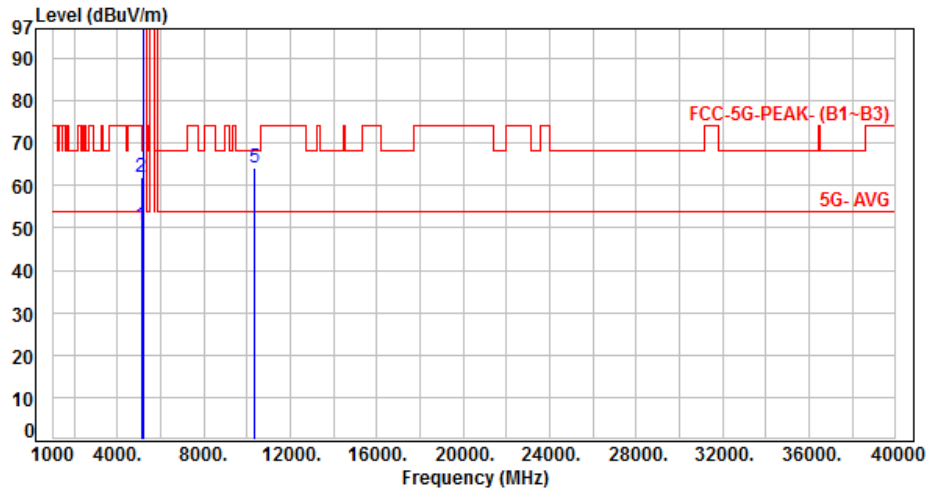

No.	Frequency (MHz)	Factor (dB)	Reading (dBuV)	Level (dBuV/m)	Limit (dBuV/m)	Margin (dB)	Detector	Height (cm)	Azimuth (deg)	P/F
1	5101.00	4.56	45.81	50.37	54.00	-3.63	Average	236	179	P
2	5101.00	4.56	57.47	62.03	74.00	-11.97	Peak	236	179	P
3	5180.00	4.66	98.44	103.10	200.00	-96.90	Average	236	179	P
4	5180.00	4.66	108.18	112.84	200.00	-87.16	Peak	236	179	P
5	10360.00	11.51	52.61	64.12	68.20	-4.08	Peak	100	79	P

Note: Level=Reading+Factor
Margin=Level-Limit
Factor=Antenna Factor + cable loss - Amplifier Factor



Power	: AC 120V / 60Hz	Pol/Phase	: HORIZONTAL
Test Mode	: Mode 1, Band 1, CH36		:

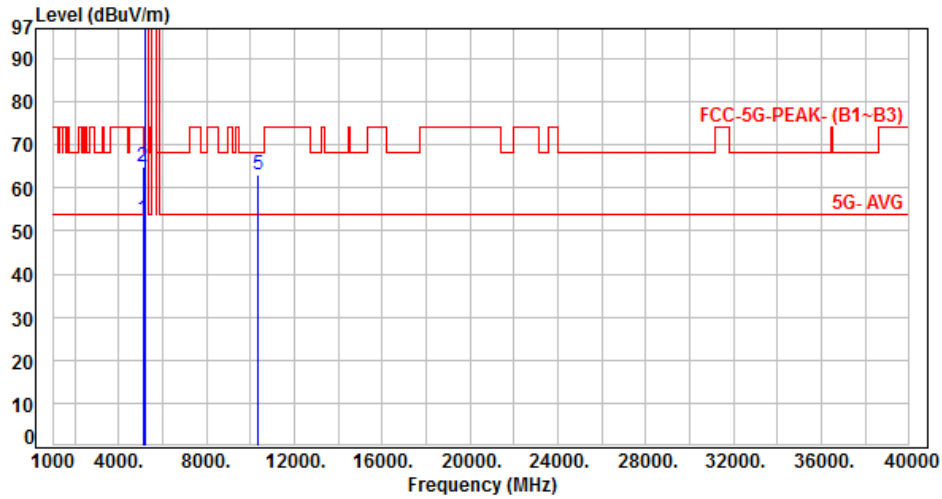

No.	Frequency (MHz)	Factor (dB)	Reading (dBuV)	Level (dBuV/m)	Limit (dBuV/m)	Margin (dB)	Detector	Height (cm)	Azimuth (deg)	P/F
1	5101.00	4.56	48.25	52.81	54.00	-1.19	Average	100	28	P
2	5101.00	4.56	60.19	64.75	74.00	-9.25	Peak	100	28	P
3	5180.00	4.66	100.03	104.69	200.00	-95.31	Average	100	28	P
4	5180.00	4.66	109.23	113.89	200.00	-86.11	Peak	100	28	P
5	10360.00	11.51	51.43	62.94	68.20	-5.26	Peak	125	191	P

Note: Level=Reading+Factor
Margin=Level-Limit
Factor=Antenna Factor + cable loss - Amplifier Factor



Power	: AC 120V / 60Hz	Pol/Phase	: VERTICAL
Test Mode	: Mode 1, Band 1, CH40		:

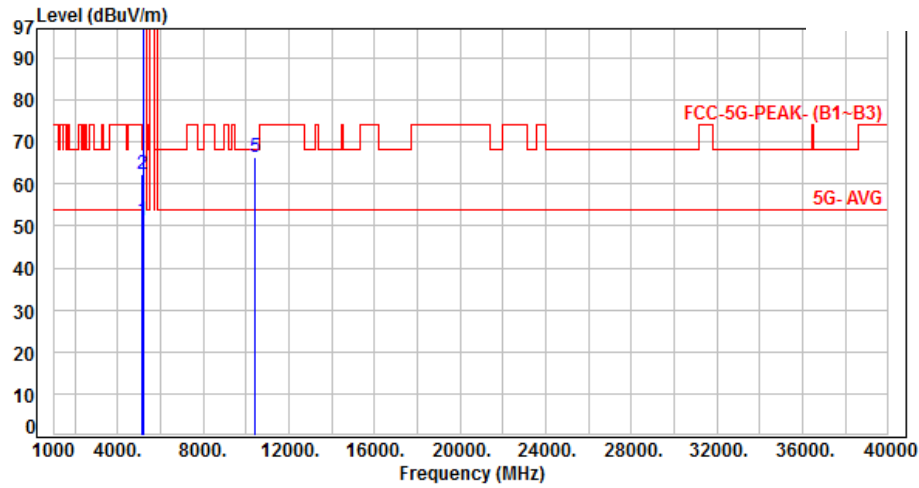

No.	Frequency (MHz)	Factor (dB)	Reading (dBUV)	Level (dBUV/m)	Limit (dBUV/m)	Margin (dB)	Detector	Height (cm)	Azimuth (deg)	P/F
1	5121.00	4.62	46.79	51.41	54.00	-2.59	Average	129	186	P
2	5121.00	4.62	57.55	62.17	74.00	-11.83	Peak	129	186	P
3	5200.00	4.63	97.87	102.50	200.00	-97.50	Average	129	186	P
4	5200.00	4.63	107.50	112.13	200.00	-87.87	Peak	129	186	P
5	10400.00	11.57	54.96	66.53	68.20	-1.67	Peak	102	83	P

Note: Level=Reading+Factor
Margin=Level-Limit
Factor=Antenna Factor + cable loss - Amplifier Factor



Power	: AC 120V / 60Hz	Pol/Phase	: HORIZONTAL
Test Mode	: Mode 1, Band 1, CH40		:

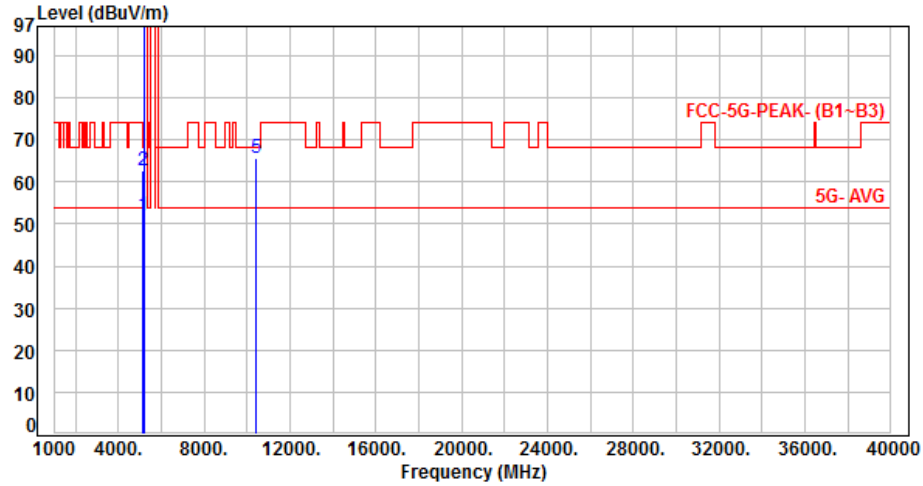

No.	Frequency (MHz)	Factor (dB)	Reading (dBuV)	Level (dBuV/m)	Limit (dBuV/m)	Margin (dB)	Detector	Height (cm)	Azimuth (deg)	P/F
1	5118.00	4.61	47.28	51.89	54.00	-2.11	Average	235	118	P
2	5118.00	4.61	57.91	62.52	74.00	-11.48	Peak	235	118	P
3	5200.00	4.63	100.27	104.90	200.00	-95.10	Average	235	118	P
4	5200.00	4.63	110.23	114.86	200.00	-85.14	Peak	235	118	P
5	10400.00	11.57	53.94	65.51	68.20	-2.69	Peak	115	189	P

Note: Level=Reading+Factor
 Margin=Level-Limit
 Factor=Antenna Factor + cable loss - Amplifier Factor



Power	: AC 120V / 60Hz	Pol/Phase	: VERTICAL
Test Mode	: Mode 1, Band 1, CH48		:

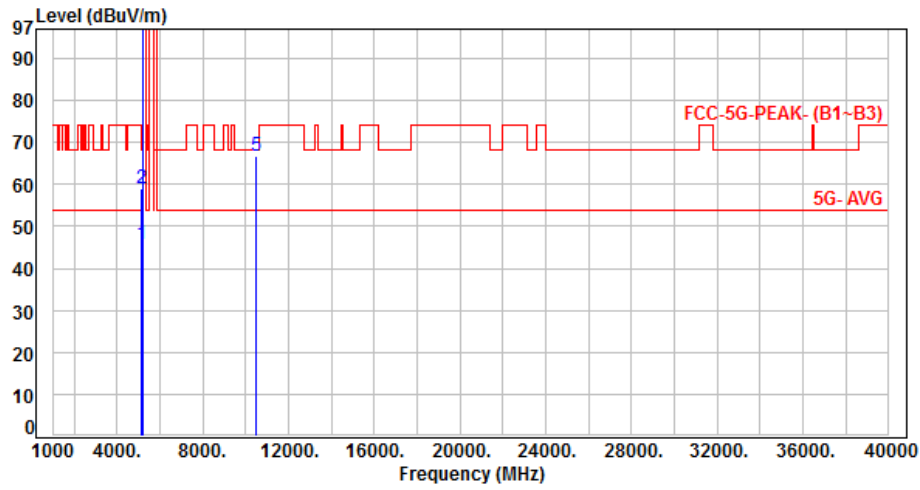

No.	Frequency (MHz)	Factor (dB)	Reading (dBuV)	Level (dBuV/m)	Limit (dBuV/m)	Margin (dB)	Detector	Height (cm)	Azimuth (deg)	P/F
1	5150.00	4.69	40.94	45.63	54.00	-8.37	Average	129	182	P
2	5150.00	4.69	54.15	58.84	74.00	-15.16	Peak	129	182	P
3	5240.00	4.73	97.59	102.32	200.00	-97.68	Average	129	182	P
4	5240.00	4.73	107.03	111.76	200.00	-88.24	Peak	129	182	P
5	10480.00	11.70	55.17	66.87	68.20	-1.33	Peak	100	88	P

Note: Level=Reading+Factor
 Margin=Level-Limit
 Factor=Antenna Factor + cable loss - Amplifier Factor



Power	: AC 120V / 60Hz	Pol/Phase	: HORIZONTAL
Test Mode	: Mode 1, Band 1, CH48		:

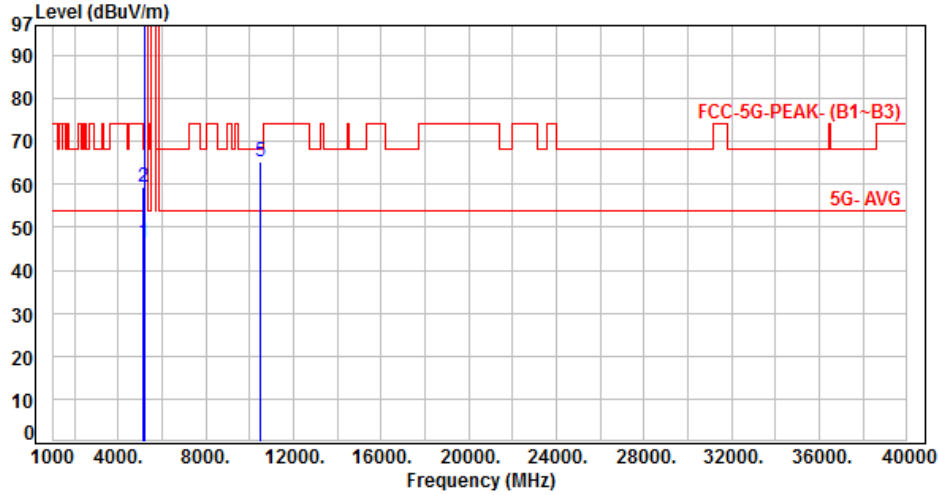

No.	Frequency (MHz)	Factor (dB)	Reading (dBuV)	Level (dBuV/m)	Limit (dBuV/m)	Margin (dB)	Detector	Height (cm)	Azimuth (deg)	P/F
1	5150.00	4.69	41.78	46.47	54.00	-7.53	Average	200	37	P
2	5150.00	4.69	54.71	59.40	74.00	-14.60	Peak	200	37	P
3	5240.00	4.73	100.21	104.94	200.00	-95.06	Average	200	37	P
4	5240.00	4.73	109.64	114.37	200.00	-85.63	Peak	200	37	P
5	10480.00	11.70	53.76	65.46	68.20	-2.74	Peak	123	190	P

Note: Level=Reading+Factor
 Margin=Level-Limit
 Factor=Antenna Factor + cable loss - Amplifier Factor



Power	: AC 120V / 60Hz	Pol/Phase	: VERTICAL
Test Mode	: Mode 4, Band 1, CH36		:

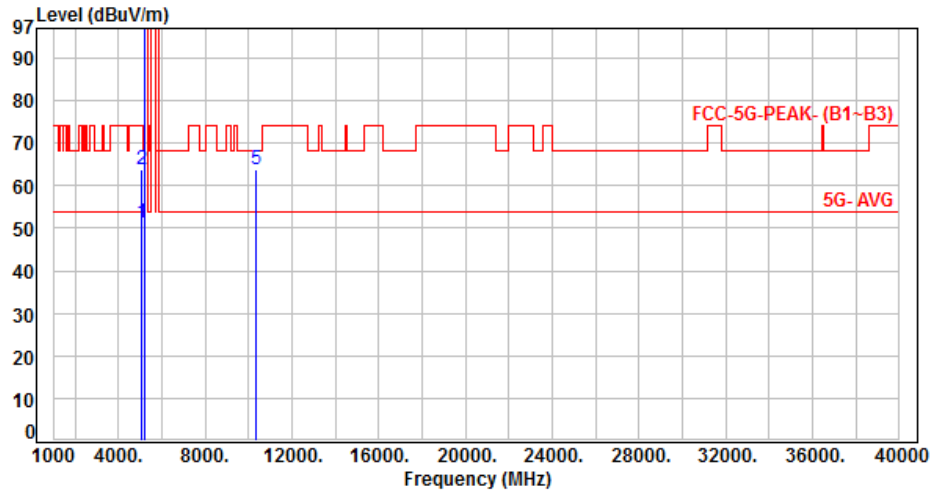

No.	Frequency (MHz)	Factor (dB)	Reading (dBuV)	Level (dBuV/m)	Limit (dBuV/m)	Margin (dB)	Detector	Height (cm)	Azimuth (deg)	P/F
1	5099.00	4.56	46.75	51.31	54.00	-2.69	Average	317	109	P
2	5099.00	4.56	59.33	63.89	74.00	-10.11	Peak	317	109	P
3	5180.00	4.66	99.36	104.02	200.00	-95.98	Average	317	109	P
4	5180.00	4.66	109.85	114.51	200.00	-85.49	Peak	317	109	P
5	10360.00	11.51	52.37	63.88	68.20	-4.32	Peak	100	74	P

Note: Level=Reading+Factor
 Margin=Level-Limit
 Factor=Antenna Factor + cable loss - Amplifier Factor



Power	: AC 120V / 60Hz	Pol/Phase	: HORIZONTAL
Test Mode	: Mode 4, Band 1, CH36		:

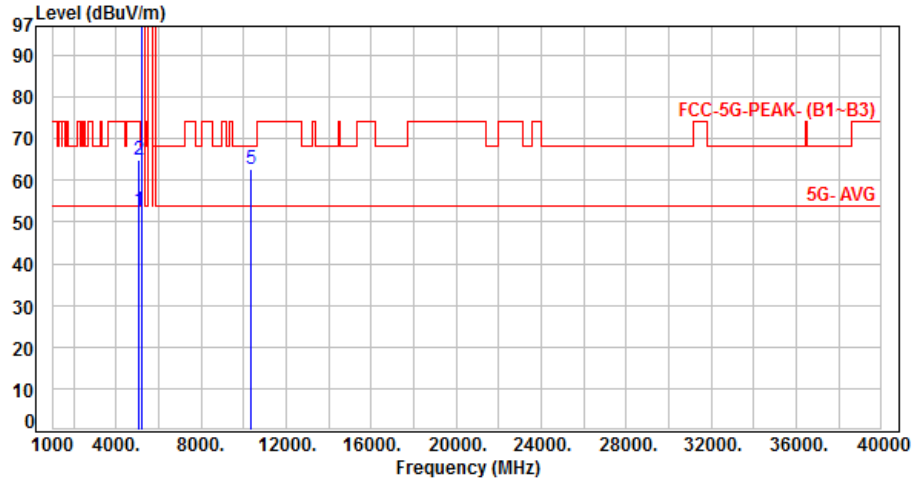

No.	Frequency (MHz)	Factor (dB)	Reading (dBuV)	Level (dBuV/m)	Limit (dBuV/m)	Margin (dB)	Detector	Height (cm)	Azimuth (deg)	P/F
1	5099.00	4.56	48.30	52.86	54.00	-1.14	Average	214	98	P
2	5099.00	4.56	60.48	65.04	74.00	-8.96	Peak	214	98	P
3	5180.00	4.66	100.82	105.48	200.00	-94.52	Average	214	98	P
4	5180.00	4.66	110.56	115.22	200.00	-84.78	Peak	214	98	P
5	10360.00	11.51	51.22	62.73	68.20	-5.47	Peak	121	188	P

Note: Level=Reading+Factor
 Margin=Level-Limit
 Factor=Antenna Factor + cable loss - Amplifier Factor



Power	: AC 120V / 60Hz	Pol/Phase	: VERTICAL
Test Mode	: Mode 4, Band 1, CH40		

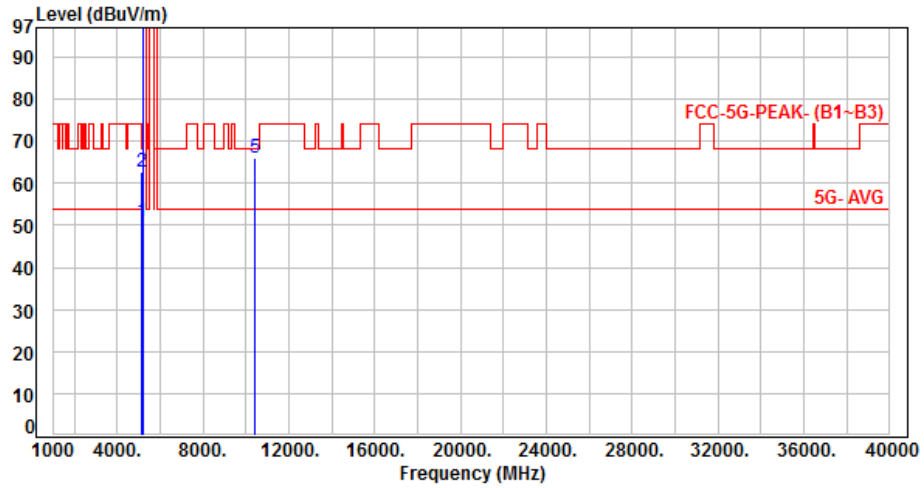

No.	Frequency (MHz)	Factor (dB)	Reading (dBuV)	Level (dBuV/m)	Limit (dBuV/m)	Margin (dB)	Detector	Height (cm)	Azimuth (deg)	P/F
1	5119.00	4.61	46.17	50.78	54.00	-3.22	Average	303	116	P
2	5119.00	4.61	58.17	62.78	74.00	-11.22	Peak	303	116	P
3	5200.00	4.63	99.84	104.47	200.00	-95.53	Average	303	116	P
4	5200.00	4.63	110.32	114.95	200.00	-85.05	Peak	303	116	P
5	10400.00	11.57	54.57	66.14	68.20	-2.06	Peak	100	85	P

Note: Level=Reading+Factor
 Margin=Level-Limit
 Factor=Antenna Factor + cable loss - Amplifier Factor



Power	: AC 120V / 60Hz	Pol/Phase	: HORIZONTAL
Test Mode	: Mode 4, Band 1, CH40		:

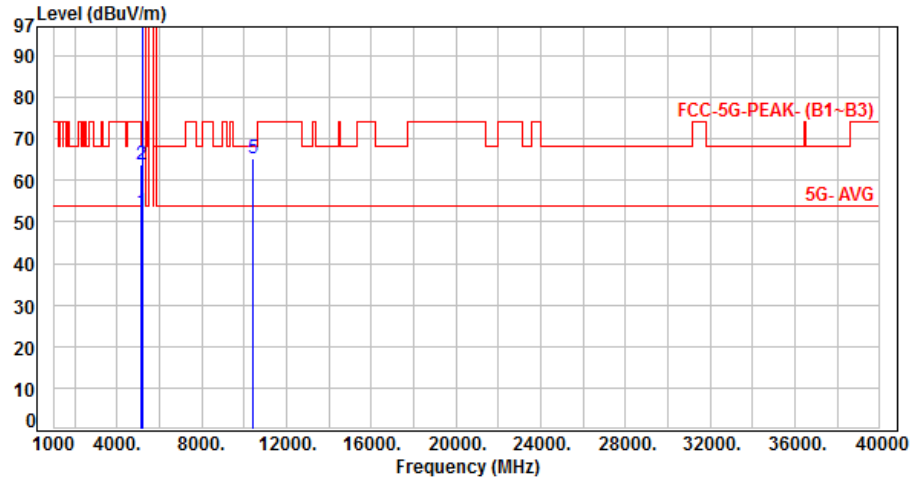

No.	Frequency (MHz)	Factor (dB)	Reading (dBuV)	Level (dBuV/m)	Limit (dBuV/m)	Margin (dB)	Detector	Height (cm)	Azimuth (deg)	P/F
1	5118.00	4.61	47.85	52.46	54.00	-1.54	Average	138	104	P
2	5118.00	4.61	59.20	63.81	74.00	-10.19	Peak	138	104	P
3	5200.00	4.63	100.82	105.45	200.00	-94.55	Average	138	104	P
4	5200.00	4.63	111.82	116.45	200.00	-83.55	Peak	138	104	P
5	10400.00	11.57	53.71	65.28	68.20	-2.92	Peak	112	185	P

Note: Level=Reading+Factor
 Margin=Level-Limit
 Factor=Antenna Factor + cable loss - Amplifier Factor



Power	: AC 120V / 60Hz	Pol/Phase	: VERTICAL
Test Mode	: Mode 4, Band 1, CH48		:

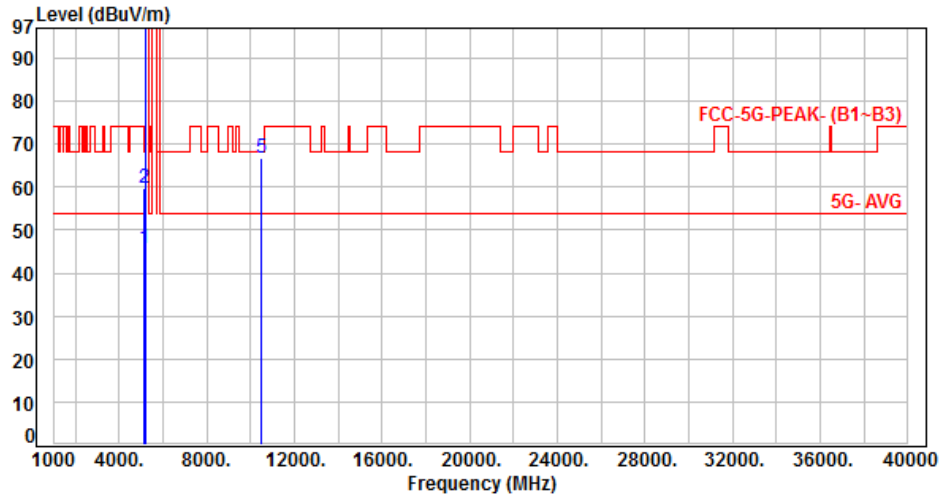

No.	Frequency (MHz)	Factor (dB)	Reading (dBuV)	Level (dBuV/m)	Limit (dBuV/m)	Margin (dB)	Detector	Height (cm)	Azimuth (deg)	P/F
1	5150.00	4.69	41.09	45.78	54.00	-8.22	Average	260	101	P
2	5150.00	4.69	55.24	59.93	74.00	-14.07	Peak	260	101	P
3	5240.00	4.73	99.50	104.23	200.00	-95.77	Average	260	101	P
4	5240.00	4.73	109.84	114.57	200.00	-85.43	Peak	260	101	P
5	10480.00	11.70	55.07	66.77	68.20	-1.43	Peak	128	88	P

Note: Level=Reading+Factor
 Margin=Level-Limit
 Factor=Antenna Factor + cable loss - Amplifier Factor



Power	: AC 120V / 60Hz	Pol/Phase	: HORIZONTAL
Test Mode	: Mode 4, Band 1, CH48		:

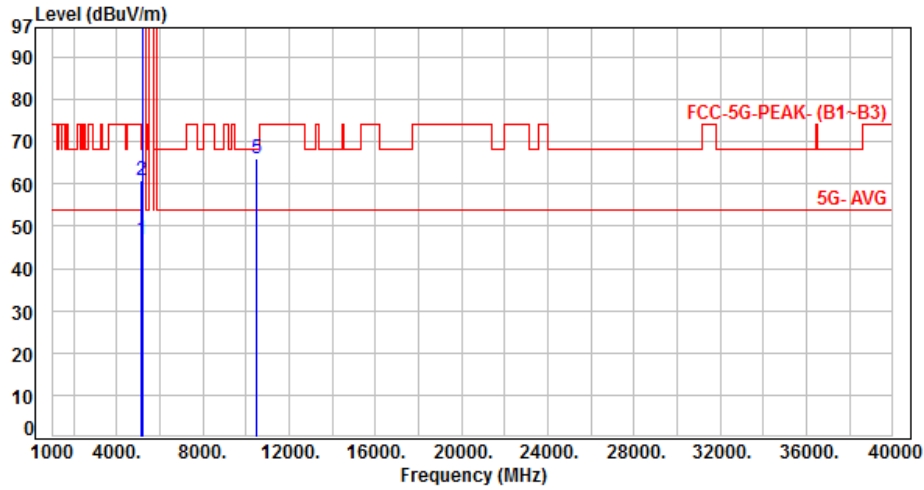

No.	Frequency (MHz)	Factor (dB)	Reading (dBuV)	Level (dBuV/m)	Limit (dBuV/m)	Margin (dB)	Detector	Height (cm)	Azimuth (deg)	P/F
1	5150.00	4.69	42.08	46.77	54.00	-7.23	Average	261	56	P
2	5150.00	4.69	56.17	60.86	74.00	-13.14	Peak	261	56	P
3	5240.00	4.73	100.21	104.94	200.00	-95.06	Average	261	56	P
4	5240.00	4.73	110.52	115.25	200.00	-84.75	Peak	261	56	P
5	10480.00	11.70	54.33	66.03	68.20	-2.17	Peak	102	87	P

Note: Level=Reading+Factor
 Margin=Level-Limit
 Factor=Antenna Factor + cable loss - Amplifier Factor



Power	: AC 120V / 60Hz	Pol/Phase	: VERTICAL
Test Mode	: Mode 5, Band 1, CH38		:

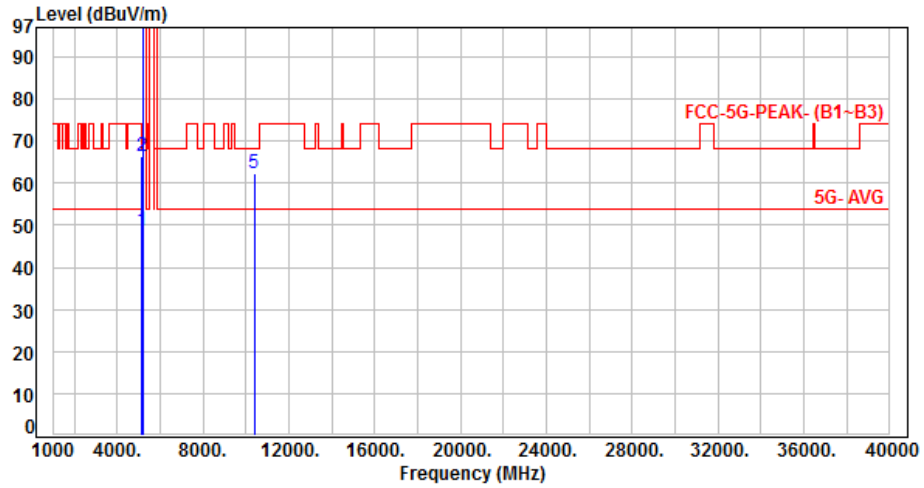

No.	Frequency (MHz)	Factor (dB)	Reading (dBUV)	Level (dBUV/m)	Limit (dBUV/m)	Margin (dB)	Detector	Height (cm)	Azimuth (deg)	P/F
1	5150.00	4.69	44.16	48.85	54.00	-5.15	Average	396	72	P
2	5150.00	4.69	61.57	66.26	74.00	-7.74	Peak	396	72	P
3	5190.00	4.64	92.54	97.18	200.00	-102.82	Average	396	72	P
4	5190.00	4.64	104.48	109.12	200.00	-90.88	Peak	396	72	P
5	10380.00	11.54	50.67	62.21	68.20	-5.99	Peak	126	87	P

Note: Level=Reading+Factor
Margin=Level-Limit
Factor=Antenna Factor + cable loss - Amplifier Factor



Power	: AC 120V / 60Hz	Pol/Phase	: HORIZONTAL
Test Mode	: Mode 5, Band 1, CH38		:

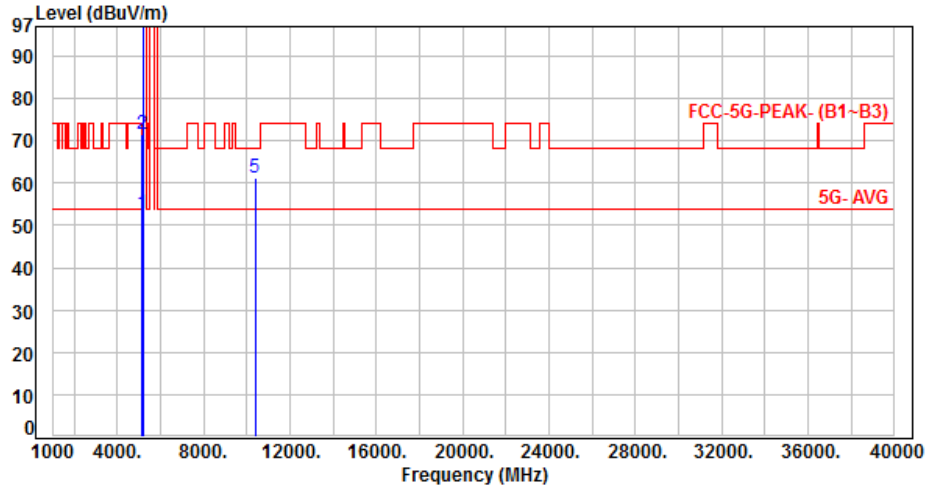

No.	Frequency (MHz)	Factor (dB)	Reading (dBuV)	Level (dBuV/m)	Limit (dBuV/m)	Margin (dB)	Detector	Height (cm)	Azimuth (deg)	P/F
1	5150.00	4.69	48.08	52.77	54.00	-1.23	Average	100	26	P
2	5150.00	4.69	66.86	71.55	74.00	-2.45	Peak	100	26	P
3	5190.00	4.64	93.81	98.45	200.00	-101.55	Average	100	26	P
4	5190.00	4.64	105.47	110.11	200.00	-89.89	Peak	100	26	P
5	10380.00	11.54	49.58	61.12	68.20	-7.08	Peak	121	194	P

Note: Level=Reading+Factor
Margin=Level-Limit
Factor=Antenna Factor + cable loss - Amplifier Factor



Power	: AC 120V / 60Hz	Pol/Phase	: VERTICAL
Test Mode	: Mode 5, Band 1, CH46		:

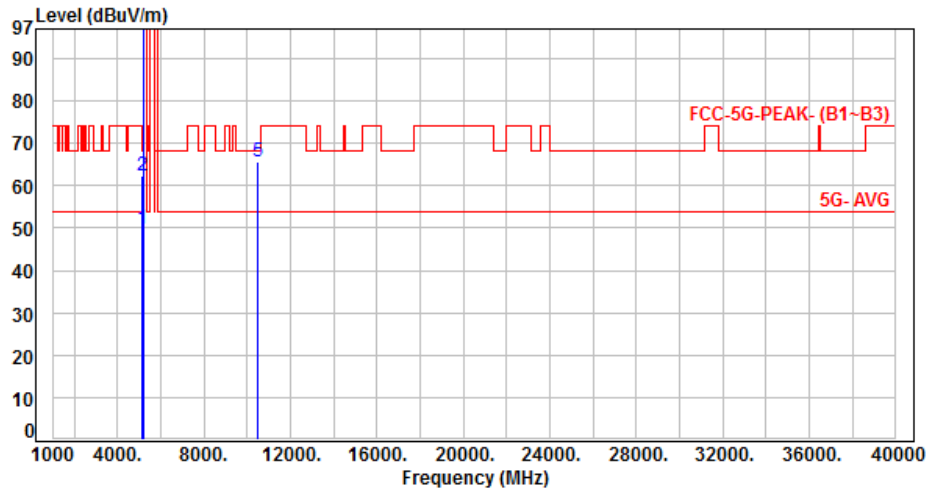

No.	Frequency (MHz)	Factor (dB)	Reading (dBuV)	Level (dBuV/m)	Limit (dBuV/m)	Margin (dB)	Detector	Height (cm)	Azimuth (deg)	P/F
1	5150.00	4.69	45.08	49.77	54.00	-4.23	Average	197	111	P
2	5150.00	4.69	57.49	62.18	74.00	-11.82	Peak	197	111	P
3	5230.00	4.70	95.73	100.43	200.00	-99.57	Average	197	111	P
4	5230.00	4.70	107.56	112.26	200.00	-87.74	Peak	197	111	P
5	10460.00	11.67	54.14	65.81	68.20	-2.39	Peak	166	84	P

Note: Level=Reading+Factor
 Margin=Level-Limit
 Factor=Antenna Factor + cable loss - Amplifier Factor



Power	: AC 120V / 60Hz	Pol/Phase	: HORIZONTAL
Test Mode	: Mode 5, Band 1, CH46		:

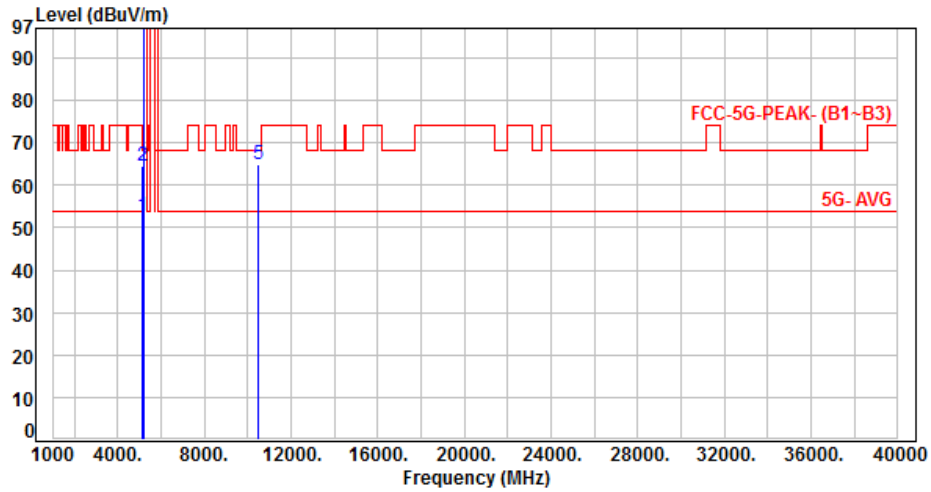

No.	Frequency (MHz)	Factor (dB)	Reading (dBuV)	Level (dBuV/m)	Limit (dBuV/m)	Margin (dB)	Detector	Height (cm)	Azimuth (deg)	P/F
1	5150.00	4.69	47.91	52.60	54.00	-1.40	Average	261	335	P
2	5150.00	4.69	59.73	64.42	74.00	-9.58	Peak	261	335	P
3	5230.00	4.70	97.94	102.64	200.00	-97.36	Average	261	335	P
4	5230.00	4.70	108.82	113.52	200.00	-86.48	Peak	261	335	P
5	10460.00	11.67	53.11	64.78	68.20	-3.42	Peak	116	189	P

Note: Level=Reading+Factor
 Margin=Level-Limit
 Factor=Antenna Factor + cable loss - Amplifier Factor



Power	: AC 120V / 60Hz	Pol/Phase	: VERTICAL
Test Mode	: Mode 6, Band 1, CH42		:

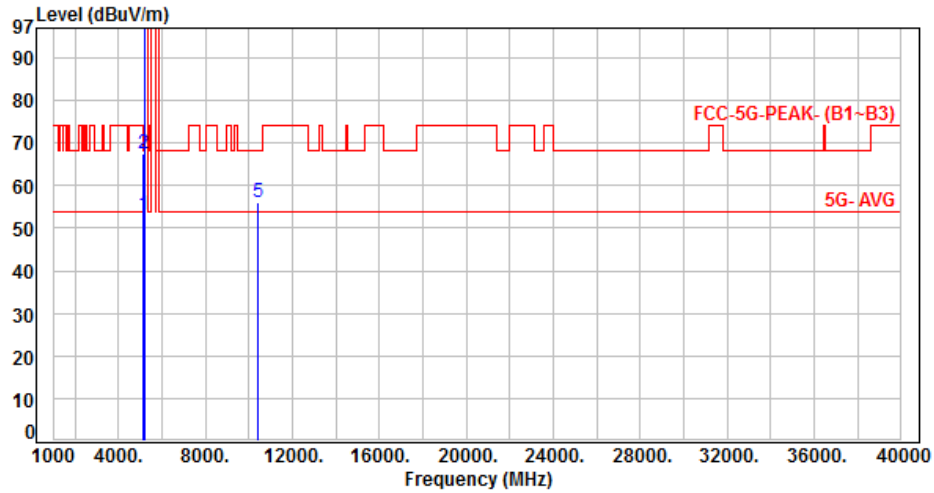

No.	Frequency (MHz)	Factor (dB)	Reading (dBuV)	Level (dBuV/m)	Limit (dBuV/m)	Margin (dB)	Detector	Height (cm)	Azimuth (deg)	P/F
1	5150.00	4.69	48.30	52.99	54.00	-1.01	Average	318	115	P
2	5150.00	4.69	62.67	67.36	74.00	-6.64	Peak	318	115	P
3	5210.00	4.65	91.18	95.83	200.00	-104.17	Average	318	115	P
4	5210.00	4.65	101.09	105.74	200.00	-94.26	Peak	318	115	P
5	10420.00	11.61	44.50	56.11	68.20	-12.09	Peak	128	86	P

Note: Level=Reading+Factor
Margin=Level-Limit
Factor=Antenna Factor + cable loss - Amplifier Factor



Power	: AC 120V / 60Hz	Pol/Phase	: HORIZONTAL
Test Mode	: Mode 6, Band 1, CH42		:

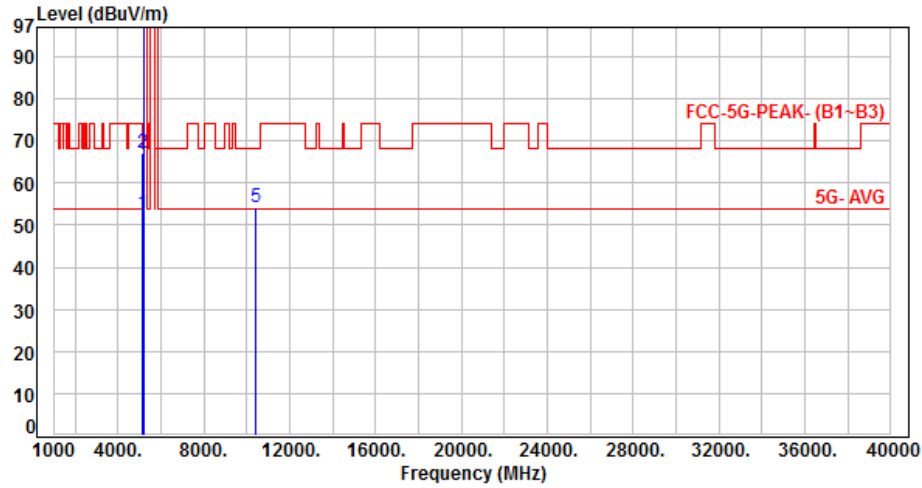

No.	Frequency (MHz)	Factor (dB)	Reading (dBuV)	Level (dBuV/m)	Limit (dBuV/m)	Margin (dB)	Detector	Height (cm)	Azimuth (deg)	P/F
1	5150.00	4.69	47.95	52.64	54.00	-1.36	Average	188	341	P
2	5150.00	4.69	62.59	67.28	74.00	-6.72	Peak	188	341	P
3	5210.00	4.65	92.30	96.95	200.00	-103.05	Average	188	341	P
4	5210.00	4.65	102.35	107.00	200.00	-93.00	Peak	188	341	P
5	10420.00	11.61	42.55	54.16	68.20	-14.04	Peak	118	189	P

Note: Level=Reading+Factor
Margin=Level-Limit
Factor=Antenna Factor + cable loss - Amplifier Factor



Power	: AC 120V / 60Hz	Pol/Phase	: VERTICAL
Test Mode	: Mode 1, Band 4, CH149		:

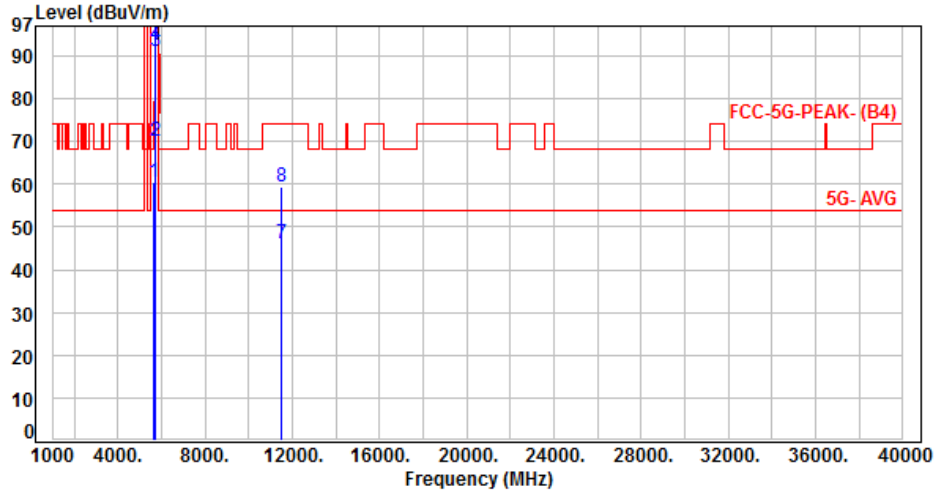

No.	Frequency (MHz)	Factor (dB)	Reading (dBuV)	Level (dBuV/m)	Limit (dBuV/m)	Margin (dB)	Detector	Height (cm)	Azimuth (deg)	P/F
1	5650.00	5.09	55.56	60.65	68.20	-7.55	Peak	226	74	P
2	5700.00	5.12	64.84	69.96	105.20	-35.24	Peak	226	74	P
3	5720.00	5.13	86.06	91.19	110.80	-19.61	Peak	226	74	P
4	5725.00	5.14	87.50	92.64	122.20	-29.56	Peak	226	74	P
5	5745.00	5.15	103.61	108.76	200.00	-91.24	Average	226	74	P
6	5745.00	5.15	114.34	119.49	200.00	-80.51	Peak	226	74	P
7	11490.00	13.27	32.73	46.00	54.00	-8.00	Average	100	84	P
8	11490.00	13.27	45.97	59.24	74.00	-14.76	Peak	100	84	P

Note: Level=Reading+Factor
Margin=Level-Limit
Factor=Antenna Factor + cable loss - Amplifier Factor



Power	: AC 120V / 60Hz	Pol/Phase	: HORIZONTAL
Test Mode	: Mode 1, Band 4, CH149		:

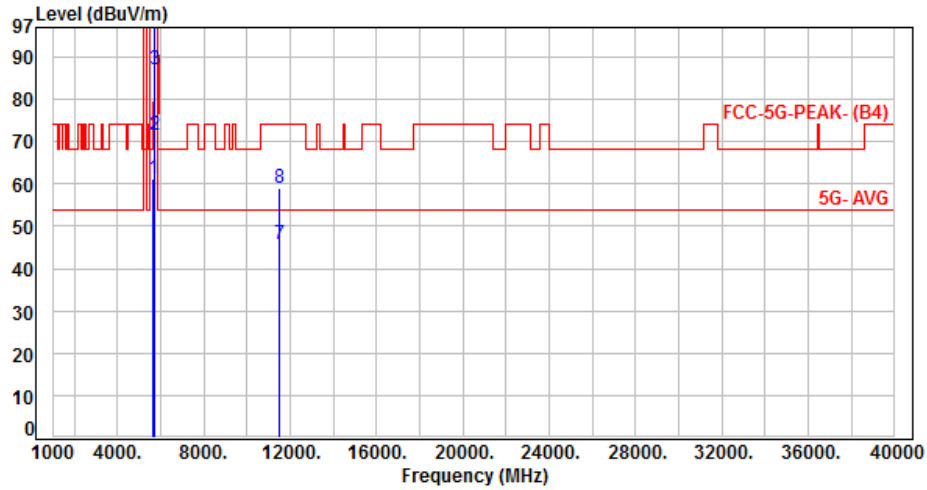

No.	Frequency (MHz)	Factor (dB)	Reading (dBuV)	Level (dBuV/m)	Limit (dBuV/m)	Margin (dB)	Detector	Height (cm)	Azimuth (deg)	P/F
1	5650.00	5.09	56.28	61.37	68.20	-6.83	Peak	336	200	P
2	5700.00	5.12	66.45	71.57	105.20	-33.63	Peak	336	200	P
3	5720.00	5.13	82.06	87.19	110.80	-23.61	Peak	336	200	P
4	5725.00	5.14	92.34	97.48	122.20	-24.72	Peak	336	200	P
5	5745.00	5.15	105.69	110.84	200.00	-89.16	Average	336	200	P
6	5745.00	5.15	115.72	120.87	200.00	-79.13	Peak	336	200	P
7	11490.00	13.27	32.56	45.83	54.00	-8.17	Average	212	79	P
8	11490.00	13.27	45.61	58.88	74.00	-15.12	Peak	212	79	P

Note: Level=Reading+Factor
 Margin=Level-Limit
 Factor=Antenna Factor + cable loss - Amplifier Factor



Power	: AC 120V / 60Hz	Pol/Phase	: VERTICAL
Test Mode	: Mode 1, Band 4, CH157		:

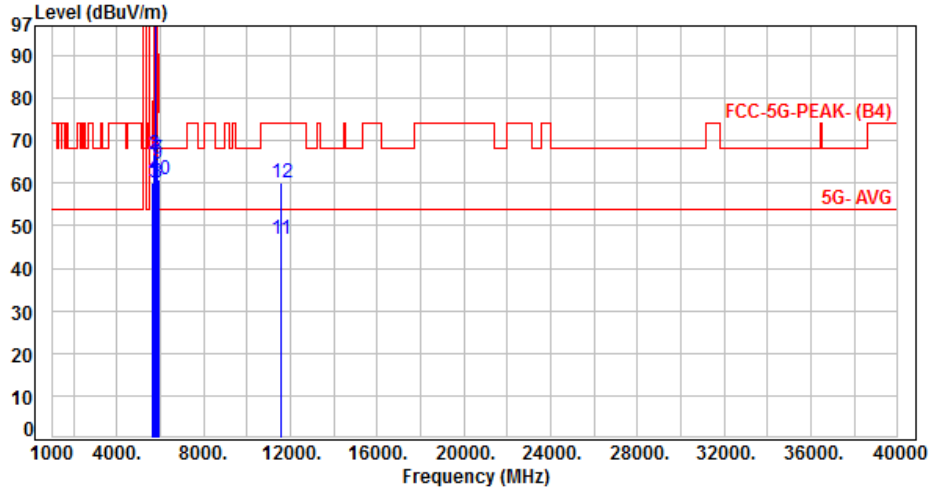

No.	Frequency (MHz)	Factor (dB)	Reading (dBuV)	Level (dBuV/m)	Limit (dBuV/m)	Margin (dB)	Detector	Height (cm)	Azimuth (deg)	P/F
1	5650.00	5.09	54.88	59.97	68.20	-8.23	Peak	203	242	P
2	5700.00	5.12	61.74	66.86	105.20	-38.34	Peak	203	242	P
3	5720.00	5.13	54.90	60.03	110.80	-50.77	Peak	203	242	P
4	5725.00	5.14	56.41	61.55	122.20	-60.65	Peak	203	242	P
5	5785.00	5.17	102.18	107.35	200.00	-92.65	Average	203	242	P
6	5785.00	5.17	112.70	117.87	200.00	-82.13	Peak	203	242	P
7	5850.00	5.21	60.49	65.70	122.20	-56.50	Peak	203	242	P
8	5855.00	5.23	54.72	59.95	110.80	-50.85	Peak	203	242	P
9	5875.00	5.31	59.31	64.62	105.20	-40.58	Peak	203	242	P
10	5925.00	5.49	55.45	60.94	68.20	-7.26	Peak	203	242	P
11	11570.00	13.50	33.28	46.78	54.00	-7.22	Average	114	106	P
12	11570.00	13.50	46.45	59.95	74.00	-14.05	Peak	114	106	P

Note: Level=Reading+Factor
 Margin=Level-Limit
 Factor=Antenna Factor + cable loss - Amplifier Factor



Power	: AC 120V / 60Hz	Pol/Phase	: HORIZONTAL
Test Mode	: Mode 1, Band 4, CH157		:

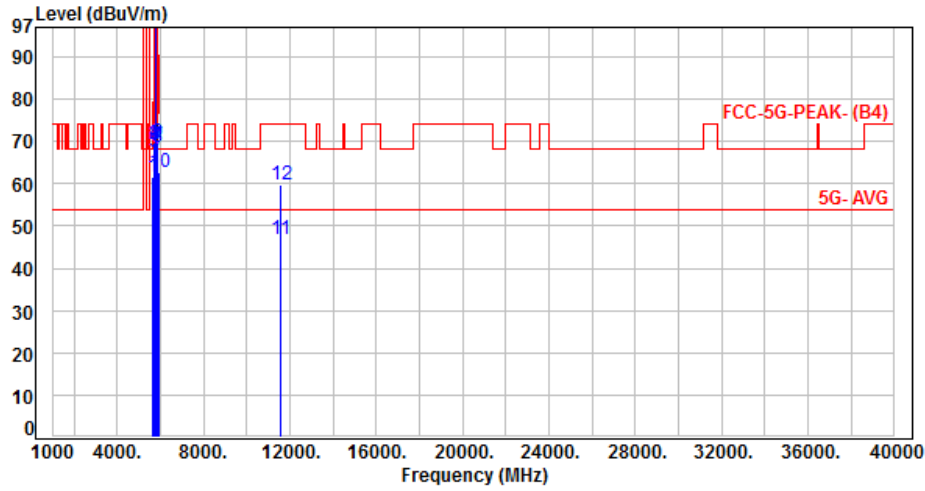

No.	Frequency (MHz)	Factor (dB)	Reading (dBuV)	Level (dBuV/m)	Limit (dBuV/m)	Margin (dB)	Detector	Height (cm)	Azimuth (deg)	P/F
1	5650.00	5.09	56.50	61.59	68.20	-6.61	Peak	219	122	P
2	5700.00	5.12	64.05	69.17	105.20	-36.03	Peak	219	122	P
3	5720.00	5.13	62.54	67.67	110.80	-43.13	Peak	219	122	P
4	5725.00	5.14	64.40	69.54	122.20	-52.66	Peak	219	122	P
5	5785.00	5.17	106.80	111.97	200.00	-88.03	Average	219	122	P
6	5785.00	5.17	117.01	122.18	200.00	-77.82	Peak	219	122	P
7	5850.00	5.21	63.90	69.11	122.20	-53.09	Peak	219	122	P
8	5855.00	5.23	63.52	68.75	110.80	-42.05	Peak	219	122	P
9	5875.00	5.31	64.26	69.57	105.20	-35.63	Peak	219	122	P
10	5925.00	5.49	57.21	62.70	68.20	-5.50	Peak	219	122	P
11	11570.00	13.50	33.24	46.74	54.00	-7.26	Average	228	75	P
12	11570.00	13.50	46.23	59.73	74.00	-14.27	Peak	228	75	P

Note: Level=Reading+Factor
 Margin=Level-Limit
 Factor=Antenna Factor + cable loss - Amplifier Factor



Power	: AC 120V / 60Hz	Pol/Phase	: VERTICAL
Test Mode	: Mode 1, Band 4, CH165		:

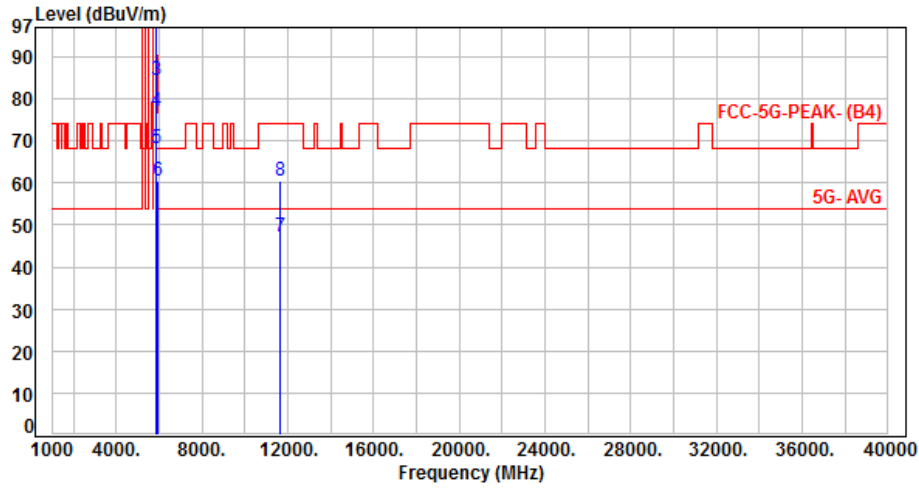

No.	Frequency (MHz)	Factor (dB)	Reading (dBuV)	Level (dBuV/m)	Limit (dBuV/m)	Margin (dB)	Detector	Height (cm)	Azimuth (deg)	P/F
1	5825.00	5.19	101.38	106.57	200.00	-93.43	Average	196	249	P
2	5825.00	5.19	111.43	116.62	200.00	-83.38	Peak	196	249	P
3	5850.00	5.21	79.43	84.64	122.20	-37.56	Peak	196	249	P
4	5855.00	5.23	71.88	77.11	110.80	-33.69	Peak	196	249	P
5	5875.00	5.31	62.88	68.19	105.20	-37.01	Peak	196	249	P
6	5925.00	5.49	54.97	60.46	68.20	-7.74	Peak	196	249	P
7	11650.00	13.68	33.64	47.32	54.00	-6.68	Average	120	115	P
8	11650.00	13.68	46.83	60.51	74.00	-13.49	Peak	120	115	P

Note: Level=Reading+Factor
 Margin=Level-Limit
 Factor=Antenna Factor + cable loss - Amplifier Factor



Power	: AC 120V / 60Hz	Pol/Phase	: HORIZONTAL
Test Mode	: Mode 1, Band 4, CH165		:

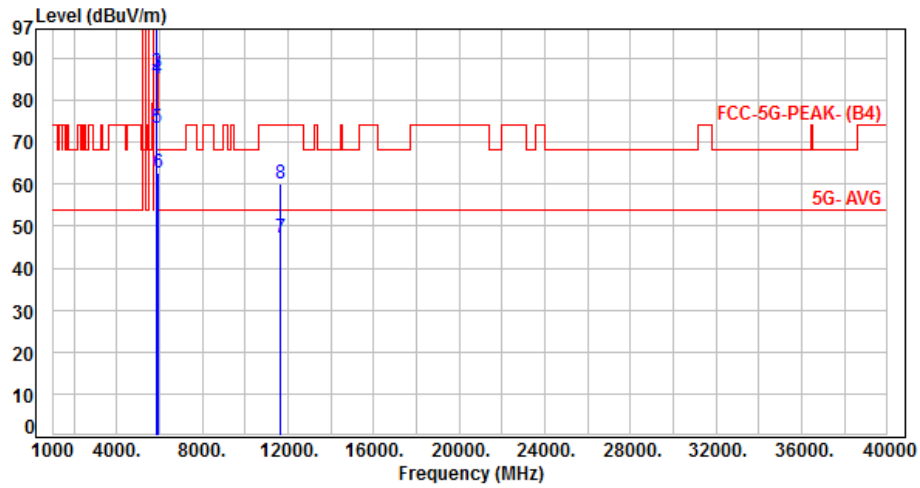

No.	Frequency (MHz)	Factor (dB)	Reading (dBuV)	Level (dBuV/m)	Limit (dBuV/m)	Margin (dB)	Detector	Height (cm)	Azimuth (deg)	P/F
1	5825.00	5.19	106.06	111.25	200.00	-88.75	Average	198	120	P
2	5825.00	5.19	116.27	121.46	200.00	-78.54	Peak	198	120	P
3	5850.00	5.21	81.64	86.85	122.20	-35.35	Peak	198	120	P
4	5855.00	5.23	79.79	85.02	110.80	-25.78	Peak	198	120	P
5	5875.00	5.31	67.90	73.21	105.20	-31.99	Peak	198	120	P
6	5925.00	5.49	57.10	62.59	68.20	-5.61	Peak	198	120	P
7	11650.00	13.68	33.51	47.19	54.00	-6.81	Average	231	80	P
8	11650.00	13.68	46.61	60.29	74.00	-13.71	Peak	231	80	P

Note: Level=Reading+Factor
Margin=Level-Limit
Factor=Antenna Factor + cable loss - Amplifier Factor



Power	: AC 120V / 60Hz	Pol/Phase	: VERTICAL
Test Mode	: Mode 4, Band 4, CH149		:

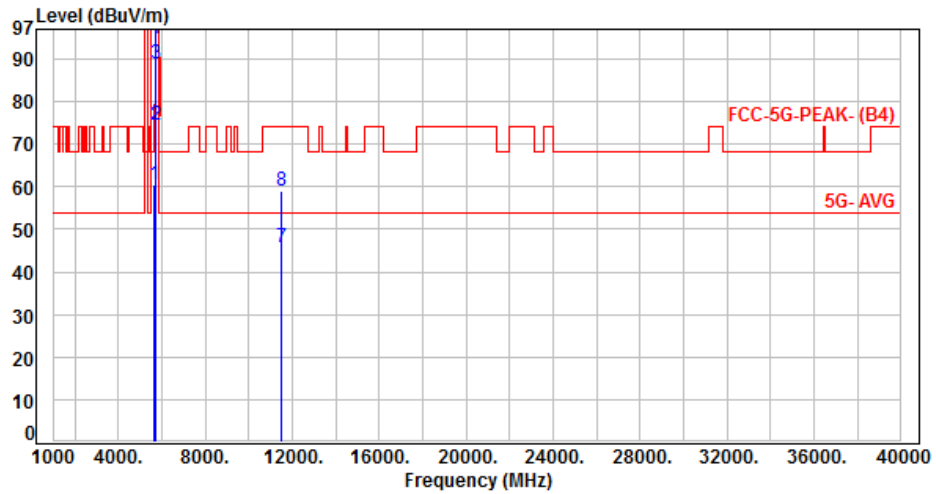

No.	Frequency (MHz)	Factor (dB)	Reading (dBuV)	Level (dBuV/m)	Limit (dBuV/m)	Margin (dB)	Detector	Height (cm)	Azimuth (deg)	P/F
1	5650.00	5.09	55.43	60.52	68.20	-7.68	Peak	212	68	P
2	5700.00	5.12	69.45	74.57	105.20	-30.63	Peak	212	68	P
3	5720.00	5.13	83.74	88.87	110.80	-21.93	Peak	212	68	P
4	5725.00	5.14	89.69	94.83	122.20	-27.37	Peak	212	68	P
5	5745.00	5.15	102.49	107.64	200.00	-92.36	Average	212	68	P
6	5745.00	5.15	113.89	119.04	200.00	-80.96	Peak	212	68	P
7	11490.00	13.27	32.30	45.57	54.00	-8.43	Average	112	128	P
8	11490.00	13.27	45.84	59.11	74.00	-14.89	Peak	112	128	P

Note: Level=Reading+Factor
 Margin=Level-Limit
 Factor=Antenna Factor + cable loss - Amplifier Factor



Power	: AC 120V / 60Hz	Pol/Phase	: HORIZONTAL
Test Mode	: Mode 4, Band 4, CH149		:

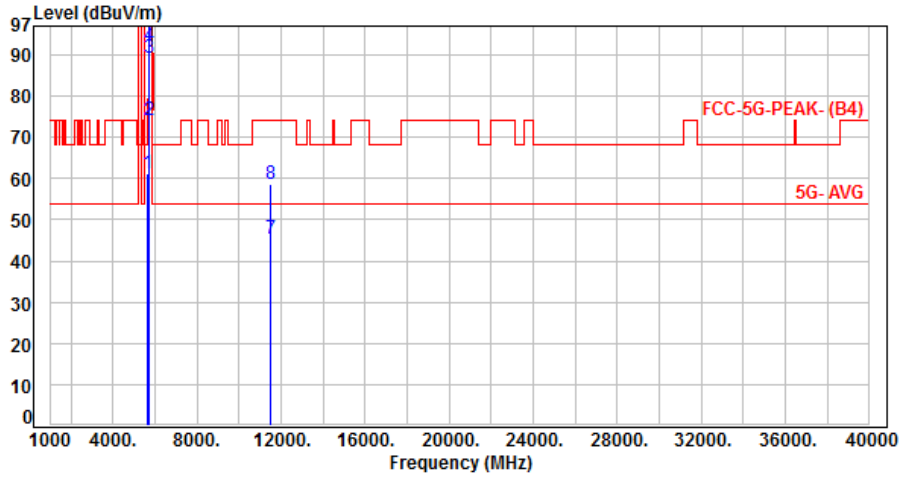

No.	Frequency (MHz)	Factor (dB)	Reading (dBuV)	Level (dBuV/m)	Limit (dBuV/m)	Margin (dB)	Detector	Height (cm)	Azimuth (deg)	P/F
1	5650.00	5.09	56.07	61.16	68.20	-7.04	Peak	235	118	P
2	5700.00	5.12	69.08	74.20	105.20	-31.00	Peak	235	118	P
3	5720.00	5.13	84.08	89.21	110.80	-21.59	Peak	235	118	P
4	5725.00	5.14	87.15	92.29	122.20	-29.91	Peak	235	118	P
5	5745.00	5.15	105.15	110.30	200.00	-89.70	Average	235	118	P
6	5745.00	5.15	116.02	121.17	200.00	-78.83	Peak	235	118	P
7	11490.00	13.27	32.18	45.45	54.00	-8.55	Average	223	86	P
8	11490.00	13.27	45.37	58.64	74.00	-15.36	Peak	223	86	P

Note: Level=Reading+Factor
 Margin=Level-Limit
 Factor=Antenna Factor + cable loss - Amplifier Factor



Power	: AC 120V / 60Hz	Pol/Phase	: VERTICAL
Test Mode	: Mode 4, Band 4, CH157		:

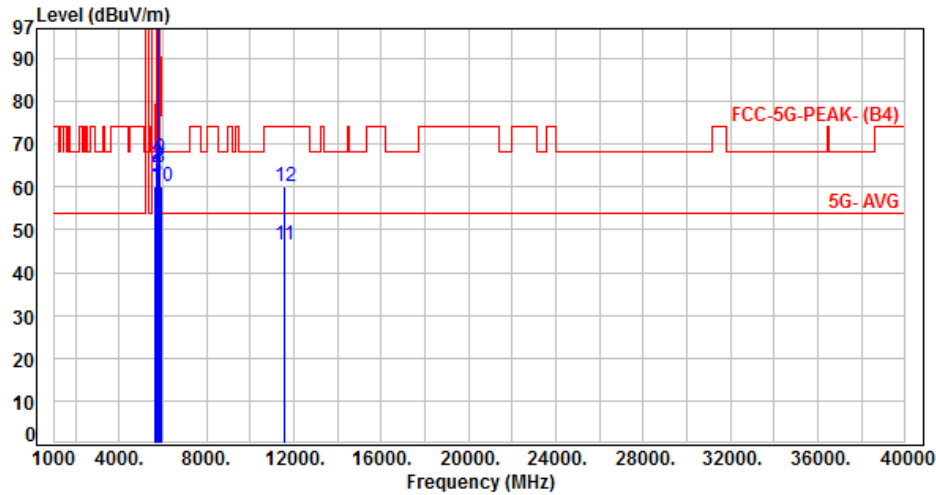

No.	Frequency (MHz)	Factor (dB)	Reading (dBuV)	Level (dBuV/m)	Limit (dBuV/m)	Margin (dB)	Detector	Height (cm)	Azimuth (deg)	P/F
1	5650.00	5.09	54.90	59.99	68.20	-8.21	Peak	183	49	P
2	5700.00	5.12	60.08	65.20	105.20	-40.00	Peak	183	49	P
3	5720.00	5.13	57.07	62.20	110.80	-48.60	Peak	183	49	P
4	5725.00	5.14	58.68	63.82	122.20	-58.38	Peak	183	49	P
5	5785.00	5.17	101.23	106.40	200.00	-93.60	Average	183	49	P
6	5785.00	5.17	112.46	117.63	200.00	-82.37	Peak	183	49	P
7	5850.00	5.21	59.37	64.58	122.20	-57.62	Peak	183	49	P
8	5855.00	5.23	59.14	64.37	110.80	-46.43	Peak	183	49	P
9	5875.00	5.31	61.47	66.78	105.20	-38.42	Peak	183	49	P
10	5925.00	5.49	54.72	60.21	68.20	-7.99	Peak	183	49	P
11	11570.00	13.50	32.97	46.47	54.00	-7.53	Average	131	106	P
12	11570.00	13.50	46.77	60.27	74.00	-13.73	Peak	131	106	P

Note: Level=Reading+Factor
 Margin=Level-Limit
 Factor=Antenna Factor + cable loss - Amplifier Factor



Power	: AC 120V / 60Hz	Pol/Phase	: HORIZONTAL
Test Mode	: Mode 4, Band 4, CH157		:

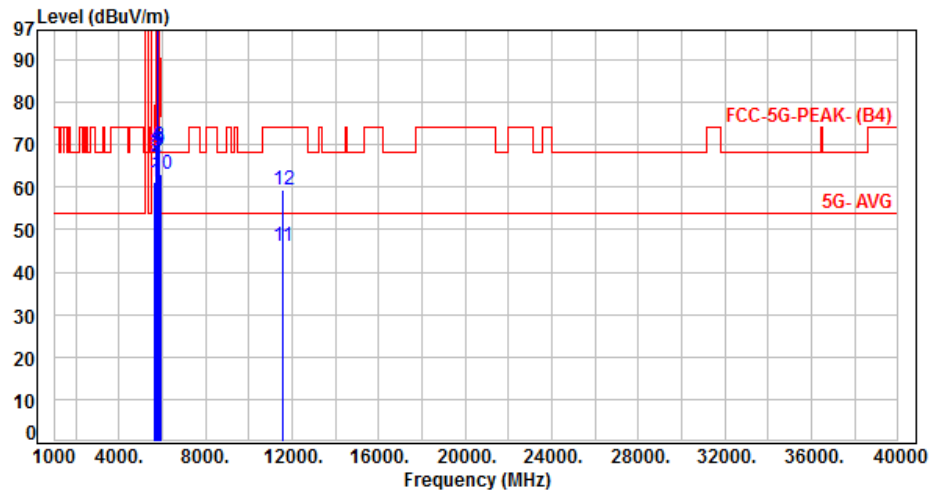

No.	Frequency (MHz)	Factor (dB)	Reading (dBuV)	Level (dBuV/m)	Limit (dBuV/m)	Margin (dB)	Detector	Height (cm)	Azimuth (deg)	P/F
1	5650.00	5.09	56.23	61.32	68.20	-6.88	Peak	115	122	P
2	5700.00	5.12	61.84	66.96	105.20	-38.24	Peak	115	122	P
3	5720.00	5.13	63.27	68.40	110.80	-42.40	Peak	115	122	P
4	5725.00	5.14	64.50	69.64	122.20	-52.56	Peak	115	122	P
5	5785.00	5.17	104.38	109.55	200.00	-90.45	Average	115	122	P
6	5785.00	5.17	115.43	120.60	200.00	-79.40	Peak	115	122	P
7	5850.00	5.21	61.87	67.08	122.20	-55.12	Peak	115	122	P
8	5855.00	5.23	64.59	69.82	110.80	-40.98	Peak	115	122	P
9	5875.00	5.31	63.19	68.50	105.20	-36.70	Peak	115	122	P
10	5925.00	5.49	57.41	62.90	68.20	-5.30	Peak	115	122	P
11	11570.00	13.50	32.66	46.16	54.00	-7.84	Average	214	78	P
12	11570.00	13.50	46.02	59.52	74.00	-14.48	Peak	214	78	P

Note: Level=Reading+Factor
 Margin=Level-Limit
 Factor=Antenna Factor + cable loss - Amplifier Factor



Power	: AC 120V / 60Hz	Pol/Phase	: VERTICAL
Test Mode	: Mode 4, Band 4, CH165		:

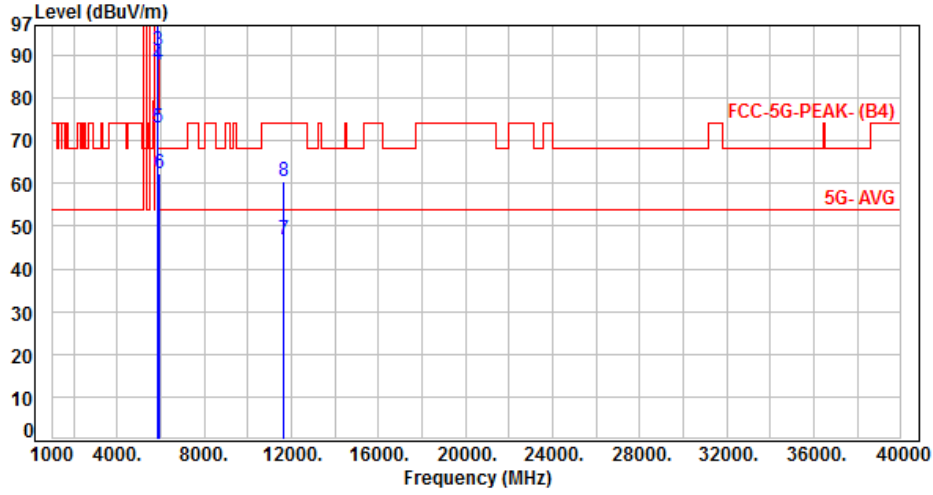

No.	Frequency (MHz)	Factor (dB)	Reading (dBuV)	Level (dBuV/m)	Limit (dBuV/m)	Margin (dB)	Detector	Height (cm)	Azimuth (deg)	P/F
1	5825.00	5.19	103.09	108.28	200.00	-91.72	Average	189	69	P
2	5825.00	5.19	114.17	119.36	200.00	-80.64	Peak	189	69	P
3	5850.00	5.21	85.93	91.14	122.20	-31.06	Peak	189	69	P
4	5855.00	5.23	82.62	87.85	110.80	-22.95	Peak	189	69	P
5	5875.00	5.31	67.87	73.18	105.20	-32.02	Peak	189	69	P
6	5925.00	5.49	57.01	62.50	68.20	-5.70	Peak	189	69	P
7	11650.00	13.68	33.17	46.85	54.00	-7.15	Average	124	119	P
8	11650.00	13.68	46.68	60.36	74.00	-13.64	Peak	124	119	P

Note: Level=Reading+Factor
 Margin=Level-Limit
 Factor=Antenna Factor + cable loss - Amplifier Factor



Power	: AC 120V / 60Hz	Pol/Phase	: HORIZONTAL
Test Mode	: Mode 4, Band 4, CH165		:

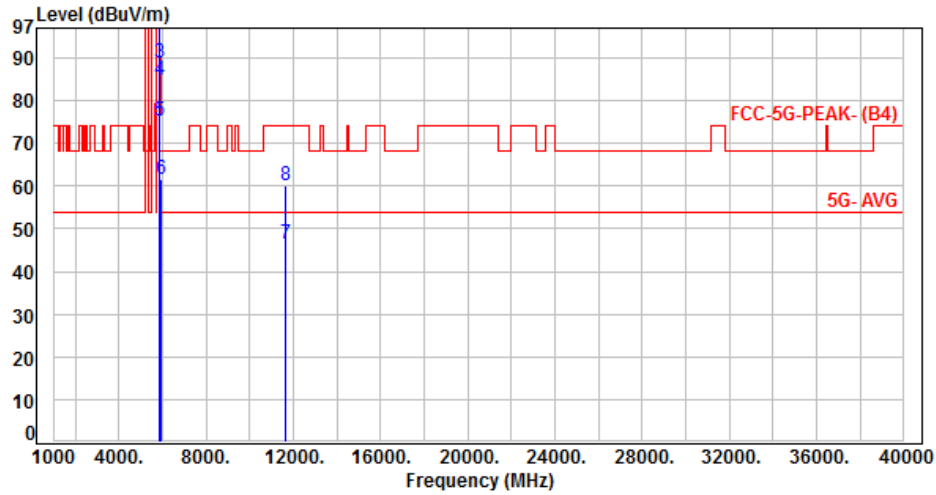

No.	Frequency (MHz)	Factor (dB)	Reading (dBuV)	Level (dBuV/m)	Limit (dBuV/m)	Margin (dB)	Detector	Height (cm)	Azimuth (deg)	P/F
1	5825.00	5.19	104.83	110.02	200.00	-89.98	Average	114	123	P
2	5825.00	5.19	116.06	121.25	200.00	-78.75	Peak	114	123	P
3	5850.00	5.21	83.70	88.91	122.20	-33.29	Peak	114	123	P
4	5855.00	5.23	79.62	84.85	110.80	-25.95	Peak	114	123	P
5	5875.00	5.31	69.95	75.26	105.20	-29.94	Peak	114	123	P
6	5925.00	5.49	56.20	61.69	68.20	-6.51	Peak	114	123	P
7	11650.00	13.68	32.97	46.65	54.00	-7.35	Average	222	74	P
8	11650.00	13.68	46.34	60.02	74.00	-13.98	Peak	222	74	P

Note: Level=Reading+Factor
 Margin=Level-Limit
 Factor=Antenna Factor + cable loss - Amplifier Factor



Power	: AC 120V / 60Hz	Pol/Phase	: VERTICAL
Test Mode	: Mode 5, Band 4, CH151		:

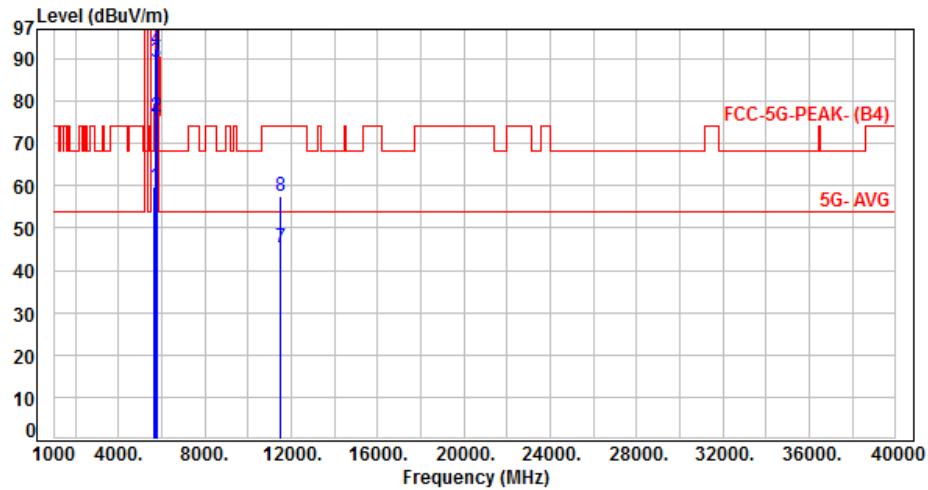

No.	Frequency (MHz)	Factor (dB)	Reading (dBuV)	Level (dBuV/m)	Limit (dBuV/m)	Margin (dB)	Detector	Height (cm)	Azimuth (deg)	P/F
1	5650.00	5.09	54.77	59.86	68.20	-8.34	Peak	281	66	P
2	5700.00	5.12	71.36	76.48	105.20	-28.72	Peak	281	66	P
3	5720.00	5.13	83.94	89.07	110.80	-21.73	Peak	281	66	P
4	5725.00	5.14	87.09	92.23	122.20	-29.97	Peak	281	66	P
5	5755.00	5.15	96.38	101.53	200.00	-98.47	Average	281	66	P
6	5755.00	5.15	107.86	113.01	200.00	-86.99	Peak	281	66	P
7	11510.00	13.32	31.87	45.19	54.00	-8.81	Average	104	137	P
8	11510.00	13.32	44.29	57.61	74.00	-16.39	Peak	104	137	P

Note: Level=Reading+Factor
 Margin=Level-Limit
 Factor=Antenna Factor + cable loss - Amplifier Factor



Power	: AC 120V / 60Hz	Pol/Phase	: HORIZONTAL
Test Mode	: Mode 5, Band 4, CH151		:

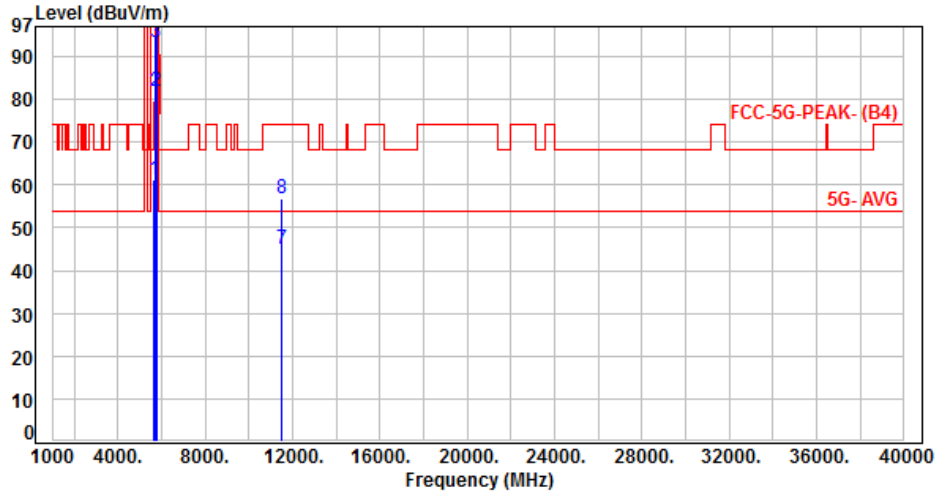

No.	Frequency (MHz)	Factor (dB)	Reading (dBuV)	Level (dBuV/m)	Limit (dBuV/m)	Margin (dB)	Detector	Height (cm)	Azimuth (deg)	P/F
1	5650.00	5.09	56.24	61.33	68.20	-6.87	Peak	187	117	P
2	5700.00	5.12	76.90	82.02	105.20	-23.18	Peak	187	117	P
3	5720.00	5.13	88.11	93.24	110.80	-17.56	Peak	187	117	P
4	5725.00	5.14	89.85	94.99	122.20	-27.21	Peak	187	117	P
5	5755.00	5.15	99.53	104.68	200.00	-95.32	Average	187	117	P
6	5755.00	5.15	110.94	116.09	200.00	-83.91	Peak	187	117	P
7	11510.00	13.32	31.55	44.87	54.00	-9.13	Average	202	96	P
8	11510.00	13.32	43.59	56.91	74.00	-17.09	Peak	202	96	P

Note: Level=Reading+Factor
Margin=Level-Limit
Factor=Antenna Factor + cable loss - Amplifier Factor



Power	: AC 120V / 60Hz	Pol/Phase	: VERTICAL
Test Mode	: Mode 5, Band 4, CH159		:

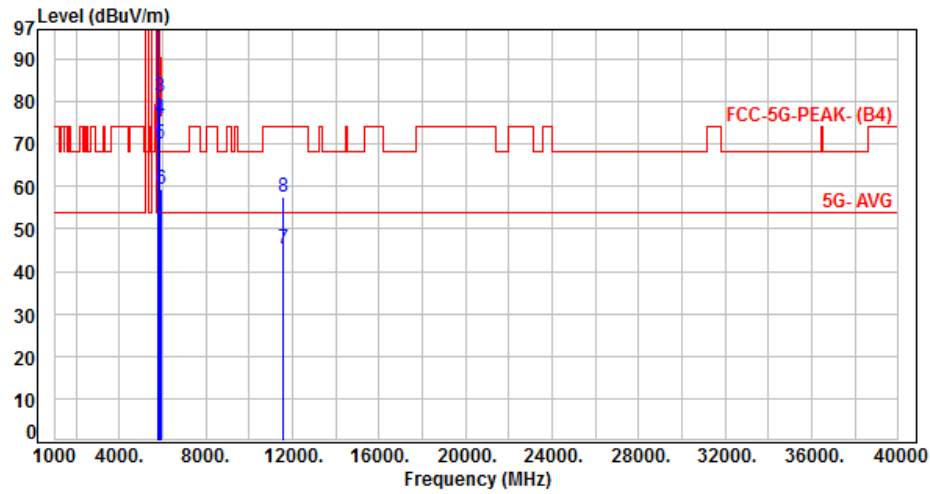

No.	Frequency (MHz)	Factor (dB)	Reading (dBuV)	Level (dBuV/m)	Limit (dBuV/m)	Margin (dB)	Detector	Height (cm)	Azimuth (deg)	P/F
1	5795.00	5.18	96.14	101.32	200.00	-98.68	Average	119	49	P
2	5795.00	5.18	108.03	113.21	200.00	-86.79	Peak	119	49	P
3	5850.00	5.21	75.89	81.10	122.20	-41.10	Peak	119	49	P
4	5855.00	5.23	70.66	75.89	110.80	-34.91	Peak	119	49	P
5	5875.00	5.31	64.69	70.00	105.20	-35.20	Peak	119	49	P
6	5925.00	5.49	53.81	59.30	68.20	-8.90	Peak	119	49	P
7	11590.00	13.55	31.64	45.19	54.00	-8.81	Average	100	133	P
8	11590.00	13.55	44.11	57.66	74.00	-16.34	Peak	100	133	P

Note: Level=Reading+Factor
 Margin=Level-Limit
 Factor=Antenna Factor + cable loss - Amplifier Factor



Power	: AC 120V / 60Hz	Pol/Phase	: HORIZONTAL
Test Mode	: Mode 5, Band 4, CH159		:

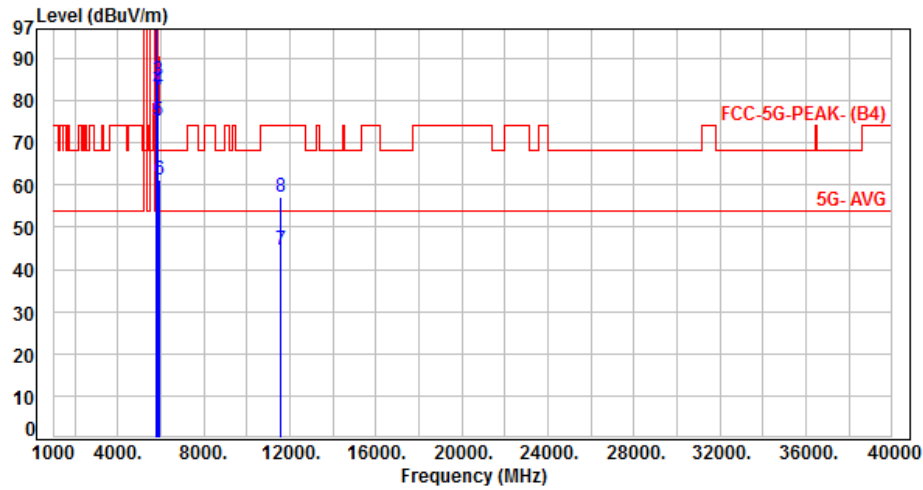

No.	Frequency (MHz)	Factor (dB)	Reading (dBuV)	Level (dBuV/m)	Limit (dBuV/m)	Margin (dB)	Detector	Height (cm)	Azimuth (deg)	P/F
1	5795.00	5.18	99.58	104.76	200.00	-95.24	Average	217	121	P
2	5795.00	5.18	111.36	116.54	200.00	-83.46	Peak	217	121	P
3	5850.00	5.21	79.77	84.98	122.20	-37.22	Peak	217	121	P
4	5855.00	5.23	77.22	82.45	110.80	-28.35	Peak	217	121	P
5	5875.00	5.31	70.05	75.36	105.20	-29.84	Peak	217	121	P
6	5925.00	5.49	55.65	61.14	68.20	-7.06	Peak	217	121	P
7	11590.00	13.55	31.23	44.78	54.00	-9.22	Average	196	74	P
8	11590.00	13.55	43.75	57.30	74.00	-16.70	Peak	196	74	P

Note: Level=Reading+Factor
 Margin=Level-Limit
 Factor=Antenna Factor + cable loss - Amplifier Factor



Power	: AC 120V / 60Hz	Pol/Phase	: VERTICAL
Test Mode	: Mode 6, Band 4, CH155		:

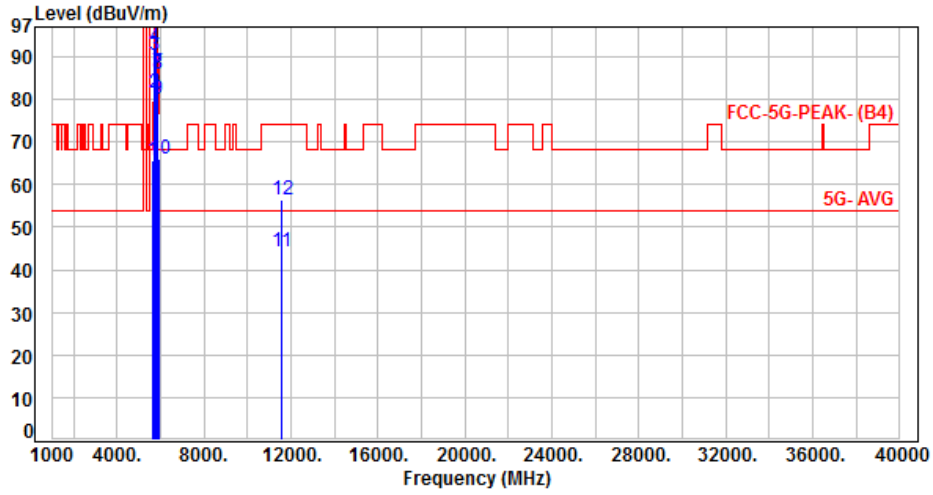

No.	Frequency (MHz)	Factor (dB)	Reading (dBuV)	Level (dBuV/m)	Limit (dBuV/m)	Margin (dB)	Detector	Height (cm)	Azimuth (deg)	P/F
1	5650.00	5.09	60.59	65.68	68.20	-2.52	Peak	125	53	P
2	5700.00	5.12	76.28	81.40	105.20	-23.80	Peak	125	53	P
3	5720.00	5.13	85.26	90.39	110.80	-20.41	Peak	125	53	P
4	5725.00	5.14	87.03	92.17	122.20	-30.03	Peak	125	53	P
5	5775.00	5.16	95.66	100.82	200.00	-99.18	Average	125	53	P
6	5775.00	5.16	105.25	110.41	200.00	-89.59	Peak	125	53	P
7	5850.00	5.21	81.02	86.23	122.20	-35.97	Peak	125	53	P
8	5855.00	5.23	80.59	85.82	110.80	-24.98	Peak	125	53	P
9	5875.00	5.31	74.69	80.00	105.20	-25.20	Peak	125	53	P
10	5925.00	5.49	60.47	65.96	68.20	-2.24	Peak	125	53	P
11	11550.00	13.44	30.65	44.09	54.00	-9.91	Average	102	139	P
12	11550.00	13.44	42.84	56.28	74.00	-17.72	Peak	102	139	P

Note: Level=Reading+Factor
 Margin=Level-Limit
 Factor=Antenna Factor + cable loss - Amplifier Factor



Power	: AC 120V / 60Hz	Pol/Phase	: HORIZONTAL
Test Mode	: Mode 6, Band 4, CH155		:

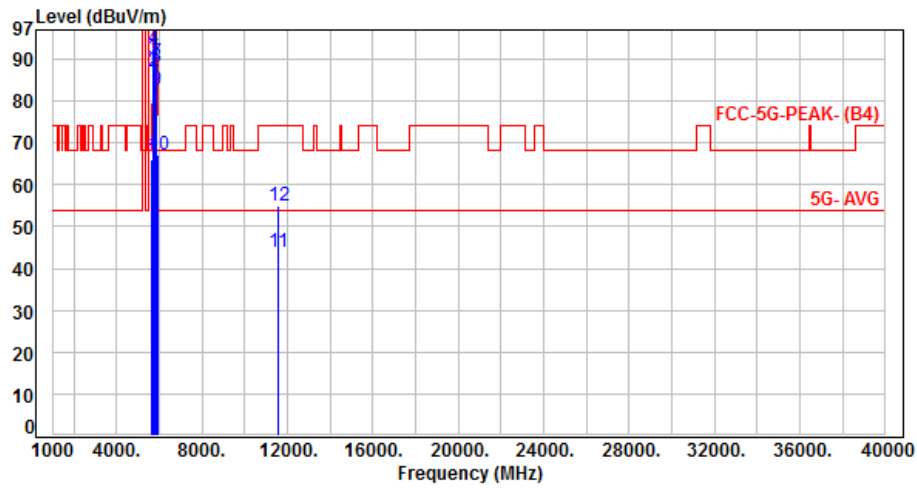

No.	Frequency (MHz)	Factor (dB)	Reading (dBuV)	Level (dBuV/m)	Limit (dBuV/m)	Margin (dB)	Detector	Height (cm)	Azimuth (deg)	P/F
1	5650.00	5.09	60.99	66.08	68.20	-2.12	Peak	200	119	P
2	5700.00	5.12	81.79	86.91	105.20	-18.29	Peak	200	119	P
3	5720.00	5.13	84.95	90.08	110.80	-20.72	Peak	200	119	P
4	5725.00	5.14	87.62	92.76	122.20	-29.44	Peak	200	119	P
5	5775.00	5.16	98.48	103.64	200.00	-96.36	Average	200	119	P
6	5775.00	5.16	108.32	113.48	200.00	-86.52	Peak	200	119	P
7	5850.00	5.21	84.20	89.41	122.20	-32.79	Peak	200	119	P
8	5855.00	5.23	82.99	88.22	110.80	-22.58	Peak	200	119	P
9	5875.00	5.31	77.40	82.71	105.20	-22.49	Peak	200	119	P
10	5925.00	5.49	61.53	67.02	68.20	-1.18	Peak	200	119	P
11	11550.00	13.44	30.43	43.87	54.00	-10.13	Average	212	105	P
12	11550.00	13.44	41.51	54.95	74.00	-19.05	Peak	212	105	P

Note: Level=Reading+Factor
 Margin=Level-Limit
 Factor=Antenna Factor + cable loss - Amplifier Factor



6.7. Restricted Bands of Operation

Only spurious emissions are permitted in any of the frequency bands listed below:

MHz	MHz	MHz	GHz
0.09000 – 0.11000	16.42000 – 16.42300	399.9 – 410.0	4.500 – 5.150
0.49500 – 0.505**	16.69475 – 16.69525	608.0 – 614.0	5.350 – 5.460
2.17350 – 2.19050	16.80425 – 16.80475	960.0 – 1240.0	7.250 – 7.750
4.12500 – 4.12800	25.50000 – 25.67000	1300.0 – 1427.0	8.025 – 8.500
4.17725 – 4.17775	37.50000 – 38.25000	1435.0 – 1626.5	9.000 – 9.200
4.20725 – 4.20775	73.00000 – 74.60000	1645.5 – 1646.5	9.300 – 9.500
6.21500 – 6.21800	74.80000 – 75.20000	1660.0 – 1710.0	10.600 – 12.700
6.26775 – 6.26825	108.00000 – 121.94000	1718.8 – 1722.2	13.250 – 13.400
6.31175 – 6.31225	123.00000 – 138.00000	2200.0 – 2300.0	14.470 – 14.500
8.29100 – 8.29400	149.90000 – 150.05000	2310.0 – 2390.0	15.350 – 16.200
8.36200 – 8.36600	156.52475 – 156.52525	2483.5 – 2500.0	17.700 – 21.400
8.37625 – 8.38675	156.70000 – 156.90000	2655.0 – 2900.0	22.010 – 23.120
8.41425 – 8.41475	162.01250 – 167.17000	3260.0 – 3267.0	23.600 – 24.000
12.29000 – 12.29300	167.72000 – 173.20000	3332.0 – 3339.0	31.200 – 31.800
12.51975 – 12.52025	240.00000 – 285.00000	3345.8 – 3358.0	36.430 – 36.500
12.57675 – 12.57725	322.00000 – 335.40000	3600.0 – 4400.0	Above 38.6
13.36000 – 13.41000			

** : Until February 1, 1999, this restricted band shall be 0.490-0.510 MHz



7. On Time, Duty Cycle and Measurement methods

7.1. Test Limit

None; for reporting purposes only.

7.2. Test Procedure

KDB 789033 Zero-Span Spectrum Analyzer Method.

7.3. Test Setup Layout

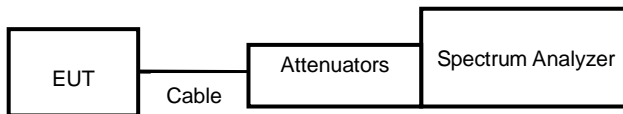



7.4. Test Result and Data

Modulation Type	On Time (ms)	Period Time (ms)	Duty Cycle (%)
802.11a,6M	2.07	2.17	95.08%
802.11ac VHT20	1.93	1.96	98.32%
802.11ac VHT40	0.96	0.98	97.32%
802.11ac VHT80	0.46	0.49	94.44%

7.5. Measurement Methods

26 dB and 6dB Emission BW	KDB 789033 D02 v02r01, Section C
99% Occupied BW	KDB 789033 D02 v02r01, Section D
Conducted Output Power	KDB 789033 D02 v02r01, Section E.2.d and E.3.b (Method PM-G)
Power Spectral Density	KDB 789033 D02 v02r01, Section F
Unwanted emissions in restricted bands	KDB 789033 D02 v02r01, Sections G and H
Unwanted emissions in non-restricted bands	KDB 789033 D02 v02r01, Sections G and H



Modulation Type: 802.11a (6Mbps)



Modulation Type: 802.11ac VHT80 (29.3Mbps)



Modulation Type: 802.11ac VHT20 (6.5Mbps)



Modulation Type: 802.11ac VHT40 (13.5Mbps)

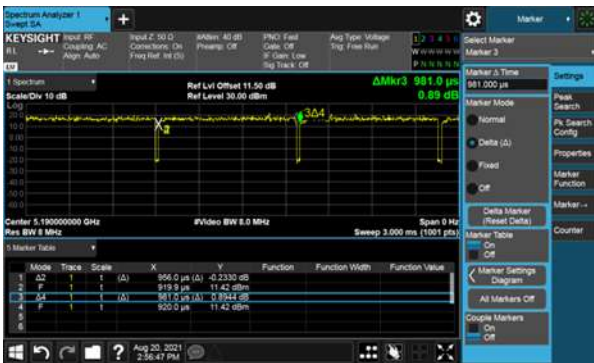



8. 6dB Bandwidth & 99% Occupied Bandwidth

8.1. Test Limit

FCC §15.407

The minimum 6 dB bandwidth shall be at least 500 kHz.

8.2. Test Procedure

Reference to 789033 D02 General UNII Test Procedures New Rules v01: The transmitter output is connected to a spectrum analyzer with the RBW set to 100KHz, the VBW $\geq 3 \times$ RBW, peak detector and max hold.

8.3. Test Setup Layout

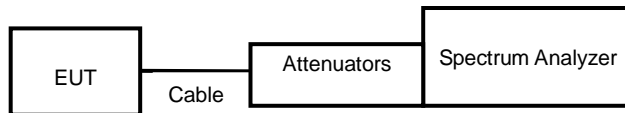

**8.4. Test Result and Data**

In the 5.8G Band

Modulation Type	Channel	Frequency (MHz)	6dB Bandwidth(MHz)			Minimum Limit (MHz)
			ANT A	ANT B	ANT C	
11a	149	5745	16.29	16.35	16.32	0.50
11a	157	5785	16.29	16.32	16.29	0.50
11a	165	5825	15.90	16.32	16.29	0.50
11ac VHT20	149	5745	17.58	17.58	17.31	0.50
11ac VHT20	157	5785	17.58	17.55	17.19	0.50
11ac VHT20	165	5825	17.55	17.55	17.22	0.50
11ac VHT40	151	5755	36.36	36.36	36.30	0.50
11ac VHT40	159	5795	36.30	36.30	36.30	0.50
11ac VHT80	155	5775	75.12	75.48	75.48	0.50

In the 5.8G Band

Modulation Type	Channel	Frequency (MHz)	99% Bandwidth(MHz)		
			ANT A	ANT B	ANT C
11a	149	5745	18.99	25.60	21.91
11a	157	5785	19.56	25.21	22.79
11a	165	5825	19.95	25.15	23.33
11ac VHT20	149	5745	19.47	25.01	21.86
11ac VHT20	157	5785	20.17	24.93	22.74
11ac VHT20	165	5825	20.69	24.84	23.30
11ac VHT40	151	5755	37.50	37.70	39.89
11ac VHT40	159	5795	37.52	37.53	40.79
11ac VHT80	155	5775	76.29	76.21	76.86



6dB Bandwidth
ANT A
Modulation Type: 802.11a (6Mbps)
CH149

Modulation Type: 802.11ac, VHT20 (6.5Mbps)
CH149



CH157



CH157



CH165



CH165





6dB Bandwidth
ANT A
Modulation Type: 802.11ac, VHT40 (13.5Mbps)
CH151

Modulation Type: 802.11ac, VHT80 (29.3Mbps)
CH155



CH159





6dB Bandwidth
ANT B
Modulation Type: 802.11a (6Mbps)
CH149

Modulation Type: 802.11ac, VHT20 (6.5Mbps)
CH149



CH157



CH157



CH165



CH165





6dB Bandwidth
ANT B
Modulation Type: 802.11ac, VHT40 (13.5Mbps)
CH151

Modulation Type: 802.11ac, VHT80 (29.3Mbps)
CH155



CH159





6dB Bandwidth
ANT C
Modulation Type: 802.11a (6Mbps)
CH149

Modulation Type: 802.11ac, VHT20 (6.5Mbps)
CH149



CH157



CH157



CH165



CH165





6dB Bandwidth
ANT C
Modulation Type: 802.11ac, VHT40 (13.5Mbps)
CH151

Modulation Type: 802.11ac, VHT80 (29.3Mbps)
CH155



CH159

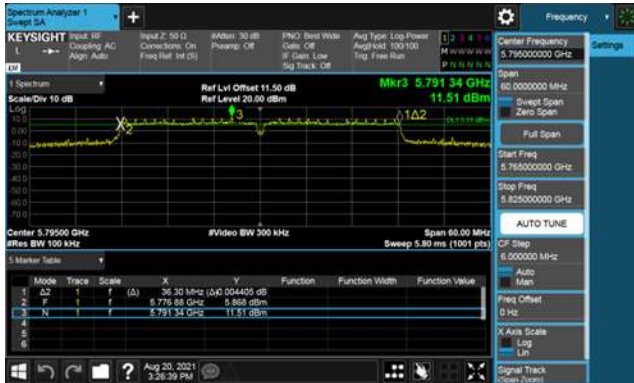



99% Occupied Bandwidth
ANT A
Modulation Type: 802.11a (6Mbps)
CH149



Modulation Type: 802.11ac, VHT20 (6.5Mbps)
CH149

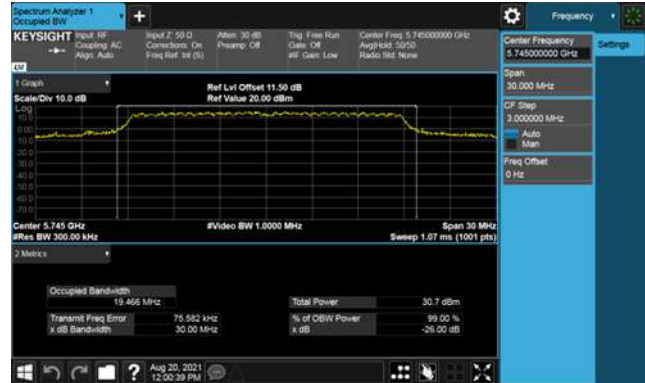

CH157



CH157

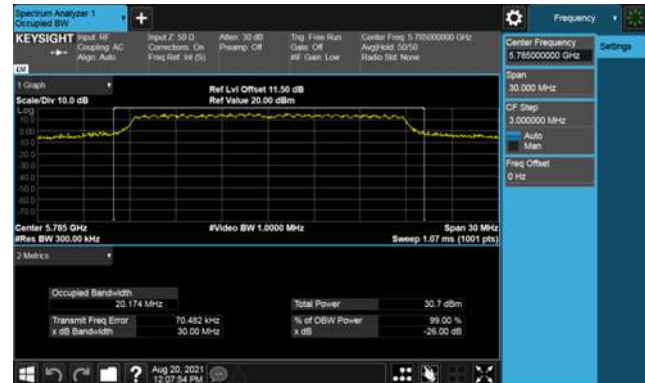

CH165



CH165





99% Occupied Bandwidth

ANT A

Modulation Type: 802.11ac, VHT40 (13.5Mbps)
CH151



Modulation Type: 802.11ac, VHT80 (29.3Mbps)
CH155



CH159





99% Occupied Bandwidth
ANT B
Modulation Type: 802.11a (6Mbps)
CH149

Modulation Type: 802.11ac, VHT20 (6.5Mbps)
CH149

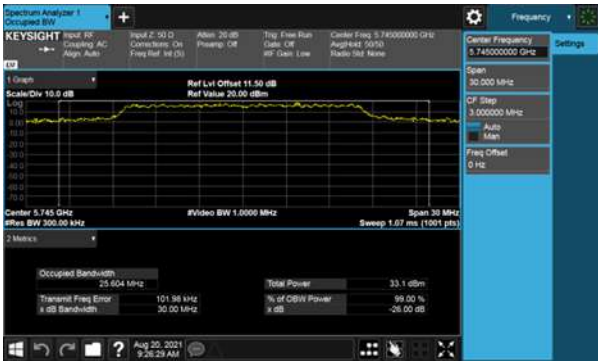

CH157



CH157



CH165



CH165





99% Occupied Bandwidth

ANT B

Modulation Type: 802.11ac, VHT40 (13.5Mbps)
CH151



Modulation Type: 802.11ac, VHT80 (29.3Mbps)
CH155



CH159





99% Occupied Bandwidth
ANT C
Modulation Type: 802.11a (6Mbps)
CH149

Modulation Type: 802.11ac, VHT20 (6.5Mbps)
CH149



CH157



CH157



CH165



CH165





99% Occupied Bandwidth

ANT C

Modulation Type: 802.11ac, VHT40 (13.5Mbps)
CH151



Modulation Type: 802.11ac, VHT80 (29.3Mbps)
CH155



CH159





9. 26dB Bandwidth & 99% Occupied Bandwidth

9.1. Test Limit

None; for reporting purposes only.

9.2. Test Procedure

Reference to 789033 D02 General UNII Test Procedures New Rules v01: The transmitter output is connected to a spectrum analyzer with the RBW = approximately 1% of the emission bandwidth, the VBW $\geq 3 \times$ RBW, peak detector and max hold.

9.3. Test Setup Layout

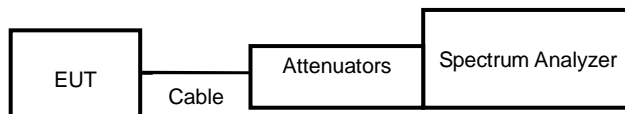



9.4. Test Result and Data

In the 5.2G Band

Mode	Channel	Frequency (MHz)	26dB Bandwidth(MHz)		
			ANT A	ANT B	ANT C
11a	36	5180	20.27	20.19	20.44
11a	40	5200	20.47	20.32	20.90
11a	48	5240	21.28	20.48	20.82
11ac VHT20	36	5180	20.74	20.71	20.69
11ac VHT20	40	5200	22.27	22.44	21.47
11ac VHT20	48	5240	25.56	23.82	27.48
11ac VHT40	38	5190	40.57	40.42	49.03
11ac VHT40	46	5230	74.55	73.89	81.14
11ac VHT80	42	5210	82.30	82.20	82.80

In the 5.2G Band

Modulation Type	Channel	Frequency (MHz)	99% Bandwidth(MHz)		
			ANT A	ANT B	ANT C
11a	36	5180	16.79	16.76	16.87
11a	40	5200	16.83	16.78	16.93
11a	48	5240	16.85	16.82	16.95
11ac VHT20	36	5180	17.77	17.81	17.89
11ac VHT20	40	5200	17.82	17.89	17.99
11ac VHT20	48	5240	17.86	17.91	18.02
11ac VHT40	38	5190	36.61	36.61	36.69
11ac VHT40	46	5230	36.89	36.93	37.02
11ac VHT80	42	5210	75.70	75.66	75.69



26dB Bandwidth Band 1
ANT A
Modulation Type: 802.11a (6Mbps)
CH36

802.11ac VHT20 (6.5Mbps)
CH36



CH40

CH40



CH48

CH48





26dB Bandwidth Band 1

ANT A

Modulation Type: 802.11ac VHT40 (13.5Mbps)
CH38

Modulation Type: 802.11ac VHT80 (29.3Mbps)
CH42



CH46





26dB Bandwidth Band 1
ANT B
Modulation Type: 802.11a (6Mbps)
CH36

802.11ac VHT20 (6.5Mbps)
CH36



CH40

CH40



CH48

CH48





26dB Bandwidth Band 1

ANT B

Modulation Type: 802.11ac VHT40 (13.5Mbps)
CH38

Modulation Type: 802.11ac VHT80 (29.3Mbps)
CH42

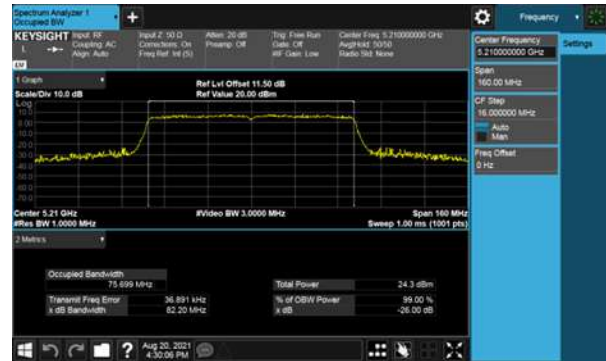

CH46





26dB Bandwidth Band 1
ANT C
Modulation Type: 802.11a (6Mbps)
CH36

802.11ac VHT20 (6.5Mbps)
CH36



CH40

CH40



CH48

CH48





26dB Bandwidth Band 1

ANT C

Modulation Type: 802.11ac VHT40 (13.5Mbps)
CH38

Modulation Type: 802.11ac VHT80 (29.3Mbps)
CH42



CH46





99% Bandwidth Band 1
ANT A
Modulation Type: 802.11a (6Mbps)
CH36

802.11ac VHT20 (6.5Mbps)
CH36



CH40

CH40



CH48

CH48





99% Bandwidth Band 1

ANT A

Modulation Type: 802.11ac VHT40 (13.5Mbps)
CH38

Modulation Type: 802.11ac VHT80 (29.3Mbps)
CH42



CH46





99% Bandwidth Band 1
ANT B
Modulation Type: 802.11a (6Mbps)
CH36

802.11ac VHT20 (6.5Mbps)
CH36



CH40

CH40



CH48

CH48





99% Bandwidth Band 1

ANT B

Modulation Type: 802.11ac VHT40 (13.5Mbps)
CH38

Modulation Type: 802.11ac VHT80 (29.3Mbps)
CH42



CH46





99% Bandwidth Band 1
ANT C
Modulation Type: 802.11a (6Mbps)
CH36

802.11ac VHT20 (6.5Mbps)
CH36



CH40

CH40



CH48

CH48





99% Bandwidth Band 1

ANT C

Modulation Type: 802.11ac VHT40 (13.5Mbps)
CH38

Modulation Type: 802.11ac VHT80 (29.3Mbps)
CH42



CH46





10. Average Power

10.1. Test Limit

Output Power:

Frequency Band	Limit	
<input checked="" type="checkbox"/> 5.15~5.25GHz		
Operating Mode		
<input type="checkbox"/>	Outdoor access point	The maximum conducted output power over the frequency band of operation shall not exceed 1 W (30dBm) provided the maximum antenna gain does not exceed 6 dBi. If transmitting antennas of directional gain greater than 6 dBi are used, both the maximum conducted output power and the maximum power spectral density shall be reduced by the amount in dB that the directional gain of the antenna exceeds 6 dBi. The maximum e.i.r.p. at any elevation angle above 30degrees as measured from the horizon must not exceed 125 mW (21 dBm).
<input checked="" type="checkbox"/>	Indoor access point	The maximum conducted output power over the frequency band of operation shall not exceed 1 W (30dBm) provided the maximum antenna gain does not exceed 6 dBi. If transmitting antennas of directional gain greater than 6 dBi are used, both the maximum conducted output power and the maximum power spectral density shall be reduced by the amount in dB that the directional gain of the antenna exceeds 6 dBi.
<input type="checkbox"/>	Fixed point-to-point access points	The maximum conducted output power over the frequency band of operation shall not exceed 1 W (30dBm). Fixed point-to-point U-NII devices may employ antennas with directional gain up to 23 dBi without any corresponding reduction in the maximum conducted output power or maximum power spectral density. For fixed point-to-point transmitters that employ a directional antenna gain greater than 23 dBi, a 1 dB reduction in maximum conducted output power and maximum power spectral density is required for each 1 dB of antenna gain in excess of 23 dBi.
<input type="checkbox"/>	client devices	The maximum conducted output power over the frequency band of operation shall not exceed 250 mW (24dBm) provided the maximum antenna gain does not exceed 6 dBi. If transmitting antennas of directional gain greater than 6 dBi are used, both the maximum conducted output power and the maximum power spectral density shall be reduced by the amount in dB that the directional gain of the antenna exceeds 6 dBi.



Frequency Band	Limit
<input type="checkbox"/> 5.25-5.35 GHz	The maximum conducted output power over the frequency bands of operation shall not exceed the lesser of 250 mW (24dBm) or 11 dBm 10 log B, where B is the 26 dB emission bandwidth in megahertz. If transmitting antennas of directional gain greater than 6 dBi are used, both the maximum conducted output power and the maximum power spectral density shall be reduced by the amount in dB that the directional gain of the antenna exceeds 6 dBi.
<input type="checkbox"/> 5.470-5.725 GHz	
<input checked="" type="checkbox"/> 5.725~5.85 GHz	

10.2. Test Procedure

The transmitter output is connected to a power meter. The cable assembly insertion loss of 11.5 dB (including 10 dB pad and 1.5 dB cable) was entered as an offset in the power meter to allow for direct reading of power.

10.3. Test Setup Layout

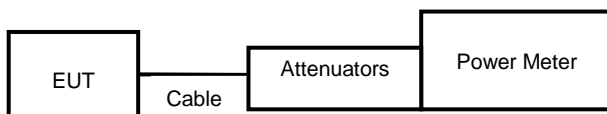

**10.4. Test Result and Data**

In the 5.2G Band

Modulation Type	Data Rate	Setting	Channel	Frequency (MHz)	Measured value of each antenna port (dBm)			Total power (dBm)	Total power (mW)	FCC Limit (dBm)
					ANT A(AJ1)	ANT B(AJ2)	ANT C(AJ6)			
11a	6 Mbps	80	36	5180	17.68	17.98	17.85	22.61	182.373	30.00
11a	6 Mbps	84	40	5200	18.68	19.21	18.85	23.69	233.895	30.00
11a	6 Mbps	86	48	5240	19.89	20.35	19.91	24.83	303.841	30.00
11n HT20	MCS 0	80	36	5180	17.48	17.91	17.85	22.52	178.731	30.00
11n HT20	MCS 0	86	40	5200	19.03	19.48	19.42	24.09	256.197	30.00
11n HT20	MCS 0	88	48	5240	19.84	20.31	20.15	24.88	307.296	30.00
11n HT40	MCS 0	82	38	5190	17.52	17.61	17.84	22.43	174.984	30.00
11n HT40	MCS 0	94	46	5230	20.87	21.35	21.19	25.91	390.161	30.00
11ac VHT20	NSS1-MCS0	80	36	5180	17.52	17.94	17.86	22.55	179.818	30.00
11ac VHT20	NSS1-MCS0	86	40	5200	19.07	19.52	19.47	24.13	258.772	30.00
11ac VHT20	NSS1-MCS0	88	48	5240	19.89	20.37	20.16	24.92	310.145	30.00
11ac VHT40	NSS1-MCS0	82	38	5190	17.53	17.66	17.87	22.46	176.203	30.00
11ac VHT40	NSS1-MCS0	94	46	5230	20.91	21.40	21.22	25.95	393.783	30.00
11ac VHT80	NSS1-MCS0	70	42	5210	15.07	15.51	15.62	20.18	104.175	30.00

In the 5.8G Band

Modulation Type	Data Rate	Setting	Channel	Frequency (MHz)	Measured value of each antenna port (dBm)			Total power (dBm)	Total power (mW)	FCC Limit (dBm)
					ANT A(AJ1)	ANT B(AJ2)	ANT C(AJ6)			
11a	6 Mbps	106	149	5745	23.72	25.73	24.77	29.59	909.532	30.00
11a	6 Mbps	106	157	5785	23.58	26.04	23.98	29.44	879.860	30.00
11a	6 Mbps	106	165	5825	23.53	26.05	24.34	29.54	899.785	30.00
11n HT20	MCS 0	106	149	5745	23.78	25.94	24.73	29.68	928.593	30.00
11n HT20	MCS 0	106	157	5785	23.60	25.89	24.48	29.53	897.780	30.00
11n HT20	MCS 0	106	165	5825	23.42	26.01	24.05	29.41	872.908	30.00
11n HT40	MCS 0	106	151	5755	22.91	23.88	23.72	28.29	675.282	30.00
11n HT40	MCS 0	106	159	5795	22.92	24.02	23.59	28.30	676.792	30.00
11ac VHT20	NSS1-MCS0	106	149	5745	23.82	25.99	24.76	29.72	937.409	30.00
11ac VHT20	NSS1-MCS0	106	157	5785	23.62	25.91	24.50	29.55	901.924	30.00
11ac VHT20	NSS1-MCS0	106	165	5825	23.46	26.05	24.08	29.45	880.395	30.00
11ac VHT40	NSS1-MCS0	106	151	5755	22.95	23.89	23.77	28.33	680.381	30.00
11ac VHT40	NSS1-MCS0	106	159	5795	22.94	24.04	23.61	28.32	679.916	30.00
11ac VHT80	NSS1-MCS0	100	155	5775	22.11	23.11	22.80	27.46	557.745	30.00



11. Power Spectral Density

11.1. Test Limit

PSD:

Frequency Band		Limit
<input checked="" type="checkbox"/>	5.15~5.25GHz	
	Operating Mode	
<input type="checkbox"/>	Outdoor access point	17 dBm/MHz
<input checked="" type="checkbox"/>	Indoor access point	17 dBm/MHz
<input type="checkbox"/>	Fixed point-to-point access points	17 dBm/MHz
<input type="checkbox"/>	Mobile and portable client devices	11 dBm/MHz
<input type="checkbox"/>	5.725~5.85 GHz	11 dBm/MHz
<input type="checkbox"/>	5.470-5.725 GHz	11 dBm/MHz
<input checked="" type="checkbox"/>	5.725~5.85 GHz	30 dBm/500kHz

11.2. Test Procedure

Reference to KDB789033 D02 General UNII Test Procedures New Rules v02r01

11.3. Test Setup Layout

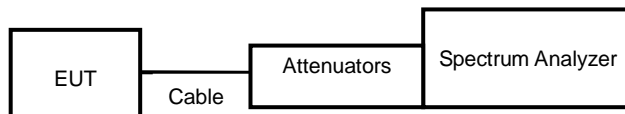

**11.4. Test Result and Data**

In the 5.2G Band

Modulation Type	Channel	Frequency (MHz)	Meas PSD (dBm/MHz)			Sum chain (dBm)	Duty Cycle CF(dB)	Total Corr'd PSD (dBm/MHz)	PSD Limit (dBm/MHz)
			ANT A	ANT B	ANT C				
11a	36	5180	5.76	6.08	7.23	11.17	0.22	11.39	14.94
11a	40	5200	6.91	7.22	8.14	12.22	0.22	12.44	14.94
11a	48	5240	7.25	7.60	8.49	12.58	0.22	12.80	14.94
11ac VHT20	36	5180	5.76	6.68	7.08	11.31	0.00	11.31	14.94
11ac VHT20	40	5200	7.43	8.55	8.73	13.05	0.00	13.05	14.94
11ac VHT20	48	5240	7.78	8.78	9.18	13.39	0.00	13.39	14.94
11ac VHT40	38	5190	2.40	2.92	4.00	7.93	0.12	8.05	14.94
11ac VHT40	46	5230	5.76	6.21	7.43	11.30	0.12	11.42	14.94
11ac VHT80	42	5210	-3.25	-2.51	-1.62	2.36	0.25	2.61	14.94

In the 5.8G Band

Modulation Type	Channel (MHz)	Frequency (MHz)	Meas PSD (dBm/MHz)			Sum chain (dBm)	Duty Cycle CF(dB)	10log(500K Hz/RBW) CF (dB)	Total Corr'd PSD (dBm/500kHz)	PSD Limit (dBm/500kHz)
			ANT A	ANT B	ANT C					
11a	149	5745	12.16	14.55	13.58	18.31	0.22	-3.01	15.52	26.98
11a	157	5785	11.95	14.69	13.43	18.27	0.22	-3.01	15.48	26.98
11a	165	5825	11.54	14.52	13.36	18.07	0.22	-3.01	15.28	26.98
11ac VHT20	149	5745	12.01	13.15	13.70	17.78	0.00	-3.01	14.77	26.98
11ac VHT20	157	5785	12.03	13.36	13.42	17.76	0.00	-3.01	14.75	26.98
11ac VHT20	165	5825	11.91	13.35	13.40	17.71	0.00	-3.01	14.70	26.98
11ac VHT40	151	5755	8.40	9.08	9.92	13.95	0.12	-3.01	11.06	26.98
11ac VHT40	159	5795	8.59	9.45	9.94	14.13	0.12	-3.01	11.24	26.98
11ac VHT80	155	5775	4.89	5.11	6.29	10.24	0.25	-3.01	7.48	26.98



Band 1 ANT A

Modulation Type: 802.11a (6Mbps)

CH36



Modulation Type: 802.11ac VHT20 (6.5Mbps)

CH36



CH40



CH40



CH48



CH48





Band 1 ANT A

Modulation Type: 802.11ac VHT40 (13.5Mbps)

CH38

Modulation Type: 802.11ac VHT80 (29.3Mbps)

CH42



CH46





Band 1 ANT B

Modulation Type: 802.11a (6Mbps)

CH36



Modulation Type: 802.11ac VHT20 (6.5Mbps)

CH36



CH40



CH40



CH48



CH48





Band 1 ANT B

Modulation Type: 802.11ac VHT40 (13.5Mbps)

CH38

Modulation Type: 802.11ac VHT80 (29.3Mbps)

CH42



CH46





Band 1 ANT C

Modulation Type: 802.11a (6Mbps)

CH36



Modulation Type: 802.11ac VHT20 (6.5Mbps)

CH36



CH40



CH40



CH48



CH48





Band 1 ANT C

Modulation Type: 802.11ac VHT40 (13.5Mbps)

CH38

Modulation Type: 802.11ac VHT80 (29.3Mbps)

CH42



CH46





Band 4 ANT A

Modulation Type: 802.11a (6Mbps)

CH149



Modulation Type: 802.11ac VHT20 (6.5Mbps)

CH149



CH157



CH157



CH165



CH165





Band 4 ANT A

Modulation Type: 802.11ac VHT40 (13.5Mbps)
CH151

Modulation Type: 802.11ac VHT80 (29.3Mbps)
CH155



CH159





Band 4 ANT B

Modulation Type: 802.11a (6Mbps)

CH149



Modulation Type: 802.11ac VHT20 (6.5Mbps)

CH149



CH157



CH157



CH165



CH165





Band 4 ANT B

Modulation Type: 802.11ac VHT40 (13.5Mbps)
CH151

Modulation Type: 802.11ac VHT80 (29.3Mbps)
CH155



CH159





Band 4 ANT C

Modulation Type: 802.11a (6Mbps)

CH149



Modulation Type: 802.11ac VHT20 (6.5Mbps)

CH149



CH157



CH157



CH165



CH165



