



FCC RADIO TEST REPORT

Applicant : CASTLENET TECHNOLOGY INC.
Address : No. 14, Ln. 141, Sec. 3, Beishen Rd., Shenkeng
Dist., New Taipei City 22244, Taiwan (R.O.C.)
Equipment : D3.0 Cable Gateway
Model No. : 1. CBV384Z4-AC1600MP
2. Infinity401 N
Trade Name : CASTLENET
FCC ID : RK9-CBV384Z4C16MP

I HEREBY CERTIFY THAT :

The sample was received on Jun. 22, 2021 and the testing was completed on Aug. 23, 2021 at CerpPASS Technology Corp. The test result refers exclusively to the test presented test model / sample. Without written approval of CerpPASS Technology Corp., the test report shall not be reproduced except in full.

Approved by:

Mark Liao / Supervisor

Laboratory Accreditation:

CerpPASS Technology Corporation Test Laboratory





Contents

1. Summary of Test Procedure and Test Results.....	5
1.1 Applicable Standards	5
2. Test Configuration of Equipment under Test	6
2.1 Feature of Equipment.....	6
2.2 Carrier Frequency of Channels.....	7
2.3 Test Mode and Test Software.....	8
2.4 Description of Test System.....	10
2.5 General Information of Test.....	11
2.6 Measurement Uncertainty	11
3. Test Equipment and Ancillaries Used for Tests	12
4. Antenna Requirements.....	14
4.1 Antenna Construction and Directional Gain.....	14
5. Test of AC Power Line Conducted Emission	15
5.1 Test Limit	15
5.2 Test Procedures	15
5.3 Typical Test Setup	16
5.4 Test Result and Data.....	17
5.5 Test Photographs	19
6. Test of Radiated Spurious Emission.....	20
6.1 Test Limit	20
6.2 Test Procedures	21
6.3 Typical Test Setup	22
6.4 Test Result and Data (9KHz ~ 30MHz)	23
6.5 Test Result and Data (30MHz ~ 1GHz).....	23
6.6 Test Result and Data (1GHz ~ 25GHz).....	25
6.7 Restricted Bands of Operation	49
6.8 Test Photographs (30MHz ~ 1GHz).....	50
6.9 Test Photographs (1GHz ~ 25GHz).....	51
7. Test of Conducted Spurious Emission	53
7.1 Test Limit	53
7.2 Test Procedure	53
7.3 Test Setup Layout	53
7.4 Test Result and Data.....	53
8. On Time, Duty Cycle and Measurement methods	68
8.1 Test Limit	68
8.2 Test Procedure	68
8.3 Test Setup Layout	68
8.4 Test Result and Data.....	68
9. 6dB Bandwidth Measurement Data	70
9.1 Test Limit	70
9.2 Test Procedures	70
9.3 Test Setup Layout	70



9.4 Test Result and Data 71

10. Maximum Peak and Average Output Power 76

10.1 Test Limit 76

10.2 Test Procedures 76

10.3 Test Setup Layout 76

10.4 Test Result and Data 77

11. Power Spectral Density 78

11.1 Test Limit 78

11.2 Test Procedures 78

11.3 Test Setup Layout 78

11.4 Test Result and Data 79

12. Radio Frequency Exposure 84

12.1 Applicable Standards 84

12.2 EUT Specification 84

12.3 Test Results 85

12.4 Calculation 85

12.5 Maximum Permissible Exposure 86



History of this test report

Report No.	Issue Date	Description
21060187-TRFCC01	Aug. 31, 2021	Original



1. Summary of Test Procedure and Test Results

1.1 Applicable Standards

ANSI C63.10:2013

FCC Rules and Regulations Part 15 Subpart C §15.247

FCC Rule	Description of Test	Result
15.203	. Antenna Requirement	PASS
15.207	. AC Power Line Conducted Emission	PASS
15.209 15.205	. Radiated Spurious Emission	PASS
15.247(d)	. Conducted Spurious Emission	PASS
15.247(a)(2)	. 6dB Bandwidth	PASS
15.247(b)	. Maximum Peak and Average Output Power	PASS
15.247(e)	. Power Spectral Density	PASS
2.1091	. Radio Frequency Exposure	PASS

*The lab has reduced the uncertainty risk factor from test equipment, environment and staff technicians which according to the standard on contract. Therefore, the test result will only be determined by standard requirement.



2. Test Configuration of Equipment under Test

2.1 Feature of Equipment

Operation Frequency Range	802.11b/g/n: 2400-2483.5MHz 802.11a/n/ac: 5150-5250MHz, 5725-5850MHz
Center Frequency Range	802.11b/g/n: 2412MHz~2462MHz 802.11a/n/ac: 5180-5240MHz, 5745-5825MHz
Modulation Type	WLAN: 2.4GHz: 802.11b: CCK, DQPSK, DBPSK 802.11g/n: BPSK, QPSK, 16QAM, 64QAM 5GHz: 802.11n/a: BPSK, QPSK, 16QAM, 64QAM 802.11ac: BPSK, QPSK, 16QAM, 64QAM, 256QAM
Modulation Technology	DSSS, OFDM
Data Rate	WLAN: 2.4GHz: 802.11b: 1, 2, 5.5, 11Mbps 802.11g: 6, 9, 12, 18, 24, 36, 48, 54Mbps 802.11n: MCS0 – MCS15, HT20/40 5GHz: 802.11a: 6, 9, 12, 18, 24, 36, 48, 54Mbps 802.11n: MCS0 – MCS23, HT20/40 802.11ac: MCS0 – MCS9, VHT20/40/80
Antenna Type	Dipole Antenna
Antenna Gain	2400-2483.5MHz: ANT A: 4.41dBi, ANT C: 2.67dBi 5150-5250MHz: ANT A: 3.06dBi, ANT B: 4.23dBi, ANT C: 2.50dBi 5725-5850MHz: ANT A: 5.18dBi, ANT B: 3.56dBi, ANT C: 3.92dBi
Adapter	1.Brand: MOSO, Model: MS-V2000R120-024H0-US 2.Brand: AcBel, Model: WAM005

Note:

- 1.802.11b fix ANT A(AJ1) transmit signal.
- 2.EUT not support TPC Function.
- 3.For more details, please refer to the User's manual of the EUT.

Difference description:

Model No.	Remark
CBV384Z4-AC1600MP	For market distinction.
Infinity401 N	



2.2 Carrier Frequency of Channels

802.11b, 802.11g, 802.11n HT20 (2412MHz~2462MHz)

Channel	Frequency(MHz)	Channel	Frequency(MHz)
*01	2412	07	2442
02	2417	08	2447
03	2422	09	2452
04	2427	10	2457
05	2432	*11	2462
*06	2437	---	---

802.11n HT40 (2422MHz~2452MHz)

Channel	Frequency(MHz)	Channel	Frequency(MHz)
---	---	07	2442
---	---	08	2447
*03	2422	*09	2452
04	2427	---	---
05	2432	---	---
*06	2437	---	---

Note: Channels remarked * are selected to perform test.



2.3 Test Mode and Test Software

- a. During testing, the interface cables and equipment positions were varied according to ANSI C63.10.
- b. The complete test system included Remote workstation and EUT for RF test. The Remote workstation included Notebook.
- c. An executive program, " Mtool ver. 2.0.1.0" under Windows OS system was executed to transmit and receive data via WLAN.
- d. The following test modes were performed for the test:

Conducted Emissions from the AC mains power ports	
Test Mode	Operating Description
1	802.11b (1Mbps) Adapter: MS-V2000R120-024H0-US
2	802.11g (6Mbps) Adapter: MS-V2000R120-024H0-US
3	802.11n HT20 (6.5Mbps) Adapter: MS-V2000R120-024H0-US
4	802.11n HT40 (13.5Mbps) Adapter: MS-V2000R120-024H0-US
5	802.11b (1Mbps) Adapter: WAM005
6	802.11g (6Mbps) Adapter: WAM005
7	802.11n HT20 (6.5Mbps) Adapter: WAM005
8	802.11n HT40 (13.5Mbps) Adapter: WAM005
caused "Test Mode 3" generated the worst case, it was reported as the final data.	
Radiation Emissions ((9KHz ~30MHz & 30MHz ~ 1GHz))	
Test Mode	Operating Description
1	802.11b (1Mbps) Adapter: MS-V2000R120-024H0-US
2	802.11g (6Mbps) Adapter: MS-V2000R120-024H0-US
3	802.11n HT20 (6.5Mbps) Adapter: MS-V2000R120-024H0-US
4	802.11n HT40 (13.5Mbps) Adapter: MS-V2000R120-024H0-US
5	802.11b (1Mbps) Adapter: WAM005
6	802.11g (6Mbps) Adapter: WAM005
7	802.11n HT20 (6.5Mbps) Adapter: WAM005
8	802.11n HT40 (13.5Mbps) Adapter: WAM005
caused "Test Mode 3" generated the worst case, it was reported as the final data.	
Radiation Emissions (1GHz ~ 25GHz)	
Test Mode	Operating Description
1	802.11b (1Mbps) Adapter: MS-V2000R120-024H0-US
2	802.11g (6Mbps) Adapter: MS-V2000R120-024H0-US
3	802.11n HT20 (6.5Mbps) Adapter: MS-V2000R120-024H0-US
4	802.11n HT40 (13.5Mbps) Adapter: MS-V2000R120-024H0-US
5	802.11b (1Mbps) Adapter: WAM005
6	802.11g (6Mbps) Adapter: WAM005
7	802.11n HT20 (6.5Mbps) Adapter: WAM005
8	802.11n HT40 (13.5Mbps) Adapter: WAM005
caused "Test Mode 1~4" generated the worst case, they were reported as the final data.	



The EUT incorporates a MIMO function

Modulation Type	TX CONFIGURATION
802.11b	1TX ,ANT A(AJ1)
802.11g	2TX
802.11n HT20	2TX
802.11n HT40	2TX



2.4 Description of Test System

RF Conducted				
Equipment	Brand	Model	Length/Type	Power cord/Length/Type
Notebook	ASUS	P2430U	N/A	Adapter / 1.8m / NS
RJ45 Cable	N/A	N/A	1.2m / NS	N/A
Radiated Emissions				
Equipment	Brand	Model	Length/Type	Power cord/Length/Type
Notebook	DELL	Vostro 3560	N/A	Adapter / 1.8m / NS
RJ45 Cable	N/A	N/A	15m / NS	N/A
AC Power Line Conducted Emission				
Equipment	Brand	Model	Length/Type	Power cord/Length/Type
Notebook	DELL	Vostro 3560	N/A	Adapter / 1.8m / NS
RJ45 Cable	N/A	N/A	3m / NS	N/A



2.5 General Information of Test

Test Site	Cerpass Technology Corporation Test Laboratory Address: No.10, Ln. 2, Lianfu St., Luzhu Dist., Taoyuan City 33848, Taiwan (R.O.C.) Tel:+886-3-3226-888 Fax:+886-3-3226-881	
	FCC	TW1079, TW1439
	IC	4934E-1, 4934E-2
	VCCI	T-2205 for Telecommunication test C-4663 for Conducted emission test R-4218 for Radiated emission test G-10812, G-10813 for radiated disturbance above 1GHz
Frequency Range Investigated:	Conducted: from 150kHz to 30 MHz Radiation: from 30 MHz to 25,000MHz	
Test Distance:	The test distance of radiated emission from antenna to EUT is 3 M.	

Test Item	Test Site	Test Period	Environmental Conditions	Tested By
RF Conducted	RFCON01-NK	2021/08/19	28°C / 49%	Nick Guan
Radiated Emissions	3M02-NK	2021/08/17~2021/08/19	22~25°C / 43~48%	Nick Guan
AC Power Line Conducted Emission	CON01-NK	2021/08/23	27°C / 55%	Dian Chen

2.6 Measurement Uncertainty

Measurement Item	Uncertainty
AC Power Line Conduction(150K~30MHz)	±3.63dB
Radiated Spurious Emission(9KHz~30MHz)	±3.4dB
Radiated Spurious Emission(30MHz~1GHz)	±5.6dB
Radiated Spurious Emission(1GHz~25GHz)	±6.6dB
Conducted Spurious Emission	±1.8dB
6dB Bandwidth	±4.4%
20dB Bandwidth	±4.4%
Occupied Bandwidth	±4.4%
Peak Output Power(Conducted Power Meter)	±1.1dB
Dwell Time / Deactivation Time	±1.2%
Power Spectral Density	±1.8dB
Duty Cycle	±1.2%



3. Test Equipment and Ancillaries Used for Tests

Test Item	Radiated Emissions				
Test Site	Semi Anechoic Room(3M02-NK)				
Instrument	Manufacturer	Model No	Serial No	Calibration Date	Valid Date
Bilog Antenna	Schwarzbeck	VULB9168	369	2021/04/26	2022/04/25
Active Loop Antenna	EMCO	6507	40855	2021/06/10	2022/06/09
Horn Antenna	EMCO	3115	31601	2020/10/16	2021/10/15
Horn Antenna	EMCO	3116	31974	2020/09/24	2021/09/23
EMI Receiver	ROHDE & SCHWARZ	ESCI	101423	2021/06/30	2022/06/29
Spectrum Analyzer	ROHDE & SCHWARZ	FSV 40-N	102151	2021/07/14	2022/07/13
Preamplifier	EM Electronics corp.	EM330	60658	2020/10/20	2021/10/19
Preamplifier	EM Electronics corp.	EM330	60660	2021/03/18	2022/03/17
Preamplifier	Agilent	8449B	3008A01954	2021/03/22	2022/03/21
Preamplifier	EMC INSTRUMENTS	EMC184045	980065	2020/11/06	2021/11/05
Bluetooth Tester	ROHDE & SCHWARZ	CBT	101133	2021/04/19	2022/04/18
Cable-3in1(30M-1G)	HARBOUR INDUSTRIES	LL142	CCE1315	2021/04/12	2022/04/11
Cable-0.5m(1G-18G)	EMEC	EM104-SMSM-0.5M	CCE1354	2021/05/06	2022/05/05
Cable-3m(1G-18G)	EMEC	EM104-SMSM-3M	CCE1355	2021/05/06	2022/05/05
Cable-8m(1G-18G)	EMEC	EM104-SMSM-8M	CCE1356	2021/05/06	2022/05/05
Cable-0.5m(30M-40G)	HUBER SUHNER	SUCOFLEX 102	28420/2	2021/04/03	2022/04/02
Cable-3m(30M-40G)	HUBER SUHNER	SUCOFLEX 102	MY2608/2	2021/04/09	2022/04/08
Cable-0.5m(1G-40G)	Rapidtek	40GHZ 50CM	38MS-38MS50 314	2021/04/08	2022/04/07
Cable-6m(9k~300M)	NA	EMC5D-BM-BM-6	130605	2020/09/18	2021/09/17
E3	AUDIX	v8.2014-8-6	RK-000529	NA	NA

Test Item	RF Conducted				
Test Site	RFCON01-NK				
Instrument	Manufacturer	Model No	Serial No	Calibration Date	Valid Date
Spectrum Analyzer	ROHDE & SCHWARZ	FSV 40-N	102151	2021/07/14	2022/07/13
Bluetooth Tester	ROHDE & SCHWARZ	CBT	101133	2021/04/19	2022/04/18
CAX Signal Analyzer	KEYSIGHT	N9000B	MY57100339	2020/12/25	2021/12/24
Attenuator	KEYSIGHT	8491B	MY39250703	2021/04/09	2022/04/08
TEMP & HUMIDITY CHAMBER	T-MACHINE	TMJ-9712	T-12-040111	2020/08/25	2021/08/24
Power Meter	Anritsu	ML2495A	1224005	2021/04/14	2022/04/13
Power Sensor	Anritsu	MA2411B	1207295	2021/04/14	2022/04/13



Test Item	AC Power Line Conducted Emission				
Test Site	CON01-NK				
Instrument	Manufacturer	Model No	Serial No	Calibration Date	Valid Date
EMI Receiver	ROHDE & SCHWARZ	ESCI	100821	2020/09/11	2021/09/10
Line Impedance Stabilization Network	Schwarzbeck	NSLK 8127	8127-516	2020/09/26	2021/09/25
Pulse Limiter	ROHDE & SCHWARZ	ESH3-Z2	101933	2020/09/17	2021/09/16
Cable-6m(9k~300M)	NA	EMC5D-BM-BM-6	130605	2020/09/18	2021/09/17
E3	AUDIX	v8.2014-8-6	RK-000531	NA	NA



4. Antenna Requirements

4.1 Antenna Construction and Directional Gain

Antenna Type	Dipole Antenna
Antenna Gain	ANT A: 4.41dBi, ANT C: 2.67dBi

2412-2462MHz:

For 11b:

For Power directional gain= $G_{ant}= 4.41$ dBi

For PSD directional gain = $G_{ant}= 4.41$ dBi

For 11g / 11n:

For Power directional gain= $G_{ant}= 4.41$ dBi

For PSD directional gain = $10 \log[(10^{G^1/20} + 10^{G^2/20} + \dots + 10^{G^N/20})^2 / N_{ANT}]$
= 6.59 (dBi)



5. Test of AC Power Line Conducted Emission

5.1 Test Limit

Conducted Emissions were measured from 150 kHz to 30 MHz with a bandwidth of 9 KHz, according to the methods defined in ANSI C63.4-2014. The EUT was placed on a nonmetallic stand in a shielded room 0.8 meters above the ground plane. The interface cables and equipment positioning were varied within limits of reasonable applications to determine the position produced maximum conducted emissions.

Frequency (MHz)	Quasi Peak (dB μ V)	Average (dB μ V)
0.15 – 0.5	66-56*	56-46*
0.5 – 5.0	56	46
5.0 – 30.0	60	50

*Decreases with the logarithm of the frequency.

5.2 Test Procedures

- a. The EUT was placed 0.4 meter from the conducting wall of the shielding room was kept at least 80 centimeters from any other grounded conducting surface.
- b. Connect EUT to the power mains through a line impedance stabilization network (LISN).
- c. All the support units are connecting to the other LISN.
- d. The LISN provides 50 ohm coupling impedance for the measuring instrument.
- e. The FCC states that a 50 ohm, 50 micro-Henry LISN should be used.
- f. Both sides of AC line were checked for maximum conducted interference.
- g. The frequency range from 150 kHz to 30 MHz was searched.
- h. Set the test-receiver system to Peak Detect Function and Specified Bandwidth with Maximum Hold Mode.



5.3 Typical Test Setup

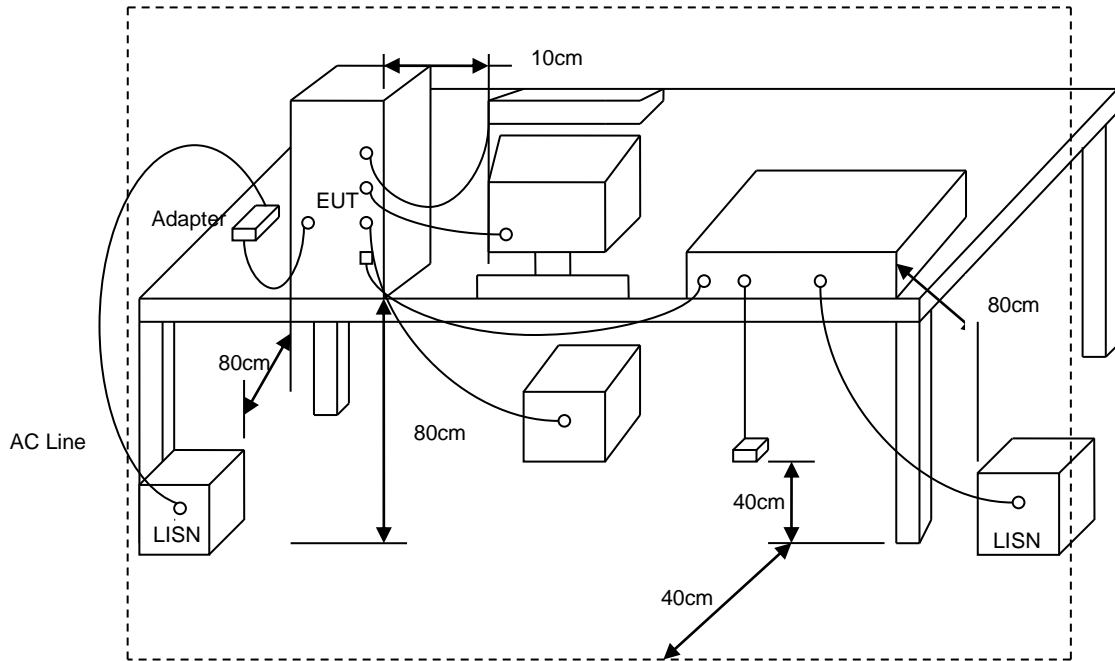



5.4 Test Result and Data

Power	: AC 120V / 60Hz	Pol/Phase	: LINE
Test Mode	: Mode 3		

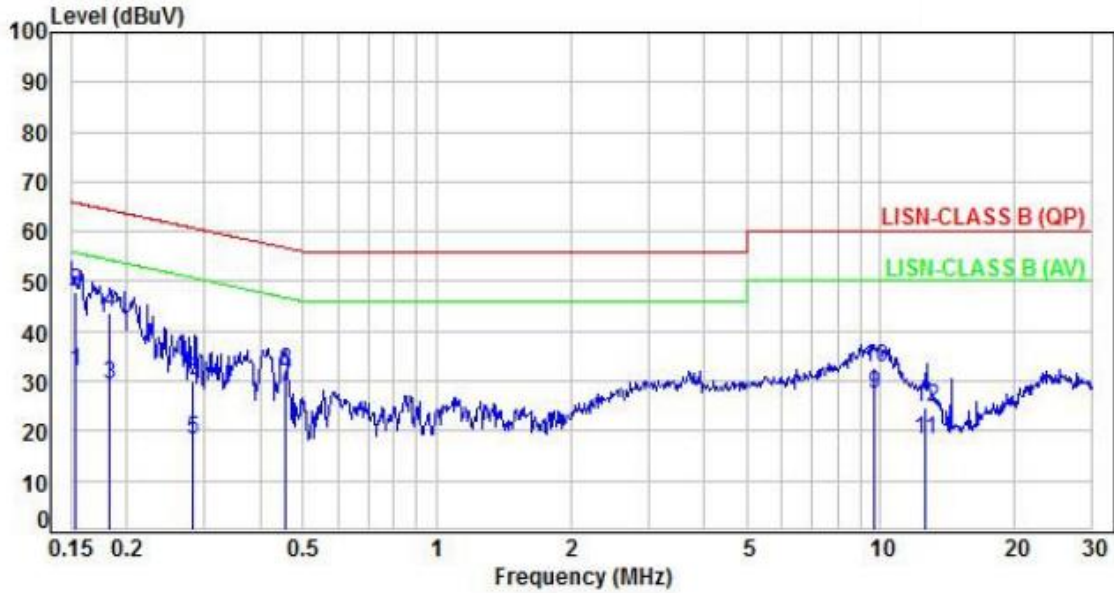

No.	Frequency (MHz)	Factor (dB)	Reading (dBuV)	Level (dBuV)	Limit (dBuV)	Margin (dB)	Detector	P/F
1	0.15	9.96	22.07	32.03	55.80	-23.77	Average	P
2	0.15	9.96	38.07	48.03	65.80	-17.77	QP	P
3	0.18	9.96	19.30	29.26	54.35	-25.09	Average	P
4	0.18	9.96	33.88	43.84	64.35	-20.51	QP	P
5	0.28	9.96	8.14	18.10	50.73	-32.63	Average	P
6	0.28	9.96	20.22	30.18	60.73	-30.55	QP	P
7	0.46	9.97	19.03	29.00	46.73	-17.73	Average	P
8	0.46	9.97	21.86	31.83	56.73	-24.90	QP	P
9	9.64	10.56	16.75	27.31	50.00	-22.69	Average	P
10	9.64	10.56	22.32	32.88	60.00	-27.12	QP	P
11	12.59	10.81	7.33	18.14	50.00	-31.86	Average	P
12	12.59	10.81	13.93	24.74	60.00	-35.26	QP	P

Note: Level=Reading+Factor
 Margin=Level-Limit
 Factor=(LISN or ISN or Current Probe)Factor + Cable Loss



Power	: AC 120V / 60Hz	Pol/Phase	: NEUTRAL
Test Mode	: Mode 3		

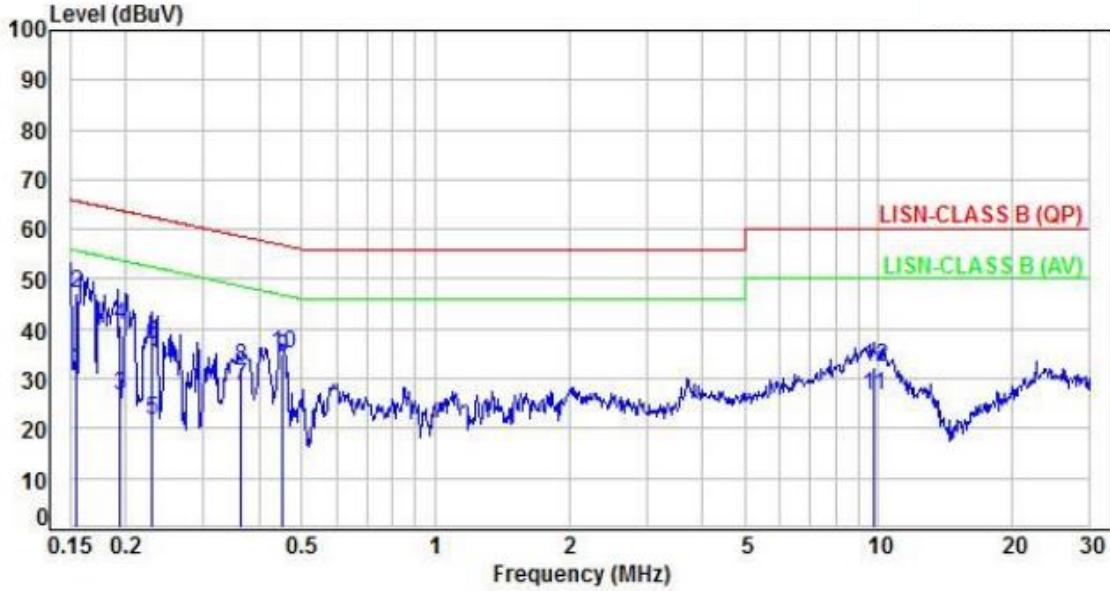

No.	Frequency (MHz)	Factor (dB)	Reading (dBuV)	Level (dBuV)	Limit (dBuV)	Margin (dB)	Detector	P/F
1	0.16	9.97	22.03	32.00	55.71	-23.71	Average	P
2	0.16	9.97	37.16	47.13	65.71	-18.58	QP	P
3	0.19	9.97	16.76	26.73	53.83	-27.10	Average	P
4	0.19	9.97	30.82	40.79	63.83	-23.04	QP	P
5	0.23	9.97	11.75	21.72	52.49	-30.77	Average	P
6	0.23	9.97	26.79	36.76	62.49	-25.73	QP	P
7	0.36	9.98	18.37	28.35	48.65	-20.30	Average	P
8	0.36	9.98	22.44	32.42	58.65	-26.23	QP	P
9	0.45	9.98	24.08	34.06	46.84	-12.78	Average	P
10	0.45	9.98	24.87	34.85	56.84	-21.99	QP	P
11	9.78	10.47	16.12	26.59	50.00	-23.41	Average	P
12	9.78	10.47	21.68	32.15	60.00	-27.85	QP	P

Note: Level=Reading+Factor
 Margin=Level-Limit
 Factor=(LISN or ISN or Current Probe)Factor + Cable Loss



6. Test of Radiated Spurious Emission

6.1 Test Limit

In any 100kHz bandwidth outside the frequency band in which the spread spectrum or digitally modulated intentional radiator is operating, the radio frequency power that is produced by the intentional radiator shall be at least 20dB below that in the 100kHz bandwidth within the band that contains the highest level of the desired power, based on either an RF conducted or a radiated measurement. If the transmitter measurement is based on the maximum conducted output power, the attenuation required under this paragraph shall be 30dB instead of 20dB. In addition, radiated emissions which fall in section 15.205(a) the restricted bands must also comply with the radiated emission limit specified in section 15.209(a).

Frequency (MHz)	Field Strength (microvolt/meter)	Measurement Distance (meters)
0.009 ~ 0.490	2400/F(kHz)	300
0.490 ~ 1.705	24000/F(kHz)	30
1.705 ~ 30.0	30	30
30 ~ 88	100	3
88 ~ 216	150	3
216 ~ 960	200	3
Above 960	500	3



6.2 Test Procedures

- a. The EUT was placed on a rotatable table top 0.8 meter above ground.
- b. The EUT was set 3 meters from the interference receiving antenna which was mounted on the top of a variable height antenna tower.
- c. The table was rotated 360 degrees to determine the position of the highest radiation.
- d. The antenna is a broadband antenna and its height is varied between one meter and four meters above ground to find the maximum value of the field strength both horizontal polarization and vertical polarization of the antenna are set to make the measurement.
- e. For each suspected emission the EUT was arranged to its worst case and then tune the antenna tower (from 1 M to 4 M) and turn table (from 0 degree to 360 degrees) to find the maximum reading.
- f. Set the test-receiver system to Peak or CISPR quasi-peak Detect Function and specified bandwidth with Maximum Hold Mode.
- g. If the emission level of the EUT in peak mode was 3 dB lower than the limit specified, then testing will be stopped and peak values of EUT will be reported, otherwise, the emissions which do not have 3 dB margin will be repeated one by one using the quasi-peak method and reported.
- h. For testing above 1GHz, the emission level of the EUT in peak mode was 20dB lower than average limit (that means the emission level in peak mode also complies with the limit in average mode), then testing will be stopped and peak values of EUT will be reported, otherwise, the emissions will be measured in average mode again and reported.
- i. "Cone of radiation" has been considered to be 3dB bandwidth of the measurement antenna.

Note:

- 1.The supporting fixture shall permit orientation of the EUT in each of three orthogonal axis positions such that emissions from the EUT are maximized.
(Y-AXIS is the worst.)
- 2.Due to the test software function limit the operation band setting(200dBuV/m).
There's no corresponding limitation in the actual test item.



6.3 Typical Test Setup

Below 30MHz test setup

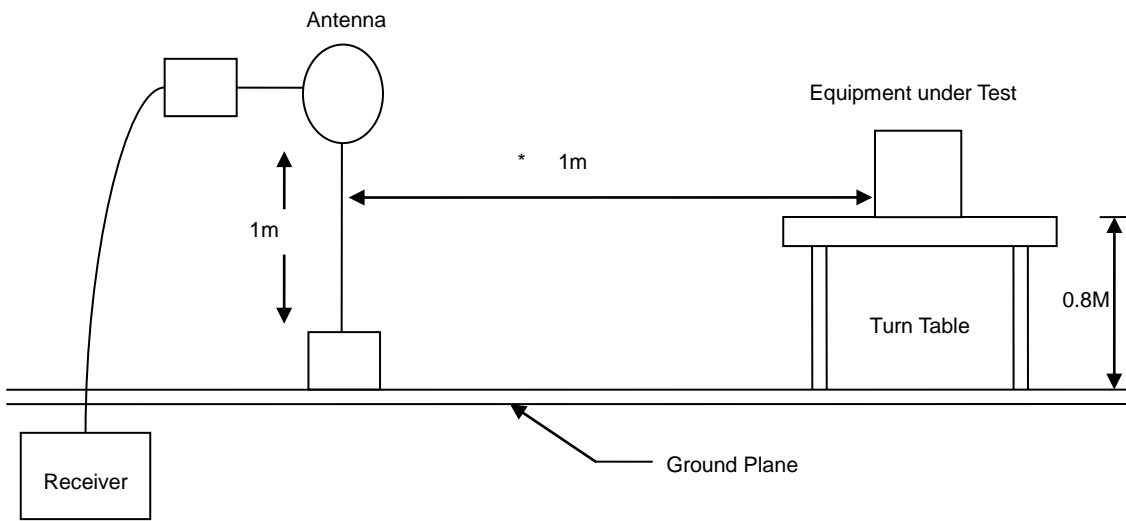

30MHz- 1GHz Test Setup

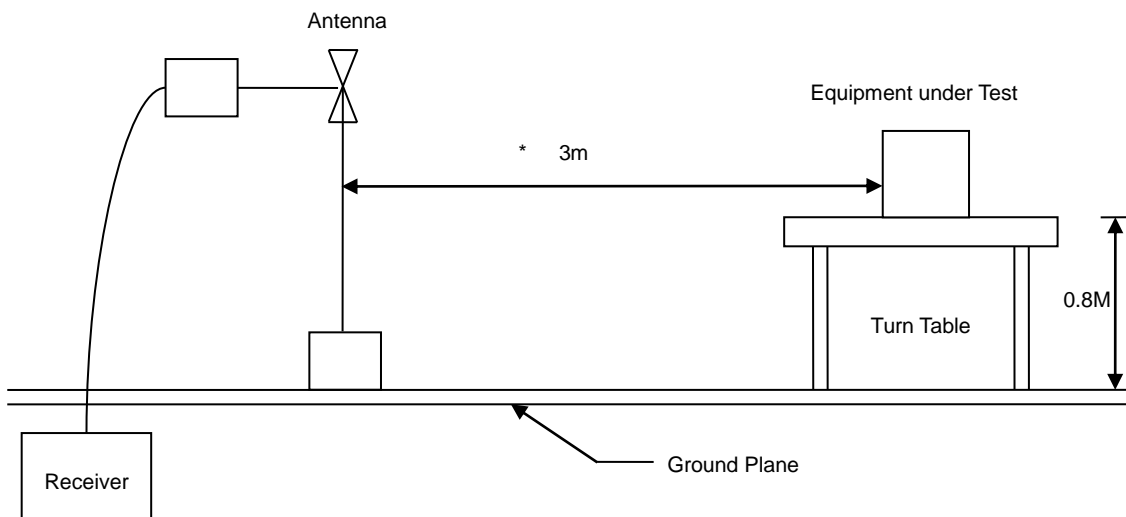

Above 1GHz Test Setup

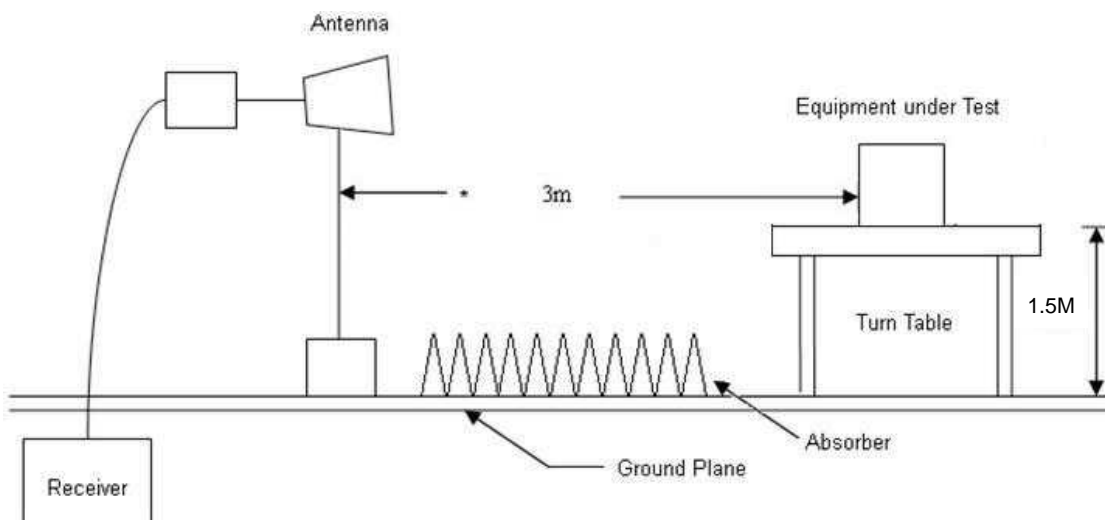



6.4 Test Result and Data (9KHz ~ 30MHz)

The 9kHz - 30MHz spurious emission is under limit 20dB more.

6.5 Test Result and Data (30MHz ~ 1GHz)

Power	: AC 120V / 60Hz	Pol/Phase	: VERTICAL
Test Mode	: Mode 3		:

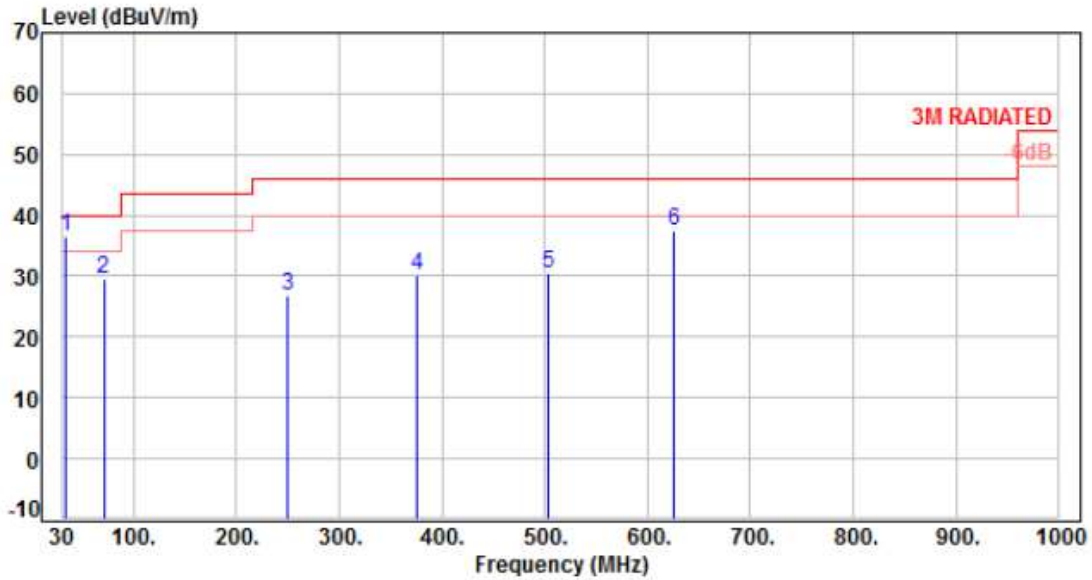

No.	Frequency (MHz)	Factor (dB)	Reading (dBuV)	Level (dBuV/m)	Limit (dBuV/m)	Margin (dB)	Detector	Height (cm)	Azimuth (deg)	P/F
1	33.94	-11.80	48.27	36.47	40.00	-3.53	QP	100	351	P
2	70.86	-13.13	42.78	29.65	40.00	-10.35	QP	100	350	P
3	249.46	-11.57	38.39	26.82	46.00	-19.18	Peak	400	0	P
4	375.54	-7.72	37.78	30.06	46.00	-15.94	Peak	400	0	P
5	503.50	-4.69	35.21	30.52	46.00	-15.48	Peak	400	0	P
6	625.64	-2.03	39.44	37.41	46.00	-8.59	Peak	400	0	P

Note: Level=Reading+Factor
 Margin=Level-Limit
 Factor=Antenna Factor + cable loss - Amplifier Factor



Power	: AC 120V / 60Hz	Pol/Phase	: HORIZONTAL
Test Mode	: Mode 3		:

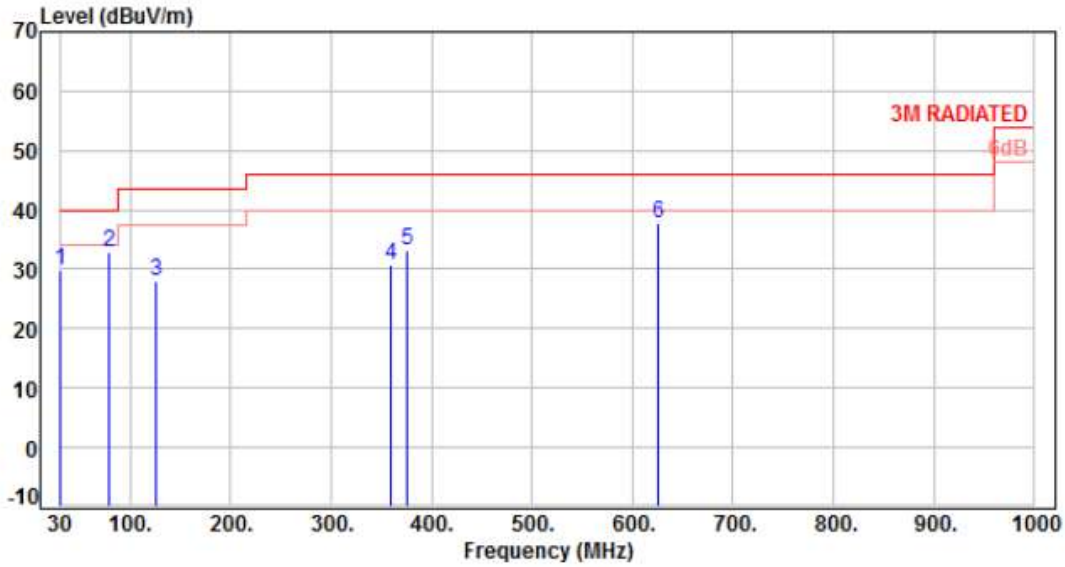

No.	Frequency (MHz)	Factor (dB)	Reading (dBuV)	Level (dBuV/m)	Limit (dBuV/m)	Margin (dB)	Detector	Height (cm)	Azimuth (deg)	P/F
1	30.00	-11.62	41.55	29.93	40.00	-10.07	Peak	400	360	P
2	78.68	-14.44	47.43	32.99	40.00	-7.01	Peak	400	360	P
3	125.24	-12.46	40.62	28.16	43.50	-15.34	Peak	400	360	P
4	359.62	-8.20	38.90	30.70	46.00	-15.30	Peak	400	360	P
5	375.45	-7.72	40.97	33.25	46.00	-12.75	Peak	400	360	P
6	625.72	-2.03	39.80	37.77	46.00	-8.23	Peak	400	360	P

Note: Level=Reading+Factor
 Margin=Level-Limit
 Factor=Antenna Factor + cable loss - Amplifier Factor



6.6 Test Result and Data (1GHz ~ 25GHz)

Power	: AC 120V / 60Hz	Pol/Phase	: VERTICAL
Test Mode	: Mode 1, CH01		:

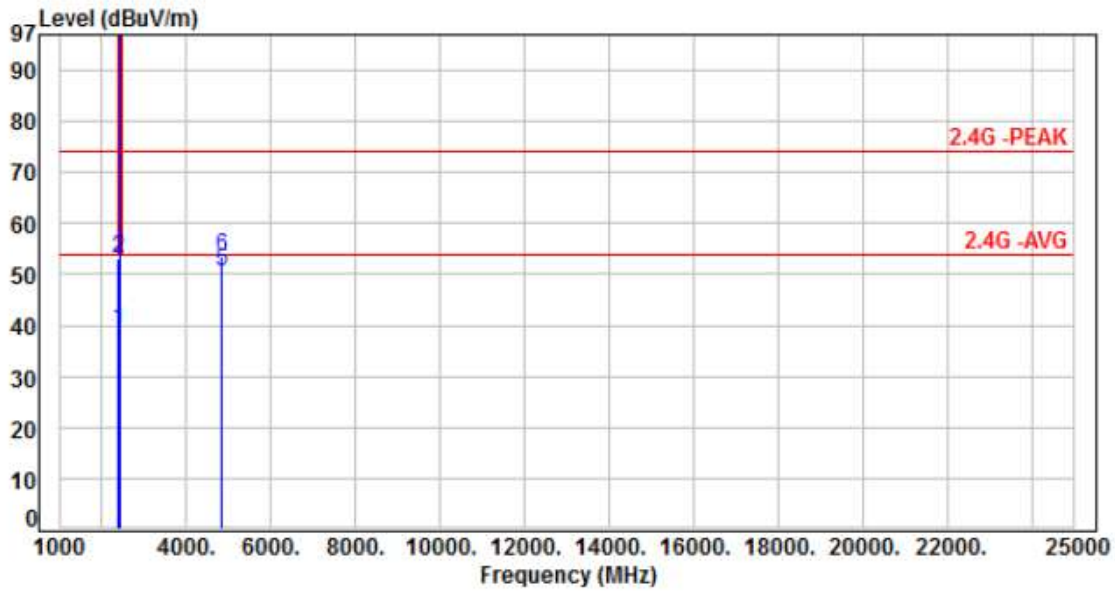

No.	Frequency (MHz)	Factor (dB)	Reading (dBuV)	Level (dBuV/m)	Limit (dBuV/m)	Margin (dB)	Detector	Height (cm)	Azimuth (deg)	P/F
1	2390.00	-3.62	42.54	38.92	54.00	-15.08	Average	400	17	P
2	2390.00	-3.62	56.56	52.94	74.00	-21.06	Peak	400	17	P
3	2412.00	-3.60	101.98	98.38	200.00	-101.62	Average	400	17	P
4	2412.00	-3.60	105.30	101.70	200.00	-98.30	Peak	400	17	P
5	4824.00	3.73	46.73	50.46	54.00	-3.54	Average	349	113	P
6	4824.00	3.73	49.72	53.45	74.00	-20.55	Peak	349	113	P

Note: Level=Reading+Factor
Margin=Level-Limit
Factor=Antenna Factor + cable loss - Amplifier Factor



Power	: AC 120V / 60Hz	Pol/Phase	: HORIZONTAL
Test Mode	: Mode 1, CH01		:

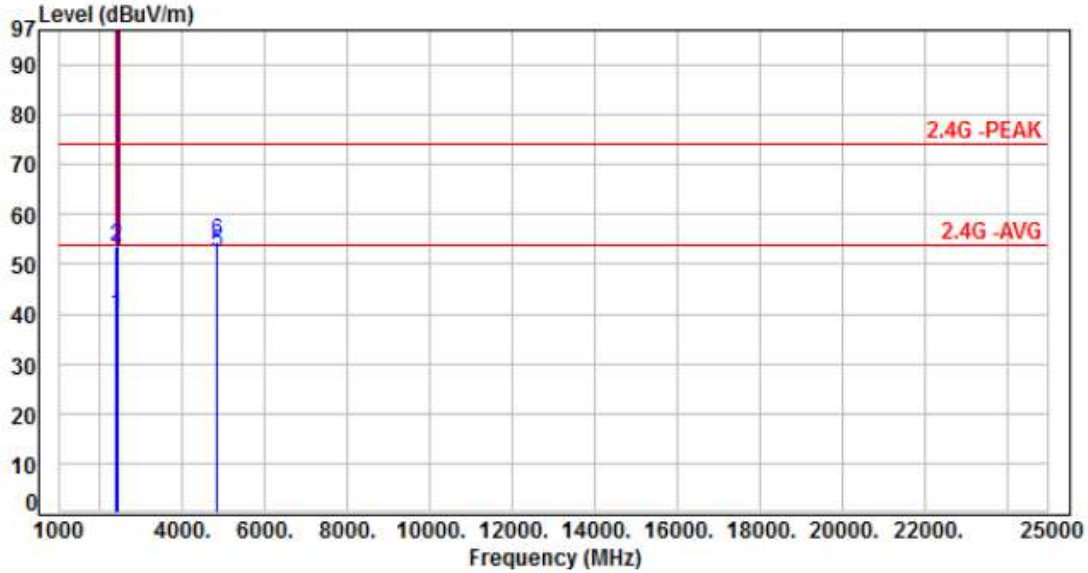

No.	Frequency (MHz)	Factor (dB)	Reading (dBuV)	Level (dBuV/m)	Limit (dBuV/m)	Margin (dB)	Detector	Height (cm)	Azimuth (deg)	P/F
1	2390.00	-3.62	43.58	39.96	54.00	-14.04	Average	100	239	P
2	2390.00	-3.62	57.01	53.39	74.00	-20.61	Peak	100	239	P
3	2412.00	-3.60	103.34	99.74	200.00	-100.26	Average	100	239	P
4	2412.00	-3.60	106.44	102.84	200.00	-97.16	Peak	100	239	P
5	4824.00	3.73	48.79	52.52	54.00	-1.48	Average	364	354	P
6	4824.00	3.73	50.97	54.70	74.00	-19.30	Peak	364	354	P

Note: Level=Reading+Factor
 Margin=Level-Limit
 Factor=Antenna Factor + cable loss - Amplifier Factor



Power	: AC 120V / 60Hz	Pol/Phase	: VERTICAL
Test Mode	: Mode 1, CH06		:

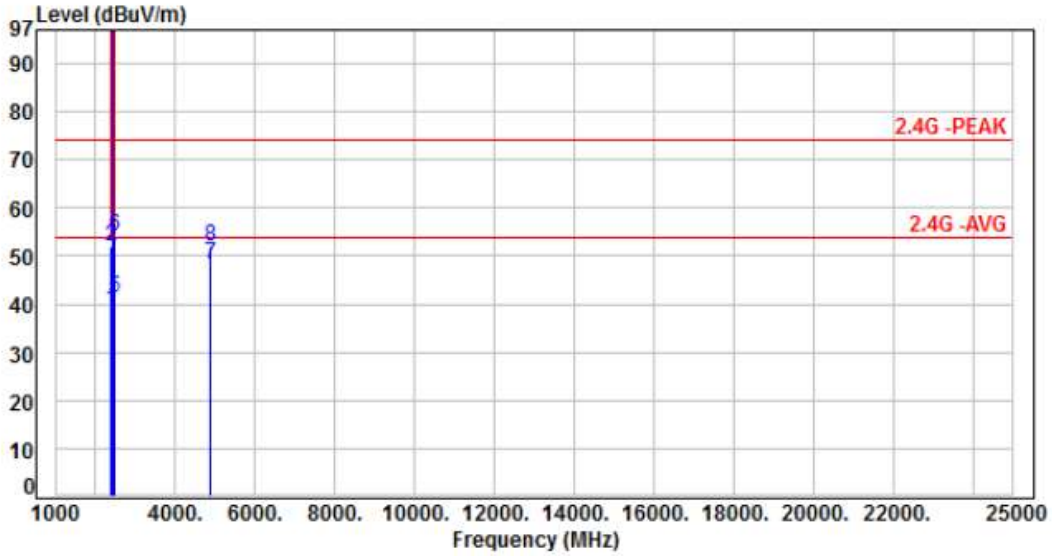

No.	Frequency (MHz)	Factor (dB)	Reading (dBuV)	Level (dBuV/m)	Limit (dBuV/m)	Margin (dB)	Detector	Height (cm)	Azimuth (deg)	P/F
1	2390.00	-3.62	42.41	38.79	54.00	-15.21	Average	355	359	P
2	2390.00	-3.62	55.50	51.88	74.00	-22.12	Peak	355	359	P
3	2437.00	-3.57	105.40	101.83	200.00	-98.17	Average	355	359	P
4	2437.00	-3.57	109.84	106.27	200.00	-93.73	Peak	355	359	P
5	2483.50	-3.40	44.66	41.26	54.00	-12.74	Average	355	359	P
6	2483.50	-3.40	57.63	54.23	74.00	-19.77	Peak	355	359	P
7	4874.00	3.90	44.55	48.45	54.00	-5.55	Average	189	44	P
8	4874.00	3.90	48.18	52.08	74.00	-21.92	Peak	189	44	P

Note: Level=Reading+Factor
 Margin=Level-Limit
 Factor=Antenna Factor + cable loss - Amplifier Factor



Power	: AC 120V / 60Hz	Pol/Phase	: HORIZONTAL
Test Mode	: Mode 1, CH06		:

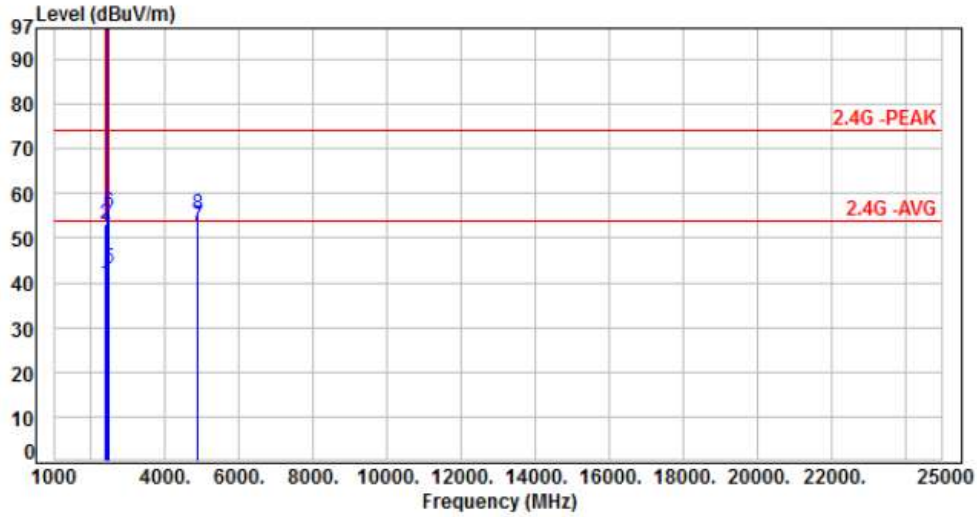

No.	Frequency (MHz)	Factor (dB)	Reading (dBuV)	Level (dBuV/m)	Limit (dBuV/m)	Margin (dB)	Detector	Height (cm)	Azimuth (deg)	P/F
1	2390.00	-3.62	43.57	39.95	54.00	-14.05	Average	100	244	P
2	2390.00	-3.62	56.61	52.99	74.00	-21.01	Peak	100	244	P
3	2437.00	-3.57	106.56	102.99	200.00	-97.01	Average	100	244	P
4	2437.00	-3.57	110.00	106.43	200.00	-93.57	Peak	100	244	P
5	2483.50	-3.40	46.40	43.00	54.00	-11.00	Average	100	244	P
6	2483.50	-3.40	59.16	55.76	74.00	-18.24	Peak	100	244	P
7	4874.00	3.90	48.89	52.79	54.00	-1.21	Average	100	360	P
8	4874.00	3.90	51.41	55.31	74.00	-18.69	Peak	100	360	P

Note: Level=Reading+Factor
 Margin=Level-Limit
 Factor=Antenna Factor + cable loss - Amplifier Factor



Power	: AC 120V / 60Hz	Pol/Phase	: VERTICAL
Test Mode	: Mode 1, CH11		:

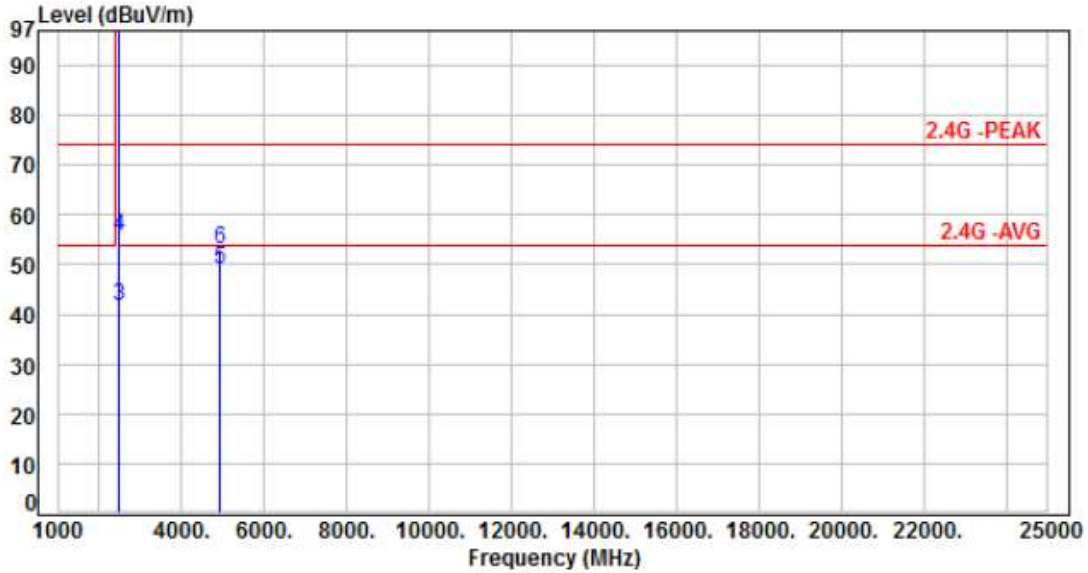

No.	Frequency (MHz)	Factor (dB)	Reading (dBuV)	Level (dBuV/m)	Limit (dBuV/m)	Margin (dB)	Detector	Height (cm)	Azimuth (deg)	P/F
1	2462.00	-3.50	102.89	99.39	200.00	-100.61	Average	386	24	P
2	2462.00	-3.50	105.82	102.32	200.00	-97.68	Peak	386	24	P
3	2483.50	-3.40	45.02	41.62	54.00	-12.38	Average	386	24	P
4	2483.50	-3.40	59.12	55.72	74.00	-18.28	Peak	386	24	P
5	4924.00	4.10	45.08	49.18	54.00	-4.82	Average	361	56	P
6	4924.00	4.10	48.87	52.97	74.00	-21.03	Peak	361	56	P

Note: Level=Reading+Factor
 Margin=Level-Limit
 Factor=Antenna Factor + cable loss - Amplifier Factor



Power	: AC 120V / 60Hz	Pol/Phase	: HORIZONTAL
Test Mode	: Mode 1, CH11		:

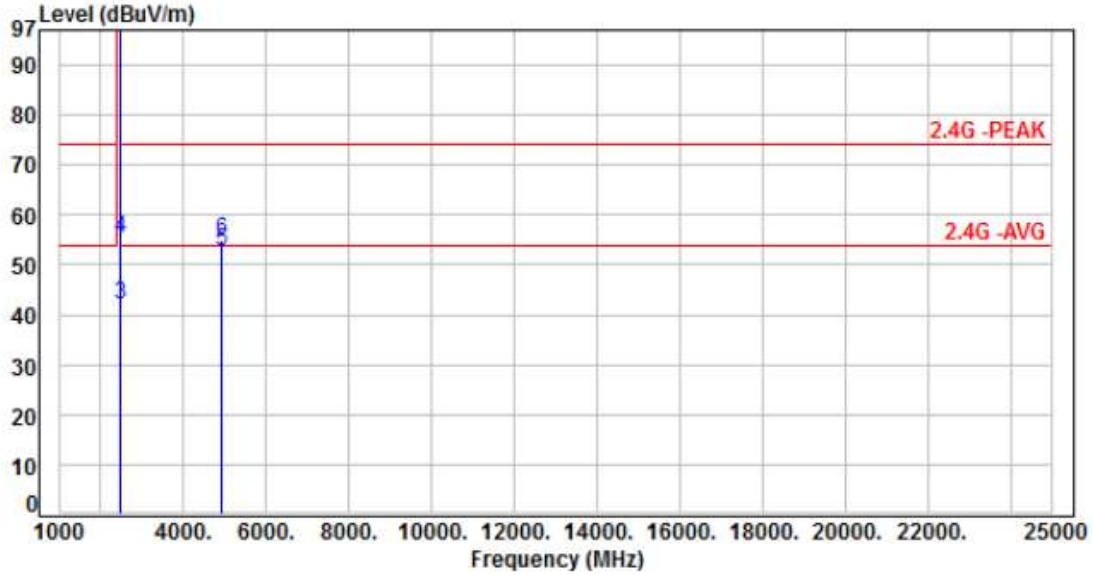

No.	Frequency (MHz)	Factor (dB)	Reading (dBuV)	Level (dBuV/m)	Limit (dBuV/m)	Margin (dB)	Detector	Height (cm)	Azimuth (deg)	P/F
1	2462.00	-3.50	103.53	100.03	200.00	-99.97	Average	104	42	P
2	2462.00	-3.50	106.47	102.97	200.00	-97.03	Peak	104	42	P
3	2483.50	-3.40	45.36	41.96	54.00	-12.04	Average	104	42	P
4	2483.50	-3.40	58.72	55.32	74.00	-18.68	Peak	104	42	P
5	4924.00	4.10	48.48	52.58	54.00	-1.42	Average	367	360	P
6	4924.00	4.10	50.88	54.98	74.00	-19.02	Peak	367	360	P

Note: Level=Reading+Factor
 Margin=Level-Limit
 Factor=Antenna Factor + cable loss - Amplifier Factor



Power	: AC 120V / 60Hz	Pol/Phase	: VERTICAL
Test Mode	: Mode 2, CH01		:

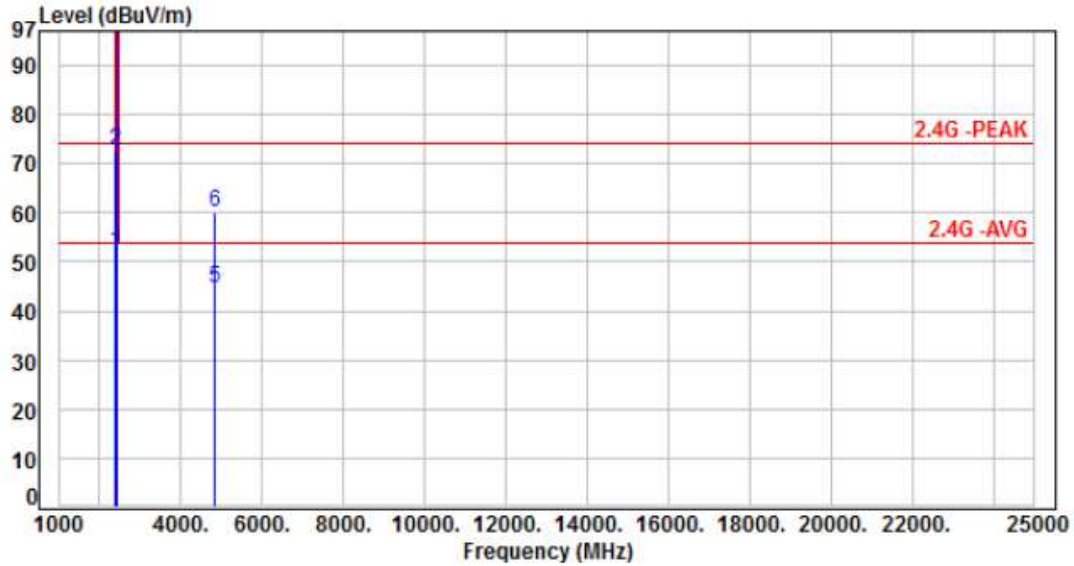

No.	Frequency (MHz)	Factor (dB)	Reading (dBuV)	Level (dBuV/m)	Limit (dBuV/m)	Margin (dB)	Detector	Height (cm)	Azimuth (deg)	P/F
1	2390.00	-3.62	55.58	51.96	54.00	-2.04	Average	400	357	P
2	2390.00	-3.62	76.46	72.84	74.00	-1.16	Peak	400	357	P
3	2412.00	-3.60	105.88	102.28	200.00	-97.72	Average	400	357	P
4	2412.00	-3.60	115.60	112.00	200.00	-88.00	Peak	400	357	P
5	4824.00	3.73	40.81	44.54	54.00	-9.46	Average	390	112	P
6	4824.00	3.73	56.40	60.13	74.00	-13.87	Peak	390	112	P

Note: Level=Reading+Factor
Margin=Level-Limit
Factor=Antenna Factor + cable loss - Amplifier Factor



Power	: AC 120V / 60Hz	Pol/Phase	: HORIZONTAL
Test Mode	: Mode 2, CH01		:

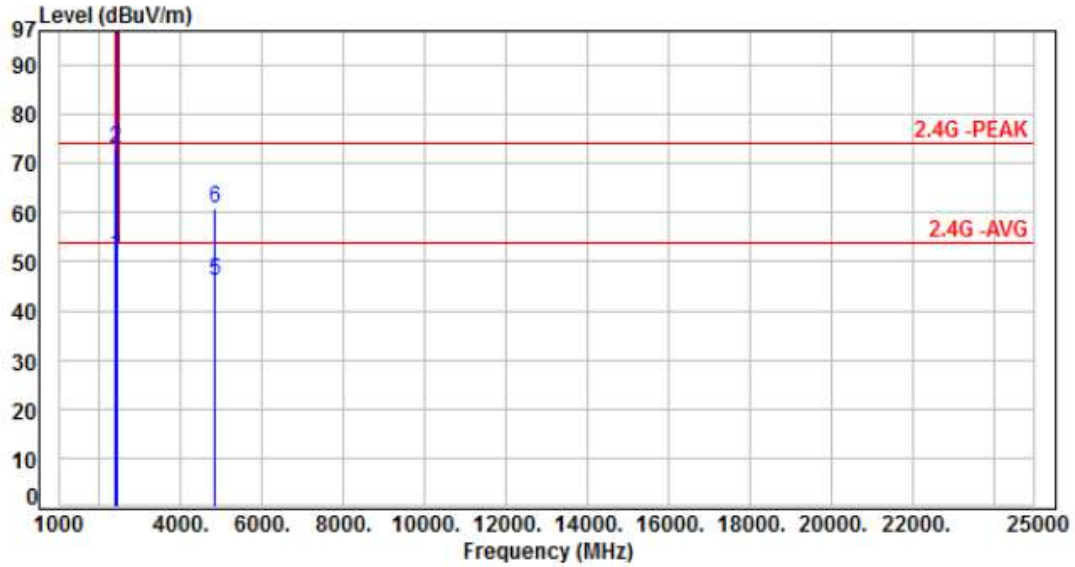

No.	Frequency (MHz)	Factor (dB)	Reading (dBUV)	Level (dBUV/m)	Limit (dBUV/m)	Margin (dB)	Detector	Height (cm)	Azimuth (deg)	P/F
1	2390.00	-3.62	54.94	51.32	54.00	-2.68	Average	284	48	P
2	2390.00	-3.62	76.56	72.94	74.00	-1.06	Peak	284	48	P
3	2412.00	-3.60	106.12	102.52	200.00	-97.48	Average	284	48	P
4	2412.00	-3.60	116.66	113.06	200.00	-86.94	Peak	284	48	P
5	4824.00	3.73	42.35	46.08	54.00	-7.92	Average	361	347	P
6	4824.00	3.73	57.00	60.73	74.00	-13.27	Peak	361	347	P

Note: Level=Reading+Factor
 Margin=Level-Limit
 Factor=Antenna Factor + cable loss - Amplifier Factor



Power	: AC 120V / 60Hz	Pol/Phase	: VERTICAL
Test Mode	: Mode 2, CH06		:

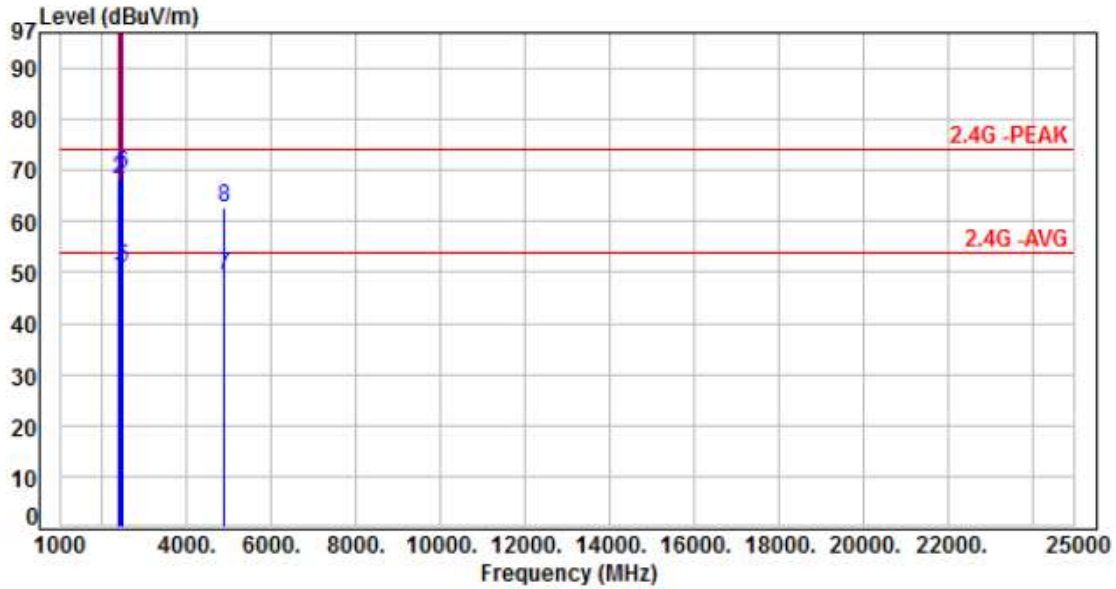

No.	Frequency (MHz)	Factor (dB)	Reading (dBuV)	Level (dBuV/m)	Limit (dBuV/m)	Margin (dB)	Detector	Height (cm)	Azimuth (deg)	P/F
1	2390.00	-3.62	52.78	49.16	54.00	-4.84	Average	383	340	P
2	2390.00	-3.62	72.03	68.41	74.00	-5.59	Peak	383	340	P
3	2437.00	-3.57	109.86	106.29	200.00	-93.71	Average	383	340	P
4	2437.00	-3.57	119.50	115.93	200.00	-84.07	Peak	383	340	P
5	2483.50	-3.40	54.32	50.92	54.00	-3.08	Average	383	340	P
6	2483.50	-3.40	72.91	69.51	74.00	-4.49	Peak	383	340	P
7	4874.00	3.90	45.58	49.48	54.00	-4.52	Average	310	112	P
8	4874.00	3.90	58.80	62.70	74.00	-11.30	Peak	310	112	P

Note: Level=Reading+Factor
 Margin=Level-Limit
 Factor=Antenna Factor + cable loss - Amplifier Factor



Power	: AC 120V / 60Hz	Pol/Phase	: HORIZONTAL
Test Mode	: Mode 2, CH06		:

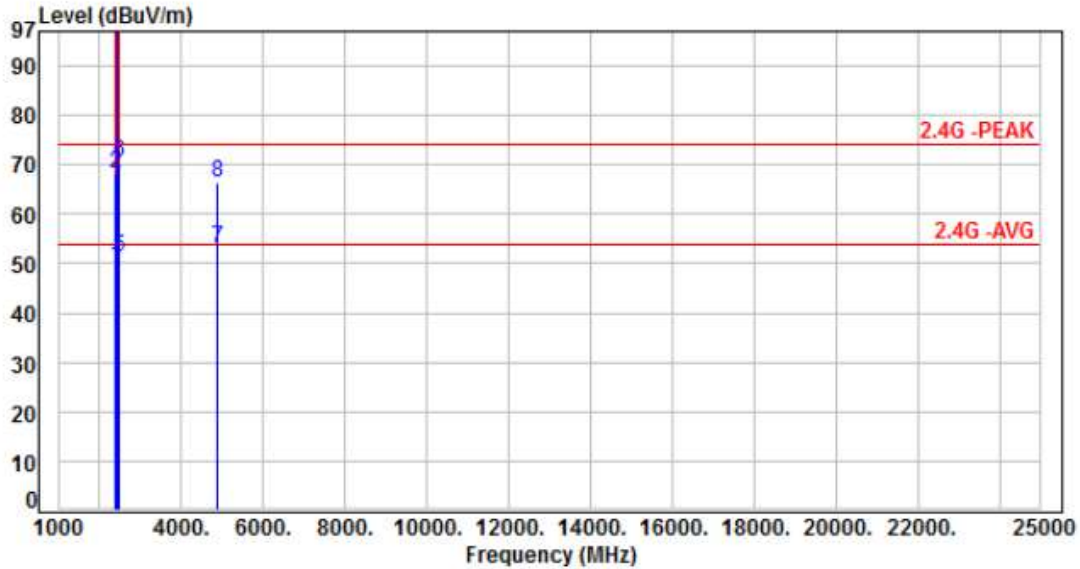

No.	Frequency (MHz)	Factor (dB)	Reading (dBuV)	Level (dBuV/m)	Limit (dBuV/m)	Margin (dB)	Detector	Height (cm)	Azimuth (deg)	P/F
1	2390.00	-3.62	53.15	49.53	54.00	-4.47	Average	271	55	P
2	2390.00	-3.62	71.95	68.33	74.00	-5.67	Peak	271	55	P
3	2437.00	-3.57	110.12	106.55	200.00	-93.45	Average	271	55	P
4	2437.00	-3.57	120.00	116.43	200.00	-83.57	Peak	271	55	P
5	2483.50	-3.40	54.54	51.14	54.00	-2.86	Average	271	55	P
6	2483.50	-3.40	73.91	70.51	74.00	-3.49	Peak	271	55	P
7	4874.00	3.90	49.21	53.11	54.00	-0.89	Average	102	357	P
8	4874.00	3.90	62.56	66.46	74.00	-7.54	Peak	102	357	P

Note: Level=Reading+Factor
 Margin=Level-Limit
 Factor=Antenna Factor + cable loss - Amplifier Factor



Power	: AC 120V / 60Hz	Pol/Phase	: VERTICAL
Test Mode	: Mode 2, CH11		:

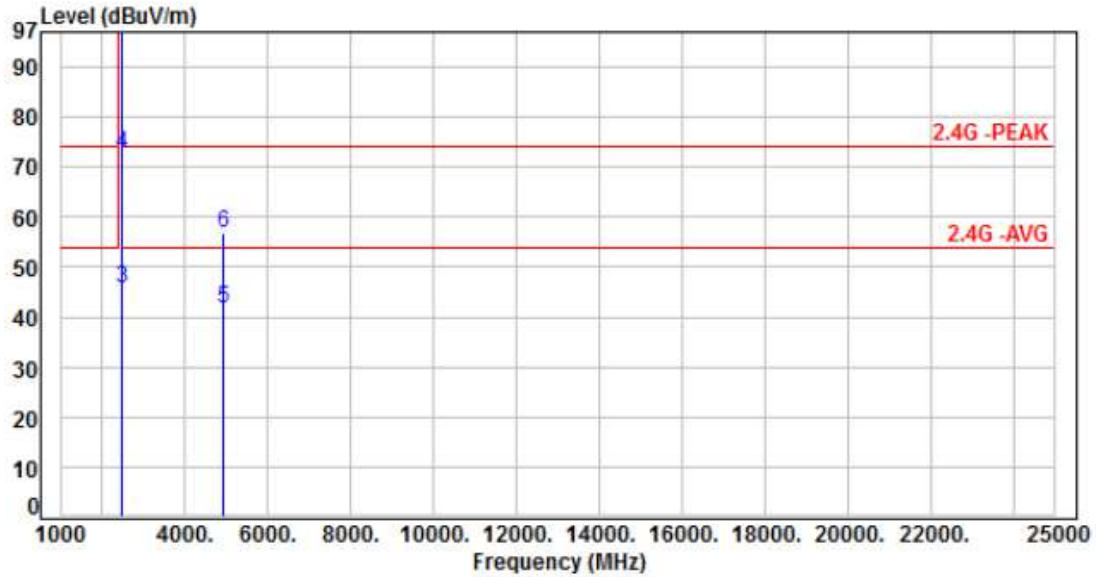

No.	Frequency (MHz)	Factor (dB)	Reading (dBuV)	Level (dBuV/m)	Limit (dBuV/m)	Margin (dB)	Detector	Height (cm)	Azimuth (deg)	P/F
1	2462.00	-3.50	104.05	100.55	200.00	-99.45	Average	380	357	P
2	2462.00	-3.50	114.37	110.87	200.00	-89.13	Peak	380	357	P
3	2483.50	-3.40	48.98	45.58	54.00	-8.42	Average	380	357	P
4	2483.50	-3.40	76.17	72.77	74.00	-1.23	Peak	380	357	P
5	4924.00	4.10	37.66	41.76	54.00	-12.24	Average	399	125	P
6	4924.00	4.10	52.72	56.82	74.00	-17.18	Peak	399	125	P

Note: Level=Reading+Factor
 Margin=Level-Limit
 Factor=Antenna Factor + cable loss - Amplifier Factor



Power	: AC 120V / 60Hz	Pol/Phase	: HORIZONTAL
Test Mode	: Mode 2, CH11		:

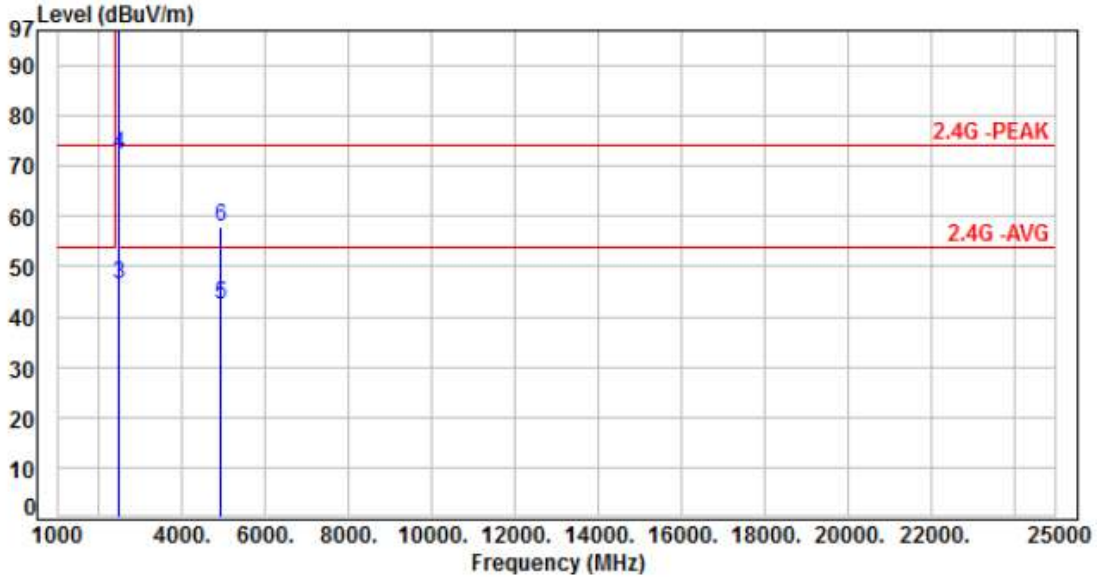

No.	Frequency (MHz)	Factor (dB)	Reading (dBuV)	Level (dBuV/m)	Limit (dBuV/m)	Margin (dB)	Detector	Height (cm)	Azimuth (deg)	P/F
1	2462.00	-3.50	105.14	101.64	200.00	-98.36	Average	256	297	P
2	2462.00	-3.50	115.49	111.99	200.00	-88.01	Peak	256	297	P
3	2483.50	-3.40	49.78	46.38	54.00	-7.62	Average	256	297	P
4	2483.50	-3.40	75.68	72.28	74.00	-1.72	Peak	256	297	P
5	4924.00	4.10	38.39	42.49	54.00	-11.51	Average	390	360	P
6	4924.00	4.10	53.64	57.74	74.00	-16.26	Peak	390	360	P

Note: Level=Reading+Factor
 Margin=Level-Limit
 Factor=Antenna Factor + cable loss - Amplifier Factor



Power	: AC 120V / 60Hz	Pol/Phase	: VERTICAL
Test Mode	: Mode 3, CH01		:

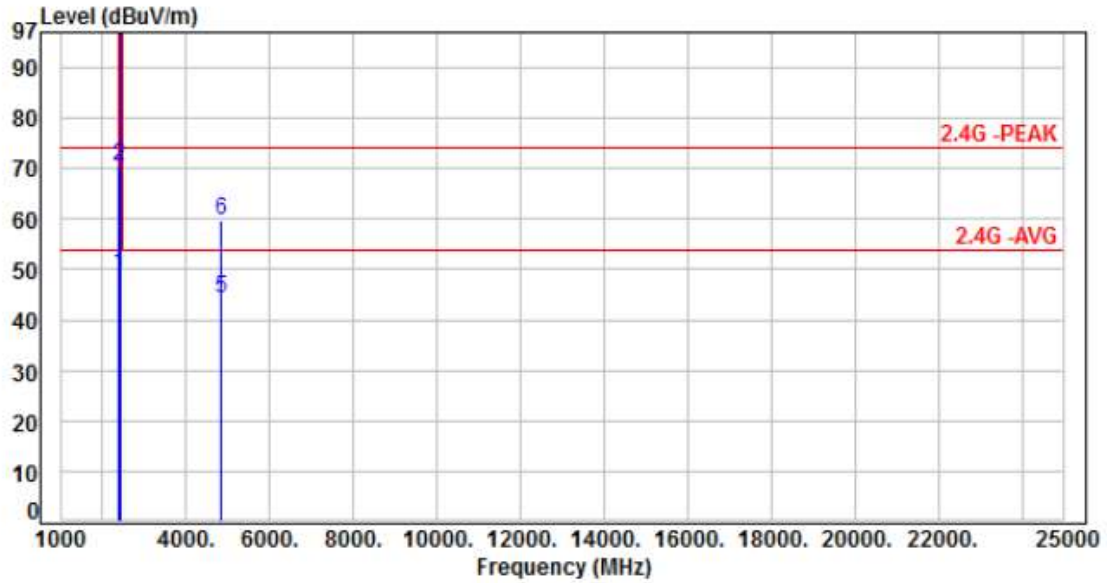

No.	Frequency (MHz)	Factor (dB)	Reading (dBuV)	Level (dBuV/m)	Limit (dBuV/m)	Margin (dB)	Detector	Height (cm)	Azimuth (deg)	P/F
1	2390.00	-3.62	52.55	48.93	54.00	-5.07	Average	400	17	P
2	2390.00	-3.62	74.14	70.52	74.00	-3.48	Peak	400	17	P
3	2412.00	-3.60	104.81	101.21	200.00	-98.79	Average	400	17	P
4	2412.00	-3.60	115.08	111.48	200.00	-88.52	Peak	400	17	P
5	4824.00	3.73	40.35	44.08	54.00	-9.92	Average	392	118	P
6	4824.00	3.73	56.15	59.88	74.00	-14.12	Peak	392	118	P

Note: Level=Reading+Factor
 Margin=Level-Limit
 Factor=Antenna Factor + cable loss - Amplifier Factor



Power	: AC 120V / 60Hz	Pol/Phase	: HORIZONTAL
Test Mode	: Mode 3, CH01		:

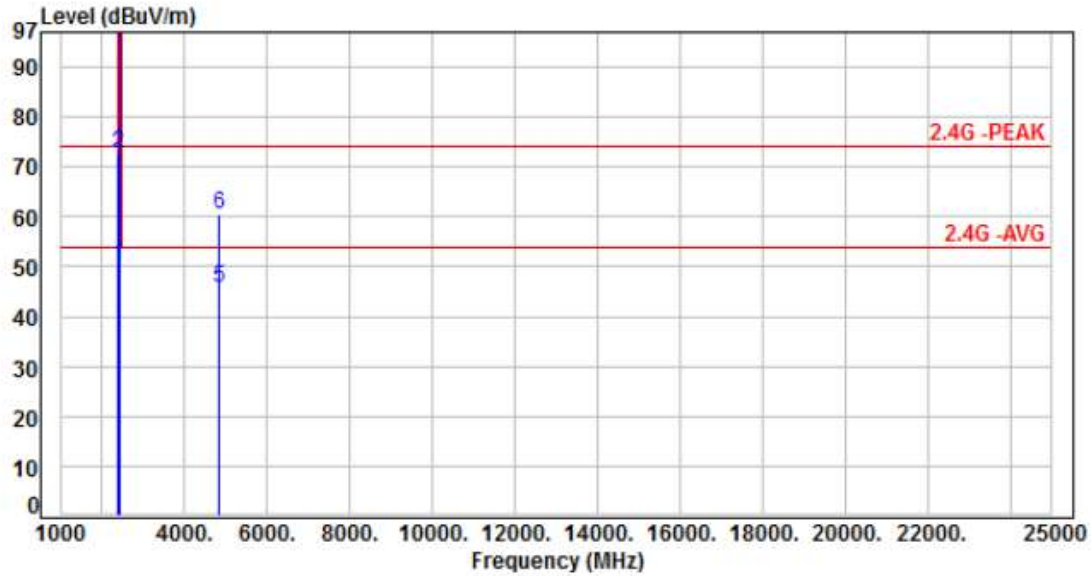

No.	Frequency (MHz)	Factor (dB)	Reading (dBuV)	Level (dBuV/m)	Limit (dBuV/m)	Margin (dB)	Detector	Height (cm)	Azimuth (deg)	P/F
1	2390.00	-3.62	53.68	50.06	54.00	-3.94	Average	236	89	P
2	2390.00	-3.62	76.22	72.60	74.00	-1.40	Peak	236	89	P
3	2412.00	-3.60	106.82	103.22	200.00	-96.78	Average	236	89	P
4	2412.00	-3.60	117.02	113.42	200.00	-86.58	Peak	236	89	P
5	4824.00	3.73	41.89	45.62	54.00	-8.38	Average	368	353	P
6	4824.00	3.73	56.69	60.42	74.00	-13.58	Peak	368	353	P

Note: Level=Reading+Factor
 Margin=Level-Limit
 Factor=Antenna Factor + cable loss - Amplifier Factor



Power	: AC 120V / 60Hz	Pol/Phase	: VERTICAL
Test Mode	: Mode 3, CH06		:

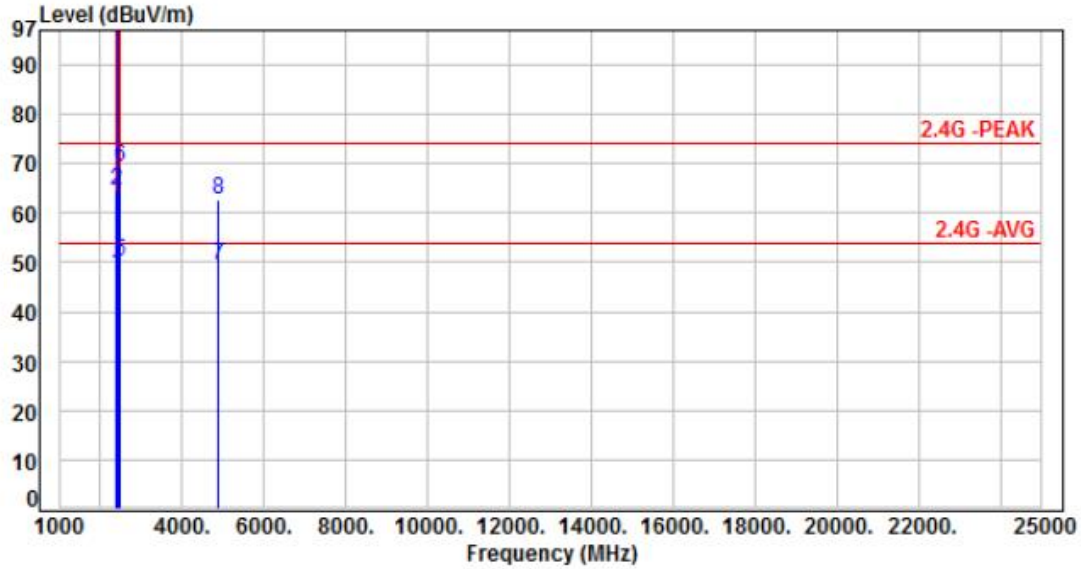

No.	Frequency (MHz)	Factor (dB)	Reading (dBuV)	Level (dBuV/m)	Limit (dBuV/m)	Margin (dB)	Detector	Height (cm)	Azimuth (deg)	P/F
1	2390.00	-3.62	51.35	47.73	54.00	-6.27	Average	383	333	P
2	2390.00	-3.62	68.33	64.71	74.00	-9.29	Peak	383	333	P
3	2437.00	-3.57	108.80	105.23	200.00	-94.77	Average	383	333	P
4	2437.00	-3.57	118.89	115.32	200.00	-84.68	Peak	383	333	P
5	2483.50	-3.40	53.70	50.30	54.00	-3.70	Average	383	333	P
6	2483.50	-3.40	72.83	69.43	74.00	-4.57	Peak	383	333	P
7	4874.00	3.90	45.34	49.24	54.00	-4.76	Average	318	124	P
8	4874.00	3.90	58.62	62.52	74.00	-11.48	Peak	318	124	P

Note: Level=Reading+Factor
 Margin=Level-Limit
 Factor=Antenna Factor + cable loss - Amplifier Factor



Power	: AC 120V / 60Hz	Pol/Phase	: HORIZONTAL
Test Mode	: Mode 3, CH06		:

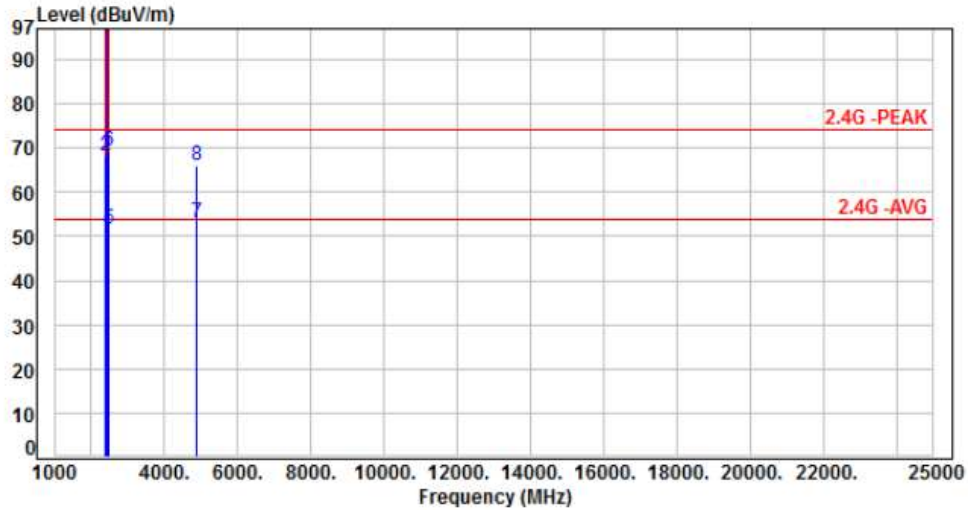

No.	Frequency (MHz)	Factor (dB)	Reading (dBuV)	Level (dBuV/m)	Limit (dBuV/m)	Margin (dB)	Detector	Height (cm)	Azimuth (deg)	P/F
1	2390.00	-3.62	53.72	50.10	54.00	-3.90	Average	196	44	P
2	2390.00	-3.62	71.79	68.17	74.00	-5.83	Peak	196	44	P
3	2437.00	-3.57	109.49	105.92	200.00	-94.08	Average	196	44	P
4	2437.00	-3.57	120.03	116.46	200.00	-83.54	Peak	196	44	P
5	2483.50	-3.40	55.22	51.82	54.00	-2.18	Average	196	44	P
6	2483.50	-3.40	72.72	69.32	74.00	-4.68	Peak	196	44	P
7	4874.00	3.90	49.11	53.01	54.00	-0.99	Average	100	360	P
8	4874.00	3.90	62.16	66.06	74.00	-7.94	Peak	100	360	P

Note: Level=Reading+Factor
 Margin=Level-Limit
 Factor=Antenna Factor + cable loss - Amplifier Factor



Power	: AC 120V / 60Hz	Pol/Phase	: VERTICAL
Test Mode	: Mode 3, CH11		:

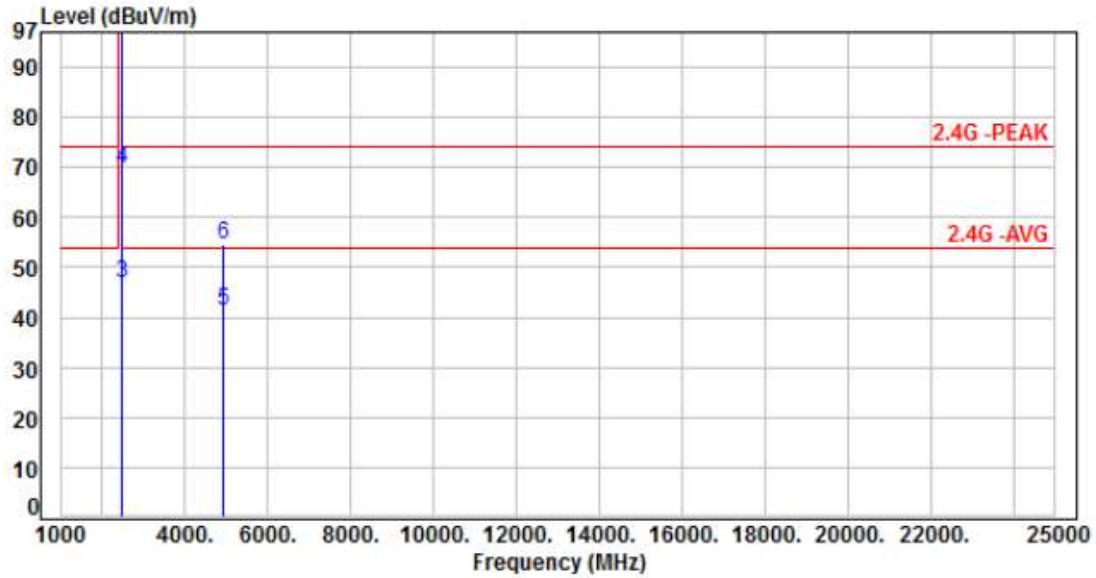

No.	Frequency (MHz)	Factor (dB)	Reading (dBuV)	Level (dBuV/m)	Limit (dBuV/m)	Margin (dB)	Detector	Height (cm)	Azimuth (deg)	P/F
1	2462.00	-3.50	103.90	100.40	200.00	-99.60	Average	385	360	P
2	2462.00	-3.50	114.30	110.80	200.00	-89.20	Peak	385	360	P
3	2483.50	-3.40	50.42	47.02	54.00	-6.98	Average	385	360	P
4	2483.50	-3.40	73.08	69.68	74.00	-4.32	Peak	385	360	P
5	4924.00	4.10	37.06	41.16	54.00	-12.84	Average	344	61	P
6	4924.00	4.10	50.54	54.64	74.00	-19.36	Peak	344	61	P

Note: Level=Reading+Factor
 Margin=Level-Limit
 Factor=Antenna Factor + cable loss - Amplifier Factor



Power	: AC 120V / 60Hz	Pol/Phase	: HORIZONTAL
Test Mode	: Mode 3, CH11		:

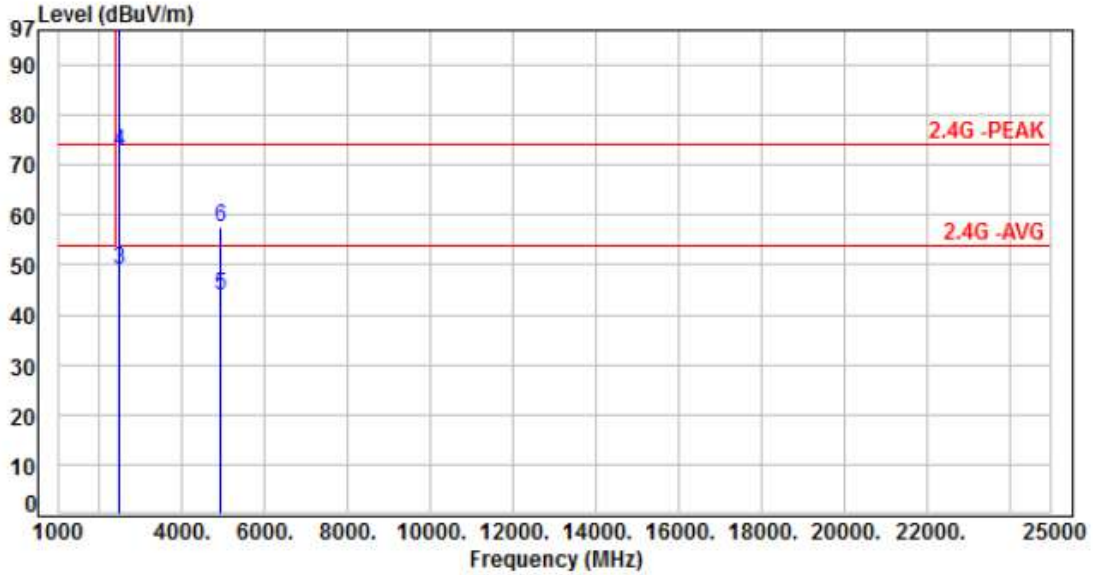

No.	Frequency (MHz)	Factor (dB)	Reading (dBuV)	Level (dBuV/m)	Limit (dBuV/m)	Margin (dB)	Detector	Height (cm)	Azimuth (deg)	P/F
1	2462.00	-3.50	104.79	101.29	200.00	-98.71	Average	335	53	P
2	2462.00	-3.50	115.25	111.75	200.00	-88.25	Peak	335	53	P
3	2483.50	-3.40	52.46	49.06	54.00	-4.94	Average	335	53	P
4	2483.50	-3.40	76.02	72.62	74.00	-1.38	Peak	335	53	P
5	4924.00	4.10	39.68	43.78	54.00	-10.22	Average	392	360	P
6	4924.00	4.10	53.53	57.63	74.00	-16.37	Peak	392	360	P

Note: Level=Reading+Factor
 Margin=Level-Limit
 Factor=Antenna Factor + cable loss - Amplifier Factor



Power	: AC 120V / 60Hz	Pol/Phase	: VERTICAL
Test Mode	: Mode 4, CH03		:

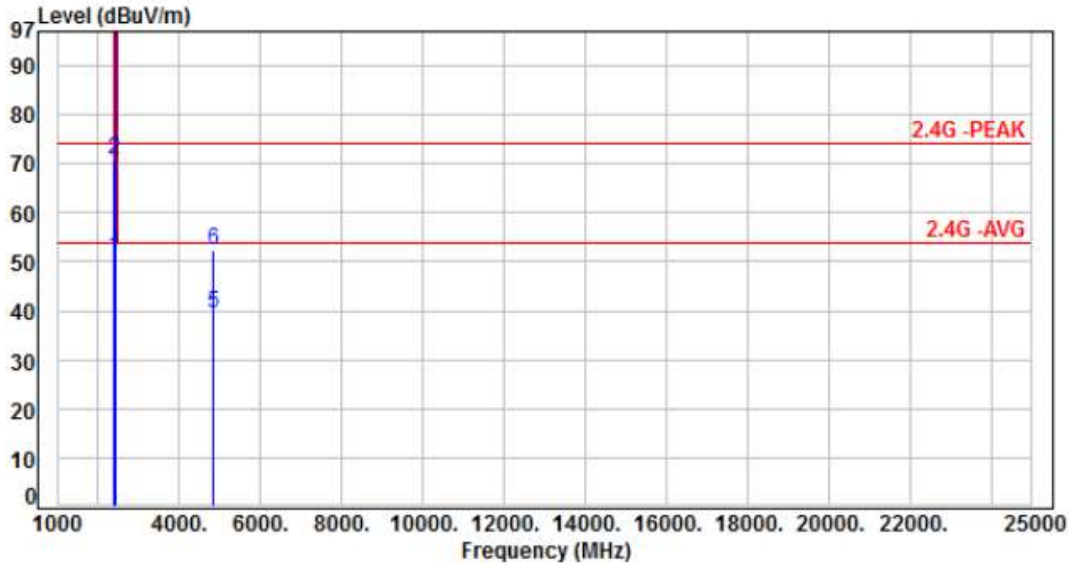

No.	Frequency (MHz)	Factor (dB)	Reading (dBuV)	Level (dBuV/m)	Limit (dBuV/m)	Margin (dB)	Detector	Height (cm)	Azimuth (deg)	P/F
1	2390.00	-3.62	54.69	51.07	54.00	-2.93	Average	397	357	P
2	2390.00	-3.62	74.59	70.97	74.00	-3.03	Peak	397	357	P
3	2422.00	-3.59	102.28	98.69	200.00	-101.31	Average	397	357	P
4	2422.00	-3.59	111.88	108.29	200.00	-91.71	Peak	397	357	P
5	4844.00	3.80	35.77	39.57	54.00	-14.43	Average	375	66	P
6	4844.00	3.80	48.68	52.48	74.00	-21.52	Peak	375	66	P

Note: Level=Reading+Factor
 Margin=Level-Limit
 Factor=Antenna Factor + cable loss - Amplifier Factor



Power	: AC 120V / 60Hz	Pol/Phase	: HORIZONTAL
Test Mode	: Mode 4, CH03		:

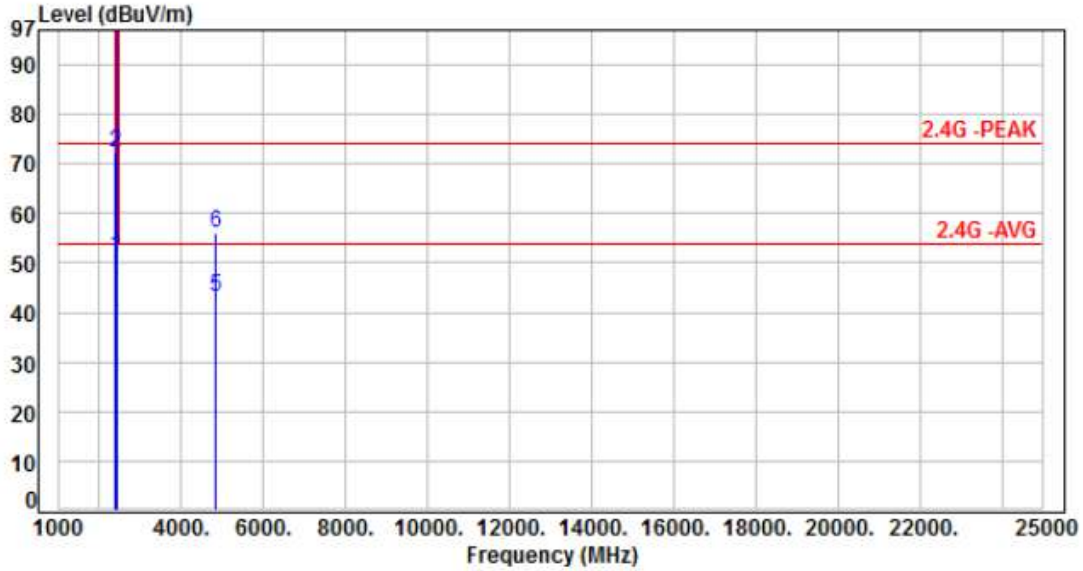

No.	Frequency (MHz)	Factor (dB)	Reading (dBuV)	Level (dBuV/m)	Limit (dBuV/m)	Margin (dB)	Detector	Height (cm)	Azimuth (deg)	P/F
1	2390.00	-3.62	54.99	51.37	54.00	-2.63	Average	383	89	P
2	2390.00	-3.62	75.98	72.36	74.00	-1.64	Peak	383	89	P
3	2422.00	-3.59	103.97	100.38	200.00	-99.62	Average	383	89	P
4	2422.00	-3.59	113.73	110.14	200.00	-89.86	Peak	383	89	P
5	4844.00	3.80	39.28	43.08	54.00	-10.92	Average	361	360	P
6	4844.00	3.80	52.30	56.10	74.00	-17.90	Peak	361	360	P

Note: Level=Reading+Factor
 Margin=Level-Limit
 Factor=Antenna Factor + cable loss - Amplifier Factor



Power	: AC 120V / 60Hz	Pol/Phase	: VERTICAL
Test Mode	: Mode 4, CH06		:

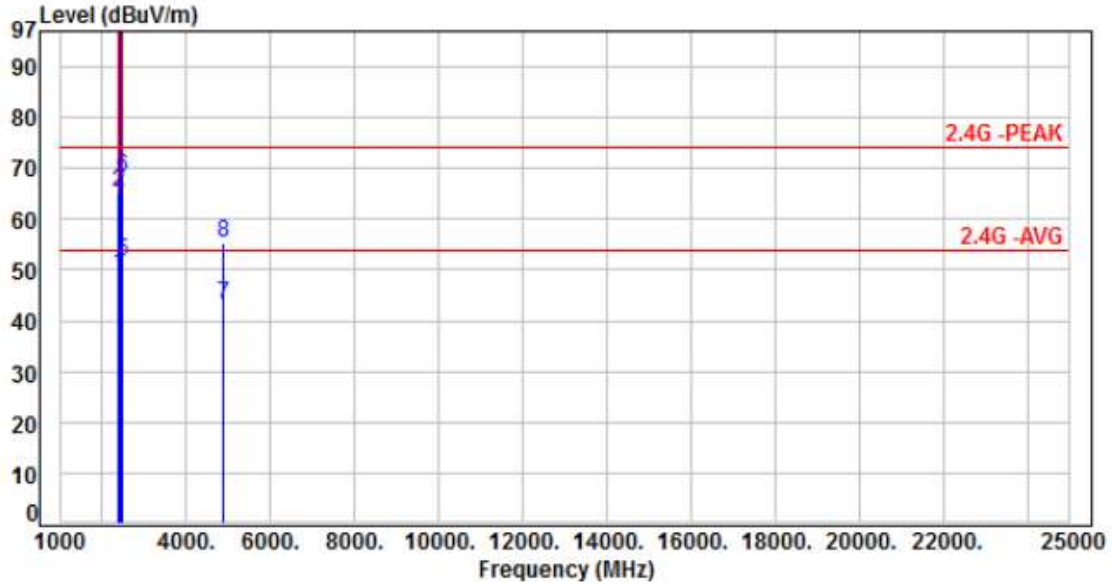

No.	Frequency (MHz)	Factor (dB)	Reading (dBuV)	Level (dBuV/m)	Limit (dBuV/m)	Margin (dB)	Detector	Height (cm)	Azimuth (deg)	P/F
1	2390.00	-3.62	52.65	49.03	54.00	-4.97	Average	382	356	P
2	2390.00	-3.62	68.84	65.22	74.00	-8.78	Peak	382	356	P
3	2437.00	-3.57	104.26	100.69	200.00	-99.31	Average	382	356	P
4	2437.00	-3.57	113.51	109.94	200.00	-90.06	Peak	382	356	P
5	2483.50	-3.40	54.92	51.52	54.00	-2.48	Average	382	356	P
6	2483.50	-3.40	71.74	68.34	74.00	-5.66	Peak	382	356	P
7	4874.00	3.90	39.26	43.16	54.00	-10.84	Average	315	100	P
8	4874.00	3.90	51.34	55.24	74.00	-18.76	Peak	315	100	P

Note: Level=Reading+Factor
 Margin=Level-Limit
 Factor=Antenna Factor + cable loss - Amplifier Factor



Power	: AC 120V / 60Hz	Pol/Phase	: HORIZONTAL
Test Mode	: Mode 4, CH06		:

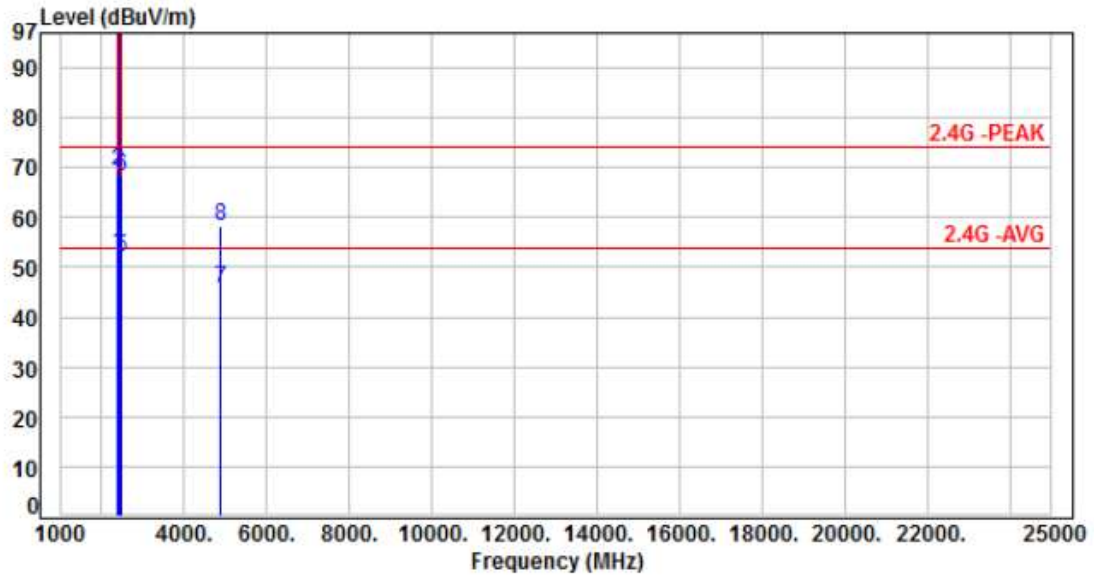

No.	Frequency (MHz)	Factor (dB)	Reading (dBuV)	Level (dBuV/m)	Limit (dBuV/m)	Margin (dB)	Detector	Height (cm)	Azimuth (deg)	P/F
1	2390.00	-3.62	56.36	52.74	54.00	-1.26	Average	359	267	P
2	2390.00	-3.62	72.79	69.17	74.00	-4.83	Peak	359	267	P
3	2437.00	-3.57	105.25	101.68	200.00	-98.32	Average	359	267	P
4	2437.00	-3.57	114.80	111.23	200.00	-88.77	Peak	359	267	P
5	2483.50	-3.40	55.26	51.86	54.00	-2.14	Average	359	267	P
6	2483.50	-3.40	71.77	68.37	74.00	-5.63	Peak	359	267	P
7	4874.00	3.90	41.82	45.72	54.00	-8.28	Average	376	356	P
8	4874.00	3.90	54.35	58.25	74.00	-15.75	Peak	376	356	P

Note: Level=Reading+Factor
 Margin=Level-Limit
 Factor=Antenna Factor + cable loss - Amplifier Factor



Power	: AC 120V / 60Hz	Pol/Phase	: VERTICAL
Test Mode	: Mode 4, CH09		:

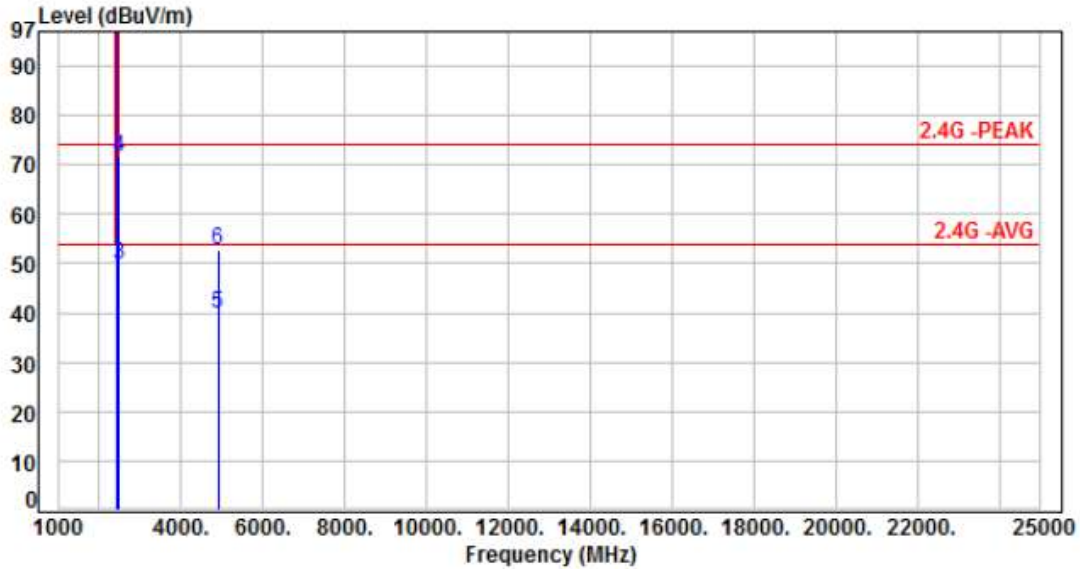

No.	Frequency (MHz)	Factor (dB)	Reading (dBuV)	Level (dBuV/m)	Limit (dBuV/m)	Margin (dB)	Detector	Height (cm)	Azimuth (deg)	P/F
1	2452.00	-3.55	102.47	98.92	200.00	-101.08	Average	386	358	P
2	2452.00	-3.55	112.06	108.51	200.00	-91.49	Peak	386	358	P
3	2483.50	-3.40	53.14	49.74	54.00	-4.26	Average	386	358	P
4	2483.50	-3.40	75.06	71.66	74.00	-2.34	Peak	386	358	P
5	4904.00	4.00	35.77	39.77	54.00	-14.23	Average	362	136	P
6	4904.00	4.00	48.83	52.83	74.00	-21.17	Peak	362	136	P

Note: Level=Reading+Factor
 Margin=Level-Limit
 Factor=Antenna Factor + cable loss - Amplifier Factor



Power	: AC 120V / 60Hz	Pol/Phase	: HORIZONTAL
Test Mode	: Mode 4, CH09		:

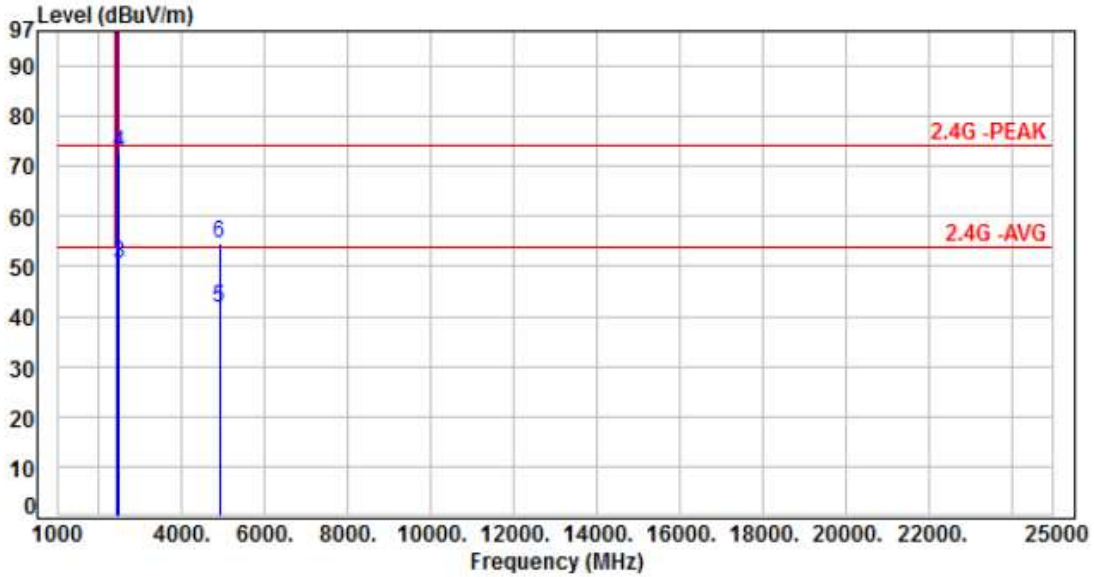

No.	Frequency (MHz)	Factor (dB)	Reading (dBuV)	Level (dBuV/m)	Limit (dBuV/m)	Margin (dB)	Detector	Height (cm)	Azimuth (deg)	P/F
1	2452.00	-3.55	103.82	100.27	200.00	-99.73	Average	276	59	P
2	2452.00	-3.55	113.91	110.36	200.00	-89.64	Peak	276	59	P
3	2483.50	-3.40	53.75	50.35	54.00	-3.65	Average	276	59	P
4	2483.50	-3.40	75.94	72.54	74.00	-1.46	Peak	276	59	P
5	4904.00	4.00	37.76	41.76	54.00	-12.24	Average	329	352	P
6	4904.00	4.00	50.74	54.74	74.00	-19.26	Peak	329	352	P

Note: Level=Reading+Factor
 Margin=Level-Limit
 Factor=Antenna Factor + cable loss - Amplifier Factor



6.7 Restricted Bands of Operation

Only spurious emissions are permitted in any of the frequency bands listed below:

MHz	MHz	MHz	GHz
0.09000 – 0.11000	16.42000 – 16.42300	399.9 – 410.0	4.500 – 5.250
0.49500 – 0.505**	16.69475 – 16.69525	608.0 – 614.0	5.350 – 5.460
2.17350 – 2.19050	16.80425 – 16.80475	960.0 – 1240.0	7.250 – 7.750
4.12500 – 4.12800	25.50000 – 25.67000	1300.0 – 1427.0	8.025 – 8.500
4.17725 – 4.17775	37.50000 – 38.25000	1435.0 – 1626.5	9.000 – 9.200
4.20725 – 4.20775	73.00000 – 74.60000	1645.5 – 1646.5	9.300 – 9.500
6.21500 – 6.21800	74.80000 – 75.20000	1660.0 – 1710.0	10.600 – 12.700
6.26775 – 6.26825	108.00000 – 121.94000	1718.8 – 1722.2	13.250 – 13.400
6.31175 – 6.31225	123.00000 – 138.00000	2200.0 – 2300.0	14.470 – 14.500
8.29100 – 8.29400	149.90000 – 150.05000	2310.0 – 2390.0	15.350 – 16.200
8.36200 – 8.36600	156.52475 – 156.52525	2483.5 – 2500.0	17.700 – 21.400
8.37625 – 8.38675	156.70000 – 156.90000	2655.0 – 2900.0	22.010 – 23.120
8.41425 – 8.41475	162.01250 – 167.17000	3260.0 – 3267.0	23.600 – 24.000
12.29000 – 12.29300	167.72000 – 173.20000	3332.0 – 3339.0	31.200 – 31.800
12.51975 – 12.52025	240.00000 – 285.00000	3345.8 – 3358.0	36.430 – 36.500
12.57675 – 12.57725	322.00000 – 335.40000	3600.0 – 4400.0	Above 38.6
13.36000 – 13.41000			

** : Until February 1, 1999, this restricted band shall be 0.490-0.510 MHz



7. Test of Conducted Spurious Emission

7.1 Test Limit

Below -20dB of the highest emission level of operating band (In 100 kHz Resolution Bandwidth)

7.2 Test Procedure

- a. The transmitter output was connected to the spectrum analyzer via a low loss cable.
- b. Set RBW of spectrum analyzer to 100 KHz and VBW of spectrum analyzer to 300 KHz with convenient frequency span including 100 KHz bandwidth from band edge.
- c. Peak conducted output power measured within any 100 kHz outside the authorized frequency band shall be attenuated by at least 20dB relative to the maximum measured in-band peak PSD level.
- d. The band edges was measured and recorded.

7.3 Test Setup Layout

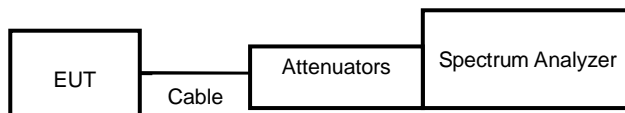

7.4 Test Result and Data

Note: Test plots refers to the following pages.



ANT A

Modulation Type: 802.11b, CH 01



Modulation Type: 802.11b, CH 06

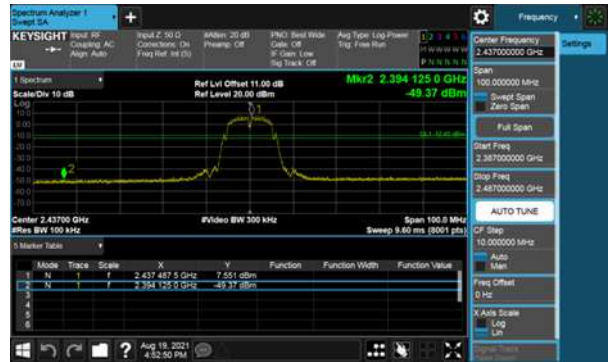
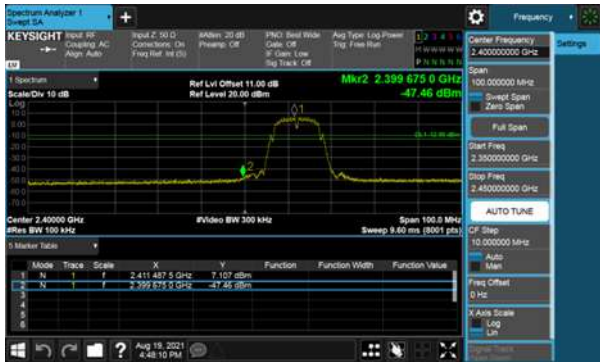



ANT A

Modulation Type: 802.11b, CH 11





ANT A

Modulation Type: 802.11g, CH 01



Modulation Type: 802.11g, CH 06

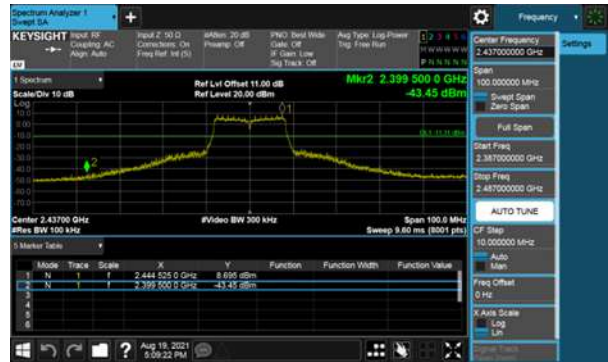



ANT A

Modulation Type: 802.11g, CH 11

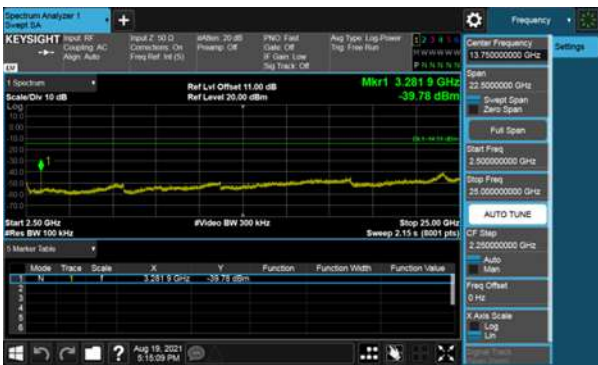
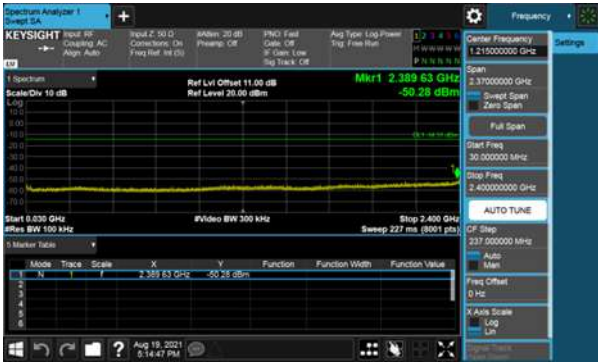



ANT A

Modulation Type: 802.11n HT20, CH01



Modulation Type: 802.11n HT20, CH06

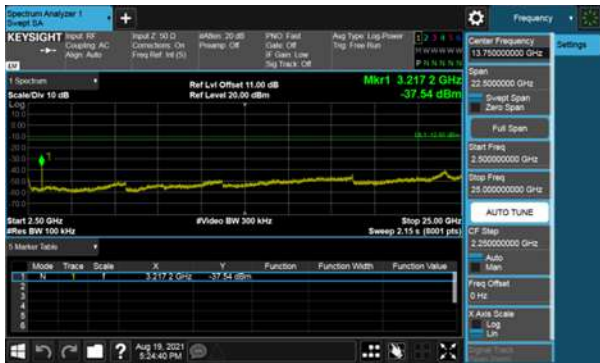



ANT A

Modulation Type: 802.11n HT20, CH11





ANT A

Modulation Type: 802.11n HT40, CH03



Modulation Type: 802.11n HT40, CH06

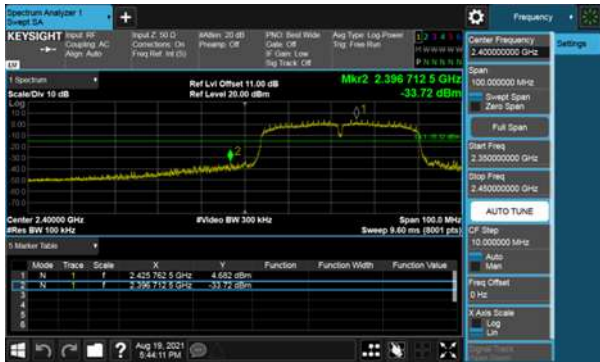



ANT A

Modulation Type: 802.11n HT40, CH09





ANT C

Modulation Type: 802.11g, CH 01



Modulation Type: 802.11g, CH 06





ANT C

Modulation Type: 802.11g, CH 11

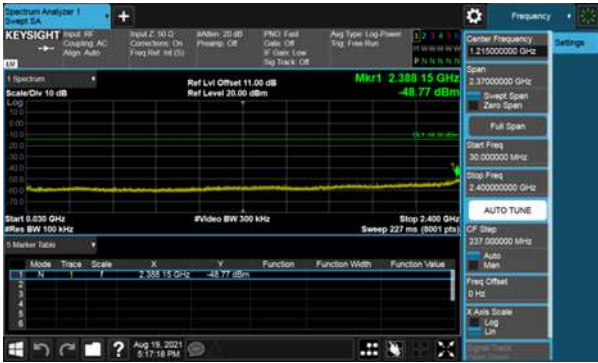



ANT C

Modulation Type: 802.11n HT20, CH01



Modulation Type: 802.11n HT20, CH06

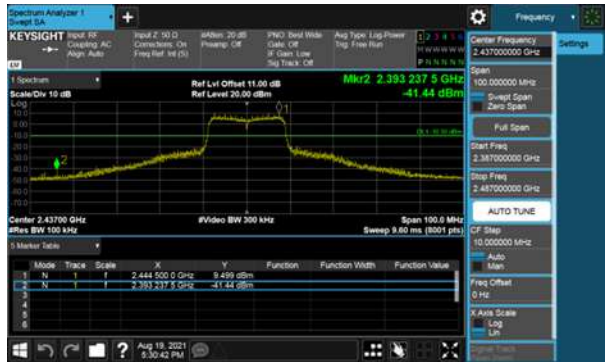
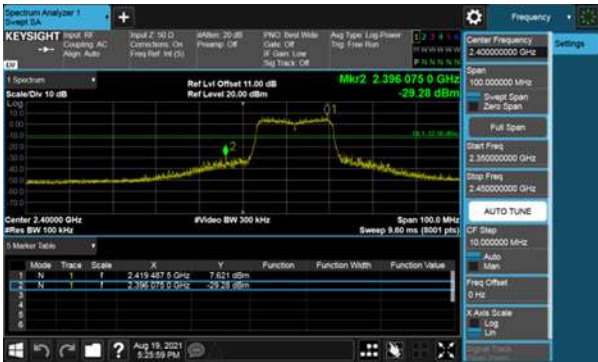



ANT C

Modulation Type: 802.11n HT20, CH11





ANT C

Modulation Type: 802.11n HT40, CH03



Modulation Type: 802.11n HT40, CH06

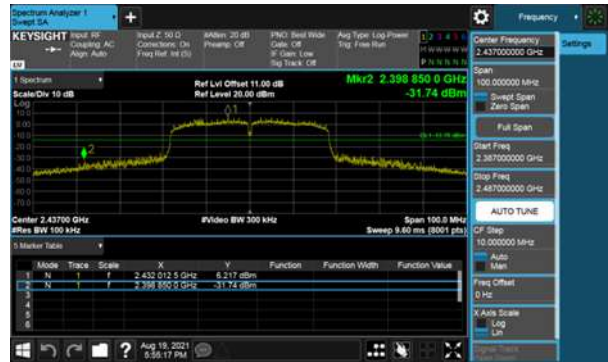
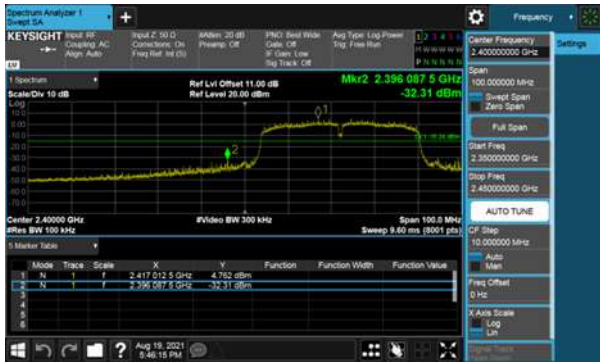



ANT C

Modulation Type: 802.11n HT40, CH09

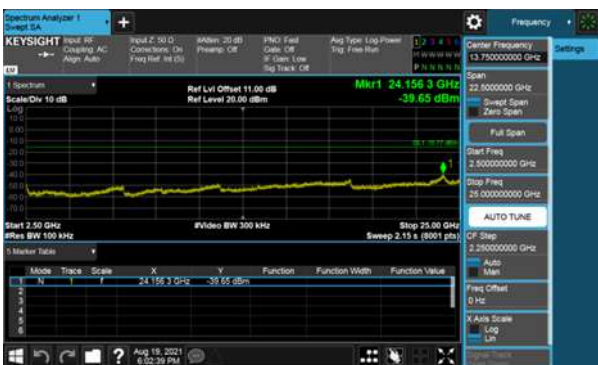
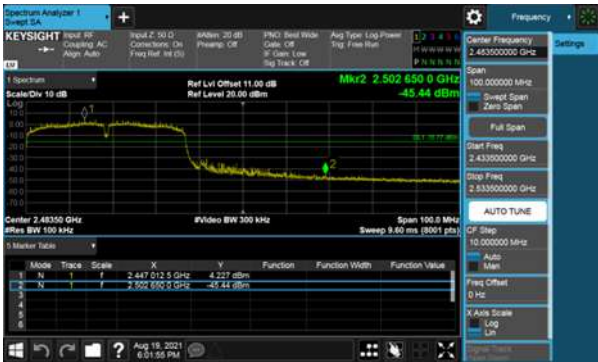



8. On Time, Duty Cycle and Measurement methods

8.1 Test Limit

None; for reporting purposes only.

8.2 Test Procedure

Zero-Span Spectrum Analyzer Method.

8.3 Test Setup Layout

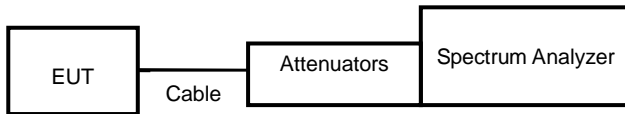

8.4 Test Result and Data

Modulation Type	On Time (msec)	Period Time (msec)	Duty Cycle (%)
11b,1M	12.44	13.06	95.25%
11g,6M	2.06	2.18	94.81%
11n HT20	1.90	2.00	95.00%
11n HT40	0.93	1.03	90.37%



Modulation Type: 802.11b(1Mbps)



Modulation Type: 802.11n HT40(13.5Mbps)



Modulation Type: 802.11g(6Mbps)



Modulation Type: 802.11n HT20(6.5Mbps)





9. 6dB Bandwidth Measurement Data

9.1 Test Limit

The minimum of 6dB Bandwidth Measurement is 0.5 MHz.

9.2 Test Procedures

- a. The transmitter output was connected to the spectrum analyzer.
- b. Set RBW of spectrum analyzer to 100 KHz and VBW to 300 KHz.
- c. The 6 dB bandwidth is defined as the total spectrum the power of which is higher than peak power minus 6 dB.
- d. The 6dB Bandwidth was measured and recorded.

9.3 Test Setup Layout

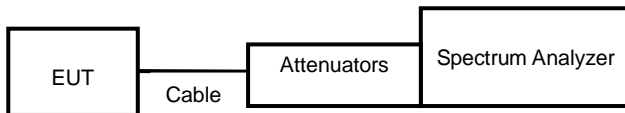



9.4 Test Result and Data

Modulation Type	Channel	Frequency (MHz)	6dB Bandwidth (MHz)		Limit (MHz)
			ANT A	ANT C	
11b	1	2412	10.02	-	0.5
	6	2437	9.57	-	0.5
	11	2462	9.60	-	0.5
11g	1	2412	16.32	16.35	0.5
	6	2437	16.32	16.32	0.5
	11	2462	16.32	16.35	0.5
11n HT20	1	2412	16.89	16.74	0.5
	6	2437	16.86	16.77	0.5
	11	2462	16.92	16.77	0.5
11n HT40	3	2422	32.58	31.38	0.5
	6	2437	32.58	31.32	0.5
	9	2452	32.58	32.52	0.5



ANT A
Modulation Type: 802.11b
CH01

Modulation Type: 802.11g
CH01



CH06

CH06



CH11

CH11





ANT A
Modulation Type: 802.11n HT20
CH01



Modulation Type: 802.11n HT40
CH03



CH06



CH06



CH11



CH09





ANT C
Modulation Type: 802.11g
CH01



Modulation Type: 802.11n HT20
CH01



CH06



CH06



CH11



CH11





ANT C
Modulation Type: 802.11n HT40
CH03



CH06



CH09





10. Maximum Peak and Average Output Power

10.1 Test Limit

The Maximum Peak Output Power Measurement is 30dBm.

If transmitting antennas of directional gain greater than 6 dBi are used, the peak output power shall be reduced by the amount in dB that the directional gain of the antenna exceeds 6 dBi

10.2 Test Procedures

The antenna port (RF output) of the EUT was connected to the input (RF input) of a power meter. Power was read directly from the meter and cable loss connection was added to the reading to obtain power at the EUT antenna terminal. The EUT Output Power was set to maximum to produce the worse case test result.

10.3 Test Setup Layout

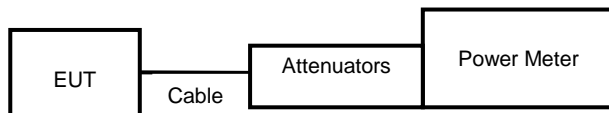

**10.4 Test Result and Data**

Setting	Modulation Mode	Channel	Frequency (MHz)	Conducted(peak) output power (dBm)		Total PK power (dBm)	Total PK power (mW)	Power Limit (dBm)
				ANT A (AJ1)	ANT C (AJ6)			
62	11b	1	2412	20.99	-	20.99	125.603	30.00
64		6	2437	21.48	-	21.48	140.605	30.00
62		11	2462	21.07	-	21.07	127.938	30.00
74	11g	1	2412	26.32	26.29	29.32	854.147	30.00
80		6	2437	26.94	26.79	29.88	971.840	30.00
66		11	2462	25.13	24.95	28.05	638.445	30.00
72	11n HT20	1	2412	25.89	26.10	29.01	795.531	30.00
79		6	2437	26.97	26.88	29.94	985.266	30.00
66		11	2462	25.21	25.15	28.19	659.235	30.00
68	11n HT40	3	2422	26.12	25.91	29.03	799.203	30.00
74		6	2437	26.85	26.69	29.78	950.832	30.00
66		9	2452	26.05	25.93	29.00	794.459	30.00

Setting	Modulation Mode	Channel	Frequency (MHz)	Conducted(average) output power (dBm)		Total AV power (dBm)	Total AV power (mW)	Power Limit (dBm)
				ANT A (AJ1)	ANT C (AJ6)			
62	11b	1	2412	15.91	-	15.91	38.994	NA
64		6	2437	16.34	-	16.34	43.053	NA
62		11	2462	15.99	-	15.99	39.719	NA
74	11g	1	2412	18.22	18.09	21.17	130.791	NA
80		6	2437	19.74	19.53	22.65	183.932	NA
66		11	2462	16.10	16.11	19.12	81.570	NA
72	11n HT20	1	2412	17.54	17.77	20.67	116.596	NA
79		6	2437	19.77	19.64	22.72	186.887	NA
66		11	2462	16.26	16.37	19.33	85.618	NA
68	11n HT40	3	2422	17.65	17.16	20.42	110.210	NA
74		6	2437	19.17	18.98	22.09	161.672	NA
66		9	2452	17.53	17.07	20.32	107.557	NA

Note: Average power is for reference only.



11. Power Spectral Density

11.1 Test Limit

The Maximum of Power Spectral Density Measurement is 8dBm.

If transmitting antennas of directional gain greater than 6 dBi are used, the power spectral density shall be reduced by the amount in dB that the directional gain of the antenna exceeds 6 dBi

11.2 Test Procedures

- a. The transmitter output was connected to spectrum analyzer.
- b. The spectrum analyzer's resolution bandwidth were set at 3kHz RBW and 10KHz VBW as that of the fundamental frequency. Set the sweep time=auto couple.
- c. The power spectral density was measured and recorded.

11.3 Test Setup Layout

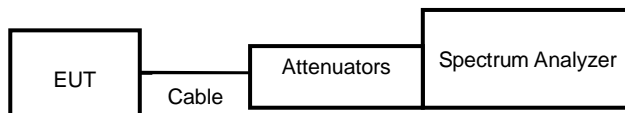



11.4 Test Result and Data

Modulation Type	Channel	Frequency (MHz)	Maximum Power Density of 3KHz Bandwidth(dBm)		Sum chain (dBm)	Duty Cycle CF(dB)	Total PSD (dBm)	Limit (dBm)
			ANT A	ANT C				
11b	1	2412	-8.32	-	-8.32	0.00	-8.32	8.00
	6	2437	-7.07	-	-7.07	0.00	-7.07	8.00
	11	2462	-7.77	-	-7.77	0.00	-7.77	8.00
11g	1	2412	-7.31	-6.84	-4.06	0.00	-4.06	7.41
	6	2437	-5.43	-6.04	-2.71	0.00	-2.71	7.41
	11	2462	-9.24	-8.33	-5.75	0.00	-5.75	7.41
11n HT20	1	2412	-7.30	-7.40	-4.34	0.00	-4.34	7.41
	6	2437	-5.39	-5.54	-2.45	0.00	-2.45	7.41
	11	2462	-7.69	-9.36	-5.43	0.00	-5.43	7.41
11n HT40	3	2422	-11.40	-10.06	-7.67	0.00	-7.67	7.41
	6	2437	-9.32	-9.55	-6.42	0.00	-6.42	7.41
	9	2452	-10.64	-10.76	-7.69	0.00	-7.69	7.41



ANT A
Modulation Type: 802.11b
CH01

Modulation Type: 802.11g
CH01



CH06

CH06

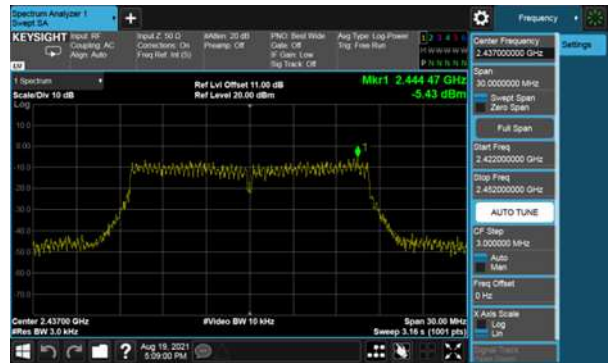

CH11

CH11





ANT A
Modulation Type: 802.11n HT20
CH01

Modulation Type: 802.11n HT40
CH03



CH06

CH06

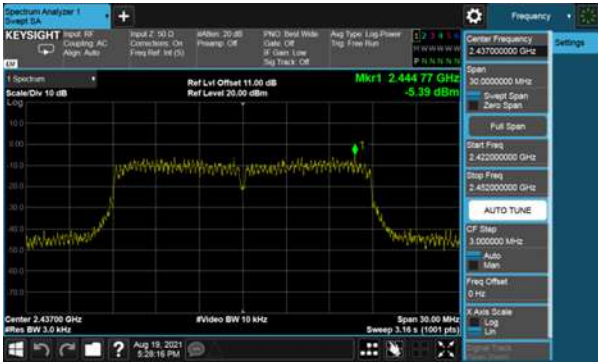

CH11

CH09

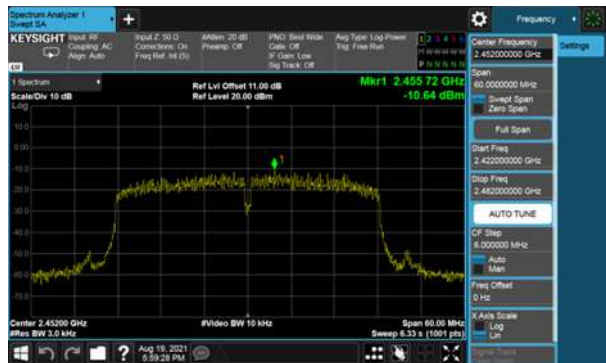



ANT C
Modulation Type: 802.11g
CH01

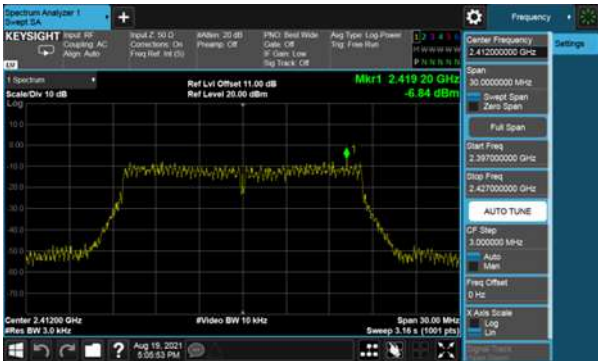

Modulation Type: 802.11n HT20
CH01



CH06

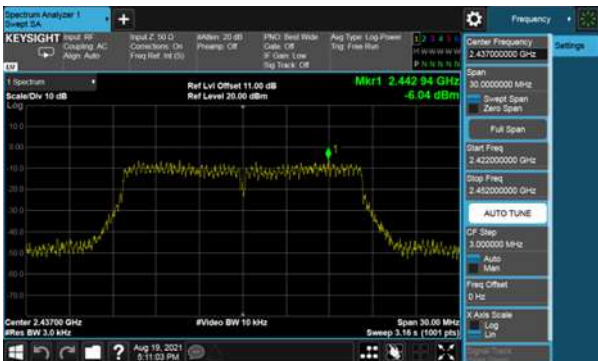

CH06

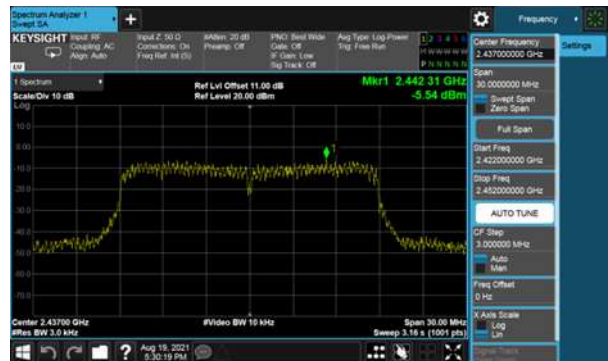

CH11



CH11





ANT C
Modulation Type: 802.11n HT40
CH03



CH06



CH09

