

ELECTROMAGNETIC EMISSIONS COMPLIANCE REPORT

Applicant: CastleNet Technology Inc.
No. 14, Ln. 141, Sec. 3, Beishen Rd., Shenkeng Dist.,
New Taipei City 22244, Taiwan (R.O.C.)

Product Name: Wireless Cable Gateway

Brand Name: Castlenet

Model No.: CBV384Z4

Model Difference: N/A

Report Number: E2/2020/B0039

FCC ID RK9-CBV384Z4

FCC Rule Part: §15.407, Cat: U-NII

Issue Date: Apr. 09, 2021

Date of Test: Nov. 23, 2020 - Mar. 12, 2021

**Date of EUT Re-
ceived:** Nov. 23, 2020

The above equipment was tested by SGS Taiwan Ltd. Central RF Lab Laboratory The test data, data evaluation, test procedures, and equipment configurations shown in this report were made in accordance with the procedures given in ANSI C63.10: 2013 and the energy emitted by the sample EUT tested as described in this report is in compliance with conducted and radiated emission limits.

The test results of this report relate only to the tested sample identified in this report.

proved By: _____

Vito Pei / Asst. Supervisor

Vito Pei



Unless otherwise stated the results shown in this test report refer only to the sample(s) tested and such sample(s) are retained for 90 days only.

除非另有說明，此報告結果僅對測試之樣品負責，同時此樣品僅保留90天。本報告未經本公司書面許可，不可部份複製。

This document is issued by the Company subject to its General Conditions of Service printed overleaf, available on request or accessible at <http://www.sgs.com.tw/Terms-and-Conditions> and for electronic format documents, subject to Terms and Conditions for Electronic Documents at <http://www.sgs.com.tw/Terms-and-Conditions>. Attention is drawn to the limitation of liability, indemnification and jurisdiction issues defined therein. Any holder of this document is advised that information contained hereon reflects the Company's findings at the time of its intervention only and within the limits of Client's instructions, if any. The Company's sole responsibility is to its Client and this document does not exonerate parties to a transaction from exercising all their rights and obligations under the transaction documents. This document cannot be reproduced except in full, without prior written approval of the Company. Any unauthorized alteration, forgery or falsification of the content or appearance of this document is unlawful and offenders may be prosecuted to the fullest extent of the law.

Revision History

Report Number	Revision	Description	Issue Date	Revised By
E2/2020/B0039	Rev.00	Original.	Apr. 09, 2021	Revised By: Yuri Tsai

Note:

Antenna information is provided by the applicant, test results of this report are applicable to the sample EUT received.

Unless otherwise stated the results shown in this test report refer only to the sample(s) tested and such sample(s) are retained for 90 days only.

除非另有說明，此報告結果僅對測試之樣品負責，同時此樣品僅保留90天。本報告未經本公司書面許可，不可部份複製。

This document is issued by the Company subject to its General Conditions of Service printed overleaf, available on request or accessible at <http://www.sgs.com.tw/Terms-and-Conditions> and for electronic format documents, subject to Terms and Conditions for Electronic Documents at <http://www.sgs.com.tw/Terms-and-Conditions>. Attention is drawn to the limitation of liability, indemnification and jurisdiction issues defined therein. Any holder of this document is advised that information contained hereon reflects the Company's findings at the time of its intervention only and within the limits of Client's instructions, if any. The Company's sole responsibility is to its Client and this document does not exonerate parties to a transaction from exercising all their rights and obligations under the transaction documents. This document cannot be reproduced except in full, without prior written approval of the Company. Any unauthorized alteration, forgery or falsification of the content or appearance of this document is unlawful and offenders may be prosecuted to the fullest extent of the law.

Contents

1	GENERAL INFORMATION	4
2	SUMMARY OF TEST RESULT	7
3	MEASUREMENT UNCERTAINTY	7
4	TPC AND DFS MEASUREMENT	8
5	APPLICABLE STANDARDS.....	9
6	TEST SETUP	13
7	TEST EQUIPMENT USED:.....	13
8	DESCRIPTION OF EUT:	14
9	RADAR TYPE WAVEFORM CALIBRATION AT DFS DECTION THESHOLD	15
10	CHANNEL CLOSING TRANSMISSION AND CHANNEL MOVE TIME MEASUREMENT (RADAR TYPE 0).....	27
11	NON-OCCUPANCY PERIOD MEASUREMENT	29
12	UNII DETECTION BANDWIDTH MEASUREMENT	30
13	CHANNEL AVAILABILITY CHECK MEASUREMENT	35
14	IN SERVICE MONITORING.....	37

Unless otherwise stated the results shown in this test report refer only to the sample(s) tested and such sample(s) are retained for 90 days only.

除非另有說明，此報告結果僅對測試之樣品負責，同時此樣品僅保留90天。本報告未經本公司書面許可，不可部份複製。

This document is issued by the Company subject to its General Conditions of Service printed overleaf, available on request or accessible at <http://www.sgs.com.tw/Terms-and-Conditions> and for electronic format documents, subject to Terms and Conditions for Electronic Documents at <http://www.sgs.com.tw/Terms-and-Conditions>. Attention is drawn to the limitation of liability, indemnification and jurisdiction issues defined therein. Any holder of this document is advised that information contained hereon reflects the Company's findings at the time of its intervention only and within the limits of Client's instructions, if any. The Company's sole responsibility is to its Client and this document does not exonerate parties to a transaction from exercising all their rights and obligations under the transaction documents. This document cannot be reproduced except in full, without prior written approval of the Company. Any unauthorized alteration, forgery or falsification of the content or appearance of this document is unlawful and offenders may be prosecuted to the fullest extent of the law.

1 GENERAL INFORMATION

1.1 Product Description

Product Name:	Wireless Cable Gateway	
Brand Name:	Castlenet	
Model No.:	CBV384Z4	
Model Difference:	N/A	
Operation mode	Master equipment	
Hardware Version:	N/A	
Software Version:	N/A	
EUT Series No.:	PJ20B158002	
Power Supply:	12Vdc from AC/DC Adapter	
Modulation type:	64QAM, 16QAM, QPSK, BPSK for OFDM 256QAM for OFDM in 802.11ac only	
Transition Rate:	802.11 a: 6/9/12/18/24/36/48/54 Mbps 802.11 n_20MHz: 6.5 – 288.9Mbps 802.11 n_40MHz: 13.5 – 600.0Mbps	802.11 ac_20MHz: 6.5 –346.8Mbps 802.11 ac_40MHz: 13.5 –800.0Mbps 802.11 ac_80MHz: 29.3 – 1733.2Mbps

DFS FW version:



Unless otherwise stated the results shown in this test report refer only to the sample(s) tested and such sample(s) are retained for 90 days only.

除非另有說明，此報告結果僅對測試之樣品負責，同時此樣品僅保留90天。本報告未經本公司書面許可，不可部份複製。

This document is issued by the Company subject to its General Conditions of Service printed overleaf, available on request or accessible at <http://www.sgs.com.tw/Terms-and-Conditions> and for electronic format documents, subject to Terms and Conditions for Electronic Documents at <http://www.sgs.com.tw/Terms-and-Conditions>. Attention is drawn to the limitation of liability, indemnification and jurisdiction issues defined therein. Any holder of this document is advised that information contained hereon reflects the Company's findings at the time of its intervention only and within the limits of Client's instructions, if any. The Company's sole responsibility is to its Client and this document does not exonerate parties to a transaction from exercising all their rights and obligations under the transaction documents. This document cannot be reproduced except in full, without prior written approval of the Company. Any unauthorized alteration, forgery or falsification of the content or appearance of this document is unlawful and offenders may be prosecuted to the fullest extent of the law.

1.2 Antenna Designation

Ant. Type	Ch0/Ch1/Ch2/Ch3	Supplier	Part No.	Freq.(MHz)	Peak Gain (dBi)	Worst Antenna Gain
PCB	Ch0	AnJie	CBV384Z4-AC2800	5250~5350	2.86	
				5470~5725	2.73	
PCB	Ch1	AnJie	CBV384Z4-AC2800	5250~5350	2.86	
				5470~5725	2.82	
PCB	Ch2	AnJie	CBV384Z4-AC2800	5250~5350	2.95	
				5470~5725	2.73	
PCB	Ch3	AnJie	CBV384Z4-AC2800	5250~5350	2.97	V
				5470~5725	2.96	V

Note: Investigation has been done to determine the worst case scenario for the above antennas demonstrated with measurements in this report.

For MIMO mode, higher antenna gains are chosen to ensure higher directional gain is evaluated as below.

Ant. Type	Supplier	Part No.	Freq.(MHz)	Peak Gain (dBi)
PCB	AnJie	CBV384Z4-AC2800	5250~5350	8.93
			5470~5725	8.83

Note: Above 4 antenna ports were used for DFS test.

1.3 WLAN 5GHz:

Wi-Fi 802.11	Frequency Range	Channels	Rated Power (Avg.) (dBm) (Worst case)		Maximum Antenna Gain (dBi)	EIRP (dBm)
a	5250~5350	4	21.94		8.93	30.87
	5470~5725	12	21.98		8.83	30.81
n_HT ac_VHT 20M	5250~5350	4	HT:	20.29	8.93	29.22
	5470~5725	12	HT:	20.34	8.83	29.17
n_HT ac_VHT 40M	5250~5350	2	HT:	20.39	8.93	29.32
	5470~5725	6	HT:	20.55	8.83	29.38
ac_VHT 80M	5250~5350	1	20.37		8.93	29.3
	5470~5725	3	20.41		8.83	29.24

Unless otherwise stated the results shown in this test report refer only to the sample(s) tested and such sample(s) are retained for 90 days only.

除非另有說明，此報告結果僅對測試之樣品負責，同時此樣品僅保留90天。本報告未經本公司書面許可，不可部份複製。

This document is issued by the Company subject to its General Conditions of Service printed overleaf, available on request or accessible at <http://www.sgs.com.tw/Terms-and-Conditions> and for electronic format documents, subject to Terms and Conditions for Electronic Documents at <http://www.sgs.com.tw/Terms-and-Conditions>. Attention is drawn to the limitation of liability, indemnification and jurisdiction issues defined therein. Any holder of this document is advised that information contained hereon reflects the Company's findings at the time of its intervention only and within the limits of Client's instructions, if any. The Company's sole responsibility is to its Client and this document does not exonerate parties to a transaction from exercising all their rights and obligations under the transaction documents. This document cannot be reproduced except in full, without prior written approval of the Company. Any unauthorized alteration, forgery or falsification of the content or appearance of this document is unlawful and offenders may be prosecuted to the fullest extent of the law.

1.4 Test Methodology of Applied Standards

FCC Part 15, Subpart E §15.407

FCC KDB 905462 D02 UNII DFS Compliance Procedures New Rules v02

1.5 Test Facility

Laboratory	Test Site Address		FCC Designation number
SGS Taiwan Ltd. Central RF Lab. (TAF code 3702)	<input type="checkbox"/>	No.134, Wu Kung Road, New Taipei Industrial Park, Wuku District, New Taipei City, Taiwan.	TW0027
	<input checked="" type="checkbox"/>	No.2, Keji 1st Rd., Guishan District, Taoyuan City, Taiwan 333	TW0028

1.6 Special Accessories

There are no special accessories used while test was conducted.

1.7 Equipment Modifications

There was no modification incorporated into the EUT.

Unless otherwise stated the results shown in this test report refer only to the sample(s) tested and such sample(s) are retained for 90 days only.

除非另有說明，此報告結果僅對測試之樣品負責，同時此樣品僅保留90天。本報告未經本公司書面許可，不可部份複製。

This document is issued by the Company subject to its General Conditions of Service printed overleaf, available on request or accessible at <http://www.sgs.com.tw/Terms-and-Conditions> and for electronic format documents, subject to Terms and Conditions for Electronic Documents at <http://www.sgs.com.tw/Terms-and-Conditions>. Attention is drawn to the limitation of liability, indemnification and jurisdiction issues defined therein. Any holder of this document is advised that information contained hereon reflects the Company's findings at the time of its intervention only and within the limits of Client's instructions, if any. The Company's sole responsibility is to its Client and this document does not exonerate parties to a transaction from exercising all their rights and obligations under the transaction documents. This document cannot be reproduced except in full, without prior written approval of the Company. Any unauthorized alteration, forgery or falsification of the content or appearance of this document is unlawful and offenders may be prosecuted to the fullest extent of the law.

2 SUMMARY OF TEST RESULT

FCC and ISED Rules	Description Of Test	Result
§15.407(h) FCC KDB 905462 D02	TPC and DFS Measurement	Compliant

3 MEASUREMENT UNCERTAINTY

Test Items	Uncertainty
TPC and DFS Measurement	+/- 0.89 Hz
Temperature	+/- 0.4 °C
Humidity	+/- 3.5 %
DC / AC Power Source	DC= +/- 1%, AC= +/- 1%

This uncertainty represents an expanded uncertainty expressed at approximately the 95% confidence level using a coverage factor of k=2.

The conformity assessment statement in this report is based solely on the test results, measurement uncertainty is excluded.

Unless otherwise stated the results shown in this test report refer only to the sample(s) tested and such sample(s) are retained for 90 days only.

除非另有說明，此報告結果僅對測試之樣品負責，同時此樣品僅保留90天。本報告未經本公司書面許可，不可部份複製。

This document is issued by the Company subject to its General Conditions of Service printed overleaf, available on request or accessible at <http://www.sgs.com.tw/Terms-and-Conditions> and for electronic format documents, subject to Terms and Conditions for Electronic Documents at <http://www.sgs.com.tw/Terms-and-Conditions>. Attention is drawn to the limitation of liability, indemnification and jurisdiction issues defined therein. Any holder of this document is advised that information contained hereon reflects the Company's findings at the time of its intervention only and within the limits of Client's instructions, if any. The Company's sole responsibility is to its Client and this document does not exonerate parties to a transaction from exercising all their rights and obligations under the transaction documents. This document cannot be reproduced except in full, without prior written approval of the Company. Any unauthorized alteration, forgery or falsification of the content or appearance of this document is unlawful and offenders may be prosecuted to the fullest extent of the law.

4 TPC AND DFS MEASUREMENT

4.1 TPC: Standard Applicable

According to §15.407(h)(1), Transmit power control (TPC). U-NII devices operating in the 5.25-5.35 GHz band and the 5.47-5.725 GHz band shall employ a TPC mechanism. The U-NII device is required to have the capability to operate at least 6 dB below the mean EIRP value of 30 dBm. A TPC mechanism is not required for systems with an e.i.r.p. of less than 500 mW.

Result: Yes, the EUT employs TPC mechanism.

4.2 DFS: Standard Applicable

According to §15.407(h)(2) and FCC KDB 905462 D02 , Radar Detection Function of Dynamic Frequency Selection (DFS).

Radar Detection Function of Dynamic Frequency Selection (DFS). U-NII devices operating with any part of its 26 dB emission bandwidth in the 5.25-5.35 GHz and 5.47-5.725 GHz bands shall employ a DFS radar detection mechanism to detect the presence of radar systems and to avoid co-channel operation with radar systems. Operators shall only use equipment with a DFS mechanism that is turned on when operating in these bands. The device must sense for radar signals at 100 percent of its emission bandwidth. The minimum DFS detection threshold for devices with a maximum e.i.r.p. of 200 mW to 1 W is -64 dBm. For devices that operate with less than 200 mW e.i.r.p. and a power spectral density of less than 10 dBm in a 1 MHz band, the minimum detection threshold is -62 dBm. The detection threshold is the received power averaged over 1 microsecond referenced to a 0 dBi antenna. For the initial channel setting, the manufacturers shall be permitted to provide for either random channel selection or manual channel selection.

- (i) Operational Modes. The DFS requirement applies to the following operational modes:
 - (a) The requirement for channel availability check time applies in the master operational mode.
 - (b) The requirement for channel move time applies in both the master and slave operational modes.
- (ii) Channel Availability Check Time. A U-NII device shall check if there is a radar system already operating on the channel before it can initiate a transmission on a channel and when it has to move to a new channel. The U-NII device may start using the channel if no radar signal with a power level greater than the interference threshold values listed in paragraph (h)(2) of this section, is detected within 60 seconds.
- (iii) Channel Move Time. After a radar's presence is detected, all transmissions shall cease on the operating channel within 10 seconds. Transmissions during this period shall consist of normal traffic for a maximum of 200 ms after detection of the radar signal. In addition, intermittent management and control signals can be sent during the remaining time to facilitate vacating the operating channel.

Non-occupancy Period. A channel that has been flagged as containing a radar system, either by a channel availability check or in-service monitoring, is subject to a non-occupancy period of at least 30 minutes. The non-occupancy period starts at the time when the radar system is detected.

Unless otherwise stated the results shown in this test report refer only to the sample(s) tested and such sample(s) are retained for 90 days only.

除非另有說明，此報告結果僅對測試之樣品負責，同時此樣品僅保留90天。本報告未經本公司書面許可，不可部份複製。

This document is issued by the Company subject to its General Conditions of Service printed overleaf, available on request or accessible at <http://www.sgs.com.tw/Terms-and-Conditions> and for electronic format documents, subject to Terms and Conditions for Electronic Documents at <http://www.sgs.com.tw/Terms-and-Conditions>. Attention is drawn to the limitation of liability, indemnification and jurisdiction issues defined therein. Any holder of this document is advised that information contained hereon reflects the Company's findings at the time of its intervention only and within the limits of Client's instructions, if any. The Company's sole responsibility is to its Client and this document does not exonerate parties to a transaction from exercising all their rights and obligations under the transaction documents. This document cannot be reproduced except in full, without prior written approval of the Company. Any unauthorized alteration, forgery or falsification of the content or appearance of this document is unlawful and offenders may be prosecuted to the fullest extent of the law.

5 APPLICABLE STANDARDS

Table 1: Applicability of DFS requirements prior to use of a channel

Requirement	Operational Mode		
	Master	Client(without radar detection)	Client(with radar detection)
Non-occupancy Period	Yes	Not required	Yes
DFS Detection Threshold	Yes	Not required	Yes
Channel Availability Check Time	Yes	Not required	Not required
U-NII Detection Bandwidth	Yes	Not required	Yes

Table 2: Applicability of DFS requirements during normal operation

Requirement	Operational Mode	
	Master Device or Client with Radar Detection	Client Without Radar Detection
DFS Detection Threshold	Yes	Not required
Channel Closing Transmission time	Yes	Yes
Channel Move time	Yes	Yes
U-NII Detection Bandwidth	Yes	Not required

Unless otherwise stated the results shown in this test report refer only to the sample(s) tested and such sample(s) are retained for 90 days only.

除非另有說明，此報告結果僅對測試之樣品負責，同時此樣品僅保留90天。本報告未經本公司書面許可，不可部份複製。

This document is issued by the Company subject to its General Conditions of Service printed overleaf, available on request or accessible at <http://www.sgs.com.tw/Terms-and-Conditions> and for electronic format documents, subject to Terms and Conditions for Electronic Documents at <http://www.sgs.com.tw/Terms-and-Conditions>. Attention is drawn to the limitation of liability, indemnification and jurisdiction issues defined therein. Any holder of this document is advised that information contained hereon reflects the Company's findings at the time of its intervention only and within the limits of Client's instructions, if any. The Company's sole responsibility is to its Client and this document does not exonerate parties to a transaction from exercising all their rights and obligations under the transaction documents. This document cannot be reproduced except in full, without prior written approval of the Company. Any unauthorized alteration, forgery or falsification of the content or appearance of this document is unlawful and offenders may be prosecuted to the fullest extent of the law.

Additional requirements for devices with multiple bandwidth mode	Master Device or Client with Radar Detection	Client Without Radar Detection
U-NII Detection Bandwidth and Statistical Performance Check	All BW modes must be tested	Not required
Channel Move Time and Channel Closing Transmission Time	Test using widest BW mode available	Test using the widest BW mode available for the link
All other tests	Any single BW mode	Not required
<p>Note: Frequencies selected for statistical performance check (Section 7.8.4) should include several frequencies within the radar detection bandwidth and frequencies near the edge of the radar detection bandwidth. For 802.11 devices it is suggested to select frequencies in each of the bonded 20 MHz channels and the channel center frequency.</p>		

Table 3: Interference Threshold values, Master or Client incorporating In-Service Monitoring

Maximum Transmit Power	Value (See Notes 1, 2, and 3)
EIRP ≥ 200 milliwatt	-64 dBm
EIRP < 200 milliwatt and power spectral density < 10 dBm/MHz	-62 dBm
EIRP < 200 milliwatt that do not meet the power spectral density requirement	-64 dBm
<p>Note 1: This is the level at the input of the receiver assuming a 0 dBi receive antenna. Note 2: Throughout these test procedures an additional 1 dB has been added to the amplitude of the test transmission waveforms to account for variations in measurement equipment. This will ensure that the test signal is at or above the detection threshold level to trigger a DFS response. Note3: EIRP is based on the highest antenna gain. For MIMO devices refer to KDB Publication 662911 D01.</p>	

Unless otherwise stated the results shown in this test report refer only to the sample(s) tested and such sample(s) are retained for 90 days only.

除非另有說明，此報告結果僅對測試之樣品負責，同時此樣品僅保留90天。本報告未經本公司書面許可，不可部份複製。

This document is issued by the Company subject to its General Conditions of Service printed overleaf, available on request or accessible at <http://www.sgs.com.tw/Terms-and-Conditions> and for electronic format documents, subject to Terms and Conditions for Electronic Documents at <http://www.sgs.com.tw/Terms-and-Conditions>. Attention is drawn to the limitation of liability, indemnification and jurisdiction issues defined therein. Any holder of this document is advised that information contained hereon reflects the Company's findings at the time of its intervention only and within the limits of Client's instructions, if any. The Company's sole responsibility is to its Client and this document does not exonerate parties to a transaction from exercising all their rights and obligations under the transaction documents. This document cannot be reproduced except in full, without prior written approval of the Company. Any unauthorized alteration, forgery or falsification of the content or appearance of this document is unlawful and offenders may be prosecuted to the fullest extent of the law.

Table 4: DFS Response requirement values

Parameter	Value
Non-occupancy period	Minimum 30 minutes
Channel Availability Check Time	60 seconds
Channel Move Time	10 seconds See Note 1.
Channel Closing Transmission Time	200 milliseconds + an aggregate of 60 milliseconds over remaining 10 second period. See Notes 1 and 2.
U-NII Detection Bandwidth	Minimum 100% of the U-NII 99% transmission power bandwidth. See Note 3.
<p>Note 1: Channel Move Time and the Channel Closing Transmission Time should be performed with Radar Type 0. The measurement timing begins at the end of the Radar Type 0 burst.</p> <p>Note 2: The Channel Closing Transmission Time is comprised of 200 milliseconds starting at the beginning of the Channel Move Time plus any additional intermittent control signals required to facilitate a Channel move (an aggregate of 60 milliseconds) during the remainder of the 10 second period. The aggregate duration of control signals will not count quiet periods in between transmissions.</p> <p>Note 3: During the U-NII Detection Bandwidth detection test, radar type 0 should be used. For each frequency step the minimum percentage of detection is 90 percent. Measurements are performed with no data traffic.</p>	

Unless otherwise stated the results shown in this test report refer only to the sample(s) tested and such sample(s) are retained for 90 days only.

除非另有說明，此報告結果僅對測試之樣品負責，同時此樣品僅保留90天。本報告未經本公司書面許可，不可部份複製。

This document is issued by the Company subject to its General Conditions of Service printed overleaf, available on request or accessible at <http://www.sgs.com.tw/Terms-and-Conditions> and for electronic format documents, subject to Terms and Conditions for Electronic Documents at <http://www.sgs.com.tw/Terms-and-Conditions>. Attention is drawn to the limitation of liability, indemnification and jurisdiction issues defined therein. Any holder of this document is advised that information contained hereon reflects the Company's findings at the time of its intervention only and within the limits of Client's instructions, if any. The Company's sole responsibility is to its Client and this document does not exonerate parties to a transaction from exercising all their rights and obligations under the transaction documents. This document cannot be reproduced except in full, without prior written approval of the Company. Any unauthorized alteration, forgery or falsification of the content or appearance of this document is unlawful and offenders may be prosecuted to the fullest extent of the law.

**Table 5: Radar Test Waveforms
Short Pulse Radar**

Radar Type	Pulse Width (μsec)	PRI (μsec)	Number of Pulses	Minimum Percentage of Successful Detection	Minimum Number of Trials
0	1	1428	18	See Note 1	See Note 1
1	1	Test A: 15 unique PRI values randomly selected from the list of 23 PRI values in Table 5a Test B: 15 unique PRI values randomly selected within the range of 518-3066 μsec, with a minimum increment of 1 μsec, excluding PRI values selected in Test A	Roundup $\left\{ \begin{array}{l} \left(\frac{1}{360} \right) \\ \left(\frac{19 \cdot 10^6}{\text{PRI}_{\mu\text{SEC}}} \right) \end{array} \right\}$	60%	30
2	1-5	150-230	23-29	60%	30
3	6-10	200-500	16-18	60%	30
4	11-20	200-500	12-16	60%	30
Aggregate (Radar Types 1-4)				80%	120
Note 1: Short Pulse Radar Type 0 should be used for the detection bandwidth test, channel move time, and channel closing time tests.					

Long Pulse Radar

Radar Type	Pulse Width (μsec)	Chirp Width (MHz)	PRI (μsec)	Number of Pulses per Burst	Number of Bursts	Minimum Percentage of Successful Detection	Minimum Number of Trials
5	50-100	5-20	1000-2000	1-3	8-20	80%	30

Frequency Hopping Radar

Radar Type	Pulse Width (μsec)	PRI (μsec)	Pulses per Hop	Hopping Rate (kHz)	Hopping Sequence Length (msec)	Minimum Percentage of Successful Detection	Minimum Number of Trials
6	1	333	9	0.333	300	70%	30

The applicant of this given application confirms that information regarding the parameters of the detected Radar Waveforms is not available to the end user.

Unless otherwise stated the results shown in this test report refer only to the sample(s) tested and such sample(s) are retained for 90 days only.

除非另有說明，此報告結果僅對測試之樣品負責，同時此樣品僅保留90天。本報告未經本公司書面許可，不可部份複製。

This document is issued by the Company subject to its General Conditions of Service printed overleaf, available on request or accessible at <http://www.sgs.com.tw/Terms-and-Conditions> and for electronic format documents, subject to Terms and Conditions for Electronic Documents at <http://www.sgs.com.tw/Terms-and-Conditions>. Attention is drawn to the limitation of liability, indemnification and jurisdiction issues defined therein. Any holder of this document is advised that information contained hereon reflects the Company's findings at the time of its intervention only and within the limits of Client's instructions, if any. The Company's sole responsibility is to its Client and this document does not exonerate parties to a transaction from exercising all their rights and obligations under the transaction documents. This document cannot be reproduced except in full, without prior written approval of the Company. Any unauthorized alteration, forgery or falsification of the content or appearance of this document is unlawful and offenders may be prosecuted to the fullest extent of the law.

6 TEST SETUP

Setup for Master with injection at the Master

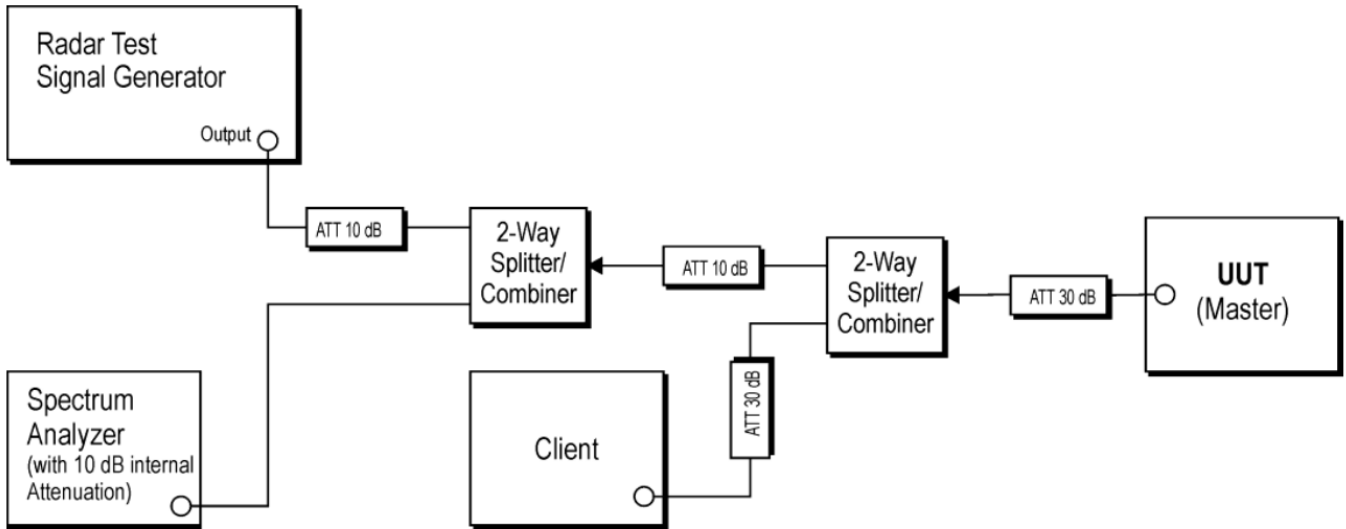

7 TEST EQUIPMENT USED:

Conducted Emission Test Site					
EQUIPMENT TYPE	MFR	MODEL NUMBER	SERIAL NUMBER	LAST CAL.	CAL DUE.
EMI Receiver	KEYSIGHT	N9038A	MY52260216	12/01/2020	11/30/2021
Signal Generator	KEYSIGHT	N5182B	MY59100873	06/26/2020	06/25/2021
Power Divider	Agilent	11636B	56355	12/16/2020	12/15/2021
Power Divider	Agilent	11636B	59355	12/16/2020	12/15/2021
Attenuator	Woken	WRF53AYM2B 7	RF08	11/19/2020	11/18/2021
Splitter	Marvelous Microwave	MVE8576	RF257	11/19/2020	11/18/2021
Splitter	Woken	DOM35LW1A2	RF258	11/19/2020	11/18/2021
RF Module	Intel	AX200NGW	50EB717946EF	N/A	N/A

Unless otherwise stated the results shown in this test report refer only to the sample(s) tested and such sample(s) are retained for 90 days only.

除非另有說明，此報告結果僅對測試之樣品負責，同時此樣品僅保留90天。本報告未經本公司書面許可，不可部份複製。

This document is issued by the Company subject to its General Conditions of Service printed overleaf, available on request or accessible at <http://www.sgs.com.tw/Terms-and-Conditions> and for electronic format documents, subject to Terms and Conditions for Electronic Documents at <http://www.sgs.com.tw/Terms-and-Conditions>. Attention is drawn to the limitation of liability, indemnification and jurisdiction issues defined therein. Any holder of this document is advised that information contained hereon reflects the Company's findings at the time of its intervention only and within the limits of Client's instructions, if any. The Company's sole responsibility is to its Client and this document does not exonerate parties to a transaction from exercising all their rights and obligations under the transaction documents. This document cannot be reproduced except in full, without prior written approval of the Company. Any unauthorized alteration, forgery or falsification of the content or appearance of this document is unlawful and offenders may be prosecuted to the fullest extent of the law.

8 DESCRIPTION OF EUT:

EUT operates over the 5250-5350MHz and 5470-5725MHz ranges and EUT is a Master device with radar detection and DFS capability.

UNII-Band	
	UNII-2A (5250-5350 MHz)
	UNII-2C (5470-5725 MHz)

The EUT utilizes the 802.11ac architecture. Three nominal channel bandwidths are implemented: 20 MHz, 40 MHz and 80 MHz.

Timing plots are required with calculations demonstrating a minimum channel loading of approximately 17% or greater.

EUT has TPC mechanism implemented, the level of output power is adjustable.

The rated output power of the master unit is >23 dBm(EIRP).therefore the required interference threshold level is -64dBm.after correction for antenna gain and procedural adjustments, the required threshold at the antenna port is -61dBm.

While calibrate the path on antenna port of DFS test equipment (master), measurements equipments (spectrum) is ensured to be 50 Ohms, and therefore verification on antenna gain measurement can be ignored.

The EUT uses one transmitter/receiver chains and one receive only chain, each connected to an antenna to perform radiated tests.

The Slave device associated with the EUT during these tests does not have radar detection capability.

The software installed in the access point is firmware-venom-arm revision:
CBV384Z4_0167_19230.M.156tnvram

Unless otherwise stated the results shown in this test report refer only to the sample(s) tested and such sample(s) are retained for 90 days only.

除非另有說明，此報告結果僅對測試之樣品負責，同時此樣品僅保留90天。本報告未經本公司書面許可，不可部份複製。

This document is issued by the Company subject to its General Conditions of Service printed overleaf, available on request or accessible at <http://www.sgs.com.tw/Terms-and-Conditions> and for electronic format documents, subject to Terms and Conditions for Electronic Documents at <http://www.sgs.com.tw/Terms-and-Conditions>. Attention is drawn to the limitation of liability, indemnification and jurisdiction issues defined therein. Any holder of this document is advised that information contained hereon reflects the Company's findings at the time of its intervention only and within the limits of Client's instructions, if any. The Company's sole responsibility is to its Client and this document does not exonerate parties to a transaction from exercising all their rights and obligations under the transaction documents. This document cannot be reproduced except in full, without prior written approval of the Company. Any unauthorized alteration, forgery or falsification of the content or appearance of this document is unlawful and offenders may be prosecuted to the fullest extent of the law.

9 RADAR TYPE WAVEFORM CALIBRATION AT DFS DECTION THRESHOLD

9.15290MHz

Radar type 0

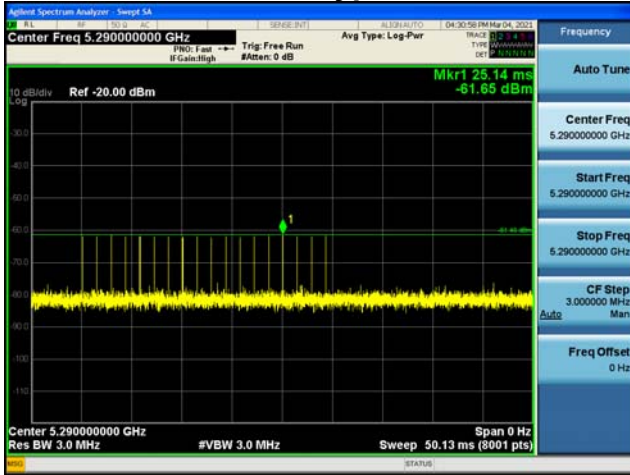

Radar type 2

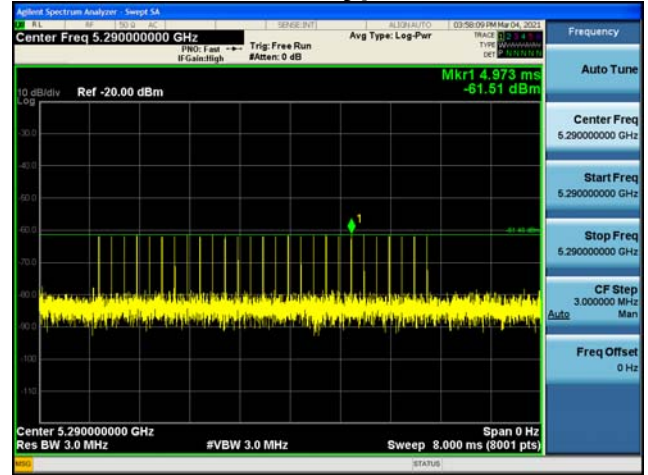

Radar type 1-A

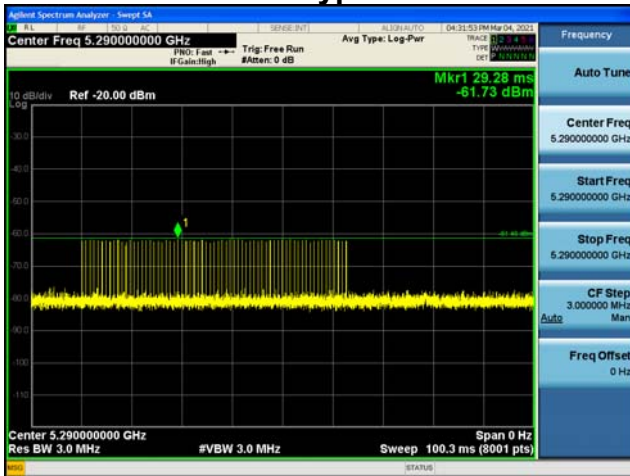

Radar type 3

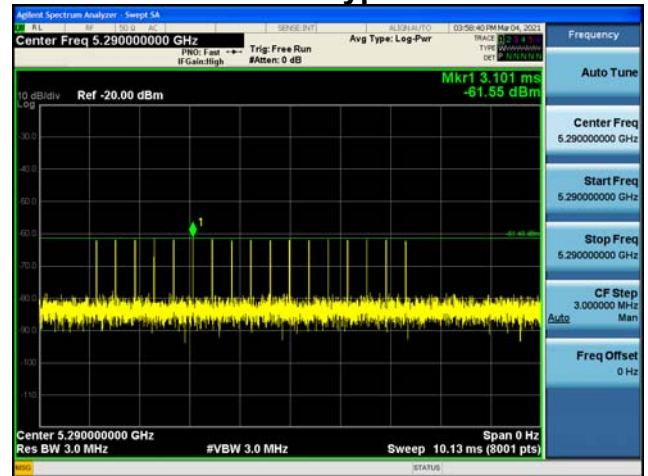

Radar type 1-B

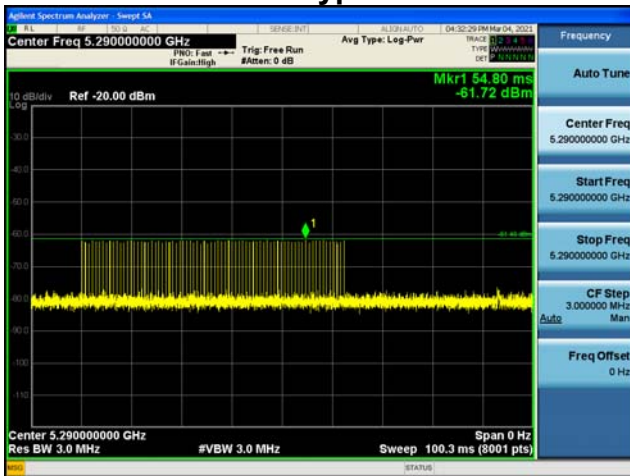

Radar type 4

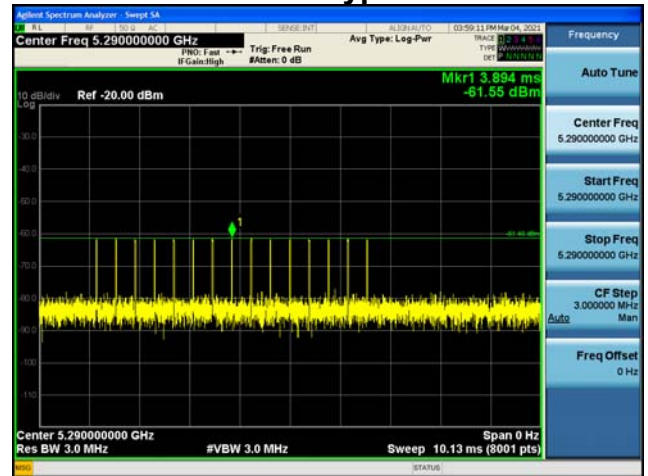

Unless otherwise stated the results shown in this test report refer only to the sample(s) tested and such sample(s) are retained for 90 days only.

除非另有說明，此報告結果僅對測試之樣品負責，同時此樣品僅保留90天。本報告未經本公司書面許可，不可部份複製。

This document is issued by the Company subject to its General Conditions of Service printed overleaf, available on request or accessible at <http://www.sgs.com.tw/Terms-and-Conditions> and for electronic format documents, subject to Terms and Conditions for Electronic Documents at <http://www.sgs.com.tw/Terms-and-Conditions>. Attention is drawn to the limitation of liability, indemnification and jurisdiction issues defined therein. Any holder of this document is advised that information contained hereon reflects the Company's findings at the time of its intervention only and within the limits of Client's instructions, if any. The Company's sole responsibility is to its Client and this document does not exonerate parties to a transaction from exercising all their rights and obligations under the transaction documents. This document cannot be reproduced except in full, without prior written approval of the Company. Any unauthorized alteration, forgery or falsification of the content or appearance of this document is unlawful and offenders may be prosecuted to the fullest extent of the law.

Radar type 5



Radar type 6

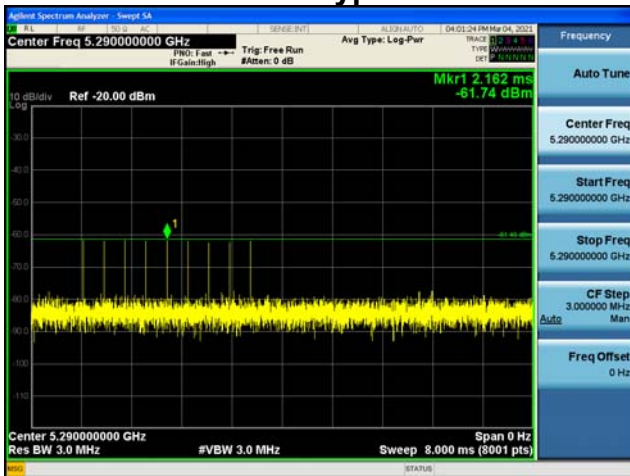

WLAN traffic

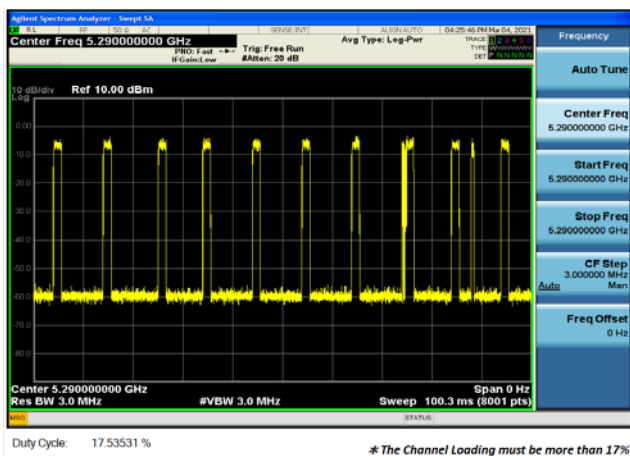

Unless otherwise stated the results shown in this test report refer only to the sample(s) tested and such sample(s) are retained for 90 days only.

除非另有說明，此報告結果僅對測試之樣品負責，同時此樣品僅保留90天。本報告未經本公司書面許可，不可部份複製。
This document is issued by the Company subject to its General Conditions of Service printed overleaf, available on request or accessible at <http://www.sgs.com.tw/Terms-and-Conditions> and for electronic format documents, subject to Terms and Conditions for Electronic Documents at <http://www.sgs.com.tw/Terms-and-Conditions>. Attention is drawn to the limitation of liability, indemnification and jurisdiction issues defined therein. Any holder of this document is advised that information contained hereon reflects the Company's findings at the time of its intervention only and within the limits of Client's instructions, if any. The Company's sole responsibility is to its Client and this document does not exonerate parties to a transaction from exercising all their rights and obligations under the transaction documents. This document cannot be reproduced except in full, without prior written approval of the Company. Any unauthorized alteration, forgery or falsification of the content or appearance of this document is unlawful and offenders may be prosecuted to the fullest extent of the law.

9.25310MHz

Radar type 0

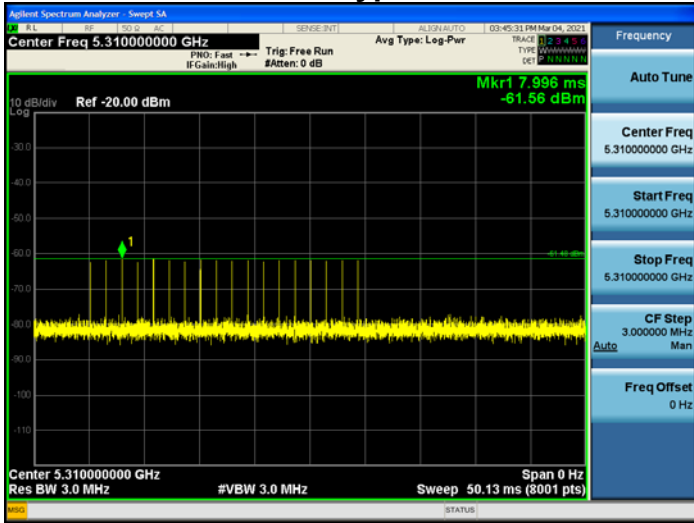

Radar type 2

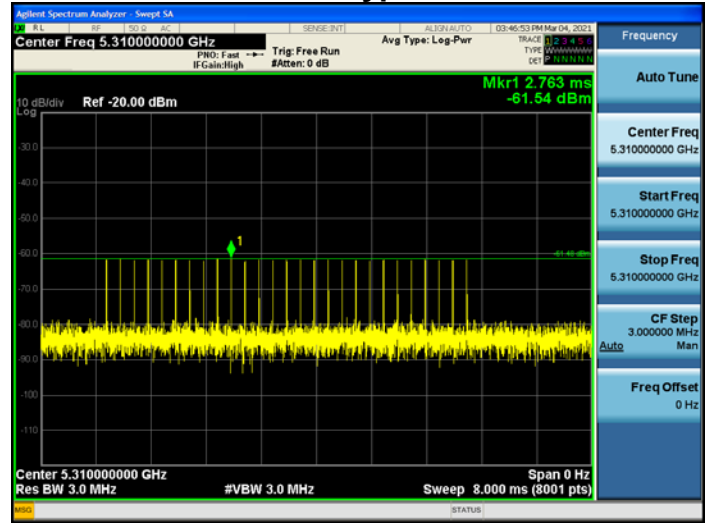

Radar type 1-A

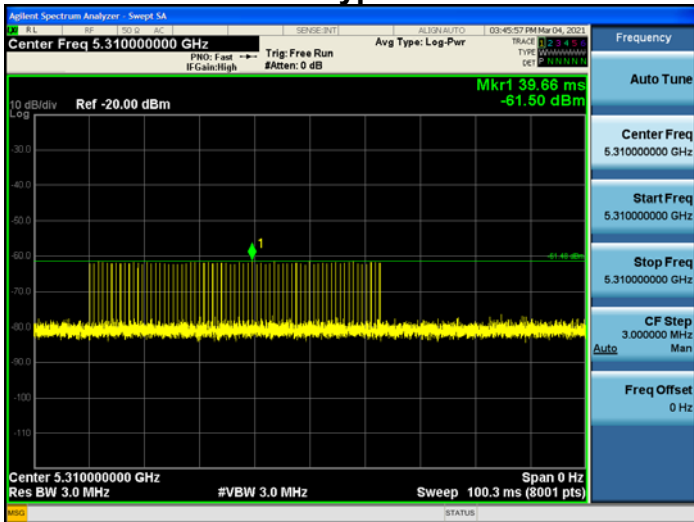

Radar type 3

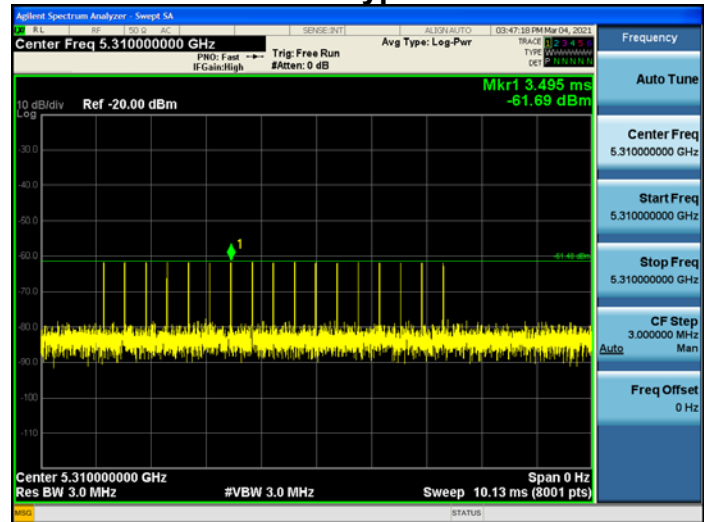

Radar type 1-B

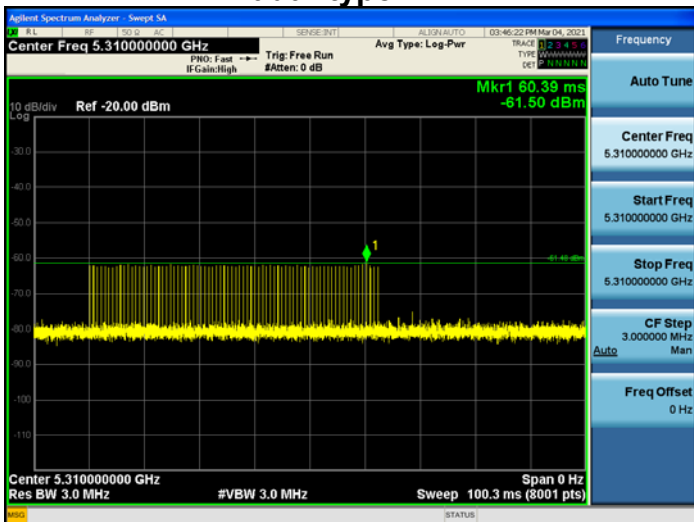

Radar type 4

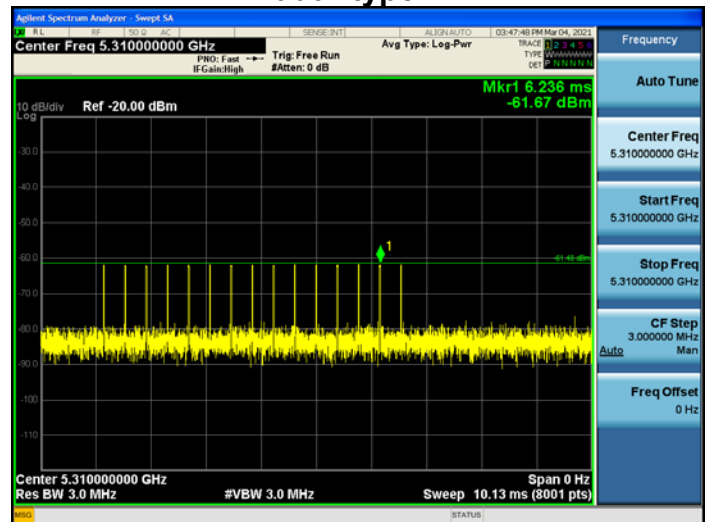

Unless otherwise stated the results shown in this test report refer only to the sample(s) tested and such sample(s) are retained for 90 days only.

除非另有說明，此報告結果僅對測試之樣品負責，同時此樣品僅保留90天。本報告未經本公司書面許可，不可部份複製。

This document is issued by the Company subject to its General Conditions of Service printed overleaf, available on request or accessible at <http://www.sgs.com.tw/Terms-and-Conditions> and for electronic format documents, subject to Terms and Conditions for Electronic Documents at <http://www.sgs.com.tw/Terms-and-Conditions>. Attention is drawn to the limitation of liability, indemnification and jurisdiction issues defined therein. Any holder of this document is advised that information contained hereon reflects the Company's findings at the time of its intervention only and within the limits of Client's instructions, if any. The Company's sole responsibility is to its Client and this document does not exonerate parties to a transaction from exercising all their rights and obligations under the transaction documents. This document cannot be reproduced except in full, without prior written approval of the Company. Any unauthorized alteration, forgery or falsification of the content or appearance of this document is unlawful and offenders may be prosecuted to the fullest extent of the law.

Radar type 5



WLAN traffic

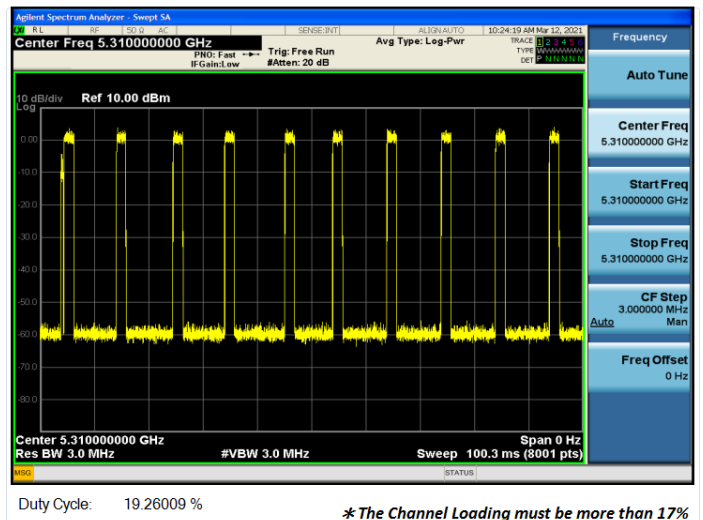

Radar type 6

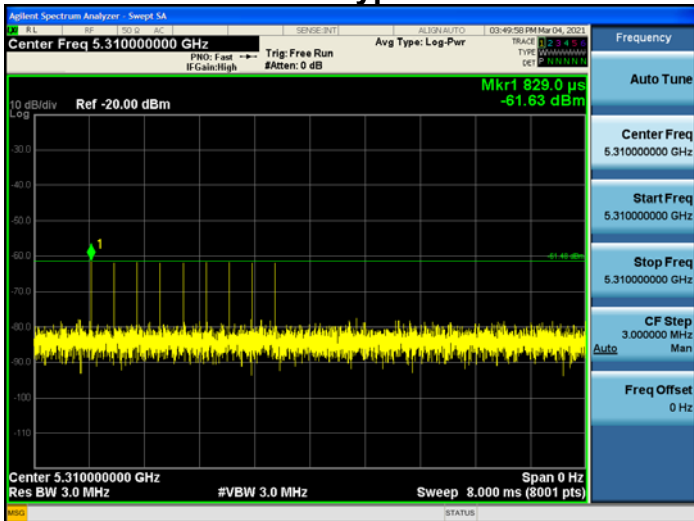

Unless otherwise stated the results shown in this test report refer only to the sample(s) tested and such sample(s) are retained for 90 days only.

除非另有說明，此報告結果僅對測試之樣品負責，同時此樣品僅保留90天。本報告未經本公司書面許可，不可部份複製。

This document is issued by the Company subject to its General Conditions of Service printed overleaf, available on request or accessible at <http://www.sgs.com.tw/Terms-and-Conditions> and for electronic format documents, subject to Terms and Conditions for Electronic Documents at <http://www.sgs.com.tw/Terms-and-Conditions>. Attention is drawn to the limitation of liability, indemnification and jurisdiction issues defined therein. Any holder of this document is advised that information contained hereon reflects the Company's findings at the time of its intervention only and within the limits of Client's instructions, if any. The Company's sole responsibility is to its Client and this document does not exonerate parties to a transaction from exercising all their rights and obligations under the transaction documents. This document cannot be reproduced except in full, without prior written approval of the Company. Any unauthorized alteration, forgery or falsification of the content or appearance of this document is unlawful and offenders may be prosecuted to the fullest extent of the law.

9.35320MHz

Radar type 0

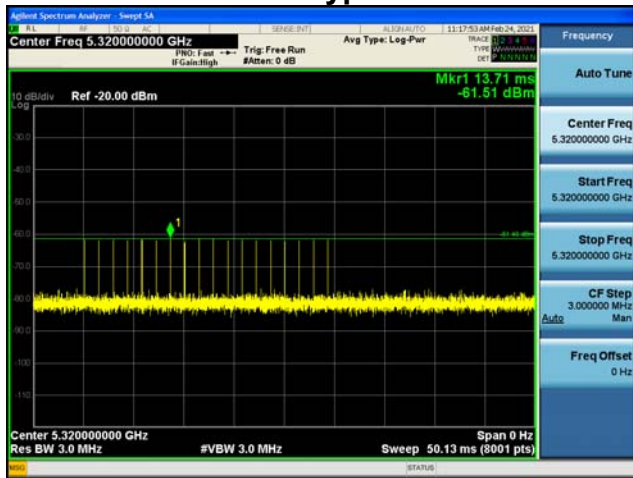

Radar type 2

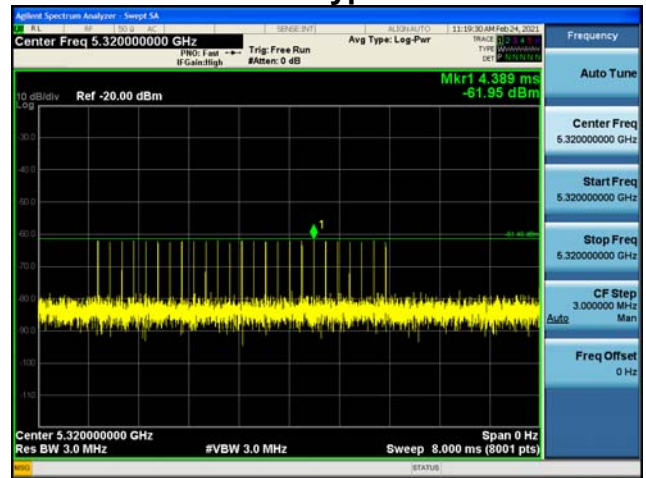

Radar type 1-A

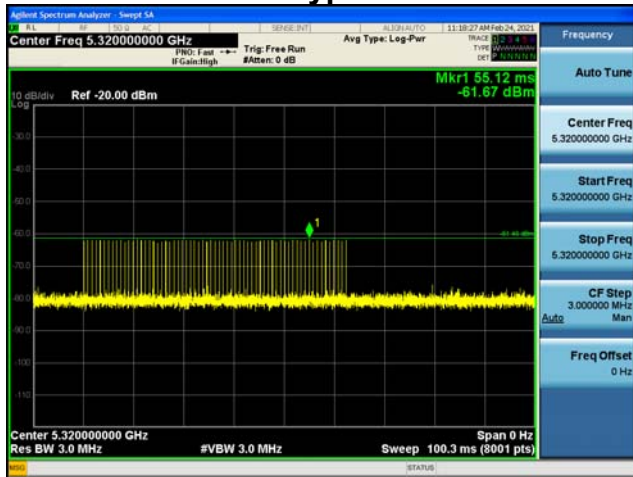

Radar type 3

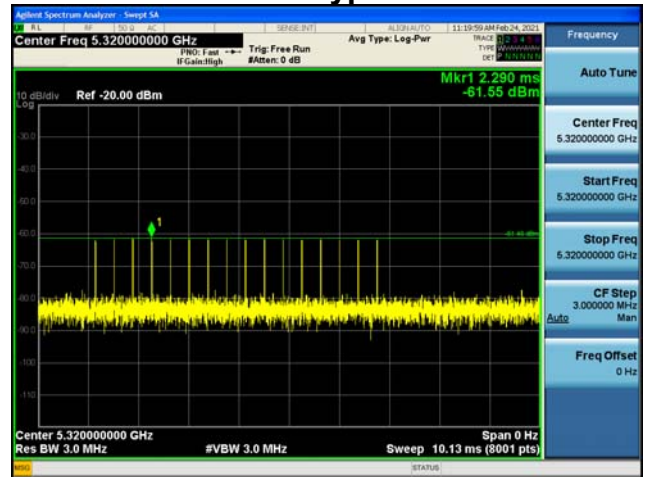

Radar type 1-B

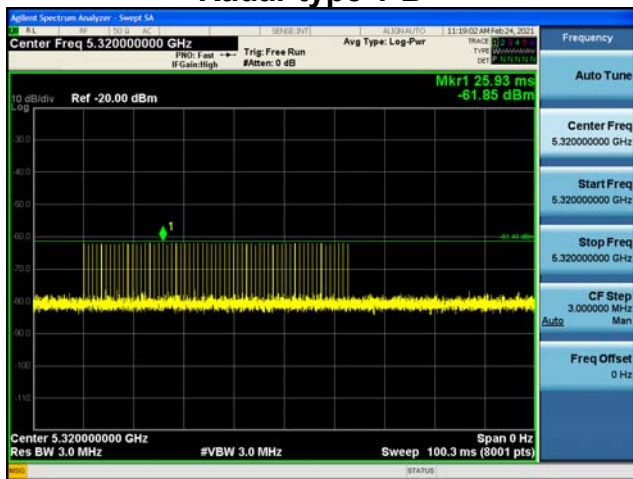

Radar type 4

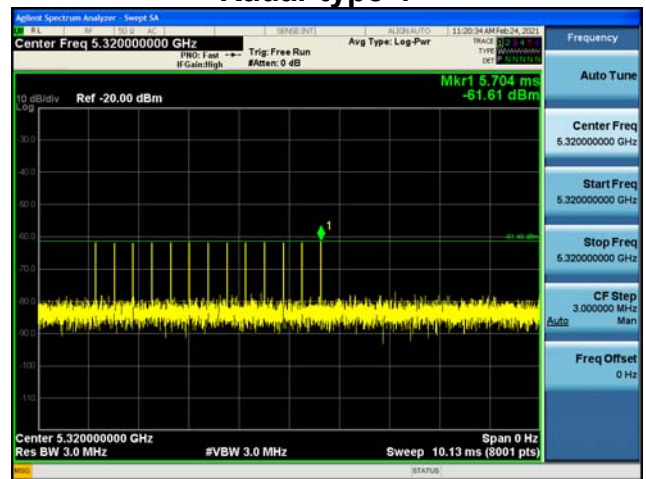

Unless otherwise stated the results shown in this test report refer only to the sample(s) tested and such sample(s) are retained for 90 days only.

除非另有說明，此報告結果僅對測試之樣品負責，同時此樣品僅保留90天。本報告未經本公司書面許可，不可部份複製。

This document is issued by the Company subject to its General Conditions of Service printed overleaf, available on request or accessible at <http://www.sgs.com.tw/Terms-and-Conditions> and for electronic format documents, subject to Terms and Conditions for Electronic Documents at <http://www.sgs.com.tw/Terms-and-Conditions>. Attention is drawn to the limitation of liability, indemnification and jurisdiction issues defined therein. Any holder of this document is advised that information contained hereon reflects the Company's findings at the time of its intervention only and within the limits of Client's instructions, if any. The Company's sole responsibility is to its Client and this document does not exonerate parties to a transaction from exercising all their rights and obligations under the transaction documents. This document cannot be reproduced except in full, without prior written approval of the Company. Any unauthorized alteration, forgery or falsification of the content or appearance of this document is unlawful and offenders may be prosecuted to the fullest extent of the law.

Radar type 5



WLAN traffic

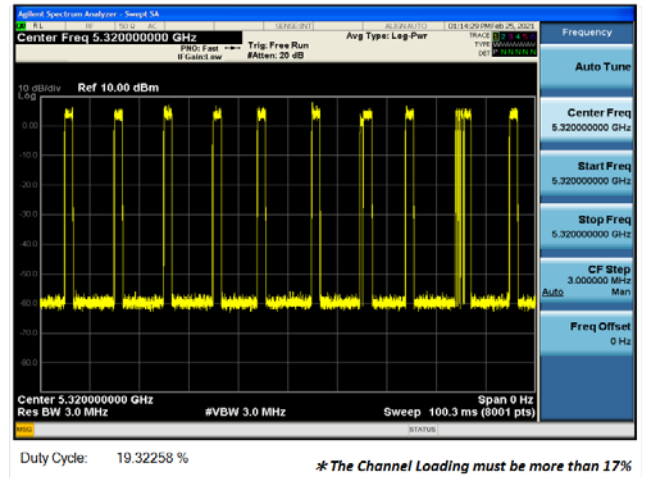

Radar type 6

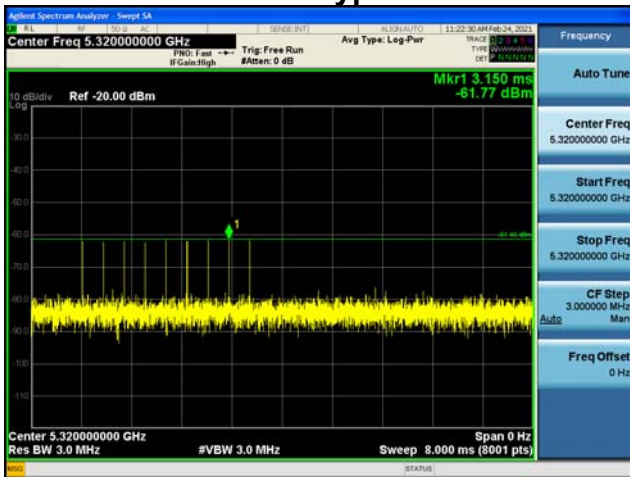

Unless otherwise stated the results shown in this test report refer only to the sample(s) tested and such sample(s) are retained for 90 days only.

除非另有說明，此報告結果僅對測試之樣品負責，同時此樣品僅保留90天。本報告未經本公司書面許可，不可部份複製。

This document is issued by the Company subject to its General Conditions of Service printed overleaf, available on request or accessible at <http://www.sgs.com.tw/Terms-and-Conditions> and for electronic format documents, subject to Terms and Conditions for Electronic Documents at <http://www.sgs.com.tw/Terms-and-Conditions>. Attention is drawn to the limitation of liability, indemnification and jurisdiction issues defined therein. Any holder of this document is advised that information contained hereon reflects the Company's findings at the time of its intervention only and within the limits of Client's instructions, if any. The Company's sole responsibility is to its Client and this document does not exonerate parties to a transaction from exercising all their rights and obligations under the transaction documents. This document cannot be reproduced except in full, without prior written approval of the Company. Any unauthorized alteration, forgery or falsification of the content or appearance of this document is unlawful and offenders may be prosecuted to the fullest extent of the law.

9.45500MHz

Radar type 0

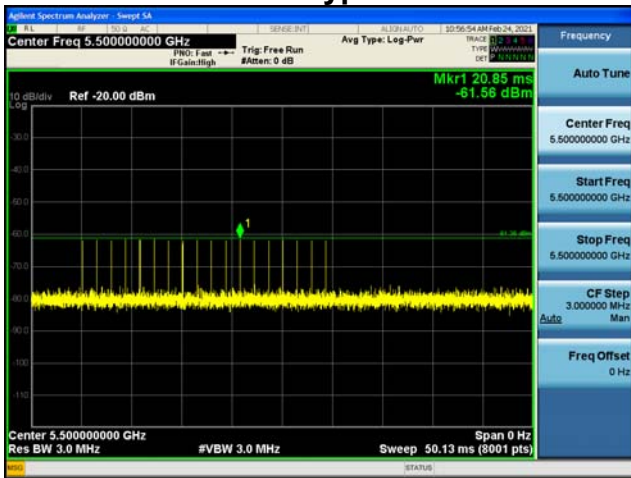

Radar type 2

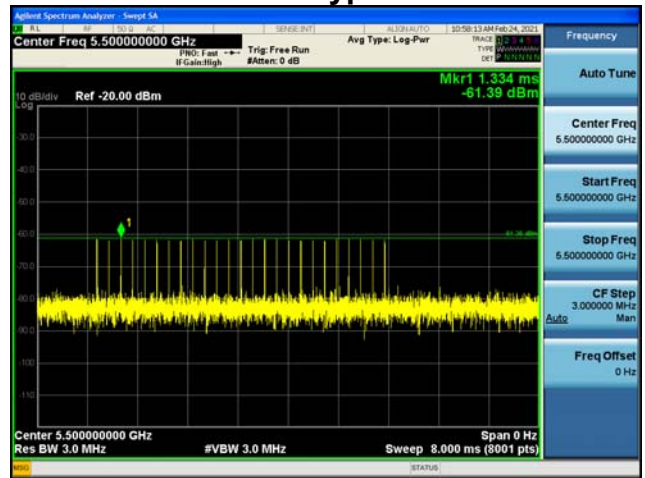

Radar type 1-A

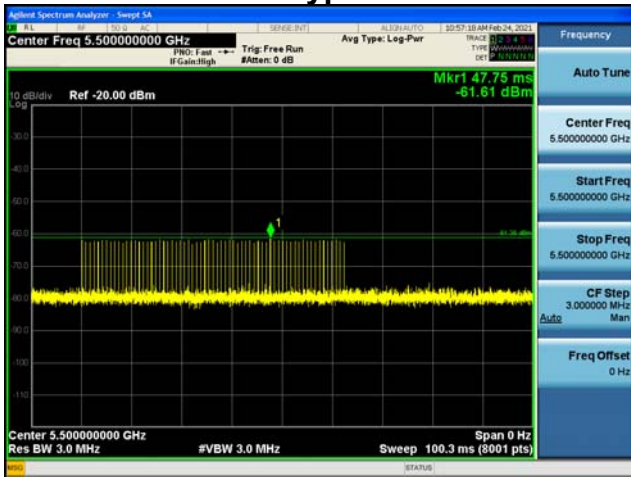

Radar type 3

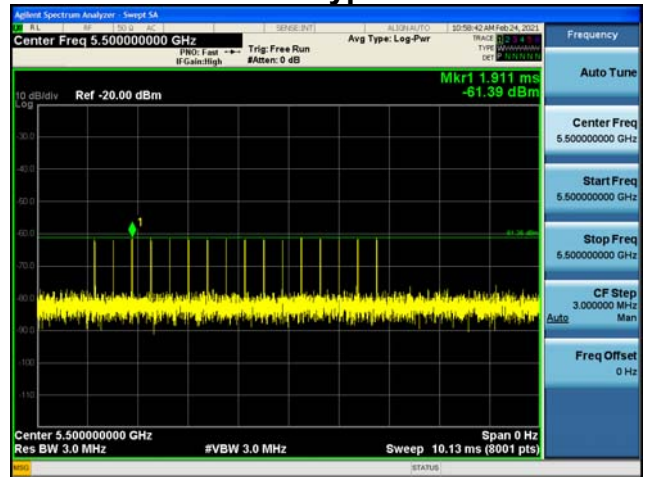

Radar type 1-B

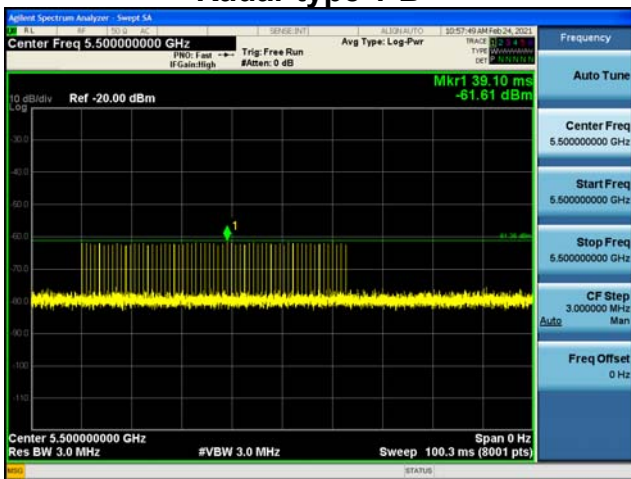

Radar type 4

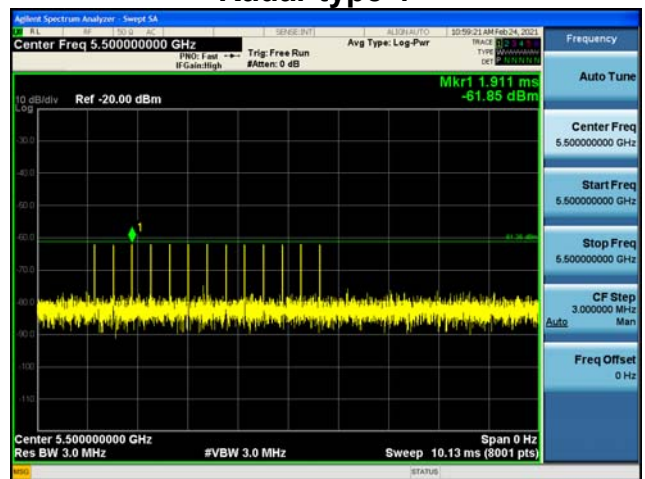

Unless otherwise stated the results shown in this test report refer only to the sample(s) tested and such sample(s) are retained for 90 days only.

除非另有說明，此報告結果僅對測試之樣品負責，同時此樣品僅保留90天。本報告未經本公司書面許可，不可部份複製。

This document is issued by the Company subject to its General Conditions of Service printed overleaf, available on request or accessible at <http://www.sgs.com.tw/Terms-and-Conditions> and for electronic format documents, subject to Terms and Conditions for Electronic Documents at <http://www.sgs.com.tw/Terms-and-Conditions>. Attention is drawn to the limitation of liability, indemnification and jurisdiction issues defined therein. Any holder of this document is advised that information contained hereon reflects the Company's findings at the time of its intervention only and within the limits of Client's instructions, if any. The Company's sole responsibility is to its Client and this document does not exonerate parties to a transaction from exercising all their rights and obligations under the transaction documents. This document cannot be reproduced except in full, without prior written approval of the Company. Any unauthorized alteration, forgery or falsification of the content or appearance of this document is unlawful and offenders may be prosecuted to the fullest extent of the law.

Radar type 5



WLAN traffic

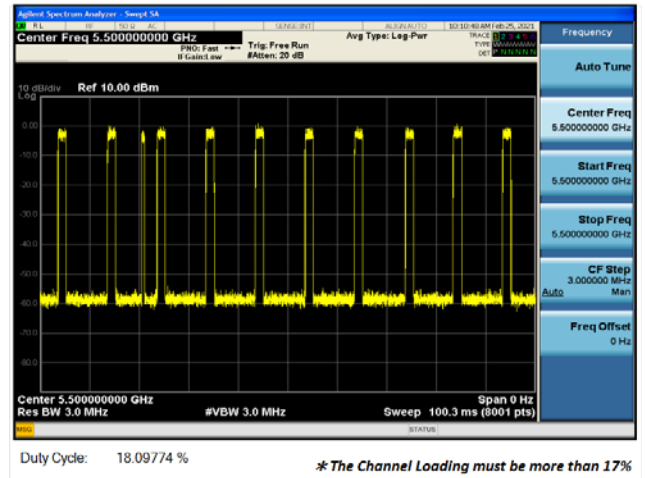

Radar type 6

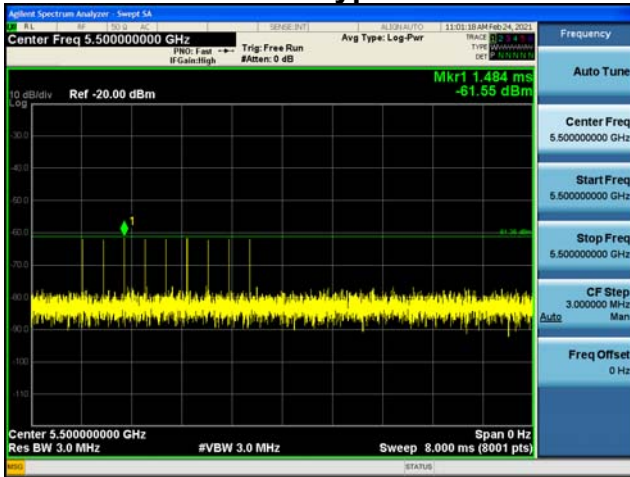

Unless otherwise stated the results shown in this test report refer only to the sample(s) tested and such sample(s) are retained for 90 days only.

除非另有說明，此報告結果僅對測試之樣品負責，同時此樣品僅保留90天。本報告未經本公司書面許可，不可部份複製。

This document is issued by the Company subject to its General Conditions of Service printed overleaf, available on request or accessible at <http://www.sgs.com.tw/Terms-and-Conditions> and for electronic format documents, subject to Terms and Conditions for Electronic Documents at <http://www.sgs.com.tw/Terms-and-Conditions>. Attention is drawn to the limitation of liability, indemnification and jurisdiction issues defined therein. Any holder of this document is advised that information contained hereon reflects the Company's findings at the time of its intervention only and within the limits of Client's instructions, if any. The Company's sole responsibility is to its Client and this document does not exonerate parties to a transaction from exercising all their rights and obligations under the transaction documents. This document cannot be reproduced except in full, without prior written approval of the Company. Any unauthorized alteration, forgery or falsification of the content or appearance of this document is unlawful and offenders may be prosecuted to the fullest extent of the law.

9.55510MHz

Radar type 0

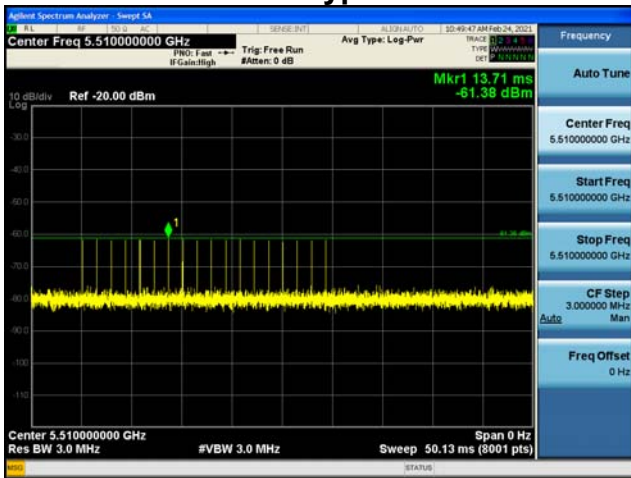

Radar type 2

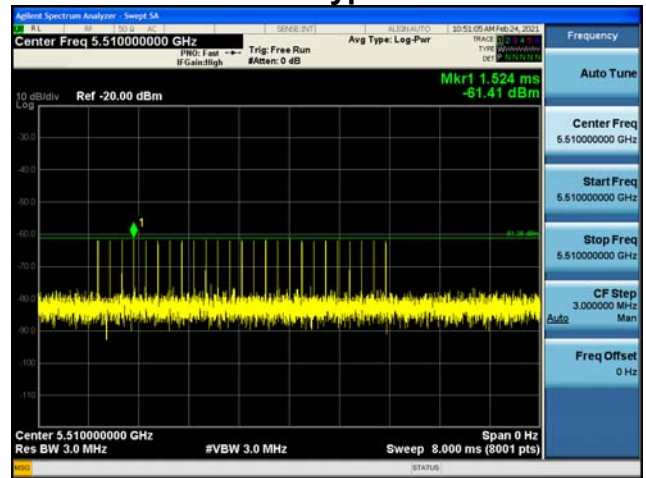

Radar type 1-A

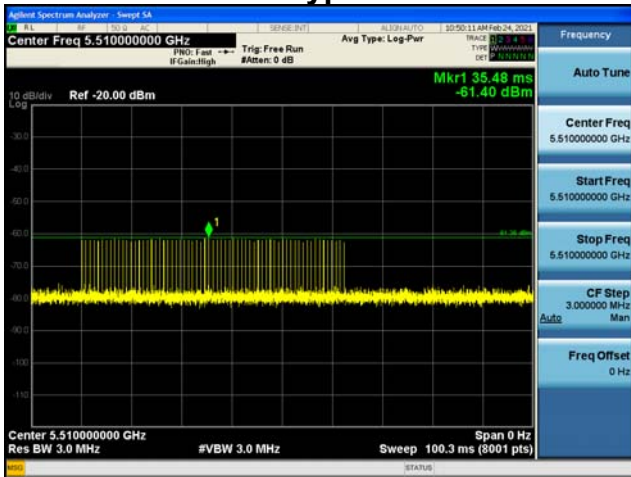

Radar type 3

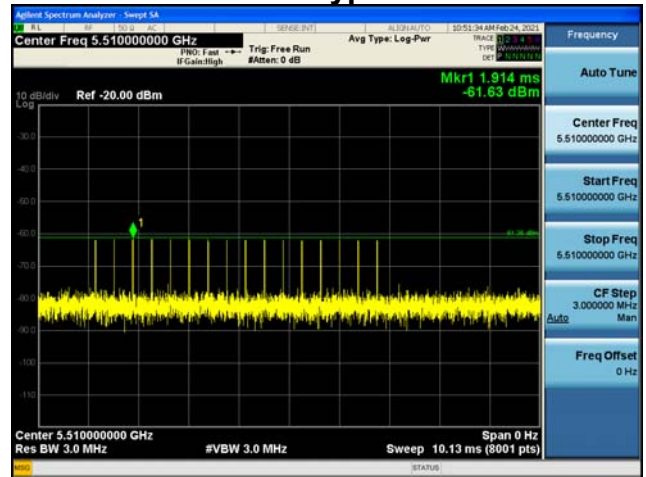

Radar type 1-B

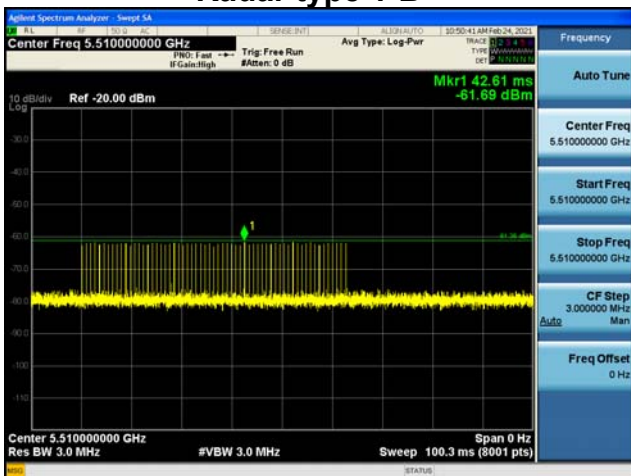

Radar type 4

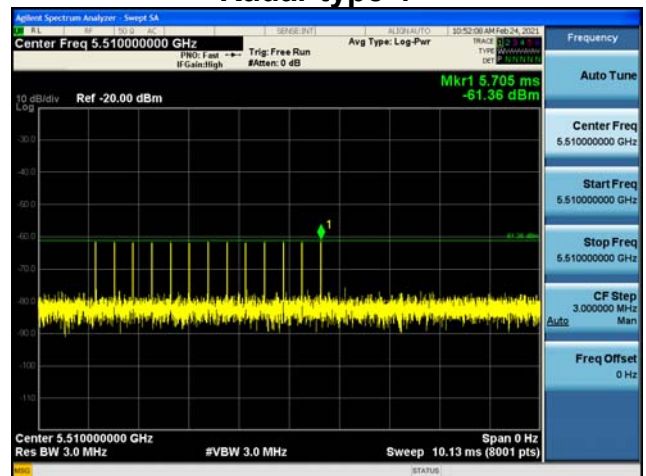

Unless otherwise stated the results shown in this test report refer only to the sample(s) tested and such sample(s) are retained for 90 days only.

除非另有說明，此報告結果僅對測試之樣品負責，同時此樣品僅保留90天。本報告未經本公司書面許可，不可部份複製。

This document is issued by the Company subject to its General Conditions of Service printed overleaf, available on request or accessible at <http://www.sgs.com.tw/Terms-and-Conditions> and for electronic format documents, subject to Terms and Conditions for Electronic Documents at <http://www.sgs.com.tw/Terms-and-Conditions>. Attention is drawn to the limitation of liability, indemnification and jurisdiction issues defined therein. Any holder of this document is advised that information contained hereon reflects the Company's findings at the time of its intervention only and within the limits of Client's instructions, if any. The Company's sole responsibility is to its Client and this document does not exonerate parties to a transaction from exercising all their rights and obligations under the transaction documents. This document cannot be reproduced except in full, without prior written approval of the Company. Any unauthorized alteration, forgery or falsification of the content or appearance of this document is unlawful and offenders may be prosecuted to the fullest extent of the law.

Radar type 5



WLAN traffic

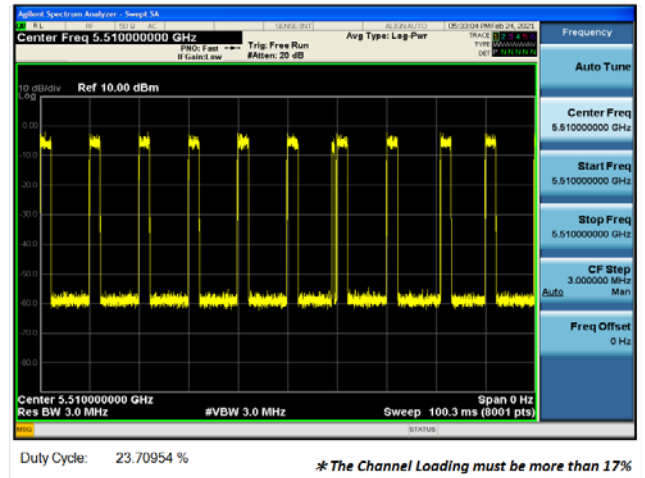

Radar type 6

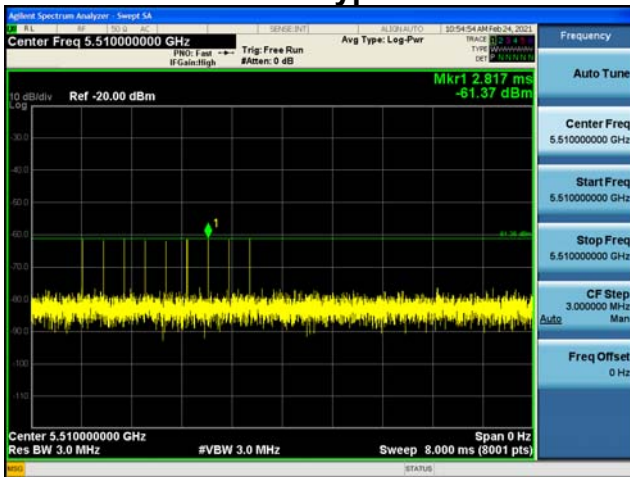

Unless otherwise stated the results shown in this test report refer only to the sample(s) tested and such sample(s) are retained for 90 days only.

除非另有說明，此報告結果僅對測試之樣品負責，同時此樣品僅保留90天。本報告未經本公司書面許可，不可部份複製。

This document is issued by the Company subject to its General Conditions of Service printed overleaf, available on request or accessible at <http://www.sgs.com.tw/Terms-and-Conditions> and for electronic format documents, subject to Terms and Conditions for Electronic Documents at <http://www.sgs.com.tw/Terms-and-Conditions>. Attention is drawn to the limitation of liability, indemnification and jurisdiction issues defined therein. Any holder of this document is advised that information contained hereon reflects the Company's findings at the time of its intervention only and within the limits of Client's instructions, if any. The Company's sole responsibility is to its Client and this document does not exonerate parties to a transaction from exercising all their rights and obligations under the transaction documents. This document cannot be reproduced except in full, without prior written approval of the Company. Any unauthorized alteration, forgery or falsification of the content or appearance of this document is unlawful and offenders may be prosecuted to the fullest extent of the law.

9.65530MHz

Radar type 0

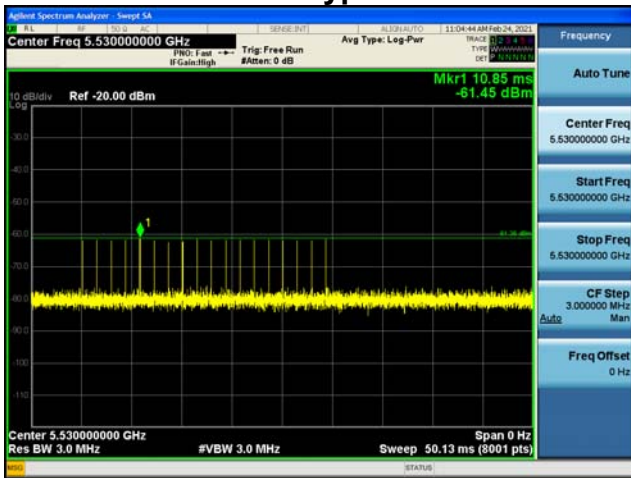

Radar type 2

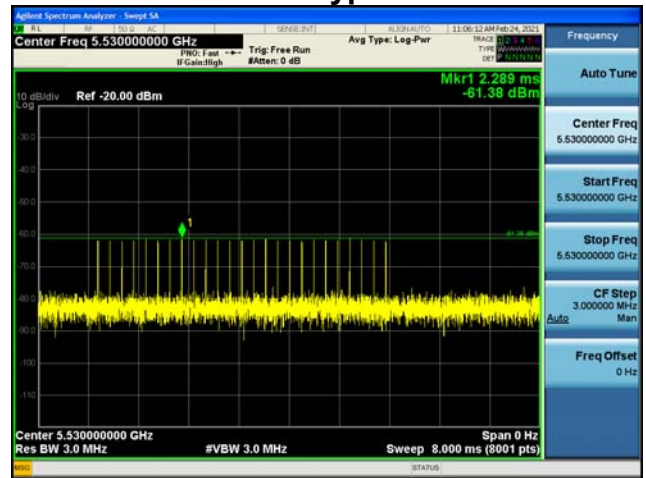

Radar type 1-A

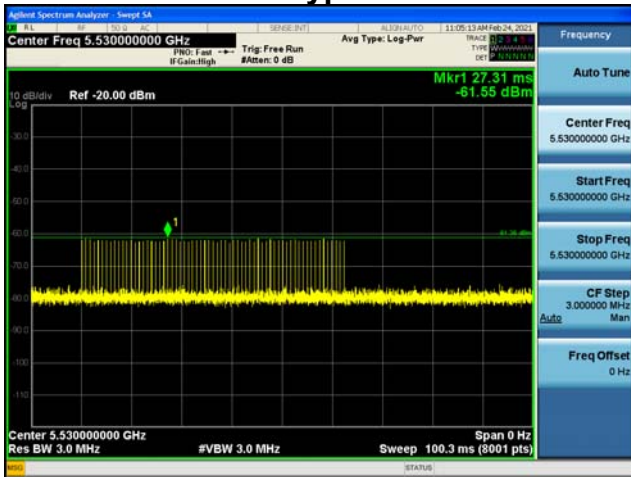

Radar type 3

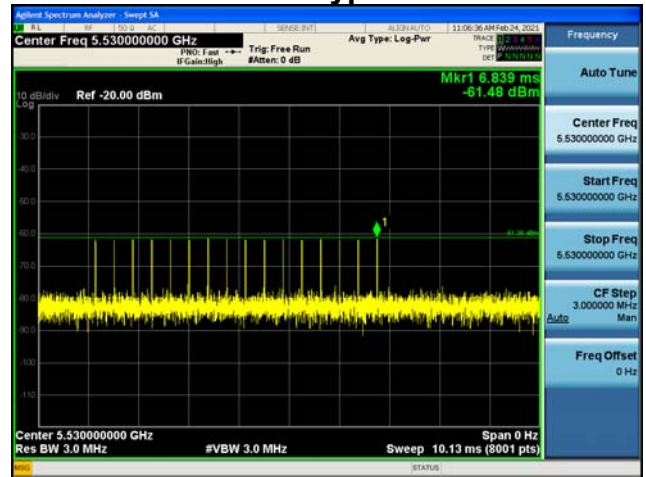

Radar type 1-B

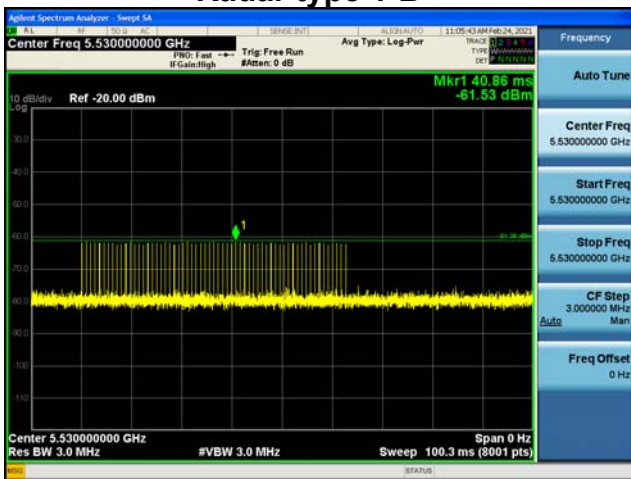

Radar type 4

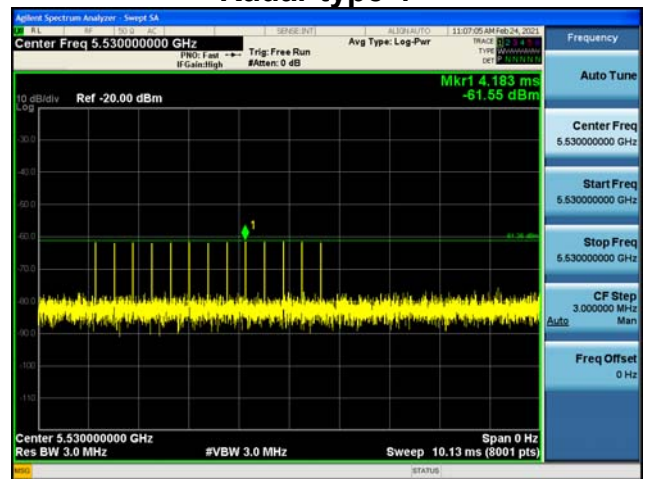

Unless otherwise stated the results shown in this test report refer only to the sample(s) tested and such sample(s) are retained for 90 days only.

除非另有說明，此報告結果僅對測試之樣品負責，同時此樣品僅保留90天。本報告未經本公司書面許可，不可部份複製。

This document is issued by the Company subject to its General Conditions of Service printed overleaf, available on request or accessible at <http://www.sgs.com.tw/Terms-and-Conditions> and for electronic format documents, subject to Terms and Conditions for Electronic Documents at <http://www.sgs.com.tw/Terms-and-Conditions>. Attention is drawn to the limitation of liability, indemnification and jurisdiction issues defined therein. Any holder of this document is advised that information contained hereon reflects the Company's findings at the time of its intervention only and within the limits of Client's instructions, if any. The Company's sole responsibility is to its Client and this document does not exonerate parties to a transaction from exercising all their rights and obligations under the transaction documents. This document cannot be reproduced except in full, without prior written approval of the Company. Any unauthorized alteration, forgery or falsification of the content or appearance of this document is unlawful and offenders may be prosecuted to the fullest extent of the law.

Radar type 5



WLAN traffic

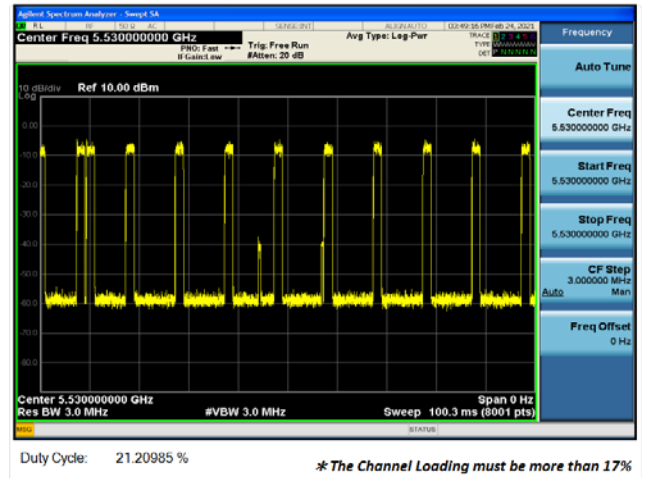

Radar type 6

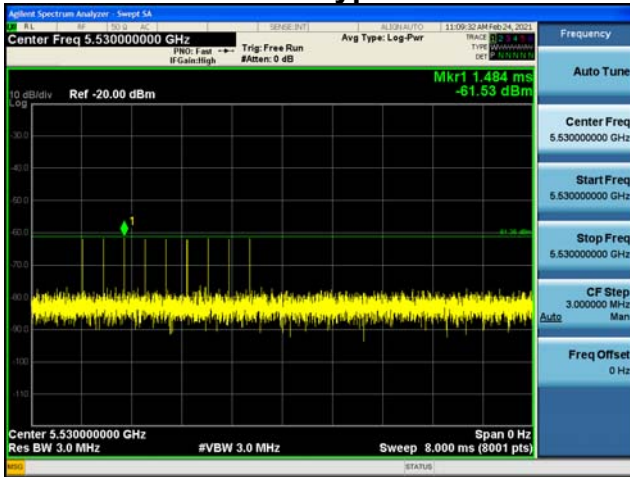

Unless otherwise stated the results shown in this test report refer only to the sample(s) tested and such sample(s) are retained for 90 days only.

除非另有說明，此報告結果僅對測試之樣品負責，同時此樣品僅保留90天。本報告未經本公司書面許可，不可部份複製。

This document is issued by the Company subject to its General Conditions of Service printed overleaf, available on request or accessible at <http://www.sgs.com.tw/Terms-and-Conditions> and for electronic format documents, subject to Terms and Conditions for Electronic Documents at <http://www.sgs.com.tw/Terms-and-Conditions>. Attention is drawn to the limitation of liability, indemnification and jurisdiction issues defined therein. Any holder of this document is advised that information contained hereon reflects the Company's findings at the time of its intervention only and within the limits of Client's instructions, if any. The Company's sole responsibility is to its Client and this document does not exonerate parties to a transaction from exercising all their rights and obligations under the transaction documents. This document cannot be reproduced except in full, without prior written approval of the Company. Any unauthorized alteration, forgery or falsification of the content or appearance of this document is unlawful and offenders may be prosecuted to the fullest extent of the law.

10 CHANNEL CLOSING TRANSMISSION AND CHANNEL MOVE TIME MEASUREMENT (RADAR TYPE 0)

10.1 5290MHz

Channel Move Time

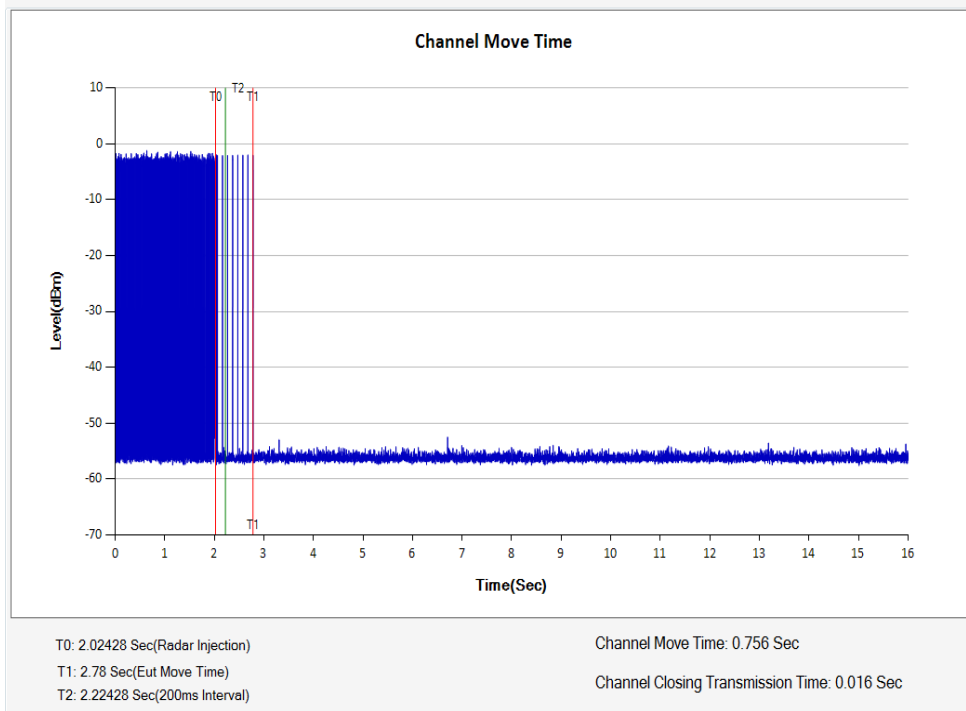

Channel Closing Transmission Time

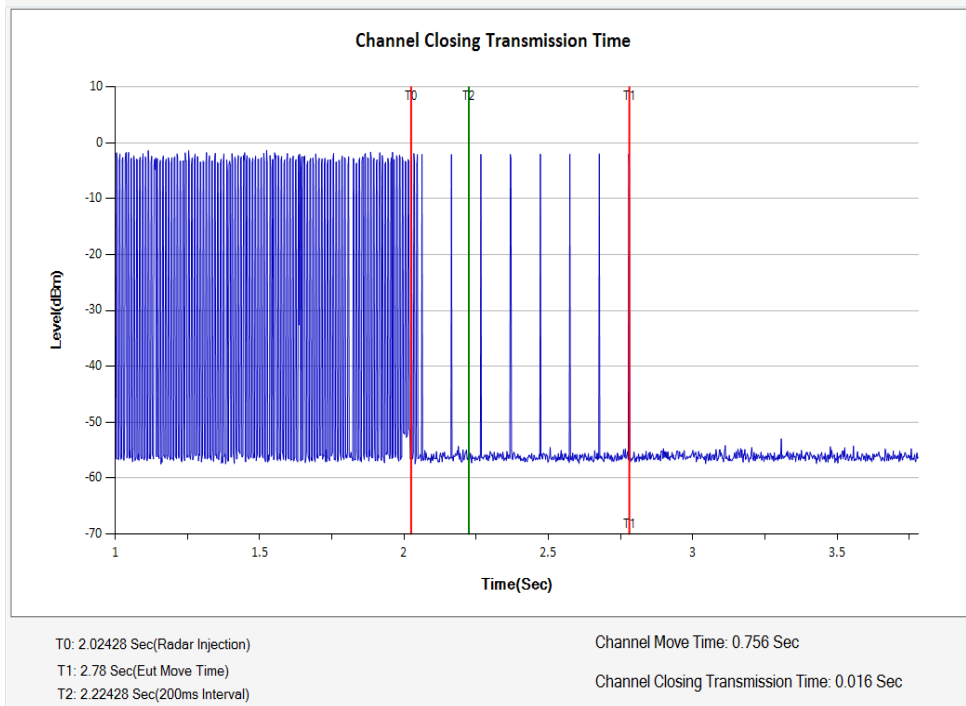

Unless otherwise stated the results shown in this test report refer only to the sample(s) tested and such sample(s) are retained for 90 days only.

除非另有說明，此報告結果僅對測試之樣品負責，同時此樣品僅保留90天。本報告未經本公司書面許可，不可部份複製。

This document is issued by the Company subject to its General Conditions of Service printed overleaf, available on request or accessible at <http://www.sgs.com.tw/Terms-and-Conditions> and for electronic format documents, subject to Terms and Conditions for Electronic Documents at <http://www.sgs.com.tw/Terms-and-Conditions>. Attention is drawn to the limitation of liability, indemnification and jurisdiction issues defined therein. Any holder of this document is advised that information contained hereon reflects the Company's findings at the time of its intervention only and within the limits of Client's instructions, if any. The Company's sole responsibility is to its Client and this document does not exonerate parties to a transaction from exercising all their rights and obligations under the transaction documents. This document cannot be reproduced except in full, without prior written approval of the Company. Any unauthorized alteration, forgery or falsification of the content or appearance of this document is unlawful and offenders may be prosecuted to the fullest extent of the law.

10.2 5530MHz Channel Move Time

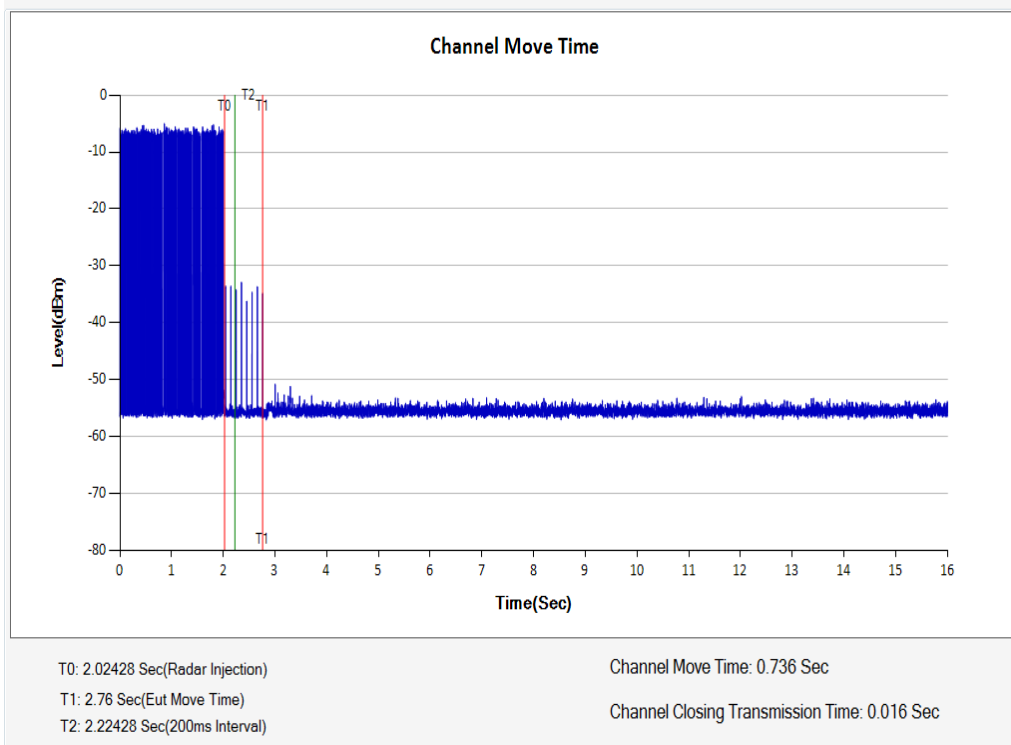

Channel Closing Transmission Time

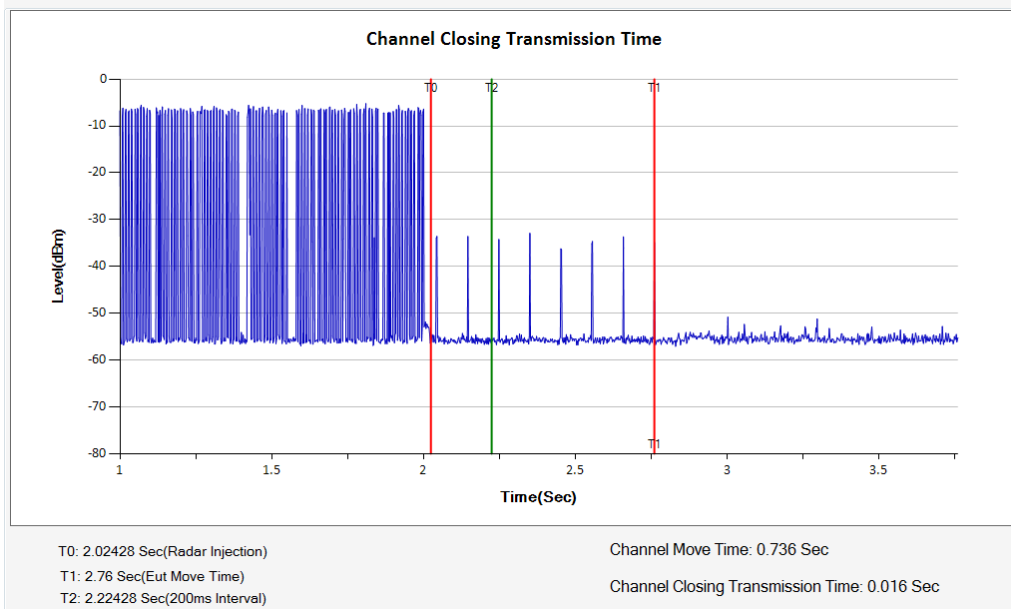

Unless otherwise stated the results shown in this test report refer only to the sample(s) tested and such sample(s) are retained for 90 days only.

除非另有說明，此報告結果僅對測試之樣品負責，同時此樣品僅保留90天。本報告未經本公司書面許可，不可部份複製。

This document is issued by the Company subject to its General Conditions of Service printed overleaf, available on request or accessible at <http://www.sgs.com.tw/Terms-and-Conditions> and for electronic format documents, subject to Terms and Conditions for Electronic Documents at <http://www.sgs.com.tw/Terms-and-Conditions>. Attention is drawn to the limitation of liability, indemnification and jurisdiction issues defined therein. Any holder of this document is advised that information contained hereon reflects the Company's findings at the time of its intervention only and within the limits of Client's instructions, if any. The Company's sole responsibility is to its Client and this document does not exonerate parties to a transaction from exercising all their rights and obligations under the transaction documents. This document cannot be reproduced except in full, without prior written approval of the Company. Any unauthorized alteration, forgery or falsification of the content or appearance of this document is unlawful and offenders may be prosecuted to the fullest extent of the law.

11 NON-OCCUPANCY PERIOD MEASUREMENT

To verify whether channel is unavailable to be operated in 30 minutes.

$1.8ks = 1800s = 1800 s/min /60 = 30minute$

5290MHz

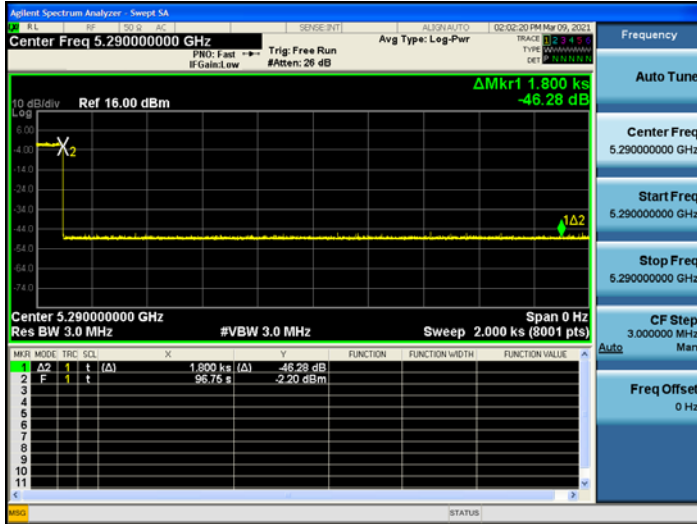

5530MHz



Unless otherwise stated the results shown in this test report refer only to the sample(s) tested and such sample(s) are retained for 90 days only.

除非另有說明，此報告結果僅對測試之樣品負責，同時此樣品僅保留90天。本報告未經本公司書面許可，不可部份複製。

This document is issued by the Company subject to its General Conditions of Service printed overleaf, available on request or accessible at <http://www.sgs.com.tw/Terms-and-Conditions> and for electronic format documents, subject to Terms and Conditions for Electronic Documents at <http://www.sgs.com.tw/Terms-and-Conditions>. Attention is drawn to the limitation of liability, indemnification and jurisdiction issues defined therein. Any holder of this document is advised that information contained hereon reflects the Company's findings at the time of its intervention only and within the limits of Client's instructions, if any. The Company's sole responsibility is to its Client and this document does not exonerate parties to a transaction from exercising all their rights and obligations under the transaction documents. This document cannot be reproduced except in full, without prior written approval of the Company. Any unauthorized alteration, forgery or falsification of the content or appearance of this document is unlawful and offenders may be prosecuted to the fullest extent of the law.

12 UNII DETECTION BANDWIDTH MEASUREMENT

12.1 Test Result

5290MHz

EUT operating Frequency(MHz)	: 5290	EUT 99% Bandwidth(MHz)	: 75.643								
Radar Type	: Type 0	Detection BW(MHz)	: 80								
Test Result	: Pass	※ FH: 5330	FL: 5250								
Radio Frequency (MHz)	DFS Detection Trials (1=Detection, 0= No Detection)										Detection Rate (%)
	1	2	3	4	5	6	7	8	9	10	
5250	1	1	1	1	1	1	1	1	1	1	100
5255	1	1	1	1	1	1	1	1	1	1	100
5260	1	1	1	1	1	1	1	1	1	1	100
5265	1	1	1	1	1	1	1	1	1	1	100
5270	1	1	1	1	1	1	1	1	1	1	100
5275	1	1	1	1	1	1	1	1	1	1	100
5280	1	1	1	1	1	1	1	1	1	1	100
5285	1	1	1	1	1	1	1	1	1	1	100
5290	1	1	1	1	1	1	1	1	1	1	100
5295	1	1	1	1	1	1	1	1	1	1	100
5300	1	1	1	1	1	1	1	1	1	1	100
5305	1	1	1	1	1	1	1	1	1	1	100
5310	1	1	1	1	1	1	1	1	1	1	100
5315	1	1	1	1	1	1	1	1	1	1	100
5320	1	1	1	1	1	1	1	1	1	1	100
5325	1	1	1	1	1	1	1	1	1	1	100
5330	1	1	1	1	1	1	1	1	1	1	100
5250	1	1	1	1	1	1	1	1	1	1	100
5255	1	1	1	1	1	1	1	1	1	1	100

Unless otherwise stated the results shown in this test report refer only to the sample(s) tested and such sample(s) are retained for 90 days only.

除非另有說明，此報告結果僅對測試之樣品負責，同時此樣品僅保留90天。本報告未經本公司書面許可，不可部份複製。

This document is issued by the Company subject to its General Conditions of Service printed overleaf, available on request or accessible at <http://www.sgs.com.tw/Terms-and-Conditions> and for electronic format documents, subject to Terms and Conditions for Electronic Documents at <http://www.sgs.com.tw/Terms-and-Conditions>. Attention is drawn to the limitation of liability, indemnification and jurisdiction issues defined therein. Any holder of this document is advised that information contained hereon reflects the Company's findings at the time of its intervention only and within the limits of Client's instructions, if any. The Company's sole responsibility is to its Client and this document does not exonerate parties to a transaction from exercising all their rights and obligations under the transaction documents. This document cannot be reproduced except in full, without prior written approval of the Company. Any unauthorized alteration, forgery or falsification of the content or appearance of this document is unlawful and offenders may be prosecuted to the fullest extent of the law.

5310MHz

EUT operating Frequency(MHz)	: 5310	EUT 99% Bandwidth(MHz)	: 36.368								
Radar Type	: Type 0	Detection BW(MHz)	: 40								
Test Result	: Pass	※ FH: 5330	FL: 5290								
Radio Frequency (MHz)	DFS Detection Trials (1=Detection, 0= No Detection)										Detection Rate (%)
	1	2	3	4	5	6	7	8	9	10	
5290	1	1	1	1	1	1	1	1	1	1	100
5295	1	1	1	1	1	1	1	1	1	1	100
5300	1	1	1	1	1	1	1	1	1	1	100
5305	1	1	1	1	1	1	1	1	1	1	100
5310	1	1	1	1	1	1	1	1	1	1	100
5315	1	1	1	1	1	1	1	1	1	0	90
5320	1	1	1	1	1	1	1	0	1	1	90
5325	1	1	1	1	1	1	1	1	1	0	90
5330	1	1	1	1	1	1	1	1	1	1	100

5320MHz

EUT operating Frequency(MHz)	: 5320	EUT 99% Bandwidth(MHz)	: 17.663								
Radar Type	: Type 0	Detection BW(MHz)	: 19								
Test Result	: Pass	※ FH: 5329	FL: 5310								
Radio Frequency (MHz)	DFS Detection Trials (1=Detection, 0= No Detection)										Detection Rate (%)
	1	2	3	4	5	6	7	8	9	10	
5310	1	1	1	1	1	1	1	1	1	1	100
5315	1	1	1	1	1	1	1	1	1	1	100
5320	0	1	1	1	1	1	1	1	1	1	90
5325	1	1	1	1	1	1	1	1	1	1	100
5329	1	1	1	1	1	1	1	1	1	1	100
5330	0	0	0	1	1	1	1	1	1	1	70

Unless otherwise stated the results shown in this test report refer only to the sample(s) tested and such sample(s) are retained for 90 days only.

除非另有說明，此報告結果僅對測試之樣品負責，同時此樣品僅保留90天。本報告未經本公司書面許可，不可部份複製。

This document is issued by the Company subject to its General Conditions of Service printed overleaf, available on request or accessible at <http://www.sgs.com.tw/Terms-and-Conditions> and for electronic format documents, subject to Terms and Conditions for Electronic Documents at <http://www.sgs.com.tw/Terms-and-Conditions>. Attention is drawn to the limitation of liability, indemnification and jurisdiction issues defined therein. Any holder of this document is advised that information contained hereon reflects the Company's findings at the time of its intervention only and within the limits of Client's instructions, if any. The Company's sole responsibility is to its Client and this document does not exonerate parties to a transaction from exercising all their rights and obligations under the transaction documents. This document cannot be reproduced except in full, without prior written approval of the Company. Any unauthorized alteration, forgery or falsification of the content or appearance of this document is unlawful and offenders may be prosecuted to the fullest extent of the law.

5500MHz

EUT operating Frequency(MHz)	: 5500	EUT 99% Bandwidth(MHz)	: 17.711
Radar Type	: Type 0	Detection BW(MHz)	: 19
Test Result	: Pass	※ FH: 5509	FL: 5490

Radio Frequency (MHz)	DFS Detection Trials (1=Detection, 0= No Detection)										Detection Rate (%)
	1	2	3	4	5	6	7	8	9	10	
5490	1	1	1	1	1	1	1	1	1	1	100
5495	1	1	1	1	1	1	1	1	1	1	100
5500	1	1	1	1	1	1	1	1	1	1	100
5505	1	1	1	1	1	1	1	1	1	1	100
5509	1	1	1	1	1	1	1	1	1	1	100
5510	0	0	0	1	1	1	1	1	1	1	70

5510MHz

EUT operating Frequency(MHz)	: 5510	EUT 99% Bandwidth(MHz)	: 36.324
Radar Type	: Type 0	Detection BW(MHz)	: 40
Test Result	: Pass	※ FH: 5530	FL: 5490

Radio Frequency (MHz)	DFS Detection Trials (1=Detection, 0= No Detection)										Detection Rate (%)
	1	2	3	4	5	6	7	8	9	10	
5490	1	1	1	1	1	1	1	1	1	1	100
5495	1	1	1	1	1	1	1	1	1	1	100
5500	1	1	1	1	1	1	1	1	1	1	100
5505	1	1	1	1	1	1	1	1	1	1	100
5510	1	1	1	1	1	1	1	1	1	1	100
5515	1	1	1	1	1	1	1	1	1	1	100
5520	1	1	1	1	1	1	1	1	1	1	100
5525	1	1	1	1	1	1	1	1	1	1	100
5530	1	1	1	1	1	1	1	1	1	1	100

Unless otherwise stated the results shown in this test report refer only to the sample(s) tested and such sample(s) are retained for 90 days only.

除非另有說明，此報告結果僅對測試之樣品負責，同時此樣品僅保留90天。本報告未經本公司書面許可，不可部份複製。

This document is issued by the Company subject to its General Conditions of Service printed overleaf, available on request or accessible at <http://www.sgs.com.tw/Terms-and-Conditions> and for electronic format documents, subject to Terms and Conditions for Electronic Documents at <http://www.sgs.com.tw/Terms-and-Conditions>. Attention is drawn to the limitation of liability, indemnification and jurisdiction issues defined therein. Any holder of this document is advised that information contained hereon reflects the Company's findings at the time of its intervention only and within the limits of Client's instructions, if any. The Company's sole responsibility is to its Client and this document does not exonerate parties to a transaction from exercising all their rights and obligations under the transaction documents. This document cannot be reproduced except in full, without prior written approval of the Company. Any unauthorized alteration, forgery or falsification of the content or appearance of this document is unlawful and offenders may be prosecuted to the fullest extent of the law.

5530MHz

EUT operating Frequency(MHz)	: 5530	EUT 99% Bandwidth(MHz)	: 75.806
Radar Type	: Type 0	Detction BW(MHz)	: 80
Test Result	: Pass	※ FH: 5570	FL: 5490

Radio Frequency (MHz)	DFS Detection Trials (1=Detection, 0= No Detection)										Detection Rate (%)
	1	2	3	4	5	6	7	8	9	10	
5490	1	1	1	1	1	1	1	1	1	1	100
5495	1	1	1	1	1	1	1	1	1	1	100
5500	1	1	1	1	1	1	1	1	1	1	100
5505	1	1	1	1	1	1	1	1	1	1	100
5510	1	1	1	1	1	1	1	1	1	1	100
5515	1	1	1	1	1	1	1	1	1	1	100
5520	1	1	1	1	1	1	1	1	1	1	100
5525	1	1	1	1	1	1	1	1	1	1	100
5530	1	1	1	1	1	1	1	1	1	1	100
5535	1	1	1	1	1	1	1	1	1	1	100
5540	1	1	1	1	1	1	1	1	1	1	100
5545	1	1	1	1	1	1	1	1	1	1	100
5550	1	1	1	1	1	1	1	1	1	1	100
5555	1	1	1	1	1	1	1	1	1	1	100
5560	1	1	1	1	1	1	1	1	1	1	100
5565	1	1	1	1	1	1	1	1	1	1	100
5570	1	1	1	1	1	1	1	1	1	1	100

Unless otherwise stated the results shown in this test report refer only to the sample(s) tested and such sample(s) are retained for 90 days only.

除非另有說明，此報告結果僅對測試之樣品負責，同時此樣品僅保留90天。本報告未經本公司書面許可，不可部份複製。

This document is issued by the Company subject to its General Conditions of Service printed overleaf, available on request or accessible at <http://www.sgs.com.tw/Terms-and-Conditions> and for electronic format documents, subject to Terms and Conditions for Electronic Documents at <http://www.sgs.com.tw/Terms-and-Conditions>. Attention is drawn to the limitation of liability, indemnification and jurisdiction issues defined therein. Any holder of this document is advised that information contained hereon reflects the Company's findings at the time of its intervention only and within the limits of Client's instructions, if any. The Company's sole responsibility is to its Client and this document does not exonerate parties to a transaction from exercising all their rights and obligations under the transaction documents. This document cannot be reproduced except in full, without prior written approval of the Company. Any unauthorized alteration, forgery or falsification of the content or appearance of this document is unlawful and offenders may be prosecuted to the fullest extent of the law.

5290MHz

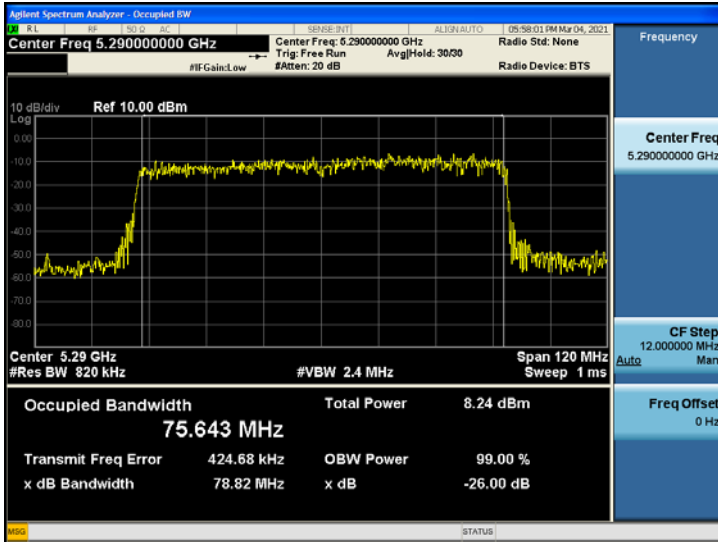

5500MHz

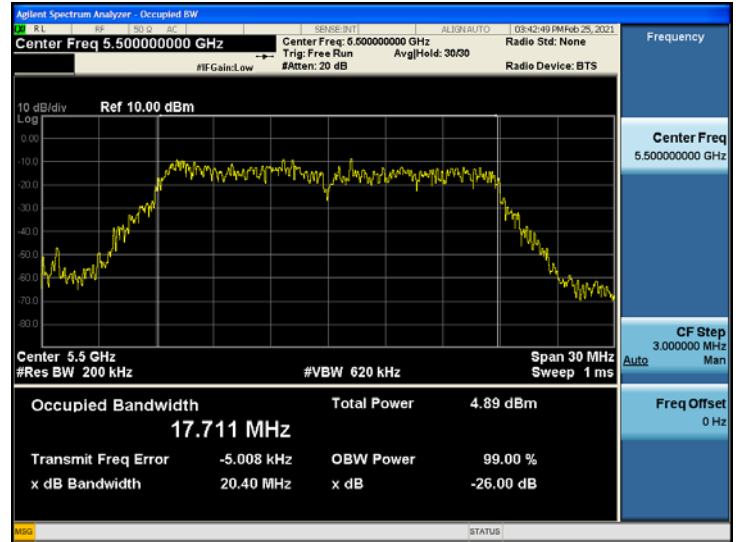

5310MHz

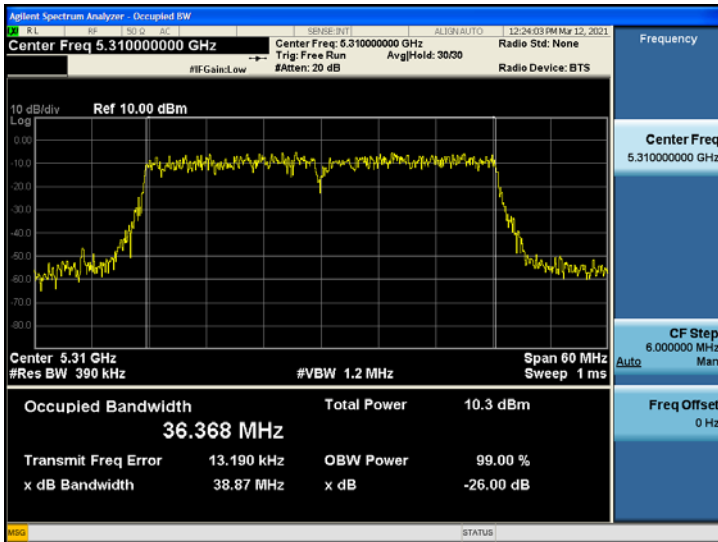

5510MHz

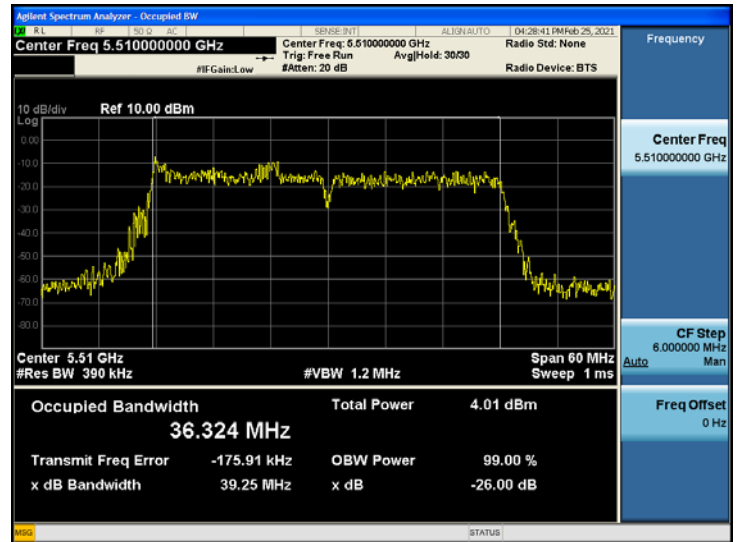

5320MHz

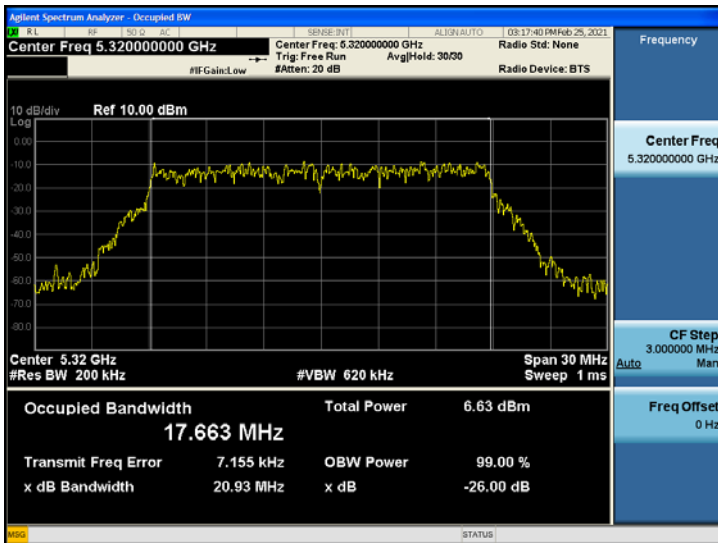

5530MHz

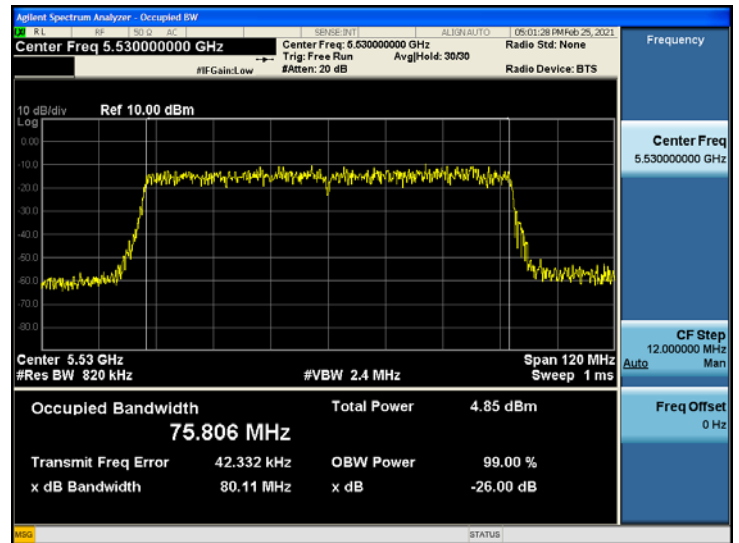

Unless otherwise stated the results shown in this test report refer only to the sample(s) tested and such sample(s) are retained for 90 days only.

除非另有說明，此報告結果僅對測試之樣品負責，同時此樣品僅保留90天。本報告未經本公司書面許可，不可部份複製。

This document is issued by the Company subject to its General Conditions of Service printed overleaf, available on request or accessible at <http://www.sgs.com.tw/Terms-and-Conditions> and for electronic format documents, subject to Terms and Conditions for Electronic Documents at <http://www.sgs.com.tw/Terms-and-Conditions>. Attention is drawn to the limitation of liability, indemnification and jurisdiction issues defined therein. Any holder of this document is advised that information contained hereon reflects the Company's findings at the time of its intervention only and within the limits of Client's instructions, if any. The Company's sole responsibility is to its Client and this document does not exonerate parties to a transaction from exercising all their rights and obligations under the transaction documents. This document cannot be reproduced except in full, without prior written approval of the Company. Any unauthorized alteration, forgery or falsification of the content or appearance of this document is unlawful and offenders may be prosecuted to the fullest extent of the law.

13 CHANNEL AVAILABILITY CHECK MEASUREMENT

13.1 5290MHz

The time of channel availability check (60s)

Radar type 0:



Unless otherwise stated the results shown in this test report refer only to the sample(s) tested and such sample(s) are retained for 90 days only.

除非另有說明，此報告結果僅對測試之樣品負責，同時此樣品僅保留90天。本報告未經本公司書面許可，不可部份複製。

This document is issued by the Company subject to its General Conditions of Service printed overleaf, available on request or accessible at <http://www.sgs.com.tw/Terms-and-Conditions> and for electronic format documents, subject to Terms and Conditions for Electronic Documents at <http://www.sgs.com.tw/Terms-and-Conditions>. Attention is drawn to the limitation of liability, indemnification and jurisdiction issues defined therein. Any holder of this document is advised that information contained hereon reflects the Company's findings at the time of its intervention only and within the limits of Client's instructions, if any. The Company's sole responsibility is to its Client and this document does not exonerate parties to a transaction from exercising all their rights and obligations under the transaction documents. This document cannot be reproduced except in full, without prior written approval of the Company. Any unauthorized alteration, forgery or falsification of the content or appearance of this document is unlawful and offenders may be prosecuted to the fullest extent of the law.

13.2 5530MHz

The time of channel availability check (60s)

Radar type 0:



Unless otherwise stated the results shown in this test report refer only to the sample(s) tested and such sample(s) are retained for 90 days only.

除非另有說明，此報告結果僅對測試之樣品負責，同時此樣品僅保留90天。本報告未經本公司書面許可，不可部份複製。

This document is issued by the Company subject to its General Conditions of Service printed overleaf, available on request or accessible at <http://www.sgs.com.tw/Terms-and-Conditions> and for electronic format documents, subject to Terms and Conditions for Electronic Documents at <http://www.sgs.com.tw/Terms-and-Conditions>. Attention is drawn to the limitation of liability, indemnification and jurisdiction issues defined therein. Any holder of this document is advised that information contained hereon reflects the Company's findings at the time of its intervention only and within the limits of Client's instructions, if any. The Company's sole responsibility is to its Client and this document does not exonerate parties to a transaction from exercising all their rights and obligations under the transaction documents. This document cannot be reproduced except in full, without prior written approval of the Company. Any unauthorized alteration, forgery or falsification of the content or appearance of this document is unlawful and offenders may be prosecuted to the fullest extent of the law.

14 IN SERVICE MONITORING

14.1 5290MHz:

Short Pulse Radar Type	Minimum Number of Trials	Detection(%)		Minmum Percentage of Successful Detection(%)	Pass/Fail
1	30	90		60	Pass
2	30	96.67		60	Pass
3	30	96.67		60	Pass
4	30	90		60	Pass
Aggregate (Radar Types 1-4)	120	93.335		80	Pass
Long Pulse Radar Type	Minimum Number of Trials	Each Detection(%)	Total Detection(%)	Minmum Percentage of Successful Detection(%)	Pass/Fail
5	Center:10	70	90	80	Pass
	Low Edge:10	100			
	High Edge:10	100			
Frequency Hopping Radar Type	Minimum Number of Trials	Detection(%)		Minmum Percentage of Successful Detection(%)	Pass/Fail
6	30	100		70	Pass

Unless otherwise stated the results shown in this test report refer only to the sample(s) tested and such sample(s) are retained for 90 days only.

除非另有說明，此報告結果僅對測試之樣品負責，同時此樣品僅保留90天。本報告未經本公司書面許可，不可部份複製。

This document is issued by the Company subject to its General Conditions of Service printed overleaf, available on request or accessible at <http://www.sgs.com.tw/Terms-and-Conditions> and for electronic format documents, subject to Terms and Conditions for Electronic Documents at <http://www.sgs.com.tw/Terms-and-Conditions>. Attention is drawn to the limitation of liability, indemnification and jurisdiction issues defined therein. Any holder of this document is advised that information contained hereon reflects the Company's findings at the time of its intervention only and within the limits of Client's instructions, if any. The Company's sole responsibility is to its Client and this document does not exonerate parties to a transaction from exercising all their rights and obligations under the transaction documents. This document cannot be reproduced except in full, without prior written approval of the Company. Any unauthorized alteration, forgery or falsification of the content or appearance of this document is unlawful and offenders may be prosecuted to the fullest extent of the law.

14.2 Radar Type 1 for 5290 MHz:

Data Sheet for FCC Radar Type 1						
Trial	VSG Frequency (MHz)	Pulse Repetition Frequency	Pulse Repetition Frequency	PRI	Test A/B	Successful Detection
		Number (1 to 23)	(Pulses Per Second)	(msec)	A/B	(Yes/No)
1	5290	6	1618.1	618	A	Yes
2	5290	14	1285.3	778	A	Yes
3	5290	20	1113.6	898	A	Yes
4	5290	21	1089.3	918	A	Yes
5	5290	22	1066.1	938	A	Yes
6	5290	8	1519.8	658	A	Yes
7	5290	10	1432.7	698	A	Yes
8	5290	7	1567.4	638	A	Yes
9	5290	17	1193.3	838	A	Yes
10	5290	1	1930.5	518	A	Yes
11	5290	4	1730.1	578	A	Yes
12	5290	18	1165.5	858	A	Yes
13	5290	16	1222.5	818	A	Yes
14	5290	11	1392.8	718	A	Yes
15	5290	13	1319.3	758	A	Yes
16	5290	-	1011.1	989	B	Yes
17	5290	-	1845	542	B	Yes
18	5290	-	1061.6	942	B	Yes
19	5290	-	1742.2	574	B	Yes
20	5290	-	478.5	2090	B	Yes
21	5290	-	999	1001	B	Yes
22	5290	-	997	1003	B	Yes
23	5290	-	443.3	2256	B	Yes
24	5290	-	528	1894	B	Yes
25	5290	-	326.5	3063	B	Yes
26	5290	-	577.7	1731	B	Yes
27	5290	-	361.5	2766	B	No
28	5290	-	574.1	1742	B	No
29	5290	-	603.5	1657	B	No
30	5290	-	649.8	1539	B	Yes

Unless otherwise stated the results shown in this test report refer only to the sample(s) tested and such sample(s) are retained for 90 days only.

除非另有說明，此報告結果僅對測試之樣品負責，同時此樣品僅保留90天。本報告未經本公司書面許可，不可部份複製。

This document is issued by the Company subject to its General Conditions of Service printed overleaf, available on request or accessible at <http://www.sgs.com.tw/Terms-and-Conditions> and for electronic format documents, subject to Terms and Conditions for Electronic Documents at <http://www.sgs.com.tw/Terms-and-Conditions>. Attention is drawn to the limitation of liability, indemnification and jurisdiction issues defined therein. Any holder of this document is advised that information contained hereon reflects the Company's findings at the time of its intervention only and within the limits of Client's instructions, if any. The Company's sole responsibility is to its Client and this document does not exonerate parties to a transaction from exercising all their rights and obligations under the transaction documents. This document cannot be reproduced except in full, without prior written approval of the Company. Any unauthorized alteration, forgery or falsification of the content or appearance of this document is unlawful and offenders may be prosecuted to the fullest extent of the law.

14.3 Radar Type 2 for 5290 MHz:

Data Sheet for FCC Radar Type 2

Trial	VSG Frequency (MHz)	Number Pulses per Burst (23-29)	Pulse Width (1-5)	PRI (150-230)	Successful Detection
			(μ s)	(μ s)	(Yes/No)
1	5290	26	3.1	205	Yes
2	5290	26	3.1	166	Yes
3	5290	29	4.9	168	Yes
4	5290	24	1.8	219	Yes
5	5290	28	4.1	189	Yes
6	5290	23	1.1	199	Yes
7	5290	28	4.4	179	Yes
8	5290	27	3.8	177	Yes
9	5290	27	3.4	151	Yes
10	5290	28	3.9	191	Yes
11	5290	23	1.2	228	Yes
12	5290	25	2.3	194	Yes
13	5290	23	1.1	211	Yes
14	5290	29	4.8	157	Yes
15	5290	28	4.2	229	Yes
16	5290	29	4.8	158	Yes
17	5290	27	3.3	175	Yes
18	5290	28	4.4	193	Yes
19	5290	28	4.4	183	Yes
20	5290	29	4.5	176	Yes
21	5290	25	2.6	153	Yes
22	5290	25	2.3	230	No
23	5290	27	3.3	172	Yes
24	5290	29	4.7	224	Yes
25	5290	29	4.9	171	Yes
26	5290	28	4.4	222	Yes
27	5290	25	2.2	160	Yes
28	5290	28	4.1	185	Yes
29	5290	23	1.2	154	Yes
30	5290	28	4.2	207	Yes

Unless otherwise stated the results shown in this test report refer only to the sample(s) tested and such sample(s) are retained for 90 days only.

除非另有說明，此報告結果僅對測試之樣品負責，同時此樣品僅保留90天。本報告未經本公司書面許可，不可部份複製。

This document is issued by the Company subject to its General Conditions of Service printed overleaf, available on request or accessible at <http://www.sgs.com.tw/Terms-and-Conditions> and for electronic format documents, subject to Terms and Conditions for Electronic Documents at <http://www.sgs.com.tw/Terms-and-Conditions>. Attention is drawn to the limitation of liability, indemnification and jurisdiction issues defined therein. Any holder of this document is advised that information contained hereon reflects the Company's findings at the time of its intervention only and within the limits of Client's instructions, if any. The Company's sole responsibility is to its Client and this document does not exonerate parties to a transaction from exercising all their rights and obligations under the transaction documents. This document cannot be reproduced except in full, without prior written approval of the Company. Any unauthorized alteration, forgery or falsification of the content or appearance of this document is unlawful and offenders may be prosecuted to the fullest extent of the law.

14.4 Radar Type 3 for 5290 MHz:

Data Sheet for FCC Radar Type 3					
Trial	VSG Frequency (MHz)	Number Pulses per Burst (16-18)	Pulse Width (6-10)	PRI (200-500)	Successful Detection
			(μ s)	(μ s)	(Yes/No)
1	5290	17	8.1	426	Yes
2	5290	17	8.1	327	Yes
3	5290	18	9.9	326	Yes
4	5290	16	6.8	451	Yes
5	5290	18	9.1	407	Yes
6	5290	16	6.1	388	Yes
7	5290	18	9.4	274	Yes
8	5290	18	8.8	226	Yes
9	5290	17	8.4	361	Yes
10	5290	18	8.9	401	Yes
11	5290	16	6.2	265	No
12	5290	16	7.3	234	Yes
13	5290	16	6.1	252	Yes
14	5290	18	9.8	474	Yes
15	5290	18	9.2	214	Yes
16	5290	18	9.8	355	Yes
17	5290	17	8.3	256	Yes
18	5290	18	9.4	286	Yes
19	5290	18	9.4	498	Yes
20	5290	18	9.5	263	Yes
21	5290	17	7.6	218	Yes
22	5290	16	7.3	268	Yes
23	5290	17	8.3	447	Yes
24	5290	18	9.7	201	Yes
25	5290	18	9.9	485	Yes
26	5290	18	9.4	410	Yes
27	5290	16	7.2	266	Yes
28	5290	18	9.1	233	Yes
29	5290	16	6.2	294	Yes
30	5290	18	9.2	278	Yes

Unless otherwise stated the results shown in this test report refer only to the sample(s) tested and such sample(s) are retained for 90 days only.

除非另有說明，此報告結果僅對測試之樣品負責，同時此樣品僅保留90天。本報告未經本公司書面許可，不可部份複製。

This document is issued by the Company subject to its General Conditions of Service printed overleaf, available on request or accessible at <http://www.sgs.com.tw/Terms-and-Conditions> and for electronic format documents, subject to Terms and Conditions for Electronic Documents at <http://www.sgs.com.tw/Terms-and-Conditions>. Attention is drawn to the limitation of liability, indemnification and jurisdiction issues defined therein. Any holder of this document is advised that information contained hereon reflects the Company's findings at the time of its intervention only and within the limits of Client's instructions, if any. The Company's sole responsibility is to its Client and this document does not exonerate parties to a transaction from exercising all their rights and obligations under the transaction documents. This document cannot be reproduced except in full, without prior written approval of the Company. Any unauthorized alteration, forgery or falsification of the content or appearance of this document is unlawful and offenders may be prosecuted to the fullest extent of the law.

14.5 Radar Type 4 for 5290 MHz:

Data Sheet for FCC Radar Type 4

Trial	VSG Frequency (MHz)	Number Pulses per Burst (12-16)	Pulse Width (11-20)	PRI (200-500)	Successful Detection
			(μs)	(μs)	(Yes/No)
1	5290	14	15.6	426	Yes
2	5290	14	15.7	327	Yes
3	5290	16	19.8	326	Yes
4	5290	12	12.8	451	Yes
5	5290	15	17.9	407	Yes
6	5290	12	11.3	388	Yes
7	5290	16	18.7	274	Yes
8	5290	15	17.2	226	No
9	5290	14	16.3	361	Yes
10	5290	15	17.5	401	Yes
11	5290	12	11.4	265	Yes
12	5290	13	13.8	234	Yes
13	5290	12	11.3	252	Yes
14	5290	16	19.4	474	Yes
15	5290	15	18.2	214	Yes
16	5290	16	19.4	355	No
17	5290	14	16.2	256	Yes
18	5290	16	18.7	286	Yes
19	5290	16	18.7	498	Yes
20	5290	16	18.8	263	Yes
21	5290	14	14.6	218	No
22	5290	13	13.9	268	Yes
23	5290	14	16.2	447	Yes
24	5290	16	19.4	201	Yes
25	5290	16	19.6	485	Yes
26	5290	16	18.6	410	Yes
27	5290	13	13.7	266	Yes
28	5290	15	18	233	Yes
29	5290	12	11.5	294	Yes
30	5290	15	18.2	278	Yes

Unless otherwise stated the results shown in this test report refer only to the sample(s) tested and such sample(s) are retained for 90 days only.

除非另有說明，此報告結果僅對測試之樣品負責，同時此樣品僅保留90天。本報告未經本公司書面許可，不可部份複製。

This document is issued by the Company subject to its General Conditions of Service printed overleaf, available on request or accessible at <http://www.sgs.com.tw/Terms-and-Conditions> and for electronic format documents, subject to Terms and Conditions for Electronic Documents at <http://www.sgs.com.tw/Terms-and-Conditions>. Attention is drawn to the limitation of liability, indemnification and jurisdiction issues defined therein. Any holder of this document is advised that information contained hereon reflects the Company's findings at the time of its intervention only and within the limits of Client's instructions, if any. The Company's sole responsibility is to its Client and this document does not exonerate parties to a transaction from exercising all their rights and obligations under the transaction documents. This document cannot be reproduced except in full, without prior written approval of the Company. Any unauthorized alteration, forgery or falsification of the content or appearance of this document is unlawful and offenders may be prosecuted to the fullest extent of the law.

14.6 Radar Type 5 for 5290 MHz

14.6.1 Trial 1:

Data Sheet for FCC Radar Type 5						
Trial Number:		1		VSG Frequency(MHz):		5290
Number of Bursts in Trial:			14		Successful Detection: No	
Burst (8-20)	Number Pulses per Burst (1-3)	Pulse Width (50-100)	Chirp Width (5-20)	Pulse 1-to-2 Spacing	Pulse 2-to-3 Spacing	Starting Location Within Interval
		(μ sec)	(MHz)	(μ sec)	(μ sec)	(μ sec)
1	2	75.7	13	1450.3		646095
2	2	76.2	13	1835.8		853391
3	3	98.6	13	1660.4	1151.4	206260
4	1	60	13			414310
5	3	88.3	13	1410.7	982.7	620248
6	1	52	13			829565
7	3	92.7	13	1451.3	1091.3	180697
8	3	84.5	13	1906.5	1481.5	387097
9	2	79.4	13	1230.6		595173
10	3	86.3	13	1491.7	1529.7	801190
11	1	52.5	13			155846
12	1	65.8	13			363169
13	1	51.8	13			570697
14	3	96.5	13	919.5	1148.5	776534

Unless otherwise stated the results shown in this test report refer only to the sample(s) tested and such sample(s) are retained for 90 days only.

除非另有說明，此報告結果僅對測試之樣品負責，同時此樣品僅保留90天。本報告未經本公司書面許可，不可部份複製。

This document is issued by the Company subject to its General Conditions of Service printed overleaf, available on request or accessible at <http://www.sgs.com.tw/Terms-and-Conditions> and for electronic format documents, subject to Terms and Conditions for Electronic Documents at <http://www.sgs.com.tw/Terms-and-Conditions>. Attention is drawn to the limitation of liability, indemnification and jurisdiction issues defined therein. Any holder of this document is advised that information contained hereon reflects the Company's findings at the time of its intervention only and within the limits of Client's instructions, if any. The Company's sole responsibility is to its Client and this document does not exonerate parties to a transaction from exercising all their rights and obligations under the transaction documents. This document cannot be reproduced except in full, without prior written approval of the Company. Any unauthorized alteration, forgery or falsification of the content or appearance of this document is unlawful and offenders may be prosecuted to the fullest extent of the law.

14.6.2 Trial 2:

Data Sheet for FCC Radar Type 5						
Trial Number:		2		VSG Frequency(MHz):		5290
Number of Bursts in Trial:			14		Successful Detection: Yes	
Burst (8-20)	Number Pulses per Burst (1-3)	Pulse Width (50-100)	Chirp Width (5-20)	Pulse 1-to-2 Spacing	Pulse 2-to-3 Spacing	Starting Location Within Interval
		(μ sec)	(MHz)	(μ sec)	(μ sec)	(μ sec)
1	3	89.7	13	1178.3	976.3	129878
2	3	96.5	13	1823.5	1552.5	336196
3	2	78.6	13	1730.4		544288
4	3	92.6	13	1348.4	1150.4	750076
5	3	92.6	13	1533.4	1761.4	104294
6	3	93	13	1878	1609	310994
7	2	70.3	13	1860.7		518416
8	1	66	13			727353
9	2	78.7	13	1898.3		78905
10	3	96.3	13	954.7	1546.7	285586
11	3	97.7	13	1410.3	1595.3	492469
12	3	92.3	13	1052.7	1690.7	699494
13	1	65.3	13			53555
14	3	88.9	13	1411.1	1716.1	260074

Unless otherwise stated the results shown in this test report refer only to the sample(s) tested and such sample(s) are retained for 90 days only.

除非另有說明，此報告結果僅對測試之樣品負責，同時此樣品僅保留90天。本報告未經本公司書面許可，不可部份複製。

This document is issued by the Company subject to its General Conditions of Service printed overleaf, available on request or accessible at <http://www.sgs.com.tw/Terms-and-Conditions> and for electronic format documents, subject to Terms and Conditions for Electronic Documents at <http://www.sgs.com.tw/Terms-and-Conditions>. Attention is drawn to the limitation of liability, indemnification and jurisdiction issues defined therein. Any holder of this document is advised that information contained hereon reflects the Company's findings at the time of its intervention only and within the limits of Client's instructions, if any. The Company's sole responsibility is to its Client and this document does not exonerate parties to a transaction from exercising all their rights and obligations under the transaction documents. This document cannot be reproduced except in full, without prior written approval of the Company. Any unauthorized alteration, forgery or falsification of the content or appearance of this document is unlawful and offenders may be prosecuted to the fullest extent of the law.

14.6.3 Trial 3:

Data Sheet for FCC Radar Type 5						
Trial Number:		3		VSG Frequency(MHz):		5290
Number of Bursts in Trial:			20		Successful Detection: No	
Burst (8-20)	Number Pulses per Burst (1-3)	Pulse Width (50-100)	Chirp Width (5-20)	Pulse 1-to-2 Spacing	Pulse 2-to-3 Spacing	Starting Location Within Interval
		(μ sec)	(MHz)	(μ sec)	(μ sec)	(μ sec)
1	1	53.1	20			327984
2	3	90	20	1789	1447	470347
3	2	82.3	20	1038.7		19538
4	2	76.2	20	1301.8		164251
5	2	80.3	20	1314.7		309125
6	3	91.2	20	1887.8	1592.8	452206
7	2	82.6	20	1648.4		1697
8	1	56.7	20			146959
9	2	69.4	20	1711.6		291322
10	2	71	20	1475		436052
11	3	97.9	20	1413.1	1179.1	579415
12	3	93.2	20	1553.8	1022.8	128485
13	2	72.1	20	1223.9		273557
14	3	94.6	20	1584.4	990.4	417454
15	3	90.4	20	1291.6	1396.6	561415
16	3	85.2	20	1173.8	1748.8	110459
17	3	95.3	20	1538.7	1756.7	254888
18	2	71.2	20	1839.8		400255
19	1	64.1	20			546815
20	2	74.5	20	1751.5		92943

Unless otherwise stated the results shown in this test report refer only to the sample(s) tested and such sample(s) are retained for 90 days only.

除非另有說明，此報告結果僅對測試之樣品負責，同時此樣品僅保留90天。本報告未經本公司書面許可，不可部份複製。

This document is issued by the Company subject to its General Conditions of Service printed overleaf, available on request or accessible at <http://www.sgs.com.tw/Terms-and-Conditions> and for electronic format documents, subject to Terms and Conditions for Electronic Documents at <http://www.sgs.com.tw/Terms-and-Conditions>. Attention is drawn to the limitation of liability, indemnification and jurisdiction issues defined therein. Any holder of this document is advised that information contained hereon reflects the Company's findings at the time of its intervention only and within the limits of Client's instructions, if any. The Company's sole responsibility is to its Client and this document does not exonerate parties to a transaction from exercising all their rights and obligations under the transaction documents. This document cannot be reproduced except in full, without prior written approval of the Company. Any unauthorized alteration, forgery or falsification of the content or appearance of this document is unlawful and offenders may be prosecuted to the fullest extent of the law.

14.6.4 Trial 4:

Data Sheet for FCC Radar Type 5						
Trial Number:		4		VSG Frequency(MHz):		5290
Number of Bursts in Trial:			10		Successful Detection: No	
Burst (8-20)	Number Pulses per Burst (1-3)	Pulse Width (50-100)	Chirp Width (5-20)	Pulse 1-to-2 Spacing	Pulse 2-to-3 Spacing	Starting Location Within Interval
		(μ sec)	(MHz)	(μ sec)	(μ sec)	(μ sec)
1	2	71.3	8	1835.7		476618
2	1	57.3	8			768080
3	3	95.2	8	917.8	1522.8	1056357
4	2	82.8	8	1172.2		150695
5	2	79.5	8	1775.5		441008
6	2	68.9	8	1636.1		731474
7	1	53.6	8			1022491
8	1	59.6	8			115101
9	3	97.5	8	1330.5	1620.5	404670
10	1	52.3	8			696336

Unless otherwise stated the results shown in this test report refer only to the sample(s) tested and such sample(s) are retained for 90 days only.

除非另有說明，此報告結果僅對測試之樣品負責，同時此樣品僅保留90天。本報告未經本公司書面許可，不可部份複製。

This document is issued by the Company subject to its General Conditions of Service printed overleaf, available on request or accessible at <http://www.sgs.com.tw/Terms-and-Conditions> and for electronic format documents, subject to Terms and Conditions for Electronic Documents at <http://www.sgs.com.tw/Terms-and-Conditions>. Attention is drawn to the limitation of liability, indemnification and jurisdiction issues defined therein. Any holder of this document is advised that information contained hereon reflects the Company's findings at the time of its intervention only and within the limits of Client's instructions, if any. The Company's sole responsibility is to its Client and this document does not exonerate parties to a transaction from exercising all their rights and obligations under the transaction documents. This document cannot be reproduced except in full, without prior written approval of the Company. Any unauthorized alteration, forgery or falsification of the content or appearance of this document is unlawful and offenders may be prosecuted to the fullest extent of the law.

14.6.5 Trial 5:

Data Sheet for FCC Radar Type 5						
Trial Number:		5		VSG Frequency(MHz):		5290
Number of Bursts in Trial:			17		Successful Detection: Yes	
Burst (8-20)	Number Pulses per Burst (1-3)	Pulse Width (50-100)	Chirp Width (5-20)	Pulse 1-to-2 Spacing	Pulse 2-to-3 Spacing	Starting Location Within Interval
		(μ sec)	(MHz)	(μ sec)	(μ sec)	(μ sec)
1	1	62.3	17			580292
2	3	96	17	1892	1376	46376
3	3	86.7	17	1845.3	1609.3	216364
4	1	53.7	17			388124
5	2	81.3	17	1741.7		557500
6	3	89.5	17	1284.5	1043.5	25448
7	1	53.9	17			196365
8	2	76.3	17	1248.7		366324
9	3	85.6	17	1399.4	1573.4	535403
10	1	60.6	17			4498
11	1	63.8	17			175244
12	2	82.9	17	1841.1		345455
13	2	77	17	950		516472
14	1	57.6	17			687535
15	3	94.7	17	1506.3	1682.3	153508
16	3	99.4	17	1072.6	1097.6	324212
17	2	70.8	17	1827.2		494914

Unless otherwise stated the results shown in this test report refer only to the sample(s) tested and such sample(s) are retained for 90 days only.

除非另有說明，此報告結果僅對測試之樣品負責，同時此樣品僅保留90天。本報告未經本公司書面許可，不可部份複製。

This document is issued by the Company subject to its General Conditions of Service printed overleaf, available on request or accessible at <http://www.sgs.com.tw/Terms-and-Conditions> and for electronic format documents, subject to Terms and Conditions for Electronic Documents at <http://www.sgs.com.tw/Terms-and-Conditions>. Attention is drawn to the limitation of liability, indemnification and jurisdiction issues defined therein. Any holder of this document is advised that information contained hereon reflects the Company's findings at the time of its intervention only and within the limits of Client's instructions, if any. The Company's sole responsibility is to its Client and this document does not exonerate parties to a transaction from exercising all their rights and obligations under the transaction documents. This document cannot be reproduced except in full, without prior written approval of the Company. Any unauthorized alteration, forgery or falsification of the content or appearance of this document is unlawful and offenders may be prosecuted to the fullest extent of the law.

14.6.6 Trial 6

Data Sheet for FCC Radar Type 5						
Trial Number:		6		VSG Frequency(MHz):		5290
Number of Bursts in Trial:			8		Successful Detection: Yes	
Burst (8-20)	Number Pulses per Burst (1-3)	Pulse Width (50-100)	Chirp Width (5-20)	Pulse 1-to-2 Spacing	Pulse 2-to-3 Spacing	Starting Location Within Interval
		(μ sec)	(MHz)	(μ sec)	(μ sec)	(μ sec)
1	2	75.7	5	1039.3		1417883
2	2	75.7	5	1675.3		283058
3	3	93.5	5	1267.5	1790.5	645459
4	1	50.9	5			1010268
5	2	76.5	5	1874.5		1371553
6	2	78.2	5	1352.8		238446
7	3	90.9	5	1594.1	1659.1	600817
8	2	67.6	5	1311.4		964778

Unless otherwise stated the results shown in this test report refer only to the sample(s) tested and such sample(s) are retained for 90 days only.

除非另有說明，此報告結果僅對測試之樣品負責，同時此樣品僅保留90天。本報告未經本公司書面許可，不可部份複製。

This document is issued by the Company subject to its General Conditions of Service printed overleaf, available on request or accessible at <http://www.sgs.com.tw/Terms-and-Conditions> and for electronic format documents, subject to Terms and Conditions for Electronic Documents at <http://www.sgs.com.tw/Terms-and-Conditions>. Attention is drawn to the limitation of liability, indemnification and jurisdiction issues defined therein. Any holder of this document is advised that information contained hereon reflects the Company's findings at the time of its intervention only and within the limits of Client's instructions, if any. The Company's sole responsibility is to its Client and this document does not exonerate parties to a transaction from exercising all their rights and obligations under the transaction documents. This document cannot be reproduced except in full, without prior written approval of the Company. Any unauthorized alteration, forgery or falsification of the content or appearance of this document is unlawful and offenders may be prosecuted to the fullest extent of the law.

14.6.7 Trial 7:

Data Sheet for FCC Radar Type 5						
Trial Number:		7		VSG Frequency(MHz):		5290
Number of Bursts in Trial:			19		Successful Detection: Yes	
Burst (8-20)	Number Pulses per Burst (1-3)	Pulse Width (50-100)	Chirp Width (5-20)	Pulse 1-to-2 Spacing	Pulse 2-to-3 Spacing	Starting Location Within Interval
		(μ sec)	(MHz)	(μ sec)	(μ sec)	(μ sec)
1	3	95.8	18	1832.2	1410.2	555394
2	3	94.9	18	1322.1	1204.1	81223
3	3	99.5	18	1355.5	1089.5	233328
4	3	96.8	18	1535.2	1145.2	385633
5	1	61.3	18			540366
6	3	87.5	18	1422.5	1401.5	62393
7	2	72.9	18	1379.1		215032
8	1	59.2	18			368445
9	2	67.1	18	1004.9		520066
10	1	58.6	18			43887
11	1	51.8	18			196798
12	1	56.4	18			349750
13	2	68.4	18	1078.6		501484
14	1	63.2	18			25077
15	1	50.8	18			177809
16	2	81.2	18	1690.8		329509
17	2	68.9	18	1214.1		482804
18	3	85.6	18	1638.4	1504.4	6218
19	1	53.4	18			159040

Unless otherwise stated the results shown in this test report refer only to the sample(s) tested and such sample(s) are retained for 90 days only.

除非另有說明，此報告結果僅對測試之樣品負責，同時此樣品僅保留90天。本報告未經本公司書面許可，不可部份複製。

This document is issued by the Company subject to its General Conditions of Service printed overleaf, available on request or accessible at <http://www.sgs.com.tw/Terms-and-Conditions> and for electronic format documents, subject to Terms and Conditions for Electronic Documents at <http://www.sgs.com.tw/Terms-and-Conditions>. Attention is drawn to the limitation of liability, indemnification and jurisdiction issues defined therein. Any holder of this document is advised that information contained hereon reflects the Company's findings at the time of its intervention only and within the limits of Client's instructions, if any. The Company's sole responsibility is to its Client and this document does not exonerate parties to a transaction from exercising all their rights and obligations under the transaction documents. This document cannot be reproduced except in full, without prior written approval of the Company. Any unauthorized alteration, forgery or falsification of the content or appearance of this document is unlawful and offenders may be prosecuted to the fullest extent of the law.

14.6.8 Trial 8:

Data Sheet for FCC Radar Type 5						
Trial Number:		8		VSG Frequency(MHz):		5290
Number of Bursts in Trial:			16		Successful Detection: Yes	
Burst (8-20)	Number Pulses per Burst (1-3)	Pulse Width (50-100)	Chirp Width (5-20)	Pulse 1-to-2 Spacing	Pulse 2-to-3 Spacing	Starting Location Within Interval
		(μ sec)	(MHz)	(μ sec)	(μ sec)	(μ sec)
1	1	60.6	16			370709
2	3	88.4	16	1673.6	1542.6	549691
3	2	80.4	16	1180.6		732531
4	3	87.6	16	1044.4	1739.4	165939
5	3	88.2	16	1018.8	1348.8	346815
6	2	80.1	16	1083.9		529051
7	3	98.1	16	1002.9	932.9	709596
8	2	78	16	1770		143881
9	3	84	16	1829	955	324420
10	1	53.9	16			507438
11	1	51.3	16			689099
12	3	85.9	16	1091.1	973.1	121440
13	2	67.8	16	1372.2		302742
14	3	95.8	16	1367.2	1777.2	483049
15	3	86.1	16	1808.9	1553.9	663080
16	3	85.6	16	1203.4	1201.4	99115

Unless otherwise stated the results shown in this test report refer only to the sample(s) tested and such sample(s) are retained for 90 days only.

除非另有說明，此報告結果僅對測試之樣品負責，同時此樣品僅保留90天。本報告未經本公司書面許可，不可部份複製。

This document is issued by the Company subject to its General Conditions of Service printed overleaf, available on request or accessible at <http://www.sgs.com.tw/Terms-and-Conditions> and for electronic format documents, subject to Terms and Conditions for Electronic Documents at <http://www.sgs.com.tw/Terms-and-Conditions>. Attention is drawn to the limitation of liability, indemnification and jurisdiction issues defined therein. Any holder of this document is advised that information contained hereon reflects the Company's findings at the time of its intervention only and within the limits of Client's instructions, if any. The Company's sole responsibility is to its Client and this document does not exonerate parties to a transaction from exercising all their rights and obligations under the transaction documents. This document cannot be reproduced except in full, without prior written approval of the Company. Any unauthorized alteration, forgery or falsification of the content or appearance of this document is unlawful and offenders may be prosecuted to the fullest extent of the law.

14.6.9 Trial 9:

Data Sheet for FCC Radar Type 5						
Trial Number:		9		VSG Frequency(MHz):		5290
Number of Bursts in Trial:			15		Successful Detection: Yes	
Burst (8-20)	Number Pulses per Burst (1-3)	Pulse Width (50-100)	Chirp Width (5-20)	Pulse 1-to-2 Spacing	Pulse 2-to-3 Spacing	Starting Location Within Interval
		(μ sec)	(MHz)	(μ sec)	(μ sec)	(μ sec)
1	3	94.7	14	1479.3	1263.3	298833
2	1	54.5	14			493176
3	2	79.6	14	1873.4		685083
4	2	74.2	14	1843.8		82062
5	2	73.2	14	1416.8		275417
6	3	90.9	14	1149.1	1074.1	467980
7	2	73.7	14	1483.3		662375
8	1	59.9	14			58438
9	3	99	14	1378	1647	251182
10	3	92.8	14	1777.2	1876.2	443379
11	3	93	14	1382	1233	637342
12	1	52.4	14			34582
13	1	62.4	14			228187
14	2	74.8	14	1905.2		420798
15	1	62.3	14			615553

Unless otherwise stated the results shown in this test report refer only to the sample(s) tested and such sample(s) are retained for 90 days only.

除非另有說明，此報告結果僅對測試之樣品負責，同時此樣品僅保留90天。本報告未經本公司書面許可，不可部份複製。

This document is issued by the Company subject to its General Conditions of Service printed overleaf, available on request or accessible at <http://www.sgs.com.tw/Terms-and-Conditions> and for electronic format documents, subject to Terms and Conditions for Electronic Documents at <http://www.sgs.com.tw/Terms-and-Conditions>. Attention is drawn to the limitation of liability, indemnification and jurisdiction issues defined therein. Any holder of this document is advised that information contained hereon reflects the Company's findings at the time of its intervention only and within the limits of Client's instructions, if any. The Company's sole responsibility is to its Client and this document does not exonerate parties to a transaction from exercising all their rights and obligations under the transaction documents. This document cannot be reproduced except in full, without prior written approval of the Company. Any unauthorized alteration, forgery or falsification of the content or appearance of this document is unlawful and offenders may be prosecuted to the fullest extent of the law.

14.6.10 Trial 10:

Data Sheet for FCC Radar Type 5						
Trial Number:		10		VSG Frequency(MHz):		5290
Number of Bursts in Trial:			17		Successful Detection: Yes	
Burst (8-20)	Number Pulses per Burst (1-3)	Pulse Width (50-100)	Chirp Width (5-20)	Pulse 1-to-2 Spacing	Pulse 2-to-3 Spacing	Starting Location Within Interval
		(μ sec)	(MHz)	(μ sec)	(μ sec)	(μ sec)
1	2	82	16	1608		9460
2	3	90.9	16	1895.1	1899.1	179231
3	2	74.7	16	971.3		350504
4	2	80.3	16	1727.7		520285
5	2	79.3	16	1343.7		691395
6	1	65.4	16			159274
7	1	57.2	16			330226
8	1	61.3	16			500882
9	2	66.7	16	1384.3		670070
10	1	63.3	16			138302
11	1	59.5	16			308892
12	3	89	16	956	1389	478108
13	1	55.2	16			651105
14	1	65.7	16			117181
15	2	72.8	16	1140.2		287537
16	3	84.1	16	1657.9	1577.9	456409
17	1	60.6	16			630080

Unless otherwise stated the results shown in this test report refer only to the sample(s) tested and such sample(s) are retained for 90 days only.

除非另有說明，此報告結果僅對測試之樣品負責，同時此樣品僅保留90天。本報告未經本公司書面許可，不可部份複製。

This document is issued by the Company subject to its General Conditions of Service printed overleaf, available on request or accessible at <http://www.sgs.com.tw/Terms-and-Conditions> and for electronic format documents, subject to Terms and Conditions for Electronic Documents at <http://www.sgs.com.tw/Terms-and-Conditions>. Attention is drawn to the limitation of liability, indemnification and jurisdiction issues defined therein. Any holder of this document is advised that information contained hereon reflects the Company's findings at the time of its intervention only and within the limits of Client's instructions, if any. The Company's sole responsibility is to its Client and this document does not exonerate parties to a transaction from exercising all their rights and obligations under the transaction documents. This document cannot be reproduced except in full, without prior written approval of the Company. Any unauthorized alteration, forgery or falsification of the content or appearance of this document is unlawful and offenders may be prosecuted to the fullest extent of the law.

14.6.11 Trial 11:

Data Sheet for FCC Radar Type 5						
Trial Number:		11		VSG Frequency(MHz):		5254.1785
Number of Bursts in Trial:			8		Successful Detection: Yes	
Burst (8-20)	Number Pulses per Burst (1-3)	Pulse Width (50-100)	Chirp Width (5-20)	Pulse 1-to-2 Spacing	Pulse 2-to-3 Spacing	Starting Location Within Interval
		(μ sec)	(MHz)	(μ sec)	(μ sec)	(μ sec)
1	2	82.3	5	1891.7		204286
2	2	77.7	5	1726.3		567132
3	1	56.2	5			931599
4	2	76.6	5	1705.4		1293038
5	3	89.4	5	1564.6	1775.6	159393
6	1	61.4	5			523221
7	2	80.3	5	1636.7		885768
8	2	69.7	5	1494.3		1249162

14.6.12 Trial 12:

Data Sheet for FCC Radar Type 5						
Trial Number:		12		VSG Frequency(MHz):		5256.1785
Number of Bursts in Trial:			12		Successful Detection: Yes	
Burst (8-20)	Number Pulses per Burst (1-3)	Pulse Width (50-100)	Chirp Width (5-20)	Pulse 1-to-2 Spacing	Pulse 2-to-3 Spacing	Starting Location Within Interval
		(μ sec)	(MHz)	(μ sec)	(μ sec)	(μ sec)
1	1	64.7	10			76661
2	2	70.5	10	1788.5		318052
3	3	88.7	10	1145.3	1370.3	559355
4	3	95.4	10	1585.6	977.6	800973
5	3	87.2	10	1730.8	931.8	46677
6	3	95.7	10	1486.3	1643.3	287993
7	1	65.5	10			531115
8	1	59.1	10			773599
9	3	91.7	10	1495.3	944.3	16922
10	2	69.4	10	1818.6		258740
11	3	95.1	10	1223.9	1397.9	499728
12	3	93.2	10	1751.8	1222.8	740884

Unless otherwise stated the results shown in this test report refer only to the sample(s) tested and such sample(s) are retained for 90 days only.

除非另有說明，此報告結果僅對測試之樣品負責，同時此樣品僅保留90天。本報告未經本公司書面許可，不可部份複製。

This document is issued by the Company subject to its General Conditions of Service printed overleaf, available on request or accessible at <http://www.sgs.com.tw/Terms-and-Conditions> and for electronic format documents, subject to Terms and Conditions for Electronic Documents at <http://www.sgs.com.tw/Terms-and-Conditions>. Attention is drawn to the limitation of liability, indemnification and jurisdiction issues defined therein. Any holder of this document is advised that information contained hereon reflects the Company's findings at the time of its intervention only and within the limits of Client's instructions, if any. The Company's sole responsibility is to its Client and this document does not exonerate parties to a transaction from exercising all their rights and obligations under the transaction documents. This document cannot be reproduced except in full, without prior written approval of the Company. Any unauthorized alteration, forgery or falsification of the content or appearance of this document is unlawful and offenders may be prosecuted to the fullest extent of the law.

14.6.13 Trial 13:

Data Sheet for FCC Radar Type 5						
Trial Number:		13		VSG Frequency(MHz):		5254.1785
Number of Bursts in Trial:			8		Successful Detection: Yes	
Burst (8-20)	Number Pulses per Burst (1-3)	Pulse Width (50-100)	Chirp Width (5-20)	Pulse 1-to-2 Spacing	Pulse 2-to-3 Spacing	Starting Location Within Interval
		(μ sec)	(MHz)	(μ sec)	(μ sec)	(μ sec)
1	1	65.5	5			1479371
2	1	56.8	5			344182
3	2	70.1	5	1105.9		706970
4	3	87.4	5	1570.6	1874.6	1068743
5	3	93.3	5	1060.7	1618.7	1432093
6	1	62.8	5			299316
7	1	60.9	5			662666
8	1	63.7	5			1026325

Unless otherwise stated the results shown in this test report refer only to the sample(s) tested and such sample(s) are retained for 90 days only.

除非另有說明，此報告結果僅對測試之樣品負責，同時此樣品僅保留90天。本報告未經本公司書面許可，不可部份複製。

This document is issued by the Company subject to its General Conditions of Service printed overleaf, available on request or accessible at <http://www.sgs.com.tw/Terms-and-Conditions> and for electronic format documents, subject to Terms and Conditions for Electronic Documents at <http://www.sgs.com.tw/Terms-and-Conditions>. Attention is drawn to the limitation of liability, indemnification and jurisdiction issues defined therein. Any holder of this document is advised that information contained hereon reflects the Company's findings at the time of its intervention only and within the limits of Client's instructions, if any. The Company's sole responsibility is to its Client and this document does not exonerate parties to a transaction from exercising all their rights and obligations under the transaction documents. This document cannot be reproduced except in full, without prior written approval of the Company. Any unauthorized alteration, forgery or falsification of the content or appearance of this document is unlawful and offenders may be prosecuted to the fullest extent of the law.

14.6.14 Trial 14:

Data Sheet for FCC Radar Type 5						
Trial Number:		14		VSG Frequency(MHz):		5259.7785
Number of Bursts in Trial:			20		Successful Detection: Yes	
Burst (8-20)	Number Pulses per Burst (1-3)	Pulse Width (50-100)	Chirp Width (5-20)	Pulse 1-to-2 Spacing	Pulse 2-to-3 Spacing	Starting Location Within Interval
		(μ sec)	(MHz)	(μ sec)	(μ sec)	(μ sec)
1	1	51.9	19			555310
2	2	68.4	19	1297.6		101410
3	3	94.2	19	937.8	1678.8	245502
4	2	76.1	19	1023.9		391491
5	1	58.7	19			537470
6	2	82.3	19	1078.7		83620
7	2	70.1	19	1302.9		228490
8	3	84.7	19	1375.3	1583.3	372232
9	2	68.6	19	1426.4		517894
10	3	85.7	19	963.3	1248.3	65637
11	3	92.7	19	1210.3	1139.3	210105
12	2	79.5	19	1500.5		355398
13	3	94.5	19	1452.5	1043.5	498911
14	1	60.5	19			48049
15	1	64.6	19			193165
16	3	95	19	1062	1748	336831
17	2	68.6	19	1053.4		482936
18	1	65.9	19			30180
19	2	79.6	19	945.4		175084
20	2	67.6	19	933.4		320145

Unless otherwise stated the results shown in this test report refer only to the sample(s) tested and such sample(s) are retained for 90 days only.

除非另有說明，此報告結果僅對測試之樣品負責，同時此樣品僅保留90天。本報告未經本公司書面許可，不可部份複製。

This document is issued by the Company subject to its General Conditions of Service printed overleaf, available on request or accessible at <http://www.sgs.com.tw/Terms-and-Conditions> and for electronic format documents, subject to Terms and Conditions for Electronic Documents at <http://www.sgs.com.tw/Terms-and-Conditions>. Attention is drawn to the limitation of liability, indemnification and jurisdiction issues defined therein. Any holder of this document is advised that information contained hereon reflects the Company's findings at the time of its intervention only and within the limits of Client's instructions, if any. The Company's sole responsibility is to its Client and this document does not exonerate parties to a transaction from exercising all their rights and obligations under the transaction documents. This document cannot be reproduced except in full, without prior written approval of the Company. Any unauthorized alteration, forgery or falsification of the content or appearance of this document is unlawful and offenders may be prosecuted to the fullest extent of the law.

14.6.15 Trial 15:

Data Sheet for FCC Radar Type 5						
Trial Number:		15		VSG Frequency(MHz):		5258.9785
Number of Bursts in Trial:			18		Successful Detection: Yes	
Burst (8-20)	Number Pulses per Burst (1-3)	Pulse Width (50-100)	Chirp Width (5-20)	Pulse 1-to-2 Spacing	Pulse 2-to-3 Spacing	Starting Location Within Interval
		(μ sec)	(MHz)	(μ sec)	(μ sec)	(μ sec)
1	3	94	17	1439	1888	514754
2	2	79.9	17	1615.1		13624
3	1	63.6	17			175105
4	3	96.4	17	1606.6	1207.6	334596
5	2	77.7	17	1836.3		496335
6	3	91	17	1245	1130	656012
7	3	95.2	17	1843.8	1354.8	154230
8	2	75.5	17	1645.5		315659
9	1	57.6	17			477960
10	2	68.8	17	948.2		638361
11	3	83.4	17	1039.6	1116.6	134744
12	2	76.6	17	1028.4		296218
13	1	50.4	17			458029
14	1	66.5	17			618940
15	2	67.8	17	1250.2		115207
16	3	96.3	17	1337.7	984.7	275765
17	2	76.3	17	1450.7		436688
18	1	62.5	17			598976

Unless otherwise stated the results shown in this test report refer only to the sample(s) tested and such sample(s) are retained for 90 days only.

除非另有說明，此報告結果僅對測試之樣品負責，同時此樣品僅保留90天。本報告未經本公司書面許可，不可部份複製。

This document is issued by the Company subject to its General Conditions of Service printed overleaf, available on request or accessible at <http://www.sgs.com.tw/Terms-and-Conditions> and for electronic format documents, subject to Terms and Conditions for Electronic Documents at <http://www.sgs.com.tw/Terms-and-Conditions>. Attention is drawn to the limitation of liability, indemnification and jurisdiction issues defined therein. Any holder of this document is advised that information contained hereon reflects the Company's findings at the time of its intervention only and within the limits of Client's instructions, if any. The Company's sole responsibility is to its Client and this document does not exonerate parties to a transaction from exercising all their rights and obligations under the transaction documents. This document cannot be reproduced except in full, without prior written approval of the Company. Any unauthorized alteration, forgery or falsification of the content or appearance of this document is unlawful and offenders may be prosecuted to the fullest extent of the law.

14.6.16 Trial 16:

Data Sheet for FCC Radar Type 5						
Trial Number:		16		VSG Frequency(MHz):		5259.7785
Number of Bursts in Trial:			20		Successful Detection: Yes	
Burst (8-20)	Number Pulses per Burst (1-3)	Pulse Width (50-100)	Chirp Width (5-20)	Pulse 1-to-2 Spacing	Pulse 2-to-3 Spacing	Starting Location Within Interval
		(μ sec)	(MHz)	(μ sec)	(μ sec)	(μ sec)
1	3	86.6	19	1849.4	1340.4	85405
2	1	54.8	19			231183
3	2	75.5	19	1790.5		375035
4	2	80.8	19	1449.2		520228
5	3	90.5	19	931.5	1160.5	67791
6	1	56	19			213098
7	2	76.7	19	1877.3		357248
8	1	65.6	19			503347
9	3	98.7	19	1273.3	1295.3	49898
10	1	55	19			195306
11	3	92.3	19	1251.7	1171.7	339090
12	2	75.1	19	979.9		484759
13	2	68.8	19	1501.2		32183
14	2	77.3	19	1798.7		176994
15	2	83.2	19	1421.8		321885
16	3	93.3	19	1451.7	1520.7	465477
17	2	69.7	19	932.3		14378
18	2	72.1	19	1385.9		159073
19	1	54.8	19			304639
20	3	97.9	19	1634.1	939.1	447875

Unless otherwise stated the results shown in this test report refer only to the sample(s) tested and such sample(s) are retained for 90 days only.

除非另有說明，此報告結果僅對測試之樣品負責，同時此樣品僅保留90天。本報告未經本公司書面許可，不可部份複製。

This document is issued by the Company subject to its General Conditions of Service printed overleaf, available on request or accessible at <http://www.sgs.com.tw/Terms-and-Conditions> and for electronic format documents, subject to Terms and Conditions for Electronic Documents at <http://www.sgs.com.tw/Terms-and-Conditions>. Attention is drawn to the limitation of liability, indemnification and jurisdiction issues defined therein. Any holder of this document is advised that information contained hereon reflects the Company's findings at the time of its intervention only and within the limits of Client's instructions, if any. The Company's sole responsibility is to its Client and this document does not exonerate parties to a transaction from exercising all their rights and obligations under the transaction documents. This document cannot be reproduced except in full, without prior written approval of the Company. Any unauthorized alteration, forgery or falsification of the content or appearance of this document is unlawful and offenders may be prosecuted to the fullest extent of the law.

14.6.17 Trial 17:

Data Sheet for FCC Radar Type 5						
Trial Number:		17		VSG Frequency(MHz):		5257.7785
Number of Bursts in Trial:			15		Successful Detection: Yes	
Burst (8-20)	Number Pulses per Burst (1-3)	Pulse Width (50-100)	Chirp Width (5-20)	Pulse 1-to-2 Spacing	Pulse 2-to-3 Spacing	Starting Location Within Interval
		(μ sec)	(MHz)	(μ sec)	(μ sec)	(μ sec)
1	3	98.5	14	1529.5	1540.5	790275
2	2	67.8	14	967.2		188767
3	3	87.2	14	1393.8	1408.8	381473
4	3	94.7	14	1083.3	1702.3	574184
5	2	77.1	14	1188.9		768439
6	3	99.9	14	1371.1	1009.1	164630
7	1	52.2	14			358931
8	1	66	14			552374
9	2	79	14	1802		743959
10	2	77.9	14	1074.1		141116
11	3	92.8	14	1900.2	1228.2	333425
12	2	68.3	14	1261.7		527752
13	2	68.6	14	1277.4		720969
14	1	56.1	14			117503
15	2	79.4	14	997.6		310715

Unless otherwise stated the results shown in this test report refer only to the sample(s) tested and such sample(s) are retained for 90 days only.

除非另有說明，此報告結果僅對測試之樣品負責，同時此樣品僅保留90天。本報告未經本公司書面許可，不可部份複製。

This document is issued by the Company subject to its General Conditions of Service printed overleaf, available on request or accessible at <http://www.sgs.com.tw/Terms-and-Conditions> and for electronic format documents, subject to Terms and Conditions for Electronic Documents at <http://www.sgs.com.tw/Terms-and-Conditions>. Attention is drawn to the limitation of liability, indemnification and jurisdiction issues defined therein. Any holder of this document is advised that information contained hereon reflects the Company's findings at the time of its intervention only and within the limits of Client's instructions, if any. The Company's sole responsibility is to its Client and this document does not exonerate parties to a transaction from exercising all their rights and obligations under the transaction documents. This document cannot be reproduced except in full, without prior written approval of the Company. Any unauthorized alteration, forgery or falsification of the content or appearance of this document is unlawful and offenders may be prosecuted to the fullest extent of the law.

14.6.18 Trial 18:

Data Sheet for FCC Radar Type 5						
Trial Number:		18		VSG Frequency(MHz):		5259.3785
Number of Bursts in Trial:			19		Successful Detection: Yes	
Burst (8-20)	Number Pulses per Burst (1-3)	Pulse Width (50-100)	Chirp Width (5-20)	Pulse 1-to-2 Spacing	Pulse 2-to-3 Spacing	Starting Location Within Interval
		(μ sec)	(MHz)	(μ sec)	(μ sec)	(μ sec)
1	2	74.7	18	1195.3		397610
2	3	92.2	18	986.8	1411.8	548460
3	1	63.1	18			73913
4	3	89.4	18	1857.6	1340.6	225288
5	1	57.5	18			379635
6	2	69.6	18	1755.4		530955
7	1	62.1	18			55066
8	3	92.3	18	1823.7	1520.7	206531
9	3	90.1	18	1411.9	1426.9	359180
10	2	83.3	18	1525.7		511995
11	2	82.5	18	920.5		36177
12	1	50	18			189009
13	1	56	18			341672
14	3	93.4	18	958.6	1162.6	492876
15	1	57.1	18			17384
16	3	96.9	18	1903.1	1547.1	169257
17	3	95.7	18	1611.3	1631.3	321056
18	3	91.5	18	1837.5	1020.5	473521
19	2	78.5	18	1722.5		626753

Unless otherwise stated the results shown in this test report refer only to the sample(s) tested and such sample(s) are retained for 90 days only.

除非另有說明，此報告結果僅對測試之樣品負責，同時此樣品僅保留90天。本報告未經本公司書面許可，不可部份複製。

This document is issued by the Company subject to its General Conditions of Service printed overleaf, available on request or accessible at <http://www.sgs.com.tw/Terms-and-Conditions> and for electronic format documents, subject to Terms and Conditions for Electronic Documents at <http://www.sgs.com.tw/Terms-and-Conditions>. Attention is drawn to the limitation of liability, indemnification and jurisdiction issues defined therein. Any holder of this document is advised that information contained hereon reflects the Company's findings at the time of its intervention only and within the limits of Client's instructions, if any. The Company's sole responsibility is to its Client and this document does not exonerate parties to a transaction from exercising all their rights and obligations under the transaction documents. This document cannot be reproduced except in full, without prior written approval of the Company. Any unauthorized alteration, forgery or falsification of the content or appearance of this document is unlawful and offenders may be prosecuted to the fullest extent of the law.

14.6.19 Trial 19:

Data Sheet for FCC Radar Type 5						
Trial Number:		19		VSG Frequency(MHz):		5259.3785
Number of Bursts in Trial:			19		Successful Detection: Yes	
Burst (8-20)	Number Pulses per Burst (1-3)	Pulse Width (50-100)	Chirp Width (5-20)	Pulse 1-to-2 Spacing	Pulse 2-to-3 Spacing	Starting Location Within Interval
		(μ sec)	(MHz)	(μ sec)	(μ sec)	(μ sec)
1	1	64.1	18			151404
2	2	68.7	18	1329.3		303636
3	2	67.7	18	1621.3		455897
4	2	80.9	18	925.1		608478
5	1	53.7	18			132455
6	3	90.7	18	1583.3	965.3	284045
7	1	53.7	18			438429
8	1	60.7	18			591109
9	3	86.6	18	1369.4	1362.4	113150
10	2	70.7	18	1328.3		266125
11	1	62.2	18			419294
12	2	73.9	18	1043.1		571533
13	1	56.5	18			94839
14	1	62.7	18			247847
15	3	98	18	1526	1572	398132
16	1	58.4	18			553311
17	1	51.1	18			76048
18	1	56.6	18			228873
19	2	82.8	18	1720.2		380555

Unless otherwise stated the results shown in this test report refer only to the sample(s) tested and such sample(s) are retained for 90 days only.

除非另有說明，此報告結果僅對測試之樣品負責，同時此樣品僅保留90天。本報告未經本公司書面許可，不可部份複製。

This document is issued by the Company subject to its General Conditions of Service printed overleaf, available on request or accessible at <http://www.sgs.com.tw/Terms-and-Conditions> and for electronic format documents, subject to Terms and Conditions for Electronic Documents at <http://www.sgs.com.tw/Terms-and-Conditions>. Attention is drawn to the limitation of liability, indemnification and jurisdiction issues defined therein. Any holder of this document is advised that information contained hereon reflects the Company's findings at the time of its intervention only and within the limits of Client's instructions, if any. The Company's sole responsibility is to its Client and this document does not exonerate parties to a transaction from exercising all their rights and obligations under the transaction documents. This document cannot be reproduced except in full, without prior written approval of the Company. Any unauthorized alteration, forgery or falsification of the content or appearance of this document is unlawful and offenders may be prosecuted to the fullest extent of the law.

14.6.20 Trial 20:

Data Sheet for FCC Radar Type 5						
Trial Number:		20		VSG Frequency(MHz):		5259.3785
Number of Bursts in Trial:			19		Successful Detection: Yes	
Burst (8-20)	Number Pulses per Burst (1-3)	Pulse Width (50-100)	Chirp Width (5-20)	Pulse 1-to-2 Spacing	Pulse 2-to-3 Spacing	Starting Location Within Interval
		(μ sec)	(MHz)	(μ sec)	(μ sec)	(μ sec)
1	3	97.3	18	1385.7	1004.7	532247
2	2	78.3	18	1527.7		57131
3	3	86.3	18	1377.7	941.7	209175
4	2	75.6	18	1300.4		361912
5	3	97.1	18	1425.9	1562.9	512859
6	1	61.3	18			38427
7	3	94.7	18	1832.3	1797.3	189951
8	3	99.9	18	1615.1	1227.1	342491
9	3	96.2	18	1114.8	1128.8	495260
10	2	72.7	18	1002.3		19590
11	2	71.8	18	1446.2		172045
12	2	81.1	18	1817.9		324012
13	3	97.1	18	911.9	1082.9	476328
14	2	76.9	18	1550.1		795
15	3	90.2	18	1815.8	1585.8	152759
16	3	92	18	1261	1695	304775
17	1	60.6	18			459016
18	1	57	18			612493
19	1	61.2	18			134877

Unless otherwise stated the results shown in this test report refer only to the sample(s) tested and such sample(s) are retained for 90 days only.

除非另有說明，此報告結果僅對測試之樣品負責，同時此樣品僅保留90天。本報告未經本公司書面許可，不可部份複製。

This document is issued by the Company subject to its General Conditions of Service printed overleaf, available on request or accessible at <http://www.sgs.com.tw/Terms-and-Conditions> and for electronic format documents, subject to Terms and Conditions for Electronic Documents at <http://www.sgs.com.tw/Terms-and-Conditions>. Attention is drawn to the limitation of liability, indemnification and jurisdiction issues defined therein. Any holder of this document is advised that information contained hereon reflects the Company's findings at the time of its intervention only and within the limits of Client's instructions, if any. The Company's sole responsibility is to its Client and this document does not exonerate parties to a transaction from exercising all their rights and obligations under the transaction documents. This document cannot be reproduced except in full, without prior written approval of the Company. Any unauthorized alteration, forgery or falsification of the content or appearance of this document is unlawful and offenders may be prosecuted to the fullest extent of the law.

14.6.21 Trial 21:

Data Sheet for FCC Radar Type 5						
Trial Number:		21		VSG Frequency(MHz):		5323.4215
Number of Bursts in Trial:			13		Successful Detection: Yes	
Burst (8-20)	Number Pulses per Burst (1-3)	Pulse Width (50-100)	Chirp Width (5-20)	Pulse 1-to-2 Spacing	Pulse 2-to-3 Spacing	Starting Location Within Interval
		(μ sec)	(MHz)	(μ sec)	(μ sec)	(μ sec)
1	1	59.3	11			420586
2	3	98.7	11	1621.3	1301.3	641808
3	1	53.8	11			867823
4	1	58.9	11			169631
5	2	75.5	11	1554.5		392320
6	2	71.5	11	1535.5		615399
7	2	77.8	11	1860.2		838671
8	1	59.4	11			142128
9	2	76	11	1021		365105
10	3	87.3	11	1224.7	1506.7	587038
11	1	58.1	11			813032
12	3	84.9	11	1098.1	1553.1	114183
13	1	55.9	11			337935

Unless otherwise stated the results shown in this test report refer only to the sample(s) tested and such sample(s) are retained for 90 days only.

除非另有說明，此報告結果僅對測試之樣品負責，同時此樣品僅保留90天。本報告未經本公司書面許可，不可部份複製。

This document is issued by the Company subject to its General Conditions of Service printed overleaf, available on request or accessible at <http://www.sgs.com.tw/Terms-and-Conditions> and for electronic format documents, subject to Terms and Conditions for Electronic Documents at <http://www.sgs.com.tw/Terms-and-Conditions>. Attention is drawn to the limitation of liability, indemnification and jurisdiction issues defined therein. Any holder of this document is advised that information contained hereon reflects the Company's findings at the time of its intervention only and within the limits of Client's instructions, if any. The Company's sole responsibility is to its Client and this document does not exonerate parties to a transaction from exercising all their rights and obligations under the transaction documents. This document cannot be reproduced except in full, without prior written approval of the Company. Any unauthorized alteration, forgery or falsification of the content or appearance of this document is unlawful and offenders may be prosecuted to the fullest extent of the law.

14.6.22 Trial 22:

Data Sheet for FCC Radar Type 5						
Trial Number:		22		VSG Frequency(MHz):		5323.8215
Number of Bursts in Trial:			12		Successful Detection: Yes	
Burst (8-20)	Number Pulses per Burst (1-3)	Pulse Width (50-100)	Chirp Width (5-20)	Pulse 1-to-2 Spacing	Pulse 2-to-3 Spacing	Starting Location Within Interval
		(μ sec)	(MHz)	(μ sec)	(μ sec)	(μ sec)
1	3	90.2	10	1273.8	1204.8	606736
2	1	62.9	10			850876
3	3	94.2	10	1482.8	1602.8	93968
4	1	50.2	10			336477
5	2	77.8	10	936.2		577757
6	3	93.2	10	1579.8	1677.8	817990
7	2	70.7	10	1139.3		64356
8	2	69.6	10	1677.4		306218
9	1	59.1	10			548542
10	3	90.9	10	1382.1	993.1	788888
11	1	57.5	10			34613
12	3	88.1	10	923.9	1836.9	275921

Unless otherwise stated the results shown in this test report refer only to the sample(s) tested and such sample(s) are retained for 90 days only.

除非另有說明，此報告結果僅對測試之樣品負責，同時此樣品僅保留90天。本報告未經本公司書面許可，不可部份複製。

This document is issued by the Company subject to its General Conditions of Service printed overleaf, available on request or accessible at <http://www.sgs.com.tw/Terms-and-Conditions> and for electronic format documents, subject to Terms and Conditions for Electronic Documents at <http://www.sgs.com.tw/Terms-and-Conditions>. Attention is drawn to the limitation of liability, indemnification and jurisdiction issues defined therein. Any holder of this document is advised that information contained hereon reflects the Company's findings at the time of its intervention only and within the limits of Client's instructions, if any. The Company's sole responsibility is to its Client and this document does not exonerate parties to a transaction from exercising all their rights and obligations under the transaction documents. This document cannot be reproduced except in full, without prior written approval of the Company. Any unauthorized alteration, forgery or falsification of the content or appearance of this document is unlawful and offenders may be prosecuted to the fullest extent of the law.

14.6.23 Trial 23:

Data Sheet for FCC Radar Type 5						
Trial Number:		23		VSG Frequency(MHz):		5322.2215
Number of Bursts in Trial:			15		Successful Detection: Yes	
Burst (8-20)	Number Pulses per Burst (1-3)	Pulse Width (50-100)	Chirp Width (5-20)	Pulse 1-to-2 Spacing	Pulse 2-to-3 Spacing	Starting Location Within Interval
		(μ sec)	(MHz)	(μ sec)	(μ sec)	(μ sec)
1	1	64.7	14			415120
2	3	89.6	14	1085.4	1597.4	606453
3	1	65.2	14			3836
4	3	97.1	14	1273.9	1796.9	196765
5	1	66.3	14			391306
6	2	70.7	14	1892.3		583184
7	3	87.3	14	1673.7	1200.7	775695
8	1	51.4	14			173646
9	3	90	14	998	1587	366139
10	3	97.3	14	1723.7	1681.7	558113
11	3	84.2	14	1194.8	1188.8	752330
12	3	93.5	14	1780.5	1458.5	149161
13	2	69.3	14	1497.7		342569
14	1	60.7	14			537050
15	1	54	14			730970

Unless otherwise stated the results shown in this test report refer only to the sample(s) tested and such sample(s) are retained for 90 days only.

除非另有說明，此報告結果僅對測試之樣品負責，同時此樣品僅保留90天。本報告未經本公司書面許可，不可部份複製。

This document is issued by the Company subject to its General Conditions of Service printed overleaf, available on request or accessible at <http://www.sgs.com.tw/Terms-and-Conditions> and for electronic format documents, subject to Terms and Conditions for Electronic Documents at <http://www.sgs.com.tw/Terms-and-Conditions>. Attention is drawn to the limitation of liability, indemnification and jurisdiction issues defined therein. Any holder of this document is advised that information contained hereon reflects the Company's findings at the time of its intervention only and within the limits of Client's instructions, if any. The Company's sole responsibility is to its Client and this document does not exonerate parties to a transaction from exercising all their rights and obligations under the transaction documents. This document cannot be reproduced except in full, without prior written approval of the Company. Any unauthorized alteration, forgery or falsification of the content or appearance of this document is unlawful and offenders may be prosecuted to the fullest extent of the law.

14.6.24 Trial 24:

Data Sheet for FCC Radar Type 5						
Trial Number:		24		VSG Frequency(MHz):		5320.2215
Number of Bursts in Trial:			20		Successful Detection: Yes	
Burst (8-20)	Number Pulses per Burst (1-3)	Pulse Width (50-100)	Chirp Width (5-20)	Pulse 1-to-2 Spacing	Pulse 2-to-3 Spacing	Starting Location Within Interval
		(μ sec)	(MHz)	(μ sec)	(μ sec)	(μ sec)
1	2	69.3	19	1293.7		94192
2	1	51.9	19			239745
3	2	68.6	19	1582.4		383859
4	1	62.5	19			529765
5	3	88.1	19	915.9	1048.9	76228
6	3	87.8	19	1104.2	1140.2	220653
7	1	65.8	19			366886
8	3	90.9	19	1123.1	1324.1	509849
9	3	84.2	19	1904.8	1361.8	58326
10	2	82.8	19	1605.2		203265
11	3	90	19	1177	1126	347500
12	1	64.1	19			494229
13	2	67.4	19	1012.6		40688
14	3	86.4	19	1558.6	1100.6	185058
15	3	91.7	19	1461.3	1772.3	329175
16	1	50.2	19			476294
17	1	57.7	19			22880
18	3	96.3	19	1617.7	1315.7	167054
19	2	70.9	19	1872.1		311966
20	1	60.7	19			458616

Unless otherwise stated the results shown in this test report refer only to the sample(s) tested and such sample(s) are retained for 90 days only.

除非另有說明，此報告結果僅對測試之樣品負責，同時此樣品僅保留90天。本報告未經本公司書面許可，不可部份複製。

This document is issued by the Company subject to its General Conditions of Service printed overleaf, available on request or accessible at <http://www.sgs.com.tw/Terms-and-Conditions> and for electronic format documents, subject to Terms and Conditions for Electronic Documents at <http://www.sgs.com.tw/Terms-and-Conditions>. Attention is drawn to the limitation of liability, indemnification and jurisdiction issues defined therein. Any holder of this document is advised that information contained hereon reflects the Company's findings at the time of its intervention only and within the limits of Client's instructions, if any. The Company's sole responsibility is to its Client and this document does not exonerate parties to a transaction from exercising all their rights and obligations under the transaction documents. This document cannot be reproduced except in full, without prior written approval of the Company. Any unauthorized alteration, forgery or falsification of the content or appearance of this document is unlawful and offenders may be prosecuted to the fullest extent of the law.

14.6.25 Trial 25:

Data Sheet for FCC Radar Type 5						
Trial Number:		25		VSG Frequency(MHz):		5319.8215
Number of Bursts in Trial:			20		Successful Detection: Yes	
Burst (8-20)	Number Pulses per Burst (1-3)	Pulse Width (50-100)	Chirp Width (5-20)	Pulse 1-to-2 Spacing	Pulse 2-to-3 Spacing	Starting Location Within Interval
		(μ sec)	(MHz)	(μ sec)	(μ sec)	(μ sec)
1	2	81.9	20	1747.1		4972
2	1	62.6	20			150270
3	1	62.4	20			295146
4	1	59.6	20			440705
5	1	66.6	20			585945
6	2	70.9	20	1927.1		131840
7	3	83.4	20	1273.6	1651.6	275953
8	1	66	20			422341
9	3	93	20	1287	1229	565394
10	2	78.7	20	1908.3		113975
11	1	50.6	20			259629
12	2	80.9	20	1405.1		403645
13	2	67	20	1119		548813
14	3	89.2	20	1509.8	1008.8	96014
15	1	51.4	20			241566
16	2	67.6	20	1374.4		386144
17	3	90.5	20	1318.5	1145.5	529515
18	2	78.4	20	1374.6		78447
19	2	69.5	20	1465.5		223236
20	1	50.2	20			368841

Unless otherwise stated the results shown in this test report refer only to the sample(s) tested and such sample(s) are retained for 90 days only.

除非另有說明，此報告結果僅對測試之樣品負責，同時此樣品僅保留90天。本報告未經本公司書面許可，不可部份複製。

This document is issued by the Company subject to its General Conditions of Service printed overleaf, available on request or accessible at <http://www.sgs.com.tw/Terms-and-Conditions> and for electronic format documents, subject to Terms and Conditions for Electronic Documents at <http://www.sgs.com.tw/Terms-and-Conditions>. Attention is drawn to the limitation of liability, indemnification and jurisdiction issues defined therein. Any holder of this document is advised that information contained hereon reflects the Company's findings at the time of its intervention only and within the limits of Client's instructions, if any. The Company's sole responsibility is to its Client and this document does not exonerate parties to a transaction from exercising all their rights and obligations under the transaction documents. This document cannot be reproduced except in full, without prior written approval of the Company. Any unauthorized alteration, forgery or falsification of the content or appearance of this document is unlawful and offenders may be prosecuted to the fullest extent of the law.

14.6.26 Trial 26:

Data Sheet for FCC Radar Type 5						
Trial Number:		26		VSG Frequency(MHz):		5320.6215
Number of Bursts in Trial:			18		Successful Detection: Yes	
Burst (8-20)	Number Pulses per Burst (1-3)	Pulse Width (50-100)	Chirp Width (5-20)	Pulse 1-to-2 Spacing	Pulse 2-to-3 Spacing	Starting Location Within Interval
		(μ sec)	(MHz)	(μ sec)	(μ sec)	(μ sec)
1	3	98.9	18	1308.1	1758.1	568650
2	3	98.7	18	1695.3	1690.3	67123
3	2	81	18	929		228397
4	1	64.3	18			390410
5	2	76.4	18	1343.6		550359
6	1	56.5	18			47616
7	2	69.8	18	1199.2		208712
8	1	65.1	18			370179
9	3	98.3	18	1534.7	1270.7	528943
10	3	97	18	1717	1581	27624
11	2	76.4	18	1683.6		188468
12	3	97.3	18	1588.7	1219.7	348918
13	3	98.5	18	1611.5	1263.5	509458
14	3	100	18	1471	1010	7870
15	2	72.1	18	1282.9		168818
16	1	56.6	18			330451
17	3	89.6	18	1459.4	1814.4	489199
18	1	59	18			653547

Unless otherwise stated the results shown in this test report refer only to the sample(s) tested and such sample(s) are retained for 90 days only.

除非另有說明，此報告結果僅對測試之樣品負責，同時此樣品僅保留90天。本報告未經本公司書面許可，不可部份複製。

This document is issued by the Company subject to its General Conditions of Service printed overleaf, available on request or accessible at <http://www.sgs.com.tw/Terms-and-Conditions> and for electronic format documents, subject to Terms and Conditions for Electronic Documents at <http://www.sgs.com.tw/Terms-and-Conditions>. Attention is drawn to the limitation of liability, indemnification and jurisdiction issues defined therein. Any holder of this document is advised that information contained hereon reflects the Company's findings at the time of its intervention only and within the limits of Client's instructions, if any. The Company's sole responsibility is to its Client and this document does not exonerate parties to a transaction from exercising all their rights and obligations under the transaction documents. This document cannot be reproduced except in full, without prior written approval of the Company. Any unauthorized alteration, forgery or falsification of the content or appearance of this document is unlawful and offenders may be prosecuted to the fullest extent of the law.

14.6.27 Trial 27:

Data Sheet for FCC Radar Type 5						
Trial Number:		27		VSG Frequency(MHz):		5324.2215
Number of Bursts in Trial:			11		Successful Detection: Yes	
Burst (8-20)	Number Pulses per Burst (1-3)	Pulse Width (50-100)	Chirp Width (5-20)	Pulse 1-to-2 Spacing	Pulse 2-to-3 Spacing	Starting Location Within Interval
		(μ sec)	(MHz)	(μ sec)	(μ sec)	(μ sec)
1	3	96	9	964	1269	244138
2	2	67.1	9	1167.9		508034
3	1	54.3	9			772920
4	3	99.9	9	1046.1	1220.1	1035183
5	3	98	9	1600	940	211483
6	1	55.5	9			476199
7	2	82.1	9	1539.9		739691
8	1	59.1	9			1005073
9	3	97.1	9	1569.9	1053.9	179037
10	2	78.3	9	1685.7		442966
11	3	85	9	1745	1510	705622

Unless otherwise stated the results shown in this test report refer only to the sample(s) tested and such sample(s) are retained for 90 days only.

除非另有說明，此報告結果僅對測試之樣品負責，同時此樣品僅保留90天。本報告未經本公司書面許可，不可部份複製。

This document is issued by the Company subject to its General Conditions of Service printed overleaf, available on request or accessible at <http://www.sgs.com.tw/Terms-and-Conditions> and for electronic format documents, subject to Terms and Conditions for Electronic Documents at <http://www.sgs.com.tw/Terms-and-Conditions>. Attention is drawn to the limitation of liability, indemnification and jurisdiction issues defined therein. Any holder of this document is advised that information contained hereon reflects the Company's findings at the time of its intervention only and within the limits of Client's instructions, if any. The Company's sole responsibility is to its Client and this document does not exonerate parties to a transaction from exercising all their rights and obligations under the transaction documents. This document cannot be reproduced except in full, without prior written approval of the Company. Any unauthorized alteration, forgery or falsification of the content or appearance of this document is unlawful and offenders may be prosecuted to the fullest extent of the law.

14.6.28 Trial 28:

Data Sheet for FCC Radar Type 5						
Trial Number:		28		VSG Frequency(MHz):		5321.0215
Number of Bursts in Trial:			18		Successful Detection: Yes	
Burst (8-20)	Number Pulses per Burst (1-3)	Pulse Width (50-100)	Chirp Width (5-20)	Pulse 1-to-2 Spacing	Pulse 2-to-3 Spacing	Starting Location Within Interval
		(μ sec)	(MHz)	(μ sec)	(μ sec)	(μ sec)
1	2	74	17	1226		592566
2	1	59.8	17			89732
3	2	79.3	17	1839.7		250502
4	2	76.7	17	1083.3		411804
5	2	70.6	17	1421.4		572049
6	1	61.8	17			69871
7	2	83.2	17	1608.8		230717
8	2	81.7	17	1839.3		391658
9	3	98.1	17	1843.9	1145.9	551342
10	2	83.3	17	1716.7		49863
11	1	60	17			211312
12	1	51	17			372850
13	2	68.2	17	1899.8		532734
14	2	67.8	17	1688.2		30024
15	3	96	17	1446	1613	190604
16	1	52.3	17			352547
17	1	53.4	17			513835
18	2	82.4	17	1680.6		10225

Unless otherwise stated the results shown in this test report refer only to the sample(s) tested and such sample(s) are retained for 90 days only.

除非另有說明，此報告結果僅對測試之樣品負責，同時此樣品僅保留90天。本報告未經本公司書面許可，不可部份複製。

This document is issued by the Company subject to its General Conditions of Service printed overleaf, available on request or accessible at <http://www.sgs.com.tw/Terms-and-Conditions> and for electronic format documents, subject to Terms and Conditions for Electronic Documents at <http://www.sgs.com.tw/Terms-and-Conditions>. Attention is drawn to the limitation of liability, indemnification and jurisdiction issues defined therein. Any holder of this document is advised that information contained hereon reflects the Company's findings at the time of its intervention only and within the limits of Client's instructions, if any. The Company's sole responsibility is to its Client and this document does not exonerate parties to a transaction from exercising all their rights and obligations under the transaction documents. This document cannot be reproduced except in full, without prior written approval of the Company. Any unauthorized alteration, forgery or falsification of the content or appearance of this document is unlawful and offenders may be prosecuted to the fullest extent of the law.

14.6.29 Trial 29:

Data Sheet for FCC Radar Type 5						
Trial Number:		29		VSG Frequency(MHz):		5325.4215
Number of Bursts in Trial:			8		Successful Detection: Yes	
Burst (8-20)	Number Pulses per Burst (1-3)	Pulse Width (50-100)	Chirp Width (5-20)	Pulse 1-to-2 Spacing	Pulse 2-to-3 Spacing	Starting Location Within Interval
		(μ sec)	(MHz)	(μ sec)	(μ sec)	(μ sec)
1	2	67	6	1136		386176
2	2	67	6	975		749473
3	3	94.8	6	946.2	1399.2	1111261
4	2	78.1	6	1873.9		1475197
5	2	81.4	6	1855.6		341314
6	2	82.5	6	1477.5		704354
7	1	52.3	6			1068403
8	3	95.9	6	1723.1	1465.1	1429278

Unless otherwise stated the results shown in this test report refer only to the sample(s) tested and such sample(s) are retained for 90 days only.

除非另有說明，此報告結果僅對測試之樣品負責，同時此樣品僅保留90天。本報告未經本公司書面許可，不可部份複製。

This document is issued by the Company subject to its General Conditions of Service printed overleaf, available on request or accessible at <http://www.sgs.com.tw/Terms-and-Conditions> and for electronic format documents, subject to Terms and Conditions for Electronic Documents at <http://www.sgs.com.tw/Terms-and-Conditions>. Attention is drawn to the limitation of liability, indemnification and jurisdiction issues defined therein. Any holder of this document is advised that information contained hereon reflects the Company's findings at the time of its intervention only and within the limits of Client's instructions, if any. The Company's sole responsibility is to its Client and this document does not exonerate parties to a transaction from exercising all their rights and obligations under the transaction documents. This document cannot be reproduced except in full, without prior written approval of the Company. Any unauthorized alteration, forgery or falsification of the content or appearance of this document is unlawful and offenders may be prosecuted to the fullest extent of the law.

14.6.30 Trial 30:

Data Sheet for FCC Radar Type 5						
Trial Number:		30		VSG Frequency(MHz):		5321.0215
Number of Bursts in Trial:			18		Successful Detection: Yes	
Burst (8-20)	Number Pulses per Burst (1-3)	Pulse Width (50-100)	Chirp Width (5-20)	Pulse 1-to-2 Spacing	Pulse 2-to-3 Spacing	Starting Location Within Interval
		(μ sec)	(MHz)	(μ sec)	(μ sec)	(μ sec)
1	3	99.1	17	1050.9	1191.9	131268
2	1	50.7	17			293150
3	2	75.5	17	1479.5		453485
4	2	82.2	17	1702.8		613895
5	2	67.3	17	1725.7		111637
6	1	59.4	17			273119
7	3	91.5	17	1718.5	1057.5	432670
8	2	80.2	17	1136.8		594976
9	2	74.2	17	975.8		91921
10	3	87.2	17	1141.8	1835.8	252079
11	3	97.2	17	1803.8	1028.8	413002
12	2	70.5	17	1487.5		574498
13	2	77.9	17	1638.1		71981
14	3	88.2	17	1134.8	1636.8	232616
15	3	88.9	17	1484.1	1059.1	393436
16	2	74.9	17	1917.1		554812
17	3	91.5	17	1591.5	1728.5	52089
18	2	75.8	17	1480.2		213172

Unless otherwise stated the results shown in this test report refer only to the sample(s) tested and such sample(s) are retained for 90 days only.

除非另有說明，此報告結果僅對測試之樣品負責，同時此樣品僅保留90天。本報告未經本公司書面許可，不可部份複製。

This document is issued by the Company subject to its General Conditions of Service printed overleaf, available on request or accessible at <http://www.sgs.com.tw/Terms-and-Conditions> and for electronic format documents, subject to Terms and Conditions for Electronic Documents at <http://www.sgs.com.tw/Terms-and-Conditions>. Attention is drawn to the limitation of liability, indemnification and jurisdiction issues defined therein. Any holder of this document is advised that information contained hereon reflects the Company's findings at the time of its intervention only and within the limits of Client's instructions, if any. The Company's sole responsibility is to its Client and this document does not exonerate parties to a transaction from exercising all their rights and obligations under the transaction documents. This document cannot be reproduced except in full, without prior written approval of the Company. Any unauthorized alteration, forgery or falsification of the content or appearance of this document is unlawful and offenders may be prosecuted to the fullest extent of the law.

14.7 Radar Type 6 for 5290 MHz:

Data Sheet for FCC Radar Type 6						
Trial	Pulse Width	PRI	Pulses per Hop	Hopping Rate	Hopping Sequence Length	Successful Detection
	(μ sec)	(μ sec)		(kHz)	(msec)	(Yes/No)
1	1	333	9	0.333	300	Yes
2	1	333	9	0.333	300	Yes
3	1	333	9	0.333	300	Yes
4	1	333	9	0.333	300	Yes
5	1	333	9	0.333	300	Yes
6	1	333	9	0.333	300	Yes
7	1	333	9	0.333	300	Yes
8	1	333	9	0.333	300	Yes
9	1	333	9	0.333	300	Yes
10	1	333	9	0.333	300	Yes
11	1	333	9	0.333	300	Yes
12	1	333	9	0.333	300	Yes
13	1	333	9	0.333	300	Yes
14	1	333	9	0.333	300	Yes
15	1	333	9	0.333	300	Yes
16	1	333	9	0.333	300	Yes
17	1	333	9	0.333	300	Yes
18	1	333	9	0.333	300	Yes
19	1	333	9	0.333	300	Yes
20	1	333	9	0.333	300	Yes
21	1	333	9	0.333	300	Yes
22	1	333	9	0.333	300	Yes
23	1	333	9	0.333	300	Yes
24	1	333	9	0.333	300	Yes
25	1	333	9	0.333	300	Yes
26	1	333	9	0.333	300	Yes
27	1	333	9	0.333	300	Yes
28	1	333	9	0.333	300	Yes
29	1	333	9	0.333	300	Yes
30	1	333	9	0.333	300	Yes

Unless otherwise stated the results shown in this test report refer only to the sample(s) tested and such sample(s) are retained for 90 days only.

除非另有說明，此報告結果僅對測試之樣品負責，同時此樣品僅保留90天。本報告未經本公司書面許可，不可部份複製。

This document is issued by the Company subject to its General Conditions of Service printed overleaf, available on request or accessible at <http://www.sgs.com.tw/Terms-and-Conditions> and for electronic format documents, subject to Terms and Conditions for Electronic Documents at <http://www.sgs.com.tw/Terms-and-Conditions>. Attention is drawn to the limitation of liability, indemnification and jurisdiction issues defined therein. Any holder of this document is advised that information contained hereon reflects the Company's findings at the time of its intervention only and within the limits of Client's instructions, if any. The Company's sole responsibility is to its Client and this document does not exonerate parties to a transaction from exercising all their rights and obligations under the transaction documents. This document cannot be reproduced except in full, without prior written approval of the Company. Any unauthorized alteration, forgery or falsification of the content or appearance of this document is unlawful and offenders may be prosecuted to the fullest extent of the law.

14.8 5310MHz:

Short Pulse Radar Type	Minimum Number of Trials	Detection(%)		Minmum Percentage of Successful Detection(%)	Pass/Fail
1	30	80		60	Pass
2	30	100		60	Pass
3	30	100		60	Pass
4	30	90		60	Pass
Aggregate (Radar Types 1-4)	120	92.5		80	Pass
Long Pulse Radar Type	Minimum Number of Trials	Each Detection(%)	Total Detection(%)	Minmum Percentage of Successful Detection(%)	Pass/Fail
5	Center:10	70	83.33333333	80	Pass
	Low Edge:10	90			
	High Edge:10	90			
Frequency Hopping Radar Type	Minimum Number of Trials	Detection(%)		Minmum Percentage of Successful Detection(%)	Pass/Fail
6	30	96.66666667		70	Pass

Unless otherwise stated the results shown in this test report refer only to the sample(s) tested and such sample(s) are retained for 90 days only.

除非另有說明，此報告結果僅對測試之樣品負責，同時此樣品僅保留90天。本報告未經本公司書面許可，不可部份複製。

This document is issued by the Company subject to its General Conditions of Service printed overleaf, available on request or accessible at <http://www.sgs.com.tw/Terms-and-Conditions> and for electronic format documents, subject to Terms and Conditions for Electronic Documents at <http://www.sgs.com.tw/Terms-and-Conditions>. Attention is drawn to the limitation of liability, indemnification and jurisdiction issues defined therein. Any holder of this document is advised that information contained hereon reflects the Company's findings at the time of its intervention only and within the limits of Client's instructions, if any. The Company's sole responsibility is to its Client and this document does not exonerate parties to a transaction from exercising all their rights and obligations under the transaction documents. This document cannot be reproduced except in full, without prior written approval of the Company. Any unauthorized alteration, forgery or falsification of the content or appearance of this document is unlawful and offenders may be prosecuted to the fullest extent of the law.

14.9 Radar Type 1 for 5310 MHz:

Data Sheet for FCC Radar Type 1						
Trial	VSG Frequency (MHz)	Pulse Repetition Frequency Number (1 to 23)	Pulse Repetition Frequency	PRI (msec)	Test A/B A/B	Successful Detection (Yes/No)
			(Pulses Per Second)			
1	5310	16	1222.5	818	A	Yes
2	5310	12	1355	738	A	Yes
3	5310	11	1392.8	718	A	Yes
4	5310	17	1193.3	838	A	Yes
5	5310	9	1474.9	678	A	Yes
6	5310	10	1432.7	698	A	Yes
7	5310	4	1730.1	578	A	Yes
8	5310	15	1253.1	798	A	Yes
9	5310	8	1519.8	658	A	Yes
10	5310	5	1672.2	598	A	Yes
11	5310	20	1113.6	898	A	Yes
12	5310	3	1792.1	558	A	Yes
13	5310	13	1319.3	758	A	Yes
14	5310	2	1858.7	538	A	Yes
15	5310	19	1139	878	A	Yes
16	5310	-	755.3	1324	B	Yes
17	5310	-	336.5	2972	B	No
18	5310	-	445	2247	B	Yes
19	5310	-	628.1	1592	B	Yes
20	5310	-	546.1	1831	B	No
21	5310	-	901.7	1109	B	Yes
22	5310	-	646	1548	B	No
23	5310	-	327.5	3053	B	Yes
24	5310	-	847.5	1180	B	Yes
25	5310	-	378.9	2639	B	No
26	5310	-	679.3	1472	B	No
27	5310	-	356.5	2805	B	Yes
28	5310	-	1100.1	909	B	Yes
29	5310	-	512.6	1951	B	No
30	5310	-	1179.2	848	B	Yes

Unless otherwise stated the results shown in this test report refer only to the sample(s) tested and such sample(s) are retained for 90 days only.

除非另有說明，此報告結果僅對測試之樣品負責，同時此樣品僅保留90天。本報告未經本公司書面許可，不可部份複製。

This document is issued by the Company subject to its General Conditions of Service printed overleaf, available on request or accessible at <http://www.sgs.com.tw/Terms-and-Conditions> and for electronic format documents, subject to Terms and Conditions for Electronic Documents at <http://www.sgs.com.tw/Terms-and-Conditions>. Attention is drawn to the limitation of liability, indemnification and jurisdiction issues defined therein. Any holder of this document is advised that information contained hereon reflects the Company's findings at the time of its intervention only and within the limits of Client's instructions, if any. The Company's sole responsibility is to its Client and this document does not exonerate parties to a transaction from exercising all their rights and obligations under the transaction documents. This document cannot be reproduced except in full, without prior written approval of the Company. Any unauthorized alteration, forgery or falsification of the content or appearance of this document is unlawful and offenders may be prosecuted to the fullest extent of the law.

14.10 Radar Type 2 for 5310 MHz:

Data Sheet for FCC Radar Type 2					
Trial	VSG Frequency (MHz)	Number Pulses per Burst (23-29)	Pulse Width (1-5)	PRI (150-230)	Successful Detection
			(μ s)	(μ s)	(Yes/No)
1	5310	25	2.2	191	Yes
2	5310	26	3.3	186	Yes
3	5310	29	4.8	227	Yes
4	5310	29	5	185	Yes
5	5310	25	2.1	222	Yes
6	5310	28	4.5	175	Yes
7	5310	28	4	190	Yes
8	5310	23	1.1	220	Yes
9	5310	28	4.1	213	Yes
10	5310	23	1.1	223	Yes
11	5310	25	2.5	157	Yes
12	5310	26	2.8	217	Yes
13	5310	24	1.7	216	Yes
14	5310	24	1.6	179	Yes
15	5310	26	2.8	155	Yes
16	5310	25	2.7	196	Yes
17	5310	24	1.6	152	Yes
18	5310	25	2.2	170	Yes
19	5310	24	1.6	188	Yes
20	5310	24	1.7	178	Yes
21	5310	26	2.7	192	Yes
22	5310	24	2.1	197	Yes
23	5310	25	2.3	180	Yes
24	5310	23	1.2	221	Yes
25	5310	26	2.9	207	Yes
26	5310	27	3.7	209	Yes
27	5310	29	4.8	229	Yes
28	5310	29	5	212	Yes
29	5310	29	4.9	176	Yes
30	5310	27	3.4	160	Yes

Unless otherwise stated the results shown in this test report refer only to the sample(s) tested and such sample(s) are retained for 90 days only.

除非另有說明，此報告結果僅對測試之樣品負責，同時此樣品僅保留90天。本報告未經本公司書面許可，不可部份複製。

This document is issued by the Company subject to its General Conditions of Service printed overleaf, available on request or accessible at <http://www.sgs.com.tw/Terms-and-Conditions> and for electronic format documents, subject to Terms and Conditions for Electronic Documents at <http://www.sgs.com.tw/Terms-and-Conditions>. Attention is drawn to the limitation of liability, indemnification and jurisdiction issues defined therein. Any holder of this document is advised that information contained hereon reflects the Company's findings at the time of its intervention only and within the limits of Client's instructions, if any. The Company's sole responsibility is to its Client and this document does not exonerate parties to a transaction from exercising all their rights and obligations under the transaction documents. This document cannot be reproduced except in full, without prior written approval of the Company. Any unauthorized alteration, forgery or falsification of the content or appearance of this document is unlawful and offenders may be prosecuted to the fullest extent of the law.

14.11 Radar Type 3 for 5310 MHz:

Data Sheet for FCC Radar Type 3					
Trial	VSG Frequency (MHz)	Number Pulses per Burst (16-18)	Pulse Width (6-10)	PRI (200-500)	Successful Detection
			(μ s)	(μ s)	(Yes/No)
1	5310	16	7.2	379	Yes
2	5310	17	8.3	353	Yes
3	5310	18	9.8	462	Yes
4	5310	18	10	428	Yes
5	5310	16	7.1	354	Yes
6	5310	18	9.5	222	Yes
7	5310	18	9	364	Yes
8	5310	16	6.1	217	Yes
9	5310	18	9.1	387	Yes
10	5310	16	6.1	433	Yes
11	5310	17	7.5	246	Yes
12	5310	17	7.8	231	Yes
13	5310	16	6.7	228	Yes
14	5310	16	6.6	375	Yes
15	5310	17	7.8	304	Yes
16	5310	17	7.7	215	Yes
17	5310	16	6.6	500	Yes
18	5310	16	7.2	401	Yes
19	5310	16	6.6	216	Yes
20	5310	16	6.7	251	Yes
21	5310	17	7.7	202	Yes
22	5310	16	7.1	461	Yes
23	5310	16	7.3	267	Yes
24	5310	16	6.2	227	Yes
25	5310	17	7.9	362	Yes
26	5310	18	8.7	358	Yes
27	5310	18	9.8	204	Yes
28	5310	18	10	219	Yes
29	5310	18	9.9	315	Yes
30	5310	17	8.4	351	Yes

Unless otherwise stated the results shown in this test report refer only to the sample(s) tested and such sample(s) are retained for 90 days only.

除非另有說明，此報告結果僅對測試之樣品負責，同時此樣品僅保留90天。本報告未經本公司書面許可，不可部份複製。

This document is issued by the Company subject to its General Conditions of Service printed overleaf, available on request or accessible at <http://www.sgs.com.tw/Terms-and-Conditions> and for electronic format documents, subject to Terms and Conditions for Electronic Documents at <http://www.sgs.com.tw/Terms-and-Conditions>. Attention is drawn to the limitation of liability, indemnification and jurisdiction issues defined therein. Any holder of this document is advised that information contained hereon reflects the Company's findings at the time of its intervention only and within the limits of Client's instructions, if any. The Company's sole responsibility is to its Client and this document does not exonerate parties to a transaction from exercising all their rights and obligations under the transaction documents. This document cannot be reproduced except in full, without prior written approval of the Company. Any unauthorized alteration, forgery or falsification of the content or appearance of this document is unlawful and offenders may be prosecuted to the fullest extent of the law.

14.12 Radar Type 4 for 5310 MHz:

Data Sheet for FCC Radar Type 4					
Trial	VSG Frequency (MHz)	Number Pulses per Burst (12-16)	Pulse Width (11-20)	PRI (200-500)	Successful Detection
			(μ s)	(μ s)	(Yes/No)
1	5310	13	13.8	379	Yes
2	5310	14	16.1	353	Yes
3	5310	16	19.6	462	Yes
4	5310	16	19.9	428	No
5	5310	13	13.6	354	Yes
6	5310	16	18.7	222	Yes
7	5310	15	17.7	364	Yes
8	5310	12	11.2	217	Yes
9	5310	15	17.9	387	Yes
10	5310	12	11.3	433	Yes
11	5310	13	14.4	246	Yes
12	5310	14	15	231	Yes
13	5310	12	12.7	228	Yes
14	5310	12	12.4	375	Yes
15	5310	14	15	304	Yes
16	5310	14	14.8	215	Yes
17	5310	12	12.3	500	Yes
18	5310	13	13.7	401	Yes
19	5310	12	12.4	216	Yes
20	5310	12	12.7	251	Yes
21	5310	14	14.9	202	Yes
22	5310	13	13.4	461	No
23	5310	13	14	267	Yes
24	5310	12	11.4	227	Yes
25	5310	14	15.3	362	No
26	5310	15	17.1	358	Yes
27	5310	16	19.5	204	Yes
28	5310	16	20	219	Yes
29	5310	16	19.7	315	Yes
30	5310	14	16.4	351	Yes

Unless otherwise stated the results shown in this test report refer only to the sample(s) tested and such sample(s) are retained for 90 days only.

除非另有說明，此報告結果僅對測試之樣品負責，同時此樣品僅保留90天。本報告未經本公司書面許可，不可部份複製。

This document is issued by the Company subject to its General Conditions of Service printed overleaf, available on request or accessible at <http://www.sgs.com.tw/Terms-and-Conditions> and for electronic format documents, subject to Terms and Conditions for Electronic Documents at <http://www.sgs.com.tw/Terms-and-Conditions>. Attention is drawn to the limitation of liability, indemnification and jurisdiction issues defined therein. Any holder of this document is advised that information contained hereon reflects the Company's findings at the time of its intervention only and within the limits of Client's instructions, if any. The Company's sole responsibility is to its Client and this document does not exonerate parties to a transaction from exercising all their rights and obligations under the transaction documents. This document cannot be reproduced except in full, without prior written approval of the Company. Any unauthorized alteration, forgery or falsification of the content or appearance of this document is unlawful and offenders may be prosecuted to the fullest extent of the law.

14.13 Radar Type 5 for 5310 MHz:

14.13.1 Trial 1:

Data Sheet for FCC Radar Type 5						
Trial Number:		1		VSG Frequency(MHz):		5310
Number of Bursts in Trial:			14		Successful Detection: No	
Burst (8-20)	Number Pulses per Burst (1-3)	Pulse Width (50-100)	Chirp Width (5-20)	Pulse 1-to-2 Spacing	Pulse 2-to-3 Spacing	Starting Location Within Interval
		(μ sec)	(MHz)	(μ sec)	(μ sec)	(μ sec)
1	2	75.7	13	1450.3		646095
2	2	76.2	13	1835.8		853391
3	3	98.6	13	1660.4	1151.4	206260
4	1	60	13			414310
5	3	88.3	13	1410.7	982.7	620248
6	1	52	13			829565
7	3	92.7	13	1451.3	1091.3	180697
8	3	84.5	13	1906.5	1481.5	387097
9	2	79.4	13	1230.6		595173
10	3	86.3	13	1491.7	1529.7	801190
11	1	52.5	13			155846
12	1	65.8	13			363169
13	1	51.8	13			570697
14	3	96.5	13	919.5	1148.5	776534

Unless otherwise stated the results shown in this test report refer only to the sample(s) tested and such sample(s) are retained for 90 days only.

除非另有說明，此報告結果僅對測試之樣品負責，同時此樣品僅保留90天。本報告未經本公司書面許可，不可部份複製。

This document is issued by the Company subject to its General Conditions of Service printed overleaf, available on request or accessible at <http://www.sgs.com.tw/Terms-and-Conditions> and for electronic format documents, subject to Terms and Conditions for Electronic Documents at <http://www.sgs.com.tw/Terms-and-Conditions>. Attention is drawn to the limitation of liability, indemnification and jurisdiction issues defined therein. Any holder of this document is advised that information contained hereon reflects the Company's findings at the time of its intervention only and within the limits of Client's instructions, if any. The Company's sole responsibility is to its Client and this document does not exonerate parties to a transaction from exercising all their rights and obligations under the transaction documents. This document cannot be reproduced except in full, without prior written approval of the Company. Any unauthorized alteration, forgery or falsification of the content or appearance of this document is unlawful and offenders may be prosecuted to the fullest extent of the law.

14.13.2 Trial 2:

Data Sheet for FCC Radar Type 5						
Trial Number:		2		VSG Frequency(MHz):		5310
Number of Bursts in Trial:			14		Successful Detection: Yes	
Burst (8-20)	Number Pulses per Burst (1-3)	Pulse Width (50-100)	Chirp Width (5-20)	Pulse 1-to-2 Spacing	Pulse 2-to-3 Spacing	Starting Location Within Interval
		(μ sec)	(MHz)	(μ sec)	(μ sec)	(μ sec)
1	3	89.7	13	1178.3	976.3	129878
2	3	96.5	13	1823.5	1552.5	336196
3	2	78.6	13	1730.4		544288
4	3	92.6	13	1348.4	1150.4	750076
5	3	92.6	13	1533.4	1761.4	104294
6	3	93	13	1878	1609	310994
7	2	70.3	13	1860.7		518416
8	1	66	13			727353
9	2	78.7	13	1898.3		78905
10	3	96.3	13	954.7	1546.7	285586
11	3	97.7	13	1410.3	1595.3	492469
12	3	92.3	13	1052.7	1690.7	699494
13	1	65.3	13			53555
14	3	88.9	13	1411.1	1716.1	260074

Unless otherwise stated the results shown in this test report refer only to the sample(s) tested and such sample(s) are retained for 90 days only.

除非另有說明，此報告結果僅對測試之樣品負責，同時此樣品僅保留90天。本報告未經本公司書面許可，不可部份複製。

This document is issued by the Company subject to its General Conditions of Service printed overleaf, available on request or accessible at <http://www.sgs.com.tw/Terms-and-Conditions> and for electronic format documents, subject to Terms and Conditions for Electronic Documents at <http://www.sgs.com.tw/Terms-and-Conditions>. Attention is drawn to the limitation of liability, indemnification and jurisdiction issues defined therein. Any holder of this document is advised that information contained hereon reflects the Company's findings at the time of its intervention only and within the limits of Client's instructions, if any. The Company's sole responsibility is to its Client and this document does not exonerate parties to a transaction from exercising all their rights and obligations under the transaction documents. This document cannot be reproduced except in full, without prior written approval of the Company. Any unauthorized alteration, forgery or falsification of the content or appearance of this document is unlawful and offenders may be prosecuted to the fullest extent of the law.

14.13.3 Trial 3

Data Sheet for FCC Radar Type 5						
Trial Number:		3		VSG Frequency(MHz):		5310
Number of Bursts in Trial:			20		Successful Detection: Yes	
Burst (8-20)	Number Pulses per Burst (1-3)	Pulse Width (50-100)	Chirp Width (5-20)	Pulse 1-to-2 Spacing	Pulse 2-to-3 Spacing	Starting Location Within Interval
		(μ sec)	(MHz)	(μ sec)	(μ sec)	(μ sec)
1	1	53.1	20			327984
2	3	90	20	1789	1447	470347
3	2	82.3	20	1038.7		19538
4	2	76.2	20	1301.8		164251
5	2	80.3	20	1314.7		309125
6	3	91.2	20	1887.8	1592.8	452206
7	2	82.6	20	1648.4		1697
8	1	56.7	20			146959
9	2	69.4	20	1711.6		291322
10	2	71	20	1475		436052
11	3	97.9	20	1413.1	1179.1	579415
12	3	93.2	20	1553.8	1022.8	128485
13	2	72.1	20	1223.9		273557
14	3	94.6	20	1584.4	990.4	417454
15	3	90.4	20	1291.6	1396.6	561415
16	3	85.2	20	1173.8	1748.8	110459
17	3	95.3	20	1538.7	1756.7	254888
18	2	71.2	20	1839.8		400255
19	1	64.1	20			546815
20	2	74.5	20	1751.5		92943

Unless otherwise stated the results shown in this test report refer only to the sample(s) tested and such sample(s) are retained for 90 days only.

除非另有說明，此報告結果僅對測試之樣品負責，同時此樣品僅保留90天。本報告未經本公司書面許可，不可部份複製。

This document is issued by the Company subject to its General Conditions of Service printed overleaf, available on request or accessible at <http://www.sgs.com.tw/Terms-and-Conditions> and for electronic format documents, subject to Terms and Conditions for Electronic Documents at <http://www.sgs.com.tw/Terms-and-Conditions>. Attention is drawn to the limitation of liability, indemnification and jurisdiction issues defined therein. Any holder of this document is advised that information contained hereon reflects the Company's findings at the time of its intervention only and within the limits of Client's instructions, if any. The Company's sole responsibility is to its Client and this document does not exonerate parties to a transaction from exercising all their rights and obligations under the transaction documents. This document cannot be reproduced except in full, without prior written approval of the Company. Any unauthorized alteration, forgery or falsification of the content or appearance of this document is unlawful and offenders may be prosecuted to the fullest extent of the law.

14.13.4 Trial 4

Data Sheet for FCC Radar Type 5						
Trial Number:		4		VSG Frequency(MHz):		5310
Number of Bursts in Trial:			10		Successful Detection: No	
Burst (8-20)	Number Pulses per Burst (1-3)	Pulse Width (50-100)	Chirp Width (5-20)	Pulse 1-to-2 Spacing	Pulse 2-to-3 Spacing	Starting Location Within Interval
		(μ sec)	(MHz)	(μ sec)	(μ sec)	(μ sec)
1	2	71.3	8	1835.7		476618
2	1	57.3	8			768080
3	3	95.2	8	917.8	1522.8	1056357
4	2	82.8	8	1172.2		150695
5	2	79.5	8	1775.5		441008
6	2	68.9	8	1636.1		731474
7	1	53.6	8			1022491
8	1	59.6	8			115101
9	3	97.5	8	1330.5	1620.5	404670
10	1	52.3	8			696336

Unless otherwise stated the results shown in this test report refer only to the sample(s) tested and such sample(s) are retained for 90 days only.

除非另有說明，此報告結果僅對測試之樣品負責，同時此樣品僅保留90天。本報告未經本公司書面許可，不可部份複製。

This document is issued by the Company subject to its General Conditions of Service printed overleaf, available on request or accessible at <http://www.sgs.com.tw/Terms-and-Conditions> and for electronic format documents, subject to Terms and Conditions for Electronic Documents at <http://www.sgs.com.tw/Terms-and-Conditions>. Attention is drawn to the limitation of liability, indemnification and jurisdiction issues defined therein. Any holder of this document is advised that information contained hereon reflects the Company's findings at the time of its intervention only and within the limits of Client's instructions, if any. The Company's sole responsibility is to its Client and this document does not exonerate parties to a transaction from exercising all their rights and obligations under the transaction documents. This document cannot be reproduced except in full, without prior written approval of the Company. Any unauthorized alteration, forgery or falsification of the content or appearance of this document is unlawful and offenders may be prosecuted to the fullest extent of the law.

14.13.5 Trial 5

Data Sheet for FCC Radar Type 5						
Trial Number:		5		VSG Frequency(MHz):		5310
Number of Bursts in Trial:			17		Successful Detection: Yes	
Burst (8-20)	Number Pulses per Burst (1-3)	Pulse Width (50-100)	Chirp Width (5-20)	Pulse 1-to-2 Spacing	Pulse 2-to-3 Spacing	Starting Location Within Interval
		(μ sec)	(MHz)	(μ sec)	(μ sec)	(μ sec)
1	1	62.3	17			580292
2	3	96	17	1892	1376	46376
3	3	86.7	17	1845.3	1609.3	216364
4	1	53.7	17			388124
5	2	81.3	17	1741.7		557500
6	3	89.5	17	1284.5	1043.5	25448
7	1	53.9	17			196365
8	2	76.3	17	1248.7		366324
9	3	85.6	17	1399.4	1573.4	535403
10	1	60.6	17			4498
11	1	63.8	17			175244
12	2	82.9	17	1841.1		345455
13	2	77	17	950		516472
14	1	57.6	17			687535
15	3	94.7	17	1506.3	1682.3	153508
16	3	99.4	17	1072.6	1097.6	324212
17	2	70.8	17	1827.2		494914

Unless otherwise stated the results shown in this test report refer only to the sample(s) tested and such sample(s) are retained for 90 days only.

除非另有說明，此報告結果僅對測試之樣品負責，同時此樣品僅保留90天。本報告未經本公司書面許可，不可部份複製。

This document is issued by the Company subject to its General Conditions of Service printed overleaf, available on request or accessible at <http://www.sgs.com.tw/Terms-and-Conditions> and for electronic format documents, subject to Terms and Conditions for Electronic Documents at <http://www.sgs.com.tw/Terms-and-Conditions>. Attention is drawn to the limitation of liability, indemnification and jurisdiction issues defined therein. Any holder of this document is advised that information contained hereon reflects the Company's findings at the time of its intervention only and within the limits of Client's instructions, if any. The Company's sole responsibility is to its Client and this document does not exonerate parties to a transaction from exercising all their rights and obligations under the transaction documents. This document cannot be reproduced except in full, without prior written approval of the Company. Any unauthorized alteration, forgery or falsification of the content or appearance of this document is unlawful and offenders may be prosecuted to the fullest extent of the law.

14.13.6 Trial 6

Data Sheet for FCC Radar Type 5						
Trial Number:		6		VSG Frequency(MHz):		5310
Number of Bursts in Trial:			8		Successful Detection: Yes	
Burst (8-20)	Number Pulses per Burst (1-3)	Pulse Width (50-100)	Chirp Width (5-20)	Pulse 1-to-2 Spacing	Pulse 2-to-3 Spacing	Starting Location Within Interval
		(μ sec)	(MHz)	(μ sec)	(μ sec)	(μ sec)
1	2	75.7	5	1039.3		1417883
2	2	75.7	5	1675.3		283058
3	3	93.5	5	1267.5	1790.5	645459
4	1	50.9	5			1010268
5	2	76.5	5	1874.5		1371553
6	2	78.2	5	1352.8		238446
7	3	90.9	5	1594.1	1659.1	600817
8	2	67.6	5	1311.4		964778

Unless otherwise stated the results shown in this test report refer only to the sample(s) tested and such sample(s) are retained for 90 days only.

除非另有說明，此報告結果僅對測試之樣品負責，同時此樣品僅保留90天。本報告未經本公司書面許可，不可部份複製。

This document is issued by the Company subject to its General Conditions of Service printed overleaf, available on request or accessible at <http://www.sgs.com.tw/Terms-and-Conditions> and for electronic format documents, subject to Terms and Conditions for Electronic Documents at <http://www.sgs.com.tw/Terms-and-Conditions>. Attention is drawn to the limitation of liability, indemnification and jurisdiction issues defined therein. Any holder of this document is advised that information contained hereon reflects the Company's findings at the time of its intervention only and within the limits of Client's instructions, if any. The Company's sole responsibility is to its Client and this document does not exonerate parties to a transaction from exercising all their rights and obligations under the transaction documents. This document cannot be reproduced except in full, without prior written approval of the Company. Any unauthorized alteration, forgery or falsification of the content or appearance of this document is unlawful and offenders may be prosecuted to the fullest extent of the law.

14.13.7 Trial 7

Data Sheet for FCC Radar Type 5						
Trial Number:		7		VSG Frequency(MHz):		5310
Number of Bursts in Trial:			19		Successful Detection: Yes	
Burst (8-20)	Number Pulses per Burst (1-3)	Pulse Width (50-100)	Chirp Width (5-20)	Pulse 1-to-2 Spacing	Pulse 2-to-3 Spacing	Starting Location Within Interval
		(μ sec)	(MHz)	(μ sec)	(μ sec)	(μ sec)
1	3	95.8	18	1832.2	1410.2	555394
2	3	94.9	18	1322.1	1204.1	81223
3	3	99.5	18	1355.5	1089.5	233328
4	3	96.8	18	1535.2	1145.2	385633
5	1	61.3	18			540366
6	3	87.5	18	1422.5	1401.5	62393
7	2	72.9	18	1379.1		215032
8	1	59.2	18			368445
9	2	67.1	18	1004.9		520066
10	1	58.6	18			43887
11	1	51.8	18			196798
12	1	56.4	18			349750
13	2	68.4	18	1078.6		501484
14	1	63.2	18			25077
15	1	50.8	18			177809
16	2	81.2	18	1690.8		329509
17	2	68.9	18	1214.1		482804
18	3	85.6	18	1638.4	1504.4	6218
19	1	53.4	18			159040

Unless otherwise stated the results shown in this test report refer only to the sample(s) tested and such sample(s) are retained for 90 days only.

除非另有說明，此報告結果僅對測試之樣品負責，同時此樣品僅保留90天。本報告未經本公司書面許可，不可部份複製。

This document is issued by the Company subject to its General Conditions of Service printed overleaf, available on request or accessible at <http://www.sgs.com.tw/Terms-and-Conditions> and for electronic format documents, subject to Terms and Conditions for Electronic Documents at <http://www.sgs.com.tw/Terms-and-Conditions>. Attention is drawn to the limitation of liability, indemnification and jurisdiction issues defined therein. Any holder of this document is advised that information contained hereon reflects the Company's findings at the time of its intervention only and within the limits of Client's instructions, if any. The Company's sole responsibility is to its Client and this document does not exonerate parties to a transaction from exercising all their rights and obligations under the transaction documents. This document cannot be reproduced except in full, without prior written approval of the Company. Any unauthorized alteration, forgery or falsification of the content or appearance of this document is unlawful and offenders may be prosecuted to the fullest extent of the law.

14.13.8 Trial 8

Data Sheet for FCC Radar Type 5						
Trial Number:		8		VSG Frequency(MHz):		5310
Number of Bursts in Trial:			16		Successful Detection: No	
Burst (8-20)	Number Pulses per Burst (1-3)	Pulse Width (50-100)	Chirp Width (5-20)	Pulse 1-to-2 Spacing	Pulse 2-to-3 Spacing	Starting Location Within Interval
		(μ sec)	(MHz)	(μ sec)	(μ sec)	(μ sec)
1	1	60.6	16			370709
2	3	88.4	16	1673.6	1542.6	549691
3	2	80.4	16	1180.6		732531
4	3	87.6	16	1044.4	1739.4	165939
5	3	88.2	16	1018.8	1348.8	346815
6	2	80.1	16	1083.9		529051
7	3	98.1	16	1002.9	932.9	709596
8	2	78	16	1770		143881
9	3	84	16	1829	955	324420
10	1	53.9	16			507438
11	1	51.3	16			689099
12	3	85.9	16	1091.1	973.1	121440
13	2	67.8	16	1372.2		302742
14	3	95.8	16	1367.2	1777.2	483049
15	3	86.1	16	1808.9	1553.9	663080
16	3	85.6	16	1203.4	1201.4	99115

Unless otherwise stated the results shown in this test report refer only to the sample(s) tested and such sample(s) are retained for 90 days only.

除非另有說明，此報告結果僅對測試之樣品負責，同時此樣品僅保留90天。本報告未經本公司書面許可，不可部份複製。

This document is issued by the Company subject to its General Conditions of Service printed overleaf, available on request or accessible at <http://www.sgs.com.tw/Terms-and-Conditions> and for electronic format documents, subject to Terms and Conditions for Electronic Documents at <http://www.sgs.com.tw/Terms-and-Conditions>. Attention is drawn to the limitation of liability, indemnification and jurisdiction issues defined therein. Any holder of this document is advised that information contained hereon reflects the Company's findings at the time of its intervention only and within the limits of Client's instructions, if any. The Company's sole responsibility is to its Client and this document does not exonerate parties to a transaction from exercising all their rights and obligations under the transaction documents. This document cannot be reproduced except in full, without prior written approval of the Company. Any unauthorized alteration, forgery or falsification of the content or appearance of this document is unlawful and offenders may be prosecuted to the fullest extent of the law.

14.13.9 Trial 9

Data Sheet for FCC Radar Type 5						
Trial Number:		9		VSG Frequency(MHz):		5310
Number of Bursts in Trial:			15		Successful Detection: Yes	
Burst (8-20)	Number Pulses per Burst (1-3)	Pulse Width (50-100)	Chirp Width (5-20)	Pulse 1-to-2 Spacing	Pulse 2-to-3 Spacing	Starting Location Within Interval
		(μ sec)	(MHz)	(μ sec)	(μ sec)	(μ sec)
1	3	94.7	14	1479.3	1263.3	298833
2	1	54.5	14			493176
3	2	79.6	14	1873.4		685083
4	2	74.2	14	1843.8		82062
5	2	73.2	14	1416.8		275417
6	3	90.9	14	1149.1	1074.1	467980
7	2	73.7	14	1483.3		662375
8	1	59.9	14			58438
9	3	99	14	1378	1647	251182
10	3	92.8	14	1777.2	1876.2	443379
11	3	93	14	1382	1233	637342
12	1	52.4	14			34582
13	1	62.4	14			228187
14	2	74.8	14	1905.2		420798
15	1	62.3	14			615553

Unless otherwise stated the results shown in this test report refer only to the sample(s) tested and such sample(s) are retained for 90 days only.

除非另有說明，此報告結果僅對測試之樣品負責，同時此樣品僅保留90天。本報告未經本公司書面許可，不可部份複製。

This document is issued by the Company subject to its General Conditions of Service printed overleaf, available on request or accessible at <http://www.sgs.com.tw/Terms-and-Conditions> and for electronic format documents, subject to Terms and Conditions for Electronic Documents at <http://www.sgs.com.tw/Terms-and-Conditions>. Attention is drawn to the limitation of liability, indemnification and jurisdiction issues defined therein. Any holder of this document is advised that information contained hereon reflects the Company's findings at the time of its intervention only and within the limits of Client's instructions, if any. The Company's sole responsibility is to its Client and this document does not exonerate parties to a transaction from exercising all their rights and obligations under the transaction documents. This document cannot be reproduced except in full, without prior written approval of the Company. Any unauthorized alteration, forgery or falsification of the content or appearance of this document is unlawful and offenders may be prosecuted to the fullest extent of the law.

14.13.10 Trial 10

Data Sheet for FCC Radar Type 5						
Trial Number:		10		VSG Frequency(MHz):		5310
Number of Bursts in Trial:			17		Successful Detection: Yes	
Burst (8-20)	Number Pulses per Burst (1-3)	Pulse Width (50-100)	Chirp Width (5-20)	Pulse 1-to-2 Spacing	Pulse 2-to-3 Spacing	Starting Location Within Interval
		(μ sec)	(MHz)	(μ sec)	(μ sec)	(μ sec)
1	2	82	16	1608		9460
2	3	90.9	16	1895.1	1899.1	179231
3	2	74.7	16	971.3		350504
4	2	80.3	16	1727.7		520285
5	2	79.3	16	1343.7		691395
6	1	65.4	16			159274
7	1	57.2	16			330226
8	1	61.3	16			500882
9	2	66.7	16	1384.3		670070
10	1	63.3	16			138302
11	1	59.5	16			308892
12	3	89	16	956	1389	478108
13	1	55.2	16			651105
14	1	65.7	16			117181
15	2	72.8	16	1140.2		287537
16	3	84.1	16	1657.9	1577.9	456409
17	1	60.6	16			630080

Unless otherwise stated the results shown in this test report refer only to the sample(s) tested and such sample(s) are retained for 90 days only.

除非另有說明，此報告結果僅對測試之樣品負責，同時此樣品僅保留90天。本報告未經本公司書面許可，不可部份複製。

This document is issued by the Company subject to its General Conditions of Service printed overleaf, available on request or accessible at <http://www.sgs.com.tw/Terms-and-Conditions> and for electronic format documents, subject to Terms and Conditions for Electronic Documents at <http://www.sgs.com.tw/Terms-and-Conditions>. Attention is drawn to the limitation of liability, indemnification and jurisdiction issues defined therein. Any holder of this document is advised that information contained hereon reflects the Company's findings at the time of its intervention only and within the limits of Client's instructions, if any. The Company's sole responsibility is to its Client and this document does not exonerate parties to a transaction from exercising all their rights and obligations under the transaction documents. This document cannot be reproduced except in full, without prior written approval of the Company. Any unauthorized alteration, forgery or falsification of the content or appearance of this document is unlawful and offenders may be prosecuted to the fullest extent of the law.

14.13.11 Trial 11

Data Sheet for FCC Radar Type 5						
Trial Number:		11		VSG Frequency(MHz):		5293.816
Number of Bursts in Trial:			8		Successful Detection: No	
Burst (8-20)	Number Pulses per Burst (1-3)	Pulse Width (50-100)	Chirp Width (5-20)	Pulse 1-to-2 Spacing	Pulse 2-to-3 Spacing	Starting Location Within Interval
		(μ sec)	(MHz)	(μ sec)	(μ sec)	(μ sec)
1	2	82.3	5	1891.7		204286
2	2	77.7	5	1726.3		567132
3	1	56.2	5			931599
4	2	76.6	5	1705.4		1293038
5	3	89.4	5	1564.6	1775.6	159393
6	1	61.4	5			523221
7	2	80.3	5	1636.7		885768
8	2	69.7	5	1494.3		1249162

Unless otherwise stated the results shown in this test report refer only to the sample(s) tested and such sample(s) are retained for 90 days only.

除非另有說明，此報告結果僅對測試之樣品負責，同時此樣品僅保留90天。本報告未經本公司書面許可，不可部份複製。

This document is issued by the Company subject to its General Conditions of Service printed overleaf, available on request or accessible at <http://www.sgs.com.tw/Terms-and-Conditions> and for electronic format documents, subject to Terms and Conditions for Electronic Documents at <http://www.sgs.com.tw/Terms-and-Conditions>. Attention is drawn to the limitation of liability, indemnification and jurisdiction issues defined therein. Any holder of this document is advised that information contained hereon reflects the Company's findings at the time of its intervention only and within the limits of Client's instructions, if any. The Company's sole responsibility is to its Client and this document does not exonerate parties to a transaction from exercising all their rights and obligations under the transaction documents. This document cannot be reproduced except in full, without prior written approval of the Company. Any unauthorized alteration, forgery or falsification of the content or appearance of this document is unlawful and offenders may be prosecuted to the fullest extent of the law.

14.13.12 Trial 12

Data Sheet for FCC Radar Type 5						
Trial Number:		12		VSG Frequency(MHz):		5295.816
Number of Bursts in Trial:			12		Successful Detection: Yes	
Burst (8-20)	Number Pulses per Burst (1-3)	Pulse Width (50-100)	Chirp Width (5-20)	Pulse 1-to-2 Spacing	Pulse 2-to-3 Spacing	Starting Location Within Interval
		(μ sec)	(MHz)	(μ sec)	(μ sec)	(μ sec)
1	1	64.7	10			76661
2	2	70.5	10	1788.5		318052
3	3	88.7	10	1145.3	1370.3	559355
4	3	95.4	10	1585.6	977.6	800973
5	3	87.2	10	1730.8	931.8	46677
6	3	95.7	10	1486.3	1643.3	287993
7	1	65.5	10			531115
8	1	59.1	10			773599
9	3	91.7	10	1495.3	944.3	16922
10	2	69.4	10	1818.6		258740
11	3	95.1	10	1223.9	1397.9	499728
12	3	93.2	10	1751.8	1222.8	740884

Unless otherwise stated the results shown in this test report refer only to the sample(s) tested and such sample(s) are retained for 90 days only.

除非另有說明，此報告結果僅對測試之樣品負責，同時此樣品僅保留90天。本報告未經本公司書面許可，不可部份複製。

This document is issued by the Company subject to its General Conditions of Service printed overleaf, available on request or accessible at <http://www.sgs.com.tw/Terms-and-Conditions> and for electronic format documents, subject to Terms and Conditions for Electronic Documents at <http://www.sgs.com.tw/Terms-and-Conditions>. Attention is drawn to the limitation of liability, indemnification and jurisdiction issues defined therein. Any holder of this document is advised that information contained hereon reflects the Company's findings at the time of its intervention only and within the limits of Client's instructions, if any. The Company's sole responsibility is to its Client and this document does not exonerate parties to a transaction from exercising all their rights and obligations under the transaction documents. This document cannot be reproduced except in full, without prior written approval of the Company. Any unauthorized alteration, forgery or falsification of the content or appearance of this document is unlawful and offenders may be prosecuted to the fullest extent of the law.

14.13.13 Trial 13

Data Sheet for FCC Radar Type 5						
Trial Number:		13		VSG Frequency(MHz):		5293.816
Number of Bursts in Trial:			8		Successful Detection: Yes	
Burst (8-20)	Number Pulses per Burst (1-3)	Pulse Width (50-100)	Chirp Width (5-20)	Pulse 1-to-2 Spacing	Pulse 2-to-3 Spacing	Starting Location Within Interval
		(μ sec)	(MHz)	(μ sec)	(μ sec)	(μ sec)
1	1	65.5	5			1479371
2	1	56.8	5			344182
3	2	70.1	5	1105.9		706970
4	3	87.4	5	1570.6	1874.6	1068743
5	3	93.3	5	1060.7	1618.7	1432093
6	1	62.8	5			299316
7	1	60.9	5			662666
8	1	63.7	5			1026325

Unless otherwise stated the results shown in this test report refer only to the sample(s) tested and such sample(s) are retained for 90 days only.

除非另有說明，此報告結果僅對測試之樣品負責，同時此樣品僅保留90天。本報告未經本公司書面許可，不可部份複製。

This document is issued by the Company subject to its General Conditions of Service printed overleaf, available on request or accessible at <http://www.sgs.com.tw/Terms-and-Conditions> and for electronic format documents, subject to Terms and Conditions for Electronic Documents at <http://www.sgs.com.tw/Terms-and-Conditions>. Attention is drawn to the limitation of liability, indemnification and jurisdiction issues defined therein. Any holder of this document is advised that information contained hereon reflects the Company's findings at the time of its intervention only and within the limits of Client's instructions, if any. The Company's sole responsibility is to its Client and this document does not exonerate parties to a transaction from exercising all their rights and obligations under the transaction documents. This document cannot be reproduced except in full, without prior written approval of the Company. Any unauthorized alteration, forgery or falsification of the content or appearance of this document is unlawful and offenders may be prosecuted to the fullest extent of the law.

14.13.14 Trial 14

Data Sheet for FCC Radar Type 5						
Trial Number:		14		VSG Frequency(MHz):		5299.416
Number of Bursts in Trial:			20		Successful Detection: Yes	
Burst (8-20)	Number Pulses per Burst (1-3)	Pulse Width (50-100)	Chirp Width (5-20)	Pulse 1-to-2 Spacing	Pulse 2-to-3 Spacing	Starting Location Within Interval
		(μ sec)	(MHz)	(μ sec)	(μ sec)	(μ sec)
1	1	51.9	19			555310
2	2	68.4	19	1297.6		101410
3	3	94.2	19	937.8	1678.8	245502
4	2	76.1	19	1023.9		391491
5	1	58.7	19			537470
6	2	82.3	19	1078.7		83620
7	2	70.1	19	1302.9		228490
8	3	84.7	19	1375.3	1583.3	372232
9	2	68.6	19	1426.4		517894
10	3	85.7	19	963.3	1248.3	65637
11	3	92.7	19	1210.3	1139.3	210105
12	2	79.5	19	1500.5		355398
13	3	94.5	19	1452.5	1043.5	498911
14	1	60.5	19			48049
15	1	64.6	19			193165
16	3	95	19	1062	1748	336831
17	2	68.6	19	1053.4		482936
18	1	65.9	19			30180
19	2	79.6	19	945.4		175084
20	2	67.6	19	933.4		320145

Unless otherwise stated the results shown in this test report refer only to the sample(s) tested and such sample(s) are retained for 90 days only.

除非另有說明，此報告結果僅對測試之樣品負責，同時此樣品僅保留90天。本報告未經本公司書面許可，不可部份複製。

This document is issued by the Company subject to its General Conditions of Service printed overleaf, available on request or accessible at <http://www.sgs.com.tw/Terms-and-Conditions> and for electronic format documents, subject to Terms and Conditions for Electronic Documents at <http://www.sgs.com.tw/Terms-and-Conditions>. Attention is drawn to the limitation of liability, indemnification and jurisdiction issues defined therein. Any holder of this document is advised that information contained hereon reflects the Company's findings at the time of its intervention only and within the limits of Client's instructions, if any. The Company's sole responsibility is to its Client and this document does not exonerate parties to a transaction from exercising all their rights and obligations under the transaction documents. This document cannot be reproduced except in full, without prior written approval of the Company. Any unauthorized alteration, forgery or falsification of the content or appearance of this document is unlawful and offenders may be prosecuted to the fullest extent of the law.

14.13.15 Trial 15

Data Sheet for FCC Radar Type 5						
Trial Number:		15		VSG Frequency(MHz):		5298.616
Number of Bursts in Trial:			18		Successful Detection: Yes	
Burst (8-20)	Number Pulses per Burst (1-3)	Pulse Width (50-100)	Chirp Width (5-20)	Pulse 1-to-2 Spacing	Pulse 2-to-3 Spacing	Starting Location Within Interval
		(μ sec)	(MHz)	(μ sec)	(μ sec)	(μ sec)
1	3	94	17	1439	1888	514754
2	2	79.9	17	1615.1		13624
3	1	63.6	17			175105
4	3	96.4	17	1606.6	1207.6	334596
5	2	77.7	17	1836.3		496335
6	3	91	17	1245	1130	656012
7	3	95.2	17	1843.8	1354.8	154230
8	2	75.5	17	1645.5		315659
9	1	57.6	17			477960
10	2	68.8	17	948.2		638361
11	3	83.4	17	1039.6	1116.6	134744
12	2	76.6	17	1028.4		296218
13	1	50.4	17			458029
14	1	66.5	17			618940
15	2	67.8	17	1250.2		115207
16	3	96.3	17	1337.7	984.7	275765
17	2	76.3	17	1450.7		436688
18	1	62.5	17			598976

Unless otherwise stated the results shown in this test report refer only to the sample(s) tested and such sample(s) are retained for 90 days only.

除非另有說明，此報告結果僅對測試之樣品負責，同時此樣品僅保留90天。本報告未經本公司書面許可，不可部份複製。

This document is issued by the Company subject to its General Conditions of Service printed overleaf, available on request or accessible at <http://www.sgs.com.tw/Terms-and-Conditions> and for electronic format documents, subject to Terms and Conditions for Electronic Documents at <http://www.sgs.com.tw/Terms-and-Conditions>. Attention is drawn to the limitation of liability, indemnification and jurisdiction issues defined therein. Any holder of this document is advised that information contained hereon reflects the Company's findings at the time of its intervention only and within the limits of Client's instructions, if any. The Company's sole responsibility is to its Client and this document does not exonerate parties to a transaction from exercising all their rights and obligations under the transaction documents. This document cannot be reproduced except in full, without prior written approval of the Company. Any unauthorized alteration, forgery or falsification of the content or appearance of this document is unlawful and offenders may be prosecuted to the fullest extent of the law.

14.13.16 Trial 16

Data Sheet for FCC Radar Type 5						
Trial Number:		16		VSG Frequency(MHz):		5299.416
Number of Bursts in Trial:			20		Successful Detection: Yes	
Burst (8-20)	Number Pulses per Burst (1-3)	Pulse Width (50-100)	Chirp Width (5-20)	Pulse 1-to-2 Spacing	Pulse 2-to-3 Spacing	Starting Location Within Interval
		(μ sec)	(MHz)	(μ sec)	(μ sec)	(μ sec)
1	3	86.6	19	1849.4	1340.4	85405
2	1	54.8	19			231183
3	2	75.5	19	1790.5		375035
4	2	80.8	19	1449.2		520228
5	3	90.5	19	931.5	1160.5	67791
6	1	56	19			213098
7	2	76.7	19	1877.3		357248
8	1	65.6	19			503347
9	3	98.7	19	1273.3	1295.3	49898
10	1	55	19			195306
11	3	92.3	19	1251.7	1171.7	339090
12	2	75.1	19	979.9		484759
13	2	68.8	19	1501.2		32183
14	2	77.3	19	1798.7		176994
15	2	83.2	19	1421.8		321885
16	3	93.3	19	1451.7	1520.7	465477
17	2	69.7	19	932.3		14378
18	2	72.1	19	1385.9		159073
19	1	54.8	19			304639
20	3	97.9	19	1634.1	939.1	447875

Unless otherwise stated the results shown in this test report refer only to the sample(s) tested and such sample(s) are retained for 90 days only.

除非另有說明，此報告結果僅對測試之樣品負責，同時此樣品僅保留90天。本報告未經本公司書面許可，不可部份複製。

This document is issued by the Company subject to its General Conditions of Service printed overleaf, available on request or accessible at <http://www.sgs.com.tw/Terms-and-Conditions> and for electronic format documents, subject to Terms and Conditions for Electronic Documents at <http://www.sgs.com.tw/Terms-and-Conditions>. Attention is drawn to the limitation of liability, indemnification and jurisdiction issues defined therein. Any holder of this document is advised that information contained hereon reflects the Company's findings at the time of its intervention only and within the limits of Client's instructions, if any. The Company's sole responsibility is to its Client and this document does not exonerate parties to a transaction from exercising all their rights and obligations under the transaction documents. This document cannot be reproduced except in full, without prior written approval of the Company. Any unauthorized alteration, forgery or falsification of the content or appearance of this document is unlawful and offenders may be prosecuted to the fullest extent of the law.

14.13.17 Trial 17

Data Sheet for FCC Radar Type 5						
Trial Number:		17		VSG Frequency(MHz):		5297.416
Number of Bursts in Trial:			15		Successful Detection: Yes	
Burst (8-20)	Number Pulses per Burst (1-3)	Pulse Width (50-100)	Chirp Width (5-20)	Pulse 1-to-2 Spacing	Pulse 2-to-3 Spacing	Starting Location Within Interval
		(μ sec)	(MHz)	(μ sec)	(μ sec)	(μ sec)
1	3	98.5	14	1529.5	1540.5	790275
2	2	67.8	14	967.2		188767
3	3	87.2	14	1393.8	1408.8	381473
4	3	94.7	14	1083.3	1702.3	574184
5	2	77.1	14	1188.9		768439
6	3	99.9	14	1371.1	1009.1	164630
7	1	52.2	14			358931
8	1	66	14			552374
9	2	79	14	1802		743959
10	2	77.9	14	1074.1		141116
11	3	92.8	14	1900.2	1228.2	333425
12	2	68.3	14	1261.7		527752
13	2	68.6	14	1277.4		720969
14	1	56.1	14			117503
15	2	79.4	14	997.6		310715

Unless otherwise stated the results shown in this test report refer only to the sample(s) tested and such sample(s) are retained for 90 days only.

除非另有說明，此報告結果僅對測試之樣品負責，同時此樣品僅保留90天。本報告未經本公司書面許可，不可部份複製。

This document is issued by the Company subject to its General Conditions of Service printed overleaf, available on request or accessible at <http://www.sgs.com.tw/Terms-and-Conditions> and for electronic format documents, subject to Terms and Conditions for Electronic Documents at <http://www.sgs.com.tw/Terms-and-Conditions>. Attention is drawn to the limitation of liability, indemnification and jurisdiction issues defined therein. Any holder of this document is advised that information contained hereon reflects the Company's findings at the time of its intervention only and within the limits of Client's instructions, if any. The Company's sole responsibility is to its Client and this document does not exonerate parties to a transaction from exercising all their rights and obligations under the transaction documents. This document cannot be reproduced except in full, without prior written approval of the Company. Any unauthorized alteration, forgery or falsification of the content or appearance of this document is unlawful and offenders may be prosecuted to the fullest extent of the law.

14.13.18 Trial 18

Data Sheet for FCC Radar Type 5						
Trial Number:		18		VSG Frequency(MHz):		5299.016
Number of Bursts in Trial:			19		Successful Detection: Yes	
Burst (8-20)	Number Pulses per Burst (1-3)	Pulse Width (50-100)	Chirp Width (5-20)	Pulse 1-to-2 Spacing	Pulse 2-to-3 Spacing	Starting Location Within Interval
		(μ sec)	(MHz)	(μ sec)	(μ sec)	(μ sec)
1	2	74.7	18	1195.3		397610
2	3	92.2	18	986.8	1411.8	548460
3	1	63.1	18			73913
4	3	89.4	18	1857.6	1340.6	225288
5	1	57.5	18			379635
6	2	69.6	18	1755.4		530955
7	1	62.1	18			55066
8	3	92.3	18	1823.7	1520.7	206531
9	3	90.1	18	1411.9	1426.9	359180
10	2	83.3	18	1525.7		511995
11	2	82.5	18	920.5		36177
12	1	50	18			189009
13	1	56	18			341672
14	3	93.4	18	958.6	1162.6	492876
15	1	57.1	18			17384
16	3	96.9	18	1903.1	1547.1	169257
17	3	95.7	18	1611.3	1631.3	321056
18	3	91.5	18	1837.5	1020.5	473521
19	2	78.5	18	1722.5		626753

Unless otherwise stated the results shown in this test report refer only to the sample(s) tested and such sample(s) are retained for 90 days only.

除非另有說明，此報告結果僅對測試之樣品負責，同時此樣品僅保留90天。本報告未經本公司書面許可，不可部份複製。

This document is issued by the Company subject to its General Conditions of Service printed overleaf, available on request or accessible at <http://www.sgs.com.tw/Terms-and-Conditions> and for electronic format documents, subject to Terms and Conditions for Electronic Documents at <http://www.sgs.com.tw/Terms-and-Conditions>. Attention is drawn to the limitation of liability, indemnification and jurisdiction issues defined therein. Any holder of this document is advised that information contained hereon reflects the Company's findings at the time of its intervention only and within the limits of Client's instructions, if any. The Company's sole responsibility is to its Client and this document does not exonerate parties to a transaction from exercising all their rights and obligations under the transaction documents. This document cannot be reproduced except in full, without prior written approval of the Company. Any unauthorized alteration, forgery or falsification of the content or appearance of this document is unlawful and offenders may be prosecuted to the fullest extent of the law.

14.13.19 Trial 19

Data Sheet for FCC Radar Type 5						
Trial Number:		19		VSG Frequency(MHz):		5299.016
Number of Bursts in Trial:			19		Successful Detection: Yes	
Burst (8-20)	Number Pulses per Burst (1-3)	Pulse Width (50-100)	Chirp Width (5-20)	Pulse 1-to-2 Spacing	Pulse 2-to-3 Spacing	Starting Location Within Interval
		(μ sec)	(MHz)	(μ sec)	(μ sec)	(μ sec)
1	1	64.1	18			151404
2	2	68.7	18	1329.3		303636
3	2	67.7	18	1621.3		455897
4	2	80.9	18	925.1		608478
5	1	53.7	18			132455
6	3	90.7	18	1583.3	965.3	284045
7	1	53.7	18			438429
8	1	60.7	18			591109
9	3	86.6	18	1369.4	1362.4	113150
10	2	70.7	18	1328.3		266125
11	1	62.2	18			419294
12	2	73.9	18	1043.1		571533
13	1	56.5	18			94839
14	1	62.7	18			247847
15	3	98	18	1526	1572	398132
16	1	58.4	18			553311
17	1	51.1	18			76048
18	1	56.6	18			228873
19	2	82.8	18	1720.2		380555

Unless otherwise stated the results shown in this test report refer only to the sample(s) tested and such sample(s) are retained for 90 days only.

除非另有說明，此報告結果僅對測試之樣品負責，同時此樣品僅保留90天。本報告未經本公司書面許可，不可部份複製。

This document is issued by the Company subject to its General Conditions of Service printed overleaf, available on request or accessible at <http://www.sgs.com.tw/Terms-and-Conditions> and for electronic format documents, subject to Terms and Conditions for Electronic Documents at <http://www.sgs.com.tw/Terms-and-Conditions>. Attention is drawn to the limitation of liability, indemnification and jurisdiction issues defined therein. Any holder of this document is advised that information contained hereon reflects the Company's findings at the time of its intervention only and within the limits of Client's instructions, if any. The Company's sole responsibility is to its Client and this document does not exonerate parties to a transaction from exercising all their rights and obligations under the transaction documents. This document cannot be reproduced except in full, without prior written approval of the Company. Any unauthorized alteration, forgery or falsification of the content or appearance of this document is unlawful and offenders may be prosecuted to the fullest extent of the law.

14.13.20 Trial 20

Data Sheet for FCC Radar Type 5						
Trial Number:		20		VSG Frequency(MHz):		5299.016
Number of Bursts in Trial:			19		Successful Detection: Yes	
Burst (8-20)	Number Pulses per Burst (1-3)	Pulse Width (50-100)	Chirp Width (5-20)	Pulse 1-to-2 Spacing	Pulse 2-to-3 Spacing	Starting Location Within Interval
		(μ sec)	(MHz)	(μ sec)	(μ sec)	(μ sec)
1	3	97.3	18	1385.7	1004.7	532247
2	2	78.3	18	1527.7		57131
3	3	86.3	18	1377.7	941.7	209175
4	2	75.6	18	1300.4		361912
5	3	97.1	18	1425.9	1562.9	512859
6	1	61.3	18			38427
7	3	94.7	18	1832.3	1797.3	189951
8	3	99.9	18	1615.1	1227.1	342491
9	3	96.2	18	1114.8	1128.8	495260
10	2	72.7	18	1002.3		19590
11	2	71.8	18	1446.2		172045
12	2	81.1	18	1817.9		324012
13	3	97.1	18	911.9	1082.9	476328
14	2	76.9	18	1550.1		795
15	3	90.2	18	1815.8	1585.8	152759
16	3	92	18	1261	1695	304775
17	1	60.6	18			459016
18	1	57	18			612493
19	1	61.2	18			134877

Unless otherwise stated the results shown in this test report refer only to the sample(s) tested and such sample(s) are retained for 90 days only.

除非另有說明，此報告結果僅對測試之樣品負責，同時此樣品僅保留90天。本報告未經本公司書面許可，不可部份複製。

This document is issued by the Company subject to its General Conditions of Service printed overleaf, available on request or accessible at <http://www.sgs.com.tw/Terms-and-Conditions> and for electronic format documents, subject to Terms and Conditions for Electronic Documents at <http://www.sgs.com.tw/Terms-and-Conditions>. Attention is drawn to the limitation of liability, indemnification and jurisdiction issues defined therein. Any holder of this document is advised that information contained hereon reflects the Company's findings at the time of its intervention only and within the limits of Client's instructions, if any. The Company's sole responsibility is to its Client and this document does not exonerate parties to a transaction from exercising all their rights and obligations under the transaction documents. This document cannot be reproduced except in full, without prior written approval of the Company. Any unauthorized alteration, forgery or falsification of the content or appearance of this document is unlawful and offenders may be prosecuted to the fullest extent of the law.

14.13.21 Trial 21

Data Sheet for FCC Radar Type 5						
Trial Number:		21		VSG Frequency(MHz):		5323.784
Number of Bursts in Trial:			13		Successful Detection: Yes	
Burst (8-20)	Number Pulses per Burst (1-3)	Pulse Width (50-100)	Chirp Width (5-20)	Pulse 1-to-2 Spacing	Pulse 2-to-3 Spacing	Starting Location Within Interval
		(μ sec)	(MHz)	(μ sec)	(μ sec)	(μ sec)
1	1	59.3	11			420586
2	3	98.7	11	1621.3	1301.3	641808
3	1	53.8	11			867823
4	1	58.9	11			169631
5	2	75.5	11	1554.5		392320
6	2	71.5	11	1535.5		615399
7	2	77.8	11	1860.2		838671
8	1	59.4	11			142128
9	2	76	11	1021		365105
10	3	87.3	11	1224.7	1506.7	587038
11	1	58.1	11			813032
12	3	84.9	11	1098.1	1553.1	114183
13	1	55.9	11			337935

Unless otherwise stated the results shown in this test report refer only to the sample(s) tested and such sample(s) are retained for 90 days only.

除非另有說明，此報告結果僅對測試之樣品負責，同時此樣品僅保留90天。本報告未經本公司書面許可，不可部份複製。

This document is issued by the Company subject to its General Conditions of Service printed overleaf, available on request or accessible at <http://www.sgs.com.tw/Terms-and-Conditions> and for electronic format documents, subject to Terms and Conditions for Electronic Documents at <http://www.sgs.com.tw/Terms-and-Conditions>. Attention is drawn to the limitation of liability, indemnification and jurisdiction issues defined therein. Any holder of this document is advised that information contained hereon reflects the Company's findings at the time of its intervention only and within the limits of Client's instructions, if any. The Company's sole responsibility is to its Client and this document does not exonerate parties to a transaction from exercising all their rights and obligations under the transaction documents. This document cannot be reproduced except in full, without prior written approval of the Company. Any unauthorized alteration, forgery or falsification of the content or appearance of this document is unlawful and offenders may be prosecuted to the fullest extent of the law.

14.13.22 Trial 22

Data Sheet for FCC Radar Type 5						
Trial Number:		22		VSG Frequency(MHz):		5324.184
Number of Bursts in Trial:			12		Successful Detection: Yes	
Burst (8-20)	Number Pulses per Burst (1-3)	Pulse Width (50-100)	Chirp Width (5-20)	Pulse 1-to-2 Spacing	Pulse 2-to-3 Spacing	Starting Location Within Interval
		(μ sec)	(MHz)	(μ sec)	(μ sec)	(μ sec)
1	3	90.2	10	1273.8	1204.8	606736
2	1	62.9	10			850876
3	3	94.2	10	1482.8	1602.8	93968
4	1	50.2	10			336477
5	2	77.8	10	936.2		577757
6	3	93.2	10	1579.8	1677.8	817990
7	2	70.7	10	1139.3		64356
8	2	69.6	10	1677.4		306218
9	1	59.1	10			548542
10	3	90.9	10	1382.1	993.1	788888
11	1	57.5	10			34613
12	3	88.1	10	923.9	1836.9	275921

Unless otherwise stated the results shown in this test report refer only to the sample(s) tested and such sample(s) are retained for 90 days only.

除非另有說明，此報告結果僅對測試之樣品負責，同時此樣品僅保留90天。本報告未經本公司書面許可，不可部份複製。

This document is issued by the Company subject to its General Conditions of Service printed overleaf, available on request or accessible at <http://www.sgs.com.tw/Terms-and-Conditions> and for electronic format documents, subject to Terms and Conditions for Electronic Documents at <http://www.sgs.com.tw/Terms-and-Conditions>. Attention is drawn to the limitation of liability, indemnification and jurisdiction issues defined therein. Any holder of this document is advised that information contained hereon reflects the Company's findings at the time of its intervention only and within the limits of Client's instructions, if any. The Company's sole responsibility is to its Client and this document does not exonerate parties to a transaction from exercising all their rights and obligations under the transaction documents. This document cannot be reproduced except in full, without prior written approval of the Company. Any unauthorized alteration, forgery or falsification of the content or appearance of this document is unlawful and offenders may be prosecuted to the fullest extent of the law.

14.13.23 Trial 23

Data Sheet for FCC Radar Type 5						
Trial Number:		23		VSG Frequency(MHz):		5322.584
Number of Bursts in Trial:			15		Successful Detection: Yes	
Burst (8-20)	Number Pulses per Burst (1-3)	Pulse Width (50-100)	Chirp Width (5-20)	Pulse 1-to-2 Spacing	Pulse 2-to-3 Spacing	Starting Location Within Interval
		(μ sec)	(MHz)	(μ sec)	(μ sec)	(μ sec)
1	1	64.7	14			415120
2	3	89.6	14	1085.4	1597.4	606453
3	1	65.2	14			3836
4	3	97.1	14	1273.9	1796.9	196765
5	1	66.3	14			391306
6	2	70.7	14	1892.3		583184
7	3	87.3	14	1673.7	1200.7	775695
8	1	51.4	14			173646
9	3	90	14	998	1587	366139
10	3	97.3	14	1723.7	1681.7	558113
11	3	84.2	14	1194.8	1188.8	752330
12	3	93.5	14	1780.5	1458.5	149161
13	2	69.3	14	1497.7		342569
14	1	60.7	14			537050
15	1	54	14			730970

Unless otherwise stated the results shown in this test report refer only to the sample(s) tested and such sample(s) are retained for 90 days only.

除非另有說明，此報告結果僅對測試之樣品負責，同時此樣品僅保留90天。本報告未經本公司書面許可，不可部份複製。

This document is issued by the Company subject to its General Conditions of Service printed overleaf, available on request or accessible at <http://www.sgs.com.tw/Terms-and-Conditions> and for electronic format documents, subject to Terms and Conditions for Electronic Documents at <http://www.sgs.com.tw/Terms-and-Conditions>. Attention is drawn to the limitation of liability, indemnification and jurisdiction issues defined therein. Any holder of this document is advised that information contained hereon reflects the Company's findings at the time of its intervention only and within the limits of Client's instructions, if any. The Company's sole responsibility is to its Client and this document does not exonerate parties to a transaction from exercising all their rights and obligations under the transaction documents. This document cannot be reproduced except in full, without prior written approval of the Company. Any unauthorized alteration, forgery or falsification of the content or appearance of this document is unlawful and offenders may be prosecuted to the fullest extent of the law.

14.13.24 Trial 24

Data Sheet for FCC Radar Type 5						
Trial Number:		24		VSG Frequency(MHz):		5320.584
Number of Bursts in Trial:			20		Successful Detection: No	
Burst (8-20)	Number Pulses per Burst (1-3)	Pulse Width (50-100)	Chirp Width (5-20)	Pulse 1-to-2 Spacing	Pulse 2-to-3 Spacing	Starting Location Within Interval
		(μ sec)	(MHz)	(μ sec)	(μ sec)	(μ sec)
1	2	69.3	19	1293.7		94192
2	1	51.9	19			239745
3	2	68.6	19	1582.4		383859
4	1	62.5	19			529765
5	3	88.1	19	915.9	1048.9	76228
6	3	87.8	19	1104.2	1140.2	220653
7	1	65.8	19			366886
8	3	90.9	19	1123.1	1324.1	509849
9	3	84.2	19	1904.8	1361.8	58326
10	2	82.8	19	1605.2		203265
11	3	90	19	1177	1126	347500
12	1	64.1	19			494229
13	2	67.4	19	1012.6		40688
14	3	86.4	19	1558.6	1100.6	185058
15	3	91.7	19	1461.3	1772.3	329175
16	1	50.2	19			476294
17	1	57.7	19			22880
18	3	96.3	19	1617.7	1315.7	167054
19	2	70.9	19	1872.1		311966
20	1	60.7	19			458616

Unless otherwise stated the results shown in this test report refer only to the sample(s) tested and such sample(s) are retained for 90 days only.

除非另有說明，此報告結果僅對測試之樣品負責，同時此樣品僅保留90天。本報告未經本公司書面許可，不可部份複製。

This document is issued by the Company subject to its General Conditions of Service printed overleaf, available on request or accessible at <http://www.sgs.com.tw/Terms-and-Conditions> and for electronic format documents, subject to Terms and Conditions for Electronic Documents at <http://www.sgs.com.tw/Terms-and-Conditions>. Attention is drawn to the limitation of liability, indemnification and jurisdiction issues defined therein. Any holder of this document is advised that information contained hereon reflects the Company's findings at the time of its intervention only and within the limits of Client's instructions, if any. The Company's sole responsibility is to its Client and this document does not exonerate parties to a transaction from exercising all their rights and obligations under the transaction documents. This document cannot be reproduced except in full, without prior written approval of the Company. Any unauthorized alteration, forgery or falsification of the content or appearance of this document is unlawful and offenders may be prosecuted to the fullest extent of the law.

14.13.25 Trial 25

Data Sheet for FCC Radar Type 5						
Trial Number:		25		VSG Frequency(MHz):		5320.184
Number of Bursts in Trial:			20		Successful Detection: Yes	
Burst (8-20)	Number Pulses per Burst (1-3)	Pulse Width (50-100)	Chirp Width (5-20)	Pulse 1-to-2 Spacing	Pulse 2-to-3 Spacing	Starting Location Within Interval
		(μ sec)	(MHz)	(μ sec)	(μ sec)	(μ sec)
1	2	81.9	20	1747.1		4972
2	1	62.6	20			150270
3	1	62.4	20			295146
4	1	59.6	20			440705
5	1	66.6	20			585945
6	2	70.9	20	1927.1		131840
7	3	83.4	20	1273.6	1651.6	275953
8	1	66	20			422341
9	3	93	20	1287	1229	565394
10	2	78.7	20	1908.3		113975
11	1	50.6	20			259629
12	2	80.9	20	1405.1		403645
13	2	67	20	1119		548813
14	3	89.2	20	1509.8	1008.8	96014
15	1	51.4	20			241566
16	2	67.6	20	1374.4		386144
17	3	90.5	20	1318.5	1145.5	529515
18	2	78.4	20	1374.6		78447
19	2	69.5	20	1465.5		223236
20	1	50.2	20			368841

Unless otherwise stated the results shown in this test report refer only to the sample(s) tested and such sample(s) are retained for 90 days only.

除非另有說明，此報告結果僅對測試之樣品負責，同時此樣品僅保留90天。本報告未經本公司書面許可，不可部份複製。

This document is issued by the Company subject to its General Conditions of Service printed overleaf, available on request or accessible at <http://www.sgs.com.tw/Terms-and-Conditions> and for electronic format documents, subject to Terms and Conditions for Electronic Documents at <http://www.sgs.com.tw/Terms-and-Conditions>. Attention is drawn to the limitation of liability, indemnification and jurisdiction issues defined therein. Any holder of this document is advised that information contained hereon reflects the Company's findings at the time of its intervention only and within the limits of Client's instructions, if any. The Company's sole responsibility is to its Client and this document does not exonerate parties to a transaction from exercising all their rights and obligations under the transaction documents. This document cannot be reproduced except in full, without prior written approval of the Company. Any unauthorized alteration, forgery or falsification of the content or appearance of this document is unlawful and offenders may be prosecuted to the fullest extent of the law.

14.13.26 Trial 26

Data Sheet for FCC Radar Type 5						
Trial Number:		26		VSG Frequency(MHz):		5320.984
Number of Bursts in Trial:			18		Successful Detection: Yes	
Burst (8-20)	Number Pulses per Burst (1-3)	Pulse Width (50-100)	Chirp Width (5-20)	Pulse 1-to-2 Spacing	Pulse 2-to-3 Spacing	Starting Location Within Interval
		(μ sec)	(MHz)	(μ sec)	(μ sec)	(μ sec)
1	3	98.9	18	1308.1	1758.1	568650
2	3	98.7	18	1695.3	1690.3	67123
3	2	81	18	929		228397
4	1	64.3	18			390410
5	2	76.4	18	1343.6		550359
6	1	56.5	18			47616
7	2	69.8	18	1199.2		208712
8	1	65.1	18			370179
9	3	98.3	18	1534.7	1270.7	528943
10	3	97	18	1717	1581	27624
11	2	76.4	18	1683.6		188468
12	3	97.3	18	1588.7	1219.7	348918
13	3	98.5	18	1611.5	1263.5	509458
14	3	100	18	1471	1010	7870
15	2	72.1	18	1282.9		168818
16	1	56.6	18			330451
17	3	89.6	18	1459.4	1814.4	489199
18	1	59	18			653547

Unless otherwise stated the results shown in this test report refer only to the sample(s) tested and such sample(s) are retained for 90 days only.

除非另有說明，此報告結果僅對測試之樣品負責，同時此樣品僅保留90天。本報告未經本公司書面許可，不可部份複製。

This document is issued by the Company subject to its General Conditions of Service printed overleaf, available on request or accessible at <http://www.sgs.com.tw/Terms-and-Conditions> and for electronic format documents, subject to Terms and Conditions for Electronic Documents at <http://www.sgs.com.tw/Terms-and-Conditions>. Attention is drawn to the limitation of liability, indemnification and jurisdiction issues defined therein. Any holder of this document is advised that information contained hereon reflects the Company's findings at the time of its intervention only and within the limits of Client's instructions, if any. The Company's sole responsibility is to its Client and this document does not exonerate parties to a transaction from exercising all their rights and obligations under the transaction documents. This document cannot be reproduced except in full, without prior written approval of the Company. Any unauthorized alteration, forgery or falsification of the content or appearance of this document is unlawful and offenders may be prosecuted to the fullest extent of the law.

14.13.27 Trial 27

Data Sheet for FCC Radar Type 5						
Trial Number:		27		VSG Frequency(MHz):		5324.584
Number of Bursts in Trial:			11		Successful Detection: Yes	
Burst (8-20)	Number Pulses per Burst (1-3)	Pulse Width (50-100)	Chirp Width (5-20)	Pulse 1-to-2 Spacing	Pulse 2-to-3 Spacing	Starting Location Within Interval
		(μ sec)	(MHz)	(μ sec)	(μ sec)	(μ sec)
1	3	96	9	964	1269	244138
2	2	67.1	9	1167.9		508034
3	1	54.3	9			772920
4	3	99.9	9	1046.1	1220.1	1035183
5	3	98	9	1600	940	211483
6	1	55.5	9			476199
7	2	82.1	9	1539.9		739691
8	1	59.1	9			1005073
9	3	97.1	9	1569.9	1053.9	179037
10	2	78.3	9	1685.7		442966
11	3	85	9	1745	1510	705622

Unless otherwise stated the results shown in this test report refer only to the sample(s) tested and such sample(s) are retained for 90 days only.

除非另有說明，此報告結果僅對測試之樣品負責，同時此樣品僅保留90天。本報告未經本公司書面許可，不可部份複製。

This document is issued by the Company subject to its General Conditions of Service printed overleaf, available on request or accessible at <http://www.sgs.com.tw/Terms-and-Conditions> and for electronic format documents, subject to Terms and Conditions for Electronic Documents at <http://www.sgs.com.tw/Terms-and-Conditions>. Attention is drawn to the limitation of liability, indemnification and jurisdiction issues defined therein. Any holder of this document is advised that information contained hereon reflects the Company's findings at the time of its intervention only and within the limits of Client's instructions, if any. The Company's sole responsibility is to its Client and this document does not exonerate parties to a transaction from exercising all their rights and obligations under the transaction documents. This document cannot be reproduced except in full, without prior written approval of the Company. Any unauthorized alteration, forgery or falsification of the content or appearance of this document is unlawful and offenders may be prosecuted to the fullest extent of the law.

14.13.28 Trial 28

Data Sheet for FCC Radar Type 5						
Trial Number:		28		VSG Frequency(MHz):		5321.384
Number of Bursts in Trial:			18		Successful Detection: Yes	
Burst (8-20)	Number Pulses per Burst (1-3)	Pulse Width (50-100)	Chirp Width (5-20)	Pulse 1-to-2 Spacing	Pulse 2-to-3 Spacing	Starting Location Within Interval
		(μ sec)	(MHz)	(μ sec)	(μ sec)	(μ sec)
1	2	74	17	1226		592566
2	1	59.8	17			89732
3	2	79.3	17	1839.7		250502
4	2	76.7	17	1083.3		411804
5	2	70.6	17	1421.4		572049
6	1	61.8	17			69871
7	2	83.2	17	1608.8		230717
8	2	81.7	17	1839.3		391658
9	3	98.1	17	1843.9	1145.9	551342
10	2	83.3	17	1716.7		49863
11	1	60	17			211312
12	1	51	17			372850
13	2	68.2	17	1899.8		532734
14	2	67.8	17	1688.2		30024
15	3	96	17	1446	1613	190604
16	1	52.3	17			352547
17	1	53.4	17			513835
18	2	82.4	17	1680.6		10225

Unless otherwise stated the results shown in this test report refer only to the sample(s) tested and such sample(s) are retained for 90 days only.

除非另有說明，此報告結果僅對測試之樣品負責，同時此樣品僅保留90天。本報告未經本公司書面許可，不可部份複製。

This document is issued by the Company subject to its General Conditions of Service printed overleaf, available on request or accessible at <http://www.sgs.com.tw/Terms-and-Conditions> and for electronic format documents, subject to Terms and Conditions for Electronic Documents at <http://www.sgs.com.tw/Terms-and-Conditions>. Attention is drawn to the limitation of liability, indemnification and jurisdiction issues defined therein. Any holder of this document is advised that information contained hereon reflects the Company's findings at the time of its intervention only and within the limits of Client's instructions, if any. The Company's sole responsibility is to its Client and this document does not exonerate parties to a transaction from exercising all their rights and obligations under the transaction documents. This document cannot be reproduced except in full, without prior written approval of the Company. Any unauthorized alteration, forgery or falsification of the content or appearance of this document is unlawful and offenders may be prosecuted to the fullest extent of the law.

14.13.29 Trial 29

Data Sheet for FCC Radar Type 5						
Trial Number:		29		VSG Frequency(MHz):		5325.784
Number of Bursts in Trial:			8		Successful Detection: Yes	
Burst (8-20)	Number Pulses per Burst (1-3)	Pulse Width (50-100)	Chirp Width (5-20)	Pulse 1-to-2 Spacing	Pulse 2-to-3 Spacing	Starting Location Within Interval
		(μ sec)	(MHz)	(μ sec)	(μ sec)	(μ sec)
1	2	67	6	1136		386176
2	2	67	6	975		749473
3	3	94.8	6	946.2	1399.2	1111261
4	2	78.1	6	1873.9		1475197
5	2	81.4	6	1855.6		341314
6	2	82.5	6	1477.5		704354
7	1	52.3	6			1068403
8	3	95.9	6	1723.1	1465.1	1429278

Unless otherwise stated the results shown in this test report refer only to the sample(s) tested and such sample(s) are retained for 90 days only.

除非另有說明，此報告結果僅對測試之樣品負責，同時此樣品僅保留90天。本報告未經本公司書面許可，不可部份複製。

This document is issued by the Company subject to its General Conditions of Service printed overleaf, available on request or accessible at <http://www.sgs.com.tw/Terms-and-Conditions> and for electronic format documents, subject to Terms and Conditions for Electronic Documents at <http://www.sgs.com.tw/Terms-and-Conditions>. Attention is drawn to the limitation of liability, indemnification and jurisdiction issues defined therein. Any holder of this document is advised that information contained hereon reflects the Company's findings at the time of its intervention only and within the limits of Client's instructions, if any. The Company's sole responsibility is to its Client and this document does not exonerate parties to a transaction from exercising all their rights and obligations under the transaction documents. This document cannot be reproduced except in full, without prior written approval of the Company. Any unauthorized alteration, forgery or falsification of the content or appearance of this document is unlawful and offenders may be prosecuted to the fullest extent of the law.

14.13.30 Trial 30

Data Sheet for FCC Radar Type 5						
Trial Number:		30		VSG Frequency(MHz):		5321.384
Number of Bursts in Trial:			18		Successful Detection: Yes	
Burst (8-20)	Number Pulses per Burst (1-3)	Pulse Width (50-100)	Chirp Width (5-20)	Pulse 1-to-2 Spacing	Pulse 2-to-3 Spacing	Starting Location Within Interval
		(μ sec)	(MHz)	(μ sec)	(μ sec)	(μ sec)
1	3	99.1	17	1050.9	1191.9	131268
2	1	50.7	17			293150
3	2	75.5	17	1479.5		453485
4	2	82.2	17	1702.8		613895
5	2	67.3	17	1725.7		111637
6	1	59.4	17			273119
7	3	91.5	17	1718.5	1057.5	432670
8	2	80.2	17	1136.8		594976
9	2	74.2	17	975.8		91921
10	3	87.2	17	1141.8	1835.8	252079
11	3	97.2	17	1803.8	1028.8	413002
12	2	70.5	17	1487.5		574498
13	2	77.9	17	1638.1		71981
14	3	88.2	17	1134.8	1636.8	232616
15	3	88.9	17	1484.1	1059.1	393436
16	2	74.9	17	1917.1		554812
17	3	91.5	17	1591.5	1728.5	52089
18	2	75.8	17	1480.2		213172

Unless otherwise stated the results shown in this test report refer only to the sample(s) tested and such sample(s) are retained for 90 days only.

除非另有說明，此報告結果僅對測試之樣品負責，同時此樣品僅保留90天。本報告未經本公司書面許可，不可部份複製。

This document is issued by the Company subject to its General Conditions of Service printed overleaf, available on request or accessible at <http://www.sgs.com.tw/Terms-and-Conditions> and for electronic format documents, subject to Terms and Conditions for Electronic Documents at <http://www.sgs.com.tw/Terms-and-Conditions>. Attention is drawn to the limitation of liability, indemnification and jurisdiction issues defined therein. Any holder of this document is advised that information contained hereon reflects the Company's findings at the time of its intervention only and within the limits of Client's instructions, if any. The Company's sole responsibility is to its Client and this document does not exonerate parties to a transaction from exercising all their rights and obligations under the transaction documents. This document cannot be reproduced except in full, without prior written approval of the Company. Any unauthorized alteration, forgery or falsification of the content or appearance of this document is unlawful and offenders may be prosecuted to the fullest extent of the law.

14.14 Radar Type 6 for 5310 MHz:

Data Sheet for FCC Radar Type 6						
Trial	Pulse Width	PRI	Pulses per Hop	Hopping Rate	Hopping Sequence Length	Successful Detection
	(μ sec)	(μ sec)		(kHz)	(msec)	(Yes/No)
1	1	333	9	0.333	300	Yes
2	1	333	9	0.333	300	Yes
3	1	333	9	0.333	300	Yes
4	1	333	9	0.333	300	Yes
5	1	333	9	0.333	300	Yes
6	1	333	9	0.333	300	Yes
7	1	333	9	0.333	300	Yes
8	1	333	9	0.333	300	Yes
9	1	333	9	0.333	300	Yes
10	1	333	9	0.333	300	Yes
11	1	333	9	0.333	300	Yes
12	1	333	9	0.333	300	Yes
13	1	333	9	0.333	300	Yes
14	1	333	9	0.333	300	Yes
15	1	333	9	0.333	300	Yes
16	1	333	9	0.333	300	Yes
17	1	333	9	0.333	300	Yes
18	1	333	9	0.333	300	Yes
19	1	333	9	0.333	300	Yes
20	1	333	9	0.333	300	Yes
21	1	333	9	0.333	300	Yes
22	1	333	9	0.333	300	Yes
23	1	333	9	0.333	300	Yes
24	1	333	9	0.333	300	No
25	1	333	9	0.333	300	Yes
26	1	333	9	0.333	300	Yes
27	1	333	9	0.333	300	Yes
28	1	333	9	0.333	300	Yes
29	1	333	9	0.333	300	Yes
30	1	333	9	0.333	300	Yes

Unless otherwise stated the results shown in this test report refer only to the sample(s) tested and such sample(s) are retained for 90 days only.

除非另有說明，此報告結果僅對測試之樣品負責，同時此樣品僅保留90天。本報告未經本公司書面許可，不可部份複製。

This document is issued by the Company subject to its General Conditions of Service printed overleaf, available on request or accessible at <http://www.sgs.com.tw/Terms-and-Conditions> and for electronic format documents, subject to Terms and Conditions for Electronic Documents at <http://www.sgs.com.tw/Terms-and-Conditions>. Attention is drawn to the limitation of liability, indemnification and jurisdiction issues defined therein. Any holder of this document is advised that information contained hereon reflects the Company's findings at the time of its intervention only and within the limits of Client's instructions, if any. The Company's sole responsibility is to its Client and this document does not exonerate parties to a transaction from exercising all their rights and obligations under the transaction documents. This document cannot be reproduced except in full, without prior written approval of the Company. Any unauthorized alteration, forgery or falsification of the content or appearance of this document is unlawful and offenders may be prosecuted to the fullest extent of the law.

14.15 5320MHz:

Short Pulse Radar Type	Minimum Number of Trials	Detection(%)		Minimum Percentage of Successful Detection(%)	Pass/Fail
1	30	73.33		60	Pass
2	30	100		60	Pass
3	30	96.67		60	Pass
4	30	90		60	Pass
Aggregate (Radar Types 1-4)	120	90		80	Pass
Long Pulse Radar Type	Minimum Number of Trials	Each Detection(%)	Total Detection(%)	Minimum Percentage of Successful Detection(%)	Pass/Fail
5	Center:10	80	86.66666667	80	Pass
	Low Edge:10	80			
	High Edge:10	100			
Frequency Hopping Radar Type	Minimum Number of Trials	Detection(%)		Minimum Percentage of Successful Detection(%)	Pass/Fail
6	30	96.66666667		70	Pass

Unless otherwise stated the results shown in this test report refer only to the sample(s) tested and such sample(s) are retained for 90 days only.

除非另有說明，此報告結果僅對測試之樣品負責，同時此樣品僅保留90天。本報告未經本公司書面許可，不可部份複製。

This document is issued by the Company subject to its General Conditions of Service printed overleaf, available on request or accessible at <http://www.sgs.com.tw/Terms-and-Conditions> and for electronic format documents, subject to Terms and Conditions for Electronic Documents at <http://www.sgs.com.tw/Terms-and-Conditions>. Attention is drawn to the limitation of liability, indemnification and jurisdiction issues defined therein. Any holder of this document is advised that information contained hereon reflects the Company's findings at the time of its intervention only and within the limits of Client's instructions, if any. The Company's sole responsibility is to its Client and this document does not exonerate parties to a transaction from exercising all their rights and obligations under the transaction documents. This document cannot be reproduced except in full, without prior written approval of the Company. Any unauthorized alteration, forgery or falsification of the content or appearance of this document is unlawful and offenders may be prosecuted to the fullest extent of the law.

14.16 Radar Type 1 for 5320 MHz:

Data Sheet for FCC Radar Type 1						
Trial	VSG Frequency (MHz)	Pulse Repetition Frequency	Pulse Repetition Frequency	PRI	Test A/B	Successful Detection
		Number (1 to 23)	(Pulses Per Second)	(msec)	A/B	(Yes/No)
1	5320	16	1222.5	818	A	Yes
2	5320	12	1355	738	A	Yes
3	5320	11	1392.8	718	A	Yes
4	5320	17	1193.3	838	A	Yes
5	5320	9	1474.9	678	A	Yes
6	5320	10	1432.7	698	A	Yes
7	5320	4	1730.1	578	A	Yes
8	5320	15	1253.1	798	A	Yes
9	5320	8	1519.8	658	A	Yes
10	5320	5	1672.2	598	A	Yes
11	5320	20	1113.6	898	A	Yes
12	5320	3	1792.1	558	A	Yes
13	5320	13	1319.3	758	A	Yes
14	5320	2	1858.7	538	A	Yes
15	5320	19	1139	878	A	Yes
16	5320	-	755.3	1324	B	Yes
17	5320	-	336.5	2972	B	No
18	5320	-	445	2247	B	Yes
19	5320	-	628.1	1592	B	No
20	5320	-	546.1	1831	B	No
21	5320	-	901.7	1109	B	Yes
22	5320	-	646	1548	B	No
23	5320	-	327.5	3053	B	Yes
24	5320	-	847.5	1180	B	Yes
25	5320	-	378.9	2639	B	No
26	5320	-	679.3	1472	B	No
27	5320	-	356.5	2805	B	No
28	5320	-	1100.1	909	B	Yes
29	5320	-	512.6	1951	B	No
30	5320	-	1179.2	848	B	Yes

Unless otherwise stated the results shown in this test report refer only to the sample(s) tested and such sample(s) are retained for 90 days only.

除非另有說明，此報告結果僅對測試之樣品負責，同時此樣品僅保留90天。本報告未經本公司書面許可，不可部份複製。

This document is issued by the Company subject to its General Conditions of Service printed overleaf, available on request or accessible at <http://www.sgs.com.tw/Terms-and-Conditions> and for electronic format documents, subject to Terms and Conditions for Electronic Documents at <http://www.sgs.com.tw/Terms-and-Conditions>. Attention is drawn to the limitation of liability, indemnification and jurisdiction issues defined therein. Any holder of this document is advised that information contained hereon reflects the Company's findings at the time of its intervention only and within the limits of Client's instructions, if any. The Company's sole responsibility is to its Client and this document does not exonerate parties to a transaction from exercising all their rights and obligations under the transaction documents. This document cannot be reproduced except in full, without prior written approval of the Company. Any unauthorized alteration, forgery or falsification of the content or appearance of this document is unlawful and offenders may be prosecuted to the fullest extent of the law.

14.17 Radar Type 2 for 5320 MHz:

Data Sheet for FCC Radar Type 2

Trial	VSG Frequency (MHz)	Number Pulses per Burst (23-29)	Pulse Width (1-5)	PRI (150-230)	Successful Detection
			(μ s)	(μ s)	(Yes/No)
1	5320	25	2.2	191	Yes
2	5320	26	3.3	186	Yes
3	5320	29	4.8	227	Yes
4	5320	29	5	185	Yes
5	5320	25	2.1	222	Yes
6	5320	28	4.5	175	Yes
7	5320	28	4	190	Yes
8	5320	23	1.1	220	Yes
9	5320	28	4.1	213	Yes
10	5320	23	1.1	223	Yes
11	5320	25	2.5	157	Yes
12	5320	26	2.8	217	Yes
13	5320	24	1.7	216	Yes
14	5320	24	1.6	179	Yes
15	5320	26	2.8	155	Yes
16	5320	25	2.7	196	Yes
17	5320	24	1.6	152	Yes
18	5320	25	2.2	170	Yes
19	5320	24	1.6	188	Yes
20	5320	24	1.7	178	Yes
21	5320	26	2.7	192	Yes
22	5320	24	2.1	197	Yes
23	5320	25	2.3	180	Yes
24	5320	23	1.2	221	Yes
25	5320	26	2.9	207	Yes
26	5320	27	3.7	209	Yes
27	5320	29	4.8	229	Yes
28	5320	29	5	212	Yes
29	5320	29	4.9	176	Yes
30	5320	27	3.4	160	Yes

Unless otherwise stated the results shown in this test report refer only to the sample(s) tested and such sample(s) are retained for 90 days only.

除非另有說明，此報告結果僅對測試之樣品負責，同時此樣品僅保留90天。本報告未經本公司書面許可，不可部份複製。

This document is issued by the Company subject to its General Conditions of Service printed overleaf, available on request or accessible at <http://www.sgs.com.tw/Terms-and-Conditions> and for electronic format documents, subject to Terms and Conditions for Electronic Documents at <http://www.sgs.com.tw/Terms-and-Conditions>. Attention is drawn to the limitation of liability, indemnification and jurisdiction issues defined therein. Any holder of this document is advised that information contained hereon reflects the Company's findings at the time of its intervention only and within the limits of Client's instructions, if any. The Company's sole responsibility is to its Client and this document does not exonerate parties to a transaction from exercising all their rights and obligations under the transaction documents. This document cannot be reproduced except in full, without prior written approval of the Company. Any unauthorized alteration, forgery or falsification of the content or appearance of this document is unlawful and offenders may be prosecuted to the fullest extent of the law.

14.18 Radar Type 3 for 5320 MHz:

Data Sheet for FCC Radar Type 3

Trial	VSG Frequency (MHz)	Number Pulses per Burst (16-18)	Pulse Width (6-10)	PRI (200-500)	Successful Detection
			(μ s)	(μ s)	(Yes/No)
1	5320	16	7.2	379	Yes
2	5320	17	8.3	353	Yes
3	5320	18	9.8	462	Yes
4	5320	18	10	428	Yes
5	5320	16	7.1	354	Yes
6	5320	18	9.5	222	Yes
7	5320	18	9	364	Yes
8	5320	16	6.1	217	Yes
9	5320	18	9.1	387	Yes
10	5320	16	6.1	433	Yes
11	5320	17	7.5	246	Yes
12	5320	17	7.8	231	No
13	5320	16	6.7	228	Yes
14	5320	16	6.6	375	Yes
15	5320	17	7.8	304	Yes
16	5320	17	7.7	215	Yes
17	5320	16	6.6	500	Yes
18	5320	16	7.2	401	Yes
19	5320	16	6.6	216	Yes
20	5320	16	6.7	251	Yes
21	5320	17	7.7	202	Yes
22	5320	16	7.1	461	Yes
23	5320	16	7.3	267	Yes
24	5320	16	6.2	227	Yes
25	5320	17	7.9	362	Yes
26	5320	18	8.7	358	Yes
27	5320	18	9.8	204	Yes
28	5320	18	10	219	Yes
29	5320	18	9.9	315	Yes
30	5320	17	8.4	351	Yes

Unless otherwise stated the results shown in this test report refer only to the sample(s) tested and such sample(s) are retained for 90 days only.

除非另有說明，此報告結果僅對測試之樣品負責，同時此樣品僅保留90天。本報告未經本公司書面許可，不可部份複製。

This document is issued by the Company subject to its General Conditions of Service printed overleaf, available on request or accessible at <http://www.sgs.com.tw/Terms-and-Conditions> and for electronic format documents, subject to Terms and Conditions for Electronic Documents at <http://www.sgs.com.tw/Terms-and-Conditions>. Attention is drawn to the limitation of liability, indemnification and jurisdiction issues defined therein. Any holder of this document is advised that information contained hereon reflects the Company's findings at the time of its intervention only and within the limits of Client's instructions, if any. The Company's sole responsibility is to its Client and this document does not exonerate parties to a transaction from exercising all their rights and obligations under the transaction documents. This document cannot be reproduced except in full, without prior written approval of the Company. Any unauthorized alteration, forgery or falsification of the content or appearance of this document is unlawful and offenders may be prosecuted to the fullest extent of the law.

14.19 Radar Type 4 for 5320 MHz:

Data Sheet for FCC Radar Type 4					
Trial	VSG Frequency (MHz)	Number Pulses per Burst (12-16)	Pulse Width (11-20)	PRI (200-500)	Successful Detection
			(μ s)	(μ s)	(Yes/No)
1	5320	13	13.8	379	Yes
2	5320	14	16.1	353	Yes
3	5320	16	19.6	462	Yes
4	5320	16	19.9	428	No
5	5320	13	13.6	354	Yes
6	5320	16	18.7	222	Yes
7	5320	15	17.7	364	Yes
8	5320	12	11.2	217	Yes
9	5320	15	17.9	387	Yes
10	5320	12	11.3	433	Yes
11	5320	13	14.4	246	Yes
12	5320	14	15	231	Yes
13	5320	12	12.7	228	Yes
14	5320	12	12.4	375	Yes
15	5320	14	15	304	Yes
16	5320	14	14.8	215	Yes
17	5320	12	12.3	500	No
18	5320	13	13.7	401	Yes
19	5320	12	12.4	216	No
20	5320	12	12.7	251	Yes
21	5320	14	14.9	202	Yes
22	5320	13	13.4	461	Yes
23	5320	13	14	267	Yes
24	5320	12	11.4	227	Yes
25	5320	14	15.3	362	Yes
26	5320	15	17.1	358	Yes
27	5320	16	19.5	204	Yes
28	5320	16	20	219	Yes
29	5320	16	19.7	315	Yes
30	5320	14	16.4	351	Yes

Unless otherwise stated the results shown in this test report refer only to the sample(s) tested and such sample(s) are retained for 90 days only.

除非另有說明，此報告結果僅對測試之樣品負責，同時此樣品僅保留90天。本報告未經本公司書面許可，不可部份複製。

This document is issued by the Company subject to its General Conditions of Service printed overleaf, available on request or accessible at <http://www.sgs.com.tw/Terms-and-Conditions> and for electronic format documents, subject to Terms and Conditions for Electronic Documents at <http://www.sgs.com.tw/Terms-and-Conditions>. Attention is drawn to the limitation of liability, indemnification and jurisdiction issues defined therein. Any holder of this document is advised that information contained hereon reflects the Company's findings at the time of its intervention only and within the limits of Client's instructions, if any. The Company's sole responsibility is to its Client and this document does not exonerate parties to a transaction from exercising all their rights and obligations under the transaction documents. This document cannot be reproduced except in full, without prior written approval of the Company. Any unauthorized alteration, forgery or falsification of the content or appearance of this document is unlawful and offenders may be prosecuted to the fullest extent of the law.

14.20 Radar Type 5 for 5320 MHz:

14.20.1 Trial 1:

Data Sheet for FCC Radar Type 5						
Trial Number:		1		VSG Frequency(MHz):		5320
Number of Bursts in Trial:			14		Successful Detection: No	
Burst (8-20)	Number Pulses per Burst (1-3)	Pulse Width (50-100)	Chirp Width (5-20)	Pulse 1-to-2 Spacing	Pulse 2-to-3 Spacing	Starting Location Within Interval
		(μ sec)	(MHz)	(μ sec)	(μ sec)	(μ sec)
1	2	75.7	13	1450.3		646095
2	2	76.2	13	1835.8		853391
3	3	98.6	13	1660.4	1151.4	206260
4	1	60	13			414310
5	3	88.3	13	1410.7	982.7	620248
6	1	52	13			829565
7	3	92.7	13	1451.3	1091.3	180697
8	3	84.5	13	1906.5	1481.5	387097
9	2	79.4	13	1230.6		595173
10	3	86.3	13	1491.7	1529.7	801190
11	1	52.5	13			155846
12	1	65.8	13			363169
13	1	51.8	13			570697
14	3	96.5	13	919.5	1148.5	776534

Unless otherwise stated the results shown in this test report refer only to the sample(s) tested and such sample(s) are retained for 90 days only.

除非另有說明，此報告結果僅對測試之樣品負責，同時此樣品僅保留90天。本報告未經本公司書面許可，不可部份複製。

This document is issued by the Company subject to its General Conditions of Service printed overleaf, available on request or accessible at <http://www.sgs.com.tw/Terms-and-Conditions> and for electronic format documents, subject to Terms and Conditions for Electronic Documents at <http://www.sgs.com.tw/Terms-and-Conditions>. Attention is drawn to the limitation of liability, indemnification and jurisdiction issues defined therein. Any holder of this document is advised that information contained hereon reflects the Company's findings at the time of its intervention only and within the limits of Client's instructions, if any. The Company's sole responsibility is to its Client and this document does not exonerate parties to a transaction from exercising all their rights and obligations under the transaction documents. This document cannot be reproduced except in full, without prior written approval of the Company. Any unauthorized alteration, forgery or falsification of the content or appearance of this document is unlawful and offenders may be prosecuted to the fullest extent of the law.

14.20.2 Trial 2:

Data Sheet for FCC Radar Type 5						
Trial Number:		2		VSG Frequency(MHz):		5320
Number of Bursts in Trial:			14		Successful Detection: Yes	
Burst (8-20)	Number Pulses per Burst (1-3)	Pulse Width (50-100)	Chirp Width (5-20)	Pulse 1-to-2 Spacing	Pulse 2-to-3 Spacing	Starting Location Within Interval
		(μ sec)	(MHz)	(μ sec)	(μ sec)	(μ sec)
1	3	89.7	13	1178.3	976.3	129878
2	3	96.5	13	1823.5	1552.5	336196
3	2	78.6	13	1730.4		544288
4	3	92.6	13	1348.4	1150.4	750076
5	3	92.6	13	1533.4	1761.4	104294
6	3	93	13	1878	1609	310994
7	2	70.3	13	1860.7		518416
8	1	66	13			727353
9	2	78.7	13	1898.3		78905
10	3	96.3	13	954.7	1546.7	285586
11	3	97.7	13	1410.3	1595.3	492469
12	3	92.3	13	1052.7	1690.7	699494
13	1	65.3	13			53555
14	3	88.9	13	1411.1	1716.1	260074

Unless otherwise stated the results shown in this test report refer only to the sample(s) tested and such sample(s) are retained for 90 days only.

除非另有說明，此報告結果僅對測試之樣品負責，同時此樣品僅保留90天。本報告未經本公司書面許可，不可部份複製。

This document is issued by the Company subject to its General Conditions of Service printed overleaf, available on request or accessible at <http://www.sgs.com.tw/Terms-and-Conditions> and for electronic format documents, subject to Terms and Conditions for Electronic Documents at <http://www.sgs.com.tw/Terms-and-Conditions>. Attention is drawn to the limitation of liability, indemnification and jurisdiction issues defined therein. Any holder of this document is advised that information contained hereon reflects the Company's findings at the time of its intervention only and within the limits of Client's instructions, if any. The Company's sole responsibility is to its Client and this document does not exonerate parties to a transaction from exercising all their rights and obligations under the transaction documents. This document cannot be reproduced except in full, without prior written approval of the Company. Any unauthorized alteration, forgery or falsification of the content or appearance of this document is unlawful and offenders may be prosecuted to the fullest extent of the law.

14.20.3 Trial 3

Data Sheet for FCC Radar Type 5						
Trial Number:		3		VSG Frequency(MHz):		5320
Number of Bursts in Trial:			20		Successful Detection: Yes	
Burst (8-20)	Number Pulses per Burst (1-3)	Pulse Width (50-100)	Chirp Width (5-20)	Pulse 1-to-2 Spacing	Pulse 2-to-3 Spacing	Starting Location Within Interval
		(μ sec)	(MHz)	(μ sec)	(μ sec)	(μ sec)
1	1	53.1	20			327984
2	3	90	20	1789	1447	470347
3	2	82.3	20	1038.7		19538
4	2	76.2	20	1301.8		164251
5	2	80.3	20	1314.7		309125
6	3	91.2	20	1887.8	1592.8	452206
7	2	82.6	20	1648.4		1697
8	1	56.7	20			146959
9	2	69.4	20	1711.6		291322
10	2	71	20	1475		436052
11	3	97.9	20	1413.1	1179.1	579415
12	3	93.2	20	1553.8	1022.8	128485
13	2	72.1	20	1223.9		273557
14	3	94.6	20	1584.4	990.4	417454
15	3	90.4	20	1291.6	1396.6	561415
16	3	85.2	20	1173.8	1748.8	110459
17	3	95.3	20	1538.7	1756.7	254888
18	2	71.2	20	1839.8		400255
19	1	64.1	20			546815
20	2	74.5	20	1751.5		92943

Unless otherwise stated the results shown in this test report refer only to the sample(s) tested and such sample(s) are retained for 90 days only.

除非另有說明，此報告結果僅對測試之樣品負責，同時此樣品僅保留90天。本報告未經本公司書面許可，不可部份複製。

This document is issued by the Company subject to its General Conditions of Service printed overleaf, available on request or accessible at <http://www.sgs.com.tw/Terms-and-Conditions> and for electronic format documents, subject to Terms and Conditions for Electronic Documents at <http://www.sgs.com.tw/Terms-and-Conditions>. Attention is drawn to the limitation of liability, indemnification and jurisdiction issues defined therein. Any holder of this document is advised that information contained hereon reflects the Company's findings at the time of its intervention only and within the limits of Client's instructions, if any. The Company's sole responsibility is to its Client and this document does not exonerate parties to a transaction from exercising all their rights and obligations under the transaction documents. This document cannot be reproduced except in full, without prior written approval of the Company. Any unauthorized alteration, forgery or falsification of the content or appearance of this document is unlawful and offenders may be prosecuted to the fullest extent of the law.

14.20.4 Trial 4

Data Sheet for FCC Radar Type 5						
Trial Number:		4		VSG Frequency(MHz):		5320
Number of Bursts in Trial:			10		Successful Detection: Yes	
Burst (8-20)	Number Pulses per Burst (1-3)	Pulse Width (50-100)	Chirp Width (5-20)	Pulse 1-to-2 Spacing	Pulse 2-to-3 Spacing	Starting Location Within Interval
		(μ sec)	(MHz)	(μ sec)	(μ sec)	(μ sec)
1	2	71.3	8	1835.7		476618
2	1	57.3	8			768080
3	3	95.2	8	917.8	1522.8	1056357
4	2	82.8	8	1172.2		150695
5	2	79.5	8	1775.5		441008
6	2	68.9	8	1636.1		731474
7	1	53.6	8			1022491
8	1	59.6	8			115101
9	3	97.5	8	1330.5	1620.5	404670
10	1	52.3	8			696336

Unless otherwise stated the results shown in this test report refer only to the sample(s) tested and such sample(s) are retained for 90 days only.

除非另有說明，此報告結果僅對測試之樣品負責，同時此樣品僅保留90天。本報告未經本公司書面許可，不可部份複製。

This document is issued by the Company subject to its General Conditions of Service printed overleaf, available on request or accessible at <http://www.sgs.com.tw/Terms-and-Conditions> and for electronic format documents, subject to Terms and Conditions for Electronic Documents at <http://www.sgs.com.tw/Terms-and-Conditions>. Attention is drawn to the limitation of liability, indemnification and jurisdiction issues defined therein. Any holder of this document is advised that information contained hereon reflects the Company's findings at the time of its intervention only and within the limits of Client's instructions, if any. The Company's sole responsibility is to its Client and this document does not exonerate parties to a transaction from exercising all their rights and obligations under the transaction documents. This document cannot be reproduced except in full, without prior written approval of the Company. Any unauthorized alteration, forgery or falsification of the content or appearance of this document is unlawful and offenders may be prosecuted to the fullest extent of the law.

14.20.5 Trial 5

Data Sheet for FCC Radar Type 5						
Trial Number:		5		VSG Frequency(MHz):		5320
Number of Bursts in Trial:			17		Successful Detection: No	
Burst (8-20)	Number Pulses per Burst (1-3)	Pulse Width (50-100)	Chirp Width (5-20)	Pulse 1-to-2 Spacing	Pulse 2-to-3 Spacing	Starting Location Within Interval
		(μ sec)	(MHz)	(μ sec)	(μ sec)	(μ sec)
1	1	62.3	17			580292
2	3	96	17	1892	1376	46376
3	3	86.7	17	1845.3	1609.3	216364
4	1	53.7	17			388124
5	2	81.3	17	1741.7		557500
6	3	89.5	17	1284.5	1043.5	25448
7	1	53.9	17			196365
8	2	76.3	17	1248.7		366324
9	3	85.6	17	1399.4	1573.4	535403
10	1	60.6	17			4498
11	1	63.8	17			175244
12	2	82.9	17	1841.1		345455
13	2	77	17	950		516472
14	1	57.6	17			687535
15	3	94.7	17	1506.3	1682.3	153508
16	3	99.4	17	1072.6	1097.6	324212
17	2	70.8	17	1827.2		494914

Unless otherwise stated the results shown in this test report refer only to the sample(s) tested and such sample(s) are retained for 90 days only.

除非另有說明，此報告結果僅對測試之樣品負責，同時此樣品僅保留90天。本報告未經本公司書面許可，不可部份複製。

This document is issued by the Company subject to its General Conditions of Service printed overleaf, available on request or accessible at <http://www.sgs.com.tw/Terms-and-Conditions> and for electronic format documents, subject to Terms and Conditions for Electronic Documents at <http://www.sgs.com.tw/Terms-and-Conditions>. Attention is drawn to the limitation of liability, indemnification and jurisdiction issues defined therein. Any holder of this document is advised that information contained hereon reflects the Company's findings at the time of its intervention only and within the limits of Client's instructions, if any. The Company's sole responsibility is to its Client and this document does not exonerate parties to a transaction from exercising all their rights and obligations under the transaction documents. This document cannot be reproduced except in full, without prior written approval of the Company. Any unauthorized alteration, forgery or falsification of the content or appearance of this document is unlawful and offenders may be prosecuted to the fullest extent of the law.

14.20.6 Trial 6

Data Sheet for FCC Radar Type 5						
Trial Number:		6		VSG Frequency(MHz):		5320
Number of Bursts in Trial:			8		Successful Detection: Yes	
Burst (8-20)	Number Pulses per Burst (1-3)	Pulse Width (50-100)	Chirp Width (5-20)	Pulse 1-to-2 Spacing	Pulse 2-to-3 Spacing	Starting Location Within Interval
		(μ sec)	(MHz)	(μ sec)	(μ sec)	(μ sec)
1	2	75.7	5	1039.3		1417883
2	2	75.7	5	1675.3		283058
3	3	93.5	5	1267.5	1790.5	645459
4	1	50.9	5			1010268
5	2	76.5	5	1874.5		1371553
6	2	78.2	5	1352.8		238446
7	3	90.9	5	1594.1	1659.1	600817
8	2	67.6	5	1311.4		964778

Unless otherwise stated the results shown in this test report refer only to the sample(s) tested and such sample(s) are retained for 90 days only.

除非另有說明，此報告結果僅對測試之樣品負責，同時此樣品僅保留90天。本報告未經本公司書面許可，不可部份複製。

This document is issued by the Company subject to its General Conditions of Service printed overleaf, available on request or accessible at <http://www.sgs.com.tw/Terms-and-Conditions> and for electronic format documents, subject to Terms and Conditions for Electronic Documents at <http://www.sgs.com.tw/Terms-and-Conditions>. Attention is drawn to the limitation of liability, indemnification and jurisdiction issues defined therein. Any holder of this document is advised that information contained hereon reflects the Company's findings at the time of its intervention only and within the limits of Client's instructions, if any. The Company's sole responsibility is to its Client and this document does not exonerate parties to a transaction from exercising all their rights and obligations under the transaction documents. This document cannot be reproduced except in full, without prior written approval of the Company. Any unauthorized alteration, forgery or falsification of the content or appearance of this document is unlawful and offenders may be prosecuted to the fullest extent of the law.

14.20.7 Trial 7

Data Sheet for FCC Radar Type 5						
Trial Number:		7		VSG Frequency(MHz):		5320
Number of Bursts in Trial:			19		Successful Detection: Yes	
Burst (8-20)	Number Pulses per Burst (1-3)	Pulse Width (50-100)	Chirp Width (5-20)	Pulse 1-to-2 Spacing	Pulse 2-to-3 Spacing	Starting Location Within Interval
		(μ sec)	(MHz)	(μ sec)	(μ sec)	(μ sec)
1	3	95.8	18	1832.2	1410.2	555394
2	3	94.9	18	1322.1	1204.1	81223
3	3	99.5	18	1355.5	1089.5	233328
4	3	96.8	18	1535.2	1145.2	385633
5	1	61.3	18			540366
6	3	87.5	18	1422.5	1401.5	62393
7	2	72.9	18	1379.1		215032
8	1	59.2	18			368445
9	2	67.1	18	1004.9		520066
10	1	58.6	18			43887
11	1	51.8	18			196798
12	1	56.4	18			349750
13	2	68.4	18	1078.6		501484
14	1	63.2	18			25077
15	1	50.8	18			177809
16	2	81.2	18	1690.8		329509
17	2	68.9	18	1214.1		482804
18	3	85.6	18	1638.4	1504.4	6218
19	1	53.4	18			159040

Unless otherwise stated the results shown in this test report refer only to the sample(s) tested and such sample(s) are retained for 90 days only.

除非另有說明，此報告結果僅對測試之樣品負責，同時此樣品僅保留90天。本報告未經本公司書面許可，不可部份複製。

This document is issued by the Company subject to its General Conditions of Service printed overleaf, available on request or accessible at <http://www.sgs.com.tw/Terms-and-Conditions> and for electronic format documents, subject to Terms and Conditions for Electronic Documents at <http://www.sgs.com.tw/Terms-and-Conditions>. Attention is drawn to the limitation of liability, indemnification and jurisdiction issues defined therein. Any holder of this document is advised that information contained hereon reflects the Company's findings at the time of its intervention only and within the limits of Client's instructions, if any. The Company's sole responsibility is to its Client and this document does not exonerate parties to a transaction from exercising all their rights and obligations under the transaction documents. This document cannot be reproduced except in full, without prior written approval of the Company. Any unauthorized alteration, forgery or falsification of the content or appearance of this document is unlawful and offenders may be prosecuted to the fullest extent of the law.

14.20.8 Trial 8

Data Sheet for FCC Radar Type 5						
Trial Number:		8		VSG Frequency(MHz):		5320
Number of Bursts in Trial:			16		Successful Detection: Yes	
Burst (8-20)	Number Pulses per Burst (1-3)	Pulse Width (50-100)	Chirp Width (5-20)	Pulse 1-to-2 Spacing	Pulse 2-to-3 Spacing	Starting Location Within Interval
		(μ sec)	(MHz)	(μ sec)	(μ sec)	(μ sec)
1	1	60.6	16			370709
2	3	88.4	16	1673.6	1542.6	549691
3	2	80.4	16	1180.6		732531
4	3	87.6	16	1044.4	1739.4	165939
5	3	88.2	16	1018.8	1348.8	346815
6	2	80.1	16	1083.9		529051
7	3	98.1	16	1002.9	932.9	709596
8	2	78	16	1770		143881
9	3	84	16	1829	955	324420
10	1	53.9	16			507438
11	1	51.3	16			689099
12	3	85.9	16	1091.1	973.1	121440
13	2	67.8	16	1372.2		302742
14	3	95.8	16	1367.2	1777.2	483049
15	3	86.1	16	1808.9	1553.9	663080
16	3	85.6	16	1203.4	1201.4	99115

Unless otherwise stated the results shown in this test report refer only to the sample(s) tested and such sample(s) are retained for 90 days only.

除非另有說明，此報告結果僅對測試之樣品負責，同時此樣品僅保留90天。本報告未經本公司書面許可，不可部份複製。

This document is issued by the Company subject to its General Conditions of Service printed overleaf, available on request or accessible at <http://www.sgs.com.tw/Terms-and-Conditions> and for electronic format documents, subject to Terms and Conditions for Electronic Documents at <http://www.sgs.com.tw/Terms-and-Conditions>. Attention is drawn to the limitation of liability, indemnification and jurisdiction issues defined therein. Any holder of this document is advised that information contained hereon reflects the Company's findings at the time of its intervention only and within the limits of Client's instructions, if any. The Company's sole responsibility is to its Client and this document does not exonerate parties to a transaction from exercising all their rights and obligations under the transaction documents. This document cannot be reproduced except in full, without prior written approval of the Company. Any unauthorized alteration, forgery or falsification of the content or appearance of this document is unlawful and offenders may be prosecuted to the fullest extent of the law.

14.20.9 Trial 9

Data Sheet for FCC Radar Type 5						
Trial Number:		9		VSG Frequency(MHz):		5320
Number of Bursts in Trial:			15		Successful Detection: Yes	
Burst (8-20)	Number Pulses per Burst (1-3)	Pulse Width (50-100)	Chirp Width (5-20)	Pulse 1-to-2 Spacing	Pulse 2-to-3 Spacing	Starting Location Within Interval
		(μ sec)	(MHz)	(μ sec)	(μ sec)	(μ sec)
1	3	94.7	14	1479.3	1263.3	298833
2	1	54.5	14			493176
3	2	79.6	14	1873.4		685083
4	2	74.2	14	1843.8		82062
5	2	73.2	14	1416.8		275417
6	3	90.9	14	1149.1	1074.1	467980
7	2	73.7	14	1483.3		662375
8	1	59.9	14			58438
9	3	99	14	1378	1647	251182
10	3	92.8	14	1777.2	1876.2	443379
11	3	93	14	1382	1233	637342
12	1	52.4	14			34582
13	1	62.4	14			228187
14	2	74.8	14	1905.2		420798
15	1	62.3	14			615553

Unless otherwise stated the results shown in this test report refer only to the sample(s) tested and such sample(s) are retained for 90 days only.

除非另有說明，此報告結果僅對測試之樣品負責，同時此樣品僅保留90天。本報告未經本公司書面許可，不可部份複製。

This document is issued by the Company subject to its General Conditions of Service printed overleaf, available on request or accessible at <http://www.sgs.com.tw/Terms-and-Conditions> and for electronic format documents, subject to Terms and Conditions for Electronic Documents at <http://www.sgs.com.tw/Terms-and-Conditions>. Attention is drawn to the limitation of liability, indemnification and jurisdiction issues defined therein. Any holder of this document is advised that information contained hereon reflects the Company's findings at the time of its intervention only and within the limits of Client's instructions, if any. The Company's sole responsibility is to its Client and this document does not exonerate parties to a transaction from exercising all their rights and obligations under the transaction documents. This document cannot be reproduced except in full, without prior written approval of the Company. Any unauthorized alteration, forgery or falsification of the content or appearance of this document is unlawful and offenders may be prosecuted to the fullest extent of the law.

14.20.10 Trial 10

Data Sheet for FCC Radar Type 5						
Trial Number:		10		VSG Frequency(MHz):		5320
Number of Bursts in Trial:			17		Successful Detection: Yes	
Burst (8-20)	Number Pulses per Burst (1-3)	Pulse Width (50-100)	Chirp Width (5-20)	Pulse 1-to-2 Spacing	Pulse 2-to-3 Spacing	Starting Location Within Interval
		(μ sec)	(MHz)	(μ sec)	(μ sec)	(μ sec)
1	2	82	16	1608		9460
2	3	90.9	16	1895.1	1899.1	179231
3	2	74.7	16	971.3		350504
4	2	80.3	16	1727.7		520285
5	2	79.3	16	1343.7		691395
6	1	65.4	16			159274
7	1	57.2	16			330226
8	1	61.3	16			500882
9	2	66.7	16	1384.3		670070
10	1	63.3	16			138302
11	1	59.5	16			308892
12	3	89	16	956	1389	478108
13	1	55.2	16			651105
14	1	65.7	16			117181
15	2	72.8	16	1140.2		287537
16	3	84.1	16	1657.9	1577.9	456409
17	1	60.6	16			630080

Unless otherwise stated the results shown in this test report refer only to the sample(s) tested and such sample(s) are retained for 90 days only.

除非另有說明，此報告結果僅對測試之樣品負責，同時此樣品僅保留90天。本報告未經本公司書面許可，不可部份複製。

This document is issued by the Company subject to its General Conditions of Service printed overleaf, available on request or accessible at <http://www.sgs.com.tw/Terms-and-Conditions> and for electronic format documents, subject to Terms and Conditions for Electronic Documents at <http://www.sgs.com.tw/Terms-and-Conditions>. Attention is drawn to the limitation of liability, indemnification and jurisdiction issues defined therein. Any holder of this document is advised that information contained hereon reflects the Company's findings at the time of its intervention only and within the limits of Client's instructions, if any. The Company's sole responsibility is to its Client and this document does not exonerate parties to a transaction from exercising all their rights and obligations under the transaction documents. This document cannot be reproduced except in full, without prior written approval of the Company. Any unauthorized alteration, forgery or falsification of the content or appearance of this document is unlawful and offenders may be prosecuted to the fullest extent of the law.

14.20.11 Trial 11

Data Sheet for FCC Radar Type 5						
Trial Number:		11		VSG Frequency(MHz):		5313.1685
Number of Bursts in Trial:			8		Successful Detection: No	
Burst (8-20)	Number Pulses per Burst (1-3)	Pulse Width (50-100)	Chirp Width (5-20)	Pulse 1-to-2 Spacing	Pulse 2-to-3 Spacing	Starting Location Within Interval
		(μ sec)	(MHz)	(μ sec)	(μ sec)	(μ sec)
1	2	82.3	5	1891.7		204286
2	2	77.7	5	1726.3		567132
3	1	56.2	5			931599
4	2	76.6	5	1705.4		1293038
5	3	89.4	5	1564.6	1775.6	159393
6	1	61.4	5			523221
7	2	80.3	5	1636.7		885768
8	2	69.7	5	1494.3		1249162

Unless otherwise stated the results shown in this test report refer only to the sample(s) tested and such sample(s) are retained for 90 days only.

除非另有說明，此報告結果僅對測試之樣品負責，同時此樣品僅保留90天。本報告未經本公司書面許可，不可部份複製。

This document is issued by the Company subject to its General Conditions of Service printed overleaf, available on request or accessible at <http://www.sgs.com.tw/Terms-and-Conditions> and for electronic format documents, subject to Terms and Conditions for Electronic Documents at <http://www.sgs.com.tw/Terms-and-Conditions>. Attention is drawn to the limitation of liability, indemnification and jurisdiction issues defined therein. Any holder of this document is advised that information contained hereon reflects the Company's findings at the time of its intervention only and within the limits of Client's instructions, if any. The Company's sole responsibility is to its Client and this document does not exonerate parties to a transaction from exercising all their rights and obligations under the transaction documents. This document cannot be reproduced except in full, without prior written approval of the Company. Any unauthorized alteration, forgery or falsification of the content or appearance of this document is unlawful and offenders may be prosecuted to the fullest extent of the law.

14.20.12 Trial 12

Data Sheet for FCC Radar Type 5						
Trial Number:		12		VSG Frequency(MHz):		5315.1685
Number of Bursts in Trial:			12		Successful Detection: Yes	
Burst (8-20)	Number Pulses per Burst (1-3)	Pulse Width (50-100)	Chirp Width (5-20)	Pulse 1-to-2 Spacing	Pulse 2-to-3 Spacing	Starting Location Within Interval
		(μ sec)	(MHz)	(μ sec)	(μ sec)	(μ sec)
1	1	64.7	10			76661
2	2	70.5	10	1788.5		318052
3	3	88.7	10	1145.3	1370.3	559355
4	3	95.4	10	1585.6	977.6	800973
5	3	87.2	10	1730.8	931.8	46677
6	3	95.7	10	1486.3	1643.3	287993
7	1	65.5	10			531115
8	1	59.1	10			773599
9	3	91.7	10	1495.3	944.3	16922
10	2	69.4	10	1818.6		258740
11	3	95.1	10	1223.9	1397.9	499728
12	3	93.2	10	1751.8	1222.8	740884

Unless otherwise stated the results shown in this test report refer only to the sample(s) tested and such sample(s) are retained for 90 days only.

除非另有說明，此報告結果僅對測試之樣品負責，同時此樣品僅保留90天。本報告未經本公司書面許可，不可部份複製。

This document is issued by the Company subject to its General Conditions of Service printed overleaf, available on request or accessible at <http://www.sgs.com.tw/Terms-and-Conditions> and for electronic format documents, subject to Terms and Conditions for Electronic Documents at <http://www.sgs.com.tw/Terms-and-Conditions>. Attention is drawn to the limitation of liability, indemnification and jurisdiction issues defined therein. Any holder of this document is advised that information contained hereon reflects the Company's findings at the time of its intervention only and within the limits of Client's instructions, if any. The Company's sole responsibility is to its Client and this document does not exonerate parties to a transaction from exercising all their rights and obligations under the transaction documents. This document cannot be reproduced except in full, without prior written approval of the Company. Any unauthorized alteration, forgery or falsification of the content or appearance of this document is unlawful and offenders may be prosecuted to the fullest extent of the law.

14.20.13 Trial 13

Data Sheet for FCC Radar Type 5						
Trial Number:		13		VSG Frequency(MHz):		5313.1685
Number of Bursts in Trial:			8		Successful Detection: Yes	
Burst (8-20)	Number Pulses per Burst (1-3)	Pulse Width (50-100)	Chirp Width (5-20)	Pulse 1-to-2 Spacing	Pulse 2-to-3 Spacing	Starting Location Within Interval
		(μ sec)	(MHz)	(μ sec)	(μ sec)	(μ sec)
1	1	65.5	5			1479371
2	1	56.8	5			344182
3	2	70.1	5	1105.9		706970
4	3	87.4	5	1570.6	1874.6	1068743
5	3	93.3	5	1060.7	1618.7	1432093
6	1	62.8	5			299316
7	1	60.9	5			662666
8	1	63.7	5			1026325

Unless otherwise stated the results shown in this test report refer only to the sample(s) tested and such sample(s) are retained for 90 days only.

除非另有說明，此報告結果僅對測試之樣品負責，同時此樣品僅保留90天。本報告未經本公司書面許可，不可部份複製。

This document is issued by the Company subject to its General Conditions of Service printed overleaf, available on request or accessible at <http://www.sgs.com.tw/Terms-and-Conditions> and for electronic format documents, subject to Terms and Conditions for Electronic Documents at <http://www.sgs.com.tw/Terms-and-Conditions>. Attention is drawn to the limitation of liability, indemnification and jurisdiction issues defined therein. Any holder of this document is advised that information contained hereon reflects the Company's findings at the time of its intervention only and within the limits of Client's instructions, if any. The Company's sole responsibility is to its Client and this document does not exonerate parties to a transaction from exercising all their rights and obligations under the transaction documents. This document cannot be reproduced except in full, without prior written approval of the Company. Any unauthorized alteration, forgery or falsification of the content or appearance of this document is unlawful and offenders may be prosecuted to the fullest extent of the law.

14.20.14 Trial 14

Data Sheet for FCC Radar Type 5						
Trial Number:		14		VSG Frequency(MHz):		5318.7685
Number of Bursts in Trial:			20		Successful Detection: Yes	
Burst (8-20)	Number Pulses per Burst (1-3)	Pulse Width (50-100)	Chirp Width (5-20)	Pulse 1-to-2 Spacing	Pulse 2-to-3 Spacing	Starting Location Within Interval
		(μ sec)	(MHz)	(μ sec)	(μ sec)	(μ sec)
1	1	51.9	19			555310
2	2	68.4	19	1297.6		101410
3	3	94.2	19	937.8	1678.8	245502
4	2	76.1	19	1023.9		391491
5	1	58.7	19			537470
6	2	82.3	19	1078.7		83620
7	2	70.1	19	1302.9		228490
8	3	84.7	19	1375.3	1583.3	372232
9	2	68.6	19	1426.4		517894
10	3	85.7	19	963.3	1248.3	65637
11	3	92.7	19	1210.3	1139.3	210105
12	2	79.5	19	1500.5		355398
13	3	94.5	19	1452.5	1043.5	498911
14	1	60.5	19			48049
15	1	64.6	19			193165
16	3	95	19	1062	1748	336831
17	2	68.6	19	1053.4		482936
18	1	65.9	19			30180
19	2	79.6	19	945.4		175084
20	2	67.6	19	933.4		320145

Unless otherwise stated the results shown in this test report refer only to the sample(s) tested and such sample(s) are retained for 90 days only.

除非另有說明，此報告結果僅對測試之樣品負責，同時此樣品僅保留90天。本報告未經本公司書面許可，不可部份複製。

This document is issued by the Company subject to its General Conditions of Service printed overleaf, available on request or accessible at <http://www.sgs.com.tw/Terms-and-Conditions> and for electronic format documents, subject to Terms and Conditions for Electronic Documents at <http://www.sgs.com.tw/Terms-and-Conditions>. Attention is drawn to the limitation of liability, indemnification and jurisdiction issues defined therein. Any holder of this document is advised that information contained hereon reflects the Company's findings at the time of its intervention only and within the limits of Client's instructions, if any. The Company's sole responsibility is to its Client and this document does not exonerate parties to a transaction from exercising all their rights and obligations under the transaction documents. This document cannot be reproduced except in full, without prior written approval of the Company. Any unauthorized alteration, forgery or falsification of the content or appearance of this document is unlawful and offenders may be prosecuted to the fullest extent of the law.

14.20.15 Trial 15

Data Sheet for FCC Radar Type 5						
Trial Number:		15		VSG Frequency(MHz):		5317.9685
Number of Bursts in Trial:			18		Successful Detection: Yes	
Burst (8-20)	Number Pulses per Burst (1-3)	Pulse Width (50-100)	Chirp Width (5-20)	Pulse 1-to-2 Spacing	Pulse 2-to-3 Spacing	Starting Location Within Interval
		(μ sec)	(MHz)	(μ sec)	(μ sec)	(μ sec)
1	3	94	17	1439	1888	514754
2	2	79.9	17	1615.1		13624
3	1	63.6	17			175105
4	3	96.4	17	1606.6	1207.6	334596
5	2	77.7	17	1836.3		496335
6	3	91	17	1245	1130	656012
7	3	95.2	17	1843.8	1354.8	154230
8	2	75.5	17	1645.5		315659
9	1	57.6	17			477960
10	2	68.8	17	948.2		638361
11	3	83.4	17	1039.6	1116.6	134744
12	2	76.6	17	1028.4		296218
13	1	50.4	17			458029
14	1	66.5	17			618940
15	2	67.8	17	1250.2		115207
16	3	96.3	17	1337.7	984.7	275765
17	2	76.3	17	1450.7		436688
18	1	62.5	17			598976

Unless otherwise stated the results shown in this test report refer only to the sample(s) tested and such sample(s) are retained for 90 days only.

除非另有說明，此報告結果僅對測試之樣品負責，同時此樣品僅保留90天。本報告未經本公司書面許可，不可部份複製。

This document is issued by the Company subject to its General Conditions of Service printed overleaf, available on request or accessible at <http://www.sgs.com.tw/Terms-and-Conditions> and for electronic format documents, subject to Terms and Conditions for Electronic Documents at <http://www.sgs.com.tw/Terms-and-Conditions>. Attention is drawn to the limitation of liability, indemnification and jurisdiction issues defined therein. Any holder of this document is advised that information contained hereon reflects the Company's findings at the time of its intervention only and within the limits of Client's instructions, if any. The Company's sole responsibility is to its Client and this document does not exonerate parties to a transaction from exercising all their rights and obligations under the transaction documents. This document cannot be reproduced except in full, without prior written approval of the Company. Any unauthorized alteration, forgery or falsification of the content or appearance of this document is unlawful and offenders may be prosecuted to the fullest extent of the law.

14.20.16 Trial 16

Data Sheet for FCC Radar Type 5						
Trial Number:		16		VSG Frequency(MHz):		5318.7685
Number of Bursts in Trial:			20		Successful Detection: Yes	
Burst (8-20)	Number Pulses per Burst (1-3)	Pulse Width (50-100)	Chirp Width (5-20)	Pulse 1-to-2 Spacing	Pulse 2-to-3 Spacing	Starting Location Within Interval
		(μ sec)	(MHz)	(μ sec)	(μ sec)	(μ sec)
1	3	86.6	19	1849.4	1340.4	85405
2	1	54.8	19			231183
3	2	75.5	19	1790.5		375035
4	2	80.8	19	1449.2		520228
5	3	90.5	19	931.5	1160.5	67791
6	1	56	19			213098
7	2	76.7	19	1877.3		357248
8	1	65.6	19			503347
9	3	98.7	19	1273.3	1295.3	49898
10	1	55	19			195306
11	3	92.3	19	1251.7	1171.7	339090
12	2	75.1	19	979.9		484759
13	2	68.8	19	1501.2		32183
14	2	77.3	19	1798.7		176994
15	2	83.2	19	1421.8		321885
16	3	93.3	19	1451.7	1520.7	465477
17	2	69.7	19	932.3		14378
18	2	72.1	19	1385.9		159073
19	1	54.8	19			304639
20	3	97.9	19	1634.1	939.1	447875

Unless otherwise stated the results shown in this test report refer only to the sample(s) tested and such sample(s) are retained for 90 days only.

除非另有說明，此報告結果僅對測試之樣品負責，同時此樣品僅保留90天。本報告未經本公司書面許可，不可部份複製。

This document is issued by the Company subject to its General Conditions of Service printed overleaf, available on request or accessible at <http://www.sgs.com.tw/Terms-and-Conditions> and for electronic format documents, subject to Terms and Conditions for Electronic Documents at <http://www.sgs.com.tw/Terms-and-Conditions>. Attention is drawn to the limitation of liability, indemnification and jurisdiction issues defined therein. Any holder of this document is advised that information contained hereon reflects the Company's findings at the time of its intervention only and within the limits of Client's instructions, if any. The Company's sole responsibility is to its Client and this document does not exonerate parties to a transaction from exercising all their rights and obligations under the transaction documents. This document cannot be reproduced except in full, without prior written approval of the Company. Any unauthorized alteration, forgery or falsification of the content or appearance of this document is unlawful and offenders may be prosecuted to the fullest extent of the law.

14.20.17 Trial 17

Data Sheet for FCC Radar Type 5						
Trial Number:		17		VSG Frequency(MHz):		5316.7685
Number of Bursts in Trial:			15		Successful Detection: No	
Burst (8-20)	Number Pulses per Burst (1-3)	Pulse Width (50-100)	Chirp Width (5-20)	Pulse 1-to-2 Spacing	Pulse 2-to-3 Spacing	Starting Location Within Interval
		(μ sec)	(MHz)	(μ sec)	(μ sec)	(μ sec)
1	3	98.5	14	1529.5	1540.5	790275
2	2	67.8	14	967.2		188767
3	3	87.2	14	1393.8	1408.8	381473
4	3	94.7	14	1083.3	1702.3	574184
5	2	77.1	14	1188.9		768439
6	3	99.9	14	1371.1	1009.1	164630
7	1	52.2	14			358931
8	1	66	14			552374
9	2	79	14	1802		743959
10	2	77.9	14	1074.1		141116
11	3	92.8	14	1900.2	1228.2	333425
12	2	68.3	14	1261.7		527752
13	2	68.6	14	1277.4		720969
14	1	56.1	14			117503
15	2	79.4	14	997.6		310715

Unless otherwise stated the results shown in this test report refer only to the sample(s) tested and such sample(s) are retained for 90 days only.

除非另有說明，此報告結果僅對測試之樣品負責，同時此樣品僅保留90天。本報告未經本公司書面許可，不可部份複製。

This document is issued by the Company subject to its General Conditions of Service printed overleaf, available on request or accessible at <http://www.sgs.com.tw/Terms-and-Conditions> and for electronic format documents, subject to Terms and Conditions for Electronic Documents at <http://www.sgs.com.tw/Terms-and-Conditions>. Attention is drawn to the limitation of liability, indemnification and jurisdiction issues defined therein. Any holder of this document is advised that information contained hereon reflects the Company's findings at the time of its intervention only and within the limits of Client's instructions, if any. The Company's sole responsibility is to its Client and this document does not exonerate parties to a transaction from exercising all their rights and obligations under the transaction documents. This document cannot be reproduced except in full, without prior written approval of the Company. Any unauthorized alteration, forgery or falsification of the content or appearance of this document is unlawful and offenders may be prosecuted to the fullest extent of the law.

14.20.18 Trial 18

Data Sheet for FCC Radar Type 5						
Trial Number:		18		VSG Frequency(MHz):		5318.3685
Number of Bursts in Trial:			19		Successful Detection: Yes	
Burst (8-20)	Number Pulses per Burst (1-3)	Pulse Width (50-100)	Chirp Width (5-20)	Pulse 1-to-2 Spacing	Pulse 2-to-3 Spacing	Starting Location Within Interval
		(μ sec)	(MHz)	(μ sec)	(μ sec)	(μ sec)
1	2	74.7	18	1195.3		397610
2	3	92.2	18	986.8	1411.8	548460
3	1	63.1	18			73913
4	3	89.4	18	1857.6	1340.6	225288
5	1	57.5	18			379635
6	2	69.6	18	1755.4		530955
7	1	62.1	18			55066
8	3	92.3	18	1823.7	1520.7	206531
9	3	90.1	18	1411.9	1426.9	359180
10	2	83.3	18	1525.7		511995
11	2	82.5	18	920.5		36177
12	1	50	18			189009
13	1	56	18			341672
14	3	93.4	18	958.6	1162.6	492876
15	1	57.1	18			17384
16	3	96.9	18	1903.1	1547.1	169257
17	3	95.7	18	1611.3	1631.3	321056
18	3	91.5	18	1837.5	1020.5	473521
19	2	78.5	18	1722.5		626753

Unless otherwise stated the results shown in this test report refer only to the sample(s) tested and such sample(s) are retained for 90 days only.

除非另有說明，此報告結果僅對測試之樣品負責，同時此樣品僅保留90天。本報告未經本公司書面許可，不可部份複製。

This document is issued by the Company subject to its General Conditions of Service printed overleaf, available on request or accessible at <http://www.sgs.com.tw/Terms-and-Conditions> and for electronic format documents, subject to Terms and Conditions for Electronic Documents at <http://www.sgs.com.tw/Terms-and-Conditions>. Attention is drawn to the limitation of liability, indemnification and jurisdiction issues defined therein. Any holder of this document is advised that information contained hereon reflects the Company's findings at the time of its intervention only and within the limits of Client's instructions, if any. The Company's sole responsibility is to its Client and this document does not exonerate parties to a transaction from exercising all their rights and obligations under the transaction documents. This document cannot be reproduced except in full, without prior written approval of the Company. Any unauthorized alteration, forgery or falsification of the content or appearance of this document is unlawful and offenders may be prosecuted to the fullest extent of the law.

14.20.19 Trial 19

Data Sheet for FCC Radar Type 5						
Trial Number:		19		VSG Frequency(MHz):		5318.3685
Number of Bursts in Trial:			19		Successful Detection: Yes	
Burst (8-20)	Number Pulses per Burst (1-3)	Pulse Width (50-100)	Chirp Width (5-20)	Pulse 1-to-2 Spacing	Pulse 2-to-3 Spacing	Starting Location Within Interval
		(μ sec)	(MHz)	(μ sec)	(μ sec)	(μ sec)
1	1	64.1	18			151404
2	2	68.7	18	1329.3		303636
3	2	67.7	18	1621.3		455897
4	2	80.9	18	925.1		608478
5	1	53.7	18			132455
6	3	90.7	18	1583.3	965.3	284045
7	1	53.7	18			438429
8	1	60.7	18			591109
9	3	86.6	18	1369.4	1362.4	113150
10	2	70.7	18	1328.3		266125
11	1	62.2	18			419294
12	2	73.9	18	1043.1		571533
13	1	56.5	18			94839
14	1	62.7	18			247847
15	3	98	18	1526	1572	398132
16	1	58.4	18			553311
17	1	51.1	18			76048
18	1	56.6	18			228873
19	2	82.8	18	1720.2		380555

Unless otherwise stated the results shown in this test report refer only to the sample(s) tested and such sample(s) are retained for 90 days only.

除非另有說明，此報告結果僅對測試之樣品負責，同時此樣品僅保留90天。本報告未經本公司書面許可，不可部份複製。

This document is issued by the Company subject to its General Conditions of Service printed overleaf, available on request or accessible at <http://www.sgs.com.tw/Terms-and-Conditions> and for electronic format documents, subject to Terms and Conditions for Electronic Documents at <http://www.sgs.com.tw/Terms-and-Conditions>. Attention is drawn to the limitation of liability, indemnification and jurisdiction issues defined therein. Any holder of this document is advised that information contained hereon reflects the Company's findings at the time of its intervention only and within the limits of Client's instructions, if any. The Company's sole responsibility is to its Client and this document does not exonerate parties to a transaction from exercising all their rights and obligations under the transaction documents. This document cannot be reproduced except in full, without prior written approval of the Company. Any unauthorized alteration, forgery or falsification of the content or appearance of this document is unlawful and offenders may be prosecuted to the fullest extent of the law.

14.20.20 Trial 20

Data Sheet for FCC Radar Type 5						
Trial Number:		20		VSG Frequency(MHz):		5318.3685
Number of Bursts in Trial:			19	Successful Detection:		Yes
Burst (8-20)	Number Pulses per Burst (1-3)	Pulse Width (50-100)	Chirp Width (5-20)	Pulse 1-to-2 Spacing	Pulse 2-to-3 Spacing	Starting Location Within Interval
		(μ sec)	(MHz)	(μ sec)	(μ sec)	(μ sec)
1	3	97.3	18	1385.7	1004.7	532247
2	2	78.3	18	1527.7		57131
3	3	86.3	18	1377.7	941.7	209175
4	2	75.6	18	1300.4		361912
5	3	97.1	18	1425.9	1562.9	512859
6	1	61.3	18			38427
7	3	94.7	18	1832.3	1797.3	189951
8	3	99.9	18	1615.1	1227.1	342491
9	3	96.2	18	1114.8	1128.8	495260
10	2	72.7	18	1002.3		19590
11	2	71.8	18	1446.2		172045
12	2	81.1	18	1817.9		324012
13	3	97.1	18	911.9	1082.9	476328
14	2	76.9	18	1550.1		795
15	3	90.2	18	1815.8	1585.8	152759
16	3	92	18	1261	1695	304775
17	1	60.6	18			459016
18	1	57	18			612493
19	1	61.2	18			134877

Unless otherwise stated the results shown in this test report refer only to the sample(s) tested and such sample(s) are retained for 90 days only.

除非另有說明，此報告結果僅對測試之樣品負責，同時此樣品僅保留90天。本報告未經本公司書面許可，不可部份複製。

This document is issued by the Company subject to its General Conditions of Service printed overleaf, available on request or accessible at <http://www.sgs.com.tw/Terms-and-Conditions> and for electronic format documents, subject to Terms and Conditions for Electronic Documents at <http://www.sgs.com.tw/Terms-and-Conditions>. Attention is drawn to the limitation of liability, indemnification and jurisdiction issues defined therein. Any holder of this document is advised that information contained hereon reflects the Company's findings at the time of its intervention only and within the limits of Client's instructions, if any. The Company's sole responsibility is to its Client and this document does not exonerate parties to a transaction from exercising all their rights and obligations under the transaction documents. This document cannot be reproduced except in full, without prior written approval of the Company. Any unauthorized alteration, forgery or falsification of the content or appearance of this document is unlawful and offenders may be prosecuted to the fullest extent of the law.

14.20.21 Trial 21

Data Sheet for FCC Radar Type 5						
Trial Number:		21		VSG Frequency(MHz):		5324.4315
Number of Bursts in Trial:			13		Successful Detection: Yes	
Burst (8-20)	Number Pulses per Burst (1-3)	Pulse Width (50-100)	Chirp Width (5-20)	Pulse 1-to-2 Spacing	Pulse 2-to-3 Spacing	Starting Location Within Interval
		(μ sec)	(MHz)	(μ sec)	(μ sec)	(μ sec)
1	1	59.3	11			420586
2	3	98.7	11	1621.3	1301.3	641808
3	1	53.8	11			867823
4	1	58.9	11			169631
5	2	75.5	11	1554.5		392320
6	2	71.5	11	1535.5		615399
7	2	77.8	11	1860.2		838671
8	1	59.4	11			142128
9	2	76	11	1021		365105
10	3	87.3	11	1224.7	1506.7	587038
11	1	58.1	11			813032
12	3	84.9	11	1098.1	1553.1	114183
13	1	55.9	11			337935

Unless otherwise stated the results shown in this test report refer only to the sample(s) tested and such sample(s) are retained for 90 days only.

除非另有說明，此報告結果僅對測試之樣品負責，同時此樣品僅保留90天。本報告未經本公司書面許可，不可部份複製。

This document is issued by the Company subject to its General Conditions of Service printed overleaf, available on request or accessible at <http://www.sgs.com.tw/Terms-and-Conditions> and for electronic format documents, subject to Terms and Conditions for Electronic Documents at <http://www.sgs.com.tw/Terms-and-Conditions>. Attention is drawn to the limitation of liability, indemnification and jurisdiction issues defined therein. Any holder of this document is advised that information contained hereon reflects the Company's findings at the time of its intervention only and within the limits of Client's instructions, if any. The Company's sole responsibility is to its Client and this document does not exonerate parties to a transaction from exercising all their rights and obligations under the transaction documents. This document cannot be reproduced except in full, without prior written approval of the Company. Any unauthorized alteration, forgery or falsification of the content or appearance of this document is unlawful and offenders may be prosecuted to the fullest extent of the law.

14.20.22 Trial 22

Data Sheet for FCC Radar Type 5						
Trial Number:		22		VSG Frequency(MHz):		5324.8315
Number of Bursts in Trial:			12		Successful Detection: Yes	
Burst (8-20)	Number Pulses per Burst (1-3)	Pulse Width (50-100)	Chirp Width (5-20)	Pulse 1-to-2 Spacing	Pulse 2-to-3 Spacing	Starting Location Within Interval
		(μ sec)	(MHz)	(μ sec)	(μ sec)	(μ sec)
1	3	90.2	10	1273.8	1204.8	606736
2	1	62.9	10			850876
3	3	94.2	10	1482.8	1602.8	93968
4	1	50.2	10			336477
5	2	77.8	10	936.2		577757
6	3	93.2	10	1579.8	1677.8	817990
7	2	70.7	10	1139.3		64356
8	2	69.6	10	1677.4		306218
9	1	59.1	10			548542
10	3	90.9	10	1382.1	993.1	788888
11	1	57.5	10			34613
12	3	88.1	10	923.9	1836.9	275921

Unless otherwise stated the results shown in this test report refer only to the sample(s) tested and such sample(s) are retained for 90 days only.

除非另有說明，此報告結果僅對測試之樣品負責，同時此樣品僅保留90天。本報告未經本公司書面許可，不可部份複製。

This document is issued by the Company subject to its General Conditions of Service printed overleaf, available on request or accessible at <http://www.sgs.com.tw/Terms-and-Conditions> and for electronic format documents, subject to Terms and Conditions for Electronic Documents at <http://www.sgs.com.tw/Terms-and-Conditions>. Attention is drawn to the limitation of liability, indemnification and jurisdiction issues defined therein. Any holder of this document is advised that information contained hereon reflects the Company's findings at the time of its intervention only and within the limits of Client's instructions, if any. The Company's sole responsibility is to its Client and this document does not exonerate parties to a transaction from exercising all their rights and obligations under the transaction documents. This document cannot be reproduced except in full, without prior written approval of the Company. Any unauthorized alteration, forgery or falsification of the content or appearance of this document is unlawful and offenders may be prosecuted to the fullest extent of the law.

14.20.23 Trial 23

Data Sheet for FCC Radar Type 5						
Trial Number:		23		VSG Frequency(MHz):		5323.2315
Number of Bursts in Trial:			15		Successful Detection: Yes	
Burst (8-20)	Number Pulses per Burst (1-3)	Pulse Width (50-100)	Chirp Width (5-20)	Pulse 1-to-2 Spacing	Pulse 2-to-3 Spacing	Starting Location Within Interval
		(μ sec)	(MHz)	(μ sec)	(μ sec)	(μ sec)
1	1	64.7	14			415120
2	3	89.6	14	1085.4	1597.4	606453
3	1	65.2	14			3836
4	3	97.1	14	1273.9	1796.9	196765
5	1	66.3	14			391306
6	2	70.7	14	1892.3		583184
7	3	87.3	14	1673.7	1200.7	775695
8	1	51.4	14			173646
9	3	90	14	998	1587	366139
10	3	97.3	14	1723.7	1681.7	558113
11	3	84.2	14	1194.8	1188.8	752330
12	3	93.5	14	1780.5	1458.5	149161
13	2	69.3	14	1497.7		342569
14	1	60.7	14			537050
15	1	54	14			730970

Unless otherwise stated the results shown in this test report refer only to the sample(s) tested and such sample(s) are retained for 90 days only.

除非另有說明，此報告結果僅對測試之樣品負責，同時此樣品僅保留90天。本報告未經本公司書面許可，不可部份複製。

This document is issued by the Company subject to its General Conditions of Service printed overleaf, available on request or accessible at <http://www.sgs.com.tw/Terms-and-Conditions> and for electronic format documents, subject to Terms and Conditions for Electronic Documents at <http://www.sgs.com.tw/Terms-and-Conditions>. Attention is drawn to the limitation of liability, indemnification and jurisdiction issues defined therein. Any holder of this document is advised that information contained hereon reflects the Company's findings at the time of its intervention only and within the limits of Client's instructions, if any. The Company's sole responsibility is to its Client and this document does not exonerate parties to a transaction from exercising all their rights and obligations under the transaction documents. This document cannot be reproduced except in full, without prior written approval of the Company. Any unauthorized alteration, forgery or falsification of the content or appearance of this document is unlawful and offenders may be prosecuted to the fullest extent of the law.

14.20.24 Trial 24

Data Sheet for FCC Radar Type 5						
Trial Number:		24		VSG Frequency(MHz):		5321.2315
Number of Bursts in Trial:			20		Successful Detection: Yes	
Burst (8-20)	Number Pulses per Burst (1-3)	Pulse Width (50-100)	Chirp Width (5-20)	Pulse 1-to-2 Spacing	Pulse 2-to-3 Spacing	Starting Location Within Interval
		(μ sec)	(MHz)	(μ sec)	(μ sec)	(μ sec)
1	2	69.3	19	1293.7		94192
2	1	51.9	19			239745
3	2	68.6	19	1582.4		383859
4	1	62.5	19			529765
5	3	88.1	19	915.9	1048.9	76228
6	3	87.8	19	1104.2	1140.2	220653
7	1	65.8	19			366886
8	3	90.9	19	1123.1	1324.1	509849
9	3	84.2	19	1904.8	1361.8	58326
10	2	82.8	19	1605.2		203265
11	3	90	19	1177	1126	347500
12	1	64.1	19			494229
13	2	67.4	19	1012.6		40688
14	3	86.4	19	1558.6	1100.6	185058
15	3	91.7	19	1461.3	1772.3	329175
16	1	50.2	19			476294
17	1	57.7	19			22880
18	3	96.3	19	1617.7	1315.7	167054
19	2	70.9	19	1872.1		311966
20	1	60.7	19			458616

Unless otherwise stated the results shown in this test report refer only to the sample(s) tested and such sample(s) are retained for 90 days only.

除非另有說明，此報告結果僅對測試之樣品負責，同時此樣品僅保留90天。本報告未經本公司書面許可，不可部份複製。

This document is issued by the Company subject to its General Conditions of Service printed overleaf, available on request or accessible at <http://www.sgs.com.tw/Terms-and-Conditions> and for electronic format documents, subject to Terms and Conditions for Electronic Documents at <http://www.sgs.com.tw/Terms-and-Conditions>. Attention is drawn to the limitation of liability, indemnification and jurisdiction issues defined therein. Any holder of this document is advised that information contained hereon reflects the Company's findings at the time of its intervention only and within the limits of Client's instructions, if any. The Company's sole responsibility is to its Client and this document does not exonerate parties to a transaction from exercising all their rights and obligations under the transaction documents. This document cannot be reproduced except in full, without prior written approval of the Company. Any unauthorized alteration, forgery or falsification of the content or appearance of this document is unlawful and offenders may be prosecuted to the fullest extent of the law.

14.20.25 Trial 25

Data Sheet for FCC Radar Type 5						
Trial Number:		25		VSG Frequency(MHz):		5320.8315
Number of Bursts in Trial:			20		Successful Detection: Yes	
Burst (8-20)	Number Pulses per Burst (1-3)	Pulse Width (50-100)	Chirp Width (5-20)	Pulse 1-to-2 Spacing	Pulse 2-to-3 Spacing	Starting Location Within Interval
		(μ sec)	(MHz)	(μ sec)	(μ sec)	(μ sec)
1	2	81.9	20	1747.1		4972
2	1	62.6	20			150270
3	1	62.4	20			295146
4	1	59.6	20			440705
5	1	66.6	20			585945
6	2	70.9	20	1927.1		131840
7	3	83.4	20	1273.6	1651.6	275953
8	1	66	20			422341
9	3	93	20	1287	1229	565394
10	2	78.7	20	1908.3		113975
11	1	50.6	20			259629
12	2	80.9	20	1405.1		403645
13	2	67	20	1119		548813
14	3	89.2	20	1509.8	1008.8	96014
15	1	51.4	20			241566
16	2	67.6	20	1374.4		386144
17	3	90.5	20	1318.5	1145.5	529515
18	2	78.4	20	1374.6		78447
19	2	69.5	20	1465.5		223236
20	1	50.2	20			368841

Unless otherwise stated the results shown in this test report refer only to the sample(s) tested and such sample(s) are retained for 90 days only.

除非另有說明，此報告結果僅對測試之樣品負責，同時此樣品僅保留90天。本報告未經本公司書面許可，不可部份複製。

This document is issued by the Company subject to its General Conditions of Service printed overleaf, available on request or accessible at <http://www.sgs.com.tw/Terms-and-Conditions> and for electronic format documents, subject to Terms and Conditions for Electronic Documents at <http://www.sgs.com.tw/Terms-and-Conditions>. Attention is drawn to the limitation of liability, indemnification and jurisdiction issues defined therein. Any holder of this document is advised that information contained hereon reflects the Company's findings at the time of its intervention only and within the limits of Client's instructions, if any. The Company's sole responsibility is to its Client and this document does not exonerate parties to a transaction from exercising all their rights and obligations under the transaction documents. This document cannot be reproduced except in full, without prior written approval of the Company. Any unauthorized alteration, forgery or falsification of the content or appearance of this document is unlawful and offenders may be prosecuted to the fullest extent of the law.

14.20.26 Trial 26

Data Sheet for FCC Radar Type 5						
Trial Number:		26		VSG Frequency(MHz):		5321.6315
Number of Bursts in Trial:			18		Successful Detection: Yes	
Burst (8-20)	Number Pulses per Burst (1-3)	Pulse Width (50-100)	Chirp Width (5-20)	Pulse 1-to-2 Spacing	Pulse 2-to-3 Spacing	Starting Location Within Interval
		(μ sec)	(MHz)	(μ sec)	(μ sec)	(μ sec)
1	3	98.9	18	1308.1	1758.1	568650
2	3	98.7	18	1695.3	1690.3	67123
3	2	81	18	929		228397
4	1	64.3	18			390410
5	2	76.4	18	1343.6		550359
6	1	56.5	18			47616
7	2	69.8	18	1199.2		208712
8	1	65.1	18			370179
9	3	98.3	18	1534.7	1270.7	528943
10	3	97	18	1717	1581	27624
11	2	76.4	18	1683.6		188468
12	3	97.3	18	1588.7	1219.7	348918
13	3	98.5	18	1611.5	1263.5	509458
14	3	100	18	1471	1010	7870
15	2	72.1	18	1282.9		168818
16	1	56.6	18			330451
17	3	89.6	18	1459.4	1814.4	489199
18	1	59	18			653547

Unless otherwise stated the results shown in this test report refer only to the sample(s) tested and such sample(s) are retained for 90 days only.

除非另有說明，此報告結果僅對測試之樣品負責，同時此樣品僅保留90天。本報告未經本公司書面許可，不可部份複製。

This document is issued by the Company subject to its General Conditions of Service printed overleaf, available on request or accessible at <http://www.sgs.com.tw/Terms-and-Conditions> and for electronic format documents, subject to Terms and Conditions for Electronic Documents at <http://www.sgs.com.tw/Terms-and-Conditions>. Attention is drawn to the limitation of liability, indemnification and jurisdiction issues defined therein. Any holder of this document is advised that information contained hereon reflects the Company's findings at the time of its intervention only and within the limits of Client's instructions, if any. The Company's sole responsibility is to its Client and this document does not exonerate parties to a transaction from exercising all their rights and obligations under the transaction documents. This document cannot be reproduced except in full, without prior written approval of the Company. Any unauthorized alteration, forgery or falsification of the content or appearance of this document is unlawful and offenders may be prosecuted to the fullest extent of the law.

14.20.27 Trial 27

Data Sheet for FCC Radar Type 5						
Trial Number:		27		VSG Frequency(MHz):		5325.2315
Number of Bursts in Trial:			11		Successful Detection: Yes	
Burst (8-20)	Number Pulses per Burst (1-3)	Pulse Width (50-100)	Chirp Width (5-20)	Pulse 1-to-2 Spacing	Pulse 2-to-3 Spacing	Starting Location Within Interval
		(μ sec)	(MHz)	(μ sec)	(μ sec)	(μ sec)
1	3	96	9	964	1269	244138
2	2	67.1	9	1167.9		508034
3	1	54.3	9			772920
4	3	99.9	9	1046.1	1220.1	1035183
5	3	98	9	1600	940	211483
6	1	55.5	9			476199
7	2	82.1	9	1539.9		739691
8	1	59.1	9			1005073
9	3	97.1	9	1569.9	1053.9	179037
10	2	78.3	9	1685.7		442966
11	3	85	9	1745	1510	705622

Unless otherwise stated the results shown in this test report refer only to the sample(s) tested and such sample(s) are retained for 90 days only.

除非另有說明，此報告結果僅對測試之樣品負責，同時此樣品僅保留90天。本報告未經本公司書面許可，不可部份複製。

This document is issued by the Company subject to its General Conditions of Service printed overleaf, available on request or accessible at <http://www.sgs.com.tw/Terms-and-Conditions> and for electronic format documents, subject to Terms and Conditions for Electronic Documents at <http://www.sgs.com.tw/Terms-and-Conditions>. Attention is drawn to the limitation of liability, indemnification and jurisdiction issues defined therein. Any holder of this document is advised that information contained hereon reflects the Company's findings at the time of its intervention only and within the limits of Client's instructions, if any. The Company's sole responsibility is to its Client and this document does not exonerate parties to a transaction from exercising all their rights and obligations under the transaction documents. This document cannot be reproduced except in full, without prior written approval of the Company. Any unauthorized alteration, forgery or falsification of the content or appearance of this document is unlawful and offenders may be prosecuted to the fullest extent of the law.

14.20.28 Trial 28

Data Sheet for FCC Radar Type 5						
Trial Number:		28		VSG Frequency(MHz):		5322.0315
Number of Bursts in Trial:			18		Successful Detection: Yes	
Burst (8-20)	Number Pulses per Burst (1-3)	Pulse Width (50-100)	Chirp Width (5-20)	Pulse 1-to-2 Spacing	Pulse 2-to-3 Spacing	Starting Location Within Interval
		(μ sec)	(MHz)	(μ sec)	(μ sec)	(μ sec)
1	2	74	17	1226		592566
2	1	59.8	17			89732
3	2	79.3	17	1839.7		250502
4	2	76.7	17	1083.3		411804
5	2	70.6	17	1421.4		572049
6	1	61.8	17			69871
7	2	83.2	17	1608.8		230717
8	2	81.7	17	1839.3		391658
9	3	98.1	17	1843.9	1145.9	551342
10	2	83.3	17	1716.7		49863
11	1	60	17			211312
12	1	51	17			372850
13	2	68.2	17	1899.8		532734
14	2	67.8	17	1688.2		30024
15	3	96	17	1446	1613	190604
16	1	52.3	17			352547
17	1	53.4	17			513835
18	2	82.4	17	1680.6		10225

Unless otherwise stated the results shown in this test report refer only to the sample(s) tested and such sample(s) are retained for 90 days only.

除非另有說明，此報告結果僅對測試之樣品負責，同時此樣品僅保留90天。本報告未經本公司書面許可，不可部份複製。

This document is issued by the Company subject to its General Conditions of Service printed overleaf, available on request or accessible at <http://www.sgs.com.tw/Terms-and-Conditions> and for electronic format documents, subject to Terms and Conditions for Electronic Documents at <http://www.sgs.com.tw/Terms-and-Conditions>. Attention is drawn to the limitation of liability, indemnification and jurisdiction issues defined therein. Any holder of this document is advised that information contained hereon reflects the Company's findings at the time of its intervention only and within the limits of Client's instructions, if any. The Company's sole responsibility is to its Client and this document does not exonerate parties to a transaction from exercising all their rights and obligations under the transaction documents. This document cannot be reproduced except in full, without prior written approval of the Company. Any unauthorized alteration, forgery or falsification of the content or appearance of this document is unlawful and offenders may be prosecuted to the fullest extent of the law.

14.20.29 Trial 29

Data Sheet for FCC Radar Type 5						
Trial Number:		29		VSG Frequency(MHz):		5326.4315
Number of Bursts in Trial:			8		Successful Detection: Yes	
Burst (8-20)	Number Pulses per Burst (1-3)	Pulse Width (50-100)	Chirp Width (5-20)	Pulse 1-to-2 Spacing	Pulse 2-to-3 Spacing	Starting Location Within Interval
		(μ sec)	(MHz)	(μ sec)	(μ sec)	(μ sec)
1	2	67	6	1136		386176
2	2	67	6	975		749473
3	3	94.8	6	946.2	1399.2	1111261
4	2	78.1	6	1873.9		1475197
5	2	81.4	6	1855.6		341314
6	2	82.5	6	1477.5		704354
7	1	52.3	6			1068403
8	3	95.9	6	1723.1	1465.1	1429278

Unless otherwise stated the results shown in this test report refer only to the sample(s) tested and such sample(s) are retained for 90 days only.

除非另有說明，此報告結果僅對測試之樣品負責，同時此樣品僅保留90天。本報告未經本公司書面許可，不可部份複製。

This document is issued by the Company subject to its General Conditions of Service printed overleaf, available on request or accessible at <http://www.sgs.com.tw/Terms-and-Conditions> and for electronic format documents, subject to Terms and Conditions for Electronic Documents at <http://www.sgs.com.tw/Terms-and-Conditions>. Attention is drawn to the limitation of liability, indemnification and jurisdiction issues defined therein. Any holder of this document is advised that information contained hereon reflects the Company's findings at the time of its intervention only and within the limits of Client's instructions, if any. The Company's sole responsibility is to its Client and this document does not exonerate parties to a transaction from exercising all their rights and obligations under the transaction documents. This document cannot be reproduced except in full, without prior written approval of the Company. Any unauthorized alteration, forgery or falsification of the content or appearance of this document is unlawful and offenders may be prosecuted to the fullest extent of the law.

14.20.30 Trial 30

Data Sheet for FCC Radar Type 5						
Trial Number:		30		VSG Frequency(MHz):		5322.0315
Number of Bursts in Trial:			18		Successful Detection: Yes	
Burst (8-20)	Number Pulses per Burst (1-3)	Pulse Width (50-100)	Chirp Width (5-20)	Pulse 1-to-2 Spacing	Pulse 2-to-3 Spacing	Starting Location Within Interval
		(μ sec)	(MHz)	(μ sec)	(μ sec)	(μ sec)
1	3	99.1	17	1050.9	1191.9	131268
2	1	50.7	17			293150
3	2	75.5	17	1479.5		453485
4	2	82.2	17	1702.8		613895
5	2	67.3	17	1725.7		111637
6	1	59.4	17			273119
7	3	91.5	17	1718.5	1057.5	432670
8	2	80.2	17	1136.8		594976
9	2	74.2	17	975.8		91921
10	3	87.2	17	1141.8	1835.8	252079
11	3	97.2	17	1803.8	1028.8	413002
12	2	70.5	17	1487.5		574498
13	2	77.9	17	1638.1		71981
14	3	88.2	17	1134.8	1636.8	232616
15	3	88.9	17	1484.1	1059.1	393436
16	2	74.9	17	1917.1		554812
17	3	91.5	17	1591.5	1728.5	52089
18	2	75.8	17	1480.2		213172

Unless otherwise stated the results shown in this test report refer only to the sample(s) tested and such sample(s) are retained for 90 days only.

除非另有說明，此報告結果僅對測試之樣品負責，同時此樣品僅保留90天。本報告未經本公司書面許可，不可部份複製。

This document is issued by the Company subject to its General Conditions of Service printed overleaf, available on request or accessible at <http://www.sgs.com.tw/Terms-and-Conditions> and for electronic format documents, subject to Terms and Conditions for Electronic Documents at <http://www.sgs.com.tw/Terms-and-Conditions>. Attention is drawn to the limitation of liability, indemnification and jurisdiction issues defined therein. Any holder of this document is advised that information contained hereon reflects the Company's findings at the time of its intervention only and within the limits of Client's instructions, if any. The Company's sole responsibility is to its Client and this document does not exonerate parties to a transaction from exercising all their rights and obligations under the transaction documents. This document cannot be reproduced except in full, without prior written approval of the Company. Any unauthorized alteration, forgery or falsification of the content or appearance of this document is unlawful and offenders may be prosecuted to the fullest extent of the law.

14.21 Radar Type 6 for 5320 MHz:

Data Sheet for FCC Radar Type 6						
Trial	Pulse Width	PRI	Pulses per Hop	Hopping Rate	Hopping Sequence Length	Successful Detection
	(μ sec)	(μ sec)		(kHz)	(msec)	(Yes/No)
1	1	333	9	0.333	300	Yes
2	1	333	9	0.333	300	Yes
3	1	333	9	0.333	300	Yes
4	1	333	9	0.333	300	Yes
5	1	333	9	0.333	300	Yes
6	1	333	9	0.333	300	Yes
7	1	333	9	0.333	300	Yes
8	1	333	9	0.333	300	Yes
9	1	333	9	0.333	300	Yes
10	1	333	9	0.333	300	Yes
11	1	333	9	0.333	300	Yes
12	1	333	9	0.333	300	Yes
13	1	333	9	0.333	300	Yes
14	1	333	9	0.333	300	Yes
15	1	333	9	0.333	300	Yes
16	1	333	9	0.333	300	Yes
17	1	333	9	0.333	300	Yes
18	1	333	9	0.333	300	Yes
19	1	333	9	0.333	300	Yes
20	1	333	9	0.333	300	Yes
21	1	333	9	0.333	300	Yes
22	1	333	9	0.333	300	Yes
23	1	333	9	0.333	300	Yes
24	1	333	9	0.333	300	Yes
25	1	333	9	0.333	300	Yes
26	1	333	9	0.333	300	Yes
27	1	333	9	0.333	300	Yes
28	1	333	9	0.333	300	Yes
29	1	333	9	0.333	300	No
30	1	333	9	0.333	300	Yes

Unless otherwise stated the results shown in this test report refer only to the sample(s) tested and such sample(s) are retained for 90 days only.

除非另有說明，此報告結果僅對測試之樣品負責，同時此樣品僅保留90天。本報告未經本公司書面許可，不可部份複製。

This document is issued by the Company subject to its General Conditions of Service printed overleaf, available on request or accessible at <http://www.sgs.com.tw/Terms-and-Conditions> and for electronic format documents, subject to Terms and Conditions for Electronic Documents at <http://www.sgs.com.tw/Terms-and-Conditions>. Attention is drawn to the limitation of liability, indemnification and jurisdiction issues defined therein. Any holder of this document is advised that information contained hereon reflects the Company's findings at the time of its intervention only and within the limits of Client's instructions, if any. The Company's sole responsibility is to its Client and this document does not exonerate parties to a transaction from exercising all their rights and obligations under the transaction documents. This document cannot be reproduced except in full, without prior written approval of the Company. Any unauthorized alteration, forgery or falsification of the content or appearance of this document is unlawful and offenders may be prosecuted to the fullest extent of the law.

14.22 5500MHz:

Short Pulse Radar Type	Minimum Number of Trials	Detection(%)		Minimum Percentage of Successful Detection(%)	Pass/Fail
1	30	73.33		60	Pass
2	30	100		60	Pass
3	30	93.33		60	Pass
4	30	93.33		60	Pass
Aggregate (Radar Types 1-4)	120	89.9975		80	Pass
Long Pulse Radar Type	Minimum Number of Trials	Each Detection(%)	Total Detection(%)	Minimum Percentage of Successful Detection(%)	Pass/Fail
5	Center:10	90	86.66666667	80	Pass
	Low Edge:10	80			
	High Edge:10	90			
Frequency Hopping Radar Type	Minimum Number of Trials	Detection(%)		Minimum Percentage of Successful Detection(%)	Pass/Fail
6	30	96.66666667		70	Pass

Unless otherwise stated the results shown in this test report refer only to the sample(s) tested and such sample(s) are retained for 90 days only.

除非另有說明，此報告結果僅對測試之樣品負責，同時此樣品僅保留90天。本報告未經本公司書面許可，不可部份複製。

This document is issued by the Company subject to its General Conditions of Service printed overleaf, available on request or accessible at <http://www.sgs.com.tw/Terms-and-Conditions> and for electronic format documents, subject to Terms and Conditions for Electronic Documents at <http://www.sgs.com.tw/Terms-and-Conditions>. Attention is drawn to the limitation of liability, indemnification and jurisdiction issues defined therein. Any holder of this document is advised that information contained hereon reflects the Company's findings at the time of its intervention only and within the limits of Client's instructions, if any. The Company's sole responsibility is to its Client and this document does not exonerate parties to a transaction from exercising all their rights and obligations under the transaction documents. This document cannot be reproduced except in full, without prior written approval of the Company. Any unauthorized alteration, forgery or falsification of the content or appearance of this document is unlawful and offenders may be prosecuted to the fullest extent of the law.

14.23 Radar Type 1 for 5500 MHz:

Data Sheet for FCC Radar Type 1						
Trial	VSG Frequency (MHz)	Pulse Repetition Frequency	Pulse Repetition Frequency	PRI	Test A/B	Successful Detection
		Number (1 to 23)	(Pulses Per Second)	(msec)	A/B	(Yes/No)
1	5500	16	1222.5	818	A	Yes
2	5500	12	1355	738	A	Yes
3	5500	11	1392.8	718	A	Yes
4	5500	17	1193.3	838	A	Yes
5	5500	9	1474.9	678	A	Yes
6	5500	10	1432.7	698	A	Yes
7	5500	4	1730.1	578	A	Yes
8	5500	15	1253.1	798	A	Yes
9	5500	8	1519.8	658	A	Yes
10	5500	5	1672.2	598	A	Yes
11	5500	20	1113.6	898	A	Yes
12	5500	3	1792.1	558	A	Yes
13	5500	13	1319.3	758	A	Yes
14	5500	2	1858.7	538	A	Yes
15	5500	19	1139	878	A	Yes
16	5500	-	755.3	1324	B	No
17	5500	-	336.5	2972	B	No
18	5500	-	445	2247	B	Yes
19	5500	-	628.1	1592	B	No
20	5500	-	546.1	1831	B	No
21	5500	-	901.7	1109	B	Yes
22	5500	-	646	1548	B	Yes
23	5500	-	327.5	3053	B	Yes
24	5500	-	847.5	1180	B	Yes
25	5500	-	378.9	2639	B	No
26	5500	-	679.3	1472	B	No
27	5500	-	356.5	2805	B	No
28	5500	-	1100.1	909	B	Yes
29	5500	-	512.6	1951	B	No
30	5500	-	1179.2	848	B	Yes

Unless otherwise stated the results shown in this test report refer only to the sample(s) tested and such sample(s) are retained for 90 days only.

除非另有說明，此報告結果僅對測試之樣品負責，同時此樣品僅保留90天。本報告未經本公司書面許可，不可部份複製。

This document is issued by the Company subject to its General Conditions of Service printed overleaf, available on request or accessible at <http://www.sgs.com.tw/Terms-and-Conditions> and for electronic format documents, subject to Terms and Conditions for Electronic Documents at <http://www.sgs.com.tw/Terms-and-Conditions>. Attention is drawn to the limitation of liability, indemnification and jurisdiction issues defined therein. Any holder of this document is advised that information contained hereon reflects the Company's findings at the time of its intervention only and within the limits of Client's instructions, if any. The Company's sole responsibility is to its Client and this document does not exonerate parties to a transaction from exercising all their rights and obligations under the transaction documents. This document cannot be reproduced except in full, without prior written approval of the Company. Any unauthorized alteration, forgery or falsification of the content or appearance of this document is unlawful and offenders may be prosecuted to the fullest extent of the law.

14.24 Radar Type 2 for 5500 MHz:

Data Sheet for FCC Radar Type 2					
Trial	VSG Frequency (MHz)	Number Pulses per Burst (23-29)	Pulse Width (1-5)	PRI (150-230)	Successful Detection
			(μ s)	(μ s)	(Yes/No)
1	5500	25	2.2	191	Yes
2	5500	26	3.3	186	Yes
3	5500	29	4.8	227	Yes
4	5500	29	5	185	Yes
5	5500	25	2.1	222	Yes
6	5500	28	4.5	175	Yes
7	5500	28	4	190	Yes
8	5500	23	1.1	220	Yes
9	5500	28	4.1	213	Yes
10	5500	23	1.1	223	Yes
11	5500	25	2.5	157	Yes
12	5500	26	2.8	217	Yes
13	5500	24	1.7	216	Yes
14	5500	24	1.6	179	Yes
15	5500	26	2.8	155	Yes
16	5500	25	2.7	196	Yes
17	5500	24	1.6	152	Yes
18	5500	25	2.2	170	Yes
19	5500	24	1.6	188	Yes
20	5500	24	1.7	178	Yes
21	5500	26	2.7	192	Yes
22	5500	24	2.1	197	Yes
23	5500	25	2.3	180	Yes
24	5500	23	1.2	221	Yes
25	5500	26	2.9	207	Yes
26	5500	27	3.7	209	Yes
27	5500	29	4.8	229	Yes
28	5500	29	5	212	Yes
29	5500	29	4.9	176	Yes
30	5500	27	3.4	160	Yes

Unless otherwise stated the results shown in this test report refer only to the sample(s) tested and such sample(s) are retained for 90 days only.

除非另有說明，此報告結果僅對測試之樣品負責，同時此樣品僅保留90天。本報告未經本公司書面許可，不可部份複製。

This document is issued by the Company subject to its General Conditions of Service printed overleaf, available on request or accessible at <http://www.sgs.com.tw/Terms-and-Conditions> and for electronic format documents, subject to Terms and Conditions for Electronic Documents at <http://www.sgs.com.tw/Terms-and-Conditions>. Attention is drawn to the limitation of liability, indemnification and jurisdiction issues defined therein. Any holder of this document is advised that information contained hereon reflects the Company's findings at the time of its intervention only and within the limits of Client's instructions, if any. The Company's sole responsibility is to its Client and this document does not exonerate parties to a transaction from exercising all their rights and obligations under the transaction documents. This document cannot be reproduced except in full, without prior written approval of the Company. Any unauthorized alteration, forgery or falsification of the content or appearance of this document is unlawful and offenders may be prosecuted to the fullest extent of the law.

14.25 Radar Type 3 for 5500 MHz:

Data Sheet for FCC Radar Type 3					
Trial	VSG Frequency (MHz)	Number Pulses per Burst (16-18)	Pulse Width (6-10)	PRI (200-500)	Successful Detection
			(μ s)	(μ s)	(Yes/No)
1	5500	16	7.2	379	Yes
2	5500	17	8.3	353	Yes
3	5500	18	9.8	462	Yes
4	5500	18	10	428	Yes
5	5500	16	7.1	354	Yes
6	5500	18	9.5	222	Yes
7	5500	18	9	364	Yes
8	5500	16	6.1	217	Yes
9	5500	18	9.1	387	Yes
10	5500	16	6.1	433	Yes
11	5500	17	7.5	246	Yes
12	5500	17	7.8	231	Yes
13	5500	16	6.7	228	Yes
14	5500	16	6.6	375	No
15	5500	17	7.8	304	Yes
16	5500	17	7.7	215	Yes
17	5500	16	6.6	500	Yes
18	5500	16	7.2	401	No
19	5500	16	6.6	216	Yes
20	5500	16	6.7	251	Yes
21	5500	17	7.7	202	Yes
22	5500	16	7.1	461	Yes
23	5500	16	7.3	267	Yes
24	5500	16	6.2	227	Yes
25	5500	17	7.9	362	Yes
26	5500	18	8.7	358	Yes
27	5500	18	9.8	204	Yes
28	5500	18	10	219	Yes
29	5500	18	9.9	315	Yes
30	5500	17	8.4	351	Yes

Unless otherwise stated the results shown in this test report refer only to the sample(s) tested and such sample(s) are retained for 90 days only.

除非另有說明，此報告結果僅對測試之樣品負責，同時此樣品僅保留90天。本報告未經本公司書面許可，不可部份複製。

This document is issued by the Company subject to its General Conditions of Service printed overleaf, available on request or accessible at <http://www.sgs.com.tw/Terms-and-Conditions> and for electronic format documents, subject to Terms and Conditions for Electronic Documents at <http://www.sgs.com.tw/Terms-and-Conditions>. Attention is drawn to the limitation of liability, indemnification and jurisdiction issues defined therein. Any holder of this document is advised that information contained hereon reflects the Company's findings at the time of its intervention only and within the limits of Client's instructions, if any. The Company's sole responsibility is to its Client and this document does not exonerate parties to a transaction from exercising all their rights and obligations under the transaction documents. This document cannot be reproduced except in full, without prior written approval of the Company. Any unauthorized alteration, forgery or falsification of the content or appearance of this document is unlawful and offenders may be prosecuted to the fullest extent of the law.

14.26 Radar Type 4 for 5500 MHz:

Data Sheet for FCC Radar Type 4					
Trial	VSG Frequency (MHz)	Number Pulses per Burst (12-16)	Pulse Width (11-20)	PRI (200-500)	Successful Detection
			(μ s)	(μ s)	(Yes/No)
1	5500	13	13.8	379	No
2	5500	14	16.1	353	Yes
3	5500	16	19.6	462	Yes
4	5500	16	19.9	428	Yes
5	5500	13	13.6	354	Yes
6	5500	16	18.7	222	Yes
7	5500	15	17.7	364	Yes
8	5500	12	11.2	217	Yes
9	5500	15	17.9	387	Yes
10	5500	12	11.3	433	Yes
11	5500	13	14.4	246	Yes
12	5500	14	15	231	Yes
13	5500	12	12.7	228	Yes
14	5500	12	12.4	375	Yes
15	5500	14	15	304	Yes
16	5500	14	14.8	215	Yes
17	5500	12	12.3	500	Yes
18	5500	13	13.7	401	Yes
19	5500	12	12.4	216	Yes
20	5500	12	12.7	251	Yes
21	5500	14	14.9	202	Yes
22	5500	13	13.4	461	No
23	5500	13	14	267	Yes
24	5500	12	11.4	227	Yes
25	5500	14	15.3	362	Yes
26	5500	15	17.1	358	Yes
27	5500	16	19.5	204	Yes
28	5500	16	20	219	Yes
29	5500	16	19.7	315	Yes
30	5500	14	16.4	351	Yes

Unless otherwise stated the results shown in this test report refer only to the sample(s) tested and such sample(s) are retained for 90 days only.

除非另有說明，此報告結果僅對測試之樣品負責，同時此樣品僅保留90天。本報告未經本公司書面許可，不可部份複製。

This document is issued by the Company subject to its General Conditions of Service printed overleaf, available on request or accessible at <http://www.sgs.com.tw/Terms-and-Conditions> and for electronic format documents, subject to Terms and Conditions for Electronic Documents at <http://www.sgs.com.tw/Terms-and-Conditions>. Attention is drawn to the limitation of liability, indemnification and jurisdiction issues defined therein. Any holder of this document is advised that information contained hereon reflects the Company's findings at the time of its intervention only and within the limits of Client's instructions, if any. The Company's sole responsibility is to its Client and this document does not exonerate parties to a transaction from exercising all their rights and obligations under the transaction documents. This document cannot be reproduced except in full, without prior written approval of the Company. Any unauthorized alteration, forgery or falsification of the content or appearance of this document is unlawful and offenders may be prosecuted to the fullest extent of the law.

14.27 Radar Type 5 for 5500 MHz:
14.27.1 Trial 1:

Data Sheet for FCC Radar Type 5						
Trial Number:		1		VSG Frequency(MHz):		5500
Number of Bursts in Trial:			14		Successful Detection: No	
Burst (8-20)	Number Pulses per Burst (1-3)	Pulse Width (50-100)	Chirp Width (5-20)	Pulse 1-to-2 Spacing	Pulse 2-to-3 Spacing	Starting Location Within Interval
		(μ sec)	(MHz)	(μ sec)	(μ sec)	(μ sec)
1	2	75.7	13	1450.3		646095
2	2	76.2	13	1835.8		853391
3	3	98.6	13	1660.4	1151.4	206260
4	1	60	13			414310
5	3	88.3	13	1410.7	982.7	620248
6	1	52	13			829565
7	3	92.7	13	1451.3	1091.3	180697
8	3	84.5	13	1906.5	1481.5	387097
9	2	79.4	13	1230.6		595173
10	3	86.3	13	1491.7	1529.7	801190
11	1	52.5	13			155846
12	1	65.8	13			363169
13	1	51.8	13			570697
14	3	96.5	13	919.5	1148.5	776534

Unless otherwise stated the results shown in this test report refer only to the sample(s) tested and such sample(s) are retained for 90 days only.

除非另有說明，此報告結果僅對測試之樣品負責，同時此樣品僅保留90天。本報告未經本公司書面許可，不可部份複製。

This document is issued by the Company subject to its General Conditions of Service printed overleaf, available on request or accessible at <http://www.sgs.com.tw/Terms-and-Conditions> and for electronic format documents, subject to Terms and Conditions for Electronic Documents at <http://www.sgs.com.tw/Terms-and-Conditions>. Attention is drawn to the limitation of liability, indemnification and jurisdiction issues defined therein. Any holder of this document is advised that information contained hereon reflects the Company's findings at the time of its intervention only and within the limits of Client's instructions, if any. The Company's sole responsibility is to its Client and this document does not exonerate parties to a transaction from exercising all their rights and obligations under the transaction documents. This document cannot be reproduced except in full, without prior written approval of the Company. Any unauthorized alteration, forgery or falsification of the content or appearance of this document is unlawful and offenders may be prosecuted to the fullest extent of the law.

14.27.2 Trial 2:

Data Sheet for FCC Radar Type 5						
Trial Number:		2		VSG Frequency(MHz):		5500
Number of Bursts in Trial:			14		Successful Detection: Yes	
Burst (8-20)	Number Pulses per Burst (1-3)	Pulse Width (50-100)	Chirp Width (5-20)	Pulse 1-to-2 Spacing	Pulse 2-to-3 Spacing	Starting Location Within Interval
		(μ sec)	(MHz)	(μ sec)	(μ sec)	(μ sec)
1	3	89.7	13	1178.3	976.3	129878
2	3	96.5	13	1823.5	1552.5	336196
3	2	78.6	13	1730.4		544288
4	3	92.6	13	1348.4	1150.4	750076
5	3	92.6	13	1533.4	1761.4	104294
6	3	93	13	1878	1609	310994
7	2	70.3	13	1860.7		518416
8	1	66	13			727353
9	2	78.7	13	1898.3		78905
10	3	96.3	13	954.7	1546.7	285586
11	3	97.7	13	1410.3	1595.3	492469
12	3	92.3	13	1052.7	1690.7	699494
13	1	65.3	13			53555
14	3	88.9	13	1411.1	1716.1	260074

Unless otherwise stated the results shown in this test report refer only to the sample(s) tested and such sample(s) are retained for 90 days only.

除非另有說明，此報告結果僅對測試之樣品負責，同時此樣品僅保留90天。本報告未經本公司書面許可，不可部份複製。

This document is issued by the Company subject to its General Conditions of Service printed overleaf, available on request or accessible at <http://www.sgs.com.tw/Terms-and-Conditions> and for electronic format documents, subject to Terms and Conditions for Electronic Documents at <http://www.sgs.com.tw/Terms-and-Conditions>. Attention is drawn to the limitation of liability, indemnification and jurisdiction issues defined therein. Any holder of this document is advised that information contained hereon reflects the Company's findings at the time of its intervention only and within the limits of Client's instructions, if any. The Company's sole responsibility is to its Client and this document does not exonerate parties to a transaction from exercising all their rights and obligations under the transaction documents. This document cannot be reproduced except in full, without prior written approval of the Company. Any unauthorized alteration, forgery or falsification of the content or appearance of this document is unlawful and offenders may be prosecuted to the fullest extent of the law.

14.27.3 Trial 3

Data Sheet for FCC Radar Type 5						
Trial Number:		3		VSG Frequency(MHz):		5500
Number of Bursts in Trial:			20		Successful Detection: Yes	
Burst (8-20)	Number Pulses per Burst (1-3)	Pulse Width (50-100)	Chirp Width (5-20)	Pulse 1-to-2 Spacing	Pulse 2-to-3 Spacing	Starting Location Within Interval
		(μ sec)	(MHz)	(μ sec)	(μ sec)	(μ sec)
1	1	53.1	20			327984
2	3	90	20	1789	1447	470347
3	2	82.3	20	1038.7		19538
4	2	76.2	20	1301.8		164251
5	2	80.3	20	1314.7		309125
6	3	91.2	20	1887.8	1592.8	452206
7	2	82.6	20	1648.4		1697
8	1	56.7	20			146959
9	2	69.4	20	1711.6		291322
10	2	71	20	1475		436052
11	3	97.9	20	1413.1	1179.1	579415
12	3	93.2	20	1553.8	1022.8	128485
13	2	72.1	20	1223.9		273557
14	3	94.6	20	1584.4	990.4	417454
15	3	90.4	20	1291.6	1396.6	561415
16	3	85.2	20	1173.8	1748.8	110459
17	3	95.3	20	1538.7	1756.7	254888
18	2	71.2	20	1839.8		400255
19	1	64.1	20			546815
20	2	74.5	20	1751.5		92943

Unless otherwise stated the results shown in this test report refer only to the sample(s) tested and such sample(s) are retained for 90 days only.

除非另有說明，此報告結果僅對測試之樣品負責，同時此樣品僅保留90天。本報告未經本公司書面許可，不可部份複製。

This document is issued by the Company subject to its General Conditions of Service printed overleaf, available on request or accessible at <http://www.sgs.com.tw/Terms-and-Conditions> and for electronic format documents, subject to Terms and Conditions for Electronic Documents at <http://www.sgs.com.tw/Terms-and-Conditions>. Attention is drawn to the limitation of liability, indemnification and jurisdiction issues defined therein. Any holder of this document is advised that information contained hereon reflects the Company's findings at the time of its intervention only and within the limits of Client's instructions, if any. The Company's sole responsibility is to its Client and this document does not exonerate parties to a transaction from exercising all their rights and obligations under the transaction documents. This document cannot be reproduced except in full, without prior written approval of the Company. Any unauthorized alteration, forgery or falsification of the content or appearance of this document is unlawful and offenders may be prosecuted to the fullest extent of the law.

14.27.4 Trial 4

Data Sheet for FCC Radar Type 5						
Trial Number:		4		VSG Frequency(MHz):		5500
Number of Bursts in Trial:			10		Successful Detection: Yes	
Burst (8-20)	Number Pulses per Burst (1-3)	Pulse Width (50-100)	Chirp Width (5-20)	Pulse 1-to-2 Spacing	Pulse 2-to-3 Spacing	Starting Location Within Interval
		(μ sec)	(MHz)	(μ sec)	(μ sec)	(μ sec)
1	2	71.3	8	1835.7		476618
2	1	57.3	8			768080
3	3	95.2	8	917.8	1522.8	1056357
4	2	82.8	8	1172.2		150695
5	2	79.5	8	1775.5		441008
6	2	68.9	8	1636.1		731474
7	1	53.6	8			1022491
8	1	59.6	8			115101
9	3	97.5	8	1330.5	1620.5	404670
10	1	52.3	8			696336

Unless otherwise stated the results shown in this test report refer only to the sample(s) tested and such sample(s) are retained for 90 days only.

除非另有說明，此報告結果僅對測試之樣品負責，同時此樣品僅保留90天。本報告未經本公司書面許可，不可部份複製。

This document is issued by the Company subject to its General Conditions of Service printed overleaf, available on request or accessible at <http://www.sgs.com.tw/Terms-and-Conditions> and for electronic format documents, subject to Terms and Conditions for Electronic Documents at <http://www.sgs.com.tw/Terms-and-Conditions>. Attention is drawn to the limitation of liability, indemnification and jurisdiction issues defined therein. Any holder of this document is advised that information contained hereon reflects the Company's findings at the time of its intervention only and within the limits of Client's instructions, if any. The Company's sole responsibility is to its Client and this document does not exonerate parties to a transaction from exercising all their rights and obligations under the transaction documents. This document cannot be reproduced except in full, without prior written approval of the Company. Any unauthorized alteration, forgery or falsification of the content or appearance of this document is unlawful and offenders may be prosecuted to the fullest extent of the law.

14.27.5 Trial 5

Data Sheet for FCC Radar Type 5						
Trial Number:		5		VSG Frequency(MHz):		5500
Number of Bursts in Trial:			17		Successful Detection: Yes	
Burst (8-20)	Number Pulses per Burst (1-3)	Pulse Width (50-100)	Chirp Width (5-20)	Pulse 1-to-2 Spacing	Pulse 2-to-3 Spacing	Starting Location Within Interval
		(μ sec)	(MHz)	(μ sec)	(μ sec)	(μ sec)
1	1	62.3	17			580292
2	3	96	17	1892	1376	46376
3	3	86.7	17	1845.3	1609.3	216364
4	1	53.7	17			388124
5	2	81.3	17	1741.7		557500
6	3	89.5	17	1284.5	1043.5	25448
7	1	53.9	17			196365
8	2	76.3	17	1248.7		366324
9	3	85.6	17	1399.4	1573.4	535403
10	1	60.6	17			4498
11	1	63.8	17			175244
12	2	82.9	17	1841.1		345455
13	2	77	17	950		516472
14	1	57.6	17			687535
15	3	94.7	17	1506.3	1682.3	153508
16	3	99.4	17	1072.6	1097.6	324212
17	2	70.8	17	1827.2		494914

Unless otherwise stated the results shown in this test report refer only to the sample(s) tested and such sample(s) are retained for 90 days only.

除非另有說明，此報告結果僅對測試之樣品負責，同時此樣品僅保留90天。本報告未經本公司書面許可，不可部份複製。

This document is issued by the Company subject to its General Conditions of Service printed overleaf, available on request or accessible at <http://www.sgs.com.tw/Terms-and-Conditions> and for electronic format documents, subject to Terms and Conditions for Electronic Documents at <http://www.sgs.com.tw/Terms-and-Conditions>. Attention is drawn to the limitation of liability, indemnification and jurisdiction issues defined therein. Any holder of this document is advised that information contained hereon reflects the Company's findings at the time of its intervention only and within the limits of Client's instructions, if any. The Company's sole responsibility is to its Client and this document does not exonerate parties to a transaction from exercising all their rights and obligations under the transaction documents. This document cannot be reproduced except in full, without prior written approval of the Company. Any unauthorized alteration, forgery or falsification of the content or appearance of this document is unlawful and offenders may be prosecuted to the fullest extent of the law.

14.27.6 Trial 6

Data Sheet for FCC Radar Type 5						
Trial Number:		6		VSG Frequency(MHz):		5500
Number of Bursts in Trial:			8		Successful Detection: Yes	
Burst (8-20)	Number Pulses per Burst (1-3)	Pulse Width (50-100)	Chirp Width (5-20)	Pulse 1-to-2 Spacing	Pulse 2-to-3 Spacing	Starting Location Within Interval
		(μ sec)	(MHz)	(μ sec)	(μ sec)	(μ sec)
1	2	75.7	5	1039.3		1417883
2	2	75.7	5	1675.3		283058
3	3	93.5	5	1267.5	1790.5	645459
4	1	50.9	5			1010268
5	2	76.5	5	1874.5		1371553
6	2	78.2	5	1352.8		238446
7	3	90.9	5	1594.1	1659.1	600817
8	2	67.6	5	1311.4		964778

Unless otherwise stated the results shown in this test report refer only to the sample(s) tested and such sample(s) are retained for 90 days only.

除非另有說明，此報告結果僅對測試之樣品負責，同時此樣品僅保留90天。本報告未經本公司書面許可，不可部份複製。

This document is issued by the Company subject to its General Conditions of Service printed overleaf, available on request or accessible at <http://www.sgs.com.tw/Terms-and-Conditions> and for electronic format documents, subject to Terms and Conditions for Electronic Documents at <http://www.sgs.com.tw/Terms-and-Conditions>. Attention is drawn to the limitation of liability, indemnification and jurisdiction issues defined therein. Any holder of this document is advised that information contained hereon reflects the Company's findings at the time of its intervention only and within the limits of Client's instructions, if any. The Company's sole responsibility is to its Client and this document does not exonerate parties to a transaction from exercising all their rights and obligations under the transaction documents. This document cannot be reproduced except in full, without prior written approval of the Company. Any unauthorized alteration, forgery or falsification of the content or appearance of this document is unlawful and offenders may be prosecuted to the fullest extent of the law.

14.27.7 Trial 7

Data Sheet for FCC Radar Type 5						
Trial Number:		7		VSG Frequency(MHz):		5500
Number of Bursts in Trial:			19		Successful Detection: Yes	
Burst (8-20)	Number Pulses per Burst (1-3)	Pulse Width (50-100)	Chirp Width (5-20)	Pulse 1-to-2 Spacing	Pulse 2-to-3 Spacing	Starting Location Within Interval
		(μ sec)	(MHz)	(μ sec)	(μ sec)	(μ sec)
1	3	95.8	18	1832.2	1410.2	555394
2	3	94.9	18	1322.1	1204.1	81223
3	3	99.5	18	1355.5	1089.5	233328
4	3	96.8	18	1535.2	1145.2	385633
5	1	61.3	18			540366
6	3	87.5	18	1422.5	1401.5	62393
7	2	72.9	18	1379.1		215032
8	1	59.2	18			368445
9	2	67.1	18	1004.9		520066
10	1	58.6	18			43887
11	1	51.8	18			196798
12	1	56.4	18			349750
13	2	68.4	18	1078.6		501484
14	1	63.2	18			25077
15	1	50.8	18			177809
16	2	81.2	18	1690.8		329509
17	2	68.9	18	1214.1		482804
18	3	85.6	18	1638.4	1504.4	6218
19	1	53.4	18			159040

Unless otherwise stated the results shown in this test report refer only to the sample(s) tested and such sample(s) are retained for 90 days only.

除非另有說明，此報告結果僅對測試之樣品負責，同時此樣品僅保留90天。本報告未經本公司書面許可，不可部份複製。

This document is issued by the Company subject to its General Conditions of Service printed overleaf, available on request or accessible at <http://www.sgs.com.tw/Terms-and-Conditions> and for electronic format documents, subject to Terms and Conditions for Electronic Documents at <http://www.sgs.com.tw/Terms-and-Conditions>. Attention is drawn to the limitation of liability, indemnification and jurisdiction issues defined therein. Any holder of this document is advised that information contained hereon reflects the Company's findings at the time of its intervention only and within the limits of Client's instructions, if any. The Company's sole responsibility is to its Client and this document does not exonerate parties to a transaction from exercising all their rights and obligations under the transaction documents. This document cannot be reproduced except in full, without prior written approval of the Company. Any unauthorized alteration, forgery or falsification of the content or appearance of this document is unlawful and offenders may be prosecuted to the fullest extent of the law.

14.27.8 Trial 8

Data Sheet for FCC Radar Type 5						
Trial Number:		8		VSG Frequency(MHz):		5500
Number of Bursts in Trial:			16		Successful Detection: Yes	
Burst (8-20)	Number Pulses per Burst (1-3)	Pulse Width (50-100)	Chirp Width (5-20)	Pulse 1-to-2 Spacing	Pulse 2-to-3 Spacing	Starting Location Within Interval
		(μ sec)	(MHz)	(μ sec)	(μ sec)	(μ sec)
1	1	60.6	16			370709
2	3	88.4	16	1673.6	1542.6	549691
3	2	80.4	16	1180.6		732531
4	3	87.6	16	1044.4	1739.4	165939
5	3	88.2	16	1018.8	1348.8	346815
6	2	80.1	16	1083.9		529051
7	3	98.1	16	1002.9	932.9	709596
8	2	78	16	1770		143881
9	3	84	16	1829	955	324420
10	1	53.9	16			507438
11	1	51.3	16			689099
12	3	85.9	16	1091.1	973.1	121440
13	2	67.8	16	1372.2		302742
14	3	95.8	16	1367.2	1777.2	483049
15	3	86.1	16	1808.9	1553.9	663080
16	3	85.6	16	1203.4	1201.4	99115

Unless otherwise stated the results shown in this test report refer only to the sample(s) tested and such sample(s) are retained for 90 days only.

除非另有說明，此報告結果僅對測試之樣品負責，同時此樣品僅保留90天。本報告未經本公司書面許可，不可部份複製。

This document is issued by the Company subject to its General Conditions of Service printed overleaf, available on request or accessible at <http://www.sgs.com.tw/Terms-and-Conditions> and for electronic format documents, subject to Terms and Conditions for Electronic Documents at <http://www.sgs.com.tw/Terms-and-Conditions>. Attention is drawn to the limitation of liability, indemnification and jurisdiction issues defined therein. Any holder of this document is advised that information contained hereon reflects the Company's findings at the time of its intervention only and within the limits of Client's instructions, if any. The Company's sole responsibility is to its Client and this document does not exonerate parties to a transaction from exercising all their rights and obligations under the transaction documents. This document cannot be reproduced except in full, without prior written approval of the Company. Any unauthorized alteration, forgery or falsification of the content or appearance of this document is unlawful and offenders may be prosecuted to the fullest extent of the law.

14.27.9 Trial 9

Data Sheet for FCC Radar Type 5						
Trial Number:		9		VSG Frequency(MHz):		5500
Number of Bursts in Trial:			15		Successful Detection: Yes	
Burst (8-20)	Number Pulses per Burst (1-3)	Pulse Width (50-100)	Chirp Width (5-20)	Pulse 1-to-2 Spacing	Pulse 2-to-3 Spacing	Starting Location Within Interval
		(μ sec)	(MHz)	(μ sec)	(μ sec)	(μ sec)
1	3	94.7	14	1479.3	1263.3	298833
2	1	54.5	14			493176
3	2	79.6	14	1873.4		685083
4	2	74.2	14	1843.8		82062
5	2	73.2	14	1416.8		275417
6	3	90.9	14	1149.1	1074.1	467980
7	2	73.7	14	1483.3		662375
8	1	59.9	14			58438
9	3	99	14	1378	1647	251182
10	3	92.8	14	1777.2	1876.2	443379
11	3	93	14	1382	1233	637342
12	1	52.4	14			34582
13	1	62.4	14			228187
14	2	74.8	14	1905.2		420798
15	1	62.3	14			615553

Unless otherwise stated the results shown in this test report refer only to the sample(s) tested and such sample(s) are retained for 90 days only.

除非另有說明，此報告結果僅對測試之樣品負責，同時此樣品僅保留90天。本報告未經本公司書面許可，不可部份複製。

This document is issued by the Company subject to its General Conditions of Service printed overleaf, available on request or accessible at <http://www.sgs.com.tw/Terms-and-Conditions> and for electronic format documents, subject to Terms and Conditions for Electronic Documents at <http://www.sgs.com.tw/Terms-and-Conditions>. Attention is drawn to the limitation of liability, indemnification and jurisdiction issues defined therein. Any holder of this document is advised that information contained hereon reflects the Company's findings at the time of its intervention only and within the limits of Client's instructions, if any. The Company's sole responsibility is to its Client and this document does not exonerate parties to a transaction from exercising all their rights and obligations under the transaction documents. This document cannot be reproduced except in full, without prior written approval of the Company. Any unauthorized alteration, forgery or falsification of the content or appearance of this document is unlawful and offenders may be prosecuted to the fullest extent of the law.

14.27.10 Trial 10

Data Sheet for FCC Radar Type 5						
Trial Number:		10		VSG Frequency(MHz):		5500
Number of Bursts in Trial:			17		Successful Detection: Yes	
Burst (8-20)	Number Pulses per Burst (1-3)	Pulse Width (50-100)	Chirp Width (5-20)	Pulse 1-to-2 Spacing	Pulse 2-to-3 Spacing	Starting Location Within Interval
		(μ sec)	(MHz)	(μ sec)	(μ sec)	(μ sec)
1	2	82	16	1608		9460
2	3	90.9	16	1895.1	1899.1	179231
3	2	74.7	16	971.3		350504
4	2	80.3	16	1727.7		520285
5	2	79.3	16	1343.7		691395
6	1	65.4	16			159274
7	1	57.2	16			330226
8	1	61.3	16			500882
9	2	66.7	16	1384.3		670070
10	1	63.3	16			138302
11	1	59.5	16			308892
12	3	89	16	956	1389	478108
13	1	55.2	16			651105
14	1	65.7	16			117181
15	2	72.8	16	1140.2		287537
16	3	84.1	16	1657.9	1577.9	456409
17	1	60.6	16			630080

Unless otherwise stated the results shown in this test report refer only to the sample(s) tested and such sample(s) are retained for 90 days only.

除非另有說明，此報告結果僅對測試之樣品負責，同時此樣品僅保留90天。本報告未經本公司書面許可，不可部份複製。

This document is issued by the Company subject to its General Conditions of Service printed overleaf, available on request or accessible at <http://www.sgs.com.tw/Terms-and-Conditions> and for electronic format documents, subject to Terms and Conditions for Electronic Documents at <http://www.sgs.com.tw/Terms-and-Conditions>. Attention is drawn to the limitation of liability, indemnification and jurisdiction issues defined therein. Any holder of this document is advised that information contained hereon reflects the Company's findings at the time of its intervention only and within the limits of Client's instructions, if any. The Company's sole responsibility is to its Client and this document does not exonerate parties to a transaction from exercising all their rights and obligations under the transaction documents. This document cannot be reproduced except in full, without prior written approval of the Company. Any unauthorized alteration, forgery or falsification of the content or appearance of this document is unlawful and offenders may be prosecuted to the fullest extent of the law.

14.27.11 Trial 11

Data Sheet for FCC Radar Type 5						
Trial Number:		11		VSG Frequency(MHz):		5493.1445
Number of Bursts in Trial:			8		Successful Detection: No	
Burst (8-20)	Number Pulses per Burst (1-3)	Pulse Width (50-100)	Chirp Width (5-20)	Pulse 1-to-2 Spacing	Pulse 2-to-3 Spacing	Starting Location Within Interval
		(μ sec)	(MHz)	(μ sec)	(μ sec)	(μ sec)
1	2	82.3	5	1891.7		204286
2	2	77.7	5	1726.3		567132
3	1	56.2	5			931599
4	2	76.6	5	1705.4		1293038
5	3	89.4	5	1564.6	1775.6	159393
6	1	61.4	5			523221
7	2	80.3	5	1636.7		885768
8	2	69.7	5	1494.3		1249162

Unless otherwise stated the results shown in this test report refer only to the sample(s) tested and such sample(s) are retained for 90 days only.

除非另有說明，此報告結果僅對測試之樣品負責，同時此樣品僅保留90天。本報告未經本公司書面許可，不可部份複製。

This document is issued by the Company subject to its General Conditions of Service printed overleaf, available on request or accessible at <http://www.sgs.com.tw/Terms-and-Conditions> and for electronic format documents, subject to Terms and Conditions for Electronic Documents at <http://www.sgs.com.tw/Terms-and-Conditions>. Attention is drawn to the limitation of liability, indemnification and jurisdiction issues defined therein. Any holder of this document is advised that information contained hereon reflects the Company's findings at the time of its intervention only and within the limits of Client's instructions, if any. The Company's sole responsibility is to its Client and this document does not exonerate parties to a transaction from exercising all their rights and obligations under the transaction documents. This document cannot be reproduced except in full, without prior written approval of the Company. Any unauthorized alteration, forgery or falsification of the content or appearance of this document is unlawful and offenders may be prosecuted to the fullest extent of the law.

14.27.12 Trial 12

Data Sheet for FCC Radar Type 5						
Trial Number:		12		VSG Frequency(MHz):		5495.1445
Number of Bursts in Trial:			12		Successful Detection: Yes	
Burst (8-20)	Number Pulses per Burst (1-3)	Pulse Width (50-100)	Chirp Width (5-20)	Pulse 1-to-2 Spacing	Pulse 2-to-3 Spacing	Starting Location Within Interval
		(μ sec)	(MHz)	(μ sec)	(μ sec)	(μ sec)
1	1	64.7	10			76661
2	2	70.5	10	1788.5		318052
3	3	88.7	10	1145.3	1370.3	559355
4	3	95.4	10	1585.6	977.6	800973
5	3	87.2	10	1730.8	931.8	46677
6	3	95.7	10	1486.3	1643.3	287993
7	1	65.5	10			531115
8	1	59.1	10			773599
9	3	91.7	10	1495.3	944.3	16922
10	2	69.4	10	1818.6		258740
11	3	95.1	10	1223.9	1397.9	499728
12	3	93.2	10	1751.8	1222.8	740884

Unless otherwise stated the results shown in this test report refer only to the sample(s) tested and such sample(s) are retained for 90 days only.

除非另有說明，此報告結果僅對測試之樣品負責，同時此樣品僅保留90天。本報告未經本公司書面許可，不可部份複製。

This document is issued by the Company subject to its General Conditions of Service printed overleaf, available on request or accessible at <http://www.sgs.com.tw/Terms-and-Conditions> and for electronic format documents, subject to Terms and Conditions for Electronic Documents at <http://www.sgs.com.tw/Terms-and-Conditions>. Attention is drawn to the limitation of liability, indemnification and jurisdiction issues defined therein. Any holder of this document is advised that information contained hereon reflects the Company's findings at the time of its intervention only and within the limits of Client's instructions, if any. The Company's sole responsibility is to its Client and this document does not exonerate parties to a transaction from exercising all their rights and obligations under the transaction documents. This document cannot be reproduced except in full, without prior written approval of the Company. Any unauthorized alteration, forgery or falsification of the content or appearance of this document is unlawful and offenders may be prosecuted to the fullest extent of the law.

14.27.13 Trial 13

Data Sheet for FCC Radar Type 5						
Trial Number:		13		VSG Frequency(MHz):		5493.1445
Number of Bursts in Trial:			8		Successful Detection: Yes	
Burst (8-20)	Number Pulses per Burst (1-3)	Pulse Width (50-100)	Chirp Width (5-20)	Pulse 1-to-2 Spacing	Pulse 2-to-3 Spacing	Starting Location Within Interval
		(μ sec)	(MHz)	(μ sec)	(μ sec)	(μ sec)
1	1	65.5	5			1479371
2	1	56.8	5			344182
3	2	70.1	5	1105.9		706970
4	3	87.4	5	1570.6	1874.6	1068743
5	3	93.3	5	1060.7	1618.7	1432093
6	1	62.8	5			299316
7	1	60.9	5			662666
8	1	63.7	5			1026325

Unless otherwise stated the results shown in this test report refer only to the sample(s) tested and such sample(s) are retained for 90 days only.

除非另有說明，此報告結果僅對測試之樣品負責，同時此樣品僅保留90天。本報告未經本公司書面許可，不可部份複製。

This document is issued by the Company subject to its General Conditions of Service printed overleaf, available on request or accessible at <http://www.sgs.com.tw/Terms-and-Conditions> and for electronic format documents, subject to Terms and Conditions for Electronic Documents at <http://www.sgs.com.tw/Terms-and-Conditions>. Attention is drawn to the limitation of liability, indemnification and jurisdiction issues defined therein. Any holder of this document is advised that information contained hereon reflects the Company's findings at the time of its intervention only and within the limits of Client's instructions, if any. The Company's sole responsibility is to its Client and this document does not exonerate parties to a transaction from exercising all their rights and obligations under the transaction documents. This document cannot be reproduced except in full, without prior written approval of the Company. Any unauthorized alteration, forgery or falsification of the content or appearance of this document is unlawful and offenders may be prosecuted to the fullest extent of the law.

14.27.14 Trial 14

Data Sheet for FCC Radar Type 5						
Trial Number:		14		VSG Frequency(MHz):		5498.7445
Number of Bursts in Trial:			20		Successful Detection: Yes	
Burst (8-20)	Number Pulses per Burst (1-3)	Pulse Width (50-100)	Chirp Width (5-20)	Pulse 1-to-2 Spacing	Pulse 2-to-3 Spacing	Starting Location Within Interval
		(μ sec)	(MHz)	(μ sec)	(μ sec)	(μ sec)
1	1	51.9	19			555310
2	2	68.4	19	1297.6		101410
3	3	94.2	19	937.8	1678.8	245502
4	2	76.1	19	1023.9		391491
5	1	58.7	19			537470
6	2	82.3	19	1078.7		83620
7	2	70.1	19	1302.9		228490
8	3	84.7	19	1375.3	1583.3	372232
9	2	68.6	19	1426.4		517894
10	3	85.7	19	963.3	1248.3	65637
11	3	92.7	19	1210.3	1139.3	210105
12	2	79.5	19	1500.5		355398
13	3	94.5	19	1452.5	1043.5	498911
14	1	60.5	19			48049
15	1	64.6	19			193165
16	3	95	19	1062	1748	336831
17	2	68.6	19	1053.4		482936
18	1	65.9	19			30180
19	2	79.6	19	945.4		175084
20	2	67.6	19	933.4		320145

Unless otherwise stated the results shown in this test report refer only to the sample(s) tested and such sample(s) are retained for 90 days only.

除非另有說明，此報告結果僅對測試之樣品負責，同時此樣品僅保留90天。本報告未經本公司書面許可，不可部份複製。

This document is issued by the Company subject to its General Conditions of Service printed overleaf, available on request or accessible at <http://www.sgs.com.tw/Terms-and-Conditions> and for electronic format documents, subject to Terms and Conditions for Electronic Documents at <http://www.sgs.com.tw/Terms-and-Conditions>. Attention is drawn to the limitation of liability, indemnification and jurisdiction issues defined therein. Any holder of this document is advised that information contained hereon reflects the Company's findings at the time of its intervention only and within the limits of Client's instructions, if any. The Company's sole responsibility is to its Client and this document does not exonerate parties to a transaction from exercising all their rights and obligations under the transaction documents. This document cannot be reproduced except in full, without prior written approval of the Company. Any unauthorized alteration, forgery or falsification of the content or appearance of this document is unlawful and offenders may be prosecuted to the fullest extent of the law.

14.27.15 Trial 15

Data Sheet for FCC Radar Type 5						
Trial Number:		15		VSG Frequency(MHz):		5497.9445
Number of Bursts in Trial:			18		Successful Detection: Yes	
Burst (8-20)	Number Pulses per Burst (1-3)	Pulse Width (50-100)	Chirp Width (5-20)	Pulse 1-to-2 Spacing	Pulse 2-to-3 Spacing	Starting Location Within Interval
		(μ sec)	(MHz)	(μ sec)	(μ sec)	(μ sec)
1	3	94	17	1439	1888	514754
2	2	79.9	17	1615.1		13624
3	1	63.6	17			175105
4	3	96.4	17	1606.6	1207.6	334596
5	2	77.7	17	1836.3		496335
6	3	91	17	1245	1130	656012
7	3	95.2	17	1843.8	1354.8	154230
8	2	75.5	17	1645.5		315659
9	1	57.6	17			477960
10	2	68.8	17	948.2		638361
11	3	83.4	17	1039.6	1116.6	134744
12	2	76.6	17	1028.4		296218
13	1	50.4	17			458029
14	1	66.5	17			618940
15	2	67.8	17	1250.2		115207
16	3	96.3	17	1337.7	984.7	275765
17	2	76.3	17	1450.7		436688
18	1	62.5	17			598976

Unless otherwise stated the results shown in this test report refer only to the sample(s) tested and such sample(s) are retained for 90 days only.

除非另有說明，此報告結果僅對測試之樣品負責，同時此樣品僅保留90天。本報告未經本公司書面許可，不可部份複製。

This document is issued by the Company subject to its General Conditions of Service printed overleaf, available on request or accessible at <http://www.sgs.com.tw/Terms-and-Conditions> and for electronic format documents, subject to Terms and Conditions for Electronic Documents at <http://www.sgs.com.tw/Terms-and-Conditions>. Attention is drawn to the limitation of liability, indemnification and jurisdiction issues defined therein. Any holder of this document is advised that information contained hereon reflects the Company's findings at the time of its intervention only and within the limits of Client's instructions, if any. The Company's sole responsibility is to its Client and this document does not exonerate parties to a transaction from exercising all their rights and obligations under the transaction documents. This document cannot be reproduced except in full, without prior written approval of the Company. Any unauthorized alteration, forgery or falsification of the content or appearance of this document is unlawful and offenders may be prosecuted to the fullest extent of the law.

14.27.16 Trial 16

Data Sheet for FCC Radar Type 5						
Trial Number:		16		VSG Frequency(MHz):		5498.7445
Number of Bursts in Trial:			20		Successful Detection: Yes	
Burst (8-20)	Number Pulses per Burst (1-3)	Pulse Width (50-100)	Chirp Width (5-20)	Pulse 1-to-2 Spacing	Pulse 2-to-3 Spacing	Starting Location Within Interval
		(μ sec)	(MHz)	(μ sec)	(μ sec)	(μ sec)
1	3	86.6	19	1849.4	1340.4	85405
2	1	54.8	19			231183
3	2	75.5	19	1790.5		375035
4	2	80.8	19	1449.2		520228
5	3	90.5	19	931.5	1160.5	67791
6	1	56	19			213098
7	2	76.7	19	1877.3		357248
8	1	65.6	19			503347
9	3	98.7	19	1273.3	1295.3	49898
10	1	55	19			195306
11	3	92.3	19	1251.7	1171.7	339090
12	2	75.1	19	979.9		484759
13	2	68.8	19	1501.2		32183
14	2	77.3	19	1798.7		176994
15	2	83.2	19	1421.8		321885
16	3	93.3	19	1451.7	1520.7	465477
17	2	69.7	19	932.3		14378
18	2	72.1	19	1385.9		159073
19	1	54.8	19			304639
20	3	97.9	19	1634.1	939.1	447875

Unless otherwise stated the results shown in this test report refer only to the sample(s) tested and such sample(s) are retained for 90 days only.

除非另有說明，此報告結果僅對測試之樣品負責，同時此樣品僅保留90天。本報告未經本公司書面許可，不可部份複製。

This document is issued by the Company subject to its General Conditions of Service printed overleaf, available on request or accessible at <http://www.sgs.com.tw/Terms-and-Conditions> and for electronic format documents, subject to Terms and Conditions for Electronic Documents at <http://www.sgs.com.tw/Terms-and-Conditions>. Attention is drawn to the limitation of liability, indemnification and jurisdiction issues defined therein. Any holder of this document is advised that information contained hereon reflects the Company's findings at the time of its intervention only and within the limits of Client's instructions, if any. The Company's sole responsibility is to its Client and this document does not exonerate parties to a transaction from exercising all their rights and obligations under the transaction documents. This document cannot be reproduced except in full, without prior written approval of the Company. Any unauthorized alteration, forgery or falsification of the content or appearance of this document is unlawful and offenders may be prosecuted to the fullest extent of the law.

14.27.17 Trial 17

Data Sheet for FCC Radar Type 5						
Trial Number:		17		VSG Frequency(MHz):		5496.7445
Number of Bursts in Trial:			15		Successful Detection: Yes	
Burst (8-20)	Number Pulses per Burst (1-3)	Pulse Width (50-100)	Chirp Width (5-20)	Pulse 1-to-2 Spacing	Pulse 2-to-3 Spacing	Starting Location Within Interval
		(μ sec)	(MHz)	(μ sec)	(μ sec)	(μ sec)
1	3	98.5	14	1529.5	1540.5	790275
2	2	67.8	14	967.2		188767
3	3	87.2	14	1393.8	1408.8	381473
4	3	94.7	14	1083.3	1702.3	574184
5	2	77.1	14	1188.9		768439
6	3	99.9	14	1371.1	1009.1	164630
7	1	52.2	14			358931
8	1	66	14			552374
9	2	79	14	1802		743959
10	2	77.9	14	1074.1		141116
11	3	92.8	14	1900.2	1228.2	333425
12	2	68.3	14	1261.7		527752
13	2	68.6	14	1277.4		720969
14	1	56.1	14			117503
15	2	79.4	14	997.6		310715

Unless otherwise stated the results shown in this test report refer only to the sample(s) tested and such sample(s) are retained for 90 days only.

除非另有說明，此報告結果僅對測試之樣品負責，同時此樣品僅保留90天。本報告未經本公司書面許可，不可部份複製。

This document is issued by the Company subject to its General Conditions of Service printed overleaf, available on request or accessible at <http://www.sgs.com.tw/Terms-and-Conditions> and for electronic format documents, subject to Terms and Conditions for Electronic Documents at <http://www.sgs.com.tw/Terms-and-Conditions>. Attention is drawn to the limitation of liability, indemnification and jurisdiction issues defined therein. Any holder of this document is advised that information contained hereon reflects the Company's findings at the time of its intervention only and within the limits of Client's instructions, if any. The Company's sole responsibility is to its Client and this document does not exonerate parties to a transaction from exercising all their rights and obligations under the transaction documents. This document cannot be reproduced except in full, without prior written approval of the Company. Any unauthorized alteration, forgery or falsification of the content or appearance of this document is unlawful and offenders may be prosecuted to the fullest extent of the law.

14.27.18 Trial 18

Data Sheet for FCC Radar Type 5						
Trial Number:		18		VSG Frequency(MHz):		5498.3445
Number of Bursts in Trial:			19		Successful Detection: Yes	
Burst (8-20)	Number Pulses per Burst (1-3)	Pulse Width (50-100)	Chirp Width (5-20)	Pulse 1-to-2 Spacing	Pulse 2-to-3 Spacing	Starting Location Within Interval
		(μ sec)	(MHz)	(μ sec)	(μ sec)	(μ sec)
1	2	74.7	18	1195.3		397610
2	3	92.2	18	986.8	1411.8	548460
3	1	63.1	18			73913
4	3	89.4	18	1857.6	1340.6	225288
5	1	57.5	18			379635
6	2	69.6	18	1755.4		530955
7	1	62.1	18			55066
8	3	92.3	18	1823.7	1520.7	206531
9	3	90.1	18	1411.9	1426.9	359180
10	2	83.3	18	1525.7		511995
11	2	82.5	18	920.5		36177
12	1	50	18			189009
13	1	56	18			341672
14	3	93.4	18	958.6	1162.6	492876
15	1	57.1	18			17384
16	3	96.9	18	1903.1	1547.1	169257
17	3	95.7	18	1611.3	1631.3	321056
18	3	91.5	18	1837.5	1020.5	473521
19	2	78.5	18	1722.5		626753

Unless otherwise stated the results shown in this test report refer only to the sample(s) tested and such sample(s) are retained for 90 days only.

除非另有說明，此報告結果僅對測試之樣品負責，同時此樣品僅保留90天。本報告未經本公司書面許可，不可部份複製。

This document is issued by the Company subject to its General Conditions of Service printed overleaf, available on request or accessible at <http://www.sgs.com.tw/Terms-and-Conditions> and for electronic format documents, subject to Terms and Conditions for Electronic Documents at <http://www.sgs.com.tw/Terms-and-Conditions>. Attention is drawn to the limitation of liability, indemnification and jurisdiction issues defined therein. Any holder of this document is advised that information contained hereon reflects the Company's findings at the time of its intervention only and within the limits of Client's instructions, if any. The Company's sole responsibility is to its Client and this document does not exonerate parties to a transaction from exercising all their rights and obligations under the transaction documents. This document cannot be reproduced except in full, without prior written approval of the Company. Any unauthorized alteration, forgery or falsification of the content or appearance of this document is unlawful and offenders may be prosecuted to the fullest extent of the law.

14.27.19 Trial 19

Data Sheet for FCC Radar Type 5						
Trial Number:		19		VSG Frequency(MHz):		5498.3445
Number of Bursts in Trial:			19		Successful Detection: Yes	
Burst (8-20)	Number Pulses per Burst (1-3)	Pulse Width (50-100)	Chirp Width (5-20)	Pulse 1-to-2 Spacing	Pulse 2-to-3 Spacing	Starting Location Within Interval
		(μ sec)	(MHz)	(μ sec)	(μ sec)	(μ sec)
1	1	64.1	18			151404
2	2	68.7	18	1329.3		303636
3	2	67.7	18	1621.3		455897
4	2	80.9	18	925.1		608478
5	1	53.7	18			132455
6	3	90.7	18	1583.3	965.3	284045
7	1	53.7	18			438429
8	1	60.7	18			591109
9	3	86.6	18	1369.4	1362.4	113150
10	2	70.7	18	1328.3		266125
11	1	62.2	18			419294
12	2	73.9	18	1043.1		571533
13	1	56.5	18			94839
14	1	62.7	18			247847
15	3	98	18	1526	1572	398132
16	1	58.4	18			553311
17	1	51.1	18			76048
18	1	56.6	18			228873
19	2	82.8	18	1720.2		380555

Unless otherwise stated the results shown in this test report refer only to the sample(s) tested and such sample(s) are retained for 90 days only.

除非另有說明，此報告結果僅對測試之樣品負責，同時此樣品僅保留90天。本報告未經本公司書面許可，不可部份複製。

This document is issued by the Company subject to its General Conditions of Service printed overleaf, available on request or accessible at <http://www.sgs.com.tw/Terms-and-Conditions> and for electronic format documents, subject to Terms and Conditions for Electronic Documents at <http://www.sgs.com.tw/Terms-and-Conditions>. Attention is drawn to the limitation of liability, indemnification and jurisdiction issues defined therein. Any holder of this document is advised that information contained hereon reflects the Company's findings at the time of its intervention only and within the limits of Client's instructions, if any. The Company's sole responsibility is to its Client and this document does not exonerate parties to a transaction from exercising all their rights and obligations under the transaction documents. This document cannot be reproduced except in full, without prior written approval of the Company. Any unauthorized alteration, forgery or falsification of the content or appearance of this document is unlawful and offenders may be prosecuted to the fullest extent of the law.

14.27.20 Trial 20

Data Sheet for FCC Radar Type 5						
Trial Number:		20		VSG Frequency(MHz):		5498.3445
Number of Bursts in Trial:			19		Successful Detection: No	
Burst (8-20)	Number Pulses per Burst (1-3)	Pulse Width (50-100)	Chirp Width (5-20)	Pulse 1-to-2 Spacing	Pulse 2-to-3 Spacing	Starting Location Within Interval
		(μ sec)	(MHz)	(μ sec)	(μ sec)	(μ sec)
1	3	97.3	18	1385.7	1004.7	532247
2	2	78.3	18	1527.7		57131
3	3	86.3	18	1377.7	941.7	209175
4	2	75.6	18	1300.4		361912
5	3	97.1	18	1425.9	1562.9	512859
6	1	61.3	18			38427
7	3	94.7	18	1832.3	1797.3	189951
8	3	99.9	18	1615.1	1227.1	342491
9	3	96.2	18	1114.8	1128.8	495260
10	2	72.7	18	1002.3		19590
11	2	71.8	18	1446.2		172045
12	2	81.1	18	1817.9		324012
13	3	97.1	18	911.9	1082.9	476328
14	2	76.9	18	1550.1		795
15	3	90.2	18	1815.8	1585.8	152759
16	3	92	18	1261	1695	304775
17	1	60.6	18			459016
18	1	57	18			612493
19	1	61.2	18			134877

Unless otherwise stated the results shown in this test report refer only to the sample(s) tested and such sample(s) are retained for 90 days only.

除非另有說明，此報告結果僅對測試之樣品負責，同時此樣品僅保留90天。本報告未經本公司書面許可，不可部份複製。

This document is issued by the Company subject to its General Conditions of Service printed overleaf, available on request or accessible at <http://www.sgs.com.tw/Terms-and-Conditions> and for electronic format documents, subject to Terms and Conditions for Electronic Documents at <http://www.sgs.com.tw/Terms-and-Conditions>. Attention is drawn to the limitation of liability, indemnification and jurisdiction issues defined therein. Any holder of this document is advised that information contained hereon reflects the Company's findings at the time of its intervention only and within the limits of Client's instructions, if any. The Company's sole responsibility is to its Client and this document does not exonerate parties to a transaction from exercising all their rights and obligations under the transaction documents. This document cannot be reproduced except in full, without prior written approval of the Company. Any unauthorized alteration, forgery or falsification of the content or appearance of this document is unlawful and offenders may be prosecuted to the fullest extent of the law.

14.27.21 Trial 21

Data Sheet for FCC Radar Type 5						
Trial Number:		21		VSG Frequency(MHz):		5504.4555
Number of Bursts in Trial:			13	Successful Detection:		Yes
Burst (8-20)	Number Pulses per Burst (1-3)	Pulse Width (50-100)	Chirp Width (5-20)	Pulse 1-to-2 Spacing	Pulse 2-to-3 Spacing	Starting Location Within Interval
		(μ sec)	(MHz)	(μ sec)	(μ sec)	(μ sec)
1	1	59.3	11			420586
2	3	98.7	11	1621.3	1301.3	641808
3	1	53.8	11			867823
4	1	58.9	11			169631
5	2	75.5	11	1554.5		392320
6	2	71.5	11	1535.5		615399
7	2	77.8	11	1860.2		838671
8	1	59.4	11			142128
9	2	76	11	1021		365105
10	3	87.3	11	1224.7	1506.7	587038
11	1	58.1	11			813032
12	3	84.9	11	1098.1	1553.1	114183
13	1	55.9	11			337935

Unless otherwise stated the results shown in this test report refer only to the sample(s) tested and such sample(s) are retained for 90 days only.

除非另有說明，此報告結果僅對測試之樣品負責，同時此樣品僅保留90天。本報告未經本公司書面許可，不可部份複製。

This document is issued by the Company subject to its General Conditions of Service printed overleaf, available on request or accessible at <http://www.sgs.com.tw/Terms-and-Conditions> and for electronic format documents, subject to Terms and Conditions for Electronic Documents at <http://www.sgs.com.tw/Terms-and-Conditions>. Attention is drawn to the limitation of liability, indemnification and jurisdiction issues defined therein. Any holder of this document is advised that information contained hereon reflects the Company's findings at the time of its intervention only and within the limits of Client's instructions, if any. The Company's sole responsibility is to its Client and this document does not exonerate parties to a transaction from exercising all their rights and obligations under the transaction documents. This document cannot be reproduced except in full, without prior written approval of the Company. Any unauthorized alteration, forgery or falsification of the content or appearance of this document is unlawful and offenders may be prosecuted to the fullest extent of the law.

14.27.22 Trial 22

Data Sheet for FCC Radar Type 5						
Trial Number:		22		VSG Frequency(MHz):		5504.8555
Number of Bursts in Trial:			12		Successful Detection: Yes	
Burst (8-20)	Number Pulses per Burst (1-3)	Pulse Width (50-100)	Chirp Width (5-20)	Pulse 1-to-2 Spacing	Pulse 2-to-3 Spacing	Starting Location Within Interval
		(μ sec)	(MHz)	(μ sec)	(μ sec)	(μ sec)
1	3	90.2	10	1273.8	1204.8	606736
2	1	62.9	10			850876
3	3	94.2	10	1482.8	1602.8	93968
4	1	50.2	10			336477
5	2	77.8	10	936.2		577757
6	3	93.2	10	1579.8	1677.8	817990
7	2	70.7	10	1139.3		64356
8	2	69.6	10	1677.4		306218
9	1	59.1	10			548542
10	3	90.9	10	1382.1	993.1	788888
11	1	57.5	10			34613
12	3	88.1	10	923.9	1836.9	275921

Unless otherwise stated the results shown in this test report refer only to the sample(s) tested and such sample(s) are retained for 90 days only.

除非另有說明，此報告結果僅對測試之樣品負責，同時此樣品僅保留90天。本報告未經本公司書面許可，不可部份複製。

This document is issued by the Company subject to its General Conditions of Service printed overleaf, available on request or accessible at <http://www.sgs.com.tw/Terms-and-Conditions> and for electronic format documents, subject to Terms and Conditions for Electronic Documents at <http://www.sgs.com.tw/Terms-and-Conditions>. Attention is drawn to the limitation of liability, indemnification and jurisdiction issues defined therein. Any holder of this document is advised that information contained hereon reflects the Company's findings at the time of its intervention only and within the limits of Client's instructions, if any. The Company's sole responsibility is to its Client and this document does not exonerate parties to a transaction from exercising all their rights and obligations under the transaction documents. This document cannot be reproduced except in full, without prior written approval of the Company. Any unauthorized alteration, forgery or falsification of the content or appearance of this document is unlawful and offenders may be prosecuted to the fullest extent of the law.

14.27.23 Trial 23

Data Sheet for FCC Radar Type 5						
Trial Number:		23		VSG Frequency(MHz):		5503.2555
Number of Bursts in Trial:			15		Successful Detection: Yes	
Burst (8-20)	Number Pulses per Burst (1-3)	Pulse Width (50-100)	Chirp Width (5-20)	Pulse 1-to-2 Spacing	Pulse 2-to-3 Spacing	Starting Location Within Interval
		(μ sec)	(MHz)	(μ sec)	(μ sec)	(μ sec)
1	1	64.7	14			415120
2	3	89.6	14	1085.4	1597.4	606453
3	1	65.2	14			3836
4	3	97.1	14	1273.9	1796.9	196765
5	1	66.3	14			391306
6	2	70.7	14	1892.3		583184
7	3	87.3	14	1673.7	1200.7	775695
8	1	51.4	14			173646
9	3	90	14	998	1587	366139
10	3	97.3	14	1723.7	1681.7	558113
11	3	84.2	14	1194.8	1188.8	752330
12	3	93.5	14	1780.5	1458.5	149161
13	2	69.3	14	1497.7		342569
14	1	60.7	14			537050
15	1	54	14			730970

Unless otherwise stated the results shown in this test report refer only to the sample(s) tested and such sample(s) are retained for 90 days only.

除非另有說明，此報告結果僅對測試之樣品負責，同時此樣品僅保留90天。本報告未經本公司書面許可，不可部份複製。

This document is issued by the Company subject to its General Conditions of Service printed overleaf, available on request or accessible at <http://www.sgs.com.tw/Terms-and-Conditions> and for electronic format documents, subject to Terms and Conditions for Electronic Documents at <http://www.sgs.com.tw/Terms-and-Conditions>. Attention is drawn to the limitation of liability, indemnification and jurisdiction issues defined therein. Any holder of this document is advised that information contained hereon reflects the Company's findings at the time of its intervention only and within the limits of Client's instructions, if any. The Company's sole responsibility is to its Client and this document does not exonerate parties to a transaction from exercising all their rights and obligations under the transaction documents. This document cannot be reproduced except in full, without prior written approval of the Company. Any unauthorized alteration, forgery or falsification of the content or appearance of this document is unlawful and offenders may be prosecuted to the fullest extent of the law.

14.27.24 Trial 24

Data Sheet for FCC Radar Type 5						
Trial Number:		24		VSG Frequency(MHz):		5501.2555
Number of Bursts in Trial:			20		Successful Detection: No	
Burst (8-20)	Number Pulses per Burst (1-3)	Pulse Width (50-100)	Chirp Width (5-20)	Pulse 1-to-2 Spacing	Pulse 2-to-3 Spacing	Starting Location Within Interval
		(μ sec)	(MHz)	(μ sec)	(μ sec)	(μ sec)
1	2	69.3	19	1293.7		94192
2	1	51.9	19			239745
3	2	68.6	19	1582.4		383859
4	1	62.5	19			529765
5	3	88.1	19	915.9	1048.9	76228
6	3	87.8	19	1104.2	1140.2	220653
7	1	65.8	19			366886
8	3	90.9	19	1123.1	1324.1	509849
9	3	84.2	19	1904.8	1361.8	58326
10	2	82.8	19	1605.2		203265
11	3	90	19	1177	1126	347500
12	1	64.1	19			494229
13	2	67.4	19	1012.6		40688
14	3	86.4	19	1558.6	1100.6	185058
15	3	91.7	19	1461.3	1772.3	329175
16	1	50.2	19			476294
17	1	57.7	19			22880
18	3	96.3	19	1617.7	1315.7	167054
19	2	70.9	19	1872.1		311966
20	1	60.7	19			458616

Unless otherwise stated the results shown in this test report refer only to the sample(s) tested and such sample(s) are retained for 90 days only.

除非另有說明，此報告結果僅對測試之樣品負責，同時此樣品僅保留90天。本報告未經本公司書面許可，不可部份複製。

This document is issued by the Company subject to its General Conditions of Service printed overleaf, available on request or accessible at <http://www.sgs.com.tw/Terms-and-Conditions> and for electronic format documents, subject to Terms and Conditions for Electronic Documents at <http://www.sgs.com.tw/Terms-and-Conditions>. Attention is drawn to the limitation of liability, indemnification and jurisdiction issues defined therein. Any holder of this document is advised that information contained hereon reflects the Company's findings at the time of its intervention only and within the limits of Client's instructions, if any. The Company's sole responsibility is to its Client and this document does not exonerate parties to a transaction from exercising all their rights and obligations under the transaction documents. This document cannot be reproduced except in full, without prior written approval of the Company. Any unauthorized alteration, forgery or falsification of the content or appearance of this document is unlawful and offenders may be prosecuted to the fullest extent of the law.

14.27.25 Trial 25

Data Sheet for FCC Radar Type 5						
Trial Number:		25		VSG Frequency(MHz):		5500.8555
Number of Bursts in Trial:			20		Successful Detection: Yes	
Burst (8-20)	Number Pulses per Burst (1-3)	Pulse Width (50-100)	Chirp Width (5-20)	Pulse 1-to-2 Spacing	Pulse 2-to-3 Spacing	Starting Location Within Interval
		(μ sec)	(MHz)	(μ sec)	(μ sec)	(μ sec)
1	2	81.9	20	1747.1		4972
2	1	62.6	20			150270
3	1	62.4	20			295146
4	1	59.6	20			440705
5	1	66.6	20			585945
6	2	70.9	20	1927.1		131840
7	3	83.4	20	1273.6	1651.6	275953
8	1	66	20			422341
9	3	93	20	1287	1229	565394
10	2	78.7	20	1908.3		113975
11	1	50.6	20			259629
12	2	80.9	20	1405.1		403645
13	2	67	20	1119		548813
14	3	89.2	20	1509.8	1008.8	96014
15	1	51.4	20			241566
16	2	67.6	20	1374.4		386144
17	3	90.5	20	1318.5	1145.5	529515
18	2	78.4	20	1374.6		78447
19	2	69.5	20	1465.5		223236
20	1	50.2	20			368841

Unless otherwise stated the results shown in this test report refer only to the sample(s) tested and such sample(s) are retained for 90 days only.

除非另有說明，此報告結果僅對測試之樣品負責，同時此樣品僅保留90天。本報告未經本公司書面許可，不可部份複製。

This document is issued by the Company subject to its General Conditions of Service printed overleaf, available on request or accessible at <http://www.sgs.com.tw/Terms-and-Conditions> and for electronic format documents, subject to Terms and Conditions for Electronic Documents at <http://www.sgs.com.tw/Terms-and-Conditions>. Attention is drawn to the limitation of liability, indemnification and jurisdiction issues defined therein. Any holder of this document is advised that information contained hereon reflects the Company's findings at the time of its intervention only and within the limits of Client's instructions, if any. The Company's sole responsibility is to its Client and this document does not exonerate parties to a transaction from exercising all their rights and obligations under the transaction documents. This document cannot be reproduced except in full, without prior written approval of the Company. Any unauthorized alteration, forgery or falsification of the content or appearance of this document is unlawful and offenders may be prosecuted to the fullest extent of the law.

14.27.26 Trial 26

Data Sheet for FCC Radar Type 5						
Trial Number:		26		VSG Frequency(MHz):		5501.6555
Number of Bursts in Trial:			18		Successful Detection: Yes	
Burst (8-20)	Number Pulses per Burst (1-3)	Pulse Width (50-100)	Chirp Width (5-20)	Pulse 1-to-2 Spacing	Pulse 2-to-3 Spacing	Starting Location Within Interval
		(μ sec)	(MHz)	(μ sec)	(μ sec)	(μ sec)
1	3	98.9	18	1308.1	1758.1	568650
2	3	98.7	18	1695.3	1690.3	67123
3	2	81	18	929		228397
4	1	64.3	18			390410
5	2	76.4	18	1343.6		550359
6	1	56.5	18			47616
7	2	69.8	18	1199.2		208712
8	1	65.1	18			370179
9	3	98.3	18	1534.7	1270.7	528943
10	3	97	18	1717	1581	27624
11	2	76.4	18	1683.6		188468
12	3	97.3	18	1588.7	1219.7	348918
13	3	98.5	18	1611.5	1263.5	509458
14	3	100	18	1471	1010	7870
15	2	72.1	18	1282.9		168818
16	1	56.6	18			330451
17	3	89.6	18	1459.4	1814.4	489199
18	1	59	18			653547

Unless otherwise stated the results shown in this test report refer only to the sample(s) tested and such sample(s) are retained for 90 days only.

除非另有說明，此報告結果僅對測試之樣品負責，同時此樣品僅保留90天。本報告未經本公司書面許可，不可部份複製。

This document is issued by the Company subject to its General Conditions of Service printed overleaf, available on request or accessible at <http://www.sgs.com.tw/Terms-and-Conditions> and for electronic format documents, subject to Terms and Conditions for Electronic Documents at <http://www.sgs.com.tw/Terms-and-Conditions>. Attention is drawn to the limitation of liability, indemnification and jurisdiction issues defined therein. Any holder of this document is advised that information contained hereon reflects the Company's findings at the time of its intervention only and within the limits of Client's instructions, if any. The Company's sole responsibility is to its Client and this document does not exonerate parties to a transaction from exercising all their rights and obligations under the transaction documents. This document cannot be reproduced except in full, without prior written approval of the Company. Any unauthorized alteration, forgery or falsification of the content or appearance of this document is unlawful and offenders may be prosecuted to the fullest extent of the law.

14.27.27 Trial 27

Data Sheet for FCC Radar Type 5						
Trial Number:		27		VSG Frequency(MHz):		5505.2555
Number of Bursts in Trial:			11		Successful Detection: Yes	
Burst (8-20)	Number Pulses per Burst (1-3)	Pulse Width (50-100)	Chirp Width (5-20)	Pulse 1-to-2 Spacing	Pulse 2-to-3 Spacing	Starting Location Within Interval
		(μ sec)	(MHz)	(μ sec)	(μ sec)	(μ sec)
1	3	96	9	964	1269	244138
2	2	67.1	9	1167.9		508034
3	1	54.3	9			772920
4	3	99.9	9	1046.1	1220.1	1035183
5	3	98	9	1600	940	211483
6	1	55.5	9			476199
7	2	82.1	9	1539.9		739691
8	1	59.1	9			1005073
9	3	97.1	9	1569.9	1053.9	179037
10	2	78.3	9	1685.7		442966
11	3	85	9	1745	1510	705622

Unless otherwise stated the results shown in this test report refer only to the sample(s) tested and such sample(s) are retained for 90 days only.

除非另有說明，此報告結果僅對測試之樣品負責，同時此樣品僅保留90天。本報告未經本公司書面許可，不可部份複製。

This document is issued by the Company subject to its General Conditions of Service printed overleaf, available on request or accessible at <http://www.sgs.com.tw/Terms-and-Conditions> and for electronic format documents, subject to Terms and Conditions for Electronic Documents at <http://www.sgs.com.tw/Terms-and-Conditions>. Attention is drawn to the limitation of liability, indemnification and jurisdiction issues defined therein. Any holder of this document is advised that information contained hereon reflects the Company's findings at the time of its intervention only and within the limits of Client's instructions, if any. The Company's sole responsibility is to its Client and this document does not exonerate parties to a transaction from exercising all their rights and obligations under the transaction documents. This document cannot be reproduced except in full, without prior written approval of the Company. Any unauthorized alteration, forgery or falsification of the content or appearance of this document is unlawful and offenders may be prosecuted to the fullest extent of the law.

14.27.28 Trial 28

Data Sheet for FCC Radar Type 5						
Trial Number:		28		VSG Frequency(MHz):		5502.0555
Number of Bursts in Trial:			18		Successful Detection: Yes	
Burst (8-20)	Number Pulses per Burst (1-3)	Pulse Width (50-100)	Chirp Width (5-20)	Pulse 1-to-2 Spacing	Pulse 2-to-3 Spacing	Starting Location Within Interval
		(μ sec)	(MHz)	(μ sec)	(μ sec)	(μ sec)
1	2	74	17	1226		592566
2	1	59.8	17			89732
3	2	79.3	17	1839.7		250502
4	2	76.7	17	1083.3		411804
5	2	70.6	17	1421.4		572049
6	1	61.8	17			69871
7	2	83.2	17	1608.8		230717
8	2	81.7	17	1839.3		391658
9	3	98.1	17	1843.9	1145.9	551342
10	2	83.3	17	1716.7		49863
11	1	60	17			211312
12	1	51	17			372850
13	2	68.2	17	1899.8		532734
14	2	67.8	17	1688.2		30024
15	3	96	17	1446	1613	190604
16	1	52.3	17			352547
17	1	53.4	17			513835
18	2	82.4	17	1680.6		10225

Unless otherwise stated the results shown in this test report refer only to the sample(s) tested and such sample(s) are retained for 90 days only.

除非另有說明，此報告結果僅對測試之樣品負責，同時此樣品僅保留90天。本報告未經本公司書面許可，不可部份複製。

This document is issued by the Company subject to its General Conditions of Service printed overleaf, available on request or accessible at <http://www.sgs.com.tw/Terms-and-Conditions> and for electronic format documents, subject to Terms and Conditions for Electronic Documents at <http://www.sgs.com.tw/Terms-and-Conditions>. Attention is drawn to the limitation of liability, indemnification and jurisdiction issues defined therein. Any holder of this document is advised that information contained hereon reflects the Company's findings at the time of its intervention only and within the limits of Client's instructions, if any. The Company's sole responsibility is to its Client and this document does not exonerate parties to a transaction from exercising all their rights and obligations under the transaction documents. This document cannot be reproduced except in full, without prior written approval of the Company. Any unauthorized alteration, forgery or falsification of the content or appearance of this document is unlawful and offenders may be prosecuted to the fullest extent of the law.

14.27.29 Trial 29

Data Sheet for FCC Radar Type 5						
Trial Number:		29		VSG Frequency(MHz):		5506.4555
Number of Bursts in Trial:			8	Successful Detection:		Yes
Burst (8-20)	Number Pulses per Burst (1-3)	Pulse Width (50-100)	Chirp Width (5-20)	Pulse 1-to-2 Spacing	Pulse 2-to-3 Spacing	Starting Location Within Interval
		(μ sec)	(MHz)	(μ sec)	(μ sec)	(μ sec)
1	2	67	6	1136		386176
2	2	67	6	975		749473
3	3	94.8	6	946.2	1399.2	1111261
4	2	78.1	6	1873.9		1475197
5	2	81.4	6	1855.6		341314
6	2	82.5	6	1477.5		704354
7	1	52.3	6			1068403
8	3	95.9	6	1723.1	1465.1	1429278

Unless otherwise stated the results shown in this test report refer only to the sample(s) tested and such sample(s) are retained for 90 days only.

除非另有說明，此報告結果僅對測試之樣品負責，同時此樣品僅保留90天。本報告未經本公司書面許可，不可部份複製。

This document is issued by the Company subject to its General Conditions of Service printed overleaf, available on request or accessible at <http://www.sgs.com.tw/Terms-and-Conditions> and for electronic format documents, subject to Terms and Conditions for Electronic Documents at <http://www.sgs.com.tw/Terms-and-Conditions>. Attention is drawn to the limitation of liability, indemnification and jurisdiction issues defined therein. Any holder of this document is advised that information contained hereon reflects the Company's findings at the time of its intervention only and within the limits of Client's instructions, if any. The Company's sole responsibility is to its Client and this document does not exonerate parties to a transaction from exercising all their rights and obligations under the transaction documents. This document cannot be reproduced except in full, without prior written approval of the Company. Any unauthorized alteration, forgery or falsification of the content or appearance of this document is unlawful and offenders may be prosecuted to the fullest extent of the law.

14.27.30 Trial 30

Data Sheet for FCC Radar Type 5						
Trial Number:		30		VSG Frequency(MHz):		5502.0555
Number of Bursts in Trial:			18		Successful Detection: Yes	
Burst (8-20)	Number Pulses per Burst (1-3)	Pulse Width (50-100)	Chirp Width (5-20)	Pulse 1-to-2 Spacing	Pulse 2-to-3 Spacing	Starting Location Within Interval
		(μ sec)	(MHz)	(μ sec)	(μ sec)	(μ sec)
1	3	99.1	17	1050.9	1191.9	131268
2	1	50.7	17			293150
3	2	75.5	17	1479.5		453485
4	2	82.2	17	1702.8		613895
5	2	67.3	17	1725.7		111637
6	1	59.4	17			273119
7	3	91.5	17	1718.5	1057.5	432670
8	2	80.2	17	1136.8		594976
9	2	74.2	17	975.8		91921
10	3	87.2	17	1141.8	1835.8	252079
11	3	97.2	17	1803.8	1028.8	413002
12	2	70.5	17	1487.5		574498
13	2	77.9	17	1638.1		71981
14	3	88.2	17	1134.8	1636.8	232616
15	3	88.9	17	1484.1	1059.1	393436
16	2	74.9	17	1917.1		554812
17	3	91.5	17	1591.5	1728.5	52089
18	2	75.8	17	1480.2		213172

Unless otherwise stated the results shown in this test report refer only to the sample(s) tested and such sample(s) are retained for 90 days only.

除非另有說明，此報告結果僅對測試之樣品負責，同時此樣品僅保留90天。本報告未經本公司書面許可，不可部份複製。

This document is issued by the Company subject to its General Conditions of Service printed overleaf, available on request or accessible at <http://www.sgs.com.tw/Terms-and-Conditions> and for electronic format documents, subject to Terms and Conditions for Electronic Documents at <http://www.sgs.com.tw/Terms-and-Conditions>. Attention is drawn to the limitation of liability, indemnification and jurisdiction issues defined therein. Any holder of this document is advised that information contained hereon reflects the Company's findings at the time of its intervention only and within the limits of Client's instructions, if any. The Company's sole responsibility is to its Client and this document does not exonerate parties to a transaction from exercising all their rights and obligations under the transaction documents. This document cannot be reproduced except in full, without prior written approval of the Company. Any unauthorized alteration, forgery or falsification of the content or appearance of this document is unlawful and offenders may be prosecuted to the fullest extent of the law.

14.28 Radar Type 6 for 5500 MHz:

Data Sheet for FCC Radar Type 6						
Trial	Pulse Width	PRI	Pulses per Hop	Hopping Rate	Hopping Sequence Length	Successful Detection
	(μ sec)	(μ sec)		(kHz)	(msec)	(Yes/No)
1	1	333	9	0.333	300	Yes
2	1	333	9	0.333	300	Yes
3	1	333	9	0.333	300	Yes
4	1	333	9	0.333	300	Yes
5	1	333	9	0.333	300	Yes
6	1	333	9	0.333	300	Yes
7	1	333	9	0.333	300	Yes
8	1	333	9	0.333	300	Yes
9	1	333	9	0.333	300	Yes
10	1	333	9	0.333	300	Yes
11	1	333	9	0.333	300	Yes
12	1	333	9	0.333	300	Yes
13	1	333	9	0.333	300	Yes
14	1	333	9	0.333	300	No
15	1	333	9	0.333	300	Yes
16	1	333	9	0.333	300	Yes
17	1	333	9	0.333	300	Yes
18	1	333	9	0.333	300	Yes
19	1	333	9	0.333	300	Yes
20	1	333	9	0.333	300	Yes
21	1	333	9	0.333	300	Yes
22	1	333	9	0.333	300	Yes
23	1	333	9	0.333	300	Yes
24	1	333	9	0.333	300	Yes
25	1	333	9	0.333	300	Yes
26	1	333	9	0.333	300	Yes
27	1	333	9	0.333	300	Yes
28	1	333	9	0.333	300	Yes
29	1	333	9	0.333	300	Yes
30	1	333	9	0.333	300	Yes

Unless otherwise stated the results shown in this test report refer only to the sample(s) tested and such sample(s) are retained for 90 days only.

除非另有說明，此報告結果僅對測試之樣品負責，同時此樣品僅保留90天。本報告未經本公司書面許可，不可部份複製。

This document is issued by the Company subject to its General Conditions of Service printed overleaf, available on request or accessible at <http://www.sgs.com.tw/Terms-and-Conditions> and for electronic format documents, subject to Terms and Conditions for Electronic Documents at <http://www.sgs.com.tw/Terms-and-Conditions>. Attention is drawn to the limitation of liability, indemnification and jurisdiction issues defined therein. Any holder of this document is advised that information contained hereon reflects the Company's findings at the time of its intervention only and within the limits of Client's instructions, if any. The Company's sole responsibility is to its Client and this document does not exonerate parties to a transaction from exercising all their rights and obligations under the transaction documents. This document cannot be reproduced except in full, without prior written approval of the Company. Any unauthorized alteration, forgery or falsification of the content or appearance of this document is unlawful and offenders may be prosecuted to the fullest extent of the law.

14.29 5510MHz:

Short Pulse Radar Type	Minimum Number of Trials	Detection(%)		Minimum Percentage of Successful Detection(%)	Pass/Fail
1	30	70		60	Pass
2	30	100		60	Pass
3	30	96.67		60	Pass
4	30	80		60	Pass
Aggregate (Radar Types 1-4)	120	86.6675		80	Pass
Long Pulse Radar Type	Minimum Number of Trials	Each Detection(%)	Total Detection(%)	Minimum Percentage of Successful Detection(%)	Pass/Fail
5	Center:10	80	83.33333333	80	Pass
	Low Edge:10	80			
	High Edge:10	90			
Frequency Hopping Radar Type	Minimum Number of Trials	Detection(%)		Minimum Percentage of Successful Detection(%)	Pass/Fail
6	30	100		70	Pass

Unless otherwise stated the results shown in this test report refer only to the sample(s) tested and such sample(s) are retained for 90 days only.

除非另有說明，此報告結果僅對測試之樣品負責，同時此樣品僅保留90天。本報告未經本公司書面許可，不可部份複製。

This document is issued by the Company subject to its General Conditions of Service printed overleaf, available on request or accessible at <http://www.sgs.com.tw/Terms-and-Conditions> and for electronic format documents, subject to Terms and Conditions for Electronic Documents at <http://www.sgs.com.tw/Terms-and-Conditions>. Attention is drawn to the limitation of liability, indemnification and jurisdiction issues defined therein. Any holder of this document is advised that information contained hereon reflects the Company's findings at the time of its intervention only and within the limits of Client's instructions, if any. The Company's sole responsibility is to its Client and this document does not exonerate parties to a transaction from exercising all their rights and obligations under the transaction documents. This document cannot be reproduced except in full, without prior written approval of the Company. Any unauthorized alteration, forgery or falsification of the content or appearance of this document is unlawful and offenders may be prosecuted to the fullest extent of the law.

14.30 Radar Type 1 for 5510 MHz:

Data Sheet for FCC Radar Type 1						
Trial	VSG Frequency (MHz)	Pulse Repetition Frequency	Pulse Repetition Frequency	PRI	Test A/B	Successful Detection
		Number (1 to 23)	(Pulses Per Second)	(msec)	A/B	(Yes/No)
1	5510	16	1222.5	818	A	Yes
2	5510	12	1355	738	A	Yes
3	5510	11	1392.8	718	A	Yes
4	5510	17	1193.3	838	A	Yes
5	5510	9	1474.9	678	A	Yes
6	5510	10	1432.7	698	A	Yes
7	5510	4	1730.1	578	A	Yes
8	5510	15	1253.1	798	A	Yes
9	5510	8	1519.8	658	A	Yes
10	5510	5	1672.2	598	A	Yes
11	5510	20	1113.6	898	A	Yes
12	5510	3	1792.1	558	A	Yes
13	5510	13	1319.3	758	A	Yes
14	5510	2	1858.7	538	A	Yes
15	5510	19	1139	878	A	Yes
16	5510	-	755.3	1324	B	Yes
17	5510	-	336.5	2972	B	No
18	5510	-	445	2247	B	No
19	5510	-	628.1	1592	B	No
20	5510	-	546.1	1831	B	No
21	5510	-	901.7	1109	B	Yes
22	5510	-	646	1548	B	No
23	5510	-	327.5	3053	B	Yes
24	5510	-	847.5	1180	B	Yes
25	5510	-	378.9	2639	B	No
26	5510	-	679.3	1472	B	No
27	5510	-	356.5	2805	B	No
28	5510	-	1100.1	909	B	Yes
29	5510	-	512.6	1951	B	No
30	5510	-	1179.2	848	B	Yes

Unless otherwise stated the results shown in this test report refer only to the sample(s) tested and such sample(s) are retained for 90 days only.

除非另有說明，此報告結果僅對測試之樣品負責，同時此樣品僅保留90天。本報告未經本公司書面許可，不可部份複製。

This document is issued by the Company subject to its General Conditions of Service printed overleaf, available on request or accessible at <http://www.sgs.com.tw/Terms-and-Conditions> and for electronic format documents, subject to Terms and Conditions for Electronic Documents at <http://www.sgs.com.tw/Terms-and-Conditions>. Attention is drawn to the limitation of liability, indemnification and jurisdiction issues defined therein. Any holder of this document is advised that information contained hereon reflects the Company's findings at the time of its intervention only and within the limits of Client's instructions, if any. The Company's sole responsibility is to its Client and this document does not exonerate parties to a transaction from exercising all their rights and obligations under the transaction documents. This document cannot be reproduced except in full, without prior written approval of the Company. Any unauthorized alteration, forgery or falsification of the content or appearance of this document is unlawful and offenders may be prosecuted to the fullest extent of the law.

14.31 Radar Type 2 for 5510 MHz:

Data Sheet for FCC Radar Type 2					
Trial	VSG Frequency (MHz)	Number Pulses per Burst (23-29)	Pulse Width (1-5)	PRI (150-230)	Successful Detection
			(μ s)	(μ s)	(Yes/No)
1	5510	25	2.2	191	Yes
2	5510	26	3.3	186	Yes
3	5510	29	4.8	227	Yes
4	5510	29	5	185	Yes
5	5510	25	2.1	222	Yes
6	5510	28	4.5	175	Yes
7	5510	28	4	190	Yes
8	5510	23	1.1	220	Yes
9	5510	28	4.1	213	Yes
10	5510	23	1.1	223	Yes
11	5510	25	2.5	157	Yes
12	5510	26	2.8	217	Yes
13	5510	24	1.7	216	Yes
14	5510	24	1.6	179	Yes
15	5510	26	2.8	155	Yes
16	5510	25	2.7	196	Yes
17	5510	24	1.6	152	Yes
18	5510	25	2.2	170	Yes
19	5510	24	1.6	188	Yes
20	5510	24	1.7	178	Yes
21	5510	26	2.7	192	Yes
22	5510	24	2.1	197	Yes
23	5510	25	2.3	180	Yes
24	5510	23	1.2	221	Yes
25	5510	26	2.9	207	Yes
26	5510	27	3.7	209	Yes
27	5510	29	4.8	229	Yes
28	5510	29	5	212	Yes
29	5510	29	4.9	176	Yes
30	5510	27	3.4	160	Yes

Unless otherwise stated the results shown in this test report refer only to the sample(s) tested and such sample(s) are retained for 90 days only.

除非另有說明，此報告結果僅對測試之樣品負責，同時此樣品僅保留90天。本報告未經本公司書面許可，不可部份複製。

This document is issued by the Company subject to its General Conditions of Service printed overleaf, available on request or accessible at <http://www.sgs.com.tw/Terms-and-Conditions> and for electronic format documents, subject to Terms and Conditions for Electronic Documents at <http://www.sgs.com.tw/Terms-and-Conditions>. Attention is drawn to the limitation of liability, indemnification and jurisdiction issues defined therein. Any holder of this document is advised that information contained hereon reflects the Company's findings at the time of its intervention only and within the limits of Client's instructions, if any. The Company's sole responsibility is to its Client and this document does not exonerate parties to a transaction from exercising all their rights and obligations under the transaction documents. This document cannot be reproduced except in full, without prior written approval of the Company. Any unauthorized alteration, forgery or falsification of the content or appearance of this document is unlawful and offenders may be prosecuted to the fullest extent of the law.

14.32 Radar Type 3 for 5510 MHz:

Data Sheet for FCC Radar Type 3					
Trial	VSG Frequency (MHz)	Number Pulses per Burst (16-18)	Pulse Width (6-10)	PRI (200-500)	Successful Detection
			(μ s)	(μ s)	(Yes/No)
1	5510	16	7.2	379	Yes
2	5510	17	8.3	353	Yes
3	5510	18	9.8	462	Yes
4	5510	18	10	428	Yes
5	5510	16	7.1	354	Yes
6	5510	18	9.5	222	Yes
7	5510	18	9	364	Yes
8	5510	16	6.1	217	Yes
9	5510	18	9.1	387	Yes
10	5510	16	6.1	433	Yes
11	5510	17	7.5	246	Yes
12	5510	17	7.8	231	Yes
13	5510	16	6.7	228	Yes
14	5510	16	6.6	375	No
15	5510	17	7.8	304	Yes
16	5510	17	7.7	215	Yes
17	5510	16	6.6	500	Yes
18	5510	16	7.2	401	Yes
19	5510	16	6.6	216	Yes
20	5510	16	6.7	251	Yes
21	5510	17	7.7	202	Yes
22	5510	16	7.1	461	Yes
23	5510	16	7.3	267	Yes
24	5510	16	6.2	227	Yes
25	5510	17	7.9	362	Yes
26	5510	18	8.7	358	Yes
27	5510	18	9.8	204	Yes
28	5510	18	10	219	Yes
29	5510	18	9.9	315	Yes
30	5510	17	8.4	351	Yes

Unless otherwise stated the results shown in this test report refer only to the sample(s) tested and such sample(s) are retained for 90 days only.

除非另有說明，此報告結果僅對測試之樣品負責，同時此樣品僅保留90天。本報告未經本公司書面許可，不可部份複製。

This document is issued by the Company subject to its General Conditions of Service printed overleaf, available on request or accessible at <http://www.sgs.com.tw/Terms-and-Conditions> and for electronic format documents, subject to Terms and Conditions for Electronic Documents at <http://www.sgs.com.tw/Terms-and-Conditions>. Attention is drawn to the limitation of liability, indemnification and jurisdiction issues defined therein. Any holder of this document is advised that information contained hereon reflects the Company's findings at the time of its intervention only and within the limits of Client's instructions, if any. The Company's sole responsibility is to its Client and this document does not exonerate parties to a transaction from exercising all their rights and obligations under the transaction documents. This document cannot be reproduced except in full, without prior written approval of the Company. Any unauthorized alteration, forgery or falsification of the content or appearance of this document is unlawful and offenders may be prosecuted to the fullest extent of the law.

14.33 Radar Type 4 for 5510 MHz:

Data Sheet for FCC Radar Type 4					
Trial	VSG Frequency (MHz)	Number Pulses per Burst (12-16)	Pulse Width (11-20)	PRI (200-500)	Successful Detection
			(μ s)	(μ s)	(Yes/No)
1	5510	13	13.8	379	No
2	5510	14	16.1	353	Yes
3	5510	16	19.6	462	No
4	5510	16	19.9	428	No
5	5510	13	13.6	354	Yes
6	5510	16	18.7	222	Yes
7	5510	15	17.7	364	Yes
8	5510	12	11.2	217	Yes
9	5510	15	17.9	387	No
10	5510	12	11.3	433	Yes
11	5510	13	14.4	246	Yes
12	5510	14	15	231	Yes
13	5510	12	12.7	228	Yes
14	5510	12	12.4	375	Yes
15	5510	14	15	304	Yes
16	5510	14	14.8	215	Yes
17	5510	12	12.3	500	No
18	5510	13	13.7	401	No
19	5510	12	12.4	216	Yes
20	5510	12	12.7	251	Yes
21	5510	14	14.9	202	Yes
22	5510	13	13.4	461	Yes
23	5510	13	14	267	Yes
24	5510	12	11.4	227	Yes
25	5510	14	15.3	362	Yes
26	5510	15	17.1	358	Yes
27	5510	16	19.5	204	Yes
28	5510	16	20	219	Yes
29	5510	16	19.7	315	Yes
30	5510	14	16.4	351	Yes

Unless otherwise stated the results shown in this test report refer only to the sample(s) tested and such sample(s) are retained for 90 days only.

除非另有說明，此報告結果僅對測試之樣品負責，同時此樣品僅保留90天。本報告未經本公司書面許可，不可部份複製。

This document is issued by the Company subject to its General Conditions of Service printed overleaf, available on request or accessible at <http://www.sgs.com.tw/Terms-and-Conditions> and for electronic format documents, subject to Terms and Conditions for Electronic Documents at <http://www.sgs.com.tw/Terms-and-Conditions>. Attention is drawn to the limitation of liability, indemnification and jurisdiction issues defined therein. Any holder of this document is advised that information contained hereon reflects the Company's findings at the time of its intervention only and within the limits of Client's instructions, if any. The Company's sole responsibility is to its Client and this document does not exonerate parties to a transaction from exercising all their rights and obligations under the transaction documents. This document cannot be reproduced except in full, without prior written approval of the Company. Any unauthorized alteration, forgery or falsification of the content or appearance of this document is unlawful and offenders may be prosecuted to the fullest extent of the law.

14.34 Radar Type 5 for 5510 MHz:
14.34.1 Trial 1:

Data Sheet for FCC Radar Type 5						
Trial Number:		1		VSG Frequency(MHz):		5510
Number of Bursts in Trial:			14		Successful Detection: No	
Burst (8-20)	Number Pulses per Burst (1-3)	Pulse Width (50-100)	Chirp Width (5-20)	Pulse 1-to-2 Spacing	Pulse 2-to-3 Spacing	Starting Location Within Interval
		(μ sec)	(MHz)	(μ sec)	(μ sec)	(μ sec)
1	2	75.7	13	1450.3		646095
2	2	76.2	13	1835.8		853391
3	3	98.6	13	1660.4	1151.4	206260
4	1	60	13			414310
5	3	88.3	13	1410.7	982.7	620248
6	1	52	13			829565
7	3	92.7	13	1451.3	1091.3	180697
8	3	84.5	13	1906.5	1481.5	387097
9	2	79.4	13	1230.6		595173
10	3	86.3	13	1491.7	1529.7	801190
11	1	52.5	13			155846
12	1	65.8	13			363169
13	1	51.8	13			570697
14	3	96.5	13	919.5	1148.5	776534

Unless otherwise stated the results shown in this test report refer only to the sample(s) tested and such sample(s) are retained for 90 days only.

除非另有說明，此報告結果僅對測試之樣品負責，同時此樣品僅保留90天。本報告未經本公司書面許可，不可部份複製。

This document is issued by the Company subject to its General Conditions of Service printed overleaf, available on request or accessible at <http://www.sgs.com.tw/Terms-and-Conditions> and for electronic format documents, subject to Terms and Conditions for Electronic Documents at <http://www.sgs.com.tw/Terms-and-Conditions>. Attention is drawn to the limitation of liability, indemnification and jurisdiction issues defined therein. Any holder of this document is advised that information contained hereon reflects the Company's findings at the time of its intervention only and within the limits of Client's instructions, if any. The Company's sole responsibility is to its Client and this document does not exonerate parties to a transaction from exercising all their rights and obligations under the transaction documents. This document cannot be reproduced except in full, without prior written approval of the Company. Any unauthorized alteration, forgery or falsification of the content or appearance of this document is unlawful and offenders may be prosecuted to the fullest extent of the law.

14.34.2 Trial 2:

Data Sheet for FCC Radar Type 5						
Trial Number:		2		VSG Frequency(MHz):		5510
Number of Bursts in Trial:			14		Successful Detection: Yes	
Burst (8-20)	Number Pulses per Burst (1-3)	Pulse Width (50-100)	Chirp Width (5-20)	Pulse 1-to-2 Spacing	Pulse 2-to-3 Spacing	Starting Location Within Interval
		(μ sec)	(MHz)	(μ sec)	(μ sec)	(μ sec)
1	3	89.7	13	1178.3	976.3	129878
2	3	96.5	13	1823.5	1552.5	336196
3	2	78.6	13	1730.4		544288
4	3	92.6	13	1348.4	1150.4	750076
5	3	92.6	13	1533.4	1761.4	104294
6	3	93	13	1878	1609	310994
7	2	70.3	13	1860.7		518416
8	1	66	13			727353
9	2	78.7	13	1898.3		78905
10	3	96.3	13	954.7	1546.7	285586
11	3	97.7	13	1410.3	1595.3	492469
12	3	92.3	13	1052.7	1690.7	699494
13	1	65.3	13			53555
14	3	88.9	13	1411.1	1716.1	260074

Unless otherwise stated the results shown in this test report refer only to the sample(s) tested and such sample(s) are retained for 90 days only.

除非另有說明，此報告結果僅對測試之樣品負責，同時此樣品僅保留90天。本報告未經本公司書面許可，不可部份複製。

This document is issued by the Company subject to its General Conditions of Service printed overleaf, available on request or accessible at <http://www.sgs.com.tw/Terms-and-Conditions> and for electronic format documents, subject to Terms and Conditions for Electronic Documents at <http://www.sgs.com.tw/Terms-and-Conditions>. Attention is drawn to the limitation of liability, indemnification and jurisdiction issues defined therein. Any holder of this document is advised that information contained hereon reflects the Company's findings at the time of its intervention only and within the limits of Client's instructions, if any. The Company's sole responsibility is to its Client and this document does not exonerate parties to a transaction from exercising all their rights and obligations under the transaction documents. This document cannot be reproduced except in full, without prior written approval of the Company. Any unauthorized alteration, forgery or falsification of the content or appearance of this document is unlawful and offenders may be prosecuted to the fullest extent of the law.

14.34.3 Trial 3

Data Sheet for FCC Radar Type 5						
Trial Number:		3		VSG Frequency(MHz):		5510
Number of Bursts in Trial:			20		Successful Detection: Yes	
Burst (8-20)	Number Pulses per Burst (1-3)	Pulse Width (50-100)	Chirp Width (5-20)	Pulse 1-to-2 Spacing	Pulse 2-to-3 Spacing	Starting Location Within Interval
		(μ sec)	(MHz)	(μ sec)	(μ sec)	(μ sec)
1	1	53.1	20			327984
2	3	90	20	1789	1447	470347
3	2	82.3	20	1038.7		19538
4	2	76.2	20	1301.8		164251
5	2	80.3	20	1314.7		309125
6	3	91.2	20	1887.8	1592.8	452206
7	2	82.6	20	1648.4		1697
8	1	56.7	20			146959
9	2	69.4	20	1711.6		291322
10	2	71	20	1475		436052
11	3	97.9	20	1413.1	1179.1	579415
12	3	93.2	20	1553.8	1022.8	128485
13	2	72.1	20	1223.9		273557
14	3	94.6	20	1584.4	990.4	417454
15	3	90.4	20	1291.6	1396.6	561415
16	3	85.2	20	1173.8	1748.8	110459
17	3	95.3	20	1538.7	1756.7	254888
18	2	71.2	20	1839.8		400255
19	1	64.1	20			546815
20	2	74.5	20	1751.5		92943

Unless otherwise stated the results shown in this test report refer only to the sample(s) tested and such sample(s) are retained for 90 days only.

除非另有說明，此報告結果僅對測試之樣品負責，同時此樣品僅保留90天。本報告未經本公司書面許可，不可部份複製。

This document is issued by the Company subject to its General Conditions of Service printed overleaf, available on request or accessible at <http://www.sgs.com.tw/Terms-and-Conditions> and for electronic format documents, subject to Terms and Conditions for Electronic Documents at <http://www.sgs.com.tw/Terms-and-Conditions>. Attention is drawn to the limitation of liability, indemnification and jurisdiction issues defined therein. Any holder of this document is advised that information contained hereon reflects the Company's findings at the time of its intervention only and within the limits of Client's instructions, if any. The Company's sole responsibility is to its Client and this document does not exonerate parties to a transaction from exercising all their rights and obligations under the transaction documents. This document cannot be reproduced except in full, without prior written approval of the Company. Any unauthorized alteration, forgery or falsification of the content or appearance of this document is unlawful and offenders may be prosecuted to the fullest extent of the law.

14.34.4 Trial 4

Data Sheet for FCC Radar Type 5						
Trial Number:		4		VSG Frequency(MHz):		5510
Number of Bursts in Trial:			10		Successful Detection: Yes	
Burst (8-20)	Number Pulses per Burst (1-3)	Pulse Width (50-100)	Chirp Width (5-20)	Pulse 1-to-2 Spacing	Pulse 2-to-3 Spacing	Starting Location Within Interval
		(μ sec)	(MHz)	(μ sec)	(μ sec)	(μ sec)
1	2	71.3	8	1835.7		476618
2	1	57.3	8			768080
3	3	95.2	8	917.8	1522.8	1056357
4	2	82.8	8	1172.2		150695
5	2	79.5	8	1775.5		441008
6	2	68.9	8	1636.1		731474
7	1	53.6	8			1022491
8	1	59.6	8			115101
9	3	97.5	8	1330.5	1620.5	404670
10	1	52.3	8			696336

Unless otherwise stated the results shown in this test report refer only to the sample(s) tested and such sample(s) are retained for 90 days only.

除非另有說明，此報告結果僅對測試之樣品負責，同時此樣品僅保留90天。本報告未經本公司書面許可，不可部份複製。

This document is issued by the Company subject to its General Conditions of Service printed overleaf, available on request or accessible at <http://www.sgs.com.tw/Terms-and-Conditions> and for electronic format documents, subject to Terms and Conditions for Electronic Documents at <http://www.sgs.com.tw/Terms-and-Conditions>. Attention is drawn to the limitation of liability, indemnification and jurisdiction issues defined therein. Any holder of this document is advised that information contained hereon reflects the Company's findings at the time of its intervention only and within the limits of Client's instructions, if any. The Company's sole responsibility is to its Client and this document does not exonerate parties to a transaction from exercising all their rights and obligations under the transaction documents. This document cannot be reproduced except in full, without prior written approval of the Company. Any unauthorized alteration, forgery or falsification of the content or appearance of this document is unlawful and offenders may be prosecuted to the fullest extent of the law.

14.34.5 Trial 5

Data Sheet for FCC Radar Type 5						
Trial Number:		5		VSG Frequency(MHz):		5510
Number of Bursts in Trial:			17		Successful Detection: Yes	
Burst (8-20)	Number Pulses per Burst (1-3)	Pulse Width (50-100)	Chirp Width (5-20)	Pulse 1-to-2 Spacing	Pulse 2-to-3 Spacing	Starting Location Within Interval
		(μ sec)	(MHz)	(μ sec)	(μ sec)	(μ sec)
1	1	62.3	17			580292
2	3	96	17	1892	1376	46376
3	3	86.7	17	1845.3	1609.3	216364
4	1	53.7	17			388124
5	2	81.3	17	1741.7		557500
6	3	89.5	17	1284.5	1043.5	25448
7	1	53.9	17			196365
8	2	76.3	17	1248.7		366324
9	3	85.6	17	1399.4	1573.4	535403
10	1	60.6	17			4498
11	1	63.8	17			175244
12	2	82.9	17	1841.1		345455
13	2	77	17	950		516472
14	1	57.6	17			687535
15	3	94.7	17	1506.3	1682.3	153508
16	3	99.4	17	1072.6	1097.6	324212
17	2	70.8	17	1827.2		494914

Unless otherwise stated the results shown in this test report refer only to the sample(s) tested and such sample(s) are retained for 90 days only.

除非另有說明，此報告結果僅對測試之樣品負責，同時此樣品僅保留90天。本報告未經本公司書面許可，不可部份複製。

This document is issued by the Company subject to its General Conditions of Service printed overleaf, available on request or accessible at <http://www.sgs.com.tw/Terms-and-Conditions> and for electronic format documents, subject to Terms and Conditions for Electronic Documents at <http://www.sgs.com.tw/Terms-and-Conditions>. Attention is drawn to the limitation of liability, indemnification and jurisdiction issues defined therein. Any holder of this document is advised that information contained hereon reflects the Company's findings at the time of its intervention only and within the limits of Client's instructions, if any. The Company's sole responsibility is to its Client and this document does not exonerate parties to a transaction from exercising all their rights and obligations under the transaction documents. This document cannot be reproduced except in full, without prior written approval of the Company. Any unauthorized alteration, forgery or falsification of the content or appearance of this document is unlawful and offenders may be prosecuted to the fullest extent of the law.

14.34.6 Trial 6

Data Sheet for FCC Radar Type 5						
Trial Number:		6		VSG Frequency(MHz):		5510
Number of Bursts in Trial:			8		Successful Detection: Yes	
Burst (8-20)	Number Pulses per Burst (1-3)	Pulse Width (50-100)	Chirp Width (5-20)	Pulse 1-to-2 Spacing	Pulse 2-to-3 Spacing	Starting Location Within Interval
		(μ sec)	(MHz)	(μ sec)	(μ sec)	(μ sec)
1	2	75.7	5	1039.3		1417883
2	2	75.7	5	1675.3		283058
3	3	93.5	5	1267.5	1790.5	645459
4	1	50.9	5			1010268
5	2	76.5	5	1874.5		1371553
6	2	78.2	5	1352.8		238446
7	3	90.9	5	1594.1	1659.1	600817
8	2	67.6	5	1311.4		964778

Unless otherwise stated the results shown in this test report refer only to the sample(s) tested and such sample(s) are retained for 90 days only.

除非另有說明，此報告結果僅對測試之樣品負責，同時此樣品僅保留90天。本報告未經本公司書面許可，不可部份複製。

This document is issued by the Company subject to its General Conditions of Service printed overleaf, available on request or accessible at <http://www.sgs.com.tw/Terms-and-Conditions> and for electronic format documents, subject to Terms and Conditions for Electronic Documents at <http://www.sgs.com.tw/Terms-and-Conditions>. Attention is drawn to the limitation of liability, indemnification and jurisdiction issues defined therein. Any holder of this document is advised that information contained hereon reflects the Company's findings at the time of its intervention only and within the limits of Client's instructions, if any. The Company's sole responsibility is to its Client and this document does not exonerate parties to a transaction from exercising all their rights and obligations under the transaction documents. This document cannot be reproduced except in full, without prior written approval of the Company. Any unauthorized alteration, forgery or falsification of the content or appearance of this document is unlawful and offenders may be prosecuted to the fullest extent of the law.

14.34.7 Trial 7

Data Sheet for FCC Radar Type 5						
Trial Number:		7		VSG Frequency(MHz):		5510
Number of Bursts in Trial:			19		Successful Detection: Yes	
Burst (8-20)	Number Pulses per Burst (1-3)	Pulse Width (50-100)	Chirp Width (5-20)	Pulse 1-to-2 Spacing	Pulse 2-to-3 Spacing	Starting Location Within Interval
		(μ sec)	(MHz)	(μ sec)	(μ sec)	(μ sec)
1	3	95.8	18	1832.2	1410.2	555394
2	3	94.9	18	1322.1	1204.1	81223
3	3	99.5	18	1355.5	1089.5	233328
4	3	96.8	18	1535.2	1145.2	385633
5	1	61.3	18			540366
6	3	87.5	18	1422.5	1401.5	62393
7	2	72.9	18	1379.1		215032
8	1	59.2	18			368445
9	2	67.1	18	1004.9		520066
10	1	58.6	18			43887
11	1	51.8	18			196798
12	1	56.4	18			349750
13	2	68.4	18	1078.6		501484
14	1	63.2	18			25077
15	1	50.8	18			177809
16	2	81.2	18	1690.8		329509
17	2	68.9	18	1214.1		482804
18	3	85.6	18	1638.4	1504.4	6218
19	1	53.4	18			159040

Unless otherwise stated the results shown in this test report refer only to the sample(s) tested and such sample(s) are retained for 90 days only.

除非另有說明，此報告結果僅對測試之樣品負責，同時此樣品僅保留90天。本報告未經本公司書面許可，不可部份複製。

This document is issued by the Company subject to its General Conditions of Service printed overleaf, available on request or accessible at <http://www.sgs.com.tw/Terms-and-Conditions> and for electronic format documents, subject to Terms and Conditions for Electronic Documents at <http://www.sgs.com.tw/Terms-and-Conditions>. Attention is drawn to the limitation of liability, indemnification and jurisdiction issues defined therein. Any holder of this document is advised that information contained hereon reflects the Company's findings at the time of its intervention only and within the limits of Client's instructions, if any. The Company's sole responsibility is to its Client and this document does not exonerate parties to a transaction from exercising all their rights and obligations under the transaction documents. This document cannot be reproduced except in full, without prior written approval of the Company. Any unauthorized alteration, forgery or falsification of the content or appearance of this document is unlawful and offenders may be prosecuted to the fullest extent of the law.

14.34.8 Trial 8

Data Sheet for FCC Radar Type 5						
Trial Number:		8		VSG Frequency(MHz):		5510
Number of Bursts in Trial:			16		Successful Detection: No	
Burst (8-20)	Number Pulses per Burst (1-3)	Pulse Width (50-100)	Chirp Width (5-20)	Pulse 1-to-2 Spacing	Pulse 2-to-3 Spacing	Starting Location Within Interval
		(μ sec)	(MHz)	(μ sec)	(μ sec)	(μ sec)
1	1	60.6	16			370709
2	3	88.4	16	1673.6	1542.6	549691
3	2	80.4	16	1180.6		732531
4	3	87.6	16	1044.4	1739.4	165939
5	3	88.2	16	1018.8	1348.8	346815
6	2	80.1	16	1083.9		529051
7	3	98.1	16	1002.9	932.9	709596
8	2	78	16	1770		143881
9	3	84	16	1829	955	324420
10	1	53.9	16			507438
11	1	51.3	16			689099
12	3	85.9	16	1091.1	973.1	121440
13	2	67.8	16	1372.2		302742
14	3	95.8	16	1367.2	1777.2	483049
15	3	86.1	16	1808.9	1553.9	663080
16	3	85.6	16	1203.4	1201.4	99115

Unless otherwise stated the results shown in this test report refer only to the sample(s) tested and such sample(s) are retained for 90 days only.

除非另有說明，此報告結果僅對測試之樣品負責，同時此樣品僅保留90天。本報告未經本公司書面許可，不可部份複製。

This document is issued by the Company subject to its General Conditions of Service printed overleaf, available on request or accessible at <http://www.sgs.com.tw/Terms-and-Conditions> and for electronic format documents, subject to Terms and Conditions for Electronic Documents at <http://www.sgs.com.tw/Terms-and-Conditions>. Attention is drawn to the limitation of liability, indemnification and jurisdiction issues defined therein. Any holder of this document is advised that information contained hereon reflects the Company's findings at the time of its intervention only and within the limits of Client's instructions, if any. The Company's sole responsibility is to its Client and this document does not exonerate parties to a transaction from exercising all their rights and obligations under the transaction documents. This document cannot be reproduced except in full, without prior written approval of the Company. Any unauthorized alteration, forgery or falsification of the content or appearance of this document is unlawful and offenders may be prosecuted to the fullest extent of the law.

14.34.9 Trial 9

Data Sheet for FCC Radar Type 5						
Trial Number:		9		VSG Frequency(MHz):		5510
Number of Bursts in Trial:			15		Successful Detection: Yes	
Burst (8-20)	Number Pulses per Burst (1-3)	Pulse Width (50-100)	Chirp Width (5-20)	Pulse 1-to-2 Spacing	Pulse 2-to-3 Spacing	Starting Location Within Interval
		(μ sec)	(MHz)	(μ sec)	(μ sec)	(μ sec)
1	3	94.7	14	1479.3	1263.3	298833
2	1	54.5	14			493176
3	2	79.6	14	1873.4		685083
4	2	74.2	14	1843.8		82062
5	2	73.2	14	1416.8		275417
6	3	90.9	14	1149.1	1074.1	467980
7	2	73.7	14	1483.3		662375
8	1	59.9	14			58438
9	3	99	14	1378	1647	251182
10	3	92.8	14	1777.2	1876.2	443379
11	3	93	14	1382	1233	637342
12	1	52.4	14			34582
13	1	62.4	14			228187
14	2	74.8	14	1905.2		420798
15	1	62.3	14			615553

Unless otherwise stated the results shown in this test report refer only to the sample(s) tested and such sample(s) are retained for 90 days only.

除非另有說明，此報告結果僅對測試之樣品負責，同時此樣品僅保留90天。本報告未經本公司書面許可，不可部份複製。

This document is issued by the Company subject to its General Conditions of Service printed overleaf, available on request or accessible at <http://www.sgs.com.tw/Terms-and-Conditions> and for electronic format documents, subject to Terms and Conditions for Electronic Documents at <http://www.sgs.com.tw/Terms-and-Conditions>. Attention is drawn to the limitation of liability, indemnification and jurisdiction issues defined therein. Any holder of this document is advised that information contained hereon reflects the Company's findings at the time of its intervention only and within the limits of Client's instructions, if any. The Company's sole responsibility is to its Client and this document does not exonerate parties to a transaction from exercising all their rights and obligations under the transaction documents. This document cannot be reproduced except in full, without prior written approval of the Company. Any unauthorized alteration, forgery or falsification of the content or appearance of this document is unlawful and offenders may be prosecuted to the fullest extent of the law.

14.34.10 Trial 10

Data Sheet for FCC Radar Type 5						
Trial Number:		10		VSG Frequency(MHz):		5510
Number of Bursts in Trial:			17		Successful Detection: Yes	
Burst (8-20)	Number Pulses per Burst (1-3)	Pulse Width (50-100)	Chirp Width (5-20)	Pulse 1-to-2 Spacing	Pulse 2-to-3 Spacing	Starting Location Within Interval
		(μ sec)	(MHz)	(μ sec)	(μ sec)	(μ sec)
1	2	82	16	1608		9460
2	3	90.9	16	1895.1	1899.1	179231
3	2	74.7	16	971.3		350504
4	2	80.3	16	1727.7		520285
5	2	79.3	16	1343.7		691395
6	1	65.4	16			159274
7	1	57.2	16			330226
8	1	61.3	16			500882
9	2	66.7	16	1384.3		670070
10	1	63.3	16			138302
11	1	59.5	16			308892
12	3	89	16	956	1389	478108
13	1	55.2	16			651105
14	1	65.7	16			117181
15	2	72.8	16	1140.2		287537
16	3	84.1	16	1657.9	1577.9	456409
17	1	60.6	16			630080

Unless otherwise stated the results shown in this test report refer only to the sample(s) tested and such sample(s) are retained for 90 days only.

除非另有說明，此報告結果僅對測試之樣品負責，同時此樣品僅保留90天。本報告未經本公司書面許可，不可部份複製。

This document is issued by the Company subject to its General Conditions of Service printed overleaf, available on request or accessible at <http://www.sgs.com.tw/Terms-and-Conditions> and for electronic format documents, subject to Terms and Conditions for Electronic Documents at <http://www.sgs.com.tw/Terms-and-Conditions>. Attention is drawn to the limitation of liability, indemnification and jurisdiction issues defined therein. Any holder of this document is advised that information contained hereon reflects the Company's findings at the time of its intervention only and within the limits of Client's instructions, if any. The Company's sole responsibility is to its Client and this document does not exonerate parties to a transaction from exercising all their rights and obligations under the transaction documents. This document cannot be reproduced except in full, without prior written approval of the Company. Any unauthorized alteration, forgery or falsification of the content or appearance of this document is unlawful and offenders may be prosecuted to the fullest extent of the law.

14.34.11 Trial 11

Data Sheet for FCC Radar Type 5						
Trial Number:		11		VSG Frequency(MHz):		5493.838
Number of Bursts in Trial:			8		Successful Detection: Yes	
Burst (8-20)	Number Pulses per Burst (1-3)	Pulse Width (50-100)	Chirp Width (5-20)	Pulse 1-to-2 Spacing	Pulse 2-to-3 Spacing	Starting Location Within Interval
		(μ sec)	(MHz)	(μ sec)	(μ sec)	(μ sec)
1	2	82.3	5	1891.7		204286
2	2	77.7	5	1726.3		567132
3	1	56.2	5			931599
4	2	76.6	5	1705.4		1293038
5	3	89.4	5	1564.6	1775.6	159393
6	1	61.4	5			523221
7	2	80.3	5	1636.7		885768
8	2	69.7	5	1494.3		1249162

Unless otherwise stated the results shown in this test report refer only to the sample(s) tested and such sample(s) are retained for 90 days only.

除非另有說明，此報告結果僅對測試之樣品負責，同時此樣品僅保留90天。本報告未經本公司書面許可，不可部份複製。

This document is issued by the Company subject to its General Conditions of Service printed overleaf, available on request or accessible at <http://www.sgs.com.tw/Terms-and-Conditions> and for electronic format documents, subject to Terms and Conditions for Electronic Documents at <http://www.sgs.com.tw/Terms-and-Conditions>. Attention is drawn to the limitation of liability, indemnification and jurisdiction issues defined therein. Any holder of this document is advised that information contained hereon reflects the Company's findings at the time of its intervention only and within the limits of Client's instructions, if any. The Company's sole responsibility is to its Client and this document does not exonerate parties to a transaction from exercising all their rights and obligations under the transaction documents. This document cannot be reproduced except in full, without prior written approval of the Company. Any unauthorized alteration, forgery or falsification of the content or appearance of this document is unlawful and offenders may be prosecuted to the fullest extent of the law.

14.34.12 Trial 12

Data Sheet for FCC Radar Type 5						
Trial Number:		12		VSG Frequency(MHz):		5495.838
Number of Bursts in Trial:			12		Successful Detection: Yes	
Burst (8-20)	Number Pulses per Burst (1-3)	Pulse Width (50-100)	Chirp Width (5-20)	Pulse 1-to-2 Spacing	Pulse 2-to-3 Spacing	Starting Location Within Interval
		(μ sec)	(MHz)	(μ sec)	(μ sec)	(μ sec)
1	1	64.7	10			76661
2	2	70.5	10	1788.5		318052
3	3	88.7	10	1145.3	1370.3	559355
4	3	95.4	10	1585.6	977.6	800973
5	3	87.2	10	1730.8	931.8	46677
6	3	95.7	10	1486.3	1643.3	287993
7	1	65.5	10			531115
8	1	59.1	10			773599
9	3	91.7	10	1495.3	944.3	16922
10	2	69.4	10	1818.6		258740
11	3	95.1	10	1223.9	1397.9	499728
12	3	93.2	10	1751.8	1222.8	740884

Unless otherwise stated the results shown in this test report refer only to the sample(s) tested and such sample(s) are retained for 90 days only.

除非另有說明，此報告結果僅對測試之樣品負責，同時此樣品僅保留90天。本報告未經本公司書面許可，不可部份複製。

This document is issued by the Company subject to its General Conditions of Service printed overleaf, available on request or accessible at <http://www.sgs.com.tw/Terms-and-Conditions> and for electronic format documents, subject to Terms and Conditions for Electronic Documents at <http://www.sgs.com.tw/Terms-and-Conditions>. Attention is drawn to the limitation of liability, indemnification and jurisdiction issues defined therein. Any holder of this document is advised that information contained hereon reflects the Company's findings at the time of its intervention only and within the limits of Client's instructions, if any. The Company's sole responsibility is to its Client and this document does not exonerate parties to a transaction from exercising all their rights and obligations under the transaction documents. This document cannot be reproduced except in full, without prior written approval of the Company. Any unauthorized alteration, forgery or falsification of the content or appearance of this document is unlawful and offenders may be prosecuted to the fullest extent of the law.

14.34.13 Trial 13

Data Sheet for FCC Radar Type 5						
Trial Number:		13		VSG Frequency(MHz):		5493.838
Number of Bursts in Trial:			8		Successful Detection: Yes	
Burst (8-20)	Number Pulses per Burst (1-3)	Pulse Width (50-100)	Chirp Width (5-20)	Pulse 1-to-2 Spacing	Pulse 2-to-3 Spacing	Starting Location Within Interval
		(μ sec)	(MHz)	(μ sec)	(μ sec)	(μ sec)
1	1	65.5	5			1479371
2	1	56.8	5			344182
3	2	70.1	5	1105.9		706970
4	3	87.4	5	1570.6	1874.6	1068743
5	3	93.3	5	1060.7	1618.7	1432093
6	1	62.8	5			299316
7	1	60.9	5			662666
8	1	63.7	5			1026325

Unless otherwise stated the results shown in this test report refer only to the sample(s) tested and such sample(s) are retained for 90 days only.

除非另有說明，此報告結果僅對測試之樣品負責，同時此樣品僅保留90天。本報告未經本公司書面許可，不可部份複製。

This document is issued by the Company subject to its General Conditions of Service printed overleaf, available on request or accessible at <http://www.sgs.com.tw/Terms-and-Conditions> and for electronic format documents, subject to Terms and Conditions for Electronic Documents at <http://www.sgs.com.tw/Terms-and-Conditions>. Attention is drawn to the limitation of liability, indemnification and jurisdiction issues defined therein. Any holder of this document is advised that information contained hereon reflects the Company's findings at the time of its intervention only and within the limits of Client's instructions, if any. The Company's sole responsibility is to its Client and this document does not exonerate parties to a transaction from exercising all their rights and obligations under the transaction documents. This document cannot be reproduced except in full, without prior written approval of the Company. Any unauthorized alteration, forgery or falsification of the content or appearance of this document is unlawful and offenders may be prosecuted to the fullest extent of the law.

14.34.14 Trial 14

Data Sheet for FCC Radar Type 5						
Trial Number:		14		VSG Frequency(MHz):		5499.438
Number of Bursts in Trial:			20		Successful Detection: Yes	
Burst (8-20)	Number Pulses per Burst (1-3)	Pulse Width (50-100)	Chirp Width (5-20)	Pulse 1-to-2 Spacing	Pulse 2-to-3 Spacing	Starting Location Within Interval
		(μ sec)	(MHz)	(μ sec)	(μ sec)	(μ sec)
1	1	51.9	19			555310
2	2	68.4	19	1297.6		101410
3	3	94.2	19	937.8	1678.8	245502
4	2	76.1	19	1023.9		391491
5	1	58.7	19			537470
6	2	82.3	19	1078.7		83620
7	2	70.1	19	1302.9		228490
8	3	84.7	19	1375.3	1583.3	372232
9	2	68.6	19	1426.4		517894
10	3	85.7	19	963.3	1248.3	65637
11	3	92.7	19	1210.3	1139.3	210105
12	2	79.5	19	1500.5		355398
13	3	94.5	19	1452.5	1043.5	498911
14	1	60.5	19			48049
15	1	64.6	19			193165
16	3	95	19	1062	1748	336831
17	2	68.6	19	1053.4		482936
18	1	65.9	19			30180
19	2	79.6	19	945.4		175084
20	2	67.6	19	933.4		320145

Unless otherwise stated the results shown in this test report refer only to the sample(s) tested and such sample(s) are retained for 90 days only.

除非另有說明，此報告結果僅對測試之樣品負責，同時此樣品僅保留90天。本報告未經本公司書面許可，不可部份複製。

This document is issued by the Company subject to its General Conditions of Service printed overleaf, available on request or accessible at <http://www.sgs.com.tw/Terms-and-Conditions> and for electronic format documents, subject to Terms and Conditions for Electronic Documents at <http://www.sgs.com.tw/Terms-and-Conditions>. Attention is drawn to the limitation of liability, indemnification and jurisdiction issues defined therein. Any holder of this document is advised that information contained hereon reflects the Company's findings at the time of its intervention only and within the limits of Client's instructions, if any. The Company's sole responsibility is to its Client and this document does not exonerate parties to a transaction from exercising all their rights and obligations under the transaction documents. This document cannot be reproduced except in full, without prior written approval of the Company. Any unauthorized alteration, forgery or falsification of the content or appearance of this document is unlawful and offenders may be prosecuted to the fullest extent of the law.

14.34.15 Trial 15

Data Sheet for FCC Radar Type 5						
Trial Number:		15		VSG Frequency(MHz):		5498.638
Number of Bursts in Trial:			18		Successful Detection: Yes	
Burst (8-20)	Number Pulses per Burst (1-3)	Pulse Width (50-100)	Chirp Width (5-20)	Pulse 1-to-2 Spacing	Pulse 2-to-3 Spacing	Starting Location Within Interval
		(μ sec)	(MHz)	(μ sec)	(μ sec)	(μ sec)
1	3	94	17	1439	1888	514754
2	2	79.9	17	1615.1		13624
3	1	63.6	17			175105
4	3	96.4	17	1606.6	1207.6	334596
5	2	77.7	17	1836.3		496335
6	3	91	17	1245	1130	656012
7	3	95.2	17	1843.8	1354.8	154230
8	2	75.5	17	1645.5		315659
9	1	57.6	17			477960
10	2	68.8	17	948.2		638361
11	3	83.4	17	1039.6	1116.6	134744
12	2	76.6	17	1028.4		296218
13	1	50.4	17			458029
14	1	66.5	17			618940
15	2	67.8	17	1250.2		115207
16	3	96.3	17	1337.7	984.7	275765
17	2	76.3	17	1450.7		436688
18	1	62.5	17			598976

Unless otherwise stated the results shown in this test report refer only to the sample(s) tested and such sample(s) are retained for 90 days only.

除非另有說明，此報告結果僅對測試之樣品負責，同時此樣品僅保留90天。本報告未經本公司書面許可，不可部份複製。

This document is issued by the Company subject to its General Conditions of Service printed overleaf, available on request or accessible at <http://www.sgs.com.tw/Terms-and-Conditions> and for electronic format documents, subject to Terms and Conditions for Electronic Documents at <http://www.sgs.com.tw/Terms-and-Conditions>. Attention is drawn to the limitation of liability, indemnification and jurisdiction issues defined therein. Any holder of this document is advised that information contained hereon reflects the Company's findings at the time of its intervention only and within the limits of Client's instructions, if any. The Company's sole responsibility is to its Client and this document does not exonerate parties to a transaction from exercising all their rights and obligations under the transaction documents. This document cannot be reproduced except in full, without prior written approval of the Company. Any unauthorized alteration, forgery or falsification of the content or appearance of this document is unlawful and offenders may be prosecuted to the fullest extent of the law.

14.34.16 Trial 16

Data Sheet for FCC Radar Type 5						
Trial Number:		16		VSG Frequency(MHz):		5499.438
Number of Bursts in Trial:			20		Successful Detection: Yes	
Burst (8-20)	Number Pulses per Burst (1-3)	Pulse Width (50-100)	Chirp Width (5-20)	Pulse 1-to-2 Spacing	Pulse 2-to-3 Spacing	Starting Location Within Interval
		(μ sec)	(MHz)	(μ sec)	(μ sec)	(μ sec)
1	3	86.6	19	1849.4	1340.4	85405
2	1	54.8	19			231183
3	2	75.5	19	1790.5		375035
4	2	80.8	19	1449.2		520228
5	3	90.5	19	931.5	1160.5	67791
6	1	56	19			213098
7	2	76.7	19	1877.3		357248
8	1	65.6	19			503347
9	3	98.7	19	1273.3	1295.3	49898
10	1	55	19			195306
11	3	92.3	19	1251.7	1171.7	339090
12	2	75.1	19	979.9		484759
13	2	68.8	19	1501.2		32183
14	2	77.3	19	1798.7		176994
15	2	83.2	19	1421.8		321885
16	3	93.3	19	1451.7	1520.7	465477
17	2	69.7	19	932.3		14378
18	2	72.1	19	1385.9		159073
19	1	54.8	19			304639
20	3	97.9	19	1634.1	939.1	447875

Unless otherwise stated the results shown in this test report refer only to the sample(s) tested and such sample(s) are retained for 90 days only.

除非另有說明，此報告結果僅對測試之樣品負責，同時此樣品僅保留90天。本報告未經本公司書面許可，不可部份複製。

This document is issued by the Company subject to its General Conditions of Service printed overleaf, available on request or accessible at <http://www.sgs.com.tw/Terms-and-Conditions> and for electronic format documents, subject to Terms and Conditions for Electronic Documents at <http://www.sgs.com.tw/Terms-and-Conditions>. Attention is drawn to the limitation of liability, indemnification and jurisdiction issues defined therein. Any holder of this document is advised that information contained hereon reflects the Company's findings at the time of its intervention only and within the limits of Client's instructions, if any. The Company's sole responsibility is to its Client and this document does not exonerate parties to a transaction from exercising all their rights and obligations under the transaction documents. This document cannot be reproduced except in full, without prior written approval of the Company. Any unauthorized alteration, forgery or falsification of the content or appearance of this document is unlawful and offenders may be prosecuted to the fullest extent of the law.

14.34.17 Trial 17

Data Sheet for FCC Radar Type 5						
Trial Number:		17		VSG Frequency(MHz):		5497.438
Number of Bursts in Trial:			15		Successful Detection: No	
Burst (8-20)	Number Pulses per Burst (1-3)	Pulse Width (50-100)	Chirp Width (5-20)	Pulse 1-to-2 Spacing	Pulse 2-to-3 Spacing	Starting Location Within Interval
		(μ sec)	(MHz)	(μ sec)	(μ sec)	(μ sec)
1	3	98.5	14	1529.5	1540.5	790275
2	2	67.8	14	967.2		188767
3	3	87.2	14	1393.8	1408.8	381473
4	3	94.7	14	1083.3	1702.3	574184
5	2	77.1	14	1188.9		768439
6	3	99.9	14	1371.1	1009.1	164630
7	1	52.2	14			358931
8	1	66	14			552374
9	2	79	14	1802		743959
10	2	77.9	14	1074.1		141116
11	3	92.8	14	1900.2	1228.2	333425
12	2	68.3	14	1261.7		527752
13	2	68.6	14	1277.4		720969
14	1	56.1	14			117503
15	2	79.4	14	997.6		310715

Unless otherwise stated the results shown in this test report refer only to the sample(s) tested and such sample(s) are retained for 90 days only.

除非另有說明，此報告結果僅對測試之樣品負責，同時此樣品僅保留90天。本報告未經本公司書面許可，不可部份複製。

This document is issued by the Company subject to its General Conditions of Service printed overleaf, available on request or accessible at <http://www.sgs.com.tw/Terms-and-Conditions> and for electronic format documents, subject to Terms and Conditions for Electronic Documents at <http://www.sgs.com.tw/Terms-and-Conditions>. Attention is drawn to the limitation of liability, indemnification and jurisdiction issues defined therein. Any holder of this document is advised that information contained hereon reflects the Company's findings at the time of its intervention only and within the limits of Client's instructions, if any. The Company's sole responsibility is to its Client and this document does not exonerate parties to a transaction from exercising all their rights and obligations under the transaction documents. This document cannot be reproduced except in full, without prior written approval of the Company. Any unauthorized alteration, forgery or falsification of the content or appearance of this document is unlawful and offenders may be prosecuted to the fullest extent of the law.

14.34.18 Trial 18

Data Sheet for FCC Radar Type 5						
Trial Number:		18		VSG Frequency(MHz):		5499.038
Number of Bursts in Trial:			19		Successful Detection: Yes	
Burst (8-20)	Number Pulses per Burst (1-3)	Pulse Width (50-100)	Chirp Width (5-20)	Pulse 1-to-2 Spacing	Pulse 2-to-3 Spacing	Starting Location Within Interval
		(μ sec)	(MHz)	(μ sec)	(μ sec)	(μ sec)
1	2	74.7	18	1195.3		397610
2	3	92.2	18	986.8	1411.8	548460
3	1	63.1	18			73913
4	3	89.4	18	1857.6	1340.6	225288
5	1	57.5	18			379635
6	2	69.6	18	1755.4		530955
7	1	62.1	18			55066
8	3	92.3	18	1823.7	1520.7	206531
9	3	90.1	18	1411.9	1426.9	359180
10	2	83.3	18	1525.7		511995
11	2	82.5	18	920.5		36177
12	1	50	18			189009
13	1	56	18			341672
14	3	93.4	18	958.6	1162.6	492876
15	1	57.1	18			17384
16	3	96.9	18	1903.1	1547.1	169257
17	3	95.7	18	1611.3	1631.3	321056
18	3	91.5	18	1837.5	1020.5	473521
19	2	78.5	18	1722.5		626753

Unless otherwise stated the results shown in this test report refer only to the sample(s) tested and such sample(s) are retained for 90 days only.

除非另有說明，此報告結果僅對測試之樣品負責，同時此樣品僅保留90天。本報告未經本公司書面許可，不可部份複製。

This document is issued by the Company subject to its General Conditions of Service printed overleaf, available on request or accessible at <http://www.sgs.com.tw/Terms-and-Conditions> and for electronic format documents, subject to Terms and Conditions for Electronic Documents at <http://www.sgs.com.tw/Terms-and-Conditions>. Attention is drawn to the limitation of liability, indemnification and jurisdiction issues defined therein. Any holder of this document is advised that information contained hereon reflects the Company's findings at the time of its intervention only and within the limits of Client's instructions, if any. The Company's sole responsibility is to its Client and this document does not exonerate parties to a transaction from exercising all their rights and obligations under the transaction documents. This document cannot be reproduced except in full, without prior written approval of the Company. Any unauthorized alteration, forgery or falsification of the content or appearance of this document is unlawful and offenders may be prosecuted to the fullest extent of the law.

14.34.19 Trial 19

Data Sheet for FCC Radar Type 5						
Trial Number:		19		VSG Frequency(MHz):		5499.038
Number of Bursts in Trial:			19		Successful Detection: Yes	
Burst (8-20)	Number Pulses per Burst (1-3)	Pulse Width (50-100)	Chirp Width (5-20)	Pulse 1-to-2 Spacing	Pulse 2-to-3 Spacing	Starting Location Within Interval
		(μ sec)	(MHz)	(μ sec)	(μ sec)	(μ sec)
1	1	64.1	18			151404
2	2	68.7	18	1329.3		303636
3	2	67.7	18	1621.3		455897
4	2	80.9	18	925.1		608478
5	1	53.7	18			132455
6	3	90.7	18	1583.3	965.3	284045
7	1	53.7	18			438429
8	1	60.7	18			591109
9	3	86.6	18	1369.4	1362.4	113150
10	2	70.7	18	1328.3		266125
11	1	62.2	18			419294
12	2	73.9	18	1043.1		571533
13	1	56.5	18			94839
14	1	62.7	18			247847
15	3	98	18	1526	1572	398132
16	1	58.4	18			553311
17	1	51.1	18			76048
18	1	56.6	18			228873
19	2	82.8	18	1720.2		380555

Unless otherwise stated the results shown in this test report refer only to the sample(s) tested and such sample(s) are retained for 90 days only.

除非另有說明，此報告結果僅對測試之樣品負責，同時此樣品僅保留90天。本報告未經本公司書面許可，不可部份複製。

This document is issued by the Company subject to its General Conditions of Service printed overleaf, available on request or accessible at <http://www.sgs.com.tw/Terms-and-Conditions> and for electronic format documents, subject to Terms and Conditions for Electronic Documents at <http://www.sgs.com.tw/Terms-and-Conditions>. Attention is drawn to the limitation of liability, indemnification and jurisdiction issues defined therein. Any holder of this document is advised that information contained hereon reflects the Company's findings at the time of its intervention only and within the limits of Client's instructions, if any. The Company's sole responsibility is to its Client and this document does not exonerate parties to a transaction from exercising all their rights and obligations under the transaction documents. This document cannot be reproduced except in full, without prior written approval of the Company. Any unauthorized alteration, forgery or falsification of the content or appearance of this document is unlawful and offenders may be prosecuted to the fullest extent of the law.

14.34.20 Trial 20

Data Sheet for FCC Radar Type 5						
Trial Number:		20		VSG Frequency(MHz):		5499.038
Number of Bursts in Trial:			19		Successful Detection: No	
Burst (8-20)	Number Pulses per Burst (1-3)	Pulse Width (50-100)	Chirp Width (5-20)	Pulse 1-to-2 Spacing	Pulse 2-to-3 Spacing	Starting Location Within Interval
		(μ sec)	(MHz)	(μ sec)	(μ sec)	(μ sec)
1	3	97.3	18	1385.7	1004.7	532247
2	2	78.3	18	1527.7		57131
3	3	86.3	18	1377.7	941.7	209175
4	2	75.6	18	1300.4		361912
5	3	97.1	18	1425.9	1562.9	512859
6	1	61.3	18			38427
7	3	94.7	18	1832.3	1797.3	189951
8	3	99.9	18	1615.1	1227.1	342491
9	3	96.2	18	1114.8	1128.8	495260
10	2	72.7	18	1002.3		19590
11	2	71.8	18	1446.2		172045
12	2	81.1	18	1817.9		324012
13	3	97.1	18	911.9	1082.9	476328
14	2	76.9	18	1550.1		795
15	3	90.2	18	1815.8	1585.8	152759
16	3	92	18	1261	1695	304775
17	1	60.6	18			459016
18	1	57	18			612493
19	1	61.2	18			134877

Unless otherwise stated the results shown in this test report refer only to the sample(s) tested and such sample(s) are retained for 90 days only.

除非另有說明，此報告結果僅對測試之樣品負責，同時此樣品僅保留90天。本報告未經本公司書面許可，不可部份複製。

This document is issued by the Company subject to its General Conditions of Service printed overleaf, available on request or accessible at <http://www.sgs.com.tw/Terms-and-Conditions> and for electronic format documents, subject to Terms and Conditions for Electronic Documents at <http://www.sgs.com.tw/Terms-and-Conditions>. Attention is drawn to the limitation of liability, indemnification and jurisdiction issues defined therein. Any holder of this document is advised that information contained hereon reflects the Company's findings at the time of its intervention only and within the limits of Client's instructions, if any. The Company's sole responsibility is to its Client and this document does not exonerate parties to a transaction from exercising all their rights and obligations under the transaction documents. This document cannot be reproduced except in full, without prior written approval of the Company. Any unauthorized alteration, forgery or falsification of the content or appearance of this document is unlawful and offenders may be prosecuted to the fullest extent of the law.

14.34.21 Trial 21

Data Sheet for FCC Radar Type 5						
Trial Number:		21		VSG Frequency(MHz):		5523.762
Number of Bursts in Trial:			13		Successful Detection: Yes	
Burst (8-20)	Number Pulses per Burst (1-3)	Pulse Width (50-100)	Chirp Width (5-20)	Pulse 1-to-2 Spacing	Pulse 2-to-3 Spacing	Starting Location Within Interval
		(μ sec)	(MHz)	(μ sec)	(μ sec)	(μ sec)
1	1	59.3	11			420586
2	3	98.7	11	1621.3	1301.3	641808
3	1	53.8	11			867823
4	1	58.9	11			169631
5	2	75.5	11	1554.5		392320
6	2	71.5	11	1535.5		615399
7	2	77.8	11	1860.2		838671
8	1	59.4	11			142128
9	2	76	11	1021		365105
10	3	87.3	11	1224.7	1506.7	587038
11	1	58.1	11			813032
12	3	84.9	11	1098.1	1553.1	114183
13	1	55.9	11			337935

Unless otherwise stated the results shown in this test report refer only to the sample(s) tested and such sample(s) are retained for 90 days only.

除非另有說明，此報告結果僅對測試之樣品負責，同時此樣品僅保留90天。本報告未經本公司書面許可，不可部份複製。

This document is issued by the Company subject to its General Conditions of Service printed overleaf, available on request or accessible at <http://www.sgs.com.tw/Terms-and-Conditions> and for electronic format documents, subject to Terms and Conditions for Electronic Documents at <http://www.sgs.com.tw/Terms-and-Conditions>. Attention is drawn to the limitation of liability, indemnification and jurisdiction issues defined therein. Any holder of this document is advised that information contained hereon reflects the Company's findings at the time of its intervention only and within the limits of Client's instructions, if any. The Company's sole responsibility is to its Client and this document does not exonerate parties to a transaction from exercising all their rights and obligations under the transaction documents. This document cannot be reproduced except in full, without prior written approval of the Company. Any unauthorized alteration, forgery or falsification of the content or appearance of this document is unlawful and offenders may be prosecuted to the fullest extent of the law.

14.34.22 Trial 22

Data Sheet for FCC Radar Type 5						
Trial Number:		22		VSG Frequency(MHz):		5524.162
Number of Bursts in Trial:			12		Successful Detection: Yes	
Burst (8-20)	Number Pulses per Burst (1-3)	Pulse Width (50-100)	Chirp Width (5-20)	Pulse 1-to-2 Spacing	Pulse 2-to-3 Spacing	Starting Location Within Interval
		(μ sec)	(MHz)	(μ sec)	(μ sec)	(μ sec)
1	3	90.2	10	1273.8	1204.8	606736
2	1	62.9	10			850876
3	3	94.2	10	1482.8	1602.8	93968
4	1	50.2	10			336477
5	2	77.8	10	936.2		577757
6	3	93.2	10	1579.8	1677.8	817990
7	2	70.7	10	1139.3		64356
8	2	69.6	10	1677.4		306218
9	1	59.1	10			548542
10	3	90.9	10	1382.1	993.1	788888
11	1	57.5	10			34613
12	3	88.1	10	923.9	1836.9	275921

Unless otherwise stated the results shown in this test report refer only to the sample(s) tested and such sample(s) are retained for 90 days only.

除非另有說明，此報告結果僅對測試之樣品負責，同時此樣品僅保留90天。本報告未經本公司書面許可，不可部份複製。

This document is issued by the Company subject to its General Conditions of Service printed overleaf, available on request or accessible at <http://www.sgs.com.tw/Terms-and-Conditions> and for electronic format documents, subject to Terms and Conditions for Electronic Documents at <http://www.sgs.com.tw/Terms-and-Conditions>. Attention is drawn to the limitation of liability, indemnification and jurisdiction issues defined therein. Any holder of this document is advised that information contained hereon reflects the Company's findings at the time of its intervention only and within the limits of Client's instructions, if any. The Company's sole responsibility is to its Client and this document does not exonerate parties to a transaction from exercising all their rights and obligations under the transaction documents. This document cannot be reproduced except in full, without prior written approval of the Company. Any unauthorized alteration, forgery or falsification of the content or appearance of this document is unlawful and offenders may be prosecuted to the fullest extent of the law.

14.34.23 Trial 23

Data Sheet for FCC Radar Type 5						
Trial Number:		23		VSG Frequency(MHz):		5522.562
Number of Bursts in Trial:			15		Successful Detection: No	
Burst (8-20)	Number Pulses per Burst (1-3)	Pulse Width (50-100)	Chirp Width (5-20)	Pulse 1-to-2 Spacing	Pulse 2-to-3 Spacing	Starting Location Within Interval
		(μ sec)	(MHz)	(μ sec)	(μ sec)	(μ sec)
1	1	64.7	14			415120
2	3	89.6	14	1085.4	1597.4	606453
3	1	65.2	14			3836
4	3	97.1	14	1273.9	1796.9	196765
5	1	66.3	14			391306
6	2	70.7	14	1892.3		583184
7	3	87.3	14	1673.7	1200.7	775695
8	1	51.4	14			173646
9	3	90	14	998	1587	366139
10	3	97.3	14	1723.7	1681.7	558113
11	3	84.2	14	1194.8	1188.8	752330
12	3	93.5	14	1780.5	1458.5	149161
13	2	69.3	14	1497.7		342569
14	1	60.7	14			537050
15	1	54	14			730970

Unless otherwise stated the results shown in this test report refer only to the sample(s) tested and such sample(s) are retained for 90 days only.

除非另有說明，此報告結果僅對測試之樣品負責，同時此樣品僅保留90天。本報告未經本公司書面許可，不可部份複製。

This document is issued by the Company subject to its General Conditions of Service printed overleaf, available on request or accessible at <http://www.sgs.com.tw/Terms-and-Conditions> and for electronic format documents, subject to Terms and Conditions for Electronic Documents at <http://www.sgs.com.tw/Terms-and-Conditions>. Attention is drawn to the limitation of liability, indemnification and jurisdiction issues defined therein. Any holder of this document is advised that information contained hereon reflects the Company's findings at the time of its intervention only and within the limits of Client's instructions, if any. The Company's sole responsibility is to its Client and this document does not exonerate parties to a transaction from exercising all their rights and obligations under the transaction documents. This document cannot be reproduced except in full, without prior written approval of the Company. Any unauthorized alteration, forgery or falsification of the content or appearance of this document is unlawful and offenders may be prosecuted to the fullest extent of the law.

14.34.24 Trial 24

Data Sheet for FCC Radar Type 5						
Trial Number:		24		VSG Frequency(MHz):		5520.562
Number of Bursts in Trial:			20		Successful Detection: Yes	
Burst (8-20)	Number Pulses per Burst (1-3)	Pulse Width (50-100)	Chirp Width (5-20)	Pulse 1-to-2 Spacing	Pulse 2-to-3 Spacing	Starting Location Within Interval
		(μ sec)	(MHz)	(μ sec)	(μ sec)	(μ sec)
1	2	69.3	19	1293.7		94192
2	1	51.9	19			239745
3	2	68.6	19	1582.4		383859
4	1	62.5	19			529765
5	3	88.1	19	915.9	1048.9	76228
6	3	87.8	19	1104.2	1140.2	220653
7	1	65.8	19			366886
8	3	90.9	19	1123.1	1324.1	509849
9	3	84.2	19	1904.8	1361.8	58326
10	2	82.8	19	1605.2		203265
11	3	90	19	1177	1126	347500
12	1	64.1	19			494229
13	2	67.4	19	1012.6		40688
14	3	86.4	19	1558.6	1100.6	185058
15	3	91.7	19	1461.3	1772.3	329175
16	1	50.2	19			476294
17	1	57.7	19			22880
18	3	96.3	19	1617.7	1315.7	167054
19	2	70.9	19	1872.1		311966
20	1	60.7	19			458616

Unless otherwise stated the results shown in this test report refer only to the sample(s) tested and such sample(s) are retained for 90 days only.

除非另有說明，此報告結果僅對測試之樣品負責，同時此樣品僅保留90天。本報告未經本公司書面許可，不可部份複製。

This document is issued by the Company subject to its General Conditions of Service printed overleaf, available on request or accessible at <http://www.sgs.com.tw/Terms-and-Conditions> and for electronic format documents, subject to Terms and Conditions for Electronic Documents at <http://www.sgs.com.tw/Terms-and-Conditions>. Attention is drawn to the limitation of liability, indemnification and jurisdiction issues defined therein. Any holder of this document is advised that information contained hereon reflects the Company's findings at the time of its intervention only and within the limits of Client's instructions, if any. The Company's sole responsibility is to its Client and this document does not exonerate parties to a transaction from exercising all their rights and obligations under the transaction documents. This document cannot be reproduced except in full, without prior written approval of the Company. Any unauthorized alteration, forgery or falsification of the content or appearance of this document is unlawful and offenders may be prosecuted to the fullest extent of the law.

14.34.25 Trial 25

Data Sheet for FCC Radar Type 5						
Trial Number:		25		VSG Frequency(MHz):		5520.162
Number of Bursts in Trial:			20		Successful Detection: Yes	
Burst (8-20)	Number Pulses per Burst (1-3)	Pulse Width (50-100)	Chirp Width (5-20)	Pulse 1-to-2 Spacing	Pulse 2-to-3 Spacing	Starting Location Within Interval
		(μ sec)	(MHz)	(μ sec)	(μ sec)	(μ sec)
1	2	81.9	20	1747.1		4972
2	1	62.6	20			150270
3	1	62.4	20			295146
4	1	59.6	20			440705
5	1	66.6	20			585945
6	2	70.9	20	1927.1		131840
7	3	83.4	20	1273.6	1651.6	275953
8	1	66	20			422341
9	3	93	20	1287	1229	565394
10	2	78.7	20	1908.3		113975
11	1	50.6	20			259629
12	2	80.9	20	1405.1		403645
13	2	67	20	1119		548813
14	3	89.2	20	1509.8	1008.8	96014
15	1	51.4	20			241566
16	2	67.6	20	1374.4		386144
17	3	90.5	20	1318.5	1145.5	529515
18	2	78.4	20	1374.6		78447
19	2	69.5	20	1465.5		223236
20	1	50.2	20			368841

Unless otherwise stated the results shown in this test report refer only to the sample(s) tested and such sample(s) are retained for 90 days only.

除非另有說明，此報告結果僅對測試之樣品負責，同時此樣品僅保留90天。本報告未經本公司書面許可，不可部份複製。

This document is issued by the Company subject to its General Conditions of Service printed overleaf, available on request or accessible at <http://www.sgs.com.tw/Terms-and-Conditions> and for electronic format documents, subject to Terms and Conditions for Electronic Documents at <http://www.sgs.com.tw/Terms-and-Conditions>. Attention is drawn to the limitation of liability, indemnification and jurisdiction issues defined therein. Any holder of this document is advised that information contained hereon reflects the Company's findings at the time of its intervention only and within the limits of Client's instructions, if any. The Company's sole responsibility is to its Client and this document does not exonerate parties to a transaction from exercising all their rights and obligations under the transaction documents. This document cannot be reproduced except in full, without prior written approval of the Company. Any unauthorized alteration, forgery or falsification of the content or appearance of this document is unlawful and offenders may be prosecuted to the fullest extent of the law.

14.34.26 Trial 26

Data Sheet for FCC Radar Type 5						
Trial Number:		26		VSG Frequency(MHz):		5520.962
Number of Bursts in Trial:			18		Successful Detection: Yes	
Burst (8-20)	Number Pulses per Burst (1-3)	Pulse Width (50-100)	Chirp Width (5-20)	Pulse 1-to-2 Spacing	Pulse 2-to-3 Spacing	Starting Location Within Interval
		(μ sec)	(MHz)	(μ sec)	(μ sec)	(μ sec)
1	3	98.9	18	1308.1	1758.1	568650
2	3	98.7	18	1695.3	1690.3	67123
3	2	81	18	929		228397
4	1	64.3	18			390410
5	2	76.4	18	1343.6		550359
6	1	56.5	18			47616
7	2	69.8	18	1199.2		208712
8	1	65.1	18			370179
9	3	98.3	18	1534.7	1270.7	528943
10	3	97	18	1717	1581	27624
11	2	76.4	18	1683.6		188468
12	3	97.3	18	1588.7	1219.7	348918
13	3	98.5	18	1611.5	1263.5	509458
14	3	100	18	1471	1010	7870
15	2	72.1	18	1282.9		168818
16	1	56.6	18			330451
17	3	89.6	18	1459.4	1814.4	489199
18	1	59	18			653547

Unless otherwise stated the results shown in this test report refer only to the sample(s) tested and such sample(s) are retained for 90 days only.

除非另有說明，此報告結果僅對測試之樣品負責，同時此樣品僅保留90天。本報告未經本公司書面許可，不可部份複製。

This document is issued by the Company subject to its General Conditions of Service printed overleaf, available on request or accessible at <http://www.sgs.com.tw/Terms-and-Conditions> and for electronic format documents, subject to Terms and Conditions for Electronic Documents at <http://www.sgs.com.tw/Terms-and-Conditions>. Attention is drawn to the limitation of liability, indemnification and jurisdiction issues defined therein. Any holder of this document is advised that information contained hereon reflects the Company's findings at the time of its intervention only and within the limits of Client's instructions, if any. The Company's sole responsibility is to its Client and this document does not exonerate parties to a transaction from exercising all their rights and obligations under the transaction documents. This document cannot be reproduced except in full, without prior written approval of the Company. Any unauthorized alteration, forgery or falsification of the content or appearance of this document is unlawful and offenders may be prosecuted to the fullest extent of the law.

14.34.27 Trial 27

Data Sheet for FCC Radar Type 5						
Trial Number:		27		VSG Frequency(MHz):		5524.562
Number of Bursts in Trial:			11		Successful Detection: Yes	
Burst (8-20)	Number Pulses per Burst (1-3)	Pulse Width (50-100)	Chirp Width (5-20)	Pulse 1-to-2 Spacing	Pulse 2-to-3 Spacing	Starting Location Within Interval
		(μ sec)	(MHz)	(μ sec)	(μ sec)	(μ sec)
1	3	96	9	964	1269	244138
2	2	67.1	9	1167.9		508034
3	1	54.3	9			772920
4	3	99.9	9	1046.1	1220.1	1035183
5	3	98	9	1600	940	211483
6	1	55.5	9			476199
7	2	82.1	9	1539.9		739691
8	1	59.1	9			1005073
9	3	97.1	9	1569.9	1053.9	179037
10	2	78.3	9	1685.7		442966
11	3	85	9	1745	1510	705622

Unless otherwise stated the results shown in this test report refer only to the sample(s) tested and such sample(s) are retained for 90 days only.

除非另有說明，此報告結果僅對測試之樣品負責，同時此樣品僅保留90天。本報告未經本公司書面許可，不可部份複製。

This document is issued by the Company subject to its General Conditions of Service printed overleaf, available on request or accessible at <http://www.sgs.com.tw/Terms-and-Conditions> and for electronic format documents, subject to Terms and Conditions for Electronic Documents at <http://www.sgs.com.tw/Terms-and-Conditions>. Attention is drawn to the limitation of liability, indemnification and jurisdiction issues defined therein. Any holder of this document is advised that information contained hereon reflects the Company's findings at the time of its intervention only and within the limits of Client's instructions, if any. The Company's sole responsibility is to its Client and this document does not exonerate parties to a transaction from exercising all their rights and obligations under the transaction documents. This document cannot be reproduced except in full, without prior written approval of the Company. Any unauthorized alteration, forgery or falsification of the content or appearance of this document is unlawful and offenders may be prosecuted to the fullest extent of the law.

14.34.28 Trial 28

Data Sheet for FCC Radar Type 5						
Trial Number:		28		VSG Frequency(MHz):		5521.362
Number of Bursts in Trial:			18		Successful Detection: Yes	
Burst (8-20)	Number Pulses per Burst (1-3)	Pulse Width (50-100)	Chirp Width (5-20)	Pulse 1-to-2 Spacing	Pulse 2-to-3 Spacing	Starting Location Within Interval
		(μ sec)	(MHz)	(μ sec)	(μ sec)	(μ sec)
1	2	74	17	1226		592566
2	1	59.8	17			89732
3	2	79.3	17	1839.7		250502
4	2	76.7	17	1083.3		411804
5	2	70.6	17	1421.4		572049
6	1	61.8	17			69871
7	2	83.2	17	1608.8		230717
8	2	81.7	17	1839.3		391658
9	3	98.1	17	1843.9	1145.9	551342
10	2	83.3	17	1716.7		49863
11	1	60	17			211312
12	1	51	17			372850
13	2	68.2	17	1899.8		532734
14	2	67.8	17	1688.2		30024
15	3	96	17	1446	1613	190604
16	1	52.3	17			352547
17	1	53.4	17			513835
18	2	82.4	17	1680.6		10225

Unless otherwise stated the results shown in this test report refer only to the sample(s) tested and such sample(s) are retained for 90 days only.

除非另有說明，此報告結果僅對測試之樣品負責，同時此樣品僅保留90天。本報告未經本公司書面許可，不可部份複製。

This document is issued by the Company subject to its General Conditions of Service printed overleaf, available on request or accessible at <http://www.sgs.com.tw/Terms-and-Conditions> and for electronic format documents, subject to Terms and Conditions for Electronic Documents at <http://www.sgs.com.tw/Terms-and-Conditions>. Attention is drawn to the limitation of liability, indemnification and jurisdiction issues defined therein. Any holder of this document is advised that information contained hereon reflects the Company's findings at the time of its intervention only and within the limits of Client's instructions, if any. The Company's sole responsibility is to its Client and this document does not exonerate parties to a transaction from exercising all their rights and obligations under the transaction documents. This document cannot be reproduced except in full, without prior written approval of the Company. Any unauthorized alteration, forgery or falsification of the content or appearance of this document is unlawful and offenders may be prosecuted to the fullest extent of the law.

14.34.29 Trial 29

Data Sheet for FCC Radar Type 5						
Trial Number:		29		VSG Frequency(MHz):		5525.762
Number of Bursts in Trial:			8		Successful Detection: Yes	
Burst (8-20)	Number Pulses per Burst (1-3)	Pulse Width (50-100)	Chirp Width (5-20)	Pulse 1-to-2 Spacing	Pulse 2-to-3 Spacing	Starting Location Within Interval
		(μ sec)	(MHz)	(μ sec)	(μ sec)	(μ sec)
1	2	67	6	1136		386176
2	2	67	6	975		749473
3	3	94.8	6	946.2	1399.2	1111261
4	2	78.1	6	1873.9		1475197
5	2	81.4	6	1855.6		341314
6	2	82.5	6	1477.5		704354
7	1	52.3	6			1068403
8	3	95.9	6	1723.1	1465.1	1429278

Unless otherwise stated the results shown in this test report refer only to the sample(s) tested and such sample(s) are retained for 90 days only.

除非另有說明，此報告結果僅對測試之樣品負責，同時此樣品僅保留90天。本報告未經本公司書面許可，不可部份複製。

This document is issued by the Company subject to its General Conditions of Service printed overleaf, available on request or accessible at <http://www.sgs.com.tw/Terms-and-Conditions> and for electronic format documents, subject to Terms and Conditions for Electronic Documents at <http://www.sgs.com.tw/Terms-and-Conditions>. Attention is drawn to the limitation of liability, indemnification and jurisdiction issues defined therein. Any holder of this document is advised that information contained hereon reflects the Company's findings at the time of its intervention only and within the limits of Client's instructions, if any. The Company's sole responsibility is to its Client and this document does not exonerate parties to a transaction from exercising all their rights and obligations under the transaction documents. This document cannot be reproduced except in full, without prior written approval of the Company. Any unauthorized alteration, forgery or falsification of the content or appearance of this document is unlawful and offenders may be prosecuted to the fullest extent of the law.

14.34.30 Trial 30

Data Sheet for FCC Radar Type 5						
Trial Number:		30		VSG Frequency(MHz):		5521.362
Number of Bursts in Trial:			18		Successful Detection: Yes	
Burst (8-20)	Number Pulses per Burst (1-3)	Pulse Width (50-100)	Chirp Width (5-20)	Pulse 1-to-2 Spacing	Pulse 2-to-3 Spacing	Starting Location Within Interval
		(μ sec)	(MHz)	(μ sec)	(μ sec)	(μ sec)
1	3	99.1	17	1050.9	1191.9	131268
2	1	50.7	17			293150
3	2	75.5	17	1479.5		453485
4	2	82.2	17	1702.8		613895
5	2	67.3	17	1725.7		111637
6	1	59.4	17			273119
7	3	91.5	17	1718.5	1057.5	432670
8	2	80.2	17	1136.8		594976
9	2	74.2	17	975.8		91921
10	3	87.2	17	1141.8	1835.8	252079
11	3	97.2	17	1803.8	1028.8	413002
12	2	70.5	17	1487.5		574498
13	2	77.9	17	1638.1		71981
14	3	88.2	17	1134.8	1636.8	232616
15	3	88.9	17	1484.1	1059.1	393436
16	2	74.9	17	1917.1		554812
17	3	91.5	17	1591.5	1728.5	52089
18	2	75.8	17	1480.2		213172

Unless otherwise stated the results shown in this test report refer only to the sample(s) tested and such sample(s) are retained for 90 days only.

除非另有說明，此報告結果僅對測試之樣品負責，同時此樣品僅保留90天。本報告未經本公司書面許可，不可部份複製。

This document is issued by the Company subject to its General Conditions of Service printed overleaf, available on request or accessible at <http://www.sgs.com.tw/Terms-and-Conditions> and for electronic format documents, subject to Terms and Conditions for Electronic Documents at <http://www.sgs.com.tw/Terms-and-Conditions>. Attention is drawn to the limitation of liability, indemnification and jurisdiction issues defined therein. Any holder of this document is advised that information contained hereon reflects the Company's findings at the time of its intervention only and within the limits of Client's instructions, if any. The Company's sole responsibility is to its Client and this document does not exonerate parties to a transaction from exercising all their rights and obligations under the transaction documents. This document cannot be reproduced except in full, without prior written approval of the Company. Any unauthorized alteration, forgery or falsification of the content or appearance of this document is unlawful and offenders may be prosecuted to the fullest extent of the law.

14.35 Radar Type 6 for 5510 MHz:

Data Sheet for FCC Radar Type 6						
Trial	Pulse Width	PRI	Pulses per Hop	Hopping Rate	Hopping Sequence Length	Successful Detection
	(μ sec)	(μ sec)		(kHz)	(msec)	(Yes/No)
1	1	333	9	0.333	300	Yes
2	1	333	9	0.333	300	Yes
3	1	333	9	0.333	300	Yes
4	1	333	9	0.333	300	Yes
5	1	333	9	0.333	300	Yes
6	1	333	9	0.333	300	Yes
7	1	333	9	0.333	300	Yes
8	1	333	9	0.333	300	Yes
9	1	333	9	0.333	300	Yes
10	1	333	9	0.333	300	Yes
11	1	333	9	0.333	300	Yes
12	1	333	9	0.333	300	Yes
13	1	333	9	0.333	300	Yes
14	1	333	9	0.333	300	Yes
15	1	333	9	0.333	300	Yes
16	1	333	9	0.333	300	Yes
17	1	333	9	0.333	300	Yes
18	1	333	9	0.333	300	Yes
19	1	333	9	0.333	300	Yes
20	1	333	9	0.333	300	Yes
21	1	333	9	0.333	300	Yes
22	1	333	9	0.333	300	Yes
23	1	333	9	0.333	300	Yes
24	1	333	9	0.333	300	Yes
25	1	333	9	0.333	300	Yes
26	1	333	9	0.333	300	Yes
27	1	333	9	0.333	300	Yes
28	1	333	9	0.333	300	Yes
29	1	333	9	0.333	300	Yes
30	1	333	9	0.333	300	Yes

Unless otherwise stated the results shown in this test report refer only to the sample(s) tested and such sample(s) are retained for 90 days only.

除非另有說明，此報告結果僅對測試之樣品負責，同時此樣品僅保留90天。本報告未經本公司書面許可，不可部份複製。

This document is issued by the Company subject to its General Conditions of Service printed overleaf, available on request or accessible at <http://www.sgs.com.tw/Terms-and-Conditions> and for electronic format documents, subject to Terms and Conditions for Electronic Documents at <http://www.sgs.com.tw/Terms-and-Conditions>. Attention is drawn to the limitation of liability, indemnification and jurisdiction issues defined therein. Any holder of this document is advised that information contained hereon reflects the Company's findings at the time of its intervention only and within the limits of Client's instructions, if any. The Company's sole responsibility is to its Client and this document does not exonerate parties to a transaction from exercising all their rights and obligations under the transaction documents. This document cannot be reproduced except in full, without prior written approval of the Company. Any unauthorized alteration, forgery or falsification of the content or appearance of this document is unlawful and offenders may be prosecuted to the fullest extent of the law.

14.36 5530 MHz

Short Pulse Radar Type	Minimum Number of Trials	Detection(%)		Minimum Percentage of Successful Detection(%)	Pass/Fail
1	30	83.33		60	Pass
2	30	93.33		60	Pass
3	30	96.67		60	Pass
4	30	90		60	Pass
Aggregate (Radar Types 1-4)	120	90.8325		80	Pass
Long Pulse Radar Type	Minimum Number of Trials	Each Detection(%)	Total Detection(%)	Minimum Percentage of Successful Detection(%)	Pass/Fail
5	Center:10	100	100	80	Pass
	Low Edge:10	100			
	High Edge:10	100			
Frequency Hopping Radar Type	Minimum Number of Trials	Detection(%)		Minimum Percentage of Successful Detection(%)	Pass/Fail
6	30	100		70	Pass

Unless otherwise stated the results shown in this test report refer only to the sample(s) tested and such sample(s) are retained for 90 days only.

除非另有說明，此報告結果僅對測試之樣品負責，同時此樣品僅保留90天。本報告未經本公司書面許可，不可部份複製。

This document is issued by the Company subject to its General Conditions of Service printed overleaf, available on request or accessible at <http://www.sgs.com.tw/Terms-and-Conditions> and for electronic format documents, subject to Terms and Conditions for Electronic Documents at <http://www.sgs.com.tw/Terms-and-Conditions>. Attention is drawn to the limitation of liability, indemnification and jurisdiction issues defined therein. Any holder of this document is advised that information contained hereon reflects the Company's findings at the time of its intervention only and within the limits of Client's instructions, if any. The Company's sole responsibility is to its Client and this document does not exonerate parties to a transaction from exercising all their rights and obligations under the transaction documents. This document cannot be reproduced except in full, without prior written approval of the Company. Any unauthorized alteration, forgery or falsification of the content or appearance of this document is unlawful and offenders may be prosecuted to the fullest extent of the law.

14.37 Radar Type 1 for 5530 MHz:

Data Sheet for FCC Radar Type 1						
Trial	VSG Frequency (MHz)	Pulse Repetition Frequency	Pulse Repetition Frequency	PRI	Test A/B	Successful Detection
		Number (1 to 23)	(Pulses Per Second)	(msec)	A/B	(Yes/No)
1	5530	16	1222.5	818	A	Yes
2	5530	12	1355	738	A	Yes
3	5530	11	1392.8	718	A	Yes
4	5530	17	1193.3	838	A	Yes
5	5530	9	1474.9	678	A	Yes
6	5530	10	1432.7	698	A	Yes
7	5530	4	1730.1	578	A	Yes
8	5530	15	1253.1	798	A	Yes
9	5530	8	1519.8	658	A	Yes
10	5530	5	1672.2	598	A	Yes
11	5530	20	1113.6	898	A	Yes
12	5530	3	1792.1	558	A	Yes
13	5530	13	1319.3	758	A	Yes
14	5530	2	1858.7	538	A	Yes
15	5530	19	1139	878	A	Yes
16	5530	-	755.3	1324	B	Yes
17	5530	-	336.5	2972	B	No
18	5530	-	445	2247	B	No
19	5530	-	628.1	1592	B	No
20	5530	-	546.1	1831	B	Yes
21	5530	-	901.7	1109	B	Yes
22	5530	-	646	1548	B	No
23	5530	-	327.5	3053	B	Yes
24	5530	-	847.5	1180	B	Yes
25	5530	-	378.9	2639	B	Yes
26	5530	-	679.3	1472	B	Yes
27	5530	-	356.5	2805	B	No
28	5530	-	1100.1	909	B	Yes
29	5530	-	512.6	1951	B	Yes
30	5530	-	1179.2	848	B	Yes

Unless otherwise stated the results shown in this test report refer only to the sample(s) tested and such sample(s) are retained for 90 days only.

除非另有說明，此報告結果僅對測試之樣品負責，同時此樣品僅保留90天。本報告未經本公司書面許可，不可部份複製。

This document is issued by the Company subject to its General Conditions of Service printed overleaf, available on request or accessible at <http://www.sgs.com.tw/Terms-and-Conditions> and for electronic format documents, subject to Terms and Conditions for Electronic Documents at <http://www.sgs.com.tw/Terms-and-Conditions>. Attention is drawn to the limitation of liability, indemnification and jurisdiction issues defined therein. Any holder of this document is advised that information contained hereon reflects the Company's findings at the time of its intervention only and within the limits of Client's instructions, if any. The Company's sole responsibility is to its Client and this document does not exonerate parties to a transaction from exercising all their rights and obligations under the transaction documents. This document cannot be reproduced except in full, without prior written approval of the Company. Any unauthorized alteration, forgery or falsification of the content or appearance of this document is unlawful and offenders may be prosecuted to the fullest extent of the law.

14.38 Radar Type 2 for 5530 MHz:

Data Sheet for FCC Radar Type 2

Trial	VSG Frequency (MHz)	Number Pulses per Burst (23-29)	Pulse Width (1-5)	PRI (150-230)	Successful Detection
			(μ s)	(μ s)	(Yes/No)
1	5530	25	2.2	191	No
2	5530	26	3.3	186	Yes
3	5530	29	4.8	227	Yes
4	5530	29	5	185	Yes
5	5530	25	2.1	222	Yes
6	5530	28	4.5	175	Yes
7	5530	28	4	190	Yes
8	5530	23	1.1	220	Yes
9	5530	28	4.1	213	Yes
10	5530	23	1.1	223	Yes
11	5530	25	2.5	157	Yes
12	5530	26	2.8	217	Yes
13	5530	24	1.7	216	Yes
14	5530	24	1.6	179	Yes
15	5530	26	2.8	155	Yes
16	5530	25	2.7	196	Yes
17	5530	24	1.6	152	Yes
18	5530	25	2.2	170	Yes
19	5530	24	1.6	188	Yes
20	5530	24	1.7	178	Yes
21	5530	26	2.7	192	Yes
22	5530	24	2.1	197	No
23	5530	25	2.3	180	Yes
24	5530	23	1.2	221	Yes
25	5530	26	2.9	207	Yes
26	5530	27	3.7	209	Yes
27	5530	29	4.8	229	Yes
28	5530	29	5	212	Yes
29	5530	29	4.9	176	Yes
30	5530	27	3.4	160	Yes

Unless otherwise stated the results shown in this test report refer only to the sample(s) tested and such sample(s) are retained for 90 days only.

除非另有說明，此報告結果僅對測試之樣品負責，同時此樣品僅保留90天。本報告未經本公司書面許可，不可部份複製。

This document is issued by the Company subject to its General Conditions of Service printed overleaf, available on request or accessible at <http://www.sgs.com.tw/Terms-and-Conditions> and for electronic format documents, subject to Terms and Conditions for Electronic Documents at <http://www.sgs.com.tw/Terms-and-Conditions>. Attention is drawn to the limitation of liability, indemnification and jurisdiction issues defined therein. Any holder of this document is advised that information contained hereon reflects the Company's findings at the time of its intervention only and within the limits of Client's instructions, if any. The Company's sole responsibility is to its Client and this document does not exonerate parties to a transaction from exercising all their rights and obligations under the transaction documents. This document cannot be reproduced except in full, without prior written approval of the Company. Any unauthorized alteration, forgery or falsification of the content or appearance of this document is unlawful and offenders may be prosecuted to the fullest extent of the law.

14.39 Radar Type 3 for 5530 MHz:

Data Sheet for FCC Radar Type 3

Trial	VSG Frequency (MHz)	Number Pulses per Burst (16-18)	Pulse Width (6-10)	PRI (200-500)	Successful Detection
			(μ s)	(μ s)	(Yes/No)
1	5530	16	7.2	379	No
2	5530	17	8.3	353	Yes
3	5530	18	9.8	462	Yes
4	5530	18	10	428	Yes
5	5530	16	7.1	354	Yes
6	5530	18	9.5	222	Yes
7	5530	18	9	364	Yes
8	5530	16	6.1	217	Yes
9	5530	18	9.1	387	Yes
10	5530	16	6.1	433	Yes
11	5530	17	7.5	246	Yes
12	5530	17	7.8	231	Yes
13	5530	16	6.7	228	Yes
14	5530	16	6.6	375	Yes
15	5530	17	7.8	304	Yes
16	5530	17	7.7	215	Yes
17	5530	16	6.6	500	Yes
18	5530	16	7.2	401	Yes
19	5530	16	6.6	216	Yes
20	5530	16	6.7	251	Yes
21	5530	17	7.7	202	Yes
22	5530	16	7.1	461	Yes
23	5530	16	7.3	267	Yes
24	5530	16	6.2	227	Yes
25	5530	17	7.9	362	Yes
26	5530	18	8.7	358	Yes
27	5530	18	9.8	204	Yes
28	5530	18	10	219	Yes
29	5530	18	9.9	315	Yes
30	5530	17	8.4	351	Yes

Unless otherwise stated the results shown in this test report refer only to the sample(s) tested and such sample(s) are retained for 90 days only.

除非另有說明，此報告結果僅對測試之樣品負責，同時此樣品僅保留90天。本報告未經本公司書面許可，不可部份複製。

This document is issued by the Company subject to its General Conditions of Service printed overleaf, available on request or accessible at <http://www.sgs.com.tw/Terms-and-Conditions> and for electronic format documents, subject to Terms and Conditions for Electronic Documents at <http://www.sgs.com.tw/Terms-and-Conditions>. Attention is drawn to the limitation of liability, indemnification and jurisdiction issues defined therein. Any holder of this document is advised that information contained hereon reflects the Company's findings at the time of its intervention only and within the limits of Client's instructions, if any. The Company's sole responsibility is to its Client and this document does not exonerate parties to a transaction from exercising all their rights and obligations under the transaction documents. This document cannot be reproduced except in full, without prior written approval of the Company. Any unauthorized alteration, forgery or falsification of the content or appearance of this document is unlawful and offenders may be prosecuted to the fullest extent of the law.

14.40 Radar Type 4 for 5530 MHz:

Data Sheet for FCC Radar Type 4

Trial	VSG Frequency (MHz)	Number Pulses per Burst (12-16)	Pulse Width (11-20)	PRI (200-500)	Successful Detection
			(μ s)	(μ s)	(Yes/No)
1	5530	13	13.8	379	Yes
2	5530	14	16.1	353	Yes
3	5530	16	19.6	462	Yes
4	5530	16	19.9	428	No
5	5530	13	13.6	354	Yes
6	5530	16	18.7	222	Yes
7	5530	15	17.7	364	Yes
8	5530	12	11.2	217	Yes
9	5530	15	17.9	387	Yes
10	5530	12	11.3	433	No
11	5530	13	14.4	246	Yes
12	5530	14	15	231	Yes
13	5530	12	12.7	228	Yes
14	5530	12	12.4	375	Yes
15	5530	14	15	304	Yes
16	5530	14	14.8	215	Yes
17	5530	12	12.3	500	Yes
18	5530	13	13.7	401	Yes
19	5530	12	12.4	216	Yes
20	5530	12	12.7	251	Yes
21	5530	14	14.9	202	No
22	5530	13	13.4	461	Yes
23	5530	13	14	267	Yes
24	5530	12	11.4	227	Yes
25	5530	14	15.3	362	Yes
26	5530	15	17.1	358	Yes
27	5530	16	19.5	204	Yes
28	5530	16	20	219	Yes
29	5530	16	19.7	315	Yes
30	5530	14	16.4	351	Yes

Unless otherwise stated the results shown in this test report refer only to the sample(s) tested and such sample(s) are retained for 90 days only.

除非另有說明，此報告結果僅對測試之樣品負責，同時此樣品僅保留90天。本報告未經本公司書面許可，不可部份複製。

This document is issued by the Company subject to its General Conditions of Service printed overleaf, available on request or accessible at <http://www.sgs.com.tw/Terms-and-Conditions> and for electronic format documents, subject to Terms and Conditions for Electronic Documents at <http://www.sgs.com.tw/Terms-and-Conditions>. Attention is drawn to the limitation of liability, indemnification and jurisdiction issues defined therein. Any holder of this document is advised that information contained hereon reflects the Company's findings at the time of its intervention only and within the limits of Client's instructions, if any. The Company's sole responsibility is to its Client and this document does not exonerate parties to a transaction from exercising all their rights and obligations under the transaction documents. This document cannot be reproduced except in full, without prior written approval of the Company. Any unauthorized alteration, forgery or falsification of the content or appearance of this document is unlawful and offenders may be prosecuted to the fullest extent of the law.

14.41 Radar Type 5 for 5530 MHz:

14.41.1 Trial 1:

Data Sheet for FCC Radar Type 5						
Trial Number:		1		VSG Frequency(MHz):		5530
Number of Bursts in Trial:			14		Successful Detection: Yes	
Burst (8-20)	Number Pulses per Burst (1-3)	Pulse Width (50-100)	Chirp Width (5-20)	Pulse 1-to-2 Spacing	Pulse 2-to-3 Spacing	Starting Location Within Interval
		(μ sec)	(MHz)	(μ sec)	(μ sec)	(μ sec)
1	2	75.7	13	1450.3		646095
2	2	76.2	13	1835.8		853391
3	3	98.6	13	1660.4	1151.4	206260
4	1	60	13			414310
5	3	88.3	13	1410.7	982.7	620248
6	1	52	13			829565
7	3	92.7	13	1451.3	1091.3	180697
8	3	84.5	13	1906.5	1481.5	387097
9	2	79.4	13	1230.6		595173
10	3	86.3	13	1491.7	1529.7	801190
11	1	52.5	13			155846
12	1	65.8	13			363169
13	1	51.8	13			570697
14	3	96.5	13	919.5	1148.5	776534

Unless otherwise stated the results shown in this test report refer only to the sample(s) tested and such sample(s) are retained for 90 days only.

除非另有說明，此報告結果僅對測試之樣品負責，同時此樣品僅保留90天。本報告未經本公司書面許可，不可部份複製。

This document is issued by the Company subject to its General Conditions of Service printed overleaf, available on request or accessible at <http://www.sgs.com.tw/Terms-and-Conditions> and for electronic format documents, subject to Terms and Conditions for Electronic Documents at <http://www.sgs.com.tw/Terms-and-Conditions>. Attention is drawn to the limitation of liability, indemnification and jurisdiction issues defined therein. Any holder of this document is advised that information contained hereon reflects the Company's findings at the time of its intervention only and within the limits of Client's instructions, if any. The Company's sole responsibility is to its Client and this document does not exonerate parties to a transaction from exercising all their rights and obligations under the transaction documents. This document cannot be reproduced except in full, without prior written approval of the Company. Any unauthorized alteration, forgery or falsification of the content or appearance of this document is unlawful and offenders may be prosecuted to the fullest extent of the law.

14.41.2 Trial 2:

Data Sheet for FCC Radar Type 5						
Trial Number:		2		VSG Frequency(MHz):		5530
Number of Bursts in Trial:			14		Successful Detection: Yes	
Burst (8-20)	Number Pulses per Burst (1-3)	Pulse Width (50-100)	Chirp Width (5-20)	Pulse 1-to-2 Spacing	Pulse 2-to-3 Spacing	Starting Location Within Interval
		(μ sec)	(MHz)	(μ sec)	(μ sec)	(μ sec)
1	3	89.7	13	1178.3	976.3	129878
2	3	96.5	13	1823.5	1552.5	336196
3	2	78.6	13	1730.4		544288
4	3	92.6	13	1348.4	1150.4	750076
5	3	92.6	13	1533.4	1761.4	104294
6	3	93	13	1878	1609	310994
7	2	70.3	13	1860.7		518416
8	1	66	13			727353
9	2	78.7	13	1898.3		78905
10	3	96.3	13	954.7	1546.7	285586
11	3	97.7	13	1410.3	1595.3	492469
12	3	92.3	13	1052.7	1690.7	699494
13	1	65.3	13			53555
14	3	88.9	13	1411.1	1716.1	260074

Unless otherwise stated the results shown in this test report refer only to the sample(s) tested and such sample(s) are retained for 90 days only.

除非另有說明，此報告結果僅對測試之樣品負責，同時此樣品僅保留90天。本報告未經本公司書面許可，不可部份複製。

This document is issued by the Company subject to its General Conditions of Service printed overleaf, available on request or accessible at <http://www.sgs.com.tw/Terms-and-Conditions> and for electronic format documents, subject to Terms and Conditions for Electronic Documents at <http://www.sgs.com.tw/Terms-and-Conditions>. Attention is drawn to the limitation of liability, indemnification and jurisdiction issues defined therein. Any holder of this document is advised that information contained hereon reflects the Company's findings at the time of its intervention only and within the limits of Client's instructions, if any. The Company's sole responsibility is to its Client and this document does not exonerate parties to a transaction from exercising all their rights and obligations under the transaction documents. This document cannot be reproduced except in full, without prior written approval of the Company. Any unauthorized alteration, forgery or falsification of the content or appearance of this document is unlawful and offenders may be prosecuted to the fullest extent of the law.

14.41.3 Trial 3

Data Sheet for FCC Radar Type 5						
Trial Number:		3		VSG Frequency(MHz):		5530
Number of Bursts in Trial:			20		Successful Detection: Yes	
Burst (8-20)	Number Pulses per Burst (1-3)	Pulse Width (50-100)	Chirp Width (5-20)	Pulse 1-to-2 Spacing	Pulse 2-to-3 Spacing	Starting Location Within Interval
		(μ sec)	(MHz)	(μ sec)	(μ sec)	(μ sec)
1	1	53.1	20			327984
2	3	90	20	1789	1447	470347
3	2	82.3	20	1038.7		19538
4	2	76.2	20	1301.8		164251
5	2	80.3	20	1314.7		309125
6	3	91.2	20	1887.8	1592.8	452206
7	2	82.6	20	1648.4		1697
8	1	56.7	20			146959
9	2	69.4	20	1711.6		291322
10	2	71	20	1475		436052
11	3	97.9	20	1413.1	1179.1	579415
12	3	93.2	20	1553.8	1022.8	128485
13	2	72.1	20	1223.9		273557
14	3	94.6	20	1584.4	990.4	417454
15	3	90.4	20	1291.6	1396.6	561415
16	3	85.2	20	1173.8	1748.8	110459
17	3	95.3	20	1538.7	1756.7	254888
18	2	71.2	20	1839.8		400255
19	1	64.1	20			546815
20	2	74.5	20	1751.5		92943

Unless otherwise stated the results shown in this test report refer only to the sample(s) tested and such sample(s) are retained for 90 days only.

除非另有說明，此報告結果僅對測試之樣品負責，同時此樣品僅保留90天。本報告未經本公司書面許可，不可部份複製。

This document is issued by the Company subject to its General Conditions of Service printed overleaf, available on request or accessible at <http://www.sgs.com.tw/Terms-and-Conditions> and for electronic format documents, subject to Terms and Conditions for Electronic Documents at <http://www.sgs.com.tw/Terms-and-Conditions>. Attention is drawn to the limitation of liability, indemnification and jurisdiction issues defined therein. Any holder of this document is advised that information contained hereon reflects the Company's findings at the time of its intervention only and within the limits of Client's instructions, if any. The Company's sole responsibility is to its Client and this document does not exonerate parties to a transaction from exercising all their rights and obligations under the transaction documents. This document cannot be reproduced except in full, without prior written approval of the Company. Any unauthorized alteration, forgery or falsification of the content or appearance of this document is unlawful and offenders may be prosecuted to the fullest extent of the law.

14.41.4 Trial 4

Data Sheet for FCC Radar Type 5						
Trial Number:		4		VSG Frequency(MHz):		5530
Number of Bursts in Trial:			10		Successful Detection: Yes	
Burst (8-20)	Number Pulses per Burst (1-3)	Pulse Width (50-100)	Chirp Width (5-20)	Pulse 1-to-2 Spacing	Pulse 2-to-3 Spacing	Starting Location Within Interval
		(μ sec)	(MHz)	(μ sec)	(μ sec)	(μ sec)
1	2	71.3	8	1835.7		476618
2	1	57.3	8			768080
3	3	95.2	8	917.8	1522.8	1056357
4	2	82.8	8	1172.2		150695
5	2	79.5	8	1775.5		441008
6	2	68.9	8	1636.1		731474
7	1	53.6	8			1022491
8	1	59.6	8			115101
9	3	97.5	8	1330.5	1620.5	404670
10	1	52.3	8			696336

Unless otherwise stated the results shown in this test report refer only to the sample(s) tested and such sample(s) are retained for 90 days only.

除非另有說明，此報告結果僅對測試之樣品負責，同時此樣品僅保留90天。本報告未經本公司書面許可，不可部份複製。

This document is issued by the Company subject to its General Conditions of Service printed overleaf, available on request or accessible at <http://www.sgs.com.tw/Terms-and-Conditions> and for electronic format documents, subject to Terms and Conditions for Electronic Documents at <http://www.sgs.com.tw/Terms-and-Conditions>. Attention is drawn to the limitation of liability, indemnification and jurisdiction issues defined therein. Any holder of this document is advised that information contained hereon reflects the Company's findings at the time of its intervention only and within the limits of Client's instructions, if any. The Company's sole responsibility is to its Client and this document does not exonerate parties to a transaction from exercising all their rights and obligations under the transaction documents. This document cannot be reproduced except in full, without prior written approval of the Company. Any unauthorized alteration, forgery or falsification of the content or appearance of this document is unlawful and offenders may be prosecuted to the fullest extent of the law.

14.41.5 Trial 5

Data Sheet for FCC Radar Type 5						
Trial Number:		5		VSG Frequency(MHz):		5530
Number of Bursts in Trial:			17		Successful Detection: Yes	
Burst (8-20)	Number Pulses per Burst (1-3)	Pulse Width (50-100)	Chirp Width (5-20)	Pulse 1-to-2 Spacing	Pulse 2-to-3 Spacing	Starting Location Within Interval
		(μ sec)	(MHz)	(μ sec)	(μ sec)	(μ sec)
1	1	62.3	17			580292
2	3	96	17	1892	1376	46376
3	3	86.7	17	1845.3	1609.3	216364
4	1	53.7	17			388124
5	2	81.3	17	1741.7		557500
6	3	89.5	17	1284.5	1043.5	25448
7	1	53.9	17			196365
8	2	76.3	17	1248.7		366324
9	3	85.6	17	1399.4	1573.4	535403
10	1	60.6	17			4498
11	1	63.8	17			175244
12	2	82.9	17	1841.1		345455
13	2	77	17	950		516472
14	1	57.6	17			687535
15	3	94.7	17	1506.3	1682.3	153508
16	3	99.4	17	1072.6	1097.6	324212
17	2	70.8	17	1827.2		494914

Unless otherwise stated the results shown in this test report refer only to the sample(s) tested and such sample(s) are retained for 90 days only.

除非另有說明，此報告結果僅對測試之樣品負責，同時此樣品僅保留90天。本報告未經本公司書面許可，不可部份複製。

This document is issued by the Company subject to its General Conditions of Service printed overleaf, available on request or accessible at <http://www.sgs.com.tw/Terms-and-Conditions> and for electronic format documents, subject to Terms and Conditions for Electronic Documents at <http://www.sgs.com.tw/Terms-and-Conditions>. Attention is drawn to the limitation of liability, indemnification and jurisdiction issues defined therein. Any holder of this document is advised that information contained hereon reflects the Company's findings at the time of its intervention only and within the limits of Client's instructions, if any. The Company's sole responsibility is to its Client and this document does not exonerate parties to a transaction from exercising all their rights and obligations under the transaction documents. This document cannot be reproduced except in full, without prior written approval of the Company. Any unauthorized alteration, forgery or falsification of the content or appearance of this document is unlawful and offenders may be prosecuted to the fullest extent of the law.

14.41.6 Trial 6

Data Sheet for FCC Radar Type 5						
Trial Number:		6		VSG Frequency(MHz):		5530
Number of Bursts in Trial:			8		Successful Detection: Yes	
Burst (8-20)	Number Pulses per Burst (1-3)	Pulse Width (50-100)	Chirp Width (5-20)	Pulse 1-to-2 Spacing	Pulse 2-to-3 Spacing	Starting Location Within Interval
		(μ sec)	(MHz)	(μ sec)	(μ sec)	(μ sec)
1	2	75.7	5	1039.3		1417883
2	2	75.7	5	1675.3		283058
3	3	93.5	5	1267.5	1790.5	645459
4	1	50.9	5			1010268
5	2	76.5	5	1874.5		1371553
6	2	78.2	5	1352.8		238446
7	3	90.9	5	1594.1	1659.1	600817
8	2	67.6	5	1311.4		964778

Unless otherwise stated the results shown in this test report refer only to the sample(s) tested and such sample(s) are retained for 90 days only.

除非另有說明，此報告結果僅對測試之樣品負責，同時此樣品僅保留90天。本報告未經本公司書面許可，不可部份複製。

This document is issued by the Company subject to its General Conditions of Service printed overleaf, available on request or accessible at <http://www.sgs.com.tw/Terms-and-Conditions> and for electronic format documents, subject to Terms and Conditions for Electronic Documents at <http://www.sgs.com.tw/Terms-and-Conditions>. Attention is drawn to the limitation of liability, indemnification and jurisdiction issues defined therein. Any holder of this document is advised that information contained hereon reflects the Company's findings at the time of its intervention only and within the limits of Client's instructions, if any. The Company's sole responsibility is to its Client and this document does not exonerate parties to a transaction from exercising all their rights and obligations under the transaction documents. This document cannot be reproduced except in full, without prior written approval of the Company. Any unauthorized alteration, forgery or falsification of the content or appearance of this document is unlawful and offenders may be prosecuted to the fullest extent of the law.

14.41.7 Trial 7

Data Sheet for FCC Radar Type 5						
Trial Number:		7		VSG Frequency(MHz):		5530
Number of Bursts in Trial:			19		Successful Detection: Yes	
Burst (8-20)	Number Pulses per Burst (1-3)	Pulse Width (50-100)	Chirp Width (5-20)	Pulse 1-to-2 Spacing	Pulse 2-to-3 Spacing	Starting Location Within Interval
		(μ sec)	(MHz)	(μ sec)	(μ sec)	(μ sec)
1	3	95.8	18	1832.2	1410.2	555394
2	3	94.9	18	1322.1	1204.1	81223
3	3	99.5	18	1355.5	1089.5	233328
4	3	96.8	18	1535.2	1145.2	385633
5	1	61.3	18			540366
6	3	87.5	18	1422.5	1401.5	62393
7	2	72.9	18	1379.1		215032
8	1	59.2	18			368445
9	2	67.1	18	1004.9		520066
10	1	58.6	18			43887
11	1	51.8	18			196798
12	1	56.4	18			349750
13	2	68.4	18	1078.6		501484
14	1	63.2	18			25077
15	1	50.8	18			177809
16	2	81.2	18	1690.8		329509
17	2	68.9	18	1214.1		482804
18	3	85.6	18	1638.4	1504.4	6218
19	1	53.4	18			159040

Unless otherwise stated the results shown in this test report refer only to the sample(s) tested and such sample(s) are retained for 90 days only.

除非另有說明，此報告結果僅對測試之樣品負責，同時此樣品僅保留90天。本報告未經本公司書面許可，不可部份複製。

This document is issued by the Company subject to its General Conditions of Service printed overleaf, available on request or accessible at <http://www.sgs.com.tw/Terms-and-Conditions> and for electronic format documents, subject to Terms and Conditions for Electronic Documents at <http://www.sgs.com.tw/Terms-and-Conditions>. Attention is drawn to the limitation of liability, indemnification and jurisdiction issues defined therein. Any holder of this document is advised that information contained hereon reflects the Company's findings at the time of its intervention only and within the limits of Client's instructions, if any. The Company's sole responsibility is to its Client and this document does not exonerate parties to a transaction from exercising all their rights and obligations under the transaction documents. This document cannot be reproduced except in full, without prior written approval of the Company. Any unauthorized alteration, forgery or falsification of the content or appearance of this document is unlawful and offenders may be prosecuted to the fullest extent of the law.

14.41.8 Trial 8

Data Sheet for FCC Radar Type 5						
Trial Number:		8		VSG Frequency(MHz):		5530
Number of Bursts in Trial:			16		Successful Detection: Yes	
Burst (8-20)	Number Pulses per Burst (1-3)	Pulse Width (50-100)	Chirp Width (5-20)	Pulse 1-to-2 Spacing	Pulse 2-to-3 Spacing	Starting Location Within Interval
		(μ sec)	(MHz)	(μ sec)	(μ sec)	(μ sec)
1	1	60.6	16			370709
2	3	88.4	16	1673.6	1542.6	549691
3	2	80.4	16	1180.6		732531
4	3	87.6	16	1044.4	1739.4	165939
5	3	88.2	16	1018.8	1348.8	346815
6	2	80.1	16	1083.9		529051
7	3	98.1	16	1002.9	932.9	709596
8	2	78	16	1770		143881
9	3	84	16	1829	955	324420
10	1	53.9	16			507438
11	1	51.3	16			689099
12	3	85.9	16	1091.1	973.1	121440
13	2	67.8	16	1372.2		302742
14	3	95.8	16	1367.2	1777.2	483049
15	3	86.1	16	1808.9	1553.9	663080
16	3	85.6	16	1203.4	1201.4	99115

Unless otherwise stated the results shown in this test report refer only to the sample(s) tested and such sample(s) are retained for 90 days only.

除非另有說明，此報告結果僅對測試之樣品負責，同時此樣品僅保留90天。本報告未經本公司書面許可，不可部份複製。

This document is issued by the Company subject to its General Conditions of Service printed overleaf, available on request or accessible at <http://www.sgs.com.tw/Terms-and-Conditions> and for electronic format documents, subject to Terms and Conditions for Electronic Documents at <http://www.sgs.com.tw/Terms-and-Conditions>. Attention is drawn to the limitation of liability, indemnification and jurisdiction issues defined therein. Any holder of this document is advised that information contained hereon reflects the Company's findings at the time of its intervention only and within the limits of Client's instructions, if any. The Company's sole responsibility is to its Client and this document does not exonerate parties to a transaction from exercising all their rights and obligations under the transaction documents. This document cannot be reproduced except in full, without prior written approval of the Company. Any unauthorized alteration, forgery or falsification of the content or appearance of this document is unlawful and offenders may be prosecuted to the fullest extent of the law.

14.41.9 Trial 9

Data Sheet for FCC Radar Type 5						
Trial Number:		9		VSG Frequency(MHz):		5530
Number of Bursts in Trial:			15		Successful Detection: Yes	
Burst (8-20)	Number Pulses per Burst (1-3)	Pulse Width (50-100)	Chirp Width (5-20)	Pulse 1-to-2 Spacing	Pulse 2-to-3 Spacing	Starting Location Within Interval
		(μ sec)	(MHz)	(μ sec)	(μ sec)	(μ sec)
1	3	94.7	14	1479.3	1263.3	298833
2	1	54.5	14			493176
3	2	79.6	14	1873.4		685083
4	2	74.2	14	1843.8		82062
5	2	73.2	14	1416.8		275417
6	3	90.9	14	1149.1	1074.1	467980
7	2	73.7	14	1483.3		662375
8	1	59.9	14			58438
9	3	99	14	1378	1647	251182
10	3	92.8	14	1777.2	1876.2	443379
11	3	93	14	1382	1233	637342
12	1	52.4	14			34582
13	1	62.4	14			228187
14	2	74.8	14	1905.2		420798
15	1	62.3	14			615553

Unless otherwise stated the results shown in this test report refer only to the sample(s) tested and such sample(s) are retained for 90 days only.

除非另有說明，此報告結果僅對測試之樣品負責，同時此樣品僅保留90天。本報告未經本公司書面許可，不可部份複製。

This document is issued by the Company subject to its General Conditions of Service printed overleaf, available on request or accessible at <http://www.sgs.com.tw/Terms-and-Conditions> and for electronic format documents, subject to Terms and Conditions for Electronic Documents at <http://www.sgs.com.tw/Terms-and-Conditions>. Attention is drawn to the limitation of liability, indemnification and jurisdiction issues defined therein. Any holder of this document is advised that information contained hereon reflects the Company's findings at the time of its intervention only and within the limits of Client's instructions, if any. The Company's sole responsibility is to its Client and this document does not exonerate parties to a transaction from exercising all their rights and obligations under the transaction documents. This document cannot be reproduced except in full, without prior written approval of the Company. Any unauthorized alteration, forgery or falsification of the content or appearance of this document is unlawful and offenders may be prosecuted to the fullest extent of the law.

14.41.10 Trial 10

Data Sheet for FCC Radar Type 5						
Trial Number:		10		VSG Frequency(MHz):		5530
Number of Bursts in Trial:			17		Successful Detection: Yes	
Burst (8-20)	Number Pulses per Burst (1-3)	Pulse Width (50-100)	Chirp Width (5-20)	Pulse 1-to-2 Spacing	Pulse 2-to-3 Spacing	Starting Location Within Interval
		(μ sec)	(MHz)	(μ sec)	(μ sec)	(μ sec)
1	2	82	16	1608		9460
2	3	90.9	16	1895.1	1899.1	179231
3	2	74.7	16	971.3		350504
4	2	80.3	16	1727.7		520285
5	2	79.3	16	1343.7		691395
6	1	65.4	16			159274
7	1	57.2	16			330226
8	1	61.3	16			500882
9	2	66.7	16	1384.3		670070
10	1	63.3	16			138302
11	1	59.5	16			308892
12	3	89	16	956	1389	478108
13	1	55.2	16			651105
14	1	65.7	16			117181
15	2	72.8	16	1140.2		287537
16	3	84.1	16	1657.9	1577.9	456409
17	1	60.6	16			630080

Unless otherwise stated the results shown in this test report refer only to the sample(s) tested and such sample(s) are retained for 90 days only.

除非另有說明，此報告結果僅對測試之樣品負責，同時此樣品僅保留90天。本報告未經本公司書面許可，不可部份複製。

This document is issued by the Company subject to its General Conditions of Service printed overleaf, available on request or accessible at <http://www.sgs.com.tw/Terms-and-Conditions> and for electronic format documents, subject to Terms and Conditions for Electronic Documents at <http://www.sgs.com.tw/Terms-and-Conditions>. Attention is drawn to the limitation of liability, indemnification and jurisdiction issues defined therein. Any holder of this document is advised that information contained hereon reflects the Company's findings at the time of its intervention only and within the limits of Client's instructions, if any. The Company's sole responsibility is to its Client and this document does not exonerate parties to a transaction from exercising all their rights and obligations under the transaction documents. This document cannot be reproduced except in full, without prior written approval of the Company. Any unauthorized alteration, forgery or falsification of the content or appearance of this document is unlawful and offenders may be prosecuted to the fullest extent of the law.

14.41.11 Trial 11

Data Sheet for FCC Radar Type 5						
Trial Number:		11		VSG Frequency(MHz):		5494.097
Number of Bursts in Trial:			8		Successful Detection: Yes	
Burst (8-20)	Number Pulses per Burst (1-3)	Pulse Width (50-100)	Chirp Width (5-20)	Pulse 1-to-2 Spacing	Pulse 2-to-3 Spacing	Starting Location Within Interval
		(μ sec)	(MHz)	(μ sec)	(μ sec)	(μ sec)
1	2	82.3	5	1891.7		204286
2	2	77.7	5	1726.3		567132
3	1	56.2	5			931599
4	2	76.6	5	1705.4		1293038
5	3	89.4	5	1564.6	1775.6	159393
6	1	61.4	5			523221
7	2	80.3	5	1636.7		885768
8	2	69.7	5	1494.3		1249162

Unless otherwise stated the results shown in this test report refer only to the sample(s) tested and such sample(s) are retained for 90 days only.

除非另有說明，此報告結果僅對測試之樣品負責，同時此樣品僅保留90天。本報告未經本公司書面許可，不可部份複製。

This document is issued by the Company subject to its General Conditions of Service printed overleaf, available on request or accessible at <http://www.sgs.com.tw/Terms-and-Conditions> and for electronic format documents, subject to Terms and Conditions for Electronic Documents at <http://www.sgs.com.tw/Terms-and-Conditions>. Attention is drawn to the limitation of liability, indemnification and jurisdiction issues defined therein. Any holder of this document is advised that information contained hereon reflects the Company's findings at the time of its intervention only and within the limits of Client's instructions, if any. The Company's sole responsibility is to its Client and this document does not exonerate parties to a transaction from exercising all their rights and obligations under the transaction documents. This document cannot be reproduced except in full, without prior written approval of the Company. Any unauthorized alteration, forgery or falsification of the content or appearance of this document is unlawful and offenders may be prosecuted to the fullest extent of the law.

14.41.12 Trial 12

Data Sheet for FCC Radar Type 5						
Trial Number:		12		VSG Frequency(MHz):		5496.097
Number of Bursts in Trial:			12		Successful Detection: Yes	
Burst (8-20)	Number Pulses per Burst (1-3)	Pulse Width (50-100)	Chirp Width (5-20)	Pulse 1-to-2 Spacing	Pulse 2-to-3 Spacing	Starting Location Within Interval
		(μ sec)	(MHz)	(μ sec)	(μ sec)	(μ sec)
1	1	64.7	10			76661
2	2	70.5	10	1788.5		318052
3	3	88.7	10	1145.3	1370.3	559355
4	3	95.4	10	1585.6	977.6	800973
5	3	87.2	10	1730.8	931.8	46677
6	3	95.7	10	1486.3	1643.3	287993
7	1	65.5	10			531115
8	1	59.1	10			773599
9	3	91.7	10	1495.3	944.3	16922
10	2	69.4	10	1818.6		258740
11	3	95.1	10	1223.9	1397.9	499728
12	3	93.2	10	1751.8	1222.8	740884

Unless otherwise stated the results shown in this test report refer only to the sample(s) tested and such sample(s) are retained for 90 days only.

除非另有說明，此報告結果僅對測試之樣品負責，同時此樣品僅保留90天。本報告未經本公司書面許可，不可部份複製。

This document is issued by the Company subject to its General Conditions of Service printed overleaf, available on request or accessible at <http://www.sgs.com.tw/Terms-and-Conditions> and for electronic format documents, subject to Terms and Conditions for Electronic Documents at <http://www.sgs.com.tw/Terms-and-Conditions>. Attention is drawn to the limitation of liability, indemnification and jurisdiction issues defined therein. Any holder of this document is advised that information contained hereon reflects the Company's findings at the time of its intervention only and within the limits of Client's instructions, if any. The Company's sole responsibility is to its Client and this document does not exonerate parties to a transaction from exercising all their rights and obligations under the transaction documents. This document cannot be reproduced except in full, without prior written approval of the Company. Any unauthorized alteration, forgery or falsification of the content or appearance of this document is unlawful and offenders may be prosecuted to the fullest extent of the law.

14.41.13 Trial 13

Data Sheet for FCC Radar Type 5						
Trial Number:		13		VSG Frequency(MHz):		5494.097
Number of Bursts in Trial:			8		Successful Detection: Yes	
Burst (8-20)	Number Pulses per Burst (1-3)	Pulse Width (50-100)	Chirp Width (5-20)	Pulse 1-to-2 Spacing	Pulse 2-to-3 Spacing	Starting Location Within Interval
		(μ sec)	(MHz)	(μ sec)	(μ sec)	(μ sec)
1	1	65.5	5			1479371
2	1	56.8	5			344182
3	2	70.1	5	1105.9		706970
4	3	87.4	5	1570.6	1874.6	1068743
5	3	93.3	5	1060.7	1618.7	1432093
6	1	62.8	5			299316
7	1	60.9	5			662666
8	1	63.7	5			1026325

Unless otherwise stated the results shown in this test report refer only to the sample(s) tested and such sample(s) are retained for 90 days only.

除非另有說明，此報告結果僅對測試之樣品負責，同時此樣品僅保留90天。本報告未經本公司書面許可，不可部份複製。

This document is issued by the Company subject to its General Conditions of Service printed overleaf, available on request or accessible at <http://www.sgs.com.tw/Terms-and-Conditions> and for electronic format documents, subject to Terms and Conditions for Electronic Documents at <http://www.sgs.com.tw/Terms-and-Conditions>. Attention is drawn to the limitation of liability, indemnification and jurisdiction issues defined therein. Any holder of this document is advised that information contained hereon reflects the Company's findings at the time of its intervention only and within the limits of Client's instructions, if any. The Company's sole responsibility is to its Client and this document does not exonerate parties to a transaction from exercising all their rights and obligations under the transaction documents. This document cannot be reproduced except in full, without prior written approval of the Company. Any unauthorized alteration, forgery or falsification of the content or appearance of this document is unlawful and offenders may be prosecuted to the fullest extent of the law.

14.41.14 Trial 14

Data Sheet for FCC Radar Type 5						
Trial Number:		14		VSG Frequency(MHz):		5499.697
Number of Bursts in Trial:			20		Successful Detection: Yes	
Burst (8-20)	Number Pulses per Burst (1-3)	Pulse Width (50-100)	Chirp Width (5-20)	Pulse 1-to-2 Spacing	Pulse 2-to-3 Spacing	Starting Location Within Interval
		(μ sec)	(MHz)	(μ sec)	(μ sec)	(μ sec)
1	1	51.9	19			555310
2	2	68.4	19	1297.6		101410
3	3	94.2	19	937.8	1678.8	245502
4	2	76.1	19	1023.9		391491
5	1	58.7	19			537470
6	2	82.3	19	1078.7		83620
7	2	70.1	19	1302.9		228490
8	3	84.7	19	1375.3	1583.3	372232
9	2	68.6	19	1426.4		517894
10	3	85.7	19	963.3	1248.3	65637
11	3	92.7	19	1210.3	1139.3	210105
12	2	79.5	19	1500.5		355398
13	3	94.5	19	1452.5	1043.5	498911
14	1	60.5	19			48049
15	1	64.6	19			193165
16	3	95	19	1062	1748	336831
17	2	68.6	19	1053.4		482936
18	1	65.9	19			30180
19	2	79.6	19	945.4		175084
20	2	67.6	19	933.4		320145

Unless otherwise stated the results shown in this test report refer only to the sample(s) tested and such sample(s) are retained for 90 days only.

除非另有說明，此報告結果僅對測試之樣品負責，同時此樣品僅保留90天。本報告未經本公司書面許可，不可部份複製。

This document is issued by the Company subject to its General Conditions of Service printed overleaf, available on request or accessible at <http://www.sgs.com.tw/Terms-and-Conditions> and for electronic format documents, subject to Terms and Conditions for Electronic Documents at <http://www.sgs.com.tw/Terms-and-Conditions>. Attention is drawn to the limitation of liability, indemnification and jurisdiction issues defined therein. Any holder of this document is advised that information contained hereon reflects the Company's findings at the time of its intervention only and within the limits of Client's instructions, if any. The Company's sole responsibility is to its Client and this document does not exonerate parties to a transaction from exercising all their rights and obligations under the transaction documents. This document cannot be reproduced except in full, without prior written approval of the Company. Any unauthorized alteration, forgery or falsification of the content or appearance of this document is unlawful and offenders may be prosecuted to the fullest extent of the law.

14.41.15 Trial 15

Data Sheet for FCC Radar Type 5						
Trial Number:		15		VSG Frequency(MHz):		5498.897
Number of Bursts in Trial:			18		Successful Detection: Yes	
Burst (8-20)	Number Pulses per Burst (1-3)	Pulse Width (50-100)	Chirp Width (5-20)	Pulse 1-to-2 Spacing	Pulse 2-to-3 Spacing	Starting Location Within Interval
		(μ sec)	(MHz)	(μ sec)	(μ sec)	(μ sec)
1	3	94	17	1439	1888	514754
2	2	79.9	17	1615.1		13624
3	1	63.6	17			175105
4	3	96.4	17	1606.6	1207.6	334596
5	2	77.7	17	1836.3		496335
6	3	91	17	1245	1130	656012
7	3	95.2	17	1843.8	1354.8	154230
8	2	75.5	17	1645.5		315659
9	1	57.6	17			477960
10	2	68.8	17	948.2		638361
11	3	83.4	17	1039.6	1116.6	134744
12	2	76.6	17	1028.4		296218
13	1	50.4	17			458029
14	1	66.5	17			618940
15	2	67.8	17	1250.2		115207
16	3	96.3	17	1337.7	984.7	275765
17	2	76.3	17	1450.7		436688
18	1	62.5	17			598976

Unless otherwise stated the results shown in this test report refer only to the sample(s) tested and such sample(s) are retained for 90 days only.

除非另有說明，此報告結果僅對測試之樣品負責，同時此樣品僅保留90天。本報告未經本公司書面許可，不可部份複製。

This document is issued by the Company subject to its General Conditions of Service printed overleaf, available on request or accessible at <http://www.sgs.com.tw/Terms-and-Conditions> and for electronic format documents, subject to Terms and Conditions for Electronic Documents at <http://www.sgs.com.tw/Terms-and-Conditions>. Attention is drawn to the limitation of liability, indemnification and jurisdiction issues defined therein. Any holder of this document is advised that information contained hereon reflects the Company's findings at the time of its intervention only and within the limits of Client's instructions, if any. The Company's sole responsibility is to its Client and this document does not exonerate parties to a transaction from exercising all their rights and obligations under the transaction documents. This document cannot be reproduced except in full, without prior written approval of the Company. Any unauthorized alteration, forgery or falsification of the content or appearance of this document is unlawful and offenders may be prosecuted to the fullest extent of the law.

14.41.16 Trial 16

Data Sheet for FCC Radar Type 5						
Trial Number:		16		VSG Frequency(MHz):		5499.697
Number of Bursts in Trial:			20		Successful Detection: Yes	
Burst (8-20)	Number Pulses per Burst (1-3)	Pulse Width (50-100)	Chirp Width (5-20)	Pulse 1-to-2 Spacing	Pulse 2-to-3 Spacing	Starting Location Within Interval
		(μ sec)	(MHz)	(μ sec)	(μ sec)	(μ sec)
1	3	86.6	19	1849.4	1340.4	85405
2	1	54.8	19			231183
3	2	75.5	19	1790.5		375035
4	2	80.8	19	1449.2		520228
5	3	90.5	19	931.5	1160.5	67791
6	1	56	19			213098
7	2	76.7	19	1877.3		357248
8	1	65.6	19			503347
9	3	98.7	19	1273.3	1295.3	49898
10	1	55	19			195306
11	3	92.3	19	1251.7	1171.7	339090
12	2	75.1	19	979.9		484759
13	2	68.8	19	1501.2		32183
14	2	77.3	19	1798.7		176994
15	2	83.2	19	1421.8		321885
16	3	93.3	19	1451.7	1520.7	465477
17	2	69.7	19	932.3		14378
18	2	72.1	19	1385.9		159073
19	1	54.8	19			304639
20	3	97.9	19	1634.1	939.1	447875

Unless otherwise stated the results shown in this test report refer only to the sample(s) tested and such sample(s) are retained for 90 days only.

除非另有說明，此報告結果僅對測試之樣品負責，同時此樣品僅保留90天。本報告未經本公司書面許可，不可部份複製。

This document is issued by the Company subject to its General Conditions of Service printed overleaf, available on request or accessible at <http://www.sgs.com.tw/Terms-and-Conditions> and for electronic format documents, subject to Terms and Conditions for Electronic Documents at <http://www.sgs.com.tw/Terms-and-Conditions>. Attention is drawn to the limitation of liability, indemnification and jurisdiction issues defined therein. Any holder of this document is advised that information contained hereon reflects the Company's findings at the time of its intervention only and within the limits of Client's instructions, if any. The Company's sole responsibility is to its Client and this document does not exonerate parties to a transaction from exercising all their rights and obligations under the transaction documents. This document cannot be reproduced except in full, without prior written approval of the Company. Any unauthorized alteration, forgery or falsification of the content or appearance of this document is unlawful and offenders may be prosecuted to the fullest extent of the law.

14.41.17 Trial 17

Data Sheet for FCC Radar Type 5						
Trial Number:		17		VSG Frequency(MHz):		5497.697
Number of Bursts in Trial:			15		Successful Detection: Yes	
Burst (8-20)	Number Pulses per Burst (1-3)	Pulse Width (50-100)	Chirp Width (5-20)	Pulse 1-to-2 Spacing	Pulse 2-to-3 Spacing	Starting Location Within Interval
		(μ sec)	(MHz)	(μ sec)	(μ sec)	(μ sec)
1	3	98.5	14	1529.5	1540.5	790275
2	2	67.8	14	967.2		188767
3	3	87.2	14	1393.8	1408.8	381473
4	3	94.7	14	1083.3	1702.3	574184
5	2	77.1	14	1188.9		768439
6	3	99.9	14	1371.1	1009.1	164630
7	1	52.2	14			358931
8	1	66	14			552374
9	2	79	14	1802		743959
10	2	77.9	14	1074.1		141116
11	3	92.8	14	1900.2	1228.2	333425
12	2	68.3	14	1261.7		527752
13	2	68.6	14	1277.4		720969
14	1	56.1	14			117503
15	2	79.4	14	997.6		310715

Unless otherwise stated the results shown in this test report refer only to the sample(s) tested and such sample(s) are retained for 90 days only.

除非另有說明，此報告結果僅對測試之樣品負責，同時此樣品僅保留90天。本報告未經本公司書面許可，不可部份複製。

This document is issued by the Company subject to its General Conditions of Service printed overleaf, available on request or accessible at <http://www.sgs.com.tw/Terms-and-Conditions> and for electronic format documents, subject to Terms and Conditions for Electronic Documents at <http://www.sgs.com.tw/Terms-and-Conditions>. Attention is drawn to the limitation of liability, indemnification and jurisdiction issues defined therein. Any holder of this document is advised that information contained hereon reflects the Company's findings at the time of its intervention only and within the limits of Client's instructions, if any. The Company's sole responsibility is to its Client and this document does not exonerate parties to a transaction from exercising all their rights and obligations under the transaction documents. This document cannot be reproduced except in full, without prior written approval of the Company. Any unauthorized alteration, forgery or falsification of the content or appearance of this document is unlawful and offenders may be prosecuted to the fullest extent of the law.

14.41.18 Trial 18

Data Sheet for FCC Radar Type 5						
Trial Number:		18		VSG Frequency(MHz):		5499.297
Number of Bursts in Trial:			19		Successful Detection: Yes	
Burst (8-20)	Number Pulses per Burst (1-3)	Pulse Width (50-100)	Chirp Width (5-20)	Pulse 1-to-2 Spacing	Pulse 2-to-3 Spacing	Starting Location Within Interval
		(μ sec)	(MHz)	(μ sec)	(μ sec)	(μ sec)
1	2	74.7	18	1195.3		397610
2	3	92.2	18	986.8	1411.8	548460
3	1	63.1	18			73913
4	3	89.4	18	1857.6	1340.6	225288
5	1	57.5	18			379635
6	2	69.6	18	1755.4		530955
7	1	62.1	18			55066
8	3	92.3	18	1823.7	1520.7	206531
9	3	90.1	18	1411.9	1426.9	359180
10	2	83.3	18	1525.7		511995
11	2	82.5	18	920.5		36177
12	1	50	18			189009
13	1	56	18			341672
14	3	93.4	18	958.6	1162.6	492876
15	1	57.1	18			17384
16	3	96.9	18	1903.1	1547.1	169257
17	3	95.7	18	1611.3	1631.3	321056
18	3	91.5	18	1837.5	1020.5	473521
19	2	78.5	18	1722.5		626753

Unless otherwise stated the results shown in this test report refer only to the sample(s) tested and such sample(s) are retained for 90 days only.

除非另有說明，此報告結果僅對測試之樣品負責，同時此樣品僅保留90天。本報告未經本公司書面許可，不可部份複製。

This document is issued by the Company subject to its General Conditions of Service printed overleaf, available on request or accessible at <http://www.sgs.com.tw/Terms-and-Conditions> and for electronic format documents, subject to Terms and Conditions for Electronic Documents at <http://www.sgs.com.tw/Terms-and-Conditions>. Attention is drawn to the limitation of liability, indemnification and jurisdiction issues defined therein. Any holder of this document is advised that information contained hereon reflects the Company's findings at the time of its intervention only and within the limits of Client's instructions, if any. The Company's sole responsibility is to its Client and this document does not exonerate parties to a transaction from exercising all their rights and obligations under the transaction documents. This document cannot be reproduced except in full, without prior written approval of the Company. Any unauthorized alteration, forgery or falsification of the content or appearance of this document is unlawful and offenders may be prosecuted to the fullest extent of the law.

14.41.19 Trial 19

Data Sheet for FCC Radar Type 5						
Trial Number:		19		VSG Frequency(MHz):		5499.297
Number of Bursts in Trial:			19		Successful Detection: Yes	
Burst (8-20)	Number Pulses per Burst (1-3)	Pulse Width (50-100)	Chirp Width (5-20)	Pulse 1-to-2 Spacing	Pulse 2-to-3 Spacing	Starting Location Within Interval
		(μ sec)	(MHz)	(μ sec)	(μ sec)	(μ sec)
1	1	64.1	18			151404
2	2	68.7	18	1329.3		303636
3	2	67.7	18	1621.3		455897
4	2	80.9	18	925.1		608478
5	1	53.7	18			132455
6	3	90.7	18	1583.3	965.3	284045
7	1	53.7	18			438429
8	1	60.7	18			591109
9	3	86.6	18	1369.4	1362.4	113150
10	2	70.7	18	1328.3		266125
11	1	62.2	18			419294
12	2	73.9	18	1043.1		571533
13	1	56.5	18			94839
14	1	62.7	18			247847
15	3	98	18	1526	1572	398132
16	1	58.4	18			553311
17	1	51.1	18			76048
18	1	56.6	18			228873
19	2	82.8	18	1720.2		380555

Unless otherwise stated the results shown in this test report refer only to the sample(s) tested and such sample(s) are retained for 90 days only.

除非另有說明，此報告結果僅對測試之樣品負責，同時此樣品僅保留90天。本報告未經本公司書面許可，不可部份複製。

This document is issued by the Company subject to its General Conditions of Service printed overleaf, available on request or accessible at <http://www.sgs.com.tw/Terms-and-Conditions> and for electronic format documents, subject to Terms and Conditions for Electronic Documents at <http://www.sgs.com.tw/Terms-and-Conditions>. Attention is drawn to the limitation of liability, indemnification and jurisdiction issues defined therein. Any holder of this document is advised that information contained hereon reflects the Company's findings at the time of its intervention only and within the limits of Client's instructions, if any. The Company's sole responsibility is to its Client and this document does not exonerate parties to a transaction from exercising all their rights and obligations under the transaction documents. This document cannot be reproduced except in full, without prior written approval of the Company. Any unauthorized alteration, forgery or falsification of the content or appearance of this document is unlawful and offenders may be prosecuted to the fullest extent of the law.

14.41.20 Trial 20

Data Sheet for FCC Radar Type 5						
Trial Number:		20		VSG Frequency(MHz):		5499.297
Number of Bursts in Trial:			19		Successful Detection: Yes	
Burst (8-20)	Number Pulses per Burst (1-3)	Pulse Width (50-100)	Chirp Width (5-20)	Pulse 1-to-2 Spacing	Pulse 2-to-3 Spacing	Starting Location Within Interval
		(μ sec)	(MHz)	(μ sec)	(μ sec)	(μ sec)
1	3	97.3	18	1385.7	1004.7	532247
2	2	78.3	18	1527.7		57131
3	3	86.3	18	1377.7	941.7	209175
4	2	75.6	18	1300.4		361912
5	3	97.1	18	1425.9	1562.9	512859
6	1	61.3	18			38427
7	3	94.7	18	1832.3	1797.3	189951
8	3	99.9	18	1615.1	1227.1	342491
9	3	96.2	18	1114.8	1128.8	495260
10	2	72.7	18	1002.3		19590
11	2	71.8	18	1446.2		172045
12	2	81.1	18	1817.9		324012
13	3	97.1	18	911.9	1082.9	476328
14	2	76.9	18	1550.1		795
15	3	90.2	18	1815.8	1585.8	152759
16	3	92	18	1261	1695	304775
17	1	60.6	18			459016
18	1	57	18			612493
19	1	61.2	18			134877

Unless otherwise stated the results shown in this test report refer only to the sample(s) tested and such sample(s) are retained for 90 days only.

除非另有說明，此報告結果僅對測試之樣品負責，同時此樣品僅保留90天。本報告未經本公司書面許可，不可部份複製。

This document is issued by the Company subject to its General Conditions of Service printed overleaf, available on request or accessible at <http://www.sgs.com.tw/Terms-and-Conditions> and for electronic format documents, subject to Terms and Conditions for Electronic Documents at <http://www.sgs.com.tw/Terms-and-Conditions>. Attention is drawn to the limitation of liability, indemnification and jurisdiction issues defined therein. Any holder of this document is advised that information contained hereon reflects the Company's findings at the time of its intervention only and within the limits of Client's instructions, if any. The Company's sole responsibility is to its Client and this document does not exonerate parties to a transaction from exercising all their rights and obligations under the transaction documents. This document cannot be reproduced except in full, without prior written approval of the Company. Any unauthorized alteration, forgery or falsification of the content or appearance of this document is unlawful and offenders may be prosecuted to the fullest extent of the law.

14.41.21 Trial 21

Data Sheet for FCC Radar Type 5						
Trial Number:		21		VSG Frequency(MHz):		5563.503
Number of Bursts in Trial:			13		Successful Detection: Yes	
Burst (8-20)	Number Pulses per Burst (1-3)	Pulse Width (50-100)	Chirp Width (5-20)	Pulse 1-to-2 Spacing	Pulse 2-to-3 Spacing	Starting Location Within Interval
		(μ sec)	(MHz)	(μ sec)	(μ sec)	(μ sec)
1	1	59.3	11			420586
2	3	98.7	11	1621.3	1301.3	641808
3	1	53.8	11			867823
4	1	58.9	11			169631
5	2	75.5	11	1554.5		392320
6	2	71.5	11	1535.5		615399
7	2	77.8	11	1860.2		838671
8	1	59.4	11			142128
9	2	76	11	1021		365105
10	3	87.3	11	1224.7	1506.7	587038
11	1	58.1	11			813032
12	3	84.9	11	1098.1	1553.1	114183
13	1	55.9	11			337935

Unless otherwise stated the results shown in this test report refer only to the sample(s) tested and such sample(s) are retained for 90 days only.

除非另有說明，此報告結果僅對測試之樣品負責，同時此樣品僅保留90天。本報告未經本公司書面許可，不可部份複製。

This document is issued by the Company subject to its General Conditions of Service printed overleaf, available on request or accessible at <http://www.sgs.com.tw/Terms-and-Conditions> and for electronic format documents, subject to Terms and Conditions for Electronic Documents at <http://www.sgs.com.tw/Terms-and-Conditions>. Attention is drawn to the limitation of liability, indemnification and jurisdiction issues defined therein. Any holder of this document is advised that information contained hereon reflects the Company's findings at the time of its intervention only and within the limits of Client's instructions, if any. The Company's sole responsibility is to its Client and this document does not exonerate parties to a transaction from exercising all their rights and obligations under the transaction documents. This document cannot be reproduced except in full, without prior written approval of the Company. Any unauthorized alteration, forgery or falsification of the content or appearance of this document is unlawful and offenders may be prosecuted to the fullest extent of the law.

14.41.22 Trial 22

Data Sheet for FCC Radar Type 5						
Trial Number:		22		VSG Frequency(MHz):		5563.903
Number of Bursts in Trial:			12		Successful Detection: Yes	
Burst (8-20)	Number Pulses per Burst (1-3)	Pulse Width (50-100)	Chirp Width (5-20)	Pulse 1-to-2 Spacing	Pulse 2-to-3 Spacing	Starting Location Within Interval
		(μ sec)	(MHz)	(μ sec)	(μ sec)	(μ sec)
1	3	90.2	10	1273.8	1204.8	606736
2	1	62.9	10			850876
3	3	94.2	10	1482.8	1602.8	93968
4	1	50.2	10			336477
5	2	77.8	10	936.2		577757
6	3	93.2	10	1579.8	1677.8	817990
7	2	70.7	10	1139.3		64356
8	2	69.6	10	1677.4		306218
9	1	59.1	10			548542
10	3	90.9	10	1382.1	993.1	788888
11	1	57.5	10			34613
12	3	88.1	10	923.9	1836.9	275921

Unless otherwise stated the results shown in this test report refer only to the sample(s) tested and such sample(s) are retained for 90 days only.

除非另有說明，此報告結果僅對測試之樣品負責，同時此樣品僅保留90天。本報告未經本公司書面許可，不可部份複製。

This document is issued by the Company subject to its General Conditions of Service printed overleaf, available on request or accessible at <http://www.sgs.com.tw/Terms-and-Conditions> and for electronic format documents, subject to Terms and Conditions for Electronic Documents at <http://www.sgs.com.tw/Terms-and-Conditions>. Attention is drawn to the limitation of liability, indemnification and jurisdiction issues defined therein. Any holder of this document is advised that information contained hereon reflects the Company's findings at the time of its intervention only and within the limits of Client's instructions, if any. The Company's sole responsibility is to its Client and this document does not exonerate parties to a transaction from exercising all their rights and obligations under the transaction documents. This document cannot be reproduced except in full, without prior written approval of the Company. Any unauthorized alteration, forgery or falsification of the content or appearance of this document is unlawful and offenders may be prosecuted to the fullest extent of the law.

14.41.23 Trial 23

Data Sheet for FCC Radar Type 5						
Trial Number:		23		VSG Frequency(MHz):		5562.303
Number of Bursts in Trial:			15		Successful Detection: Yes	
Burst (8-20)	Number Pulses per Burst (1-3)	Pulse Width (50-100)	Chirp Width (5-20)	Pulse 1-to-2 Spacing	Pulse 2-to-3 Spacing	Starting Location Within Interval
		(μ sec)	(MHz)	(μ sec)	(μ sec)	(μ sec)
1	1	64.7	14			415120
2	3	89.6	14	1085.4	1597.4	606453
3	1	65.2	14			3836
4	3	97.1	14	1273.9	1796.9	196765
5	1	66.3	14			391306
6	2	70.7	14	1892.3		583184
7	3	87.3	14	1673.7	1200.7	775695
8	1	51.4	14			173646
9	3	90	14	998	1587	366139
10	3	97.3	14	1723.7	1681.7	558113
11	3	84.2	14	1194.8	1188.8	752330
12	3	93.5	14	1780.5	1458.5	149161
13	2	69.3	14	1497.7		342569
14	1	60.7	14			537050
15	1	54	14			730970

Unless otherwise stated the results shown in this test report refer only to the sample(s) tested and such sample(s) are retained for 90 days only.

除非另有說明，此報告結果僅對測試之樣品負責，同時此樣品僅保留90天。本報告未經本公司書面許可，不可部份複製。

This document is issued by the Company subject to its General Conditions of Service printed overleaf, available on request or accessible at <http://www.sgs.com.tw/Terms-and-Conditions> and for electronic format documents, subject to Terms and Conditions for Electronic Documents at <http://www.sgs.com.tw/Terms-and-Conditions>. Attention is drawn to the limitation of liability, indemnification and jurisdiction issues defined therein. Any holder of this document is advised that information contained hereon reflects the Company's findings at the time of its intervention only and within the limits of Client's instructions, if any. The Company's sole responsibility is to its Client and this document does not exonerate parties to a transaction from exercising all their rights and obligations under the transaction documents. This document cannot be reproduced except in full, without prior written approval of the Company. Any unauthorized alteration, forgery or falsification of the content or appearance of this document is unlawful and offenders may be prosecuted to the fullest extent of the law.

14.41.24 Trial 24

Data Sheet for FCC Radar Type 5						
Trial Number:		24		VSG Frequency(MHz):		5560.303
Number of Bursts in Trial:			20		Successful Detection: Yes	
Burst (8-20)	Number Pulses per Burst (1-3)	Pulse Width (50-100)	Chirp Width (5-20)	Pulse 1-to-2 Spacing	Pulse 2-to-3 Spacing	Starting Location Within Interval
		(μ sec)	(MHz)	(μ sec)	(μ sec)	(μ sec)
1	2	69.3	19	1293.7		94192
2	1	51.9	19			239745
3	2	68.6	19	1582.4		383859
4	1	62.5	19			529765
5	3	88.1	19	915.9	1048.9	76228
6	3	87.8	19	1104.2	1140.2	220653
7	1	65.8	19			366886
8	3	90.9	19	1123.1	1324.1	509849
9	3	84.2	19	1904.8	1361.8	58326
10	2	82.8	19	1605.2		203265
11	3	90	19	1177	1126	347500
12	1	64.1	19			494229
13	2	67.4	19	1012.6		40688
14	3	86.4	19	1558.6	1100.6	185058
15	3	91.7	19	1461.3	1772.3	329175
16	1	50.2	19			476294
17	1	57.7	19			22880
18	3	96.3	19	1617.7	1315.7	167054
19	2	70.9	19	1872.1		311966
20	1	60.7	19			458616

Unless otherwise stated the results shown in this test report refer only to the sample(s) tested and such sample(s) are retained for 90 days only.

除非另有說明，此報告結果僅對測試之樣品負責，同時此樣品僅保留90天。本報告未經本公司書面許可，不可部份複製。

This document is issued by the Company subject to its General Conditions of Service printed overleaf, available on request or accessible at <http://www.sgs.com.tw/Terms-and-Conditions> and for electronic format documents, subject to Terms and Conditions for Electronic Documents at <http://www.sgs.com.tw/Terms-and-Conditions>. Attention is drawn to the limitation of liability, indemnification and jurisdiction issues defined therein. Any holder of this document is advised that information contained hereon reflects the Company's findings at the time of its intervention only and within the limits of Client's instructions, if any. The Company's sole responsibility is to its Client and this document does not exonerate parties to a transaction from exercising all their rights and obligations under the transaction documents. This document cannot be reproduced except in full, without prior written approval of the Company. Any unauthorized alteration, forgery or falsification of the content or appearance of this document is unlawful and offenders may be prosecuted to the fullest extent of the law.

14.41.25 Trial 25

Data Sheet for FCC Radar Type 5						
Trial Number:		25		VSG Frequency(MHz):		5559.903
Number of Bursts in Trial:			20		Successful Detection: Yes	
Burst (8-20)	Number Pulses per Burst (1-3)	Pulse Width (50-100)	Chirp Width (5-20)	Pulse 1-to-2 Spacing	Pulse 2-to-3 Spacing	Starting Location Within Interval
		(μ sec)	(MHz)	(μ sec)	(μ sec)	(μ sec)
1	2	81.9	20	1747.1		4972
2	1	62.6	20			150270
3	1	62.4	20			295146
4	1	59.6	20			440705
5	1	66.6	20			585945
6	2	70.9	20	1927.1		131840
7	3	83.4	20	1273.6	1651.6	275953
8	1	66	20			422341
9	3	93	20	1287	1229	565394
10	2	78.7	20	1908.3		113975
11	1	50.6	20			259629
12	2	80.9	20	1405.1		403645
13	2	67	20	1119		548813
14	3	89.2	20	1509.8	1008.8	96014
15	1	51.4	20			241566
16	2	67.6	20	1374.4		386144
17	3	90.5	20	1318.5	1145.5	529515
18	2	78.4	20	1374.6		78447
19	2	69.5	20	1465.5		223236
20	1	50.2	20			368841

Unless otherwise stated the results shown in this test report refer only to the sample(s) tested and such sample(s) are retained for 90 days only.

除非另有說明，此報告結果僅對測試之樣品負責，同時此樣品僅保留90天。本報告未經本公司書面許可，不可部份複製。

This document is issued by the Company subject to its General Conditions of Service printed overleaf, available on request or accessible at <http://www.sgs.com.tw/Terms-and-Conditions> and for electronic format documents, subject to Terms and Conditions for Electronic Documents at <http://www.sgs.com.tw/Terms-and-Conditions>. Attention is drawn to the limitation of liability, indemnification and jurisdiction issues defined therein. Any holder of this document is advised that information contained hereon reflects the Company's findings at the time of its intervention only and within the limits of Client's instructions, if any. The Company's sole responsibility is to its Client and this document does not exonerate parties to a transaction from exercising all their rights and obligations under the transaction documents. This document cannot be reproduced except in full, without prior written approval of the Company. Any unauthorized alteration, forgery or falsification of the content or appearance of this document is unlawful and offenders may be prosecuted to the fullest extent of the law.

14.41.26 Trial 26

Data Sheet for FCC Radar Type 5						
Trial Number:		26		VSG Frequency(MHz):		5560.703
Number of Bursts in Trial:			18		Successful Detection: Yes	
Burst (8-20)	Number Pulses per Burst (1-3)	Pulse Width (50-100)	Chirp Width (5-20)	Pulse 1-to-2 Spacing	Pulse 2-to-3 Spacing	Starting Location Within Interval
		(μ sec)	(MHz)	(μ sec)	(μ sec)	(μ sec)
1	3	98.9	18	1308.1	1758.1	568650
2	3	98.7	18	1695.3	1690.3	67123
3	2	81	18	929		228397
4	1	64.3	18			390410
5	2	76.4	18	1343.6		550359
6	1	56.5	18			47616
7	2	69.8	18	1199.2		208712
8	1	65.1	18			370179
9	3	98.3	18	1534.7	1270.7	528943
10	3	97	18	1717	1581	27624
11	2	76.4	18	1683.6		188468
12	3	97.3	18	1588.7	1219.7	348918
13	3	98.5	18	1611.5	1263.5	509458
14	3	100	18	1471	1010	7870
15	2	72.1	18	1282.9		168818
16	1	56.6	18			330451
17	3	89.6	18	1459.4	1814.4	489199
18	1	59	18			653547

Unless otherwise stated the results shown in this test report refer only to the sample(s) tested and such sample(s) are retained for 90 days only.

除非另有說明，此報告結果僅對測試之樣品負責，同時此樣品僅保留90天。本報告未經本公司書面許可，不可部份複製。

This document is issued by the Company subject to its General Conditions of Service printed overleaf, available on request or accessible at <http://www.sgs.com.tw/Terms-and-Conditions> and for electronic format documents, subject to Terms and Conditions for Electronic Documents at <http://www.sgs.com.tw/Terms-and-Conditions>. Attention is drawn to the limitation of liability, indemnification and jurisdiction issues defined therein. Any holder of this document is advised that information contained hereon reflects the Company's findings at the time of its intervention only and within the limits of Client's instructions, if any. The Company's sole responsibility is to its Client and this document does not exonerate parties to a transaction from exercising all their rights and obligations under the transaction documents. This document cannot be reproduced except in full, without prior written approval of the Company. Any unauthorized alteration, forgery or falsification of the content or appearance of this document is unlawful and offenders may be prosecuted to the fullest extent of the law.

14.41.27 Trial 27

Data Sheet for FCC Radar Type 5						
Trial Number:		27		VSG Frequency(MHz):		5564.303
Number of Bursts in Trial:			11		Successful Detection: Yes	
Burst (8-20)	Number Pulses per Burst (1-3)	Pulse Width (50-100)	Chirp Width (5-20)	Pulse 1-to-2 Spacing	Pulse 2-to-3 Spacing	Starting Location Within Interval
		(μ sec)	(MHz)	(μ sec)	(μ sec)	(μ sec)
1	3	96	9	964	1269	244138
2	2	67.1	9	1167.9		508034
3	1	54.3	9			772920
4	3	99.9	9	1046.1	1220.1	1035183
5	3	98	9	1600	940	211483
6	1	55.5	9			476199
7	2	82.1	9	1539.9		739691
8	1	59.1	9			1005073
9	3	97.1	9	1569.9	1053.9	179037
10	2	78.3	9	1685.7		442966
11	3	85	9	1745	1510	705622

Unless otherwise stated the results shown in this test report refer only to the sample(s) tested and such sample(s) are retained for 90 days only.

除非另有說明，此報告結果僅對測試之樣品負責，同時此樣品僅保留90天。本報告未經本公司書面許可，不可部份複製。

This document is issued by the Company subject to its General Conditions of Service printed overleaf, available on request or accessible at <http://www.sgs.com.tw/Terms-and-Conditions> and for electronic format documents, subject to Terms and Conditions for Electronic Documents at <http://www.sgs.com.tw/Terms-and-Conditions>. Attention is drawn to the limitation of liability, indemnification and jurisdiction issues defined therein. Any holder of this document is advised that information contained hereon reflects the Company's findings at the time of its intervention only and within the limits of Client's instructions, if any. The Company's sole responsibility is to its Client and this document does not exonerate parties to a transaction from exercising all their rights and obligations under the transaction documents. This document cannot be reproduced except in full, without prior written approval of the Company. Any unauthorized alteration, forgery or falsification of the content or appearance of this document is unlawful and offenders may be prosecuted to the fullest extent of the law.

14.41.28 Trial 28

Data Sheet for FCC Radar Type 5						
Trial Number:		28		VSG Frequency(MHz):		5561.103
Number of Bursts in Trial:			18		Successful Detection: Yes	
Burst (8-20)	Number Pulses per Burst (1-3)	Pulse Width (50-100)	Chirp Width (5-20)	Pulse 1-to-2 Spacing	Pulse 2-to-3 Spacing	Starting Location Within Interval
		(μ sec)	(MHz)	(μ sec)	(μ sec)	(μ sec)
1	2	74	17	1226		592566
2	1	59.8	17			89732
3	2	79.3	17	1839.7		250502
4	2	76.7	17	1083.3		411804
5	2	70.6	17	1421.4		572049
6	1	61.8	17			69871
7	2	83.2	17	1608.8		230717
8	2	81.7	17	1839.3		391658
9	3	98.1	17	1843.9	1145.9	551342
10	2	83.3	17	1716.7		49863
11	1	60	17			211312
12	1	51	17			372850
13	2	68.2	17	1899.8		532734
14	2	67.8	17	1688.2		30024
15	3	96	17	1446	1613	190604
16	1	52.3	17			352547
17	1	53.4	17			513835
18	2	82.4	17	1680.6		10225

Unless otherwise stated the results shown in this test report refer only to the sample(s) tested and such sample(s) are retained for 90 days only.

除非另有說明，此報告結果僅對測試之樣品負責，同時此樣品僅保留90天。本報告未經本公司書面許可，不可部份複製。

This document is issued by the Company subject to its General Conditions of Service printed overleaf, available on request or accessible at <http://www.sgs.com.tw/Terms-and-Conditions> and for electronic format documents, subject to Terms and Conditions for Electronic Documents at <http://www.sgs.com.tw/Terms-and-Conditions>. Attention is drawn to the limitation of liability, indemnification and jurisdiction issues defined therein. Any holder of this document is advised that information contained hereon reflects the Company's findings at the time of its intervention only and within the limits of Client's instructions, if any. The Company's sole responsibility is to its Client and this document does not exonerate parties to a transaction from exercising all their rights and obligations under the transaction documents. This document cannot be reproduced except in full, without prior written approval of the Company. Any unauthorized alteration, forgery or falsification of the content or appearance of this document is unlawful and offenders may be prosecuted to the fullest extent of the law.

14.41.29 Trial 29

Data Sheet for FCC Radar Type 5						
Trial Number:		29		VSG Frequency(MHz):		5565.503
Number of Bursts in Trial:			8		Successful Detection: Yes	
Burst (8-20)	Number Pulses per Burst (1-3)	Pulse Width (50-100)	Chirp Width (5-20)	Pulse 1-to-2 Spacing	Pulse 2-to-3 Spacing	Starting Location Within Interval
		(μ sec)	(MHz)	(μ sec)	(μ sec)	(μ sec)
1	2	67	6	1136		386176
2	2	67	6	975		749473
3	3	94.8	6	946.2	1399.2	1111261
4	2	78.1	6	1873.9		1475197
5	2	81.4	6	1855.6		341314
6	2	82.5	6	1477.5		704354
7	1	52.3	6			1068403
8	3	95.9	6	1723.1	1465.1	1429278

Unless otherwise stated the results shown in this test report refer only to the sample(s) tested and such sample(s) are retained for 90 days only.

除非另有說明，此報告結果僅對測試之樣品負責，同時此樣品僅保留90天。本報告未經本公司書面許可，不可部份複製。

This document is issued by the Company subject to its General Conditions of Service printed overleaf, available on request or accessible at <http://www.sgs.com.tw/Terms-and-Conditions> and for electronic format documents, subject to Terms and Conditions for Electronic Documents at <http://www.sgs.com.tw/Terms-and-Conditions>. Attention is drawn to the limitation of liability, indemnification and jurisdiction issues defined therein. Any holder of this document is advised that information contained hereon reflects the Company's findings at the time of its intervention only and within the limits of Client's instructions, if any. The Company's sole responsibility is to its Client and this document does not exonerate parties to a transaction from exercising all their rights and obligations under the transaction documents. This document cannot be reproduced except in full, without prior written approval of the Company. Any unauthorized alteration, forgery or falsification of the content or appearance of this document is unlawful and offenders may be prosecuted to the fullest extent of the law.

14.41.30 Trial 30

Data Sheet for FCC Radar Type 5						
Trial Number:		30		VSG Frequency(MHz):		5561.103
Number of Bursts in Trial:			18		Successful Detection: Yes	
Burst (8-20)	Number Pulses per Burst (1-3)	Pulse Width (50-100)	Chirp Width (5-20)	Pulse 1-to-2 Spacing	Pulse 2-to-3 Spacing	Starting Location Within Interval
		(μ sec)	(MHz)	(μ sec)	(μ sec)	(μ sec)
1	3	99.1	17	1050.9	1191.9	131268
2	1	50.7	17			293150
3	2	75.5	17	1479.5		453485
4	2	82.2	17	1702.8		613895
5	2	67.3	17	1725.7		111637
6	1	59.4	17			273119
7	3	91.5	17	1718.5	1057.5	432670
8	2	80.2	17	1136.8		594976
9	2	74.2	17	975.8		91921
10	3	87.2	17	1141.8	1835.8	252079
11	3	97.2	17	1803.8	1028.8	413002
12	2	70.5	17	1487.5		574498
13	2	77.9	17	1638.1		71981
14	3	88.2	17	1134.8	1636.8	232616
15	3	88.9	17	1484.1	1059.1	393436
16	2	74.9	17	1917.1		554812
17	3	91.5	17	1591.5	1728.5	52089
18	2	75.8	17	1480.2		213172

Unless otherwise stated the results shown in this test report refer only to the sample(s) tested and such sample(s) are retained for 90 days only.

除非另有說明，此報告結果僅對測試之樣品負責，同時此樣品僅保留90天。本報告未經本公司書面許可，不可部份複製。

This document is issued by the Company subject to its General Conditions of Service printed overleaf, available on request or accessible at <http://www.sgs.com.tw/Terms-and-Conditions> and for electronic format documents, subject to Terms and Conditions for Electronic Documents at <http://www.sgs.com.tw/Terms-and-Conditions>. Attention is drawn to the limitation of liability, indemnification and jurisdiction issues defined therein. Any holder of this document is advised that information contained hereon reflects the Company's findings at the time of its intervention only and within the limits of Client's instructions, if any. The Company's sole responsibility is to its Client and this document does not exonerate parties to a transaction from exercising all their rights and obligations under the transaction documents. This document cannot be reproduced except in full, without prior written approval of the Company. Any unauthorized alteration, forgery or falsification of the content or appearance of this document is unlawful and offenders may be prosecuted to the fullest extent of the law.

14.42 Radar Type 6 for 5530 MHz:

Data Sheet for FCC Radar Type 6						
Trial	Pulse Width	PRI	Pulses per Hop	Hopping Rate	Hopping Sequence Length	Successful Detection
	(μ sec)	(μ sec)		(kHz)	(msec)	(Yes/No)
1	1	333	9	0.333	300	Yes
2	1	333	9	0.333	300	Yes
3	1	333	9	0.333	300	Yes
4	1	333	9	0.333	300	Yes
5	1	333	9	0.333	300	Yes
6	1	333	9	0.333	300	Yes
7	1	333	9	0.333	300	Yes
8	1	333	9	0.333	300	Yes
9	1	333	9	0.333	300	Yes
10	1	333	9	0.333	300	Yes
11	1	333	9	0.333	300	Yes
12	1	333	9	0.333	300	Yes
13	1	333	9	0.333	300	Yes
14	1	333	9	0.333	300	Yes
15	1	333	9	0.333	300	Yes
16	1	333	9	0.333	300	Yes
17	1	333	9	0.333	300	Yes
18	1	333	9	0.333	300	Yes
19	1	333	9	0.333	300	Yes
20	1	333	9	0.333	300	Yes
21	1	333	9	0.333	300	Yes
22	1	333	9	0.333	300	Yes
23	1	333	9	0.333	300	Yes
24	1	333	9	0.333	300	Yes
25	1	333	9	0.333	300	Yes
26	1	333	9	0.333	300	Yes
27	1	333	9	0.333	300	Yes
28	1	333	9	0.333	300	Yes
29	1	333	9	0.333	300	Yes
30	1	333	9	0.333	300	Yes

~End of Report~

Unless otherwise stated the results shown in this test report refer only to the sample(s) tested and such sample(s) are retained for 90 days only.

除非另有說明，此報告結果僅對測試之樣品負責，同時此樣品僅保留90天。本報告未經本公司書面許可，不可部份複製。

This document is issued by the Company subject to its General Conditions of Service printed overleaf, available on request or accessible at <http://www.sgs.com.tw/Terms-and-Conditions> and for electronic format documents, subject to Terms and Conditions for Electronic Documents at <http://www.sgs.com.tw/Terms-and-Conditions>. Attention is drawn to the limitation of liability, indemnification and jurisdiction issues defined therein. Any holder of this document is advised that information contained hereon reflects the Company's findings at the time of its intervention only and within the limits of Client's instructions, if any. The Company's sole responsibility is to its Client and this document does not exonerate parties to a transaction from exercising all their rights and obligations under the transaction documents. This document cannot be reproduced except in full, without prior written approval of the Company. Any unauthorized alteration, forgery or falsification of the content or appearance of this document is unlawful and offenders may be prosecuted to the fullest extent of the law.