

## ELECTROMAGNETIC EMISSIONS COMPLIANCE REPORT

**Applicant:** CastleNet Technology Inc.  
No. 14, Ln. 141, Sec. 3, Beishen Rd., Shenkeng Dist.,  
New Taipei City 22244, Taiwan (R.O.C.)

**Product Name:** Wireless Cable Gateway

**Brand Name:** Castlenet

**Model No.:** CBV384Z4

**Model Difference:** N/A

**Report Number:** E2/2020/B0037-01

**FCC ID** RK9-CBV384Z4

**FCC Rule Part:** §15.407, Cat: U-NII

**Issue Date:** Feb. 23, 2021

**Date of Test:** Nov. 23, 2020 - Jan. 08, 2021

**Date of EUT Received:** Nov. 23, 2020

**We hereby certify that:**

The above equipment was tested by SGS Taiwan Ltd. Central RF Lab The test data, data evaluation, test procedures, and equipment configurations shown in this report were made in accordance with the procedures given in ANSI C63.10: 2013 and the energy emitted by the sample EUT tested as described in this report is in compliance with conducted and radiated emission limits.

The test results of this report relate only to the tested sample identified in this report.

**Approved By:**

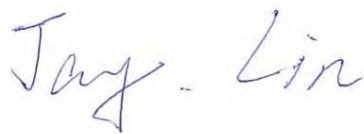

**Jay Lin / Asst. Supervisor**



Unless otherwise stated the results shown in this test report refer only to the sample(s) tested and such sample(s) are retained for 90 days only.

除非另有說明，此報告結果僅對測試之樣品負責，同時此樣品僅保留90天。本報告未經本公司書面許可，不可部份複製。

This document is issued by the Company subject to its General Conditions of Service printed overleaf, available on request or accessible at <http://www.sgs.com.tw/Terms-and-Conditions> and for electronic format documents, subject to Terms and Conditions for Electronic Documents at <http://www.sgs.com.tw/Terms-and-Conditions>. Attention is drawn to the limitation of liability, indemnification and jurisdiction issues defined therein. Any holder of this document is advised that information contained hereon reflects the Company's findings at the time of its intervention only and within the limits of Client's instructions, if any. The Company's sole responsibility is to its Client and this document does not exonerate parties to a transaction from exercising all their rights and obligations under the transaction documents. This document cannot be reproduced except in full, without prior written approval of the Company. Any unauthorized alteration, forgery or falsification of the content or appearance of this document is unlawful and offenders may be prosecuted to the fullest extent of the law.

## Revision History

Report Number	Revision	Description	Issue Date	Remark
E2/2020/B0037	Rev.00	Original.	Jan. 15, 2021	Revised By: Yuri Tsai
E2/2020/B0037-01	Rev.01	B2 & B3 disabled via software	Feb. 23, 2021	Revised By: Yuri Tsai

**Note:**

- 1、Addendum to the original test report  
This test report is an addendum to the original test report E2/2020/B0037, EUTs represent the original test report and this test report are assessed as identical in hardware and software, measurement results in the original report are fully leveraged in this test report without further verification test.
- 2、Disclaimer  
Antenna information is provided by the applicant, test results of this report are applicable to the sample EUT received.

Unless otherwise stated the results shown in this test report refer only to the sample(s) tested and such sample(s) are retained for 90 days only.

除非另有說明，此報告結果僅對測試之樣品負責，同時此樣品僅保留90天。本報告未經本公司書面許可，不可部份複製。

This document is issued by the Company subject to its General Conditions of Service printed overleaf, available on request or accessible at <http://www.sgs.com.tw/Terms-and-Conditions> and for electronic format documents, subject to Terms and Conditions for Electronic Documents at <http://www.sgs.com.tw/Terms-and-Conditions>. Attention is drawn to the limitation of liability, indemnification and jurisdiction issues defined therein. Any holder of this document is advised that information contained hereon reflects the Company's findings at the time of its intervention only and within the limits of Client's instructions, if any. The Company's sole responsibility is to its Client and this document does not exonerate parties to a transaction from exercising all their rights and obligations under the transaction documents. This document cannot be reproduced except in full, without prior written approval of the Company. Any unauthorized alteration, forgery or falsification of the content or appearance of this document is unlawful and offenders may be prosecuted to the fullest extent of the law.

## Contents

<b>1</b>	<b>GENERAL INFORMATION .....</b>	<b>4</b>
<b>2</b>	<b>SYSTEM TEST CONFIGURATION.....</b>	<b>7</b>
<b>3</b>	<b>SUMMARY OF TEST RESULT .....</b>	<b>10</b>
<b>4</b>	<b>DESCRIPTION OF TEST MODES.....</b>	<b>11</b>
<b>5</b>	<b>MEASUREMENT UNCERTAINTY .....</b>	<b>14</b>
<b>6</b>	<b>CONDUCTED EMISSION TEST.....</b>	<b>15</b>
<b>7</b>	<b>DUTY CYCLE TEST SIGNAL .....</b>	<b>19</b>
<b>8</b>	<b>26dB &amp;6dB EMISSION BANDWIDTH MEASUREMENT .....</b>	<b>22</b>
<b>9</b>	<b>MAXIMUM CONDUCTED OUTPUT POWER MEASUREMENT .....</b>	<b>38</b>
<b>10</b>	<b>MAXIMUM POWER SPECTRAL DENSITY.....</b>	<b>41</b>
<b>11</b>	<b>UNDESIRABLE RADIATED EMISSION MEASUREMENT .....</b>	<b>54</b>
<b>12</b>	<b>TRANSMISSION IN THE ABSENCE OF DATA.....</b>	<b>130</b>
<b>13</b>	<b>ANTENNA REQUIREMENT.....</b>	<b>131</b>

Unless otherwise stated the results shown in this test report refer only to the sample(s) tested and such sample(s) are retained for 90 days only.

除非另有說明，此報告結果僅對測試之樣品負責，同時此樣品僅保留90天。本報告未經本公司書面許可，不可部份複製。

This document is issued by the Company subject to its General Conditions of Service printed overleaf, available on request or accessible at <http://www.sgs.com.tw/Terms-and-Conditions> and for electronic format documents, subject to Terms and Conditions for Electronic Documents at <http://www.sgs.com.tw/Terms-and-Conditions>. Attention is drawn to the limitation of liability, indemnification and jurisdiction issues defined therein. Any holder of this document is advised that information contained hereon reflects the Company's findings at the time of its intervention only and within the limits of Client's instructions, if any. The Company's sole responsibility is to its Client and this document does not exonerate parties to a transaction from exercising all their rights and obligations under the transaction documents. This document cannot be reproduced except in full, without prior written approval of the Company. Any unauthorized alteration, forgery or falsification of the content or appearance of this document is unlawful and offenders may be prosecuted to the fullest extent of the law.

# 1 GENERAL INFORMATION

## 1.1 Product Description

Product Name:	Wireless Cable Gateway	
Brand Name:	Castlenet	
Model No.:	CBV384Z4	
Model Difference:	N/A	
Hardware Version:	N/A	
Software Version:	N/A	
EUT Series No.:	PJ20B158002	
Power Supply:	12Vdc from AC/DC Adapter	
Modulation type:	64QAM, 16QAM, QPSK, BPSK for OFDM 256QAM for OFDM in 802.11ac only	
Transition Rate:	802.11 a: 6/9/12/18/24/36/48/54 Mbps 802.11 n_20MHz: 6.5 – 288.9Mbps 802.11 n_40MHz: 13.5 – 600.0Mbps	802.11 ac_20MHz: 6.5 –346.8Mbps 802.11 ac_40MHz: 13.5 –800.0Mbps 802.11 ac_80MHz: 29.3 – 1733.2Mbps

Unless otherwise stated the results shown in this test report refer only to the sample(s) tested and such sample(s) are retained for 90 days only.

除非另有說明，此報告結果僅對測試之樣品負責，同時此樣品僅保留90天。本報告未經本公司書面許可，不可部份複製。

This document is issued by the Company subject to its General Conditions of Service printed overleaf, available on request or accessible at <http://www.sgs.com.tw/Terms-and-Conditions> and for electronic format documents, subject to Terms and Conditions for Electronic Documents at <http://www.sgs.com.tw/Terms-and-Conditions>. Attention is drawn to the limitation of liability, indemnification and jurisdiction issues defined therein. Any holder of this document is advised that information contained hereon reflects the Company's findings at the time of its intervention only and within the limits of Client's instructions, if any. The Company's sole responsibility is to its Client and this document does not exonerate parties to a transaction from exercising all their rights and obligations under the transaction documents. This document cannot be reproduced except in full, without prior written approval of the Company. Any unauthorized alteration, forgery or falsification of the content or appearance of this document is unlawful and offenders may be prosecuted to the fullest extent of the law.

## 1.2 Antenna Designation

Ant. Type	Ch0/Ch1/Ch2/Ch3	Supplier	Part No.	Freq.(MHz)	Peak Gain (dBi)	Worst Antenna Gain
PCB	Ch0	AnJie	CBV384Z4-AC2800	5150~5250	2.90	V
				5725~5850	2.97	
PCB	Ch1	AnJie	CBV384Z4-AC2800	5150~5250	2.69	
				5725~5850	2.97	
PCB	Ch2	AnJie	CBV384Z4-AC2800	5150~5250	2.93	V
				5725~5850	2.93	
PCB	Ch3	AnJie	CBV384Z4-AC2800	5150~5250	2.67	
				5725~5850	2.83	

Note: Investigation has been done to determine the worst case scenario for the above antennas demonstrated with measurements in this report.

## 1.3 Worst power

Wi-Fi 802.11	Frequency Range	Channels	Rated Power (Avg.) (dBm) (Worst case)	Modulation Technology
a	5150~5250	4	21.99	OFDM
	5725~5850	5	21.92	
n_HT ac_VHT 20M	5150~5250	4	HT: 26.63	OFDM
	5725~5850	5	HT: 26.69	
n_HT ac_VHT 40M	5150~5250	2	HT: 26.57	OFDM
	5725~5850	2	HT: 25.63	
ac_VHT 80M	5150~5250	1	21.06	OFDM
	5725~5850	1	20.68	

Unless otherwise stated the results shown in this test report refer only to the sample(s) tested and such sample(s) are retained for 90 days only.

除非另有說明，此報告結果僅對測試之樣品負責，同時此樣品僅保留90天。本報告未經本公司書面許可，不可部份複製。

This document is issued by the Company subject to its General Conditions of Service printed overleaf, available on request or accessible at <http://www.sgs.com.tw/Terms-and-Conditions> and for electronic format documents, subject to Terms and Conditions for Electronic Documents at <http://www.sgs.com.tw/Terms-and-Conditions>. Attention is drawn to the limitation of liability, indemnification and jurisdiction issues defined therein. Any holder of this document is advised that information contained hereon reflects the Company's findings at the time of its intervention only and within the limits of Client's instructions, if any. The Company's sole responsibility is to its Client and this document does not exonerate parties to a transaction from exercising all their rights and obligations under the transaction documents. This document cannot be reproduced except in full, without prior written approval of the Company. Any unauthorized alteration, forgery or falsification of the content or appearance of this document is unlawful and offenders may be prosecuted to the fullest extent of the law.

#### 1.4 Test Methodology of Applied Standards

FCC Part 15, Subpart E §15.407  
FCC KDB 789033 D02 General UNII Test Procedures New Rules v02r01  
FCC KDB 662911 D01 Multiple Transmitter Output v02r01  
ANSI C63.10:2013

#### 1.5 Test Facility

SGS Taiwan Ltd. Central RF Lab (TAF code 3702)  
No.2, Keji 1st Rd., Guishan District, Taoyuan City, Taiwan 333

FCC Designation number: TW0028

#### 1.6 Special Accessories

There are no special accessories used while test was conducted.

#### 1.7 Equipment Modifications

There was no modification incorporated into the EUT.

Unless otherwise stated the results shown in this test report refer only to the sample(s) tested and such sample(s) are retained for 90 days only.

除非另有說明，此報告結果僅對測試之樣品負責，同時此樣品僅保留90天。本報告未經本公司書面許可，不可部份複製。

This document is issued by the Company subject to its General Conditions of Service printed overleaf, available on request or accessible at <http://www.sgs.com.tw/Terms-and-Conditions> and for electronic format documents, subject to Terms and Conditions for Electronic Documents at <http://www.sgs.com.tw/Terms-and-Conditions>. Attention is drawn to the limitation of liability, indemnification and jurisdiction issues defined therein. Any holder of this document is advised that information contained hereon reflects the Company's findings at the time of its intervention only and within the limits of Client's instructions, if any. The Company's sole responsibility is to its Client and this document does not exonerate parties to a transaction from exercising all their rights and obligations under the transaction documents. This document cannot be reproduced except in full, without prior written approval of the Company. Any unauthorized alteration, forgery or falsification of the content or appearance of this document is unlawful and offenders may be prosecuted to the fullest extent of the law.

## 2 SYSTEM TEST CONFIGURATION

### 2.1 EUT Configuration

The EUT configuration for testing is installed on RF field strength measurement to meet the Commissions requirement and operating in a manner which intends to maximize its emission characteristics in a continuous normal application.

### 2.2 EUT Exercise

An engineering test mode (software/firmware) that applicant provided was utilized to manipulate the EUT into transmit, selection of the test channel, and modulation scheme.

### 2.3 Test Procedure

#### 2.3.1 Conducted Emissions

The EUT is a placed on a table which is 0.8 m above ground plane. Conducted emissions from the EUT measured in the frequency range between 0.15 MHz and 30MHz. The CISPR Quasi-Peak and Average detector mode is employed. The two LISNs provide 50uH/50 ohm of coupling impedance for the measuring instrument. Both lines of the power mains connected to the EUT were checked for maximum conducted interference.

#### 2.3.2 Conducted Test (RF)

The active antenna port of the unlicensed wireless device is connected to the spectrum analyzer with attenuator to protect the instrumentation. If a second antenna port is available, it is tested at one operating frequency, with other port(s) appropriately terminated, to verify it has similar output characteristics as the fully tested port.

#### 2.3.3 Radiated Emissions

The EUT is a placed on a turn table. For emissions testing at or below 1 GHz, the table height shall be 0.8 m above the reference ground plane. For emission measurements above 1 GHz, the table height shall be 1.5 m. The turn table shall rotate 360 degrees to determine the position of maximum emission level. EUT is set 3m away from the receiving antenna which varied from 1m to 4m to find out the highest emission. And also, each emission was to be maximized by changing the polarization of receiving antenna both horizontal and vertical. In order to find out the max. emission, the relative positions of this transmitter (EUT) was rotated through three orthogonal axes and measurement procedures for electric field radiated emissions above 1 GHz the EUT measurement is to be made "while keeping the antenna in the 'cone of radiation' from that area and pointed at the area both in azimuth and elevation, with polarization oriented for maximum response." is still within the 3dB illumination BW of the measurement antenna.

Unless otherwise stated the results shown in this test report refer only to the sample(s) tested and such sample(s) are retained for 90 days only.

除非另有說明，此報告結果僅對測試之樣品負責，同時此樣品僅保留90天。本報告未經本公司書面許可，不可部份複製。

This document is issued by the Company subject to its General Conditions of Service printed overleaf, available on request or accessible at <http://www.sgs.com.tw/Terms-and-Conditions> and for electronic format documents, subject to Terms and Conditions for Electronic Documents at <http://www.sgs.com.tw/Terms-and-Conditions>. Attention is drawn to the limitation of liability, indemnification and jurisdiction issues defined therein. Any holder of this document is advised that information contained hereon reflects the Company's findings at the time of its intervention only and within the limits of Client's instructions, if any. The Company's sole responsibility is to its Client and this document does not exonerate parties to a transaction from exercising all their rights and obligations under the transaction documents. This document cannot be reproduced except in full, without prior written approval of the Company. Any unauthorized alteration, forgery or falsification of the content or appearance of this document is unlawful and offenders may be prosecuted to the fullest extent of the law.

## 2.4 Measurement Results Explanation Example

### 2.4.1 Radiated Emission Test Sites For Measurements From 9 kHz To 30 MHz

Radiated emission below 30MHz is measured in a 9m\*9m\*6m semi-anechoic chamber, the measurements correspond to those obtained at an open-field test site.

There is a comparison data of both open-field test site and semi-Anechoic chamber, and the result came out very similar.

### 2.4.2 For all conducted test items:

The offset level is set in the spectrum analyzer to compensate the RF cable loss and attenuation factor between EUT conducted port and spectrum analyzer. With the offset compensation, the spectrum analyzer reading level is exactly EUT RF output level.

Unless otherwise stated the results shown in this test report refer only to the sample(s) tested and such sample(s) are retained for 90 days only.

除非另有說明，此報告結果僅對測試之樣品負責，同時此樣品僅保留90天。本報告未經本公司書面許可，不可部份複製。

This document is issued by the Company subject to its General Conditions of Service printed overleaf, available on request or accessible at <http://www.sgs.com.tw/Terms-and-Conditions> and for electronic format documents, subject to Terms and Conditions for Electronic Documents at <http://www.sgs.com.tw/Terms-and-Conditions>. Attention is drawn to the limitation of liability, indemnification and jurisdiction issues defined therein. Any holder of this document is advised that information contained hereon reflects the Company's findings at the time of its intervention only and within the limits of Client's instructions, if any. The Company's sole responsibility is to its Client and this document does not exonerate parties to a transaction from exercising all their rights and obligations under the transaction documents. This document cannot be reproduced except in full, without prior written approval of the Company. Any unauthorized alteration, forgery or falsification of the content or appearance of this document is unlawful and offenders may be prosecuted to the fullest extent of the law.



## 2.5 Configuration of Tested System

Fig. 2-1 Radiated Emission Configuration

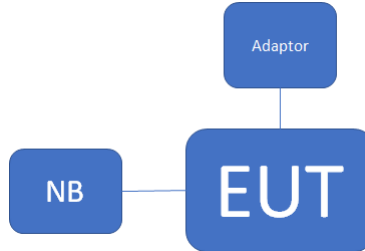

Fig. 2-2 Conducted (Antenna Port) Emission Configuration

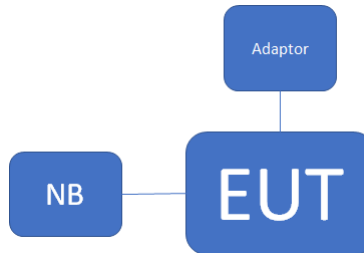

Fig. 2-3 Conducted (AC powerline) Emission Configuration

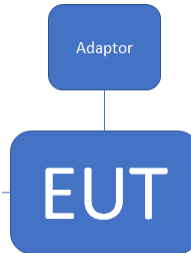

Table 2-1 Equipment Used in Tested System

Item	Equipment	Mfr/Brand	Model/Type No.	Series No.	Data Cable	Power Cord
1.	WLAN Test Software	N/A	N/A	N/A	N/A	N/A
2.	Notebook	Lenovo	L420	S0011721	N/A	N/A

Unless otherwise stated the results shown in this test report refer only to the sample(s) tested and such sample(s) are retained for 90 days only.

除非另有說明，此報告結果僅對測試之樣品負責，同時此樣品僅保留90天。本報告未經本公司書面許可，不可部份複製。

This document is issued by the Company subject to its General Conditions of Service printed overleaf, available on request or accessible at <http://www.sgs.com.tw/Terms-and-Conditions> and for electronic format documents, subject to Terms and Conditions for Electronic Documents at <http://www.sgs.com.tw/Terms-and-Conditions>. Attention is drawn to the limitation of liability, indemnification and jurisdiction issues defined therein. Any holder of this document is advised that information contained hereon reflects the Company's findings at the time of its intervention only and within the limits of Client's instructions, if any. The Company's sole responsibility is to its Client and this document does not exonerate parties to a transaction from exercising all their rights and obligations under the transaction documents. This document cannot be reproduced except in full, without prior written approval of the Company. Any unauthorized alteration, forgery or falsification of the content or appearance of this document is unlawful and offenders may be prosecuted to the fullest extent of the law.

### 3 SUMMARY OF TEST RESULT

FCC Rules	Description Of Test	Result
§15.207	AC Power Line Conducted Emission	Compliant
§15.403(i) §15.407(e)	26 dB & 6dB Emission Bandwidth	Compliant
§15.407(a)	Maximum Conducted Output Power	Compliant
§15.407(a)	Power Spectral Density	Compliant
§15.205 §15.209 §15.407(b)	Undesirable Radiated Emissions	Compliant
§15.407(c)	Transmission in case of Absence of Information	Compliant
§15.203 §15.407(a)	Antenna Requirement	Compliant

Unless otherwise stated the results shown in this test report refer only to the sample(s) tested and such sample(s) are retained for 90 days only.

除非另有說明，此報告結果僅對測試之樣品負責，同時此樣品僅保留90天。本報告未經本公司書面許可，不可部份複製。

This document is issued by the Company subject to its General Conditions of Service printed overleaf, available on request or accessible at <http://www.sgs.com.tw/Terms-and-Conditions> and for electronic format documents, subject to Terms and Conditions for Electronic Documents at <http://www.sgs.com.tw/Terms-and-Conditions>. Attention is drawn to the limitation of liability, indemnification and jurisdiction issues defined therein. Any holder of this document is advised that information contained hereon reflects the Company's findings at the time of its intervention only and within the limits of Client's instructions, if any. The Company's sole responsibility is to its Client and this document does not exonerate parties to a transaction from exercising all their rights and obligations under the transaction documents. This document cannot be reproduced except in full, without prior written approval of the Company. Any unauthorized alteration, forgery or falsification of the content or appearance of this document is unlawful and offenders may be prosecuted to the fullest extent of the law.

## 4 DESCRIPTION OF TEST MODES

### 4.1 802.11a/n/ac operated in U-NII Bands

#### Operated band in 5150 MHz ~5250 MHz:

20 M		40 M		80 M	
CH	Freq (MHz)	CH	Freq (MHz)	CH	Freq (MHz)
36	5180	38	5190	42	5210
40	5200	46	5230		
44	5220				
48	5240				

#### Operated band in 5745 MHz ~5850 MHz:

20 M		40 M		80 M	
CH	Freq (MHz)	CH	Freq (MHz)	CH	Freq (MHz)
149	5745	151	5755	155	5775
153	5765	159	5795		
157	5785				
161	5805				
165	5825				

Unless otherwise stated the results shown in this test report refer only to the sample(s) tested and such sample(s) are retained for 90 days only.

除非另有說明，此報告結果僅對測試之樣品負責，同時此樣品僅保留90天。本報告未經本公司書面許可，不可部份複製。

This document is issued by the Company subject to its General Conditions of Service printed overleaf, available on request or accessible at <http://www.sgs.com.tw/Terms-and-Conditions> and for electronic format documents, subject to Terms and Conditions for Electronic Documents at <http://www.sgs.com.tw/Terms-and-Conditions>. Attention is drawn to the limitation of liability, indemnification and jurisdiction issues defined therein. Any holder of this document is advised that information contained hereon reflects the Company's findings at the time of its intervention only and within the limits of Client's instructions, if any. The Company's sole responsibility is to its Client and this document does not exonerate parties to a transaction from exercising all their rights and obligations under the transaction documents. This document cannot be reproduced except in full, without prior written approval of the Company. Any unauthorized alteration, forgery or falsification of the content or appearance of this document is unlawful and offenders may be prosecuted to the fullest extent of the law.

#### 4.2 The Worst Test Modes and Channel Details

1. The EUT has been tested under operating condition.
2. Test program used to control the EUT for staying in continuous transmitting mode is programmed.
3. Investigation has been done on all the possible configurations for searching the worst case. The gevin UE is pre-scanned among below modes.

Modulation	Transmission Chain				Single Transmission Spatial	Multiple Transmission Spatial
<input checked="" type="checkbox"/> 802.11 a	<input checked="" type="checkbox"/> Ch0	<input checked="" type="checkbox"/> Ch1	<input checked="" type="checkbox"/> Ch2	<input checked="" type="checkbox"/> Ch3	<input type="checkbox"/> 1TX	<input checked="" type="checkbox"/> 3TX
<input checked="" type="checkbox"/> 802.11 n	<input checked="" type="checkbox"/> Ch0	<input checked="" type="checkbox"/> Ch1	<input checked="" type="checkbox"/> Ch2	<input checked="" type="checkbox"/> Ch3	<input type="checkbox"/> SISO	<input checked="" type="checkbox"/> 4TX MIMO
<input checked="" type="checkbox"/> 802.11 ac	<input checked="" type="checkbox"/> Ch0	<input checked="" type="checkbox"/> Ch1	<input checked="" type="checkbox"/> Ch2	<input checked="" type="checkbox"/> Ch3	<input type="checkbox"/> SISO	<input checked="" type="checkbox"/> 4TX MIMO

4. Therefore, below summary is the modes of test configuration that yield the highest reading and generate the highest emission chosen to carry out the relevantly mandatory test items.

Unless otherwise stated the results shown in this test report refer only to the sample(s) tested and such sample(s) are retained for 90 days only.

除非另有說明，此報告結果僅對測試之樣品負責，同時此樣品僅保留90天。本報告未經本公司書面許可，不可部份複製。

This document is issued by the Company subject to its General Conditions of Service printed overleaf, available on request or accessible at <http://www.sgs.com.tw/Terms-and-Conditions> and for electronic format documents, subject to Terms and Conditions for Electronic Documents at <http://www.sgs.com.tw/Terms-and-Conditions>. Attention is drawn to the limitation of liability, indemnification and jurisdiction issues defined therein. Any holder of this document is advised that information contained hereon reflects the Company's findings at the time of its intervention only and within the limits of Client's instructions, if any. The Company's sole responsibility is to its Client and this document does not exonerate parties to a transaction from exercising all their rights and obligations under the transaction documents. This document cannot be reproduced except in full, without prior written approval of the Company. Any unauthorized alteration, forgery or falsification of the content or appearance of this document is unlawful and offenders may be prosecuted to the fullest extent of the law.

**4.2.1 RADIATED EMISSION TEST:**

RADIATED EMISSION TEST (BELOW 1 GHz)						
MODE	FREQUENCY BAND (MHz)	AVAILABLE CHANNEL	TESTED CHANNEL	MODULATION	DATA RATE (Mbps)	ANTENNA PORT
802.11a	5180~5240	36 to 48	44	OFDM	6	ch1
	5745~5825	149 to 165	157			
802.11ac_VHT80	5190~5230	42	42	OFDM	MCS0	MIMO
	5775	155	155			

RADIATED EMISSION TEST (ABOVE 1 GHz)						
MODE	FREQUENCY BAND (MHz)	AVAILABLE CHANNEL	TESTED CHANNEL	MODULATION	DATA RATE (Mbps)	ANTENNA PORT
802.11a	5180~5240	36 to 48	36,44,48	OFDM	6	ch1
	5745~5825	149 to 165	149,157,165			
802.11n_HT20	5180~5240	36 to 48	36,44,48	OFDM	MCS0	MIMO
	5745~5825	149 to 165	149,157,165			
802.11n_HT40	5190~5230	38 to 46	38,46	OFDM	MCS0	MIMO
	5755~5795	151 to 159	151,159			
802.11ac_VHT80	5210	42	42	OFDM	MCS0	MIMO
	5775	155	155			

**Note:**

The field strength of radiation emission was measured as EUT stand-up position (H mode) and lie down position (E1, E2 mode) for 802.11a/n/ac WLAN Transmitter for channel Low, Mid and High, the worst case H position was reported.

**4.2.2 ANTENNA PORT CONDUCTED MEASUREMENT:**

CONDUCTED TEST						
MODE	FREQUENCY BAND (MHz)	AVAILABLE CHANNEL	TESTED CHANNEL	MODULATION	DATA RATE (Mbps)	ANTENNA PORT
802.11a	5180~5240	36 to 48	36,44,48	OFDM	6	ch1
	5745~5825	149 to 165	149,157,165			
802.11n_HT20	5180~5240	36 to 48	36,44,48	OFDM	MCS0	MIMO
	5745~5825	149 to 165	149,157,165			
802.11n_HT40	5190~5230	38 to 46	38,46	OFDM	MCS0	MIMO
	5755~5795	151 to 159	151,159			
802.11ac_VHT80	5210	42	42	MNSS	MCS0	MIMO
	5775	155	155			

Unless otherwise stated the results shown in this test report refer only to the sample(s) tested and such sample(s) are retained for 90 days only.

除非另有說明，此報告結果僅對測試之樣品負責，同時此樣品僅保留90天。本報告未經本公司書面許可，不可部份複製。

This document is issued by the Company subject to its General Conditions of Service printed overleaf, available on request or accessible at <http://www.sgs.com.tw/Terms-and-Conditions> and for electronic format documents, subject to Terms and Conditions for Electronic Documents at <http://www.sgs.com.tw/Terms-and-Conditions>. Attention is drawn to the limitation of liability, indemnification and jurisdiction issues defined therein. Any holder of this document is advised that information contained hereon reflects the Company's findings at the time of its intervention only and within the limits of Client's instructions, if any. The Company's sole responsibility is to its Client and this document does not exonerate parties to a transaction from exercising all their rights and obligations under the transaction documents. This document cannot be reproduced except in full, without prior written approval of the Company. Any unauthorized alteration, forgery or falsification of the content or appearance of this document is unlawful and offenders may be prosecuted to the fullest extent of the law.

## 5 MEASUREMENT UNCERTAINTY

Test Items	Uncertainty
AC Power Line Conducted Emission	+/- 2.34 dB
26dB & 6dB Emission Bandwidth	+/- 1.54 Hz
The Maximum Output Power Measurement	+/- 1 dB
Peak Power Spectral Density Measurement	+/- 1.54 dB
Frequency Stability	+/- 1.54 Hz
Temperature	+/- 0.4 °C
Humidity	+/- 3.5 %
DC / AC Power Source	DC= +/- 1%, AC= +/- 1%

Radiated Spurious Emission Measurement Uncertainty		
<b>Polarization: Vertical</b>	+/- 2.64 dB	9kHz~30MHz: +/-2.3dB
	+/- 4.93 dB	30MHz - 1000MHz: +/- 3.37dB
	+/- 4.81 dB	1GHz - 18GHz: +/- 4.04dB
	+/- 4.52 dB	18GHz - 40GHz: +/- 4.04dB
<b>Polarization: Horizontal</b>	+/- 2.64 dB	9kHz~30MHz: +/-2.3dB
	+/- 4.45 dB	30MHz - 1000MHz: +/- 4.22dB
	+/- 4.81 dB	1GHz - 18GHz: +/- 4.08dB
	+/- 4.52 dB	18GHz - 40GHz: +/- 4.08dB

**Note:**

1. This uncertainty represents an expanded uncertainty expressed at approximately the 95% confidence level using a coverage factor of k=2.
2. The conformity assessment statement in this report is based solely on the test results, measurement uncertainty is excluded.

Unless otherwise stated the results shown in this test report refer only to the sample(s) tested and such sample(s) are retained for 90 days only.

除非另有說明，此報告結果僅對測試之樣品負責，同時此樣品僅保留90天。本報告未經本公司書面許可，不可部份複製。

This document is issued by the Company subject to its General Conditions of Service printed overleaf, available on request or accessible at <http://www.sgs.com.tw/Terms-and-Conditions> and for electronic format documents, subject to Terms and Conditions for Electronic Documents at <http://www.sgs.com.tw/Terms-and-Conditions>. Attention is drawn to the limitation of liability, indemnification and jurisdiction issues defined therein. Any holder of this document is advised that information contained hereon reflects the Company's findings at the time of its intervention only and within the limits of Client's instructions, if any. The Company's sole responsibility is to its Client and this document does not exonerate parties to a transaction from exercising all their rights and obligations under the transaction documents. This document cannot be reproduced except in full, without prior written approval of the Company. Any unauthorized alteration, forgery or falsification of the content or appearance of this document is unlawful and offenders may be prosecuted to the fullest extent of the law.

## 6 CONDUCTED EMISSION TEST

### 6.1 Standard Applicable

Frequency range within 150 kHz to 30 MHz shall not exceed the Limit table as below.

Frequency range MHz	Limits dB(uV)	
	Quasi-peak	Average
0.15 to 0.50	66 to 56	56 to 46
0.50 to 5	56	46
5 to 30	60	50

Note

- The lower limit shall apply at the transition frequencies
- The limit decreases linearly with the logarithm of the frequency in the range 0.15 MHz to 0.50 MHz.

### 6.2 Measurement Equipment Used

Conducted Emission Test Site					
EQUIPMENT TYPE	MFR	MODEL NUMBER	SERIAL NUMBER	LAST CAL.	CAL DUE.
LISN	SCHWARZBECK Mess-Elektronik	NSLK8127	974	03/25/2020	03/24/2021
EMI Test Receiver	R&S	ESCI	101342	04/28/2020	04/27/2021

### 6.3 EUT Setup

- The conducted emission tests were performed in the test site, using the setup in accordance with the ANSI C63.10:2013.
- The AC/DC Power adaptor of EUT was plug-in LISN. The rear of the EUT and peripherals were placed flushed with the rear of the tabletop.
- The LISN was connected with 120Vac/60Hz power source.

Unless otherwise stated the results shown in this test report refer only to the sample(s) tested and such sample(s) are retained for 90 days only.

除非另有說明，此報告結果僅對測試之樣品負責，同時此樣品僅保留90天。本報告未經本公司書面許可，不可部份複製。

This document is issued by the Company subject to its General Conditions of Service printed overleaf, available on request or accessible at <http://www.sgs.com.tw/Terms-and-Conditions> and for electronic format documents, subject to Terms and Conditions for Electronic Documents at <http://www.sgs.com.tw/Terms-and-Conditions>. Attention is drawn to the limitation of liability, indemnification and jurisdiction issues defined therein. Any holder of this document is advised that information contained hereon reflects the Company's findings at the time of its intervention only and within the limits of Client's instructions, if any. The Company's sole responsibility is to its Client and this document does not exonerate parties to a transaction from exercising all their rights and obligations under the transaction documents. This document cannot be reproduced except in full, without prior written approval of the Company. Any unauthorized alteration, forgery or falsification of the content or appearance of this document is unlawful and offenders may be prosecuted to the fullest extent of the law.

## 6.4 Test SET-UP

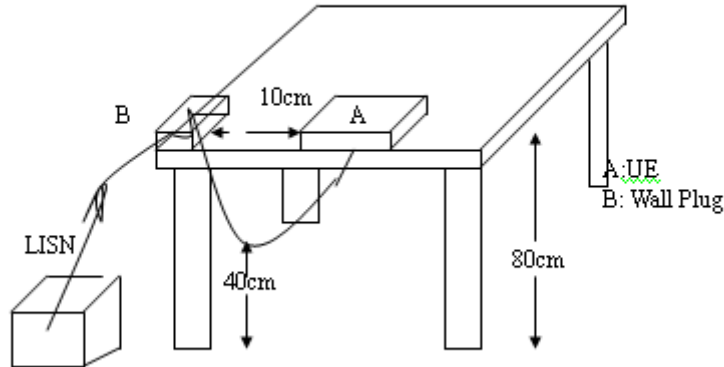

## 6.5 Measurement Procedure

1. The EUT was placed on a table which is 0.8m above ground plane.
2. Maximum procedure was performed on the six highest emissions to ensure EUT compliance.
3. Repeat above procedures until all phases of power being supplied by given UE are completed.

## 6.6 Measurement Result

Note: Refer to next page for measurement data and plots.

Note2: The \* reveals the worst-case results that closet to the limit.

Unless otherwise stated the results shown in this test report refer only to the sample(s) tested and such sample(s) are retained for 90 days only.

除非另有說明，此報告結果僅對測試之樣品負責，同時此樣品僅保留90天。本報告未經本公司書面許可，不可部份複製。

This document is issued by the Company subject to its General Conditions of Service printed overleaf, available on request or accessible at <http://www.sgs.com.tw/Terms-and-Conditions> and for electronic format documents, subject to Terms and Conditions for Electronic Documents at <http://www.sgs.com.tw/Terms-and-Conditions>. Attention is drawn to the limitation of liability, indemnification and jurisdiction issues defined therein. Any holder of this document is advised that information contained hereon reflects the Company's findings at the time of its intervention only and within the limits of Client's instructions, if any. The Company's sole responsibility is to its Client and this document does not exonerate parties to a transaction from exercising all their rights and obligations under the transaction documents. This document cannot be reproduced except in full, without prior written approval of the Company. Any unauthorized alteration, forgery or falsification of the content or appearance of this document is unlawful and offenders may be prosecuted to the fullest extent of the law.



### AC POWER LINE CONDUCTED EMISSION TEST DATA

Report Number	:E2-2020-B0037	Test Site	:Conduction Room C
Test Mode	:WLAN 5G	Test Date	:2020-12-23
Power	:120V/60Hz	Temp./Humi.	:25.4/62
Probe	:L1	Engineer	:Ashton Chiu
Note:	: MS-V300R120-036H0-US		

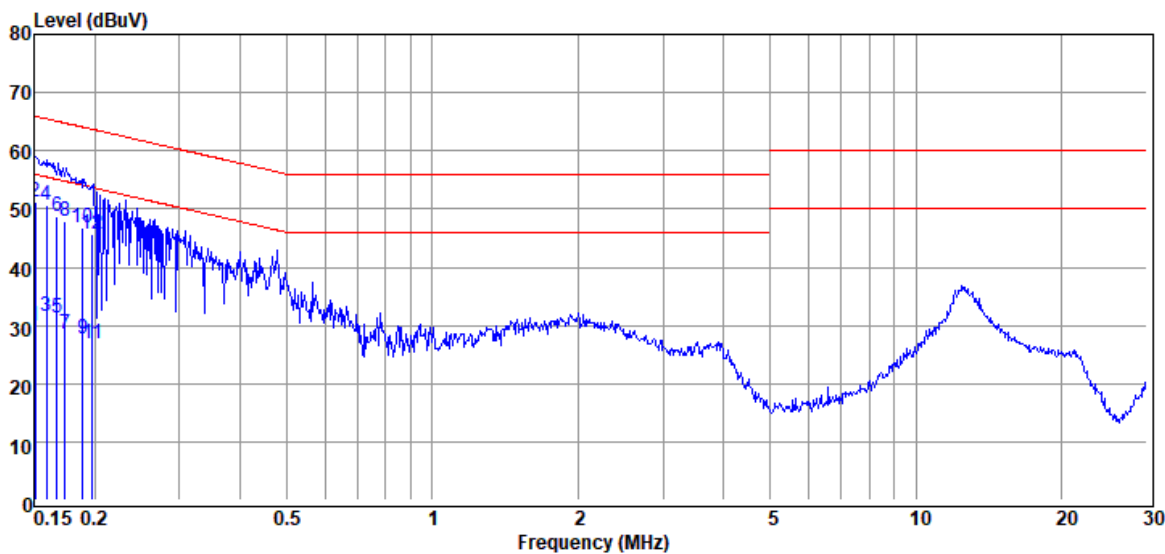

Freq. MHz	Detector Mode PK/QP/AV	Spectrum Reading Level dB $\mu$ V	Factor dB	Actual FS dB $\mu$ V	Limit dB $\mu$ V	Margin dB
0.15	Average	19.75	10.22	29.97	55.95	-25.98
0.15	QP	40.88	10.22	51.10	65.95	-14.85
0.16	Average	21.25	10.22	31.47	55.52	-24.05
0.16	QP	40.41	10.22	50.63	65.52	-14.89
0.17	Average	21.17	10.22	31.39	55.08	-23.69
0.17	QP	38.61	10.22	48.83	65.08	-16.25
0.17	Average	18.27	10.22	28.49	54.77	-26.28
0.17	QP	37.80	10.22	48.02	64.77	-16.75
0.19	Average	17.41	10.22	27.63	54.07	-26.44
0.19	QP	36.58	10.22	46.80	64.07	-17.27
0.20	Average	16.52	10.22	26.74	53.69	-26.95
0.20	QP	35.46	10.22	45.68	63.69	-18.01

Unless otherwise stated the results shown in this test report refer only to the sample(s) tested and such sample(s) are retained for 90 days only.

除非另有說明，此報告結果僅對測試之樣品負責，同時此樣品僅保留90天。本報告未經本公司書面許可，不可部份複製。

This document is issued by the Company subject to its General Conditions of Service printed overleaf, available on request or accessible at <http://www.sgs.com.tw/Terms-and-Conditions> and for electronic format documents, subject to Terms and Conditions for Electronic Documents at <http://www.sgs.com.tw/Terms-and-Conditions>. Attention is drawn to the limitation of liability, indemnification and jurisdiction issues defined therein. Any holder of this document is advised that information contained hereon reflects the Company's findings at the time of its intervention only and within the limits of Client's instructions, if any. The Company's sole responsibility is to its Client and this document does not exonerate parties to a transaction from exercising all their rights and obligations under the transaction documents. This document cannot be reproduced except in full, without prior written approval of the Company. Any unauthorized alteration, forgery or falsification of the content or appearance of this document is unlawful and offenders may be prosecuted to the fullest extent of the law.

Report Number	:E2-2020-B0037	Test Site	:Conduction Room C
Test Mode	:WLAN 5G	Test Date	:2020-12-23
Power	:120V/60Hz	Temp./Humi.	:25.4/62
Probe	:N	Engineer	:Ashton Chiu
Note:	: MS-V300R120-036H0-US		

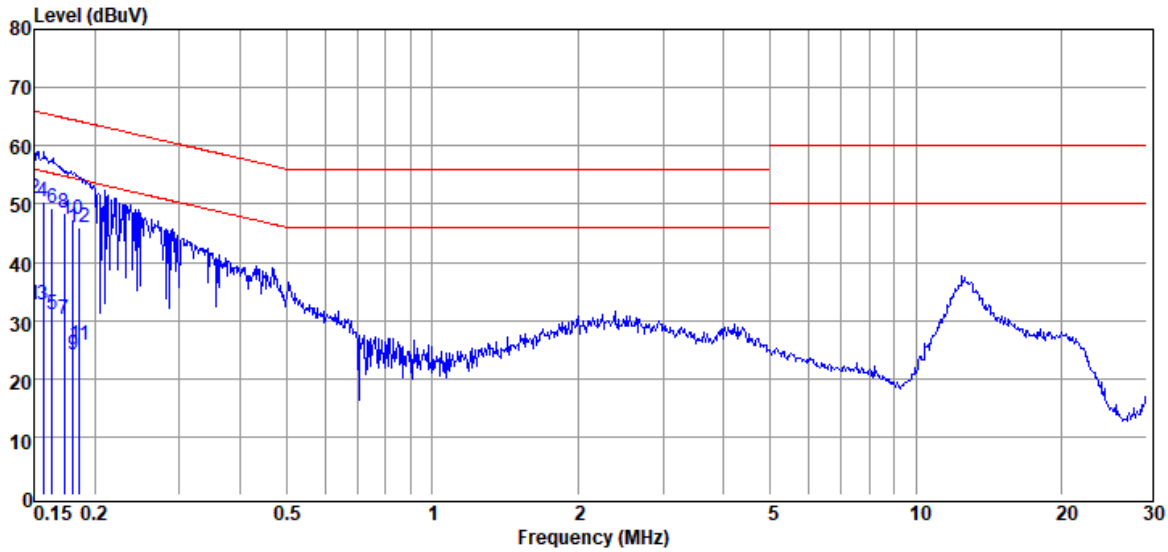

Freq. MHz	Detector Mode PK/QP/AV	Spectrum Reading Level dBμV	Factor dB	Actual FS dBμV	Limit dBμV	Margin dB
0.15	Average	22.54	10.21	32.75	56.00	-23.25
0.15	QP	40.70	10.21	50.91	66.00	-15.09
0.16	Average	22.38	10.21	32.59	55.65	-23.06
0.16	QP	40.18	10.21	50.39	65.65	-15.26
0.16	Average	20.67	10.21	30.88	55.30	-24.42
0.16	QP	39.14	10.21	49.35	65.30	-15.95
0.17	Average	20.03	10.21	30.24	54.81	-24.57
0.17	QP	38.31	10.21	48.52	64.81	-16.29
0.18	Average	13.96	10.21	24.17	54.45	-30.28
0.18	QP	37.13	10.21	47.34	64.45	-17.11
0.19	Average	15.46	10.21	25.67	54.19	-28.52
0.19	QP	35.87	10.21	46.08	64.19	-18.11

Unless otherwise stated the results shown in this test report refer only to the sample(s) tested and such sample(s) are retained for 90 days only.

除非另有說明，此報告結果僅對測試之樣品負責，同時此樣品僅保留90天。本報告未經本公司書面許可，不可部份複製。

This document is issued by the Company subject to its General Conditions of Service printed overleaf, available on request or accessible at <http://www.sgs.com.tw/Terms-and-Conditions> and for electronic format documents, subject to Terms and Conditions for Electronic Documents at <http://www.sgs.com.tw/Terms-and-Conditions>. Attention is drawn to the limitation of liability, indemnification and jurisdiction issues defined therein. Any holder of this document is advised that information contained hereon reflects the Company's findings at the time of its intervention only and within the limits of Client's instructions, if any. The Company's sole responsibility is to its Client and this document does not exonerate parties to a transaction from exercising all their rights and obligations under the transaction documents. This document cannot be reproduced except in full, without prior written approval of the Company. Any unauthorized alteration, forgery or falsification of the content or appearance of this document is unlawful and offenders may be prosecuted to the fullest extent of the law.

## 7 DUTY CYCLE TEST SIGNAL

Pre-analysis Check: While conducting average power measurement, duty cycle of each mode shall be checked to ensure its duty cycle in order to compensate for the loss due to insufficient ratio of duty cycle.

All duty cycle is pre-scanned, and result as obtained below shows only the most representative ones where duty cycle is conducted as the given transmission with given virtual operation that expresses the percentage.

### 7.1 Measurement Procedure:

1. Set span = Zero
2. RBW = 8MHz
3. VBW = 8MHz,
4. Detector = Peak

Duty Cycle:

Mode	Duty Cycle (%) =Ton / (Ton+Toff)	Duty Factor (dB) =10*log ( 1/Duty Cycle )	1/T (kHz)	VBW setting (kHz)
802.11a	95.00	0.22	0.48	1.00
802.11n_20	95.00	0.22	0.52	1.00
802.11ac_20	98.00	0.09	0.52	0.01
802.11n_40	91.00	0.41	1.06	2.00
802.11ac_40	97.00	0.13	1.05	2.00
802.11ac_80	94.00	0.27	2.17	3.00

▣ Duty Cycle Factor:  $10 * \log(1/0.95) = 0.22$

▣ Duty Cycle Factor:  $10 * \log(1/0.95) = 0.22$

▣ Duty Cycle Factor:  $10 * \log(1/0.98) = 0.09$

▣ Duty Cycle Factor:  $10 * \log(1/0.91) = 0.41$

▣ Duty Cycle Factor:  $10 * \log(1/0.97) = 0.13$

▣ Duty Cycle Factor:  $10 * \log(1/0.94) = 0.27$

Unless otherwise stated the results shown in this test report refer only to the sample(s) tested and such sample(s) are retained for 90 days only.

除非另有說明，此報告結果僅對測試之樣品負責，同時此樣品僅保留90天。本報告未經本公司書面許可，不可部份複製。

This document is issued by the Company subject to its General Conditions of Service printed overleaf, available on request or accessible at <http://www.sgs.com.tw/Terms-and-Conditions> and for electronic format documents, subject to Terms and Conditions for Electronic Documents at <http://www.sgs.com.tw/Terms-and-Conditions>. Attention is drawn to the limitation of liability, indemnification and jurisdiction issues defined therein. Any holder of this document is advised that information contained hereon reflects the Company's findings at the time of its intervention only and within the limits of Client's instructions, if any. The Company's sole responsibility is to its Client and this document does not exonerate parties to a transaction from exercising all their rights and obligations under the transaction documents. This document cannot be reproduced except in full, without prior written approval of the Company. Any unauthorized alteration, forgery or falsification of the content or appearance of this document is unlawful and offenders may be prosecuted to the fullest extent of the law.

## 7.2 DUTY CYCLE TEST SIGNAL MEASUREMENT RESULT

802.11a\_20MHz



802.11ac\_20MHz



802.11n\_20MHz



802.11n\_40MHz



Unless otherwise stated the results shown in this test report refer only to the sample(s) tested and such sample(s) are retained for 90 days only.

除非另有說明，此報告結果僅對測試之樣品負責，同時此樣品僅保留90天。本報告未經本公司書面許可，不可部份複製。

This document is issued by the Company subject to its General Conditions of Service printed overleaf, available on request or accessible at <http://www.sgs.com.tw/Terms-and-Conditions> and for electronic format documents, subject to Terms and Conditions for Electronic Documents at <http://www.sgs.com.tw/Terms-and-Conditions>. Attention is drawn to the limitation of liability, indemnification and jurisdiction issues defined therein. Any holder of this document is advised that information contained hereon reflects the Company's findings at the time of its intervention only and within the limits of Client's instructions, if any. The Company's sole responsibility is to its Client and this document does not exonerate parties to a transaction from exercising all their rights and obligations under the transaction documents. This document cannot be reproduced except in full, without prior written approval of the Company. Any unauthorized alteration, forgery or falsification of the content or appearance of this document is unlawful and offenders may be prosecuted to the fullest extent of the law.

802.11ac\_40MHz



802.11ac\_80MHz



Unless otherwise stated the results shown in this test report refer only to the sample(s) tested and such sample(s) are retained for 90 days only.

除非另有說明，此報告結果僅對測試之樣品負責，同時此樣品僅保留90天。本報告未經本公司書面許可，不可部份複製。

This document is issued by the Company subject to its General Conditions of Service printed overleaf, available on request or accessible at <http://www.sgs.com.tw/Terms-and-Conditions> and for electronic format documents, subject to Terms and Conditions for Electronic Documents at <http://www.sgs.com.tw/Terms-and-Conditions>. Attention is drawn to the limitation of liability, indemnification and jurisdiction issues defined therein. Any holder of this document is advised that information contained hereon reflects the Company's findings at the time of its intervention only and within the limits of Client's instructions, if any. The Company's sole responsibility is to its Client and this document does not exonerate parties to a transaction from exercising all their rights and obligations under the transaction documents. This document cannot be reproduced except in full, without prior written approval of the Company. Any unauthorized alteration, forgery or falsification of the content or appearance of this document is unlawful and offenders may be prosecuted to the fullest extent of the law.

## 8 26DB & 6DB EMISSION BANDWIDTH MEASUREMENT

### 8.1 Standard Applicable

There is no limit bandwidth for U-NII-1, U-NII-2-A and U-NII-2-C.

The minimum of 6dB Bandwidth measurement is 0.5 MHz for U-NII-3

### 8.2 Measurement Procedure

1. Place the EUT on the table and set it in transmitting mode.
2. The testing follows FCC KDB 789033 D02 General UNII Test Procedures New Rules.
3. Remove the antenna from the EUT and then connect a low loss RF cable from the Antenna port to the spectrum analyzer.
  - 3.a. 26dB Band width Measurement: Set the spectrum analyzer as 1% of emission BW  
Sweep=auto,  
Detector = Peak,  
Trace Mode = Max Hold,  
Manually readjust RBW until the RBW/EBW ratio is 1% based on EBW as observed on the result of pre-sequence measurement.
  - 3.b. Mark the peak frequency and -26dB (upper and lower) frequency.
4. Repeat the procedures as list above until all test default channels (low, middle, and high) are completed.
5. Minimum Emission Bandwidth for the band 5.725-5.850GHz.
  - a. Set the spectrum analyzer as  
RBW = 100 kHz,  
VBW = 3\*RBW,  
Span = 30M/50MHz,  
Detector=Peak,  
Sweep=auto
  - b. Mark the peak frequency and -6dB (upper and lower) frequency.
6. Repeat above procedures until all frequency of interest measured was complete.

Unless otherwise stated the results shown in this test report refer only to the sample(s) tested and such sample(s) are retained for 90 days only.

除非另有說明，此報告結果僅對測試之樣品負責，同時此樣品僅保留90天。本報告未經本公司書面許可，不可部份複製。

This document is issued by the Company subject to its General Conditions of Service printed overleaf, available on request or accessible at <http://www.sgs.com.tw/Terms-and-Conditions> and for electronic format documents, subject to Terms and Conditions for Electronic Documents at <http://www.sgs.com.tw/Terms-and-Conditions>. Attention is drawn to the limitation of liability, indemnification and jurisdiction issues defined therein. Any holder of this document is advised that information contained hereon reflects the Company's findings at the time of its intervention only and within the limits of Client's instructions, if any. The Company's sole responsibility is to its Client and this document does not exonerate parties to a transaction from exercising all their rights and obligations under the transaction documents. This document cannot be reproduced except in full, without prior written approval of the Company. Any unauthorized alteration, forgery or falsification of the content or appearance of this document is unlawful and offenders may be prosecuted to the fullest extent of the law.

### 8.3 Measurement Equipment Used

SGS Conducted Room					
Name of Equipment	Manufacturer	Model	Serial Number	Calibration Date	Calibration Due
Spectrum Analyzer	KEYSIGHT	N9010B	MY59071574	06/24/2020	06/23/2021
Attenuator	Marvelous	MVE2213-10	RF09	11/19/2020	11/18/2021
DC Block	PASTERNAK	PE8210	RF151	11/19/2020	11/18/2021

### 8.4 Test Set-up

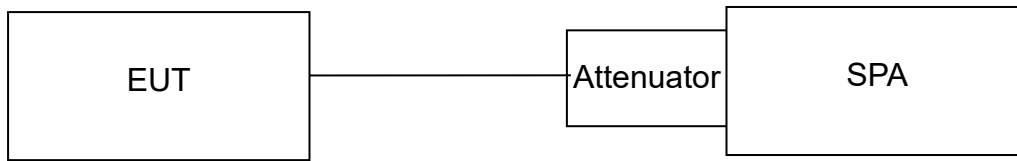

### 8.5 Measurement Result

#### 8.5.1 FCC 26dB Bandwidth

802.11a\_Ch1

Freq. (MHz)	26dB BW (MHz)	10 Log (B) (dB)
5180	21.26	13.280
5220	21.10	13.240
5240	21.55	13.330

802.11n\_HT20\_Ch0

Freq. (MHz)	26dB BW (MHz)	10 Log (B) (dB)
5180	21.20	13.260
5220	21.46	13.320
5240	21.40	13.300

802.11n\_HT20\_Ch1

Freq. (MHz)	26dB BW (MHz)	10 Log (B) (dB)
5180	21.24	13.270
5220	21.37	13.300
5240	21.28	13.280

Unless otherwise stated the results shown in this test report refer only to the sample(s) tested and such sample(s) are retained for 90 days only.

除非另有說明，此報告結果僅對測試之樣品負責，同時此樣品僅保留90天。本報告未經本公司書面許可，不可部份複製。

This document is issued by the Company subject to its General Conditions of Service printed overleaf, available on request or accessible at <http://www.sgs.com.tw/Terms-and-Conditions> and for electronic format documents, subject to Terms and Conditions for Electronic Documents at <http://www.sgs.com.tw/Terms-and-Conditions>. Attention is drawn to the limitation of liability, indemnification and jurisdiction issues defined therein. Any holder of this document is advised that information contained hereon reflects the Company's findings at the time of its intervention only and within the limits of Client's instructions, if any. The Company's sole responsibility is to its Client and this document does not exonerate parties to a transaction from exercising all their rights and obligations under the transaction documents. This document cannot be reproduced except in full, without prior written approval of the Company. Any unauthorized alteration, forgery or falsification of the content or appearance of this document is unlawful and offenders may be prosecuted to the fullest extent of the law.

802.11n\_HT20\_Ch2

Freq. (MHz)	26dB BW (MHz)	10 Log (B) (dB)
5180	21.33	13.290
5220	21.41	13.310
5240	21.25	13.270

802.11n\_HT20\_Ch3

Freq. (MHz)	26dB BW (MHz)	10 Log (B) (dB)
5180	21.42	13.310
5220	21.18	13.260
5240	20.93	13.210

802.11n\_HT40\_Ch0

Freq. (MHz)	26dB BW (MHz)	10 Log (B) (dB)
5190	43.92	16.430
5230	42.90	16.320

802.11n\_HT40\_Ch1

Freq. (MHz)	26dB BW (MHz)	10 Log (B) (dB)
5190	42.50	16.280
5230	39.80	16.000

802.11n\_HT40\_Ch2

Freq. (MHz)	26dB BW (MHz)	10 Log (B) (dB)
5190	42.92	16.330
5230	39.70	15.990

802.11n\_HT40\_Ch3

Freq. (MHz)	26dB BW (MHz)	10 Log (B) (dB)
5190	42.63	16.300
5230	39.66	15.980

802.11ac\_VHT80\_Ch0

Freq. (MHz)	26dB BW (MHz)	10 Log (B) (dB)
5210	80.14	19.040

802.11ac\_VHT80\_Ch1

Freq. (MHz)	26dB BW (MHz)	10 Log (B) (dB)
5210	80.08	19.040

802.11ac\_VHT80\_Ch2

Freq. (MHz)	26dB BW (MHz)	10 Log (B) (dB)
5210	81.34	19.100

802.11ac\_VHT80\_Ch3

Freq. (MHz)	26dB BW (MHz)	10 Log (B) (dB)
5210	80.79	19.070

Unless otherwise stated the results shown in this test report refer only to the sample(s) tested and such sample(s) are retained for 90 days only.

除非另有說明，此報告結果僅對測試之樣品負責，同時此樣品僅保留90天。本報告未經本公司書面許可，不可部份複製。

This document is issued by the Company subject to its General Conditions of Service printed overleaf, available on request or accessible at <http://www.sgs.com.tw/Terms-and-Conditions> and for electronic format documents, subject to Terms and Conditions for Electronic Documents at <http://www.sgs.com.tw/Terms-and-Conditions>. Attention is drawn to the limitation of liability, indemnification and jurisdiction issues defined therein. Any holder of this document is advised that information contained hereon reflects the Company's findings at the time of its intervention only and within the limits of Client's instructions, if any. The Company's sole responsibility is to its Client and this document does not exonerate parties to a transaction from exercising all their rights and obligations under the transaction documents. This document cannot be reproduced except in full, without prior written approval of the Company. Any unauthorized alteration, forgery or falsification of the content or appearance of this document is unlawful and offenders may be prosecuted to the fullest extent of the law.



8.5.2 6dB Bandwidth (5725 MHz~ 5850 MHz) measure with Peak detector for FCC

802.11a\_Ch1

Freq. (MHz)	6dB BW (MHz)	10 Log (B) (dB)
5745	16.38	12.140
5785	16.34	12.130
5825	16.37	12.140

802.11n\_HT20\_Ch0

Freq. (MHz)	6dB BW (MHz)	10 Log (B) (dB)
5745	17.60	12.460
5785	17.60	12.460
5825	17.33	12.390

802.11n\_HT20\_Ch1

Freq. (MHz)	6dB BW (MHz)	10 Log (B) (dB)
5745	17.60	12.460
5785	17.65	12.470
5825	17.62	12.460

802.11n\_HT20\_Ch2

Freq. (MHz)	6dB BW (MHz)	10 Log (B) (dB)
5745	17.59	12.450
5785	17.62	12.460
5825	17.57	12.450

802.11n\_HT20\_Ch3

Freq. (MHz)	6dB BW (MHz)	10 Log (B) (dB)
5745	17.63	12.460
5785	17.62	12.460
5825	17.61	12.460

802.11n\_HT40\_Ch0

Freq. (MHz)	6dB BW (MHz)	10 Log (B) (dB)
5755	36.36	15.610
5795	36.39	15.610

802.11n\_HT40\_Ch1

Freq. (MHz)	6dB BW (MHz)	10 Log (B) (dB)
5755	36.39	15.610
5795	36.39	15.610

802.11n\_HT40\_Ch2

Freq. (MHz)	6dB BW (MHz)	10 Log (B) (dB)
5755	36.38	15.610
5795	36.01	15.560

802.11n\_HT40\_Ch3

Freq. (MHz)	6dB BW (MHz)	10 Log (B) (dB)
5755	36.31	15.600
5795	36.34	15.600

Unless otherwise stated the results shown in this test report refer only to the sample(s) tested and such sample(s) are retained for 90 days only.

除非另有說明，此報告結果僅對測試之樣品負責，同時此樣品僅保留90天。本報告未經本公司書面許可，不可部份複製。

This document is issued by the Company subject to its General Conditions of Service printed overleaf, available on request or accessible at <http://www.sgs.com.tw/Terms-and-Conditions> and for electronic format documents, subject to Terms and Conditions for Electronic Documents at <http://www.sgs.com.tw/Terms-and-Conditions>. Attention is drawn to the limitation of liability, indemnification and jurisdiction issues defined therein. Any holder of this document is advised that information contained hereon reflects the Company's findings at the time of its intervention only and within the limits of Client's instructions, if any. The Company's sole responsibility is to its Client and this document does not exonerate parties to a transaction from exercising all their rights and obligations under the transaction documents. This document cannot be reproduced except in full, without prior written approval of the Company. Any unauthorized alteration, forgery or falsification of the content or appearance of this document is unlawful and offenders may be prosecuted to the fullest extent of the law.

802.11ac\_VHT80\_Ch0

Freq. (MHz)	6dB BW (MHz)	10 Log (B) (dB)
5775	75.86	18.800

802.11ac\_VHT80\_Ch1

Freq. (MHz)	6dB BW (MHz)	10 Log (B) (dB)
5775	76.05	18.810

802.11ac\_VHT80\_Ch2

Freq. (MHz)	6dB BW (MHz)	10 Log (B) (dB)
5775	75.92	18.800

802.11ac\_VHT80\_Ch3

Freq. (MHz)	6dB BW (MHz)	10 Log (B) (dB)
5775	76.12	18.810

Unless otherwise stated the results shown in this test report refer only to the sample(s) tested and such sample(s) are retained for 90 days only.

除非另有說明，此報告結果僅對測試之樣品負責，同時此樣品僅保留90天。本報告未經本公司書面許可，不可部份複製。

This document is issued by the Company subject to its General Conditions of Service printed overleaf, available on request or accessible at <http://www.sgs.com.tw/Terms-and-Conditions> and for electronic format documents, subject to Terms and Conditions for Electronic Documents at <http://www.sgs.com.tw/Terms-and-Conditions>. Attention is drawn to the limitation of liability, indemnification and jurisdiction issues defined therein. Any holder of this document is advised that information contained hereon reflects the Company's findings at the time of its intervention only and within the limits of Client's instructions, if any. The Company's sole responsibility is to its Client and this document does not exonerate parties to a transaction from exercising all their rights and obligations under the transaction documents. This document cannot be reproduced except in full, without prior written approval of the Company. Any unauthorized alteration, forgery or falsification of the content or appearance of this document is unlawful and offenders may be prosecuted to the fullest extent of the law.

802.11a\_20MHz\_Chain1\_5180MHz



802.11a\_20MHz\_Chain1\_5745MHz



802.11a\_20MHz\_Chain1\_5220MHz



802.11a\_20MHz\_Chain1\_5785MHz



802.11a\_20MHz\_Chain1\_5240MHz



802.11a\_20MHz\_Chain1\_5825MHz



Unless otherwise stated the results shown in this test report refer only to the sample(s) tested and such sample(s) are retained for 90 days only.

除非另有說明，此報告結果僅對測試之樣品負責，同時此樣品僅保留90天。本報告未經本公司書面許可，不可部份複製。

This document is issued by the Company subject to its General Conditions of Service printed overleaf, available on request or accessible at <http://www.sgs.com.tw/Terms-and-Conditions> and for electronic format documents, subject to Terms and Conditions for Electronic Documents at <http://www.sgs.com.tw/Terms-and-Conditions>. Attention is drawn to the limitation of liability, indemnification and jurisdiction issues defined therein. Any holder of this document is advised that information contained hereon reflects the Company's findings at the time of its intervention only and within the limits of Client's instructions, if any. The Company's sole responsibility is to its Client and this document does not exonerate parties to a transaction from exercising all their rights and obligations under the transaction documents. This document cannot be reproduced except in full, without prior written approval of the Company. Any unauthorized alteration, forgery or falsification of the content or appearance of this document is unlawful and offenders may be prosecuted to the fullest extent of the law.

802.11n\_20MHz\_Chain0\_5180MHz



802.11n\_20MHz\_Chain0\_5745MHz



802.11n\_20MHz\_Chain0\_5220MHz

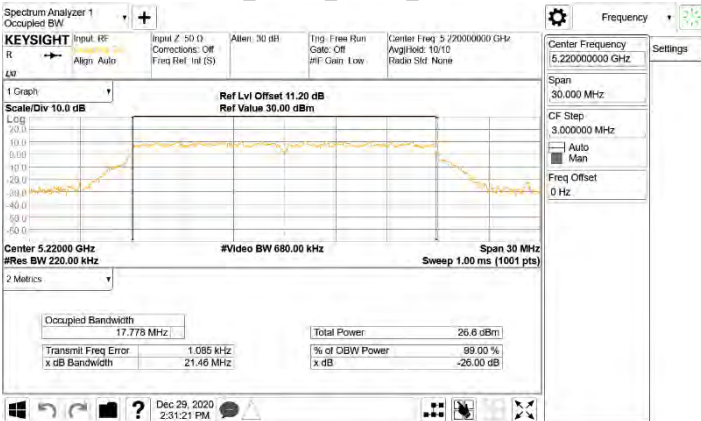

802.11n\_20MHz\_Chain0\_5785MHz



802.11n\_20MHz\_Chain0\_5240MHz



802.11n\_20MHz\_Chain0\_5825MHz



Unless otherwise stated the results shown in this test report refer only to the sample(s) tested and such sample(s) are retained for 90 days only.

除非另有說明，此報告結果僅對測試之樣品負責，同時此樣品僅保留90天。本報告未經本公司書面許可，不可部份複製。

This document is issued by the Company subject to its General Conditions of Service printed overleaf, available on request or accessible at <http://www.sgs.com.tw/Terms-and-Conditions> and for electronic format documents, subject to Terms and Conditions for Electronic Documents at <http://www.sgs.com.tw/Terms-and-Conditions>. Attention is drawn to the limitation of liability, indemnification and jurisdiction issues defined therein. Any holder of this document is advised that information contained hereon reflects the Company's findings at the time of its intervention only and within the limits of Client's instructions, if any. The Company's sole responsibility is to its Client and this document does not exonerate parties to a transaction from exercising all their rights and obligations under the transaction documents. This document cannot be reproduced except in full, without prior written approval of the Company. Any unauthorized alteration, forgery or falsification of the content or appearance of this document is unlawful and offenders may be prosecuted to the fullest extent of the law.

802.11n\_20MHz\_Chain1\_5180MHz



802.11n\_20MHz\_Chain1\_5745MHz



802.11n\_20MHz\_Chain1\_5220MHz



802.11n\_20MHz\_Chain1\_5785MHz



802.11n\_20MHz\_Chain1\_5240MHz



802.11n\_20MHz\_Chain1\_5825MHz



Unless otherwise stated the results shown in this test report refer only to the sample(s) tested and such sample(s) are retained for 90 days only.

除非另有說明，此報告結果僅對測試之樣品負責，同時此樣品僅保留90天。本報告未經本公司書面許可，不可部份複製。

This document is issued by the Company subject to its General Conditions of Service printed overleaf, available on request or accessible at <http://www.sgs.com.tw/Terms-and-Conditions> and for electronic format documents, subject to Terms and Conditions for Electronic Documents at <http://www.sgs.com.tw/Terms-and-Conditions>. Attention is drawn to the limitation of liability, indemnification and jurisdiction issues defined therein. Any holder of this document is advised that information contained hereon reflects the Company's findings at the time of its intervention only and within the limits of Client's instructions, if any. The Company's sole responsibility is to its Client and this document does not exonerate parties to a transaction from exercising all their rights and obligations under the transaction documents. This document cannot be reproduced except in full, without prior written approval of the Company. Any unauthorized alteration, forgery or falsification of the content or appearance of this document is unlawful and offenders may be prosecuted to the fullest extent of the law.

802.11n\_20MHz\_Chain2\_5180MHz



802.11n\_20MHz\_Chain2\_5745MHz



802.11n\_20MHz\_Chain2\_5220MHz



802.11n\_20MHz\_Chain2\_5785MHz



802.11n\_20MHz\_Chain2\_5240MHz



802.11n\_20MHz\_Chain2\_5825MHz



Unless otherwise stated the results shown in this test report refer only to the sample(s) tested and such sample(s) are retained for 90 days only.

除非另有說明，此報告結果僅對測試之樣品負責，同時此樣品僅保留90天。本報告未經本公司書面許可，不可部份複製。

This document is issued by the Company subject to its General Conditions of Service printed overleaf, available on request or accessible at <http://www.sgs.com.tw/Terms-and-Conditions> and for electronic format documents, subject to Terms and Conditions for Electronic Documents at <http://www.sgs.com.tw/Terms-and-Conditions>. Attention is drawn to the limitation of liability, indemnification and jurisdiction issues defined therein. Any holder of this document is advised that information contained hereon reflects the Company's findings at the time of its intervention only and within the limits of Client's instructions, if any. The Company's sole responsibility is to its Client and this document does not exonerate parties to a transaction from exercising all their rights and obligations under the transaction documents. This document cannot be reproduced except in full, without prior written approval of the Company. Any unauthorized alteration, forgery or falsification of the content or appearance of this document is unlawful and offenders may be prosecuted to the fullest extent of the law.

802.11n\_20MHz\_Chain3\_5180MHz

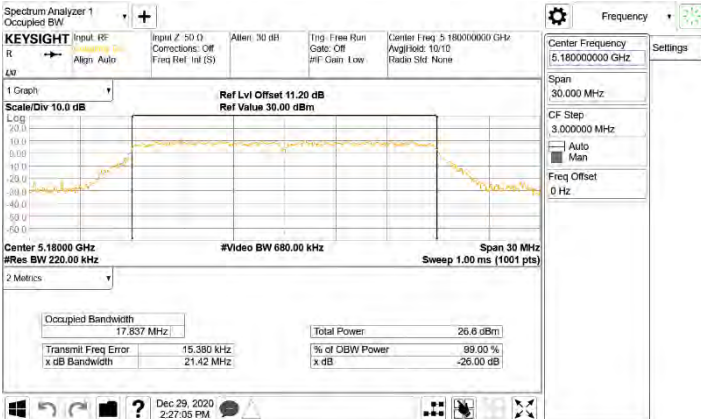

802.11n\_20MHz\_Chain3\_5745MHz



802.11n\_20MHz\_Chain3\_5220MHz

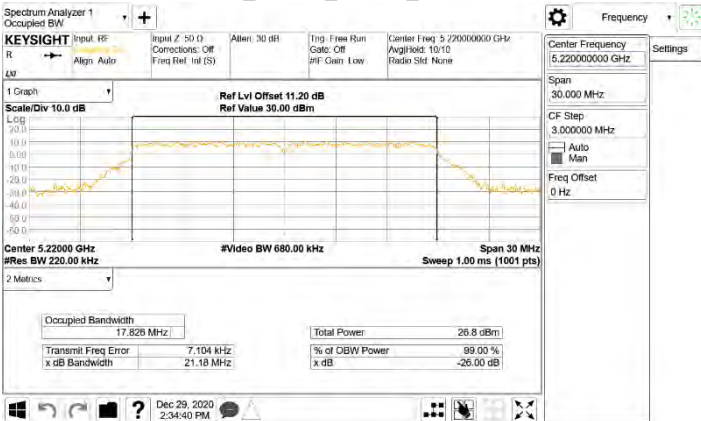

802.11n\_20MHz\_Chain3\_5785MHz



802.11n\_20MHz\_Chain3\_5240MHz

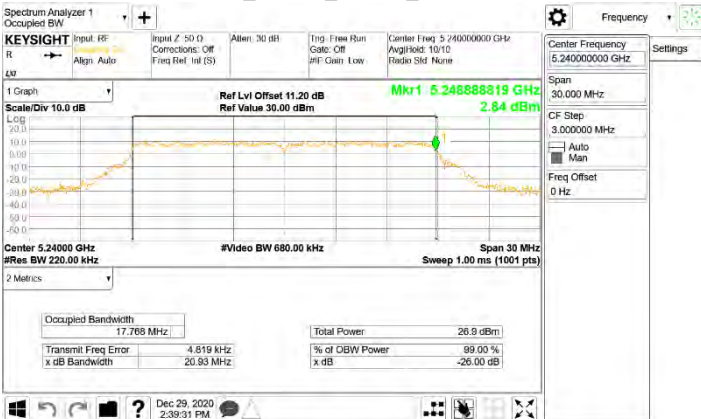

802.11n\_20MHz\_Chain3\_5825MHz



Unless otherwise stated the results shown in this test report refer only to the sample(s) tested and such sample(s) are retained for 90 days only.

除非另有說明，此報告結果僅對測試之樣品負責，同時此樣品僅保留90天。本報告未經本公司書面許可，不可部份複製。

This document is issued by the Company subject to its General Conditions of Service printed overleaf, available on request or accessible at <http://www.sgs.com.tw/Terms-and-Conditions> and for electronic format documents, subject to Terms and Conditions for Electronic Documents at <http://www.sgs.com.tw/Terms-and-Conditions>. Attention is drawn to the limitation of liability, indemnification and jurisdiction issues defined therein. Any holder of this document is advised that information contained hereon reflects the Company's findings at the time of its intervention only and within the limits of Client's instructions, if any. The Company's sole responsibility is to its Client and this document does not exonerate parties to a transaction from exercising all their rights and obligations under the transaction documents. This document cannot be reproduced except in full, without prior written approval of the Company. Any unauthorized alteration, forgery or falsification of the content or appearance of this document is unlawful and offenders may be prosecuted to the fullest extent of the law.

802.11n\_40MHz\_Chain0\_5190MHz



802.11n\_40MHz\_Chain0\_5795MHz



802.11n\_40MHz\_Chain0\_5230MHz



802.11n\_40MHz\_Chain1\_5190MHz

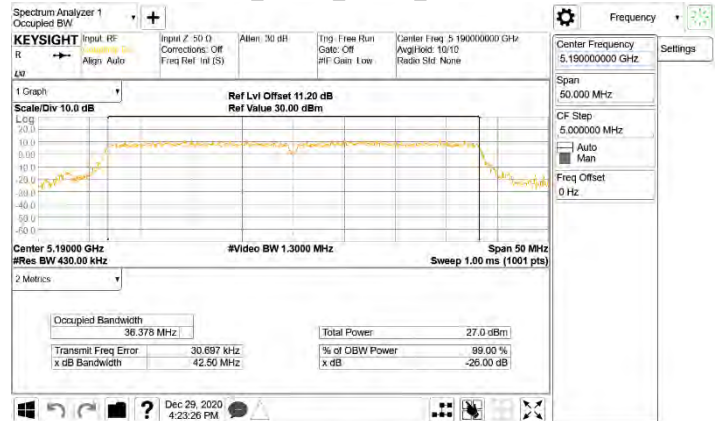

802.11n\_40MHz\_Chain0\_5755MHz



802.11n\_40MHz\_Chain1\_5230MHz



Unless otherwise stated the results shown in this test report refer only to the sample(s) tested and such sample(s) are retained for 90 days only.

除非另有說明，此報告結果僅對測試之樣品負責，同時此樣品僅保留90天。本報告未經本公司書面許可，不可部份複製。

This document is issued by the Company subject to its General Conditions of Service printed overleaf, available on request or accessible at <http://www.sgs.com.tw/Terms-and-Conditions> and for electronic format documents, subject to Terms and Conditions for Electronic Documents at <http://www.sgs.com.tw/Terms-and-Conditions>. Attention is drawn to the limitation of liability, indemnification and jurisdiction issues defined therein. Any holder of this document is advised that information contained hereon reflects the Company's findings at the time of its intervention only and within the limits of Client's instructions, if any. The Company's sole responsibility is to its Client and this document does not exonerate parties to a transaction from exercising all their rights and obligations under the transaction documents. This document cannot be reproduced except in full, without prior written approval of the Company. Any unauthorized alteration, forgery or falsification of the content or appearance of this document is unlawful and offenders may be prosecuted to the fullest extent of the law.



802.11n\_40MHz\_Chain1\_5755MHz



802.11n\_40MHz\_Chain2\_5230MHz

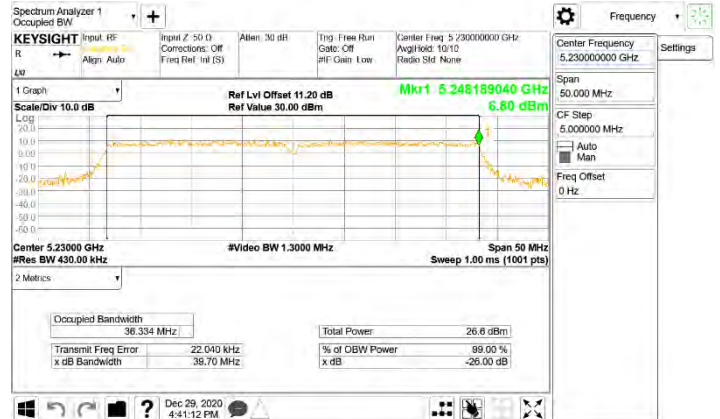

802.11n\_40MHz\_Chain1\_5795MHz

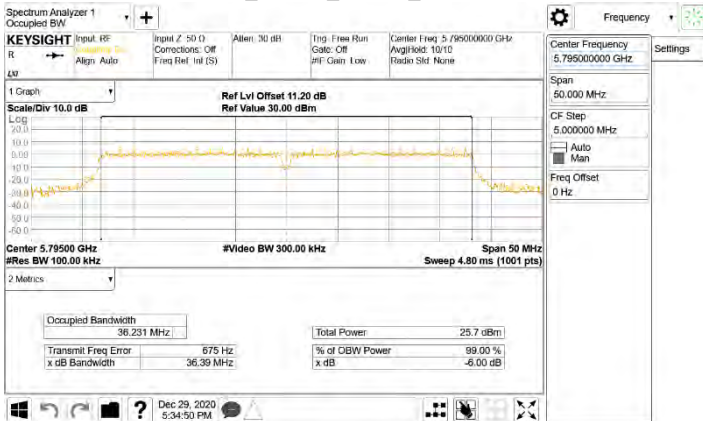

802.11n\_40MHz\_Chain2\_5755MHz



802.11n\_40MHz\_Chain2\_5190MHz



802.11n\_40MHz\_Chain2\_5795MHz



Unless otherwise stated the results shown in this test report refer only to the sample(s) tested and such sample(s) are retained for 90 days only.

除非另有說明，此報告結果僅對測試之樣品負責，同時此樣品僅保留90天。本報告未經本公司書面許可，不可部份複製。

This document is issued by the Company subject to its General Conditions of Service printed overleaf, available on request or accessible at <http://www.sgs.com.tw/Terms-and-Conditions> and for electronic format documents, subject to Terms and Conditions for Electronic Documents at <http://www.sgs.com.tw/Terms-and-Conditions>. Attention is drawn to the limitation of liability, indemnification and jurisdiction issues defined therein. Any holder of this document is advised that information contained hereon reflects the Company's findings at the time of its intervention only and within the limits of Client's instructions, if any. The Company's sole responsibility is to its Client and this document does not exonerate parties to a transaction from exercising all their rights and obligations under the transaction documents. This document cannot be reproduced except in full, without prior written approval of the Company. Any unauthorized alteration, forgery or falsification of the content or appearance of this document is unlawful and offenders may be prosecuted to the fullest extent of the law.

802.11n\_40MHz\_Chain3\_5190MHz



802.11n\_40MHz\_Chain3\_5795MHz



802.11n\_40MHz\_Chain3\_5230MHz

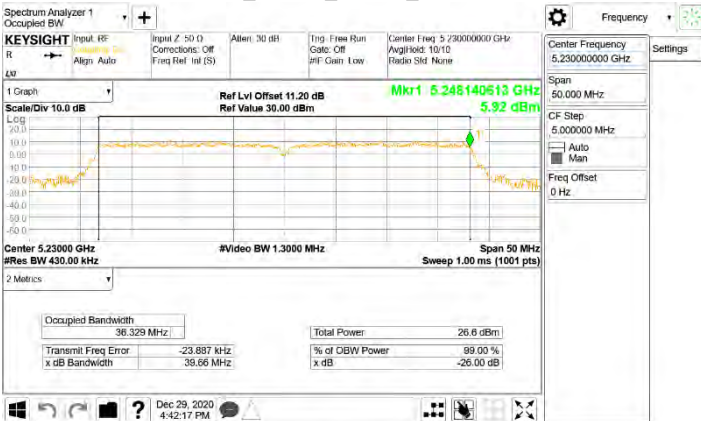

802.11ac\_80MHz\_Chain0\_5210MHz



802.11n\_40MHz\_Chain3\_5755MHz



802.11ac\_80MHz\_Chain0\_5775MHz



Unless otherwise stated the results shown in this test report refer only to the sample(s) tested and such sample(s) are retained for 90 days only.

除非另有說明，此報告結果僅對測試之樣品負責，同時此樣品僅保留90天。本報告未經本公司書面許可，不可部份複製。

This document is issued by the Company subject to its General Conditions of Service printed overleaf, available on request or accessible at <http://www.sgs.com.tw/Terms-and-Conditions> and for electronic format documents, subject to Terms and Conditions for Electronic Documents at <http://www.sgs.com.tw/Terms-and-Conditions>. Attention is drawn to the limitation of liability, indemnification and jurisdiction issues defined therein. Any holder of this document is advised that information contained hereon reflects the Company's findings at the time of its intervention only and within the limits of Client's instructions, if any. The Company's sole responsibility is to its Client and this document does not exonerate parties to a transaction from exercising all their rights and obligations under the transaction documents. This document cannot be reproduced except in full, without prior written approval of the Company. Any unauthorized alteration, forgery or falsification of the content or appearance of this document is unlawful and offenders may be prosecuted to the fullest extent of the law.

802.11ac\_80MHz\_Chain1\_5210MHz



802.11ac\_80MHz\_Chain2\_5775MHz

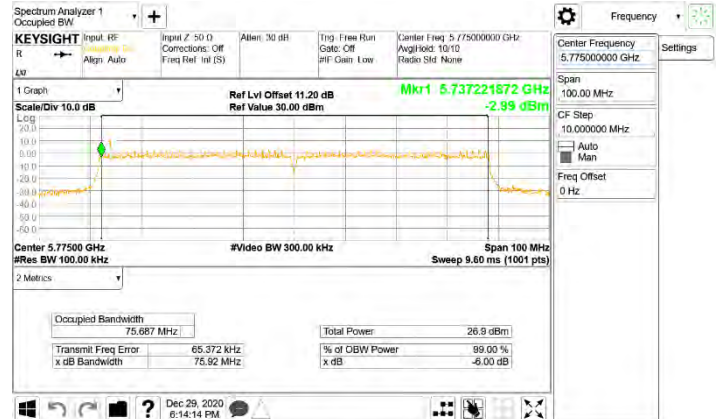

802.11ac\_80MHz\_Chain1\_5775MHz



802.11ac\_80MHz\_Chain3\_5210MHz



802.11ac\_80MHz\_Chain2\_5210MHz



802.11ac\_80MHz\_Chain3\_5775MHz



Unless otherwise stated the results shown in this test report refer only to the sample(s) tested and such sample(s) are retained for 90 days only.

除非另有說明，此報告結果僅對測試之樣品負責，同時此樣品僅保留90天。本報告未經本公司書面許可，不可部份複製。

This document is issued by the Company subject to its General Conditions of Service printed overleaf, available on request or accessible at <http://www.sgs.com.tw/Terms-and-Conditions> and for electronic format documents, subject to Terms and Conditions for Electronic Documents at <http://www.sgs.com.tw/Terms-and-Conditions>. Attention is drawn to the limitation of liability, indemnification and jurisdiction issues defined therein. Any holder of this document is advised that information contained hereon reflects the Company's findings at the time of its intervention only and within the limits of Client's instructions, if any. The Company's sole responsibility is to its Client and this document does not exonerate parties to a transaction from exercising all their rights and obligations under the transaction documents. This document cannot be reproduced except in full, without prior written approval of the Company. Any unauthorized alteration, forgery or falsification of the content or appearance of this document is unlawful and offenders may be prosecuted to the fullest extent of the law.

8.5.3 BW Verification for DFS Function

802.11a\_Ch1

Freq. (MHz)	Measured Freq. (MHz)	Limit (MHz)
5240	5248.31	< 5250
5745	5736.65	> 5725

802.11n\_HT20\_Ch0

Freq. (MHz)	Measured Freq. (MHz)	Limit (MHz)
5240	5248.94	< 5250
5745	5736.15	> 5725

802.11n\_HT20\_Ch1

Freq. (MHz)	Measured Freq. (MHz)	Limit (MHz)
5240	5248.93	< 5250
5745	5736.14	> 5725

802.11n\_HT20\_Ch2

Freq. (MHz)	Measured Freq. (MHz)	Limit (MHz)
5240	5248.95	< 5250
5745	5736.12	> 5725

802.11n\_HT20\_Ch3

Freq. (MHz)	Measured Freq. (MHz)	Limit (MHz)
5240	5248.89	< 5250
5745	5736.15	> 5725

802.11n\_HT40\_Ch0

Freq. (MHz)	Measured Freq. (MHz)	Limit (MHz)
5230	5248.10	< 5250
5755	5736.88	> 5725

802.11n\_HT40\_Ch1

Freq. (MHz)	Measured Freq. (MHz)	Limit (MHz)
5230	5248.18	< 5250
5755	5736.87	> 5725

802.11n\_HT40\_Ch2

Freq. (MHz)	Measured Freq. (MHz)	Limit (MHz)
5230	5248.19	< 5250
5755	5736.87	> 5725

802.11n\_HT40\_Ch3

Freq. (MHz)	Measured Freq. (MHz)	Limit (MHz)
5230	5248.14	< 5250
5755	5736.87	> 5725

802.11ac\_VHT80\_Ch0

Freq. (MHz)	Measured Freq. (MHz)	Limit (MHz)
5210	5247.54	< 5250
5775	5737.24	> 5725

802.11ac\_VHT80\_Ch1

Freq. (MHz)	Measured Freq. (MHz)	Limit (MHz)
5210	5247.66	< 5250
5775	5737.22	> 5725

Unless otherwise stated the results shown in this test report refer only to the sample(s) tested and such sample(s) are retained for 90 days only.

除非另有說明，此報告結果僅對測試之樣品負責，同時此樣品僅保留90天。本報告未經本公司書面許可，不可部份複製。

This document is issued by the Company subject to its General Conditions of Service printed overleaf, available on request or accessible at <http://www.sgs.com.tw/Terms-and-Conditions> and for electronic format documents, subject to Terms and Conditions for Electronic Documents at <http://www.sgs.com.tw/Terms-and-Conditions>. Attention is drawn to the limitation of liability, indemnification and jurisdiction issues defined therein. Any holder of this document is advised that information contained hereon reflects the Company's findings at the time of its intervention only and within the limits of Client's instructions, if any. The Company's sole responsibility is to its Client and this document does not exonerate parties to a transaction from exercising all their rights and obligations under the transaction documents. This document cannot be reproduced except in full, without prior written approval of the Company. Any unauthorized alteration, forgery or falsification of the content or appearance of this document is unlawful and offenders may be prosecuted to the fullest extent of the law.

802.11ac\_VHT80\_Ch2

Freq. (MHz)	Measured Freq. (MHz)	Limit (MHz)
5210	5247.80	< 5250
5775	5737.22	> 5725

802.11ac\_VHT80\_Ch3

Freq. (MHz)	Measured Freq. (MHz)	Limit (MHz)
5210	5247.78	< 5250
5775	5737.23	> 5725

Unless otherwise stated the results shown in this test report refer only to the sample(s) tested and such sample(s) are retained for 90 days only.

除非另有說明，此報告結果僅對測試之樣品負責，同時此樣品僅保留90天。本報告未經本公司書面許可，不可部份複製。

This document is issued by the Company subject to its General Conditions of Service printed overleaf, available on request or accessible at <http://www.sgs.com.tw/Terms-and-Conditions> and for electronic format documents, subject to Terms and Conditions for Electronic Documents at <http://www.sgs.com.tw/Terms-and-Conditions>. Attention is drawn to the limitation of liability, indemnification and jurisdiction issues defined therein. Any holder of this document is advised that information contained hereon reflects the Company's findings at the time of its intervention only and within the limits of Client's instructions, if any. The Company's sole responsibility is to its Client and this document does not exonerate parties to a transaction from exercising all their rights and obligations under the transaction documents. This document cannot be reproduced except in full, without prior written approval of the Company. Any unauthorized alteration, forgery or falsification of the content or appearance of this document is unlawful and offenders may be prosecuted to the fullest extent of the law.

## 9 MAXIMUM CONDUCTED OUTPUT POWER MEASUREMENT

### 9.1 Standard Applicable

#### FCC

OPERZTION Band	EUT CATEGORY		LIMIT
U-NII-1	√	Access Point (Master device )	1 Watt(30dBm)
		Fixed point-to-point Access Ponit	1 Watt(30dBm)
		Mobile and portable client device	250mW(23.98dBm)
U-NII-2A			250mW(23.98dBm) or 11dBm+10 log B
U-NII-2C			250mW(23.98dBm) or 11dBm+10 log B
U-NII-3	√		1 Watt(30dBm)

If transmitting antennas of directional gain greater than 6 dBi are used, the Maximum transmit power shall be reduced by the amount in dB that the direction-al gain of the antenna exceeds 6 dBi.

#### Note:

As per section F. 2). e). (ii) of FCC KDB 662911 D01

If antenna gains are not equal and each transmit antenna is driven by only one spatial stream, directional gain may be calculated by either of the following formulas.

$$DirectionalGain = 10 \cdot \log \left[ \frac{\sum_{j=1}^{N_{SS}} \left\{ \sum_{k=1}^{N_{ANT}} g_{j,k} \right\}^2}{N_{ANT}} \right]$$

where

Each antenna is driven by no more than one spatial stream;

NSS = the number of independent spatial streams of data;

NANT = the total number of antennas

$g_{j,k}$  = / 20 10Gk if the kth antenna is being fed by spatial stream j, or zero if it is not;

$G_k$  is the gain in dBi of the kth antenna.

The antenna gain is grater than 6 dBi, therefore the power limit autenuation has been applied in the test results.

Unless otherwise stated the results shown in this test report refer only to the sample(s) tested and such sample(s) are retained for 90 days only.

除非另有說明，此報告結果僅對測試之樣品負責，同時此樣品僅保留90天。本報告未經本公司書面許可，不可部份複製。

This document is issued by the Company subject to its General Conditions of Service printed overleaf, available on request or accessible at <http://www.sgs.com.tw/Terms-and-Conditions> and for electronic format documents, subject to Terms and Conditions for Electronic Documents at <http://www.sgs.com.tw/Terms-and-Conditions>. Attention is drawn to the limitation of liability, indemnification and jurisdiction issues defined therein. Any holder of this document is advised that information contained hereon reflects the Company's findings at the time of its intervention only and within the limits of Client's instructions, if any. The Company's sole responsibility is to its Client and this document does not exonerate parties to a transaction from exercising all their rights and obligations under the transaction documents. This document cannot be reproduced except in full, without prior written approval of the Company. Any unauthorized alteration, forgery or falsification of the content or appearance of this document is unlawful and offenders may be prosecuted to the fullest extent of the law.

### 9.2 Measurement Procedure

1. Place the EUT on the table and set it in transmitting mode.
2. The testing follows FCC KDB 789033 D02 General UNII Test Procedures New Rules .
3. Remove the antenna from the EUT and then connect a low loss RF cable from the antenna port to the power meter
4. Power Meter is used as the auxiliary test equipment to conduct the output power measurement.
5. Record the max. reading and add 10 log(1/duty cycle).
6. Repeat above procedures until all frequency (low, middle, and high channel) measured were complete.

### 9.3 Measurement Equipment Used

SGS Conducted Room					
Name of Equipment	Manufacturer	Model	Serial Number	Calibration Date	Calibration Due
Power Meter	Anritsu	ML2496A	1512003	07/23/2020	07/22/2021
Power Sensor	Anritsu	MA2411B	1339378	07/23/2020	07/22/2021
Power Sensor	Anritsu	MA2411B	1339379	07/23/2020	07/22/2021
Attenuator	Marvelous	MVE2213-10	RF09	11/19/2020	11/18/2021

### 9.4 Test Set-up

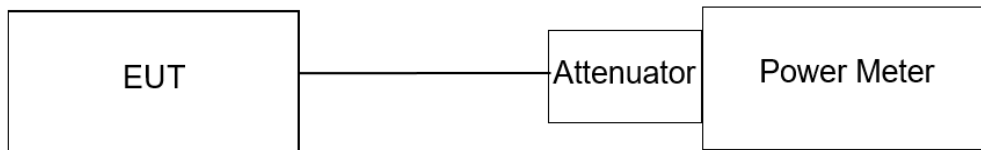

Unless otherwise stated the results shown in this test report refer only to the sample(s) tested and such sample(s) are retained for 90 days only.

除非另有說明，此報告結果僅對測試之樣品負責，同時此樣品僅保留90天。本報告未經本公司書面許可，不可部份複製。

This document is issued by the Company subject to its General Conditions of Service printed overleaf, available on request or accessible at <http://www.sgs.com.tw/Terms-and-Conditions> and for electronic format documents, subject to Terms and Conditions for Electronic Documents at <http://www.sgs.com.tw/Terms-and-Conditions>. Attention is drawn to the limitation of liability, indemnification and jurisdiction issues defined therein. Any holder of this document is advised that information contained hereon reflects the Company's findings at the time of its intervention only and within the limits of Client's instructions, if any. The Company's sole responsibility is to its Client and this document does not exonerate parties to a transaction from exercising all their rights and obligations under the transaction documents. This document cannot be reproduced except in full, without prior written approval of the Company. Any unauthorized alteration, forgery or falsification of the content or appearance of this document is unlawful and offenders may be prosecuted to the fullest extent of the law.

## 9.5 Measurement Result

### 9.5.1 Conducted output power (FCC)

#### 802.11a\_Ch1

CH	Frequency (MHz)	Data Rate	TOTAL POWER (dBm)	TOTAL POWER (mW)	REQUIRED LIMIT (dBm)	RESULT
36	5180	6	21.99	158.225	30	PASS
44	5220	6	21.97	157.498	30	PASS
48	5240	6	21.93	156.055	30	PASS
149	5745	6	21.92	155.696	30	PASS
157	5785	6	21.92	155.696	30	PASS
165	5825	6	21.89	154.624	30	PASS

#### 802.11n\_HT20\_MIMO

CH	Frequency (MHz)	Data Rate	Avg. POWER (dBm)				TOTAL POWER (dBm)	TOTAL POWER (mW)	REQUIRED LIMIT (dBm)	RESULT
			CH 0	CH 1	CH 2	CH3				
36	5180	MCS0	19.89	20.98	20.39	20.1	26.60	457.408	27.18	PASS
44	5220	MCS0	19.97	20.91	20.51	20.02	26.61	458.468	27.18	PASS
48	5240	MCS0	19.77	20.86	20.44	20.39	26.63	459.788	27.18	PASS
149	5745	MCS0	20.28	20.49	20.4	20.41	26.64	461.212	27.05	PASS
157	5785	MCS0	20.25	20.46	20.33	20.49	26.63	459.934	27.05	PASS
165	5825	MCS0	20.38	20.55	20.32	20.53	26.69	466.601	27.05	PASS

#### 802.11n\_HT40\_MIMO

CH	Frequency (MHz)	Data Rate	Avg. POWER (dBm)				TOTAL POWER (dBm)	TOTAL POWER (mW)	REQUIRED LIMIT (dBm)	RESULT
			CH 0	CH 1	CH 2	CH3				
38	5190	MCS0	16.51	17.12	17.05	16.84	23.32	214.614	27.18	PASS
46	5230	MCS0	19.81	20.47	20.08	20.18	26.57	454.110	27.18	PASS
151	5755	MCS0	15.51	15.78	15.01	15.13	21.80	151.304	27.05	PASS
159	5795	MCS0	19.29	19.38	18.88	19.22	25.63	365.322	27.05	PASS

#### 802.11ac\_VHT80\_MIMO

CH	Frequency (MHz)	Data Rate	Avg. POWER (dBm)				TOTAL POWER (dBm)	TOTAL POWER (mW)	REQUIRED LIMIT (dBm)	RESULT
			CH 0	CH 1	CH 2	CH3				
42	5210	MCS0	14.21	15.08	14.93	14.82	21.06	127.692	27.18	PASS
155	5775	MCS0	14.13	14.56	14.34	14.51	20.68	116.884	27.05	PASS

Unless otherwise stated the results shown in this test report refer only to the sample(s) tested and such sample(s) are retained for 90 days only.

除非另有說明，此報告結果僅對測試之樣品負責，同時此樣品僅保留90天。本報告未經本公司書面許可，不可部份複製。

This document is issued by the Company subject to its General Conditions of Service printed overleaf, available on request or accessible at <http://www.sgs.com.tw/Terms-and-Conditions> and for electronic format documents, subject to Terms and Conditions for Electronic Documents at <http://www.sgs.com.tw/Terms-and-Conditions>. Attention is drawn to the limitation of liability, indemnification and jurisdiction issues defined therein. Any holder of this document is advised that information contained hereon reflects the Company's findings at the time of its intervention only and within the limits of Client's instructions, if any. The Company's sole responsibility is to its Client and this document does not exonerate parties to a transaction from exercising all their rights and obligations under the transaction documents. This document cannot be reproduced except in full, without prior written approval of the Company. Any unauthorized alteration, forgery or falsification of the content or appearance of this document is unlawful and offenders may be prosecuted to the fullest extent of the law.



## 10 MAXIMUM POWER SPECTRAL DENSITY

### 10.1 Standard Applicable

#### FCC

OPERZTION Band	EUT CATEGORY		LIMIT
U-NII-1	√	Access Point (Master device )	17dBm/ MHz
		Fixed point-to-point Access Ponit	
		Mobile and portable client device	11dBm/ MHz
U-NII-2A			11dBm/ MHz
U-NII-2C			11dBm/ MHz
U-NII-3	√		30dBm/ 500kHz

If transmitting antennas of directional gain greater than 6 dBi are used, the Maximum power spectral density shall be reduced by the amount in dB that the directional gain of the antenna exceeds 6 dBi.

#### Note:

As per section F. 2). e). (ii) of FCC KDB 662911 D01

If antenna gains are not equal and each transmit antenna is driven by only one spatial stream, directional gain may be calculated by either of the following formulas.

$$DirectionalGain = 10 \cdot \log \left[ \frac{\sum_{j=1}^{N_{SS}} \left\{ \sum_{k=1}^{N_{ANT}} g_{j,k} \right\}^2}{N_{ANT}} \right]$$

where

Each antenna is driven by no more than one spatial stream;

NSS = the number of independent spatial streams of data;

NANT = the total number of antennas

$g_{j,k} = / 20 \log G_k$  if the kth antenna is being fed by spatial stream j, or zero if it is not;

$G_k$  is the gain in dBi of the kth antenna.

The antenna gain is grater than 6 dBi in MIMO mode, therefore the the power density limit autenuation has been applied in the test results.

### 10.2 Measurement Procedure

1. Place the EUT on the table and set it in transmitting mode.
2. The testing follows FCC KDB 789033 D02 General UNII Test Procedures New Rules .

Unless otherwise stated the results shown in this test report refer only to the sample(s) tested and such sample(s) are retained for 90 days only.

除非另有說明，此報告結果僅對測試之樣品負責，同時此樣品僅保留90天。本報告未經本公司書面許可，不可部份複製。

This document is issued by the Company subject to its General Conditions of Service printed overleaf, available on request or accessible at <http://www.sgs.com.tw/Terms-and-Conditions> and for electronic format documents, subject to Terms and Conditions for Electronic Documents at <http://www.sgs.com.tw/Terms-and-Conditions>. Attention is drawn to the limitation of liability, indemnification and jurisdiction issues defined therein. Any holder of this document is advised that information contained hereon reflects the Company's findings at the time of its intervention only and within the limits of Client's instructions, if any. The Company's sole responsibility is to its Client and this document does not exonerate parties to a transaction from exercising all their rights and obligations under the transaction documents. This document cannot be reproduced except in full, without prior written approval of the Company. Any unauthorized alteration, forgery or falsification of the content or appearance of this document is unlawful and offenders may be prosecuted to the fullest extent of the law.

3. Remove the antenna from the EUT and then connect a low loss RF cable from the antenna port to Spectrum.
4. **For U-NII1, U-NII-2A, U-NII-2C Band:**  
Set RBW=1MHz, VBW=3MHz, where span is enough to capture the entire bandwidth, Sweep time = Auto (601 pts), detector = sample, traces 100 sweeps of video averaging. (SA-2 with the omission of procedure x, the integration with 26dB EBW bandwidth)  
**For U-NII-3 Band:**  
Set RBW=300kHz, VBW≥ 3RBW, where span is enough to capture the entire bandwidth, Sweep time = Auto, detector = RMS or sample, traces 100 sweeps of video averaging.

Set RBW=500kHz, VBW≥ 3RBW, where span is enough to capture the entire bandwidth, Sweep time = Auto, detector = RMS or sample, traces 100 sweeps of video averaging.

5. Use the cursor on spectrum to peak search the highest level of trace
6. Record the max. reading and add 10 log(1/duty cycle).
7. Repeat above procedures until all default test channel (low, middle, and high) was complete.
8. MIMO mode: offset is set following "measure and add 10 Log (N)" on spectrum to measure the PSD for MIMO mode. Offset = cable loss + 10 log (N), where N is number of transmitting antenna.

**Note: For the test of PSD at MIMO mode, the highest emission of worst case employing Measure and add 10 log (N) technical is reported on this report after the comparison between Main Antenna at single transmitting mode and Aux that yields the higher value. The MIMO transmitting mode produces higher value of outcome**

### 10.3 Measurement Equipment Used

SGS Conducted Room					
Name of Equipment	Manufacturer	Model	Serial Number	Calibration Date	Calibration Due
Spectrum Analyzer	KEYSIGHT	N9010B	MY59071574	06/24/2020	06/23/2021
Attenuator	Marvelous	MVE2213-10	RF09	11/19/2020	11/18/2021
DC Block	PASTERNAK	PE8210	RF151	11/19/2020	11/18/2021

### 10.4 Test Set-up

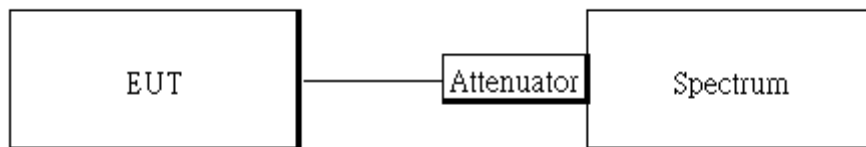

Unless otherwise stated the results shown in this test report refer only to the sample(s) tested and such sample(s) are retained for 90 days only.

除非另有說明，此報告結果僅對測試之樣品負責，同時此樣品僅保留90天。本報告未經本公司書面許可，不可部份複製。

This document is issued by the Company subject to its General Conditions of Service printed overleaf, available on request or accessible at <http://www.sgs.com.tw/Terms-and-Conditions> and for electronic format documents, subject to Terms and Conditions for Electronic Documents at <http://www.sgs.com.tw/Terms-and-Conditions>. Attention is drawn to the limitation of liability, indemnification and jurisdiction issues defined therein. Any holder of this document is advised that information contained hereon reflects the Company's findings at the time of its intervention only and within the limits of Client's instructions, if any. The Company's sole responsibility is to its Client and this document does not exonerate parties to a transaction from exercising all their rights and obligations under the transaction documents. This document cannot be reproduced except in full, without prior written approval of the Company. Any unauthorized alteration, forgery or falsification of the content or appearance of this document is unlawful and offenders may be prosecuted to the fullest extent of the law.

## 10.5 Measurement Result

### 10.5.1 Power spectral density

POWER DENSITY 802.11a MODE						
Frequency (MHz)	ch1 meas PSD (dBm/MHz)	Duty Factor (dB)	Maxmum Corr'd PSD(dBm/MHz)		Limit	Margin (dB)
5180.00	9.287	0.220	9.51		17.00 dBm/MHz	-7.49
5220.00	8.022	0.220	8.24		17.00 dBm/MHz	-8.76
5240.00	7.910	0.220	8.13		17.00 dBm/MHz	-8.87
Frequency (MHz)	ch1 meas PSD (dBm/300kHz)	Duty Factor (dB)	10log (500kHz/RBW) Factor(dB)	Maxmum Corr'd PSD(dBm/500 kHz)	Limit	Margin (dB)
5745.00	3.010	0.220	2.22	5.45	30.00 dBm/500kHz	-24.55
5785.00	2.262	0.220	2.22	4.70	30.00 dBm/500kHz	-25.30
5825.00	3.744	0.220	2.22	6.18	30.00 dBm/500kHz	-23.82

POWER DENSITY 802.11n HT20 MODE									
Frequency (MHz)	ch0 meas PSD (dBm/MHz)	ch1 meas PSD (dBm/MHz)	ch2 meas PSD (dBm/MHz)	ch3 meas PSD (dBm/MHz)	Duty Factor (dB)	Maxmum Corr'd PSD(dBm/MHz)		Limit	Margin (dB)
5180.00	1.423	0.529	1.329	1.138	0.220	7.36		14.18 dBm/MHz	-6.82
5220.00	-1.251	2.481	-0.268	3.030	0.220	7.60		14.18 dBm/MHz	-6.58
5240.00	0.163	3.283	1.403	-0.025	0.220	7.66		14.18 dBm/MHz	-6.52
Frequency (MHz)	ch0 meas PSD (dBm/300kHz)	ch1 meas PSD (dBm/300kHz)	ch2 meas PSD (dBm/300kHz)	ch3 meas PSD (dBm/300kHz)	Duty Factor (dB)	10log (500kHz/RBW) Factor(dB)	Maxmum Corr'd PSD(dBm/500 kHz)	Limit	Margin (dB)
5745.00	0.646	0.341	1.518	-1.362	0.220	2.22	8.87	27.05 dBm/500kHz	-18.18
5785.00	-3.095	-3.467	-2.950	-2.642	0.220	2.22	5.43	27.05 dBm/500kHz	-21.62
5825.00	-3.546	1.007	-1.692	-1.723	0.220	2.22	7.29	27.05 dBm/500kHz	-19.76

Unless otherwise stated the results shown in this test report refer only to the sample(s) tested and such sample(s) are retained for 90 days only.

除非另有說明，此報告結果僅對測試之樣品負責，同時此樣品僅保留90天。本報告未經本公司書面許可，不可部份複製。

This document is issued by the Company subject to its General Conditions of Service printed overleaf, available on request or accessible at <http://www.sgs.com.tw/Terms-and-Conditions> and for electronic format documents, subject to Terms and Conditions for Electronic Documents at <http://www.sgs.com.tw/Terms-and-Conditions>. Attention is drawn to the limitation of liability, indemnification and jurisdiction issues defined therein. Any holder of this document is advised that information contained hereon reflects the Company's findings at the time of its intervention only and within the limits of Client's instructions, if any. The Company's sole responsibility is to its Client and this document does not exonerate parties to a transaction from exercising all their rights and obligations under the transaction documents. This document cannot be reproduced except in full, without prior written approval of the Company. Any unauthorized alteration, forgery or falsification of the content or appearance of this document is unlawful and offenders may be prosecuted to the fullest extent of the law.

**POWER DENSITY 802.11n HT40 MODE**

Frequency (MHz)	ch0 meas PSD (dBm/MHz)	ch1 meas PSD (dBm/MHz)	ch2 meas PSD (dBm/MHz)	ch3 meas PSD (dBm/MHz)	Duty Factor (dB)	Maximum Corr'd PSD(dBm/MHz)	Limit	Margin (dB)	
5190.00	-5.133	-3.374	-5.425	-5.874	0.410	1.59	14.18 dBm/MHz	-12.59	
5230.00	-3.859	-6.609	-6.331	-4.114	0.410	1.38	14.18 dBm/MHz	-12.80	
Frequency (MHz)	ch0 meas PSD (dBm/300kHz)	ch1 meas PSD (dBm/300kHz)	ch2 meas PSD (dBm/300kHz)	ch3 meas PSD (dBm/300kHz)	Duty Factor (dB)	10log (500kHz/RBW) Factor(dB)	Maximum Corr'd PSD(dBm/500 kHz)	Limit	Margin (dB)
5755.00	-9.096	-10.036	-11.171	-10.280	0.410	2.22	-1.43	27.05 dBm/500kHz	-28.48
5795.00	-5.977	-11.589	-9.067	-11.677	0.410	2.22	-0.26	27.05 dBm/500kHz	-27.31

**POWER DENSITY 802.11ac VHT80 MODE**

Frequency (MHz)	ch0 meas PSD (dBm/MHz)	ch1 meas PSD (dBm/MHz)	ch2 meas PSD (dBm/MHz)	ch3 meas PSD (dBm/MHz)	Duty Factor (dB)	Maximum Corr'd PSD(dBm/MHz)	Limit	Margin (dB)	
5210.00	0.549	-2.295	-1.183	-1.356	0.270	5.35	14.18 dBm/MHz	-8.83	
Frequency (MHz)	ch0 meas PSD (dBm/300kHz)	ch1 meas PSD (dBm/300kHz)	ch2 meas PSD (dBm/300kHz)	ch3 meas PSD (dBm/300kHz)	Duty Factor (dB)	10log (500kHz/RBW) Factor(dB)	Maximum Corr'd PSD(dBm/500 kHz)	Limit	Margin (dB)
5775.00	-5.880	-6.193	-4.445	-6.671	0.270	2.22	2.80	27.05 dBm/500kHz	-24.25

Unless otherwise stated the results shown in this test report refer only to the sample(s) tested and such sample(s) are retained for 90 days only.

除非另有說明，此報告結果僅對測試之樣品負責，同時此樣品僅保留90天。本報告未經本公司書面許可，不可部份複製。

This document is issued by the Company subject to its General Conditions of Service printed overleaf, available on request or accessible at <http://www.sgs.com.tw/Terms-and-Conditions> and for electronic format documents, subject to Terms and Conditions for Electronic Documents at <http://www.sgs.com.tw/Terms-and-Conditions>. Attention is drawn to the limitation of liability, indemnification and jurisdiction issues defined therein. Any holder of this document is advised that information contained hereon reflects the Company's findings at the time of its intervention only and within the limits of Client's instructions, if any. The Company's sole responsibility is to its Client and this document does not exonerate parties to a transaction from exercising all their rights and obligations under the transaction documents. This document cannot be reproduced except in full, without prior written approval of the Company. Any unauthorized alteration, forgery or falsification of the content or appearance of this document is unlawful and offenders may be prosecuted to the fullest extent of the law.

802.11a\_20MHz\_Chain1\_5180MHz

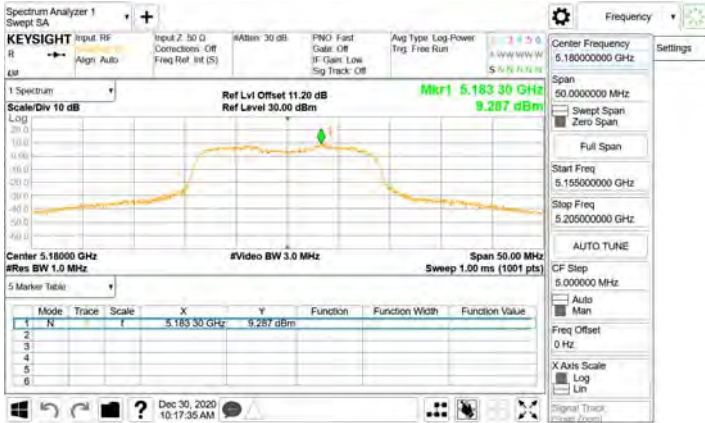

802.11a\_20MHz\_Chain1\_5745MHz



802.11a\_20MHz\_Chain1\_5220MHz

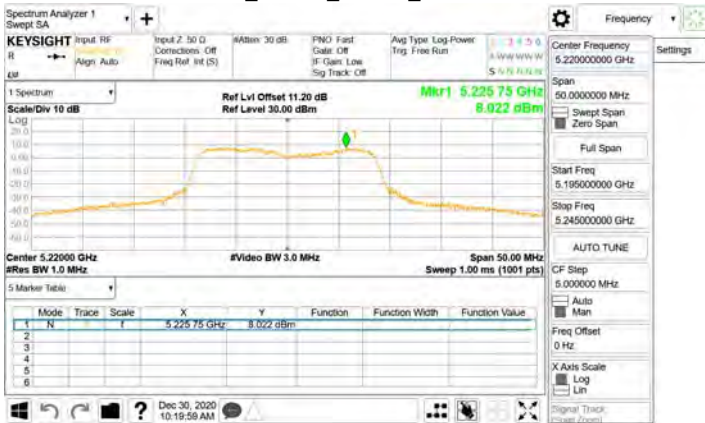

802.11a\_20MHz\_Chain1\_5785MHz



802.11a\_20MHz\_Chain1\_5240MHz

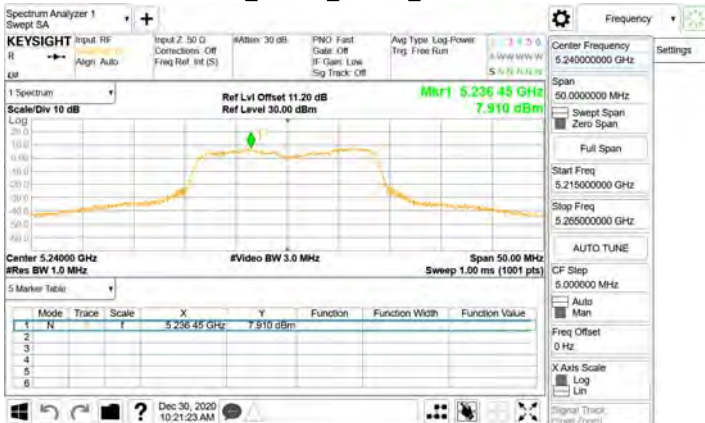

802.11a\_20MHz\_Chain1\_5825MHz

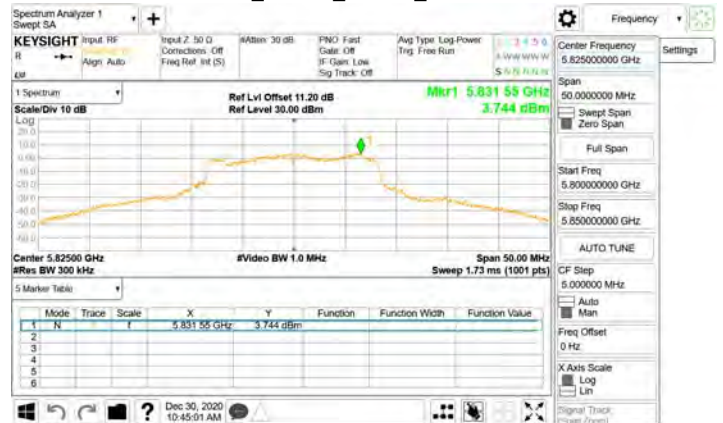

Unless otherwise stated the results shown in this test report refer only to the sample(s) tested and such sample(s) are retained for 90 days only.

除非另有說明，此報告結果僅對測試之樣品負責，同時此樣品僅保留90天。本報告未經本公司書面許可，不可部份複製。

This document is issued by the Company subject to its General Conditions of Service printed overleaf, available on request or accessible at <http://www.sgs.com.tw/Terms-and-Conditions> and for electronic format documents, subject to Terms and Conditions for Electronic Documents at <http://www.sgs.com.tw/Terms-and-Conditions>. Attention is drawn to the limitation of liability, indemnification and jurisdiction issues defined therein. Any holder of this document is advised that information contained hereon reflects the Company's findings at the time of its intervention only and within the limits of Client's instructions, if any. The Company's sole responsibility is to its Client and this document does not exonerate parties to a transaction from exercising all their rights and obligations under the transaction documents. This document cannot be reproduced except in full, without prior written approval of the Company. Any unauthorized alteration, forgery or falsification of the content or appearance of this document is unlawful and offenders may be prosecuted to the fullest extent of the law.

802.11n\_20MHz\_Chain0\_5180MHz

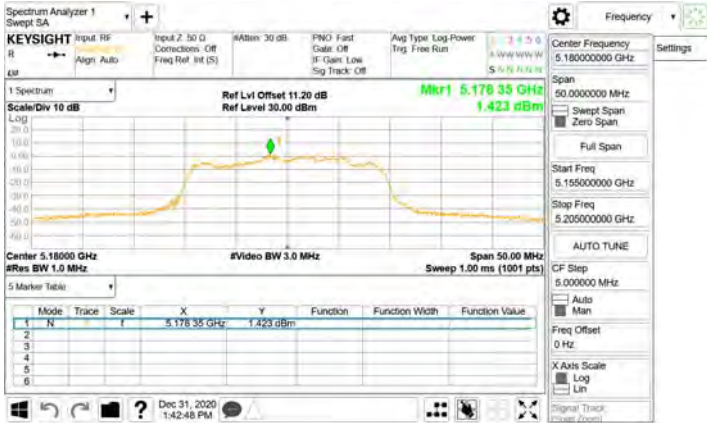

802.11n\_20MHz\_Chain0\_5745MHz

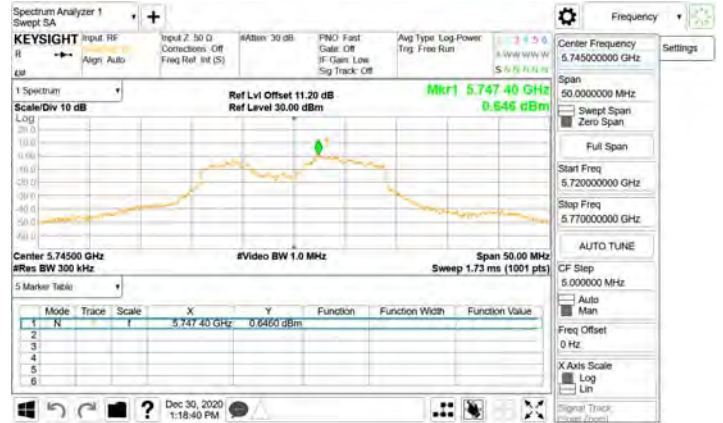

802.11n\_20MHz\_Chain0\_5220MHz



802.11n\_20MHz\_Chain0\_5785MHz

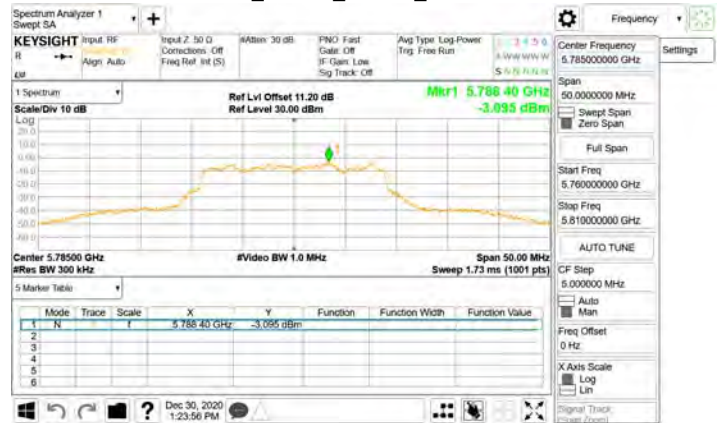

802.11n\_20MHz\_Chain0\_5240MHz



802.11n\_20MHz\_Chain0\_5825MHz

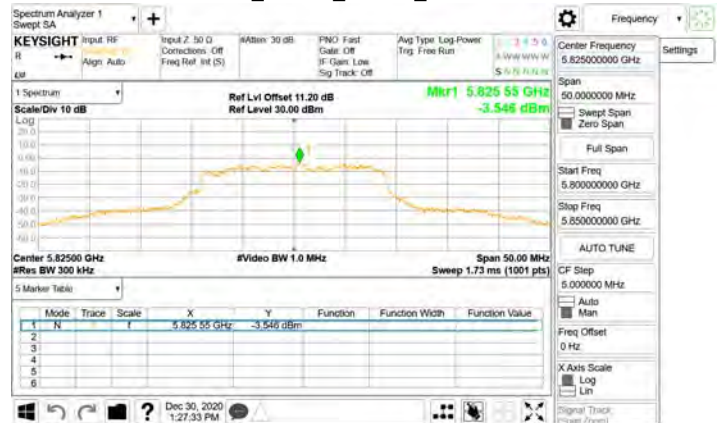

Unless otherwise stated the results shown in this test report refer only to the sample(s) tested and such sample(s) are retained for 90 days only.

除非另有說明，此報告結果僅對測試之樣品負責，同時此樣品僅保留90天。本報告未經本公司書面許可，不可部份複製。

This document is issued by the Company subject to its General Conditions of Service printed overleaf, available on request or accessible at <http://www.sgs.com.tw/Terms-and-Conditions> and for electronic format documents, subject to Terms and Conditions for Electronic Documents at <http://www.sgs.com.tw/Terms-and-Conditions>. Attention is drawn to the limitation of liability, indemnification and jurisdiction issues defined therein. Any holder of this document is advised that information contained hereon reflects the Company's findings at the time of its intervention only and within the limits of Client's instructions, if any. The Company's sole responsibility is to its Client and this document does not exonerate parties to a transaction from exercising all their rights and obligations under the transaction documents. This document cannot be reproduced except in full, without prior written approval of the Company. Any unauthorized alteration, forgery or falsification of the content or appearance of this document is unlawful and offenders may be prosecuted to the fullest extent of the law.

802.11n\_20MHz\_Chain1\_5180MHz

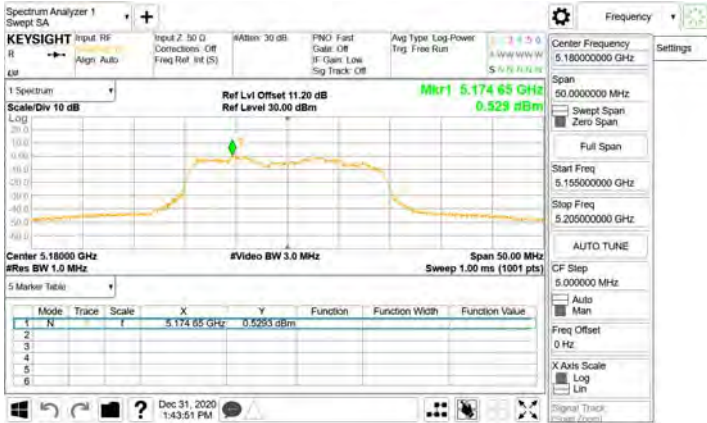

802.11n\_20MHz\_Chain1\_5745MHz

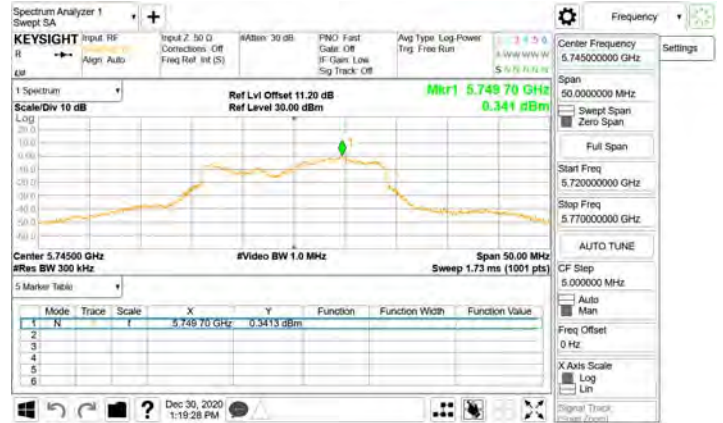

802.11n\_20MHz\_Chain1\_5220MHz



802.11n\_20MHz\_Chain1\_5785MHz



802.11n\_20MHz\_Chain1\_5240MHz



802.11n\_20MHz\_Chain1\_5825MHz



Unless otherwise stated the results shown in this test report refer only to the sample(s) tested and such sample(s) are retained for 90 days only.

除非另有說明，此報告結果僅對測試之樣品負責，同時此樣品僅保留90天。本報告未經本公司書面許可，不可部份複製。

This document is issued by the Company subject to its General Conditions of Service printed overleaf, available on request or accessible at <http://www.sgs.com.tw/Terms-and-Conditions> and for electronic format documents, subject to Terms and Conditions for Electronic Documents at <http://www.sgs.com.tw/Terms-and-Conditions>. Attention is drawn to the limitation of liability, indemnification and jurisdiction issues defined therein. Any holder of this document is advised that information contained hereon reflects the Company's findings at the time of its intervention only and within the limits of Client's instructions, if any. The Company's sole responsibility is to its Client and this document does not exonerate parties to a transaction from exercising all their rights and obligations under the transaction documents. This document cannot be reproduced except in full, without prior written approval of the Company. Any unauthorized alteration, forgery or falsification of the content or appearance of this document is unlawful and offenders may be prosecuted to the fullest extent of the law.

802.11n\_20MHz\_Chain2\_5180MHz



802.11n\_20MHz\_Chain2\_5745MHz



802.11n\_20MHz\_Chain2\_5220MHz



802.11n\_20MHz\_Chain2\_5785MHz



802.11n\_20MHz\_Chain2\_5240MHz

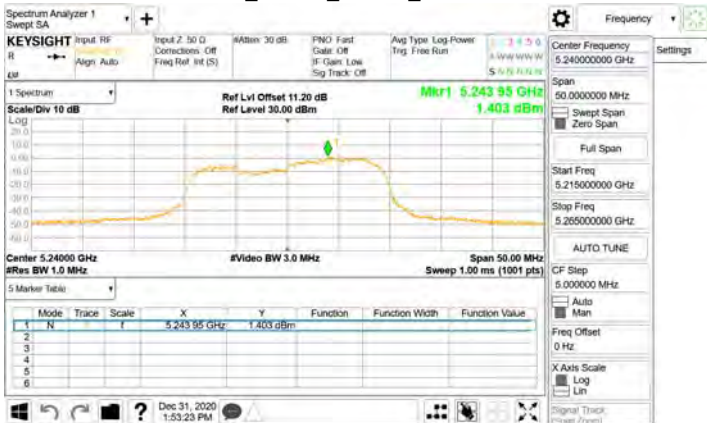

802.11n\_20MHz\_Chain2\_5825MHz

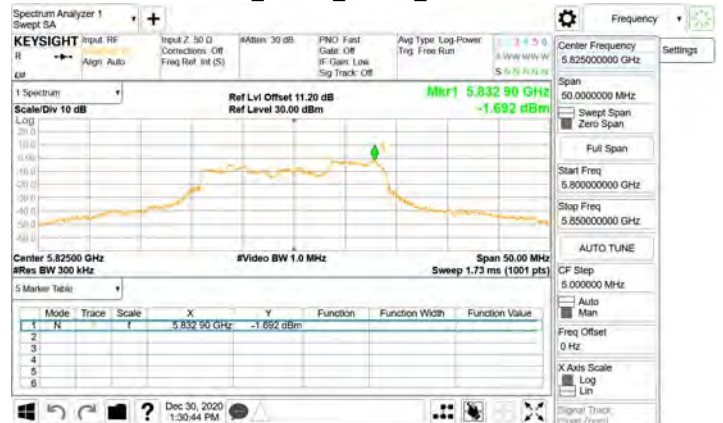

Unless otherwise stated the results shown in this test report refer only to the sample(s) tested and such sample(s) are retained for 90 days only.

除非另有說明，此報告結果僅對測試之樣品負責，同時此樣品僅保留90天。本報告未經本公司書面許可，不可部份複製。

This document is issued by the Company subject to its General Conditions of Service printed overleaf, available on request or accessible at <http://www.sgs.com.tw/Terms-and-Conditions> and for electronic format documents, subject to Terms and Conditions for Electronic Documents at <http://www.sgs.com.tw/Terms-and-Conditions>. Attention is drawn to the limitation of liability, indemnification and jurisdiction issues defined therein. Any holder of this document is advised that information contained hereon reflects the Company's findings at the time of its intervention only and within the limits of Client's instructions, if any. The Company's sole responsibility is to its Client and this document does not exonerate parties to a transaction from exercising all their rights and obligations under the transaction documents. This document cannot be reproduced except in full, without prior written approval of the Company. Any unauthorized alteration, forgery or falsification of the content or appearance of this document is unlawful and offenders may be prosecuted to the fullest extent of the law.



802.11n\_20MHz\_Chain3\_5180MHz

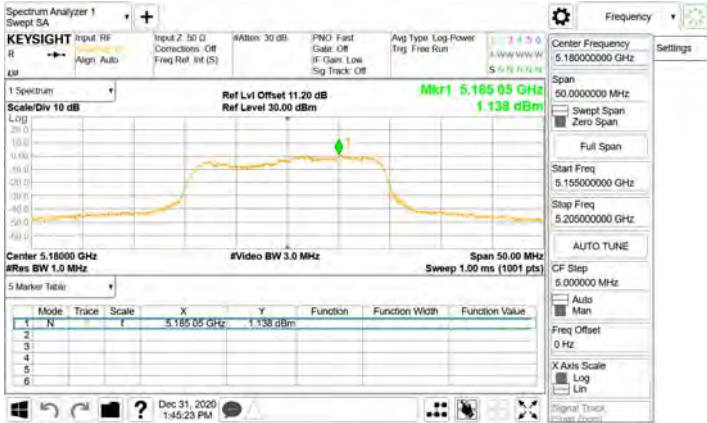

802.11n\_20MHz\_Chain3\_5745MHz

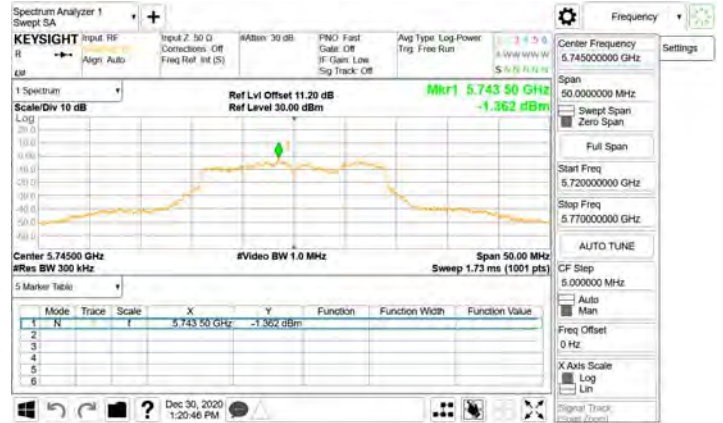

802.11n\_20MHz\_Chain3\_5220MHz



802.11n\_20MHz\_Chain3\_5785MHz



802.11n\_20MHz\_Chain3\_5240MHz

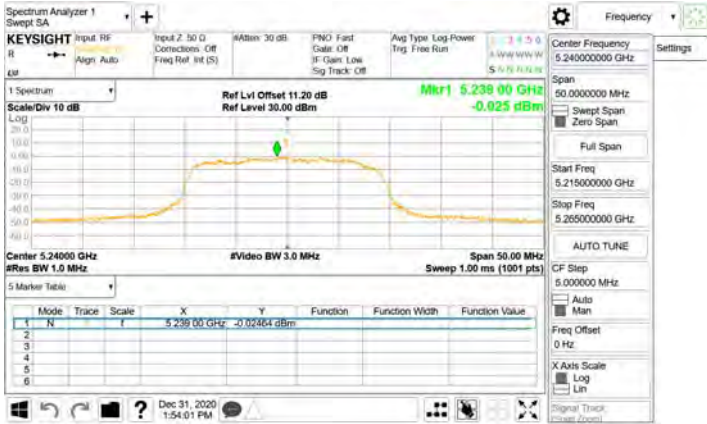

802.11n\_20MHz\_Chain3\_5825MHz



Unless otherwise stated the results shown in this test report refer only to the sample(s) tested and such sample(s) are retained for 90 days only.

除非另有說明，此報告結果僅對測試之樣品負責，同時此樣品僅保留90天。本報告未經本公司書面許可，不可部份複製。

This document is issued by the Company subject to its General Conditions of Service printed overleaf, available on request or accessible at <http://www.sgs.com.tw/Terms-and-Conditions> and for electronic format documents, subject to Terms and Conditions for Electronic Documents at <http://www.sgs.com.tw/Terms-and-Conditions>. Attention is drawn to the limitation of liability, indemnification and jurisdiction issues defined therein. Any holder of this document is advised that information contained hereon reflects the Company's findings at the time of its intervention only and within the limits of Client's instructions, if any. The Company's sole responsibility is to its Client and this document does not exonerate parties to a transaction from exercising all their rights and obligations under the transaction documents. This document cannot be reproduced except in full, without prior written approval of the Company. Any unauthorized alteration, forgery or falsification of the content or appearance of this document is unlawful and offenders may be prosecuted to the fullest extent of the law.

802.11n\_40MHz\_Chain0\_5190MHz



802.11n\_40MHz\_Chain0\_5795MHz

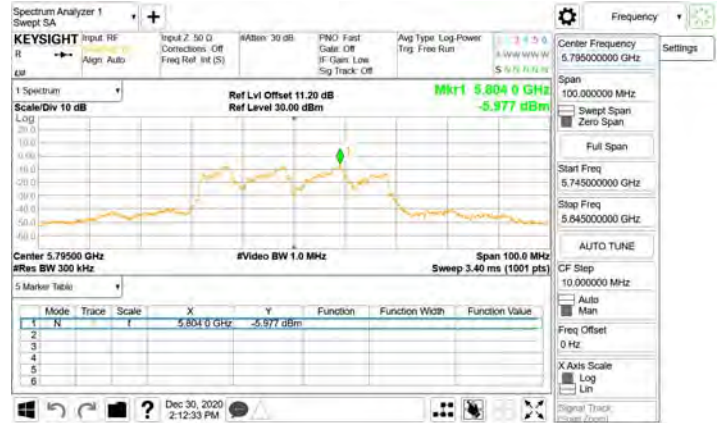

802.11n\_40MHz\_Chain0\_5230MHz

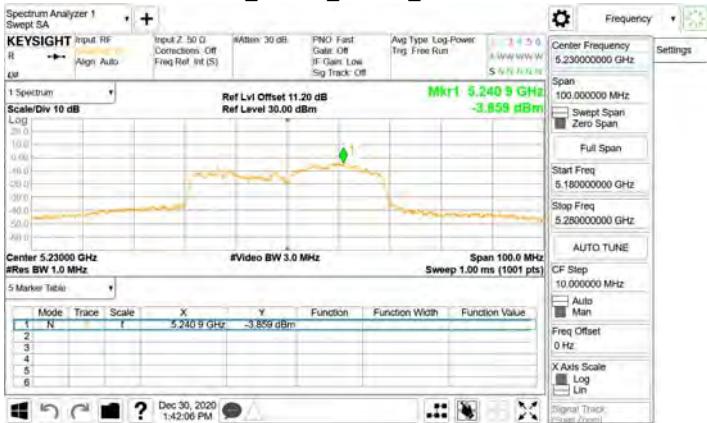

802.11n\_40MHz\_Chain1\_5190MHz



802.11n\_40MHz\_Chain0\_5755MHz

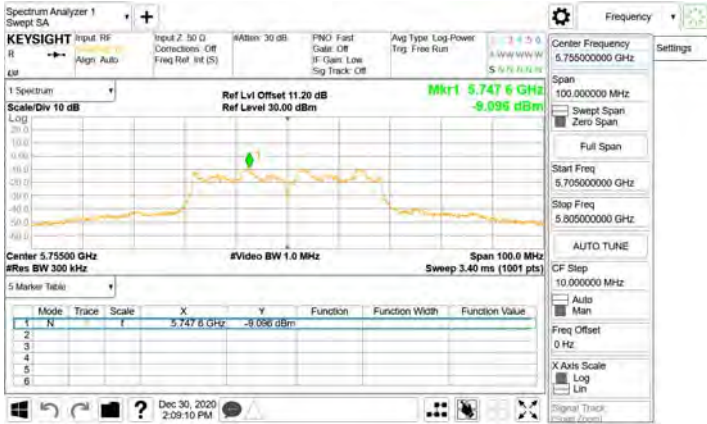

802.11n\_40MHz\_Chain1\_5230MHz

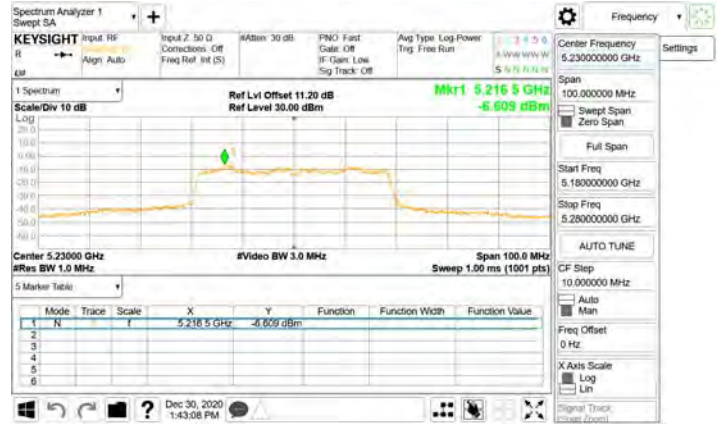

Unless otherwise stated the results shown in this test report refer only to the sample(s) tested and such sample(s) are retained for 90 days only.

除非另有說明，此報告結果僅對測試之樣品負責，同時此樣品僅保留90天。本報告未經本公司書面許可，不可部份複製。

This document is issued by the Company subject to its General Conditions of Service printed overleaf, available on request or accessible at <http://www.sgs.com.tw/Terms-and-Conditions> and for electronic format documents, subject to Terms and Conditions for Electronic Documents at <http://www.sgs.com.tw/Terms-and-Conditions>. Attention is drawn to the limitation of liability, indemnification and jurisdiction issues defined therein. Any holder of this document is advised that information contained hereon reflects the Company's findings at the time of its intervention only and within the limits of Client's instructions, if any. The Company's sole responsibility is to its Client and this document does not exonerate parties to a transaction from exercising all their rights and obligations under the transaction documents. This document cannot be reproduced except in full, without prior written approval of the Company. Any unauthorized alteration, forgery or falsification of the content or appearance of this document is unlawful and offenders may be prosecuted to the fullest extent of the law.

802.11n\_40MHz\_Chain1\_5755MHz

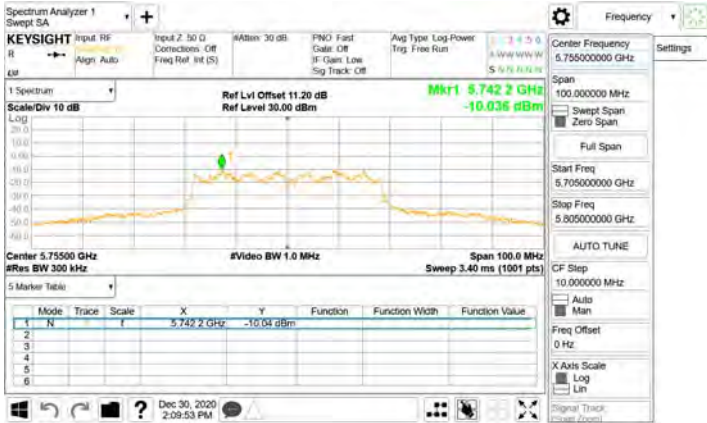

802.11n\_40MHz\_Chain2\_5230MHz



802.11n\_40MHz\_Chain1\_5795MHz

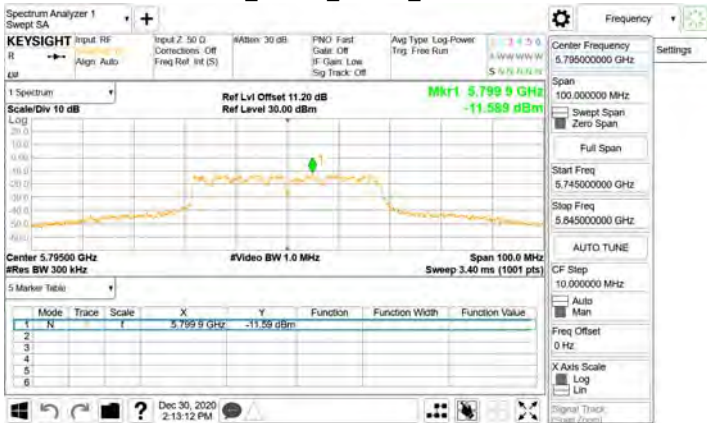

802.11n\_40MHz\_Chain2\_5755MHz



802.11n\_40MHz\_Chain2\_5190MHz

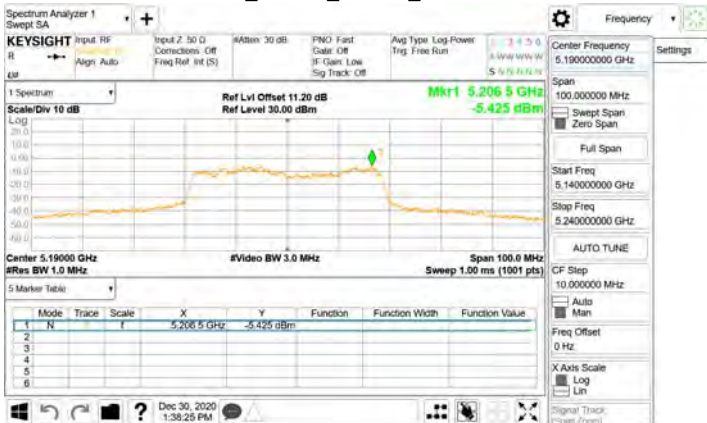

802.11n\_40MHz\_Chain2\_5795MHz

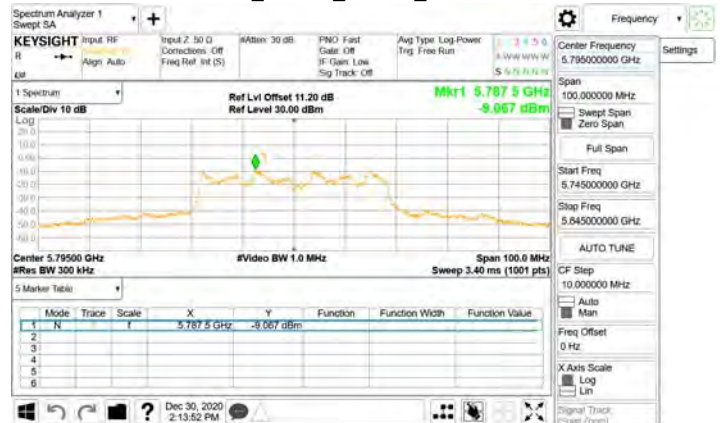

Unless otherwise stated the results shown in this test report refer only to the sample(s) tested and such sample(s) are retained for 90 days only.

除非另有說明，此報告結果僅對測試之樣品負責，同時此樣品僅保留90天。本報告未經本公司書面許可，不可部份複製。

This document is issued by the Company subject to its General Conditions of Service printed overleaf, available on request or accessible at <http://www.sgs.com.tw/Terms-and-Conditions> and for electronic format documents, subject to Terms and Conditions for Electronic Documents at <http://www.sgs.com.tw/Terms-and-Conditions>. Attention is drawn to the limitation of liability, indemnification and jurisdiction issues defined therein. Any holder of this document is advised that information contained hereon reflects the Company's findings at the time of its intervention only and within the limits of Client's instructions, if any. The Company's sole responsibility is to its Client and this document does not exonerate parties to a transaction from exercising all their rights and obligations under the transaction documents. This document cannot be reproduced except in full, without prior written approval of the Company. Any unauthorized alteration, forgery or falsification of the content or appearance of this document is unlawful and offenders may be prosecuted to the fullest extent of the law.

802.11n\_40MHz\_Chain3\_5190MHz

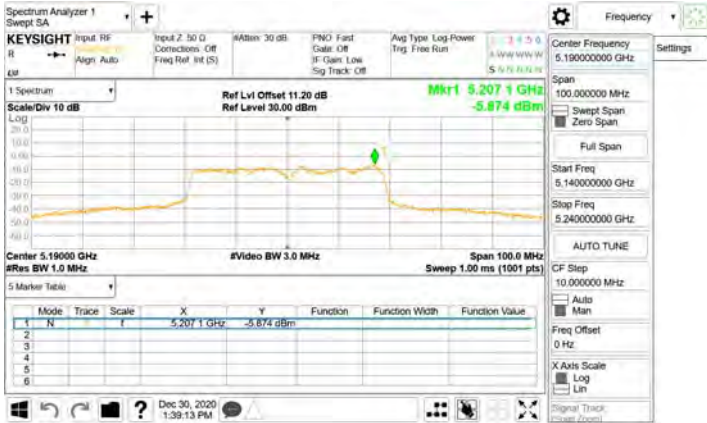

802.11n\_40MHz\_Chain3\_5795MHz

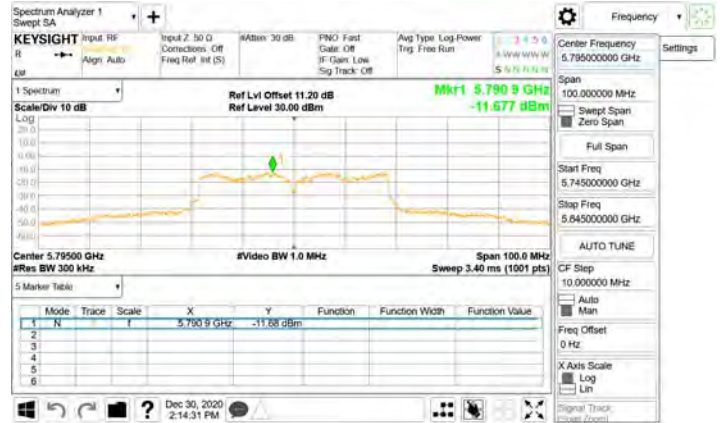

802.11n\_40MHz\_Chain3\_5230MHz

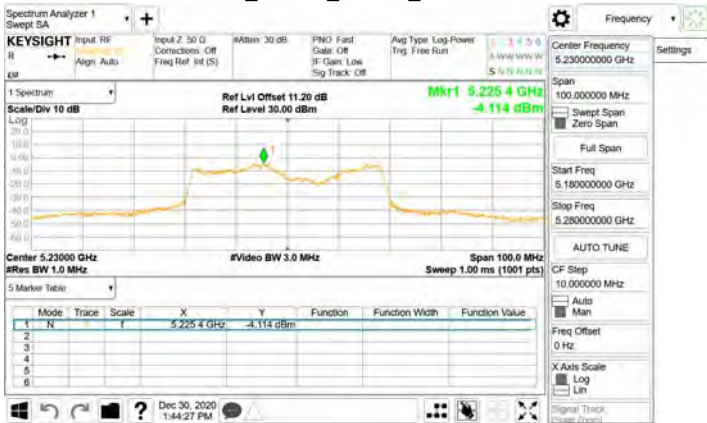

802.11ac\_80MHz\_Chain0\_5210MHz



802.11n\_40MHz\_Chain3\_5755MHz

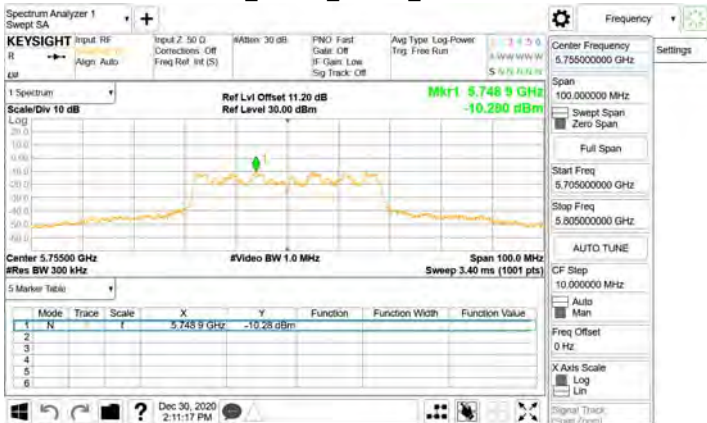

802.11ac\_80MHz\_Chain0\_5775MHz



Unless otherwise stated the results shown in this test report refer only to the sample(s) tested and such sample(s) are retained for 90 days only.

除非另有說明，此報告結果僅對測試之樣品負責，同時此樣品僅保留90天。本報告未經本公司書面許可，不可部份複製。

This document is issued by the Company subject to its General Conditions of Service printed overleaf, available on request or accessible at <http://www.sgs.com.tw/Terms-and-Conditions> and for electronic format documents, subject to Terms and Conditions for Electronic Documents at <http://www.sgs.com.tw/Terms-and-Conditions>. Attention is drawn to the limitation of liability, indemnification and jurisdiction issues defined therein. Any holder of this document is advised that information contained hereon reflects the Company's findings at the time of its intervention only and within the limits of Client's instructions, if any. The Company's sole responsibility is to its Client and this document does not exonerate parties to a transaction from exercising all their rights and obligations under the transaction documents. This document cannot be reproduced except in full, without prior written approval of the Company. Any unauthorized alteration, forgery or falsification of the content or appearance of this document is unlawful and offenders may be prosecuted to the fullest extent of the law.

802.11ac\_80MHz\_Chain1\_5210MHz

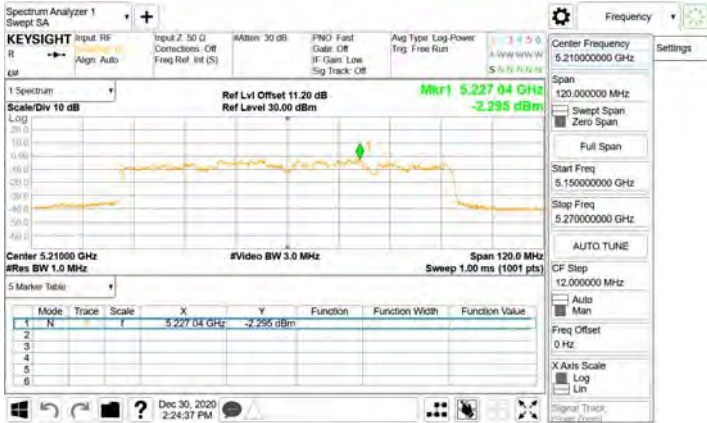

802.11ac\_80MHz\_Chain2\_5775MHz

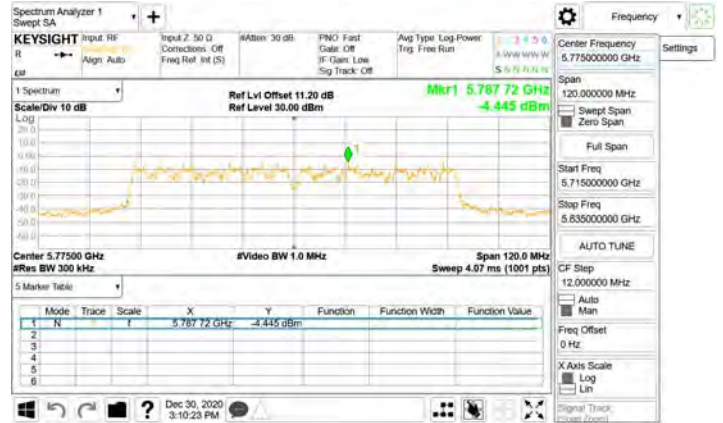

802.11ac\_80MHz\_Chain1\_5775MHz

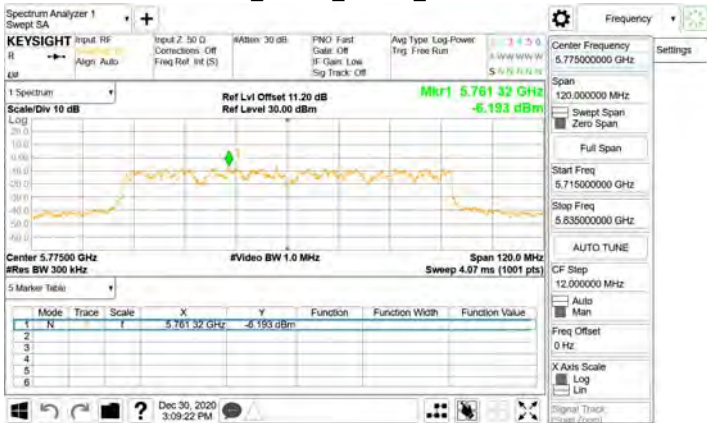

802.11ac\_80MHz\_Chain3\_5210MHz



802.11ac\_80MHz\_Chain2\_5210MHz

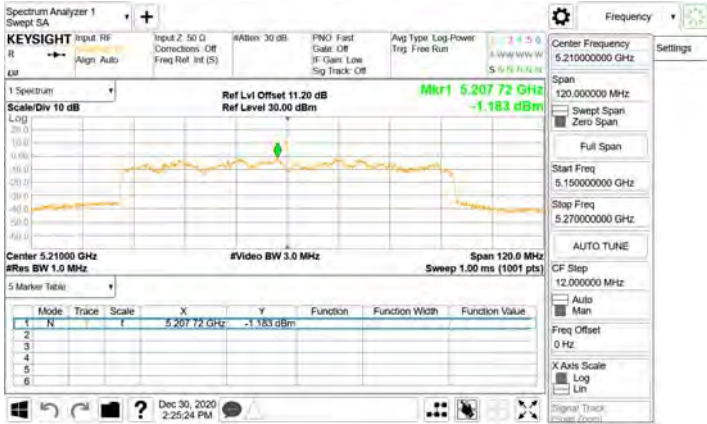

802.11ac\_80MHz\_Chain3\_5775MHz



Unless otherwise stated the results shown in this test report refer only to the sample(s) tested and such sample(s) are retained for 90 days only.

除非另有說明，此報告結果僅對測試之樣品負責，同時此樣品僅保留90天。本報告未經本公司書面許可，不可部份複製。

This document is issued by the Company subject to its General Conditions of Service printed overleaf, available on request or accessible at <http://www.sgs.com.tw/Terms-and-Conditions> and for electronic format documents, subject to Terms and Conditions for Electronic Documents at <http://www.sgs.com.tw/Terms-and-Conditions>. Attention is drawn to the limitation of liability, indemnification and jurisdiction issues defined therein. Any holder of this document is advised that information contained hereon reflects the Company's findings at the time of its intervention only and within the limits of Client's instructions, if any. The Company's sole responsibility is to its Client and this document does not exonerate parties to a transaction from exercising all their rights and obligations under the transaction documents. This document cannot be reproduced except in full, without prior written approval of the Company. Any unauthorized alteration, forgery or falsification of the content or appearance of this document is unlawful and offenders may be prosecuted to the fullest extent of the law.

## 11 UNDESIRABLE RADIATED EMISSION MEASUREMENT

### 11.1 Standard Applicable

#### 11.1.1 Band Edge

The maximum emissions outside of the frequency bands of operation shall be attenuated in accordance with the following limits:

1. For transmitters operating in the 5.15-5.25 GHz band: All emissions outside of the 5.15-5.35 GHz band shall not exceed an e.i.r.p. of -27 dBm/MHz.
2. For transmitters operating in the 5.725-5.85 GHz band: All emissions shall be limited to a level of -27 dBm/MHz at 75 MHz or more above or below the band edge increasing linearly to 10 dBm/MHz at 25 MHz above or below the band edge, and from 25 MHz above or below the band edge increasing linearly to a level of 15.6 dBm/MHz at 5 MHz above or below the band edge, and from 5 MHz above or below the band edge increasing linearly to a level of 27 dBm/MHz at the band edge.

APPLICABLE TO	EIRP LIMIT	FIELD STRENGTH AT 3m
15.407(b)(1) RSS-247 §6.2.1.2	PK: -27 (dBm/MHz)	PK: 68.3 (dBµV/m)
15.407(b)(2) RSS-247 §6.2.2.2		
15.407(b)(3) RSS-247 §6.2.3.2		
15.407(b)(4)(i) RSS-247 §6.2.4.2	PK:-27 (dBm/MHz) *1 PK:10 (dBm/MHz) *2 PK:15.6 (dBm/MHz) *3 PK:27 (dBm/MHz) *4	PK: 68.2(dBµV/m) *1 PK:105.2 (dBµV/m) *2 PK: 110.8(dBµV/m) *3 PK:122.2 (dBµV/m) *4
<p>*1 beyond 75 MHz or more above of the bandedge.            *2 below the band edge increasing linearly to 10 dBm/MHz at 25 MHz above.            *3 below the band edge increasing linearly to a level of 15.6 dBm/MHz at 5 MHz above.            *4 from 5 MHz above or below the band edge increasing linearly to a level of 27 dBm/MHz at the band edge.</p>		

$EIRP = (E \cdot d)^2 / 30$ , where  $E$  is the field in V/m,  $d$  is the measurement distance (3m),  $EIRP$  is the equivalent isotropically radiated power in Watts.

Unless otherwise stated the results shown in this test report refer only to the sample(s) tested and such sample(s) are retained for 90 days only.

除非另有說明，此報告結果僅對測試之樣品負責，同時此樣品僅保留90天。本報告未經本公司書面許可，不可部份複製。

This document is issued by the Company subject to its General Conditions of Service printed overleaf, available on request or accessible at <http://www.sgs.com.tw/Terms-and-Conditions> and for electronic format documents, subject to Terms and Conditions for Electronic Documents at <http://www.sgs.com.tw/Terms-and-Conditions>. Attention is drawn to the limitation of liability, indemnification and jurisdiction issues defined therein. Any holder of this document is advised that information contained hereon reflects the Company's findings at the time of its intervention only and within the limits of Client's instructions, if any. The Company's sole responsibility is to its Client and this document does not exonerate parties to a transaction from exercising all their rights and obligations under the transaction documents. This document cannot be reproduced except in full, without prior written approval of the Company. Any unauthorized alteration, forgery or falsification of the content or appearance of this document is unlawful and offenders may be prosecuted to the fullest extent of the law.

### 11.1.2 Spurious Emission

Unwanted spurious emissions which fall in the restricted bands must comply with the radiated emission limits specified as below table:

Frequency (MHz)	Field strength (microvolts/meter)	Distance (meters)
0.009-0.490	2400/F(KHz)	300
0.490-1.705	24000/F(KHz)	30
1.705-30	30	30
30-88	100	3
88-216	150	3
216-960	200	3
Above 960	500	3

**Note:**

1. The lower limit shall apply at the transition frequencies.
2. Emission level (dBμV/m) = 20 log Emission level (μV/m)

Unless otherwise stated the results shown in this test report refer only to the sample(s) tested and such sample(s) are retained for 90 days only.

除非另有說明，此報告結果僅對測試之樣品負責，同時此樣品僅保留90天。本報告未經本公司書面許可，不可部份複製。

This document is issued by the Company subject to its General Conditions of Service printed overleaf, available on request or accessible at <http://www.sgs.com.tw/Terms-and-Conditions> and for electronic format documents, subject to Terms and Conditions for Electronic Documents at <http://www.sgs.com.tw/Terms-and-Conditions>. Attention is drawn to the limitation of liability, indemnification and jurisdiction issues defined therein. Any holder of this document is advised that information contained hereon reflects the Company's findings at the time of its intervention only and within the limits of Client's instructions, if any. The Company's sole responsibility is to its Client and this document does not exonerate parties to a transaction from exercising all their rights and obligations under the transaction documents. This document cannot be reproduced except in full, without prior written approval of the Company. Any unauthorized alteration, forgery or falsification of the content or appearance of this document is unlawful and offenders may be prosecuted to the fullest extent of the law.

11.2 Measurement Equipment Used

SGS SAC-III					
Name of Equipment	Manufacturer	Model	Serial Number	Calibration Date	Calibration Due
Broadband Antenna	TESEQ	CBL 6112D	35240	09/08/2020	09/07/2021
Horn Antenna	Schwarzbeck	BBHA9120D	1341	06/22/2020	06/21/2021
Horn Antenna	Schwarzbeck	BBHA9170	185	07/30/2020	07/29/2021
Loop Antenna	ETS.LINDGREN	6502	143303	04/28/2020	04/27/2021
3m Site NSA	SGS	966 chamber D	N/A	07/12/2020	07/11/2021
Spectrum Analyzer	KEYSIGHT	N9010A	MY54510568	07/08/2020	07/07/2021
Pre-Amplifier	EMC Instruments	EMC184045B	980135	10/27/2020	10/26/2021
Pre-Amplifier	EMC Instruments	EMC9135	980234	11/19/2020	11/18/2021
Pre-Amplifier	EMC Instruments	EMC12630SE	980271	11/19/2020	11/18/2021
Attenuator	Marvelous	WATT-218FS-10	RF25	11/19/2020	11/18/2021
High Pass Filter	R&S	F13 HPF 3GHz	RF175	11/19/2020	11/18/2021
Lowpass Filter	Woken	EWT-56-0019	RF173	11/19/2020	11/18/2021
Notch Filter	Woken	EWT-54-0038	RF178	11/19/2020	11/18/2021
Coaxial Cable	Huber Suhner	EMC106-SM-SM-7200	150703	11/19/2020	11/18/2021
Coaxial Cable	Huber+Suhner	RG 214/U	W21.01	11/19/2020	11/18/2021
Coaxial Cable	Huber Suhner	SUCOFLEX 104	MY17413/4	11/19/2020	11/18/2021

Unless otherwise stated the results shown in this test report refer only to the sample(s) tested and such sample(s) are retained for 90 days only.

除非另有說明，此報告結果僅對測試之樣品負責，同時此樣品僅保留90天。本報告未經本公司書面許可，不可部份複製。

This document is issued by the Company subject to its General Conditions of Service printed overleaf, available on request or accessible at <http://www.sgs.com.tw/Terms-and-Conditions> and for electronic format documents, subject to Terms and Conditions for Electronic Documents at <http://www.sgs.com.tw/Terms-and-Conditions>. Attention is drawn to the limitation of liability, indemnification and jurisdiction issues defined therein. Any holder of this document is advised that information contained hereon reflects the Company's findings at the time of its intervention only and within the limits of Client's instructions, if any. The Company's sole responsibility is to its Client and this document does not exonerate parties to a transaction from exercising all their rights and obligations under the transaction documents. This document cannot be reproduced except in full, without prior written approval of the Company. Any unauthorized alteration, forgery or falsification of the content or appearance of this document is unlawful and offenders may be prosecuted to the fullest extent of the law.



### 11.3 Test SET-UP

(A) Radiated Emission Test Set-UP Frequency Below 30MHz.

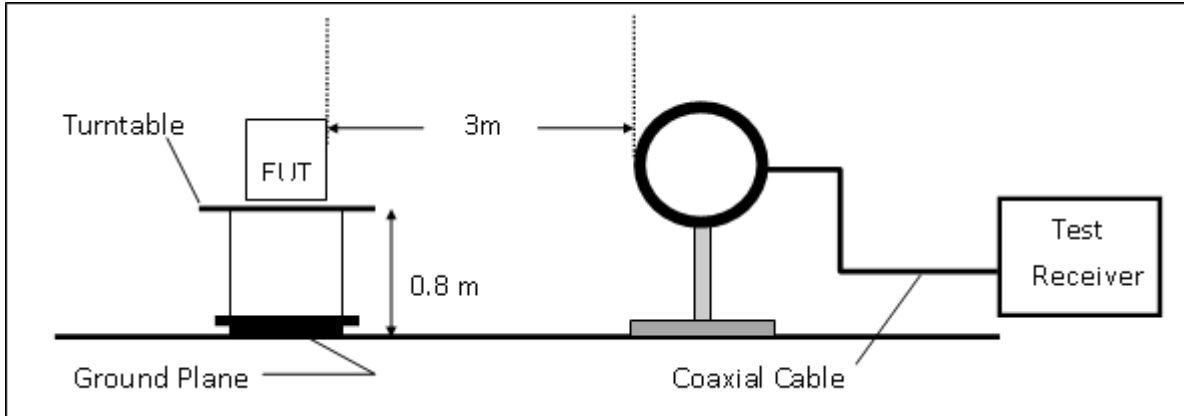

(B) Radiated Emission Test Set-UP, Frequency form 30MHz to 1000MHz

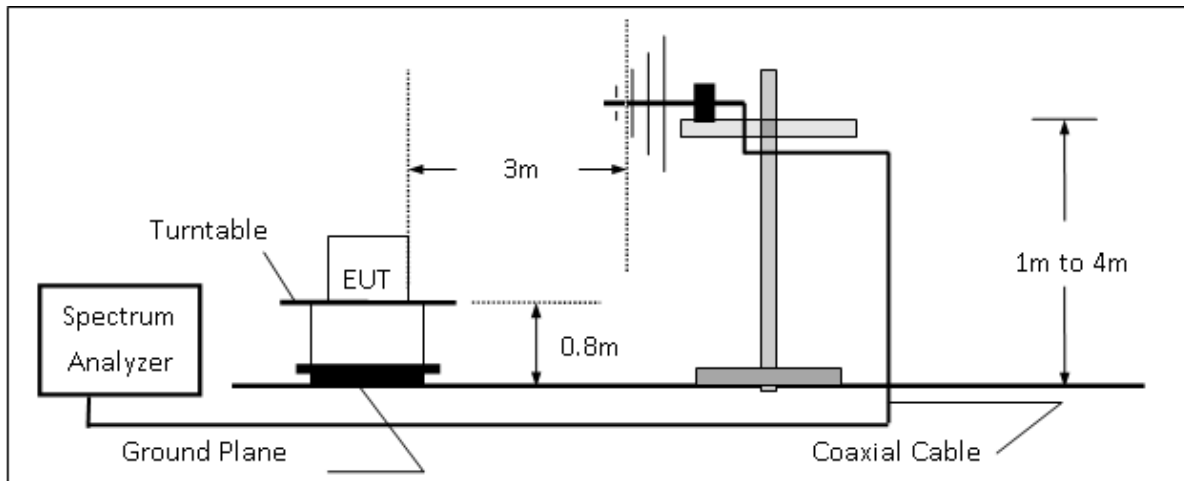

(C) Radiated Emission Test Set-UP Frequency Over 1 GHz

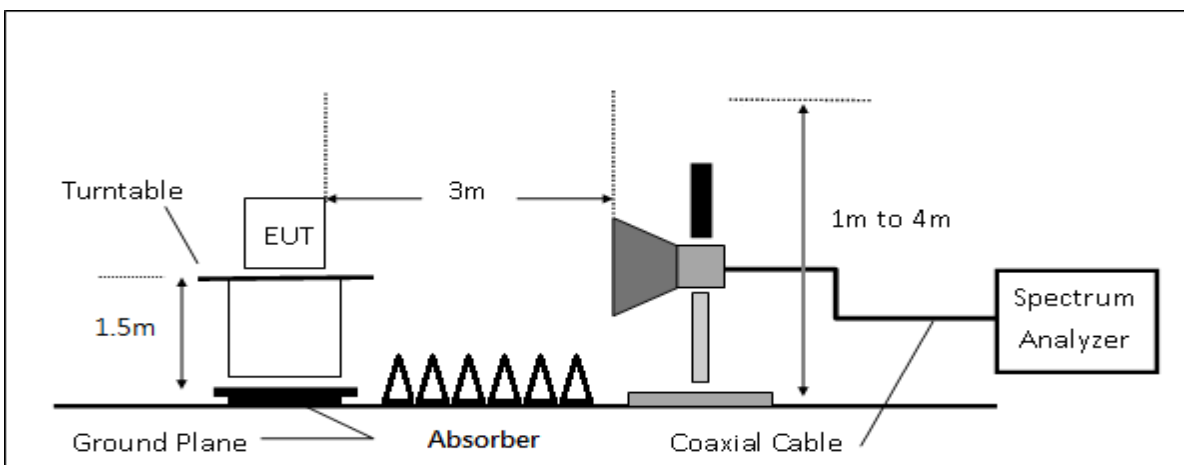

Unless otherwise stated the results shown in this test report refer only to the sample(s) tested and such sample(s) are retained for 90 days only.

除非另有說明，此報告結果僅對測試之樣品負責，同時此樣品僅保留90天。本報告未經本公司書面許可，不可部份複製。

This document is issued by the Company subject to its General Conditions of Service printed overleaf, available on request or accessible at <http://www.sgs.com.tw/Terms-and-Conditions> and for electronic format documents, subject to Terms and Conditions for Electronic Documents at <http://www.sgs.com.tw/Terms-and-Conditions>. Attention is drawn to the limitation of liability, indemnification and jurisdiction issues defined therein. Any holder of this document is advised that information contained hereon reflects the Company's findings at the time of its intervention only and within the limits of Client's instructions, if any. The Company's sole responsibility is to its Client and this document does not exonerate parties to a transaction from exercising all their rights and obligations under the transaction documents. This document cannot be reproduced except in full, without prior written approval of the Company. Any unauthorized alteration, forgery or falsification of the content or appearance of this document is unlawful and offenders may be prosecuted to the fullest extent of the law.

## 11.4 Measurement Procedure

1. The EUT was placed on a turn table which is 0.8m above ground plane.
2. The testing follows FCC KDB 789033 D02 General UNII Test Procedures New Rules .
3. The EUT was placed on a turn table with 0.8m for frequency < 1GHz and 1.5m for frequency > 1GHz above ground plane.
4. The turn table shall rotate 360 degrees to determine the position of maximum emission level.
5. EUT is set 3m away from the receiving antenna which varied from 1m to 4m to find out the highest emissions.
6. Set the spectrum analyzer as RBW=120 kHz and VBW=300 kHz for Peak Detector (PK) and Quasi-peak (QP) at frequency below 1 GHz.
7. At frequency above 1 GHz, Set the spectrum analyzer:
  - A. RBW=1 MHz, VBW=3 MHz for **Peak** Detector.
  - B. Set the spectrum analyzer as RBW=1 MHz, VBW=10 Hz (Duty cycle > 98%) or VBW ≥ 1/T (Duty cycle < 98%) for **Average** Detector.
8. Maximum procedure was performed on the six highest emissions to ensure EUT compliance.
9. And also, each emission was to be maximized by changing the polarization of receiving antenna both horizontal and vertical.
10. Repeat above procedures until all frequency measured were complete.

Unless otherwise stated the results shown in this test report refer only to the sample(s) tested and such sample(s) are retained for 90 days only.

除非另有說明，此報告結果僅對測試之樣品負責，同時此樣品僅保留90天。本報告未經本公司書面許可，不可部份複製。

This document is issued by the Company subject to its General Conditions of Service printed overleaf, available on request or accessible at <http://www.sgs.com.tw/Terms-and-Conditions> and for electronic format documents, subject to Terms and Conditions for Electronic Documents at <http://www.sgs.com.tw/Terms-and-Conditions>. Attention is drawn to the limitation of liability, indemnification and jurisdiction issues defined therein. Any holder of this document is advised that information contained hereon reflects the Company's findings at the time of its intervention only and within the limits of Client's instructions, if any. The Company's sole responsibility is to its Client and this document does not exonerate parties to a transaction from exercising all their rights and obligations under the transaction documents. This document cannot be reproduced except in full, without prior written approval of the Company. Any unauthorized alteration, forgery or falsification of the content or appearance of this document is unlawful and offenders may be prosecuted to the fullest extent of the law.

### 11.5 Field Strength Calculation

The field strength is calculated by adding the Antenna Factor and Cable Factor and subtracting the Amplifier Gain and Duty Cycle Correction Factor (if any) from the measured reading. The basic equation with a sample calculation is as follows:

$$FS = RA + AF + CL - AG$$

**Where** *FS = Field Strength*

*CL = Cable Attenuation Factor (Cable Loss)*

*RA = Reading Amplitude*

*AG = Amplifier Gain*

*AF = Antenna Factor*

The limit of the emission level is expressed in dBuV/m, which converts  $20 \cdot \log(uV/m)$

*Actual FS(dBμV/m) = SPA. Reading level(dBμV) + Factor(dB)*

*Factor(dB) = Antenna Factor(dBμV/m) + Cable Loss(dB) – Pre\_Amplifier Gain(dB)*

### 11.6 Test Results of Radiated Spurious Emissions form 9 KHz to 30 MHz

The low frequency, which started from 9 kHz to 30MHz, was pre-scanned and the result which was 20dB lower than the limit per 15.31(o) was not reported.

Unless otherwise stated the results shown in this test report refer only to the sample(s) tested and such sample(s) are retained for 90 days only.

除非另有說明，此報告結果僅對測試之樣品負責，同時此樣品僅保留90天。本報告未經本公司書面許可，不可部份複製。

This document is issued by the Company subject to its General Conditions of Service printed overleaf, available on request or accessible at <http://www.sgs.com.tw/Terms-and-Conditions> and for electronic format documents, subject to Terms and Conditions for Electronic Documents at <http://www.sgs.com.tw/Terms-and-Conditions>. Attention is drawn to the limitation of liability, indemnification and jurisdiction issues defined therein. Any holder of this document is advised that information contained hereon reflects the Company's findings at the time of its intervention only and within the limits of Client's instructions, if any. The Company's sole responsibility is to its Client and this document does not exonerate parties to a transaction from exercising all their rights and obligations under the transaction documents. This document cannot be reproduced except in full, without prior written approval of the Company. Any unauthorized alteration, forgery or falsification of the content or appearance of this document is unlawful and offenders may be prosecuted to the fullest extent of the law.

## 11.7 Radiated Spurious Emission Measurement Result

### 11.7.1 Below 1GHz Worst-Case Data:

Report Number	:E2/2020/B0037	Test Site	:966 Chamber D
Operation Mode	:802.11a / Band 1	Test Date	:2020-12-25
Test Frequency	:5220 MHz	Temp./Humi.	:20.3/66
Test Mode	:TX CH MID	Antenna Pol.	:Vertical
EUT Pol	:H Plan	Engineer	:Kailin Lee

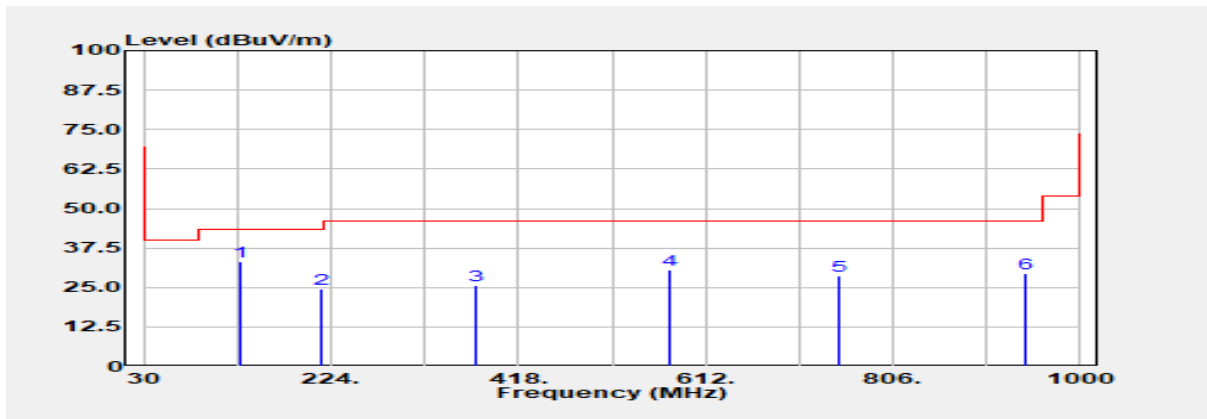

Freq. MHz	Detector Mode PK/QP/AV	Spectrum Reading Level dB $\mu$ V	Factor dB	Actual FS dB $\mu$ V/m	Limit @3m dB $\mu$ V/m	Margin dB
129.487	Peak	51.60	-18.33	33.27	43.50	-10.23
214.984	Peak	44.27	-19.92	24.35	43.50	-19.15
375.096	Peak	40.24	-14.52	25.72	46.00	-20.28
575.625	Peak	41.70	-11.00	30.70	46.00	-15.30
749.728	Peak	36.48	-7.66	28.82	46.00	-17.18
944.039	Peak	34.19	-4.79	29.40	46.00	-16.60

Unless otherwise stated the results shown in this test report refer only to the sample(s) tested and such sample(s) are retained for 90 days only.

除非另有說明，此報告結果僅對測試之樣品負責，同時此樣品僅保留90天。本報告未經本公司書面許可，不可部份複製。

This document is issued by the Company subject to its General Conditions of Service printed overleaf, available on request or accessible at <http://www.sgs.com.tw/Terms-and-Conditions> and for electronic format documents, subject to Terms and Conditions for Electronic Documents at <http://www.sgs.com.tw/Terms-and-Conditions>. Attention is drawn to the limitation of liability, indemnification and jurisdiction issues defined therein. Any holder of this document is advised that information contained hereon reflects the Company's findings at the time of its intervention only and within the limits of Client's instructions, if any. The Company's sole responsibility is to its Client and this document does not exonerate parties to a transaction from exercising all their rights and obligations under the transaction documents. This document cannot be reproduced except in full, without prior written approval of the Company. Any unauthorized alteration, forgery or falsification of the content or appearance of this document is unlawful and offenders may be prosecuted to the fullest extent of the law.

Report Number :E2/2020/B0037  
 Operation Mode :802.11a / Band 1  
 Test Frequency :5220 MHz  
 Test Mode :TX CH MID  
 EUT Pol :H Plan

Test Site :966 Chamber D  
 Test Date :2020-12-25  
 Temp./Humi. :20.3/66  
 Antenna Pol. :Horizontal  
 Engineer :Kailin Lee

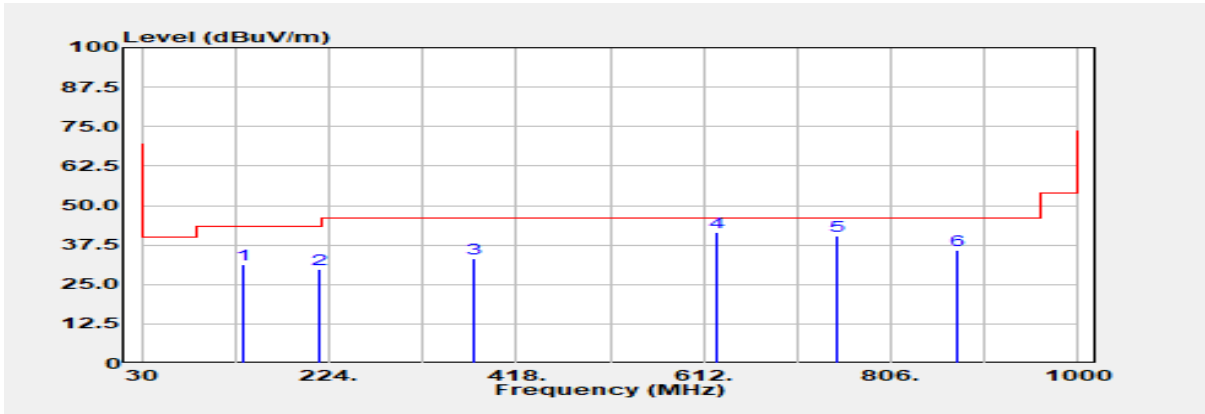

Freq. MHz	Detector Mode PK/QP/AV	Spectrum Reading Level dBuV	Factor dB	Actual FS dBuV/m	Limit @3m dBuV/m	Margin dB
134.151	Peak	49.45	-17.96	31.48	43.50	-12.02
214.984	Peak	49.73	-19.92	29.81	43.50	-13.69
375.096	Peak	47.69	-14.52	33.17	46.00	-12.83
625.369	Peak	50.54	-9.21	41.33	46.00	-4.67
749.728	Peak	47.93	-7.66	40.27	46.00	-5.73
875.641	Peak	42.12	-6.25	35.87	46.00	-10.13

Unless otherwise stated the results shown in this test report refer only to the sample(s) tested and such sample(s) are retained for 90 days only.

除非另有說明，此報告結果僅對測試之樣品負責，同時此樣品僅保留90天。本報告未經本公司書面許可，不可部份複製。

This document is issued by the Company subject to its General Conditions of Service printed overleaf, available on request or accessible at <http://www.sgs.com.tw/Terms-and-Conditions> and for electronic format documents, subject to Terms and Conditions for Electronic Documents at <http://www.sgs.com.tw/Terms-and-Conditions>. Attention is drawn to the limitation of liability, indemnification and jurisdiction issues defined therein. Any holder of this document is advised that information contained hereon reflects the Company's findings at the time of its intervention only and within the limits of Client's instructions, if any. The Company's sole responsibility is to its Client and this document does not exonerate parties to a transaction from exercising all their rights and obligations under the transaction documents. This document cannot be reproduced except in full, without prior written approval of the Company. Any unauthorized alteration, forgery or falsification of the content or appearance of this document is unlawful and offenders may be prosecuted to the fullest extent of the law.

Report Number :E2/2020/B0037  
 Operation Mode :802.11a / Band 4  
 Test Frequency :5785 MHz  
 Test Mode :TX CH MID  
 EUT Pol :H Plan

Test Site :966 Chamber D  
 Test Date :2020-12-25  
 Temp./Humi. :20.3/66  
 Antenna Pol. :Vertical  
 Engineer :Kailin Lee

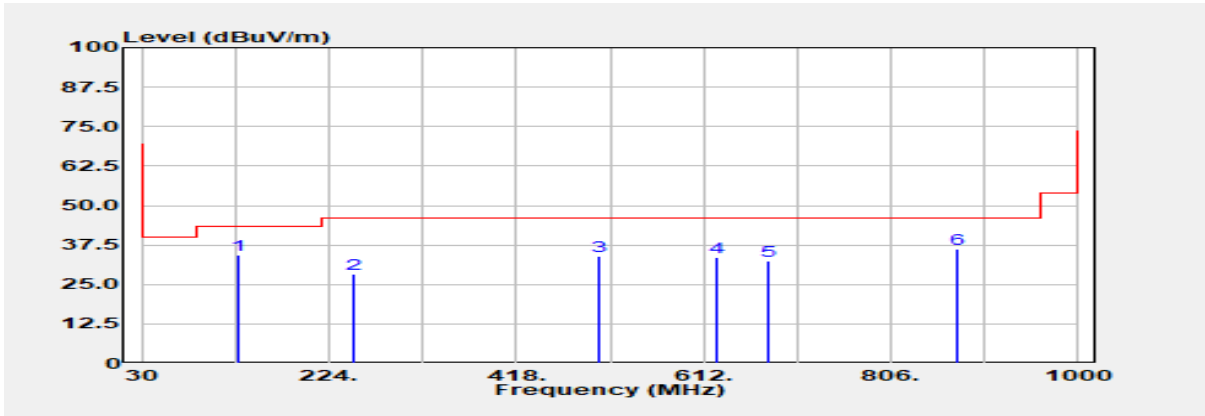

Freq. MHz	Detector Mode PK/QP/AV	Spectrum Reading Level dBuV	Factor dB	Actual FS dBuV/m	Limit @3m dBuV/m	Margin dB
129.487	Peak	52.86	-18.33	34.53	43.50	-8.97
249.183	Peak	46.50	-18.14	28.35	46.00	-17.65
504.119	Peak	45.48	-11.66	33.82	46.00	-12.18
625.369	Peak	42.72	-9.21	33.50	46.00	-12.50
679.776	Peak	40.55	-8.23	32.32	46.00	-13.68
875.641	Peak	42.34	-6.25	36.09	46.00	-9.91

Unless otherwise stated the results shown in this test report refer only to the sample(s) tested and such sample(s) are retained for 90 days only.

除非另有說明，此報告結果僅對測試之樣品負責，同時此樣品僅保留90天。本報告未經本公司書面許可，不可部份複製。

This document is issued by the Company subject to its General Conditions of Service printed overleaf, available on request or accessible at <http://www.sgs.com.tw/Terms-and-Conditions> and for electronic format documents, subject to Terms and Conditions for Electronic Documents at <http://www.sgs.com.tw/Terms-and-Conditions>. Attention is drawn to the limitation of liability, indemnification and jurisdiction issues defined therein. Any holder of this document is advised that information contained hereon reflects the Company's findings at the time of its intervention only and within the limits of Client's instructions, if any. The Company's sole responsibility is to its Client and this document does not exonerate parties to a transaction from exercising all their rights and obligations under the transaction documents. This document cannot be reproduced except in full, without prior written approval of the Company. Any unauthorized alteration, forgery or falsification of the content or appearance of this document is unlawful and offenders may be prosecuted to the fullest extent of the law.

Report Number	:E2/2020/B0037	Test Site	:966 Chamber D
Operation Mode	:802.11a / Band 4	Test Date	:2020-12-25
Test Frequency	:5785 MHz	Temp./Humi.	:20.3/66
Test Mode	:TX CH MID	Antenna Pol.	:Horizontal
EUT Pol	:H Plan	Engineer	:Kailin Lee

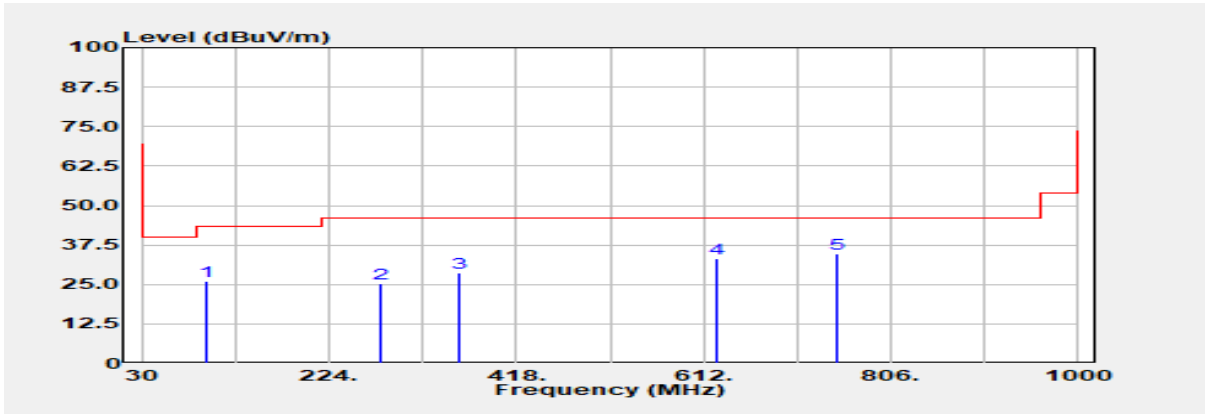

Freq. MHz	Detector Mode PK/QP/AV	Spectrum Reading Level dB $\mu$ V	Factor dB	Actual FS dB $\mu$ V/m	Limit @3m dB $\mu$ V/m	Margin dB
96.843	Peak	48.43	-22.52	25.91	43.50	-17.59
277.164	Peak	42.10	-16.73	25.38	46.00	-20.62
359.551	Peak	43.51	-14.99	28.52	46.00	-17.48
625.369	Peak	42.43	-9.21	33.22	46.00	-12.78
749.728	Peak	42.28	-7.66	34.62	46.00	-11.38

Unless otherwise stated the results shown in this test report refer only to the sample(s) tested and such sample(s) are retained for 90 days only.

除非另有說明，此報告結果僅對測試之樣品負責，同時此樣品僅保留90天。本報告未經本公司書面許可，不可部份複製。

This document is issued by the Company subject to its General Conditions of Service printed overleaf, available on request or accessible at <http://www.sgs.com.tw/Terms-and-Conditions> and for electronic format documents, subject to Terms and Conditions for Electronic Documents at <http://www.sgs.com.tw/Terms-and-Conditions>. Attention is drawn to the limitation of liability, indemnification and jurisdiction issues defined therein. Any holder of this document is advised that information contained hereon reflects the Company's findings at the time of its intervention only and within the limits of Client's instructions, if any. The Company's sole responsibility is to its Client and this document does not exonerate parties to a transaction from exercising all their rights and obligations under the transaction documents. This document cannot be reproduced except in full, without prior written approval of the Company. Any unauthorized alteration, forgery or falsification of the content or appearance of this document is unlawful and offenders may be prosecuted to the fullest extent of the law.

Report Number	:E2/2020/B0037	Test Site	:966 Chamber D
Operation Mode	:802.11ac80 / Band 1	Test Date	:2020-12-25
Test Frequency	:5210 MHz	Temp./Humi.	:20.3/66
Test Mode	:TX CH LOW	Antenna Pol.	:Vertical
EUT Pol	:H Plan	Engineer	:Kailin Lee

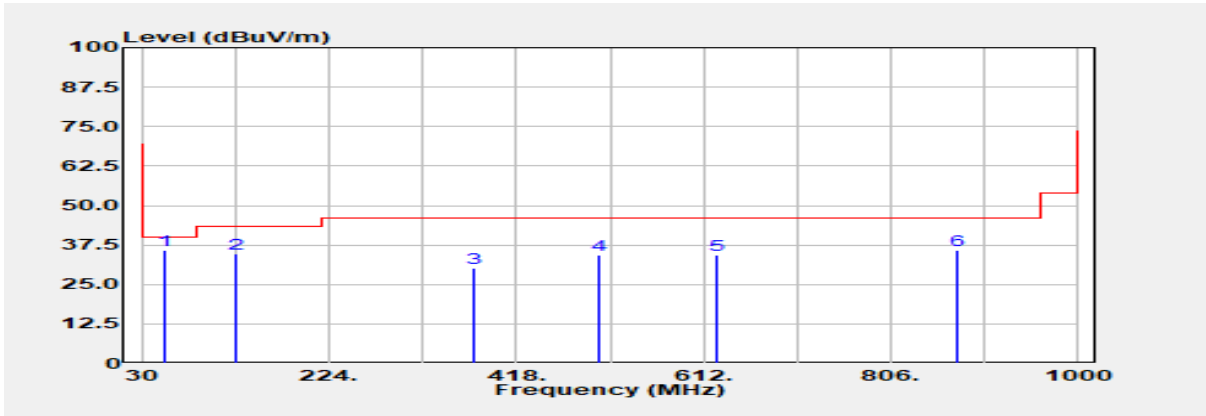

Freq. MHz	Detector Mode PK/QP/AV	Spectrum Reading Level dB $\mu$ V	Factor dB	Actual FS dB $\mu$ V/m	Limit @3m dB $\mu$ V/m	Margin dB
53.317	Peak	53.33	-17.65	35.68	40.00	-4.32
126.378	Peak	53.27	-18.67	34.60	43.50	-8.90
375.096	Peak	44.64	-14.52	30.12	46.00	-15.88
504.119	Peak	45.89	-11.66	34.23	46.00	-11.77
625.369	Peak	43.58	-9.21	34.37	46.00	-11.63
875.641	Peak	41.97	-6.25	35.72	46.00	-10.28

Unless otherwise stated the results shown in this test report refer only to the sample(s) tested and such sample(s) are retained for 90 days only.

除非另有說明，此報告結果僅對測試之樣品負責，同時此樣品僅保留90天。本報告未經本公司書面許可，不可部份複製。

This document is issued by the Company subject to its General Conditions of Service printed overleaf, available on request or accessible at <http://www.sgs.com.tw/Terms-and-Conditions> and for electronic format documents, subject to Terms and Conditions for Electronic Documents at <http://www.sgs.com.tw/Terms-and-Conditions>. Attention is drawn to the limitation of liability, indemnification and jurisdiction issues defined therein. Any holder of this document is advised that information contained hereon reflects the Company's findings at the time of its intervention only and within the limits of Client's instructions, if any. The Company's sole responsibility is to its Client and this document does not exonerate parties to a transaction from exercising all their rights and obligations under the transaction documents. This document cannot be reproduced except in full, without prior written approval of the Company. Any unauthorized alteration, forgery or falsification of the content or appearance of this document is unlawful and offenders may be prosecuted to the fullest extent of the law.



Report Number	:E2/2020/B0037	Test Site	:966 Chamber D
Operation Mode	:802.11ac80 / Band 1	Test Date	:2020-12-25
Test Frequency	:5210 MHz	Temp./Humi.	:20.3/66
Test Mode	:TX CH LOW	Antenna Pol.	:Horizontal
EUT Pol	:H Plan	Engineer	:Kailin Lee

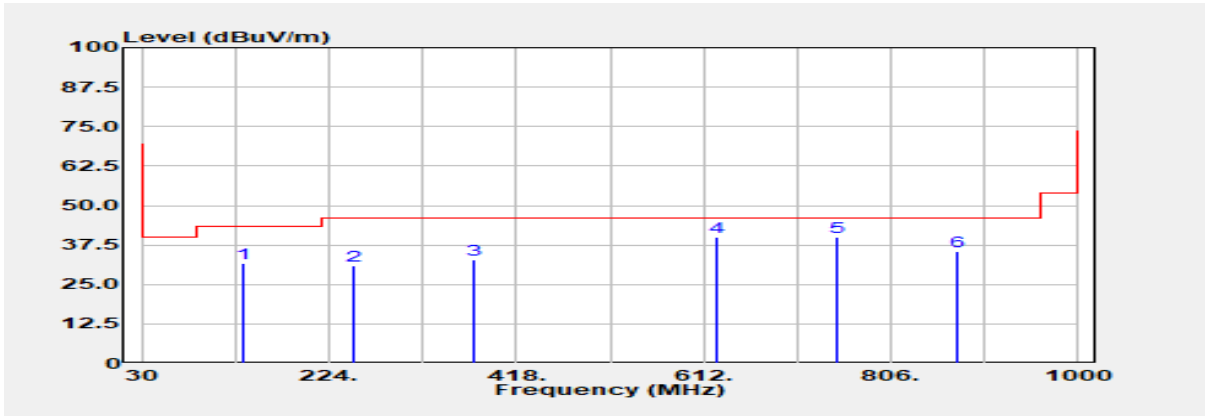

Freq. MHz	Detector Mode PK/QP/AV	Spectrum Reading Level dB $\mu$ V	Factor dB	Actual FS dB $\mu$ V/m	Limit @3m dB $\mu$ V/m	Margin dB
135.705	Peak	49.33	-17.77	31.55	43.50	-11.95
249.183	Peak	49.10	-18.14	30.96	46.00	-15.04
375.096	Peak	47.39	-14.52	32.87	46.00	-13.13
625.369	Peak	49.31	-9.21	40.09	46.00	-5.91
749.728	Peak	47.70	-7.66	40.04	46.00	-5.96
875.641	Peak	41.89	-6.25	35.64	46.00	-10.36

Unless otherwise stated the results shown in this test report refer only to the sample(s) tested and such sample(s) are retained for 90 days only.

除非另有說明，此報告結果僅對測試之樣品負責，同時此樣品僅保留90天。本報告未經本公司書面許可，不可部份複製。

This document is issued by the Company subject to its General Conditions of Service printed overleaf, available on request or accessible at <http://www.sgs.com.tw/Terms-and-Conditions> and for electronic format documents, subject to Terms and Conditions for Electronic Documents at <http://www.sgs.com.tw/Terms-and-Conditions>. Attention is drawn to the limitation of liability, indemnification and jurisdiction issues defined therein. Any holder of this document is advised that information contained hereon reflects the Company's findings at the time of its intervention only and within the limits of Client's instructions, if any. The Company's sole responsibility is to its Client and this document does not exonerate parties to a transaction from exercising all their rights and obligations under the transaction documents. This document cannot be reproduced except in full, without prior written approval of the Company. Any unauthorized alteration, forgery or falsification of the content or appearance of this document is unlawful and offenders may be prosecuted to the fullest extent of the law.

Report Number :E2/2020/B0037  
 Operation Mode :802.11ac80 / Band 4  
 Test Frequency :5775 MHz  
 Test Mode :TX CH MID  
 EUT Pol :H Plan

Test Site :966 Chamber D  
 Test Date :2020-12-25  
 Temp./Humi. :20.3/66  
 Antenna Pol. :Vertical  
 Engineer :Kailin Lee

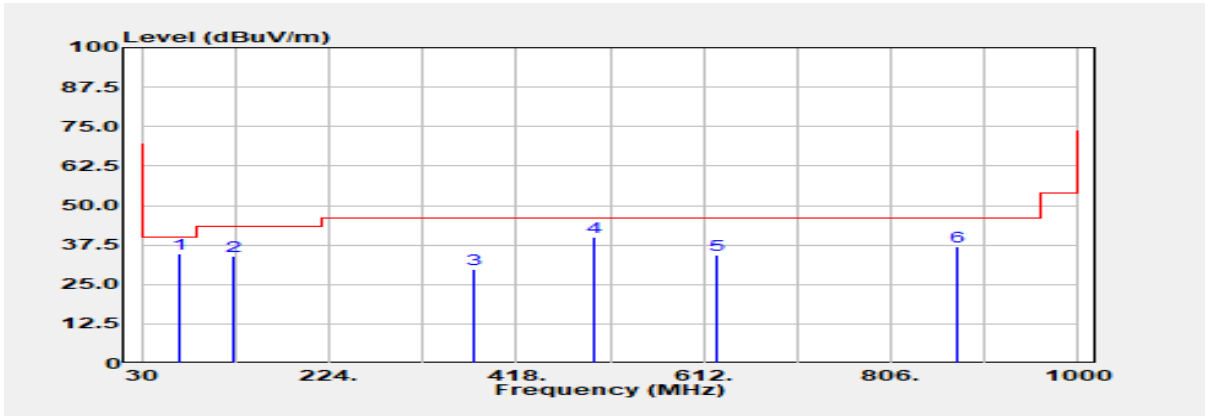

Freq. MHz	Detector Mode PK/QP/AV	Spectrum Reading Level dBuV	Factor dB	Actual FS dBuV/m	Limit @3m dBuV/m	Margin dB
68.862	Peak	53.51	-18.83	34.69	40.00	-5.31
124.824	Peak	52.90	-18.84	34.05	43.50	-9.45
375.096	Peak	44.16	-14.52	29.64	46.00	-16.36
499.455	Peak	52.20	-12.08	40.12	46.00	-5.88
625.369	Peak	43.70	-9.21	34.49	46.00	-11.51
875.641	Peak	43.41	-6.25	37.17	46.00	-8.83

Unless otherwise stated the results shown in this test report refer only to the sample(s) tested and such sample(s) are retained for 90 days only.

除非另有說明，此報告結果僅對測試之樣品負責，同時此樣品僅保留90天。本報告未經本公司書面許可，不可部份複製。

This document is issued by the Company subject to its General Conditions of Service printed overleaf, available on request or accessible at <http://www.sgs.com.tw/Terms-and-Conditions> and for electronic format documents, subject to Terms and Conditions for Electronic Documents at <http://www.sgs.com.tw/Terms-and-Conditions>. Attention is drawn to the limitation of liability, indemnification and jurisdiction issues defined therein. Any holder of this document is advised that information contained hereon reflects the Company's findings at the time of its intervention only and within the limits of Client's instructions, if any. The Company's sole responsibility is to its Client and this document does not exonerate parties to a transaction from exercising all their rights and obligations under the transaction documents. This document cannot be reproduced except in full, without prior written approval of the Company. Any unauthorized alteration, forgery or falsification of the content or appearance of this document is unlawful and offenders may be prosecuted to the fullest extent of the law.

Report Number	:E2/2020/B0037	Test Site	:966 Chamber D
Operation Mode	:802.11ac80 / Band 4	Test Date	:2020-12-25
Test Frequency	:5775 MHz	Temp./Humi.	:20.3/66
Test Mode	:TX CH MID	Antenna Pol.	:Horizontal
EUT Pol	:H Plan	Engineer	:Kailin Lee

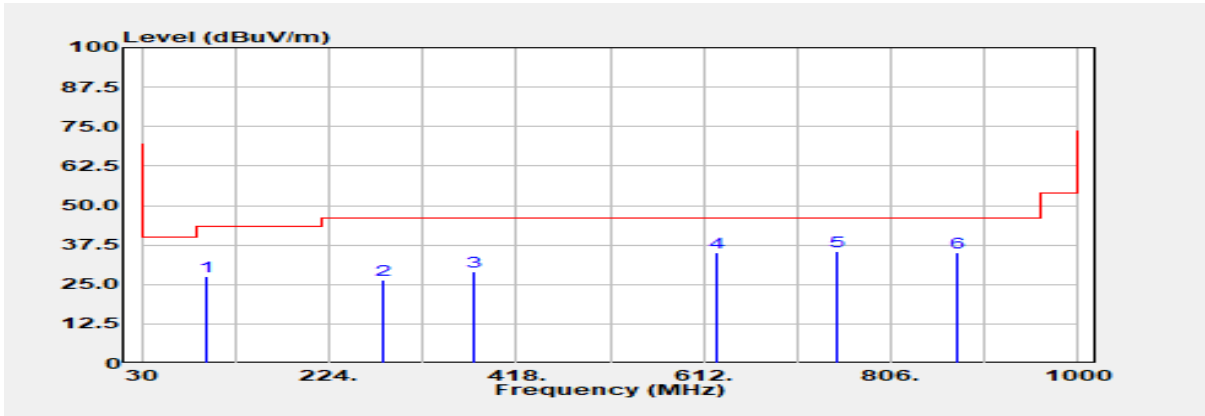

Freq. MHz	Detector Mode PK/QP/AV	Spectrum Reading Level dB $\mu$ V	Factor dB	Actual FS dB $\mu$ V/m	Limit @3m dB $\mu$ V/m	Margin dB
96.843	Peak	50.13	-22.52	27.61	43.50	-15.89
280.272	Peak	42.90	-16.46	26.45	46.00	-19.55
375.096	Peak	43.69	-14.52	29.17	46.00	-16.83
625.369	Peak	44.46	-9.21	35.25	46.00	-10.75
749.728	Peak	43.13	-7.66	35.47	46.00	-10.53
875.641	Peak	41.46	-6.25	35.21	46.00	-10.79

Unless otherwise stated the results shown in this test report refer only to the sample(s) tested and such sample(s) are retained for 90 days only.

除非另有說明，此報告結果僅對測試之樣品負責，同時此樣品僅保留90天。本報告未經本公司書面許可，不可部份複製。

This document is issued by the Company subject to its General Conditions of Service printed overleaf, available on request or accessible at <http://www.sgs.com.tw/Terms-and-Conditions> and for electronic format documents, subject to Terms and Conditions for Electronic Documents at <http://www.sgs.com.tw/Terms-and-Conditions>. Attention is drawn to the limitation of liability, indemnification and jurisdiction issues defined therein. Any holder of this document is advised that information contained hereon reflects the Company's findings at the time of its intervention only and within the limits of Client's instructions, if any. The Company's sole responsibility is to its Client and this document does not exonerate parties to a transaction from exercising all their rights and obligations under the transaction documents. This document cannot be reproduced except in full, without prior written approval of the Company. Any unauthorized alteration, forgery or falsification of the content or appearance of this document is unlawful and offenders may be prosecuted to the fullest extent of the law.

11.7.2 Above 1GHz Worst-Case Data:

Report Number	:E2/2020/B0037	Test Site	:966 Chamber D
Operation Mode	:802.11a / Band 1	Test Date	:2021-01-06
Test Frequency	:5180 MHz	Temp./Humi.	:21.3/61
Test Mode	:TX CH LOW	Antenna Pol.	:Vertical
EUT Pol	:H Plan	Engineer	:Kailin Lee

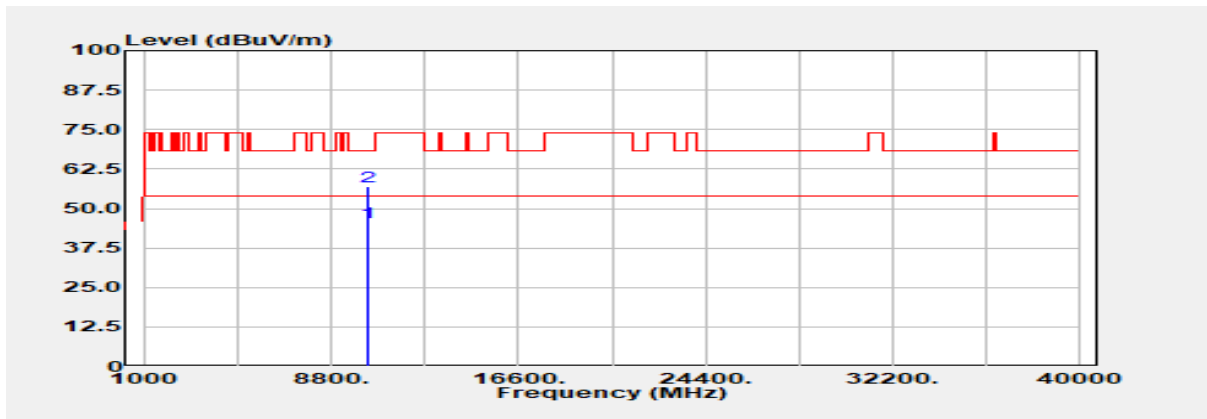

Freq. MHz	Detector Mode PK/QP/AV	Spectrum Reading Level dBμV	Factor dB	Actual FS dBμV/m	Limit @3m dBμV/m	Margin dB
10360.000	Average	37.69	7.86	45.54	54.00	-8.46
10360.000	Peak	48.94	7.86	56.80	68.20	-11.40

Unless otherwise stated the results shown in this test report refer only to the sample(s) tested and such sample(s) are retained for 90 days only.

除非另有說明，此報告結果僅對測試之樣品負責，同時此樣品僅保留90天。本報告未經本公司書面許可，不可部份複製。

This document is issued by the Company subject to its General Conditions of Service printed overleaf, available on request or accessible at <http://www.sgs.com.tw/Terms-and-Conditions> and for electronic format documents, subject to Terms and Conditions for Electronic Documents at <http://www.sgs.com.tw/Terms-and-Conditions>. Attention is drawn to the limitation of liability, indemnification and jurisdiction issues defined therein. Any holder of this document is advised that information contained hereon reflects the Company's findings at the time of its intervention only and within the limits of Client's instructions, if any. The Company's sole responsibility is to its Client and this document does not exonerate parties to a transaction from exercising all their rights and obligations under the transaction documents. This document cannot be reproduced except in full, without prior written approval of the Company. Any unauthorized alteration, forgery or falsification of the content or appearance of this document is unlawful and offenders may be prosecuted to the fullest extent of the law.

Report Number	:E2/2020/B0037	Test Site	:966 Chamber D
Operation Mode	:802.11a / Band 1	Test Date	:2021-01-06
Test Frequency	:5180 MHz	Temp./Humi.	:21.3/61
Test Mode	:TX CH LOW	Antenna Pol.	:Horizontal
EUT Pol	:H Plan	Engineer	:Kailin Lee

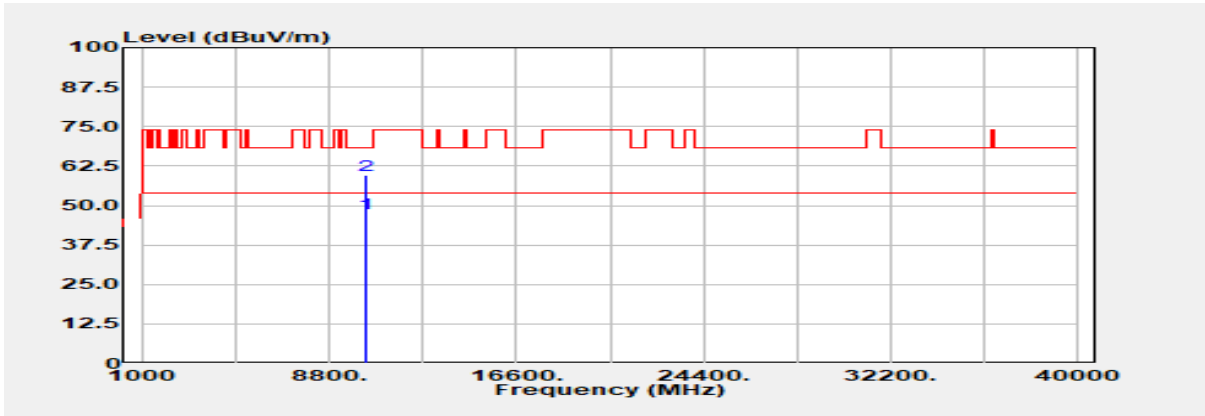

Freq. MHz	Detector Mode PK/QP/AV	Spectrum Reading Level dB $\mu$ V	Factor dB	Actual FS dB $\mu$ V/m	Limit @3m dB $\mu$ V/m	Margin dB
10360.000	Average	39.81	7.86	47.67	54.00	-6.33
10360.000	Peak	51.80	7.86	59.66	68.20	-8.54

Unless otherwise stated the results shown in this test report refer only to the sample(s) tested and such sample(s) are retained for 90 days only.

除非另有說明，此報告結果僅對測試之樣品負責，同時此樣品僅保留90天。本報告未經本公司書面許可，不可部份複製。

This document is issued by the Company subject to its General Conditions of Service printed overleaf, available on request or accessible at <http://www.sgs.com.tw/Terms-and-Conditions> and for electronic format documents, subject to Terms and Conditions for Electronic Documents at <http://www.sgs.com.tw/Terms-and-Conditions>. Attention is drawn to the limitation of liability, indemnification and jurisdiction issues defined therein. Any holder of this document is advised that information contained hereon reflects the Company's findings at the time of its intervention only and within the limits of Client's instructions, if any. The Company's sole responsibility is to its Client and this document does not exonerate parties to a transaction from exercising all their rights and obligations under the transaction documents. This document cannot be reproduced except in full, without prior written approval of the Company. Any unauthorized alteration, forgery or falsification of the content or appearance of this document is unlawful and offenders may be prosecuted to the fullest extent of the law.

Report Number :E2/2020/B0037  
 Operation Mode :802.11a / Band 1  
 Test Frequency :5220 MHz  
 Test Mode :TX CH MID  
 EUT Pol :H Plan

Test Site :966 Chamber D  
 Test Date :2021-01-06  
 Temp./Humi. :21.3/61  
 Antenna Pol. :Vertical  
 Engineer :Kailin Lee

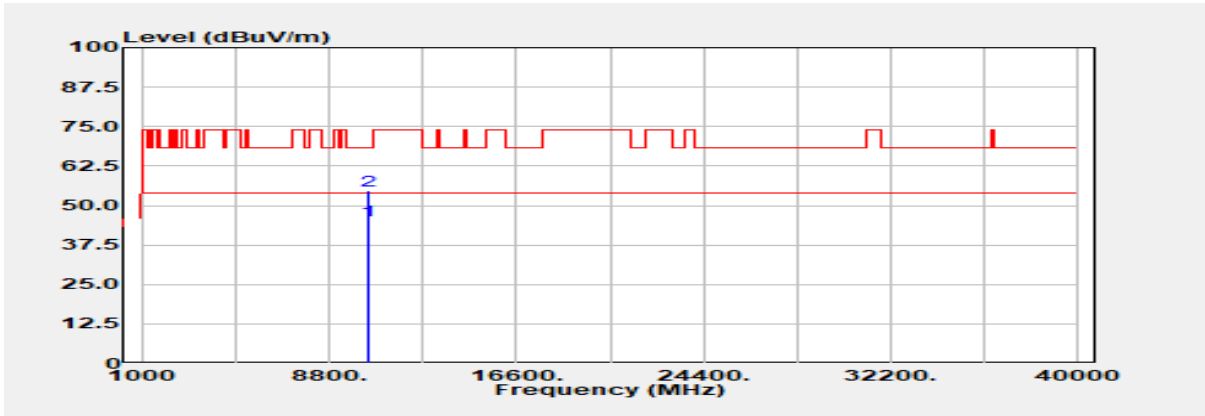

Freq. MHz	Detector Mode PK/QP/AV	Spectrum Reading Level dB $\mu$ V	Factor dB	Actual FS dB $\mu$ V/m	Limit @3m dB $\mu$ V/m	Margin dB
10440.000	Average	37.38	7.95	45.33	54.00	-8.67
10440.000	Peak	46.87	7.95	54.82	68.20	-13.38

Unless otherwise stated the results shown in this test report refer only to the sample(s) tested and such sample(s) are retained for 90 days only.

除非另有說明，此報告結果僅對測試之樣品負責，同時此樣品僅保留90天。本報告未經本公司書面許可，不可部份複製。

This document is issued by the Company subject to its General Conditions of Service printed overleaf, available on request or accessible at <http://www.sgs.com.tw/Terms-and-Conditions> and for electronic format documents, subject to Terms and Conditions for Electronic Documents at <http://www.sgs.com.tw/Terms-and-Conditions>. Attention is drawn to the limitation of liability, indemnification and jurisdiction issues defined therein. Any holder of this document is advised that information contained hereon reflects the Company's findings at the time of its intervention only and within the limits of Client's instructions, if any. The Company's sole responsibility is to its Client and this document does not exonerate parties to a transaction from exercising all their rights and obligations under the transaction documents. This document cannot be reproduced except in full, without prior written approval of the Company. Any unauthorized alteration, forgery or falsification of the content or appearance of this document is unlawful and offenders may be prosecuted to the fullest extent of the law.

Report Number :E2/2020/B0037  
 Operation Mode :802.11a / Band 1  
 Test Frequency :5220 MHz  
 Test Mode :TX CH MID  
 EUT Pol :H Plan

Test Site :966 Chamber D  
 Test Date :2021-01-06  
 Temp./Humi. :21.3/61  
 Antenna Pol. :Horizontal  
 Engineer :Kailin Lee

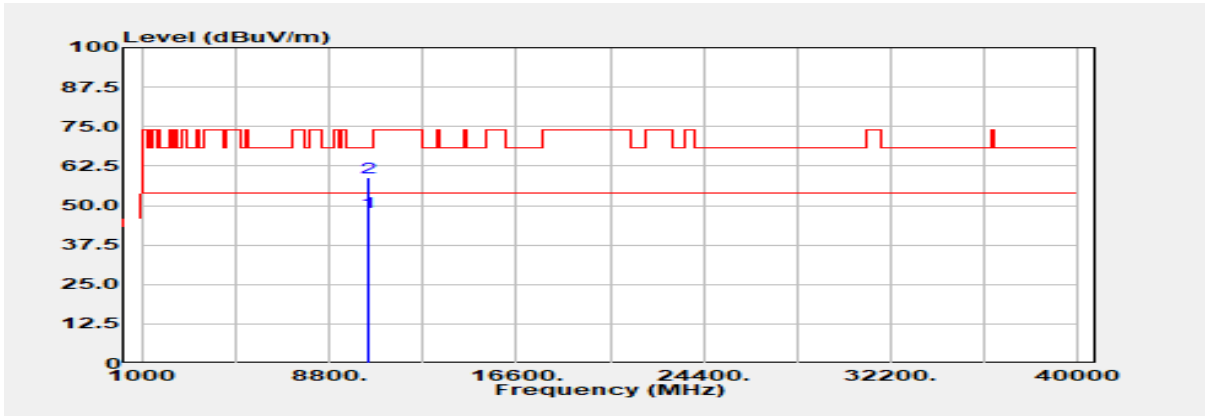

Freq. MHz	Detector Mode PK/QP/AV	Spectrum Reading Level dB $\mu$ V	Factor dB	Actual FS dB $\mu$ V/m	Limit @3m dB $\mu$ V/m	Margin dB
10440.000	Average	40.00	7.95	47.94	54.00	-6.06
10440.000	Peak	50.80	7.95	58.75	68.20	-9.45

Unless otherwise stated the results shown in this test report refer only to the sample(s) tested and such sample(s) are retained for 90 days only.

除非另有說明，此報告結果僅對測試之樣品負責，同時此樣品僅保留90天。本報告未經本公司書面許可，不可部份複製。

This document is issued by the Company subject to its General Conditions of Service printed overleaf, available on request or accessible at <http://www.sgs.com.tw/Terms-and-Conditions> and for electronic format documents, subject to Terms and Conditions for Electronic Documents at <http://www.sgs.com.tw/Terms-and-Conditions>. Attention is drawn to the limitation of liability, indemnification and jurisdiction issues defined therein. Any holder of this document is advised that information contained hereon reflects the Company's findings at the time of its intervention only and within the limits of Client's instructions, if any. The Company's sole responsibility is to its Client and this document does not exonerate parties to a transaction from exercising all their rights and obligations under the transaction documents. This document cannot be reproduced except in full, without prior written approval of the Company. Any unauthorized alteration, forgery or falsification of the content or appearance of this document is unlawful and offenders may be prosecuted to the fullest extent of the law.

Report Number	:E2/2020/B0037	Test Site	:966 Chamber D
Operation Mode	:802.11a / Band 1	Test Date	:2021-01-06
Test Frequency	:5240 MHz	Temp./Humi.	:21.3/61
Test Mode	:TX CH HIGH	Antenna Pol.	:Vertical
EUT Pol	:H Plan	Engineer	:Kailin Lee

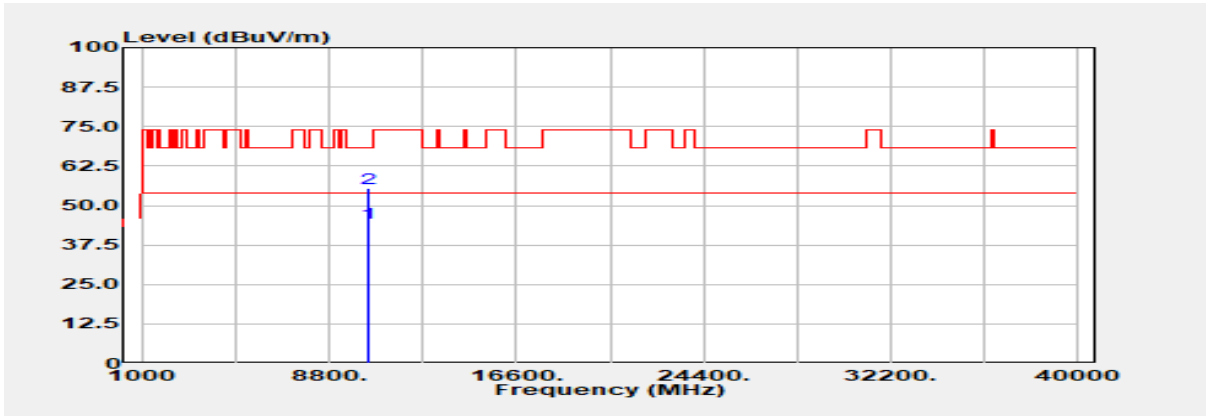

Freq. MHz	Detector Mode PK/QP/AV	Spectrum Reading Level dB $\mu$ V	Factor dB	Actual FS dB $\mu$ V/m	Limit @3m dB $\mu$ V/m	Margin dB
10480.000	Average	37.43	7.28	44.71	54.00	-9.29
10480.000	Peak	48.18	7.28	55.46	68.20	-12.74

Unless otherwise stated the results shown in this test report refer only to the sample(s) tested and such sample(s) are retained for 90 days only.

除非另有說明，此報告結果僅對測試之樣品負責，同時此樣品僅保留90天。本報告未經本公司書面許可，不可部份複製。

This document is issued by the Company subject to its General Conditions of Service printed overleaf, available on request or accessible at <http://www.sgs.com.tw/Terms-and-Conditions> and for electronic format documents, subject to Terms and Conditions for Electronic Documents at <http://www.sgs.com.tw/Terms-and-Conditions>. Attention is drawn to the limitation of liability, indemnification and jurisdiction issues defined therein. Any holder of this document is advised that information contained hereon reflects the Company's findings at the time of its intervention only and within the limits of Client's instructions, if any. The Company's sole responsibility is to its Client and this document does not exonerate parties to a transaction from exercising all their rights and obligations under the transaction documents. This document cannot be reproduced except in full, without prior written approval of the Company. Any unauthorized alteration, forgery or falsification of the content or appearance of this document is unlawful and offenders may be prosecuted to the fullest extent of the law.



Report Number	:E2/2020/B0037	Test Site	:966 Chamber D
Operation Mode	:802.11a / Band 1	Test Date	:2021-01-06
Test Frequency	:5240 MHz	Temp./Humi.	:21.3/61
Test Mode	:TX CH HIGH	Antenna Pol.	:Horizontal
EUT Pol	:H Plan	Engineer	:Kailin Lee

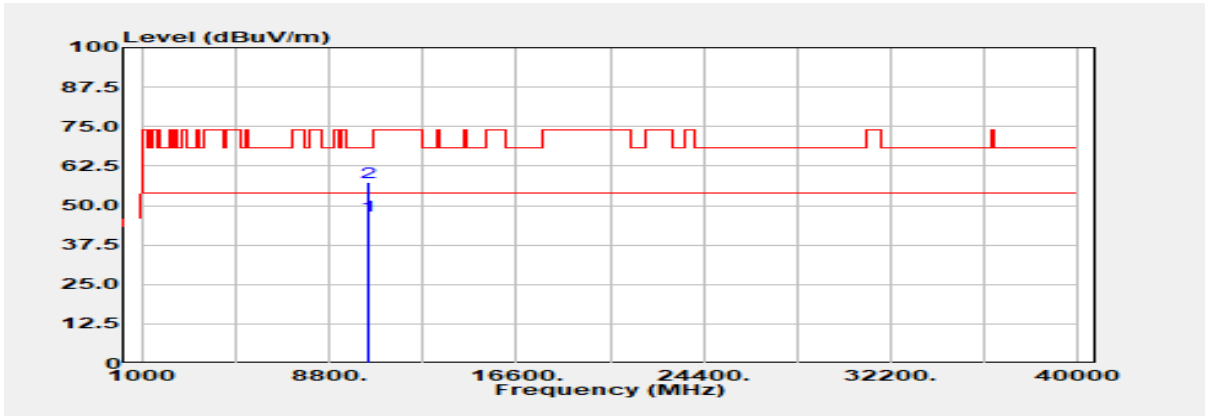

Freq. MHz	Detector Mode PK/QP/AV	Spectrum Reading Level dB $\mu$ V	Factor dB	Actual FS dB $\mu$ V/m	Limit @3m dB $\mu$ V/m	Margin dB
10480.000	Average	39.66	7.28	46.94	54.00	-7.06
10480.000	Peak	50.23	7.28	57.51	68.20	-10.69

Unless otherwise stated the results shown in this test report refer only to the sample(s) tested and such sample(s) are retained for 90 days only.

除非另有說明，此報告結果僅對測試之樣品負責，同時此樣品僅保留90天。本報告未經本公司書面許可，不可部份複製。

This document is issued by the Company subject to its General Conditions of Service printed overleaf, available on request or accessible at <http://www.sgs.com.tw/Terms-and-Conditions> and for electronic format documents, subject to Terms and Conditions for Electronic Documents at <http://www.sgs.com.tw/Terms-and-Conditions>. Attention is drawn to the limitation of liability, indemnification and jurisdiction issues defined therein. Any holder of this document is advised that information contained hereon reflects the Company's findings at the time of its intervention only and within the limits of Client's instructions, if any. The Company's sole responsibility is to its Client and this document does not exonerate parties to a transaction from exercising all their rights and obligations under the transaction documents. This document cannot be reproduced except in full, without prior written approval of the Company. Any unauthorized alteration, forgery or falsification of the content or appearance of this document is unlawful and offenders may be prosecuted to the fullest extent of the law.

Report Number	:E2/2020/B0037	Test Site	:966 Chamber D
Operation Mode	:802.11a / Band 4	Test Date	:2021-01-06
Test Frequency	:5745 MHz	Temp./Humi.	:21.3/61
Test Mode	:TX CH LOW	Antenna Pol.	:Vertical
EUT Pol	:H Plan	Engineer	:Kailin Lee

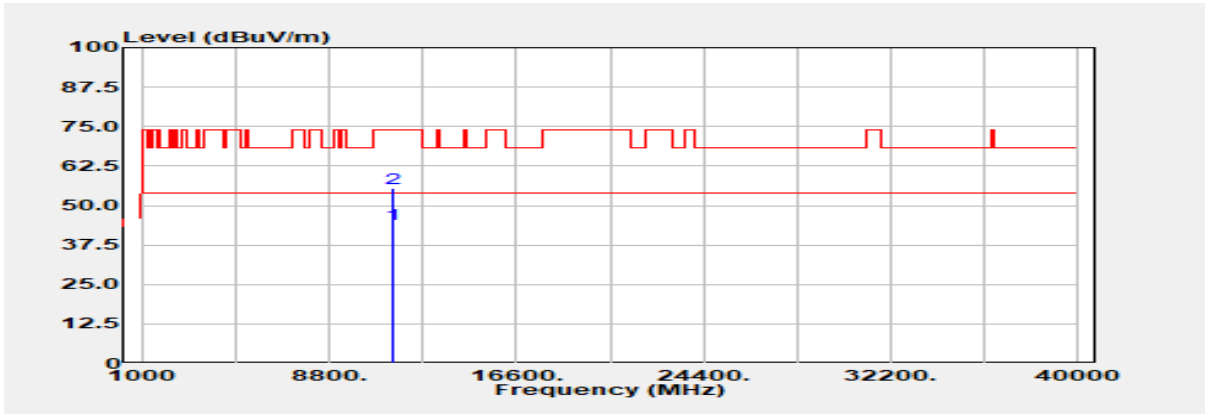

Freq. MHz	Detector Mode PK/QP/AV	Spectrum Reading Level dB $\mu$ V	Factor dB	Actual FS dB $\mu$ V/m	Limit @3m dB $\mu$ V/m	Margin dB
11490.000	Average	35.23	8.99	44.22	54.00	-9.78
11490.000	Peak	46.31	8.99	55.30	74.00	-18.70

Unless otherwise stated the results shown in this test report refer only to the sample(s) tested and such sample(s) are retained for 90 days only.

除非另有說明，此報告結果僅對測試之樣品負責，同時此樣品僅保留90天。本報告未經本公司書面許可，不可部份複製。

This document is issued by the Company subject to its General Conditions of Service printed overleaf, available on request or accessible at <http://www.sgs.com.tw/Terms-and-Conditions> and for electronic format documents, subject to Terms and Conditions for Electronic Documents at <http://www.sgs.com.tw/Terms-and-Conditions>. Attention is drawn to the limitation of liability, indemnification and jurisdiction issues defined therein. Any holder of this document is advised that information contained hereon reflects the Company's findings at the time of its intervention only and within the limits of Client's instructions, if any. The Company's sole responsibility is to its Client and this document does not exonerate parties to a transaction from exercising all their rights and obligations under the transaction documents. This document cannot be reproduced except in full, without prior written approval of the Company. Any unauthorized alteration, forgery or falsification of the content or appearance of this document is unlawful and offenders may be prosecuted to the fullest extent of the law.

Report Number	:E2/2020/B0037	Test Site	:966 Chamber D
Operation Mode	:802.11a / Band 4	Test Date	:2021-01-06
Test Frequency	:5745 MHz	Temp./Humi.	:21.3/61
Test Mode	:TX CH LOW	Antenna Pol.	:Horizontal
EUT Pol	:H Plan	Engineer	:Kailin Lee

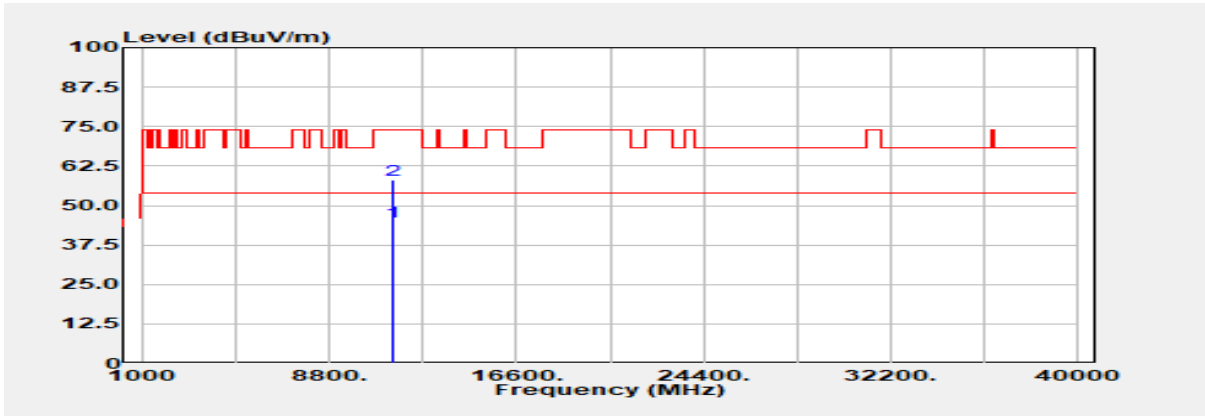

Freq. MHz	Detector Mode PK/QP/AV	Spectrum Reading Level dB $\mu$ V	Factor dB	Actual FS dB $\mu$ V/m	Limit @3m dB $\mu$ V/m	Margin dB
11490.000	Average	35.95	8.99	44.94	54.00	-9.06
11490.000	Peak	49.09	8.99	58.07	74.00	-15.93

Unless otherwise stated the results shown in this test report refer only to the sample(s) tested and such sample(s) are retained for 90 days only.

除非另有說明，此報告結果僅對測試之樣品負責，同時此樣品僅保留90天。本報告未經本公司書面許可，不可部份複製。

This document is issued by the Company subject to its General Conditions of Service printed overleaf, available on request or accessible at <http://www.sgs.com.tw/Terms-and-Conditions> and for electronic format documents, subject to Terms and Conditions for Electronic Documents at <http://www.sgs.com.tw/Terms-and-Conditions>. Attention is drawn to the limitation of liability, indemnification and jurisdiction issues defined therein. Any holder of this document is advised that information contained hereon reflects the Company's findings at the time of its intervention only and within the limits of Client's instructions, if any. The Company's sole responsibility is to its Client and this document does not exonerate parties to a transaction from exercising all their rights and obligations under the transaction documents. This document cannot be reproduced except in full, without prior written approval of the Company. Any unauthorized alteration, forgery or falsification of the content or appearance of this document is unlawful and offenders may be prosecuted to the fullest extent of the law.

Report Number	:E2/2020/B0037	Test Site	:966 Chamber D
Operation Mode	:802.11a / Band 4	Test Date	:2021-01-06
Test Frequency	:5785 MHz	Temp./Humi.	:21.3/61
Test Mode	:TX CH MID	Antenna Pol.	:Vertical
EUT Pol	:H Plan	Engineer	:Kailin Lee

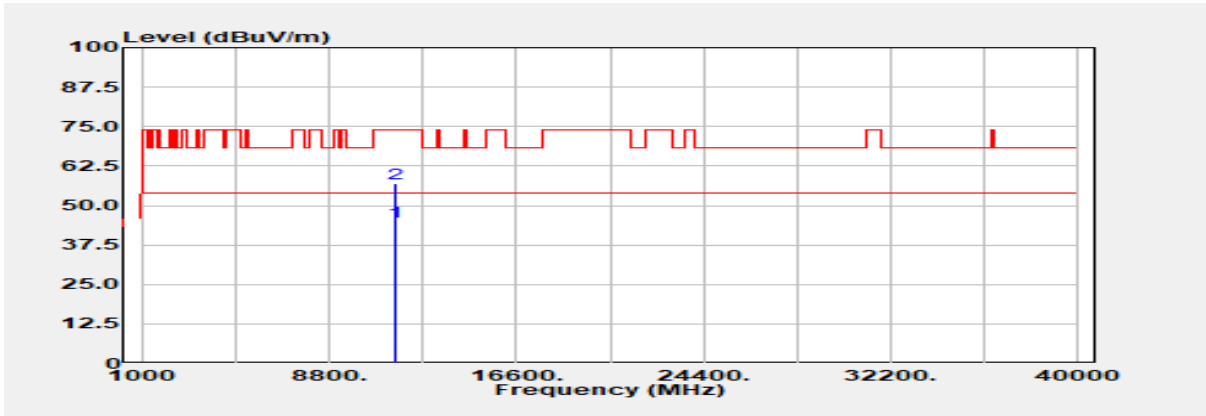

Freq. MHz	Detector Mode PK/QP/AV	Spectrum Reading Level dBuV	Factor dB	Actual FS dBuV/m	Limit @3m dBuV/m	Margin dB
11570.000	Average	36.25	8.65	44.90	54.00	-9.10
11570.000	Peak	48.22	8.65	56.87	74.00	-17.13

Unless otherwise stated the results shown in this test report refer only to the sample(s) tested and such sample(s) are retained for 90 days only.

除非另有說明，此報告結果僅對測試之樣品負責，同時此樣品僅保留90天。本報告未經本公司書面許可，不可部份複製。

This document is issued by the Company subject to its General Conditions of Service printed overleaf, available on request or accessible at <http://www.sgs.com.tw/Terms-and-Conditions> and for electronic format documents, subject to Terms and Conditions for Electronic Documents at <http://www.sgs.com.tw/Terms-and-Conditions>. Attention is drawn to the limitation of liability, indemnification and jurisdiction issues defined therein. Any holder of this document is advised that information contained hereon reflects the Company's findings at the time of its intervention only and within the limits of Client's instructions, if any. The Company's sole responsibility is to its Client and this document does not exonerate parties to a transaction from exercising all their rights and obligations under the transaction documents. This document cannot be reproduced except in full, without prior written approval of the Company. Any unauthorized alteration, forgery or falsification of the content or appearance of this document is unlawful and offenders may be prosecuted to the fullest extent of the law.

Report Number :E2/2020/B0037  
 Operation Mode :802.11a / Band 4  
 Test Frequency :5785 MHz  
 Test Mode :TX CH MID  
 EUT Pol :H Plan

Test Site :966 Chamber D  
 Test Date :2021-01-06  
 Temp./Humi. :21.3/61  
 Antenna Pol. :Horizontal  
 Engineer :Kailin Lee

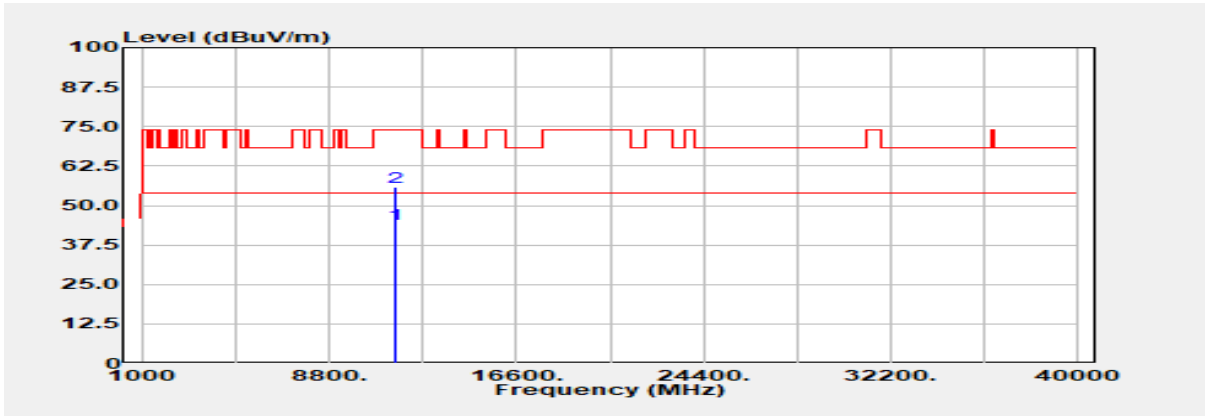

Freq. MHz	Detector Mode PK/QP/AV	Spectrum Reading Level dBuV	Factor dB	Actual FS dBuV/m	Limit @3m dBuV/m	Margin dB
11570.000	Average	35.39	8.65	44.04	54.00	-9.96
11570.000	Peak	47.19	8.65	55.84	74.00	-18.16

Unless otherwise stated the results shown in this test report refer only to the sample(s) tested and such sample(s) are retained for 90 days only.

除非另有說明，此報告結果僅對測試之樣品負責，同時此樣品僅保留90天。本報告未經本公司書面許可，不可部份複製。

This document is issued by the Company subject to its General Conditions of Service printed overleaf, available on request or accessible at <http://www.sgs.com.tw/Terms-and-Conditions> and for electronic format documents, subject to Terms and Conditions for Electronic Documents at <http://www.sgs.com.tw/Terms-and-Conditions>. Attention is drawn to the limitation of liability, indemnification and jurisdiction issues defined therein. Any holder of this document is advised that information contained hereon reflects the Company's findings at the time of its intervention only and within the limits of Client's instructions, if any. The Company's sole responsibility is to its Client and this document does not exonerate parties to a transaction from exercising all their rights and obligations under the transaction documents. This document cannot be reproduced except in full, without prior written approval of the Company. Any unauthorized alteration, forgery or falsification of the content or appearance of this document is unlawful and offenders may be prosecuted to the fullest extent of the law.

Report Number :E2/2020/B0037  
 Operation Mode :802.11a / Band 4  
 Test Frequency :5825 MHz  
 Test Mode :TX CH HIGH  
 EUT Pol :H Plan

Test Site :966 Chamber D  
 Test Date :2021-01-06  
 Temp./Humi. :21.3/61  
 Antenna Pol. :Vertical  
 Engineer :Kailin Lee

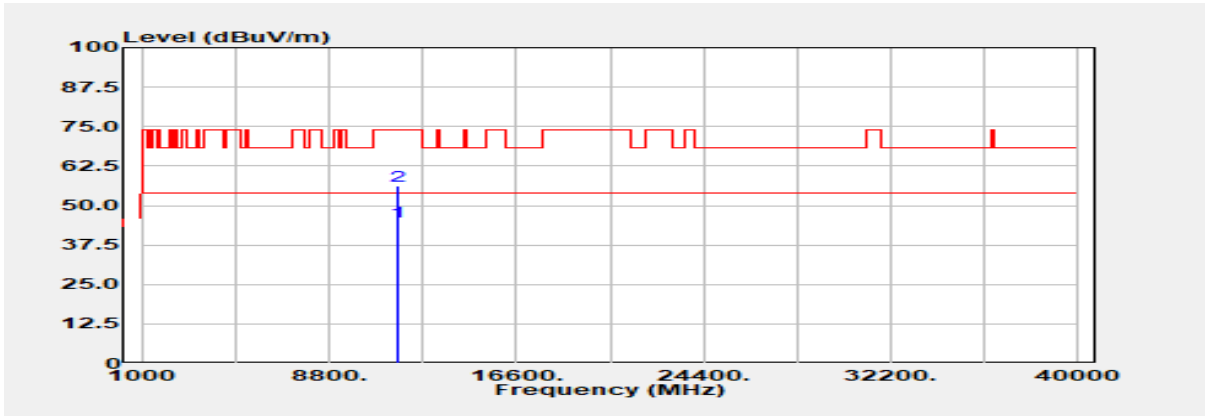

Freq. MHz	Detector Mode PK/QP/AV	Spectrum Reading Level dB $\mu$ V	Factor dB	Actual FS dB $\mu$ V/m	Limit @3m dB $\mu$ V/m	Margin dB
11650.000	Average	36.98	8.07	45.05	54.00	-8.95
11650.000	Peak	48.21	8.07	56.28	74.00	-17.72

Unless otherwise stated the results shown in this test report refer only to the sample(s) tested and such sample(s) are retained for 90 days only.

除非另有說明，此報告結果僅對測試之樣品負責，同時此樣品僅保留90天。本報告未經本公司書面許可，不可部份複製。

This document is issued by the Company subject to its General Conditions of Service printed overleaf, available on request or accessible at <http://www.sgs.com.tw/Terms-and-Conditions> and for electronic format documents, subject to Terms and Conditions for Electronic Documents at <http://www.sgs.com.tw/Terms-and-Conditions>. Attention is drawn to the limitation of liability, indemnification and jurisdiction issues defined therein. Any holder of this document is advised that information contained hereon reflects the Company's findings at the time of its intervention only and within the limits of Client's instructions, if any. The Company's sole responsibility is to its Client and this document does not exonerate parties to a transaction from exercising all their rights and obligations under the transaction documents. This document cannot be reproduced except in full, without prior written approval of the Company. Any unauthorized alteration, forgery or falsification of the content or appearance of this document is unlawful and offenders may be prosecuted to the fullest extent of the law.

Report Number :E2/2020/B0037  
 Operation Mode :802.11a / Band 4  
 Test Frequency :5825 MHz  
 Test Mode :TX CH HIGH  
 EUT Pol :H Plan

Test Site :966 Chamber D  
 Test Date :2021-01-06  
 Temp./Humi. :21.3/61  
 Antenna Pol. :Horizontal  
 Engineer :Kailin Lee

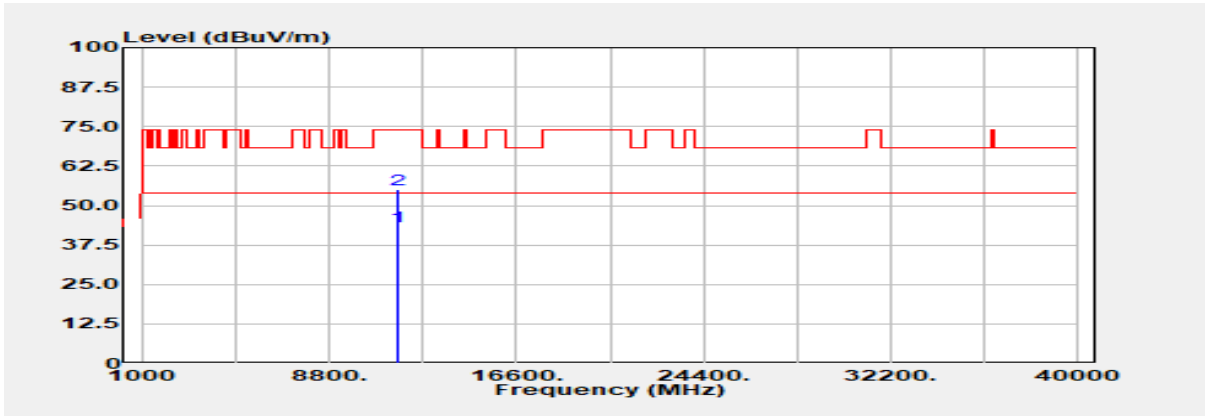

Freq. MHz	Detector Mode PK/QP/AV	Spectrum Reading Level dB $\mu$ V	Factor dB	Actual FS dB $\mu$ V/m	Limit @3m dB $\mu$ V/m	Margin dB
11650.000	Average	35.22	8.07	43.29	54.00	-10.71
11650.000	Peak	46.84	8.07	54.91	74.00	-19.09

Unless otherwise stated the results shown in this test report refer only to the sample(s) tested and such sample(s) are retained for 90 days only.

除非另有說明，此報告結果僅對測試之樣品負責，同時此樣品僅保留90天。本報告未經本公司書面許可，不可部份複製。

This document is issued by the Company subject to its General Conditions of Service printed overleaf, available on request or accessible at <http://www.sgs.com.tw/Terms-and-Conditions> and for electronic format documents, subject to Terms and Conditions for Electronic Documents at <http://www.sgs.com.tw/Terms-and-Conditions>. Attention is drawn to the limitation of liability, indemnification and jurisdiction issues defined therein. Any holder of this document is advised that information contained hereon reflects the Company's findings at the time of its intervention only and within the limits of Client's instructions, if any. The Company's sole responsibility is to its Client and this document does not exonerate parties to a transaction from exercising all their rights and obligations under the transaction documents. This document cannot be reproduced except in full, without prior written approval of the Company. Any unauthorized alteration, forgery or falsification of the content or appearance of this document is unlawful and offenders may be prosecuted to the fullest extent of the law.

Report Number	:E2/2020/B0037	Test Site	:966 Chamber D
Operation Mode	:802.11n20 / Band 1	Test Date	:2021-01-06
Test Frequency	:5180 MHz	Temp./Humi.	:22.5/70
Test Mode	:TX CH LOW	Antenna Pol.	:Vertical
EUT Pol	:H Plan	Engineer	:Kailin Lee

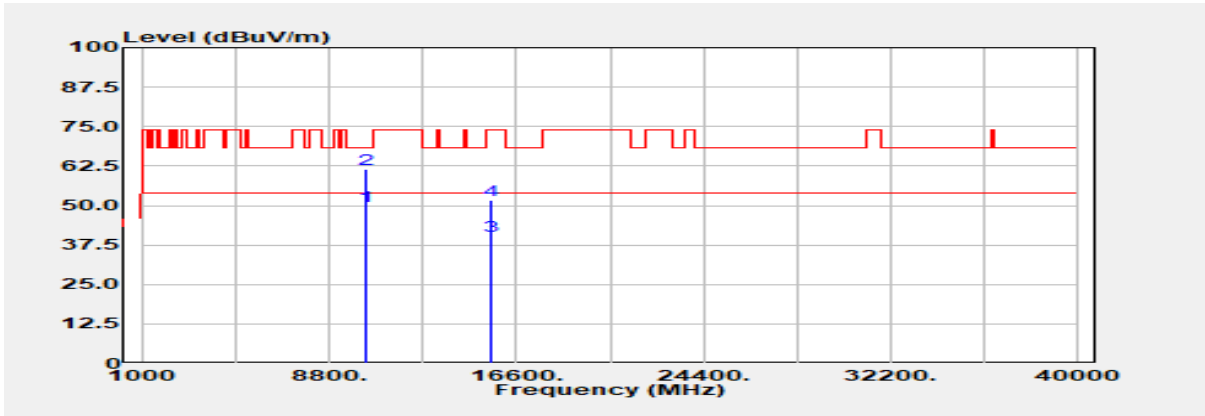

Freq. MHz	Detector Mode PK/QP/AV	Spectrum Reading Level dB $\mu$ V	Factor dB	Actual FS dB $\mu$ V/m	Limit @3m dB $\mu$ V/m	Margin dB
10360.000	Average	41.79	7.86	49.65	54.00	-4.35
10360.000	Peak	53.80	7.86	61.66	68.20	-6.54
15540.000	Average	33.78	6.42	40.20	54.00	-13.80
15540.000	Peak	45.43	6.42	51.85	74.00	-22.15

Unless otherwise stated the results shown in this test report refer only to the sample(s) tested and such sample(s) are retained for 90 days only.

除非另有說明，此報告結果僅對測試之樣品負責，同時此樣品僅保留90天。本報告未經本公司書面許可，不可部份複製。

This document is issued by the Company subject to its General Conditions of Service printed overleaf, available on request or accessible at <http://www.sgs.com.tw/Terms-and-Conditions> and for electronic format documents, subject to Terms and Conditions for Electronic Documents at <http://www.sgs.com.tw/Terms-and-Conditions>. Attention is drawn to the limitation of liability, indemnification and jurisdiction issues defined therein. Any holder of this document is advised that information contained hereon reflects the Company's findings at the time of its intervention only and within the limits of Client's instructions, if any. The Company's sole responsibility is to its Client and this document does not exonerate parties to a transaction from exercising all their rights and obligations under the transaction documents. This document cannot be reproduced except in full, without prior written approval of the Company. Any unauthorized alteration, forgery or falsification of the content or appearance of this document is unlawful and offenders may be prosecuted to the fullest extent of the law.



Report Number	:E2/2020/B0037	Test Site	:966 Chamber D
Operation Mode	:802.11n20 / Band 1	Test Date	:2021-01-06
Test Frequency	:5180 MHz	Temp./Humi.	:22.5/70
Test Mode	:TX CH LOW	Antenna Pol.	:Horizontal
EUT Pol	:H Plan	Engineer	:Kailin Lee

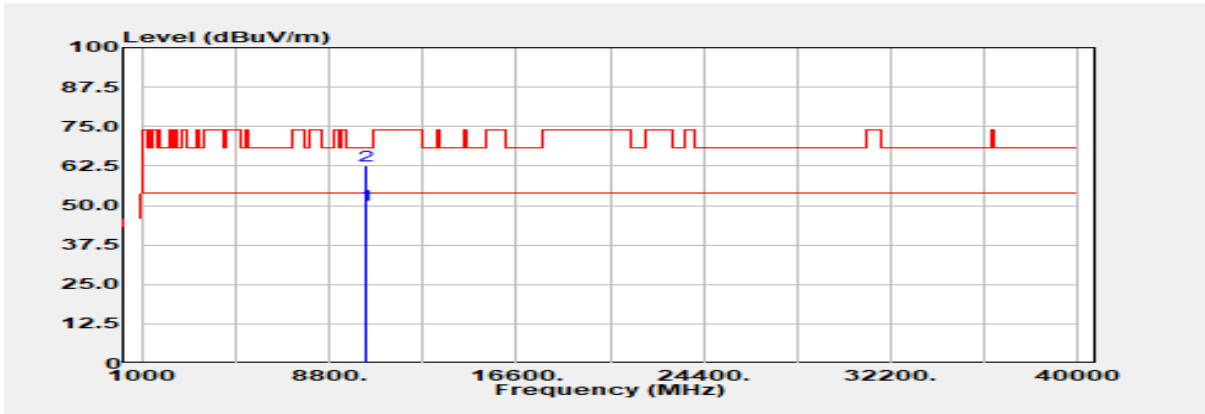

Freq. MHz	Detector Mode PK/QP/AV	Spectrum Reading Level dB $\mu$ V	Factor dB	Actual FS dB $\mu$ V/m	Limit @3m dB $\mu$ V/m	Margin dB
10360.000	Average	42.46	7.86	50.32	54.00	-3.68
10360.000	Peak	54.63	7.86	62.49	68.20	-5.71

Unless otherwise stated the results shown in this test report refer only to the sample(s) tested and such sample(s) are retained for 90 days only.

除非另有說明，此報告結果僅對測試之樣品負責，同時此樣品僅保留90天。本報告未經本公司書面許可，不可部份複製。

This document is issued by the Company subject to its General Conditions of Service printed overleaf, available on request or accessible at <http://www.sgs.com.tw/Terms-and-Conditions> and for electronic format documents, subject to Terms and Conditions for Electronic Documents at <http://www.sgs.com.tw/Terms-and-Conditions>. Attention is drawn to the limitation of liability, indemnification and jurisdiction issues defined therein. Any holder of this document is advised that information contained hereon reflects the Company's findings at the time of its intervention only and within the limits of Client's instructions, if any. The Company's sole responsibility is to its Client and this document does not exonerate parties to a transaction from exercising all their rights and obligations under the transaction documents. This document cannot be reproduced except in full, without prior written approval of the Company. Any unauthorized alteration, forgery or falsification of the content or appearance of this document is unlawful and offenders may be prosecuted to the fullest extent of the law.

Report Number	:E2/2020/B0037	Test Site	:966 Chamber D
Operation Mode	:802.11n20 / Band 1	Test Date	:2021-01-06
Test Frequency	:5220 MHz	Temp./Humi.	:22.5/70
Test Mode	:TX CH MID	Antenna Pol.	:Vertical
EUT Pol	:H Plan	Engineer	:Kailin Lee

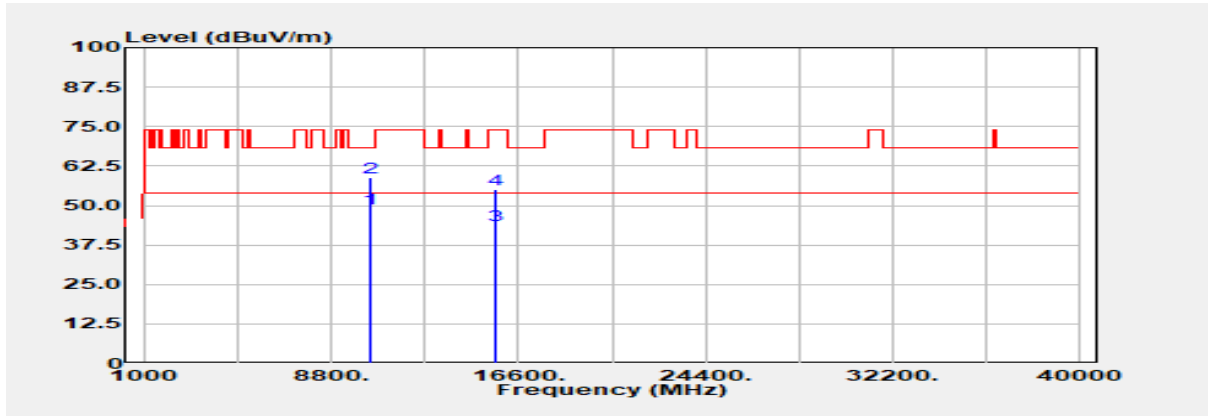

Freq. MHz	Detector Mode PK/QP/AV	Spectrum Reading Level dB $\mu$ V	Factor dB	Actual FS dB $\mu$ V/m	Limit @3m dB $\mu$ V/m	Margin dB
10440.000	Average	40.95	7.95	48.89	54.00	-5.11
10440.000	Peak	51.03	7.95	58.98	68.20	-9.22
15660.000	Average	37.45	6.36	43.81	54.00	-10.19
15660.000	Peak	48.68	6.36	55.04	74.00	-18.96

Unless otherwise stated the results shown in this test report refer only to the sample(s) tested and such sample(s) are retained for 90 days only.

除非另有說明，此報告結果僅對測試之樣品負責，同時此樣品僅保留90天。本報告未經本公司書面許可，不可部份複製。

This document is issued by the Company subject to its General Conditions of Service printed overleaf, available on request or accessible at <http://www.sgs.com.tw/Terms-and-Conditions> and for electronic format documents, subject to Terms and Conditions for Electronic Documents at <http://www.sgs.com.tw/Terms-and-Conditions>. Attention is drawn to the limitation of liability, indemnification and jurisdiction issues defined therein. Any holder of this document is advised that information contained hereon reflects the Company's findings at the time of its intervention only and within the limits of Client's instructions, if any. The Company's sole responsibility is to its Client and this document does not exonerate parties to a transaction from exercising all their rights and obligations under the transaction documents. This document cannot be reproduced except in full, without prior written approval of the Company. Any unauthorized alteration, forgery or falsification of the content or appearance of this document is unlawful and offenders may be prosecuted to the fullest extent of the law.

Report Number	:E2/2020/B0037	Test Site	:966 Chamber D
Operation Mode	:802.11n20 / Band 1	Test Date	:2021-01-06
Test Frequency	:5220 MHz	Temp./Humi.	:22.5/70
Test Mode	:TX CH MID	Antenna Pol.	:Horizontal
EUT Pol	:H Plan	Engineer	:Kailin Lee

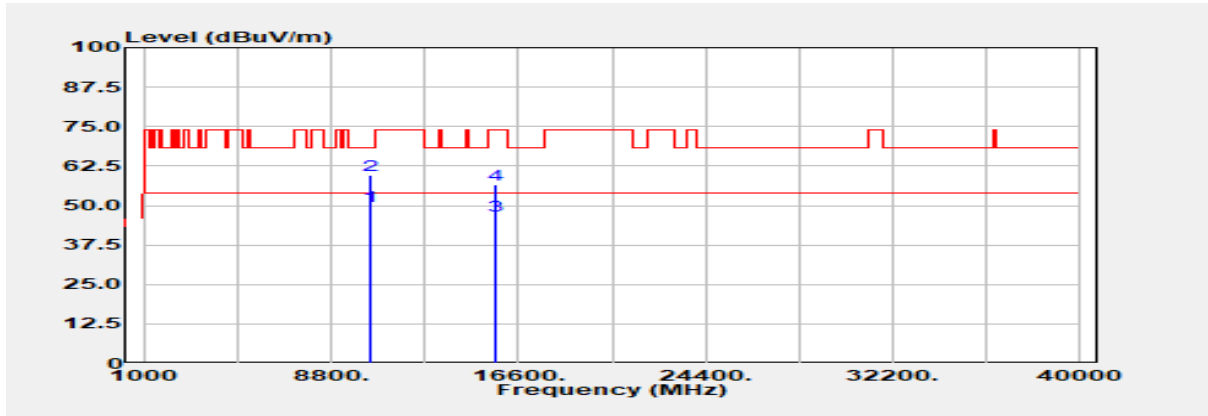

Freq. MHz	Detector Mode PK/QP/AV	Spectrum Reading Level dBuV	Factor dB	Actual FS dBuV/m	Limit @3m dBuV/m	Margin dB
10440.000	Average	41.76	7.95	49.71	54.00	-4.29
10440.000	Peak	51.84	7.95	59.79	68.20	-8.41
15660.000	Average	40.61	6.36	46.97	54.00	-7.03
15660.000	Peak	50.43	6.36	56.79	74.00	-17.21

Unless otherwise stated the results shown in this test report refer only to the sample(s) tested and such sample(s) are retained for 90 days only.

除非另有說明，此報告結果僅對測試之樣品負責，同時此樣品僅保留90天。本報告未經本公司書面許可，不可部份複製。

This document is issued by the Company subject to its General Conditions of Service printed overleaf, available on request or accessible at <http://www.sgs.com.tw/Terms-and-Conditions> and for electronic format documents, subject to Terms and Conditions for Electronic Documents at <http://www.sgs.com.tw/Terms-and-Conditions>. Attention is drawn to the limitation of liability, indemnification and jurisdiction issues defined therein. Any holder of this document is advised that information contained hereon reflects the Company's findings at the time of its intervention only and within the limits of Client's instructions, if any. The Company's sole responsibility is to its Client and this document does not exonerate parties to a transaction from exercising all their rights and obligations under the transaction documents. This document cannot be reproduced except in full, without prior written approval of the Company. Any unauthorized alteration, forgery or falsification of the content or appearance of this document is unlawful and offenders may be prosecuted to the fullest extent of the law.

Report Number	:E2/2020/B0037	Test Site	:966 Chamber D
Operation Mode	:802.11n20 / Band 1	Test Date	:2021-01-06
Test Frequency	:5240 MHz	Temp./Humi.	:21.3/61
Test Mode	:TX CH HIGH	Antenna Pol.	:Vertical
EUT Pol	:H Plan	Engineer	:Kailin Lee

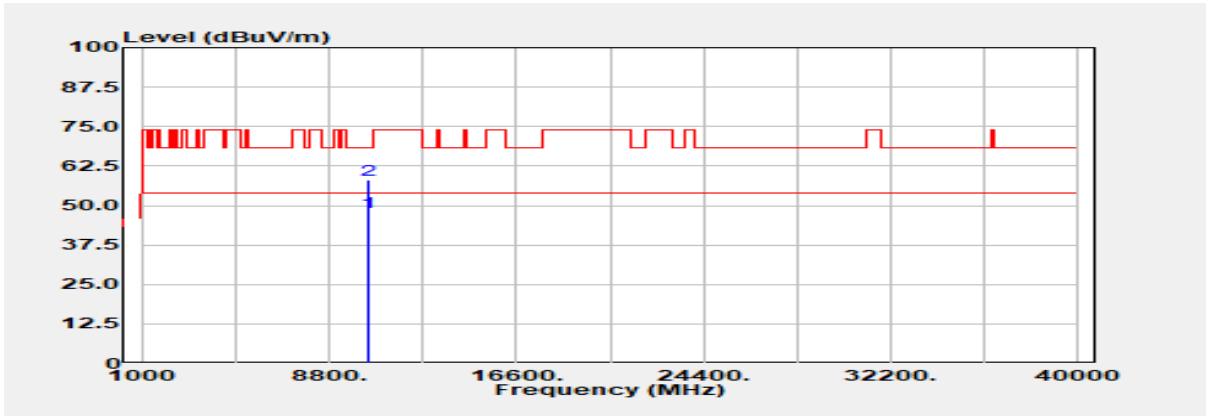

Freq. MHz	Detector Mode PK/QP/AV	Spectrum Reading Level dB $\mu$ V	Factor dB	Actual FS dB $\mu$ V/m	Limit @3m dB $\mu$ V/m	Margin dB
10480.000	Average	40.53	7.28	47.80	54.00	-6.20
10480.000	Peak	50.78	7.28	58.06	68.20	-10.14

Unless otherwise stated the results shown in this test report refer only to the sample(s) tested and such sample(s) are retained for 90 days only.

除非另有說明，此報告結果僅對測試之樣品負責，同時此樣品僅保留90天。本報告未經本公司書面許可，不可部份複製。

This document is issued by the Company subject to its General Conditions of Service printed overleaf, available on request or accessible at <http://www.sgs.com.tw/Terms-and-Conditions> and for electronic format documents, subject to Terms and Conditions for Electronic Documents at <http://www.sgs.com.tw/Terms-and-Conditions>. Attention is drawn to the limitation of liability, indemnification and jurisdiction issues defined therein. Any holder of this document is advised that information contained hereon reflects the Company's findings at the time of its intervention only and within the limits of Client's instructions, if any. The Company's sole responsibility is to its Client and this document does not exonerate parties to a transaction from exercising all their rights and obligations under the transaction documents. This document cannot be reproduced except in full, without prior written approval of the Company. Any unauthorized alteration, forgery or falsification of the content or appearance of this document is unlawful and offenders may be prosecuted to the fullest extent of the law.

Report Number	:E2/2020/B0037	Test Site	:966 Chamber D
Operation Mode	:802.11n20 / Band 1	Test Date	:2021-01-06
Test Frequency	:5240 MHz	Temp./Humi.	:21.3/61
Test Mode	:TX CH HIGH	Antenna Pol.	:Horizontal
EUT Pol	:H Plan	Engineer	:Kailin Lee

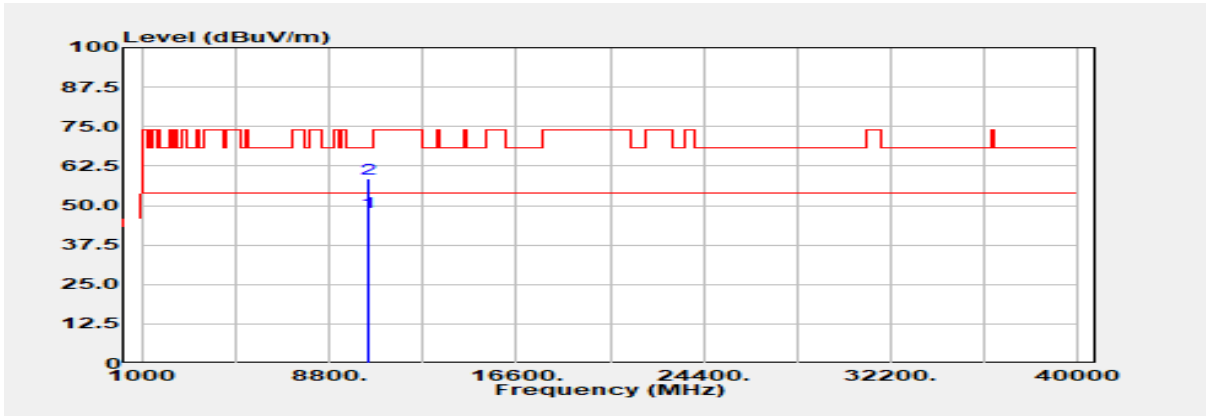

Freq. MHz	Detector Mode PK/QP/AV	Spectrum Reading Level dB $\mu$ V	Factor dB	Actual FS dB $\mu$ V/m	Limit @3m dB $\mu$ V/m	Margin dB
10480.000	Average	40.72	7.28	48.00	54.00	-6.00
10480.000	Peak	51.04	7.28	58.32	68.20	-9.88

Unless otherwise stated the results shown in this test report refer only to the sample(s) tested and such sample(s) are retained for 90 days only.

除非另有說明，此報告結果僅對測試之樣品負責，同時此樣品僅保留90天。本報告未經本公司書面許可，不可部份複製。

This document is issued by the Company subject to its General Conditions of Service printed overleaf, available on request or accessible at <http://www.sgs.com.tw/Terms-and-Conditions> and for electronic format documents, subject to Terms and Conditions for Electronic Documents at <http://www.sgs.com.tw/Terms-and-Conditions>. Attention is drawn to the limitation of liability, indemnification and jurisdiction issues defined therein. Any holder of this document is advised that information contained hereon reflects the Company's findings at the time of its intervention only and within the limits of Client's instructions, if any. The Company's sole responsibility is to its Client and this document does not exonerate parties to a transaction from exercising all their rights and obligations under the transaction documents. This document cannot be reproduced except in full, without prior written approval of the Company. Any unauthorized alteration, forgery or falsification of the content or appearance of this document is unlawful and offenders may be prosecuted to the fullest extent of the law.

Report Number	:E2/2020/B0037	Test Site	:966 Chamber D
Operation Mode	:802.11n20 / Band 4	Test Date	:2021-01-07
Test Frequency	:5745 MHz	Temp./Humi.	:21.3/61
Test Mode	:TX CH LOW	Antenna Pol.	:Vertical
EUT Pol	:H Plan	Engineer	:Kailin Lee

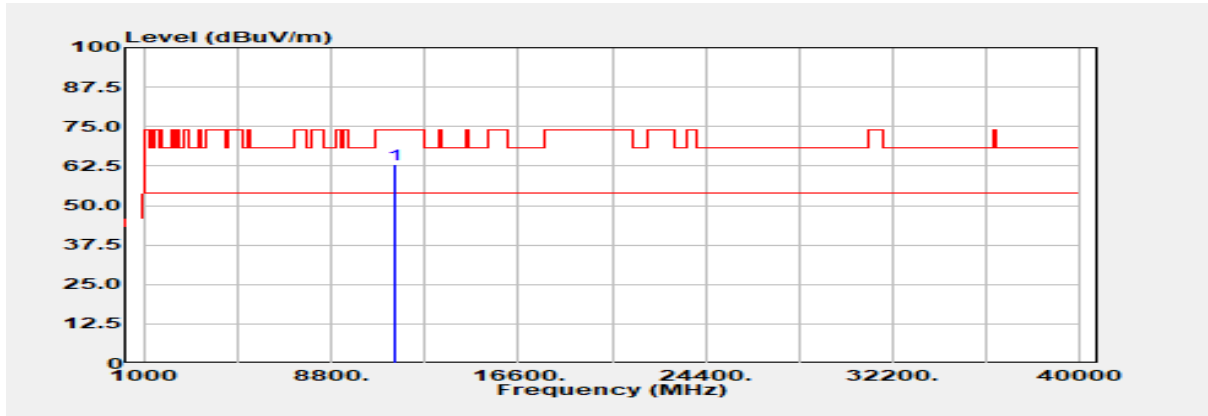

Freq. MHz	Detector Mode PK/QP/AV	Spectrum Reading Level dBuV	Factor dB	Actual FS dBuV/m	Limit @3m dBuV/m	Margin dB
11490.000	Peak	54.13	8.99	63.12	74.00	-10.88

Unless otherwise stated the results shown in this test report refer only to the sample(s) tested and such sample(s) are retained for 90 days only.

除非另有說明，此報告結果僅對測試之樣品負責，同時此樣品僅保留90天。本報告未經本公司書面許可，不可部份複製。

This document is issued by the Company subject to its General Conditions of Service printed overleaf, available on request or accessible at <http://www.sgs.com.tw/Terms-and-Conditions> and for electronic format documents, subject to Terms and Conditions for Electronic Documents at <http://www.sgs.com.tw/Terms-and-Conditions>. Attention is drawn to the limitation of liability, indemnification and jurisdiction issues defined therein. Any holder of this document is advised that information contained hereon reflects the Company's findings at the time of its intervention only and within the limits of Client's instructions, if any. The Company's sole responsibility is to its Client and this document does not exonerate parties to a transaction from exercising all their rights and obligations under the transaction documents. This document cannot be reproduced except in full, without prior written approval of the Company. Any unauthorized alteration, forgery or falsification of the content or appearance of this document is unlawful and offenders may be prosecuted to the fullest extent of the law.

Report Number	:E2/2020/B0037	Test Site	:966 Chamber D
Operation Mode	:802.11n20 / Band 4	Test Date	:2021-01-07
Test Frequency	:5745 MHz	Temp./Humi.	:21.3/61
Test Mode	:TX CH LOW	Antenna Pol.	:Horizontal
EUT Pol	:H Plan	Engineer	:Kailin Lee

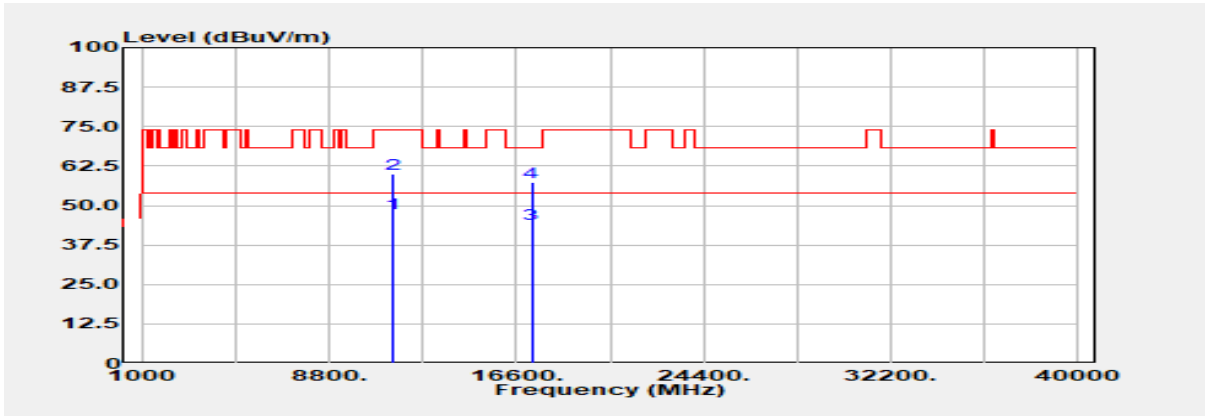

Freq. MHz	Detector Mode PK/QP/AV	Spectrum Reading Level dBuV	Factor dB	Actual FS dBuV/m	Limit @3m dBuV/m	Margin dB
11490.000	Average	38.63	8.99	47.62	54.00	-6.38
11490.000	Peak	51.05	8.99	60.04	74.00	-13.96
17235.000	Average	34.25	9.83	44.08	54.00	-9.92
17235.000	Peak	47.43	9.83	57.25	68.20	-10.95

Unless otherwise stated the results shown in this test report refer only to the sample(s) tested and such sample(s) are retained for 90 days only.

除非另有說明，此報告結果僅對測試之樣品負責，同時此樣品僅保留90天。本報告未經本公司書面許可，不可部份複製。

This document is issued by the Company subject to its General Conditions of Service printed overleaf, available on request or accessible at <http://www.sgs.com.tw/Terms-and-Conditions> and for electronic format documents, subject to Terms and Conditions for Electronic Documents at <http://www.sgs.com.tw/Terms-and-Conditions>. Attention is drawn to the limitation of liability, indemnification and jurisdiction issues defined therein. Any holder of this document is advised that information contained hereon reflects the Company's findings at the time of its intervention only and within the limits of Client's instructions, if any. The Company's sole responsibility is to its Client and this document does not exonerate parties to a transaction from exercising all their rights and obligations under the transaction documents. This document cannot be reproduced except in full, without prior written approval of the Company. Any unauthorized alteration, forgery or falsification of the content or appearance of this document is unlawful and offenders may be prosecuted to the fullest extent of the law.

Report Number	:E2/2020/B0037	Test Site	:966 Chamber D
Operation Mode	:802.11n20 / Band 4	Test Date	:2021-01-07
Test Frequency	:5785 MHz	Temp./Humi.	:21.3/61
Test Mode	:TX CH MID	Antenna Pol.	:Vertical
EUT Pol	:H Plan	Engineer	:Kailin Lee

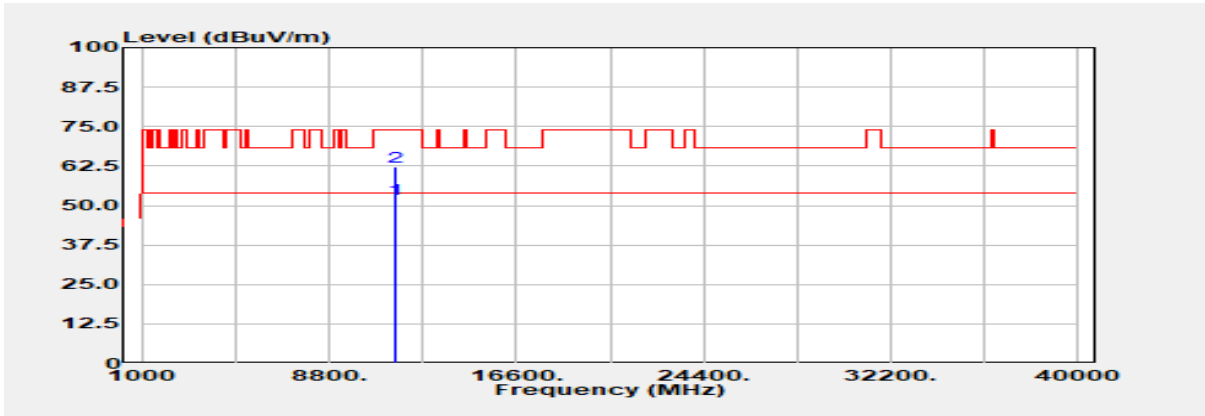

Freq. MHz	Detector Mode PK/QP/AV	Spectrum Reading Level dB $\mu$ V	Factor dB	Actual FS dB $\mu$ V/m	Limit @3m dB $\mu$ V/m	Margin dB
11570.000	Average	43.28	8.65	51.92	54.00	-2.08
11570.000	Peak	53.68	8.65	62.32	74.00	-11.68

Unless otherwise stated the results shown in this test report refer only to the sample(s) tested and such sample(s) are retained for 90 days only.

除非另有說明，此報告結果僅對測試之樣品負責，同時此樣品僅保留90天。本報告未經本公司書面許可，不可部份複製。

This document is issued by the Company subject to its General Conditions of Service printed overleaf, available on request or accessible at <http://www.sgs.com.tw/Terms-and-Conditions> and for electronic format documents, subject to Terms and Conditions for Electronic Documents at <http://www.sgs.com.tw/Terms-and-Conditions>. Attention is drawn to the limitation of liability, indemnification and jurisdiction issues defined therein. Any holder of this document is advised that information contained hereon reflects the Company's findings at the time of its intervention only and within the limits of Client's instructions, if any. The Company's sole responsibility is to its Client and this document does not exonerate parties to a transaction from exercising all their rights and obligations under the transaction documents. This document cannot be reproduced except in full, without prior written approval of the Company. Any unauthorized alteration, forgery or falsification of the content or appearance of this document is unlawful and offenders may be prosecuted to the fullest extent of the law.



Report Number	:E2/2020/B0037	Test Site	:966 Chamber D
Operation Mode	:802.11n20 / Band 4	Test Date	:2021-01-07
Test Frequency	:5785 MHz	Temp./Humi.	:21.3/61
Test Mode	:TX CH MID	Antenna Pol.	:Horizontal
EUT Pol	:H Plan	Engineer	:Kailin Lee

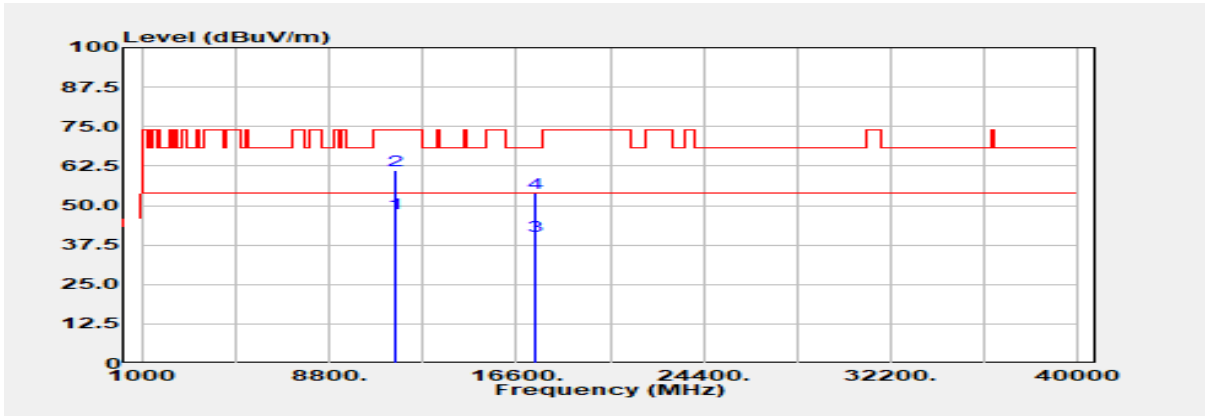

Freq. MHz	Detector Mode PK/QP/AV	Spectrum Reading Level dBuV	Factor dB	Actual FS dBuV/m	Limit @3m dBuV/m	Margin dB
11570.000	Average	38.87	8.65	47.51	54.00	-6.49
11570.000	Peak	52.38	8.65	61.03	74.00	-12.97
17355.000	Average	29.73	10.62	40.35	54.00	-13.65
17355.000	Peak	43.33	10.62	53.95	68.20	-14.25

Unless otherwise stated the results shown in this test report refer only to the sample(s) tested and such sample(s) are retained for 90 days only.

除非另有說明，此報告結果僅對測試之樣品負責，同時此樣品僅保留90天。本報告未經本公司書面許可，不可部份複製。

This document is issued by the Company subject to its General Conditions of Service printed overleaf, available on request or accessible at <http://www.sgs.com.tw/Terms-and-Conditions> and for electronic format documents, subject to Terms and Conditions for Electronic Documents at <http://www.sgs.com.tw/Terms-and-Conditions>. Attention is drawn to the limitation of liability, indemnification and jurisdiction issues defined therein. Any holder of this document is advised that information contained hereon reflects the Company's findings at the time of its intervention only and within the limits of Client's instructions, if any. The Company's sole responsibility is to its Client and this document does not exonerate parties to a transaction from exercising all their rights and obligations under the transaction documents. This document cannot be reproduced except in full, without prior written approval of the Company. Any unauthorized alteration, forgery or falsification of the content or appearance of this document is unlawful and offenders may be prosecuted to the fullest extent of the law.

Report Number	:E2/2020/B0037	Test Site	:966 Chamber D
Operation Mode	:802.11n20 / Band 4	Test Date	:2021-01-07
Test Frequency	:5825 MHz	Temp./Humi.	:21.3/61
Test Mode	:TX CH HIGH	Antenna Pol.	:Vertical
EUT Pol	:H Plan	Engineer	:Kailin Lee

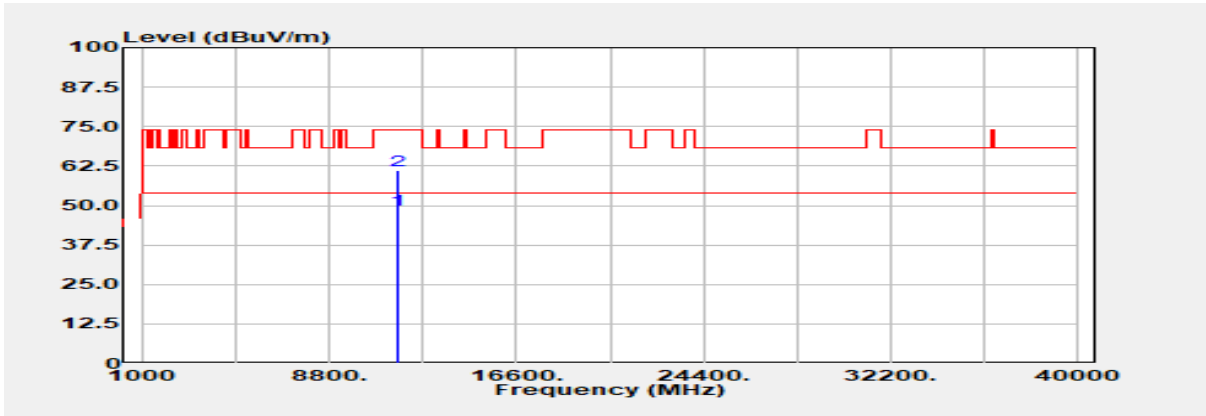

Freq. MHz	Detector Mode PK/QP/AV	Spectrum Reading Level dB $\mu$ V	Factor dB	Actual FS dB $\mu$ V/m	Limit @3m dB $\mu$ V/m	Margin dB
11650.000	Average	40.72	8.07	48.79	54.00	-5.21
11650.000	Peak	52.97	8.07	61.04	74.00	-12.96

Unless otherwise stated the results shown in this test report refer only to the sample(s) tested and such sample(s) are retained for 90 days only.

除非另有說明，此報告結果僅對測試之樣品負責，同時此樣品僅保留90天。本報告未經本公司書面許可，不可部份複製。

This document is issued by the Company subject to its General Conditions of Service printed overleaf, available on request or accessible at <http://www.sgs.com.tw/Terms-and-Conditions> and for electronic format documents, subject to Terms and Conditions for Electronic Documents at <http://www.sgs.com.tw/Terms-and-Conditions>. Attention is drawn to the limitation of liability, indemnification and jurisdiction issues defined therein. Any holder of this document is advised that information contained hereon reflects the Company's findings at the time of its intervention only and within the limits of Client's instructions, if any. The Company's sole responsibility is to its Client and this document does not exonerate parties to a transaction from exercising all their rights and obligations under the transaction documents. This document cannot be reproduced except in full, without prior written approval of the Company. Any unauthorized alteration, forgery or falsification of the content or appearance of this document is unlawful and offenders may be prosecuted to the fullest extent of the law.

Report Number	:E2/2020/B0037	Test Site	:966 Chamber D
Operation Mode	:802.11n20 / Band 4	Test Date	:2021-01-07
Test Frequency	:5825 MHz	Temp./Humi.	:21.3/61
Test Mode	:TX CH HIGH	Antenna Pol.	:Horizontal
EUT Pol	:H Plan	Engineer	:Kailin Lee

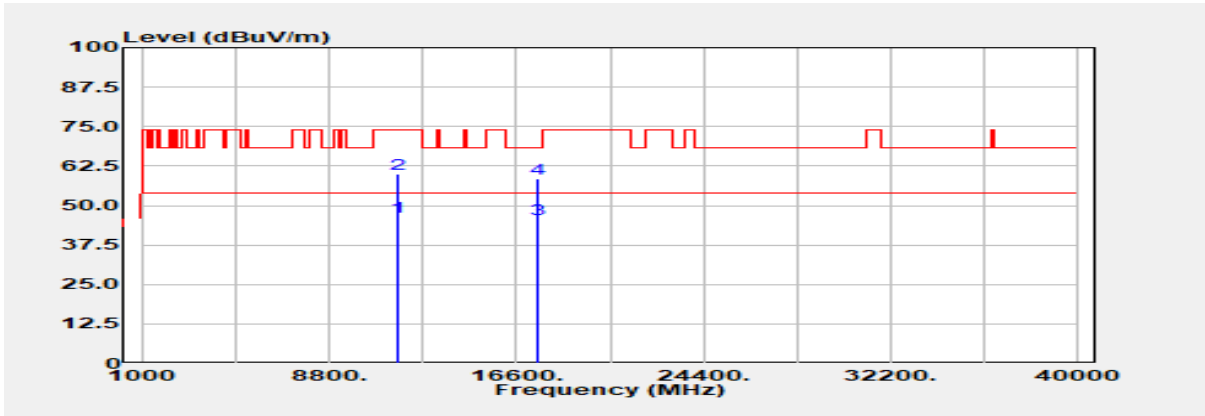

Freq. MHz	Detector Mode PK/QP/AV	Spectrum Reading Level dBuV	Factor dB	Actual FS dBuV/m	Limit @3m dBuV/m	Margin dB
11650.000	Average	38.47	8.07	46.54	54.00	-7.46
11650.000	Peak	51.94	8.07	60.01	74.00	-13.99
17480.000	Average	33.85	11.75	45.60	54.00	-8.40
17480.000	Peak	46.56	11.75	58.31	68.20	-9.89

Unless otherwise stated the results shown in this test report refer only to the sample(s) tested and such sample(s) are retained for 90 days only.

除非另有說明，此報告結果僅對測試之樣品負責，同時此樣品僅保留90天。本報告未經本公司書面許可，不可部份複製。

This document is issued by the Company subject to its General Conditions of Service printed overleaf, available on request or accessible at <http://www.sgs.com.tw/Terms-and-Conditions> and for electronic format documents, subject to Terms and Conditions for Electronic Documents at <http://www.sgs.com.tw/Terms-and-Conditions>. Attention is drawn to the limitation of liability, indemnification and jurisdiction issues defined therein. Any holder of this document is advised that information contained hereon reflects the Company's findings at the time of its intervention only and within the limits of Client's instructions, if any. The Company's sole responsibility is to its Client and this document does not exonerate parties to a transaction from exercising all their rights and obligations under the transaction documents. This document cannot be reproduced except in full, without prior written approval of the Company. Any unauthorized alteration, forgery or falsification of the content or appearance of this document is unlawful and offenders may be prosecuted to the fullest extent of the law.

Report Number	:E2/2020/B0037	Test Site	:966 Chamber D
Operation Mode	:802.11n40 / Band 1	Test Date	:2021-01-07
Test Frequency	:5190 MHz	Temp./Humi.	:20.8/62
Test Mode	:TX CH LOW	Antenna Pol.	:Vertical
EUT Pol	:H Plan	Engineer	:Kailin Lee

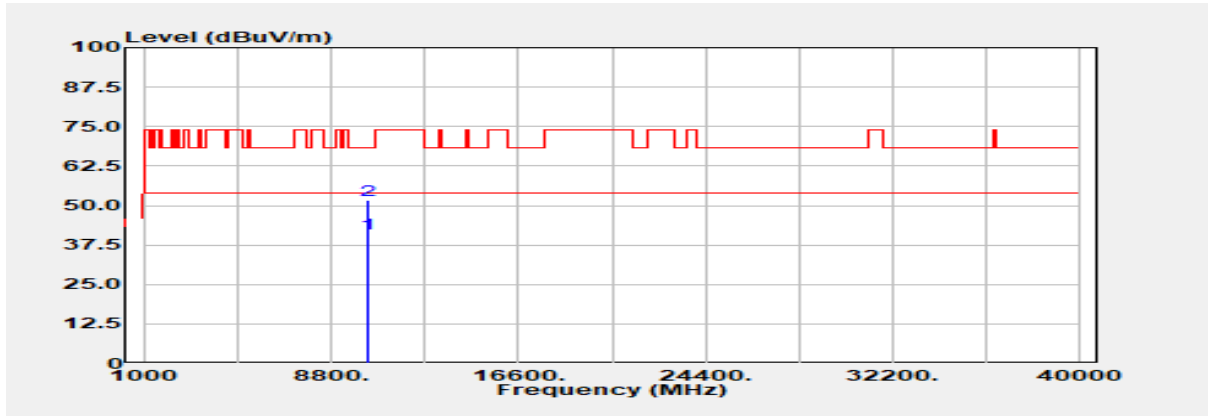

Freq. MHz	Detector Mode PK/QP/AV	Spectrum Reading Level dB $\mu$ V	Factor dB	Actual FS dB $\mu$ V/m	Limit @3m dB $\mu$ V/m	Margin dB
10380.000	Average	33.23	7.88	41.11	54.00	-12.89
10380.000	Peak	43.89	7.88	51.76	68.20	-16.44

Unless otherwise stated the results shown in this test report refer only to the sample(s) tested and such sample(s) are retained for 90 days only.

除非另有說明，此報告結果僅對測試之樣品負責，同時此樣品僅保留90天。本報告未經本公司書面許可，不可部份複製。

This document is issued by the Company subject to its General Conditions of Service printed overleaf, available on request or accessible at <http://www.sgs.com.tw/Terms-and-Conditions> and for electronic format documents, subject to Terms and Conditions for Electronic Documents at <http://www.sgs.com.tw/Terms-and-Conditions>. Attention is drawn to the limitation of liability, indemnification and jurisdiction issues defined therein. Any holder of this document is advised that information contained hereon reflects the Company's findings at the time of its intervention only and within the limits of Client's instructions, if any. The Company's sole responsibility is to its Client and this document does not exonerate parties to a transaction from exercising all their rights and obligations under the transaction documents. This document cannot be reproduced except in full, without prior written approval of the Company. Any unauthorized alteration, forgery or falsification of the content or appearance of this document is unlawful and offenders may be prosecuted to the fullest extent of the law.

Report Number	:E2/2020/B0037	Test Site	:966 Chamber D
Operation Mode	:802.11n40 / Band 1	Test Date	:2021-01-07
Test Frequency	:5190 MHz	Temp./Humi.	:20.8/62
Test Mode	:TX CH LOW	Antenna Pol.	:Horizontal
EUT Pol	:H Plan	Engineer	:Kailin Lee

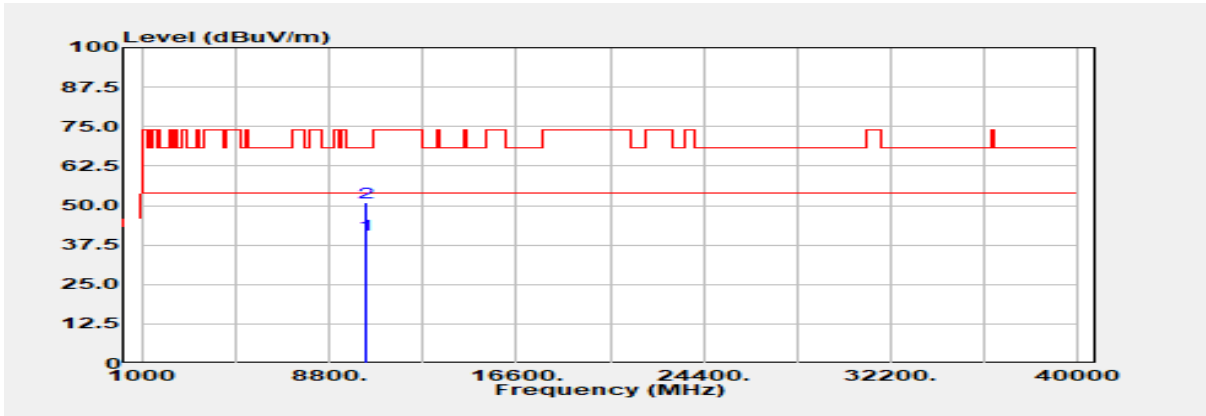

Freq. MHz	Detector Mode PK/QP/AV	Spectrum Reading Level dB $\mu$ V	Factor dB	Actual FS dB $\mu$ V/m	Limit @3m dB $\mu$ V/m	Margin dB
10380.000	Average	32.83	7.88	40.71	54.00	-13.29
10380.000	Peak	43.20	7.88	51.08	68.20	-17.12

Unless otherwise stated the results shown in this test report refer only to the sample(s) tested and such sample(s) are retained for 90 days only.

除非另有說明，此報告結果僅對測試之樣品負責，同時此樣品僅保留90天。本報告未經本公司書面許可，不可部份複製。

This document is issued by the Company subject to its General Conditions of Service printed overleaf, available on request or accessible at <http://www.sgs.com.tw/Terms-and-Conditions> and for electronic format documents, subject to Terms and Conditions for Electronic Documents at <http://www.sgs.com.tw/Terms-and-Conditions>. Attention is drawn to the limitation of liability, indemnification and jurisdiction issues defined therein. Any holder of this document is advised that information contained hereon reflects the Company's findings at the time of its intervention only and within the limits of Client's instructions, if any. The Company's sole responsibility is to its Client and this document does not exonerate parties to a transaction from exercising all their rights and obligations under the transaction documents. This document cannot be reproduced except in full, without prior written approval of the Company. Any unauthorized alteration, forgery or falsification of the content or appearance of this document is unlawful and offenders may be prosecuted to the fullest extent of the law.

Report Number	:E2/2020/B0037	Test Site	:966 Chamber D
Operation Mode	:802.11n40 / Band 1	Test Date	:2021-01-07
Test Frequency	:5230 MHz	Temp./Humi.	:20.8/62
Test Mode	:TX CH HIGH	Antenna Pol.	:Vertical
EUT Pol	:H Plan	Engineer	:Kailin Lee

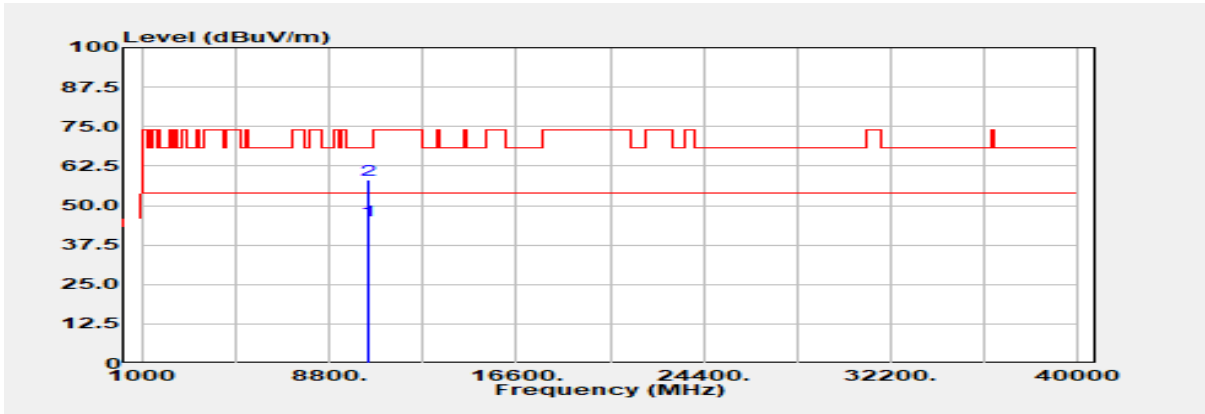

Freq. MHz	Detector Mode PK/QP/AV	Spectrum Reading Level dB $\mu$ V	Factor dB	Actual FS dB $\mu$ V/m	Limit @3m dB $\mu$ V/m	Margin dB
10460.000	Average	37.63	7.73	45.36	54.00	-8.64
10460.000	Peak	50.32	7.73	58.06	68.20	-10.14

Unless otherwise stated the results shown in this test report refer only to the sample(s) tested and such sample(s) are retained for 90 days only.

除非另有說明，此報告結果僅對測試之樣品負責，同時此樣品僅保留90天。本報告未經本公司書面許可，不可部份複製。

This document is issued by the Company subject to its General Conditions of Service printed overleaf, available on request or accessible at <http://www.sgs.com.tw/Terms-and-Conditions> and for electronic format documents, subject to Terms and Conditions for Electronic Documents at <http://www.sgs.com.tw/Terms-and-Conditions>. Attention is drawn to the limitation of liability, indemnification and jurisdiction issues defined therein. Any holder of this document is advised that information contained hereon reflects the Company's findings at the time of its intervention only and within the limits of Client's instructions, if any. The Company's sole responsibility is to its Client and this document does not exonerate parties to a transaction from exercising all their rights and obligations under the transaction documents. This document cannot be reproduced except in full, without prior written approval of the Company. Any unauthorized alteration, forgery or falsification of the content or appearance of this document is unlawful and offenders may be prosecuted to the fullest extent of the law.

Report Number	:E2/2020/B0037	Test Site	:966 Chamber D
Operation Mode	:802.11n40 / Band 1	Test Date	:2021-01-07
Test Frequency	:5230 MHz	Temp./Humi.	:20.8/62
Test Mode	:TX CH HIGH	Antenna Pol.	:Horizontal
EUT Pol	:H Plan	Engineer	:Kailin Lee

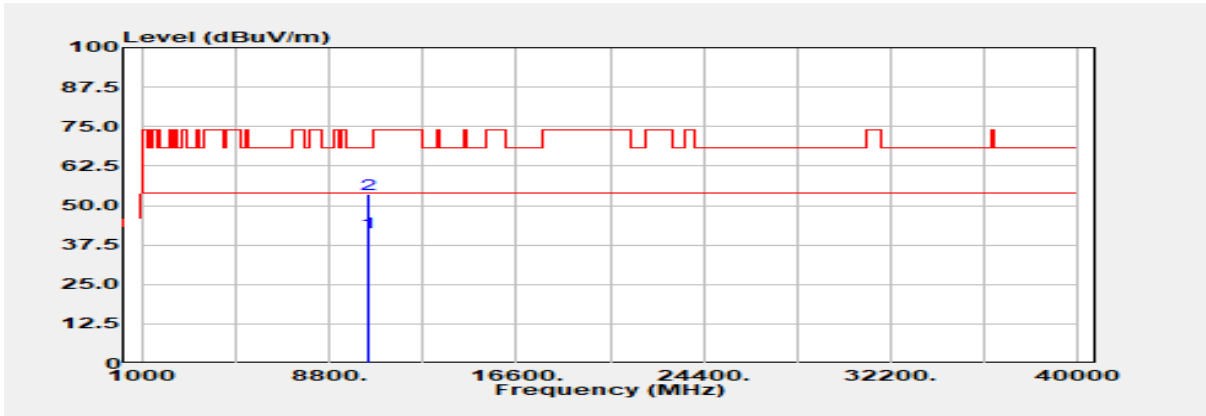

Freq. MHz	Detector Mode PK/QP/AV	Spectrum Reading Level dB $\mu$ V	Factor dB	Actual FS dB $\mu$ V/m	Limit @3m dB $\mu$ V/m	Margin dB
10460.000	Average	33.84	7.73	41.57	54.00	-12.43
10460.000	Peak	45.77	7.73	53.51	68.20	-14.69

Unless otherwise stated the results shown in this test report refer only to the sample(s) tested and such sample(s) are retained for 90 days only.

除非另有說明，此報告結果僅對測試之樣品負責，同時此樣品僅保留90天。本報告未經本公司書面許可，不可部份複製。

This document is issued by the Company subject to its General Conditions of Service printed overleaf, available on request or accessible at <http://www.sgs.com.tw/Terms-and-Conditions> and for electronic format documents, subject to Terms and Conditions for Electronic Documents at <http://www.sgs.com.tw/Terms-and-Conditions>. Attention is drawn to the limitation of liability, indemnification and jurisdiction issues defined therein. Any holder of this document is advised that information contained hereon reflects the Company's findings at the time of its intervention only and within the limits of Client's instructions, if any. The Company's sole responsibility is to its Client and this document does not exonerate parties to a transaction from exercising all their rights and obligations under the transaction documents. This document cannot be reproduced except in full, without prior written approval of the Company. Any unauthorized alteration, forgery or falsification of the content or appearance of this document is unlawful and offenders may be prosecuted to the fullest extent of the law.

Report Number	:E2/2020/B0037	Test Site	:966 Chamber D
Operation Mode	:802.11n40 / Band 4	Test Date	:2021-01-07
Test Frequency	:5755 MHz	Temp./Humi.	:20.8/62
Test Mode	:TX CH MID	Antenna Pol.	:Vertical
EUT Pol	:H Plan	Engineer	:Kailin Lee

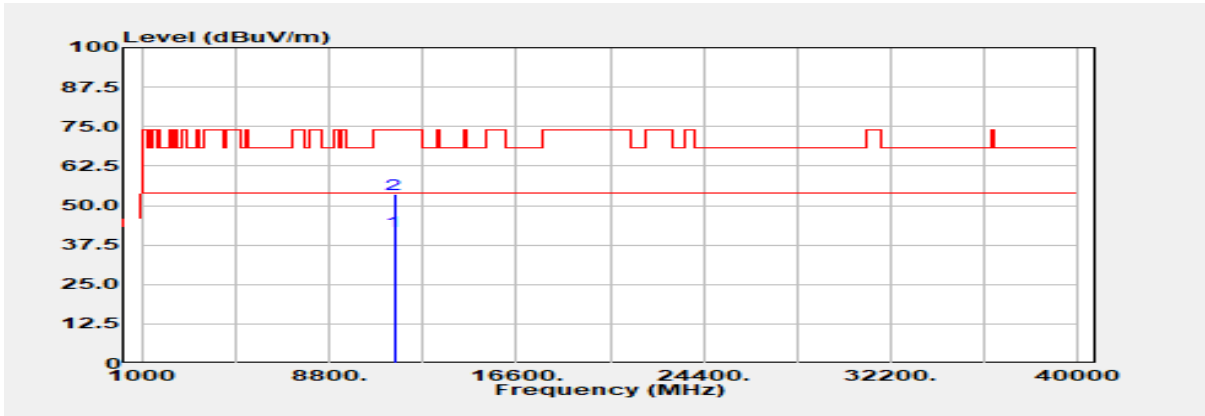

Freq. MHz	Detector Mode PK/QP/AV	Spectrum Reading Level dB $\mu$ V	Factor dB	Actual FS dB $\mu$ V/m	Limit @3m dB $\mu$ V/m	Margin dB
11510.000	Average	32.90	9.05	41.95	54.00	-12.05
11510.000	Peak	44.68	9.05	53.73	74.00	-20.27

Unless otherwise stated the results shown in this test report refer only to the sample(s) tested and such sample(s) are retained for 90 days only.

除非另有說明，此報告結果僅對測試之樣品負責，同時此樣品僅保留90天。本報告未經本公司書面許可，不可部份複製。

This document is issued by the Company subject to its General Conditions of Service printed overleaf, available on request or accessible at <http://www.sgs.com.tw/Terms-and-Conditions> and for electronic format documents, subject to Terms and Conditions for Electronic Documents at <http://www.sgs.com.tw/Terms-and-Conditions>. Attention is drawn to the limitation of liability, indemnification and jurisdiction issues defined therein. Any holder of this document is advised that information contained hereon reflects the Company's findings at the time of its intervention only and within the limits of Client's instructions, if any. The Company's sole responsibility is to its Client and this document does not exonerate parties to a transaction from exercising all their rights and obligations under the transaction documents. This document cannot be reproduced except in full, without prior written approval of the Company. Any unauthorized alteration, forgery or falsification of the content or appearance of this document is unlawful and offenders may be prosecuted to the fullest extent of the law.



Report Number	:E2/2020/B0037	Test Site	:966 Chamber D
Operation Mode	:802.11n40 / Band 4	Test Date	:2021-01-07
Test Frequency	:5755 MHz	Temp./Humi.	:20.8/62
Test Mode	:TX CH MID	Antenna Pol.	:Horizontal
EUT Pol	:H Plan	Engineer	:Kailin Lee

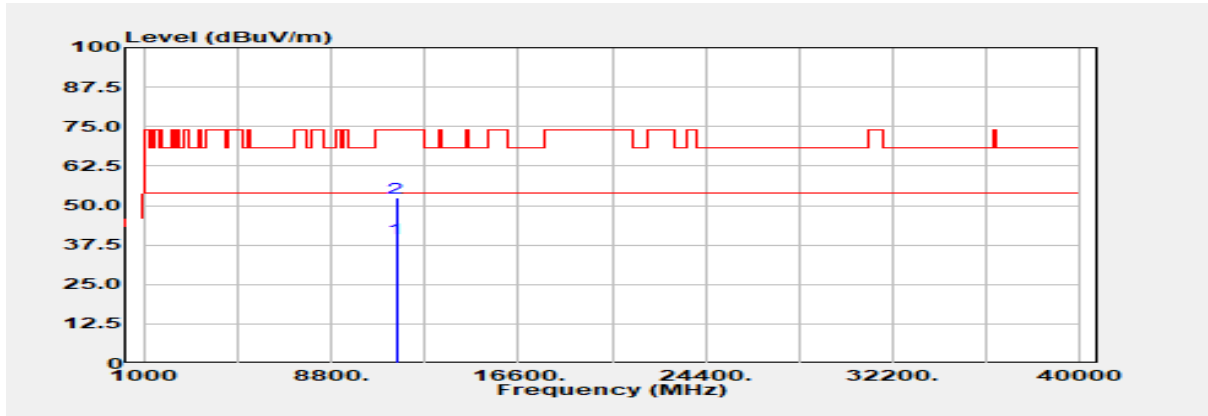

Freq. MHz	Detector Mode PK/QP/AV	Spectrum Reading Level dB $\mu$ V	Factor dB	Actual FS dB $\mu$ V/m	Limit @3m dB $\mu$ V/m	Margin dB
11510.000	Average	30.62	9.05	39.66	54.00	-14.34
11510.000	Peak	43.44	9.05	52.49	74.00	-21.51

Unless otherwise stated the results shown in this test report refer only to the sample(s) tested and such sample(s) are retained for 90 days only.

除非另有說明，此報告結果僅對測試之樣品負責，同時此樣品僅保留90天。本報告未經本公司書面許可，不可部份複製。

This document is issued by the Company subject to its General Conditions of Service printed overleaf, available on request or accessible at <http://www.sgs.com.tw/Terms-and-Conditions> and for electronic format documents, subject to Terms and Conditions for Electronic Documents at <http://www.sgs.com.tw/Terms-and-Conditions>. Attention is drawn to the limitation of liability, indemnification and jurisdiction issues defined therein. Any holder of this document is advised that information contained hereon reflects the Company's findings at the time of its intervention only and within the limits of Client's instructions, if any. The Company's sole responsibility is to its Client and this document does not exonerate parties to a transaction from exercising all their rights and obligations under the transaction documents. This document cannot be reproduced except in full, without prior written approval of the Company. Any unauthorized alteration, forgery or falsification of the content or appearance of this document is unlawful and offenders may be prosecuted to the fullest extent of the law.

Report Number	:E2/2020/B0037	Test Site	:966 Chamber D
Operation Mode	:802.11n40 / Band 4	Test Date	:2021-01-07
Test Frequency	:5795 MHz	Temp./Humi.	:20.8/62
Test Mode	:TX CH HIGH	Antenna Pol.	:Vertical
EUT Pol	:H Plan	Engineer	:Kailin Lee

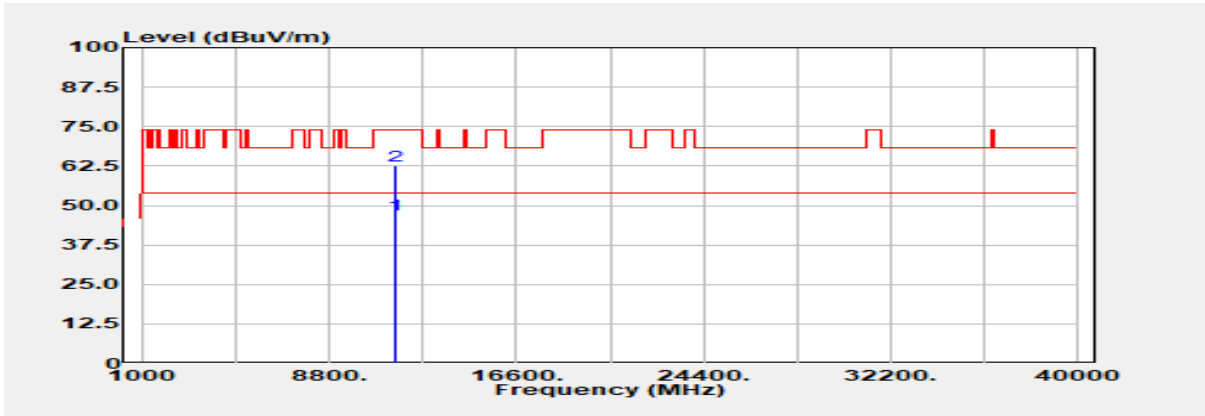

Freq. MHz	Detector Mode PK/QP/AV	Spectrum Reading Level dB $\mu$ V	Factor dB	Actual FS dB $\mu$ V/m	Limit @3m dB $\mu$ V/m	Margin dB
11590.000	Average	38.91	8.44	47.35	54.00	-6.65
11590.000	Peak	54.33	8.44	62.77	74.00	-11.23

Unless otherwise stated the results shown in this test report refer only to the sample(s) tested and such sample(s) are retained for 90 days only.

除非另有說明，此報告結果僅對測試之樣品負責，同時此樣品僅保留90天。本報告未經本公司書面許可，不可部份複製。

This document is issued by the Company subject to its General Conditions of Service printed overleaf, available on request or accessible at <http://www.sgs.com.tw/Terms-and-Conditions> and for electronic format documents, subject to Terms and Conditions for Electronic Documents at <http://www.sgs.com.tw/Terms-and-Conditions>. Attention is drawn to the limitation of liability, indemnification and jurisdiction issues defined therein. Any holder of this document is advised that information contained hereon reflects the Company's findings at the time of its intervention only and within the limits of Client's instructions, if any. The Company's sole responsibility is to its Client and this document does not exonerate parties to a transaction from exercising all their rights and obligations under the transaction documents. This document cannot be reproduced except in full, without prior written approval of the Company. Any unauthorized alteration, forgery or falsification of the content or appearance of this document is unlawful and offenders may be prosecuted to the fullest extent of the law.

Report Number	:E2/2020/B0037	Test Site	:966 Chamber D
Operation Mode	:802.11n40 / Band 4	Test Date	:2021-01-07
Test Frequency	:5795 MHz	Temp./Humi.	:20.8/62
Test Mode	:TX CH HIGH	Antenna Pol.	:Horizontal
EUT Pol	:H Plan	Engineer	:Kailin Lee

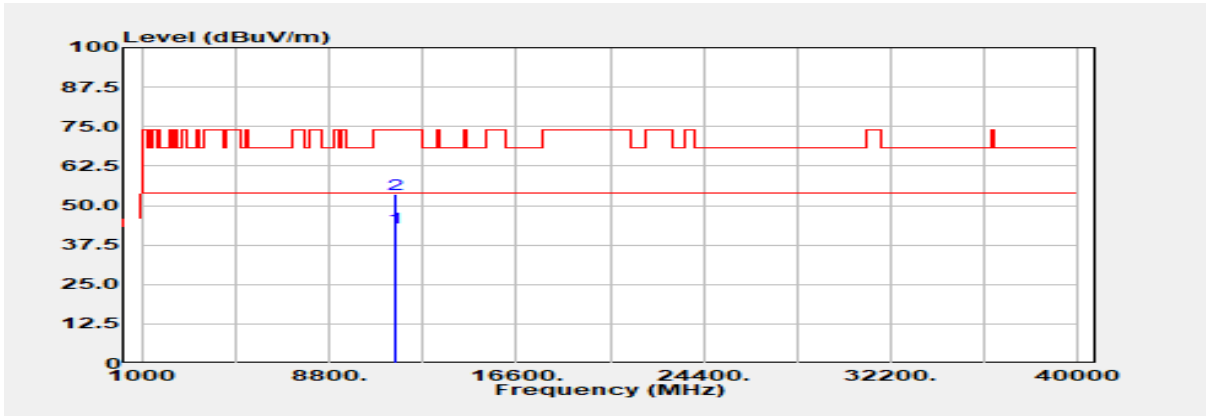

Freq. MHz	Detector Mode PK/QP/AV	Spectrum Reading Level dB $\mu$ V	Factor dB	Actual FS dB $\mu$ V/m	Limit @3m dB $\mu$ V/m	Margin dB
11590.000	Average	34.46	8.44	42.90	54.00	-11.10
11590.000	Peak	45.11	8.44	53.54	74.00	-20.46

Unless otherwise stated the results shown in this test report refer only to the sample(s) tested and such sample(s) are retained for 90 days only.

除非另有說明，此報告結果僅對測試之樣品負責，同時此樣品僅保留90天。本報告未經本公司書面許可，不可部份複製。

This document is issued by the Company subject to its General Conditions of Service printed overleaf, available on request or accessible at <http://www.sgs.com.tw/Terms-and-Conditions> and for electronic format documents, subject to Terms and Conditions for Electronic Documents at <http://www.sgs.com.tw/Terms-and-Conditions>. Attention is drawn to the limitation of liability, indemnification and jurisdiction issues defined therein. Any holder of this document is advised that information contained hereon reflects the Company's findings at the time of its intervention only and within the limits of Client's instructions, if any. The Company's sole responsibility is to its Client and this document does not exonerate parties to a transaction from exercising all their rights and obligations under the transaction documents. This document cannot be reproduced except in full, without prior written approval of the Company. Any unauthorized alteration, forgery or falsification of the content or appearance of this document is unlawful and offenders may be prosecuted to the fullest extent of the law.

Report Number	:E2/2020/B0037	Test Site	:966 Chamber D
Operation Mode	:802.11ac80 / Band 1	Test Date	:2021-01-07
Test Frequency	:5210 MHz	Temp./Humi.	:20.8/62
Test Mode	:TX CH LOW	Antenna Pol.	:Vertical
EUT Pol	:H Plan	Engineer	:Kailin Lee

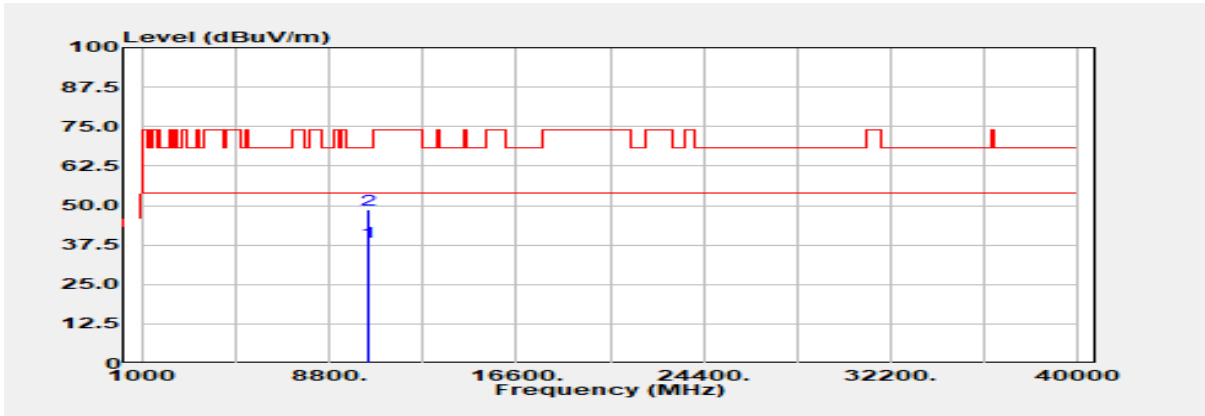

Freq. MHz	Detector Mode PK/QP/AV	Spectrum Reading Level dB $\mu$ V	Factor dB	Actual FS dB $\mu$ V/m	Limit @3m dB $\mu$ V/m	Margin dB
10420.000	Average	30.59	7.92	38.51	54.00	-15.49
10420.000	Peak	40.86	7.92	48.78	68.20	-19.42

Unless otherwise stated the results shown in this test report refer only to the sample(s) tested and such sample(s) are retained for 90 days only.

除非另有說明，此報告結果僅對測試之樣品負責，同時此樣品僅保留90天。本報告未經本公司書面許可，不可部份複製。

This document is issued by the Company subject to its General Conditions of Service printed overleaf, available on request or accessible at <http://www.sgs.com.tw/Terms-and-Conditions> and for electronic format documents, subject to Terms and Conditions for Electronic Documents at <http://www.sgs.com.tw/Terms-and-Conditions>. Attention is drawn to the limitation of liability, indemnification and jurisdiction issues defined therein. Any holder of this document is advised that information contained hereon reflects the Company's findings at the time of its intervention only and within the limits of Client's instructions, if any. The Company's sole responsibility is to its Client and this document does not exonerate parties to a transaction from exercising all their rights and obligations under the transaction documents. This document cannot be reproduced except in full, without prior written approval of the Company. Any unauthorized alteration, forgery or falsification of the content or appearance of this document is unlawful and offenders may be prosecuted to the fullest extent of the law.

Report Number	:E2/2020/B0037	Test Site	:966 Chamber D
Operation Mode	:802.11ac80 / Band 1	Test Date	:2021-01-07
Test Frequency	:5210 MHz	Temp./Humi.	:20.8/62
Test Mode	:TX CH LOW	Antenna Pol.	:Horizontal
EUT Pol	:H Plan	Engineer	:Kailin Lee

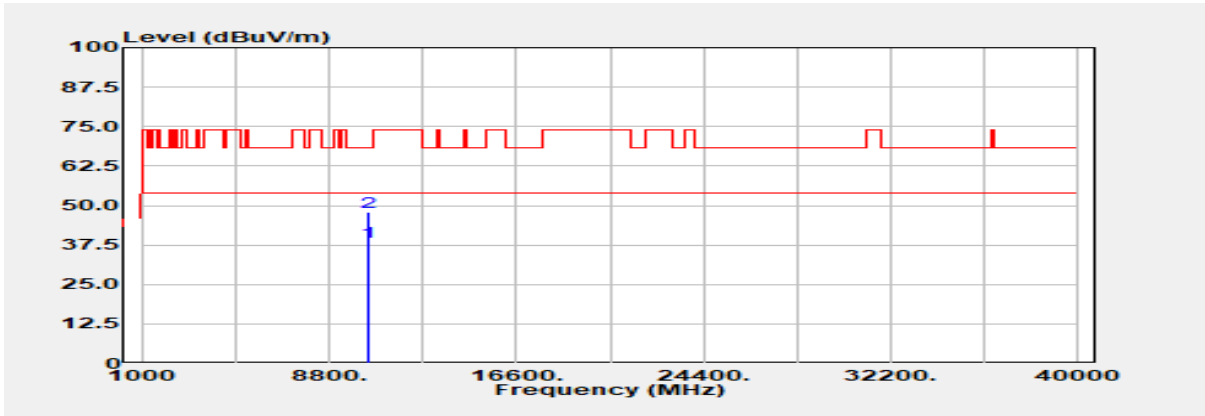

Freq. MHz	Detector Mode PK/QP/AV	Spectrum Reading Level dB $\mu$ V	Factor dB	Actual FS dB $\mu$ V/m	Limit @3m dB $\mu$ V/m	Margin dB
10420.000	Average	30.63	7.92	38.55	54.00	-15.45
10420.000	Peak	40.09	7.92	48.01	68.20	-20.19

Unless otherwise stated the results shown in this test report refer only to the sample(s) tested and such sample(s) are retained for 90 days only.

除非另有說明，此報告結果僅對測試之樣品負責，同時此樣品僅保留90天。本報告未經本公司書面許可，不可部份複製。

This document is issued by the Company subject to its General Conditions of Service printed overleaf, available on request or accessible at <http://www.sgs.com.tw/Terms-and-Conditions> and for electronic format documents, subject to Terms and Conditions for Electronic Documents at <http://www.sgs.com.tw/Terms-and-Conditions>. Attention is drawn to the limitation of liability, indemnification and jurisdiction issues defined therein. Any holder of this document is advised that information contained hereon reflects the Company's findings at the time of its intervention only and within the limits of Client's instructions, if any. The Company's sole responsibility is to its Client and this document does not exonerate parties to a transaction from exercising all their rights and obligations under the transaction documents. This document cannot be reproduced except in full, without prior written approval of the Company. Any unauthorized alteration, forgery or falsification of the content or appearance of this document is unlawful and offenders may be prosecuted to the fullest extent of the law.

Report Number	:E2/2020/B0037	Test Site	:966 Chamber D
Operation Mode	:802.11ac80 / Band 4	Test Date	:2021-01-08
Test Frequency	:5775 MHz	Temp./Humi.	: 22.5/67
Test Mode	: TX CH LOW	Antenna Pol.	:Vertical
EUT Pol	:H Plan	Engineer	:Kailin Lee

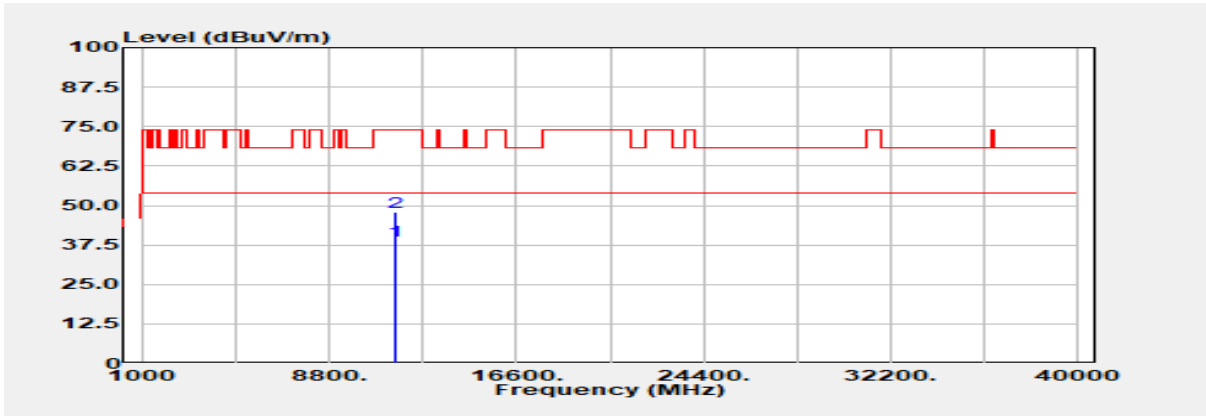

Freq. MHz	Detector Mode PK/QP/AV	Spectrum Reading Level dBμV	Factor dB	Actual FS dBμV/m	Limit @3m dBμV/m	Margin dB
11550.000	Average	29.95	8.86	38.81	54.00	-15.19
11550.000	Peak	38.90	8.86	47.76	74.00	-26.24

Unless otherwise stated the results shown in this test report refer only to the sample(s) tested and such sample(s) are retained for 90 days only.

除非另有說明，此報告結果僅對測試之樣品負責，同時此樣品僅保留90天。本報告未經本公司書面許可，不可部份複製。

This document is issued by the Company subject to its General Conditions of Service printed overleaf, available on request or accessible at <http://www.sgs.com.tw/Terms-and-Conditions> and for electronic format documents, subject to Terms and Conditions for Electronic Documents at <http://www.sgs.com.tw/Terms-and-Conditions>. Attention is drawn to the limitation of liability, indemnification and jurisdiction issues defined therein. Any holder of this document is advised that information contained hereon reflects the Company's findings at the time of its intervention only and within the limits of Client's instructions, if any. The Company's sole responsibility is to its Client and this document does not exonerate parties to a transaction from exercising all their rights and obligations under the transaction documents. This document cannot be reproduced except in full, without prior written approval of the Company. Any unauthorized alteration, forgery or falsification of the content or appearance of this document is unlawful and offenders may be prosecuted to the fullest extent of the law.

Report Number	:E2/2020/B0037	Test Site	:966 Chamber D
Operation Mode	:802.11ac80 / Band 4	Test Date	:2021-01-08
Test Frequency	:5775 MHz	Temp./Humi.	: 22.5/67
Test Mode	: TX CH LOW	Antenna Pol.	:Horizontal
EUT Pol	:H Plan	Engineer	:Kailin Lee

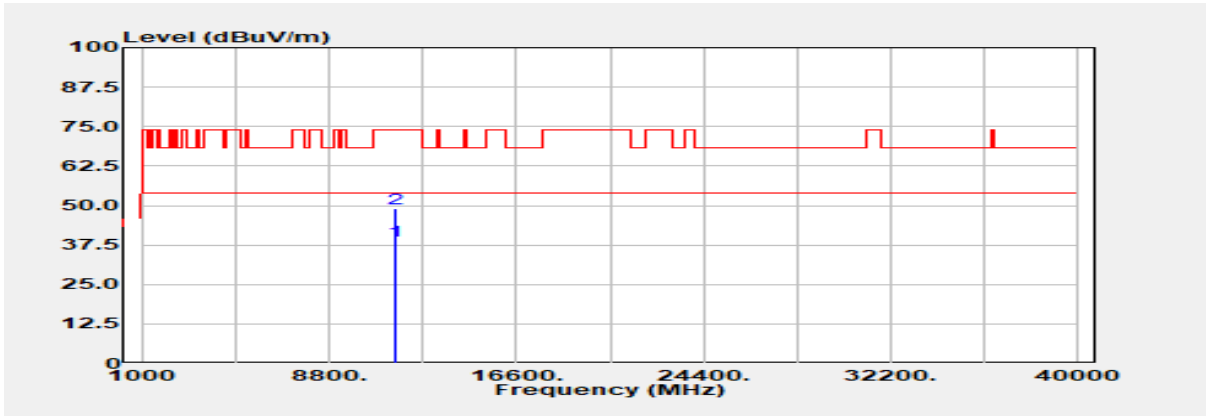

Freq. MHz	Detector Mode PK/QP/AV	Spectrum Reading Level dB $\mu$ V	Factor dB	Actual FS dB $\mu$ V/m	Limit @3m dB $\mu$ V/m	Margin dB
11550.000	Average	29.95	8.86	38.81	54.00	-15.19
11550.000	Peak	40.09	8.86	48.94	74.00	-25.06

Unless otherwise stated the results shown in this test report refer only to the sample(s) tested and such sample(s) are retained for 90 days only.

除非另有說明，此報告結果僅對測試之樣品負責，同時此樣品僅保留90天。本報告未經本公司書面許可，不可部份複製。

This document is issued by the Company subject to its General Conditions of Service printed overleaf, available on request or accessible at <http://www.sgs.com.tw/Terms-and-Conditions> and for electronic format documents, subject to Terms and Conditions for Electronic Documents at <http://www.sgs.com.tw/Terms-and-Conditions>. Attention is drawn to the limitation of liability, indemnification and jurisdiction issues defined therein. Any holder of this document is advised that information contained hereon reflects the Company's findings at the time of its intervention only and within the limits of Client's instructions, if any. The Company's sole responsibility is to its Client and this document does not exonerate parties to a transaction from exercising all their rights and obligations under the transaction documents. This document cannot be reproduced except in full, without prior written approval of the Company. Any unauthorized alteration, forgery or falsification of the content or appearance of this document is unlawful and offenders may be prosecuted to the fullest extent of the law.

**Simultaneous**

Report Number	:E2/2020/B0037	Test Site	:966 Chamber D
Operation Mode	:802.11b&802.11a/Band 1	Test Date	:2021-02-22
Test Frequency	:2437 MHZ/5220 MHz	Temp./Humi.	:21.1/49
Test Mode	:TX CH MID	Antenna Pol.	:Vertical
EUT Pol	:H Plan	Engineer	:Jack Tseng

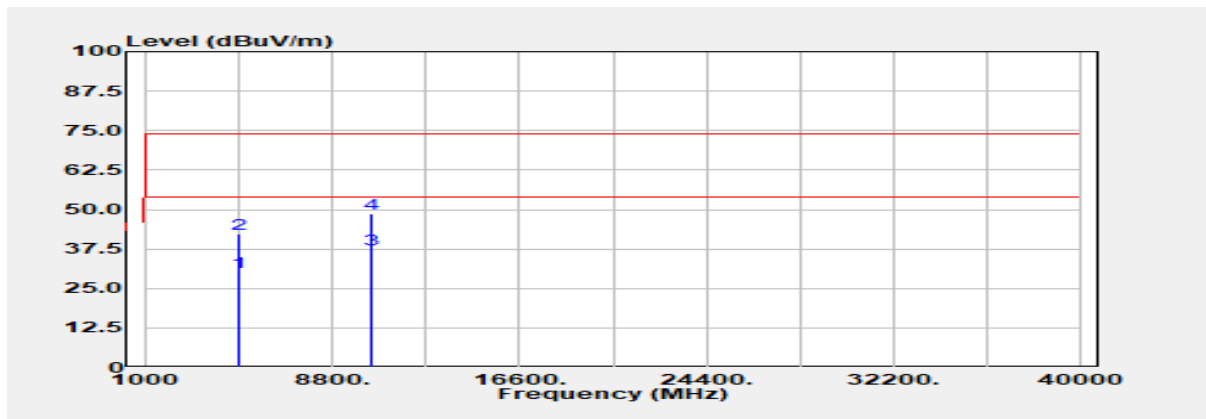

Freq. MHz	Detector Mode PK/QP/AV	Spectrum Reading Level dB $\mu$ V	Factor dB	Actual FS dB $\mu$ V/m	Limit @3m dB $\mu$ V/m	Margin dB
4874.000	Average	33.37	-3.00	30.37	54.00	-23.63
4874.000	Peak	45.12	-3.00	42.12	74.00	-31.88
10440.000	Average	29.38	7.95	37.33	54.00	-16.67
10440.000	Peak	40.65	7.95	48.60	74.00	-25.40

Unless otherwise stated the results shown in this test report refer only to the sample(s) tested and such sample(s) are retained for 90 days only.

除非另有說明，此報告結果僅對測試之樣品負責，同時此樣品僅保留90天。本報告未經本公司書面許可，不可部份複製。

This document is issued by the Company subject to its General Conditions of Service printed overleaf, available on request or accessible at <http://www.sgs.com.tw/Terms-and-Conditions> and for electronic format documents, subject to Terms and Conditions for Electronic Documents at <http://www.sgs.com.tw/Terms-and-Conditions>. Attention is drawn to the limitation of liability, indemnification and jurisdiction issues defined therein. Any holder of this document is advised that information contained hereon reflects the Company's findings at the time of its intervention only and within the limits of Client's instructions, if any. The Company's sole responsibility is to its Client and this document does not exonerate parties to a transaction from exercising all their rights and obligations under the transaction documents. This document cannot be reproduced except in full, without prior written approval of the Company. Any unauthorized alteration, forgery or falsification of the content or appearance of this document is unlawful and offenders may be prosecuted to the fullest extent of the law.



Report Number :E2/2020/B0037  
 Operation Mode :802.11b&802.11a/Band 1  
 Test Frequency :2437 MHZ/5220 MHz  
 Test Mode :TX CH MID  
 EUT Pol :H Plan

Test Site :966 Chamber D  
 Test Date :2021-02-22  
 Temp./Humi. :21.1/49  
 Antenna Pol. :Horizontal  
 Engineer :Jack Tseng

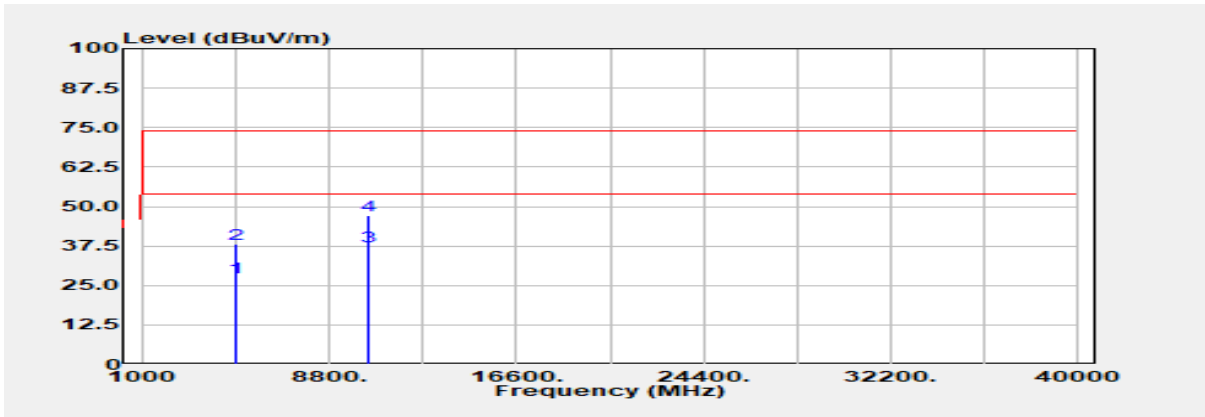

Freq. MHz	Detector Mode PK/QP/AV	Spectrum Reading Level dB $\mu$ V	Factor dB	Actual FS dB $\mu$ V/m	Limit @3m dB $\mu$ V/m	Margin dB
4874.000	Average	30.41	-3.00	27.41	54.00	-26.59
4874.000	Peak	41.07	-3.00	38.07	74.00	-35.93
10440.000	Average	29.46	7.95	37.40	54.00	-16.60
10440.000	Peak	39.26	7.95	47.21	74.00	-26.79

Unless otherwise stated the results shown in this test report refer only to the sample(s) tested and such sample(s) are retained for 90 days only.

除非另有說明，此報告結果僅對測試之樣品負責，同時此樣品僅保留90天。本報告未經本公司書面許可，不可部份複製。

This document is issued by the Company subject to its General Conditions of Service printed overleaf, available on request or accessible at <http://www.sgs.com.tw/Terms-and-Conditions> and for electronic format documents, subject to Terms and Conditions for Electronic Documents at <http://www.sgs.com.tw/Terms-and-Conditions>. Attention is drawn to the limitation of liability, indemnification and jurisdiction issues defined therein. Any holder of this document is advised that information contained hereon reflects the Company's findings at the time of its intervention only and within the limits of Client's instructions, if any. The Company's sole responsibility is to its Client and this document does not exonerate parties to a transaction from exercising all their rights and obligations under the transaction documents. This document cannot be reproduced except in full, without prior written approval of the Company. Any unauthorized alteration, forgery or falsification of the content or appearance of this document is unlawful and offenders may be prosecuted to the fullest extent of the law.

### 11.7.3 Band edge falling to restricted band

Report Number	:E2/2020/B0037	Test Site	:966 Chamber D
Operation Mode	:802.11a / Band 1	Test Date	:2020-12-26
Test Frequency	:5180 MHz	Temp./Humi.	:22.5/63
Test Mode	:BE CH LOW	Antenna Pol.	:Vertical
EUT Pol	:H Plan	Engineer	:Kailin Lee

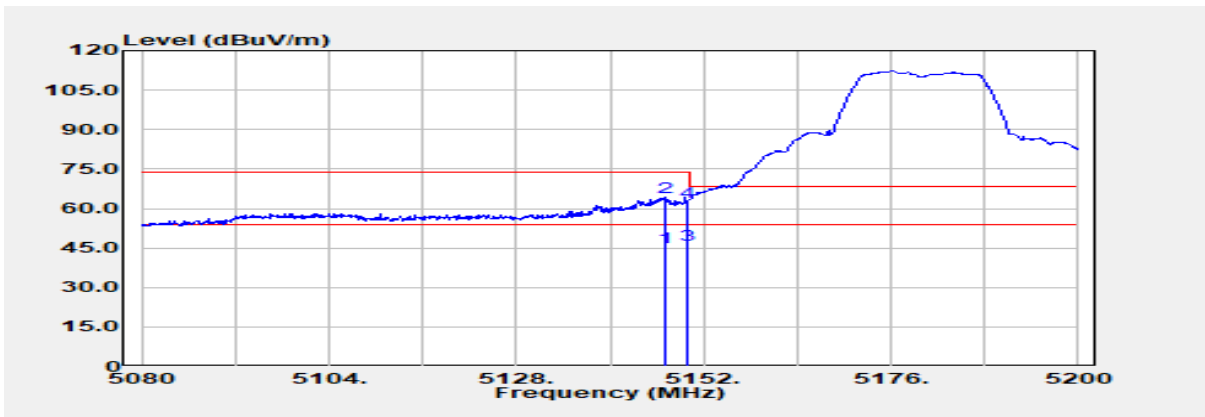

Freq. MHz	Detector Mode PK/QP/AV	Spectrum Reading Level dB $\mu$ V	Factor dB	Actual FS dB $\mu$ V/m	Limit @3m dB $\mu$ V/m	Margin dB
5147.200	Average	47.84	-2.39	45.45	54.00	-8.55
5147.200	Peak	66.57	-2.39	64.18	74.00	-9.82
5150.000	Average	48.51	-2.43	46.08	54.00	-7.92
5150.000	Peak	65.06	-2.43	62.63	74.00	-11.37

Unless otherwise stated the results shown in this test report refer only to the sample(s) tested and such sample(s) are retained for 90 days only.

除非另有說明，此報告結果僅對測試之樣品負責，同時此樣品僅保留90天。本報告未經本公司書面許可，不可部份複製。

This document is issued by the Company subject to its General Conditions of Service printed overleaf, available on request or accessible at <http://www.sgs.com.tw/Terms-and-Conditions> and for electronic format documents, subject to Terms and Conditions for Electronic Documents at <http://www.sgs.com.tw/Terms-and-Conditions>. Attention is drawn to the limitation of liability, indemnification and jurisdiction issues defined therein. Any holder of this document is advised that information contained hereon reflects the Company's findings at the time of its intervention only and within the limits of Client's instructions, if any. The Company's sole responsibility is to its Client and this document does not exonerate parties to a transaction from exercising all their rights and obligations under the transaction documents. This document cannot be reproduced except in full, without prior written approval of the Company. Any unauthorized alteration, forgery or falsification of the content or appearance of this document is unlawful and offenders may be prosecuted to the fullest extent of the law.

Report Number	:E2/2020/B0037	Test Site	:966 Chamber D
Operation Mode	:802.11a / Band 1	Test Date	:2020-12-26
Test Frequency	:5180 MHz	Temp./Humi.	:22.5/63
Test Mode	:BE CH LOW	Antenna Pol.	:Horizontal
EUT Pol	:H Plan	Engineer	:Kailin Lee

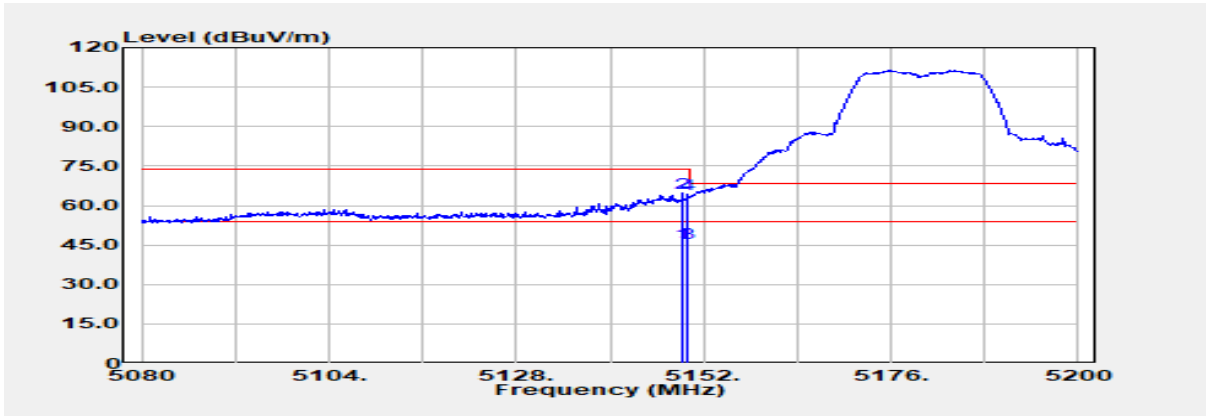

Freq. MHz	Detector Mode PK/QP/AV	Spectrum Reading Level dB $\mu$ V	Factor dB	Actual FS dB $\mu$ V/m	Limit @3m dB $\mu$ V/m	Margin dB
5149.240	Average	47.97	-2.42	45.55	54.00	-8.45
5149.240	Peak	67.00	-2.42	64.58	74.00	-9.42
5150.000	Average	48.17	-2.43	45.74	54.00	-8.26
5150.000	Peak	66.56	-2.43	64.13	74.00	-9.87

Unless otherwise stated the results shown in this test report refer only to the sample(s) tested and such sample(s) are retained for 90 days only.

除非另有說明，此報告結果僅對測試之樣品負責，同時此樣品僅保留90天。本報告未經本公司書面許可，不可部份複製。

This document is issued by the Company subject to its General Conditions of Service printed overleaf, available on request or accessible at <http://www.sgs.com.tw/Terms-and-Conditions> and for electronic format documents, subject to Terms and Conditions for Electronic Documents at <http://www.sgs.com.tw/Terms-and-Conditions>. Attention is drawn to the limitation of liability, indemnification and jurisdiction issues defined therein. Any holder of this document is advised that information contained hereon reflects the Company's findings at the time of its intervention only and within the limits of Client's instructions, if any. The Company's sole responsibility is to its Client and this document does not exonerate parties to a transaction from exercising all their rights and obligations under the transaction documents. This document cannot be reproduced except in full, without prior written approval of the Company. Any unauthorized alteration, forgery or falsification of the content or appearance of this document is unlawful and offenders may be prosecuted to the fullest extent of the law.

Report Number :E2/2020/B0037  
Operation Mode :802.11a / Band 4  
Test Frequency :5745 MHz  
Test Mode :BE CH LOW  
EUT Pol :H Plan

Test Site :966 Chamber D  
Test Date :2021-01-08  
Temp./Humi. :22.9/66  
Antenna Pol. :Vertical  
Engineer :Kailin Lee

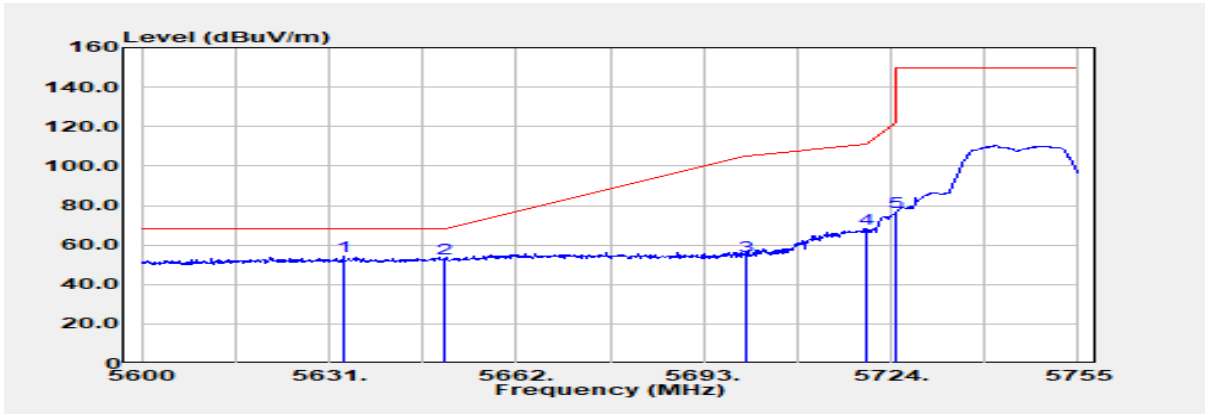

Freq. MHz	Detector Mode PK/QP/AV	Spectrum Reading Level dB $\mu$ V	Factor dB	Actual FS dB $\mu$ V/m	Limit @3m dB $\mu$ V/m	Margin dB
5633.480	Peak	56.08	-2.04	54.04	68.20	-14.16
5650.000	Peak	55.00	-2.00	53.00	68.20	-15.20
5700.000	Peak	56.69	-2.17	54.53	105.20	-50.67
5720.000	Peak	70.11	-1.70	68.42	110.80	-42.38
5725.000	Peak	78.80	-1.98	76.82	122.20	-45.38

Unless otherwise stated the results shown in this test report refer only to the sample(s) tested and such sample(s) are retained for 90 days only.

除非另有說明，此報告結果僅對測試之樣品負責，同時此樣品僅保留90天。本報告未經本公司書面許可，不可部份複製。

This document is issued by the Company subject to its General Conditions of Service printed overleaf, available on request or accessible at <http://www.sgs.com.tw/Terms-and-Conditions> and for electronic format documents, subject to Terms and Conditions for Electronic Documents at <http://www.sgs.com.tw/Terms-and-Conditions>. Attention is drawn to the limitation of liability, indemnification and jurisdiction issues defined therein. Any holder of this document is advised that information contained hereon reflects the Company's findings at the time of its intervention only and within the limits of Client's instructions, if any. The Company's sole responsibility is to its Client and this document does not exonerate parties to a transaction from exercising all their rights and obligations under the transaction documents. This document cannot be reproduced except in full, without prior written approval of the Company. Any unauthorized alteration, forgery or falsification of the content or appearance of this document is unlawful and offenders may be prosecuted to the fullest extent of the law.

Report Number :E2/2020/B0037  
 Operation Mode :802.11a / Band 4  
 Test Frequency :5745 MHz  
 Test Mode :BE CH LOW  
 EUT Pol :H Plan

Test Site :966 Chamber D  
 Test Date :2021-01-08  
 Temp./Humi. : 22.9/66  
 Antenna Pol. :Horizontal  
 Engineer :Kailin Lee

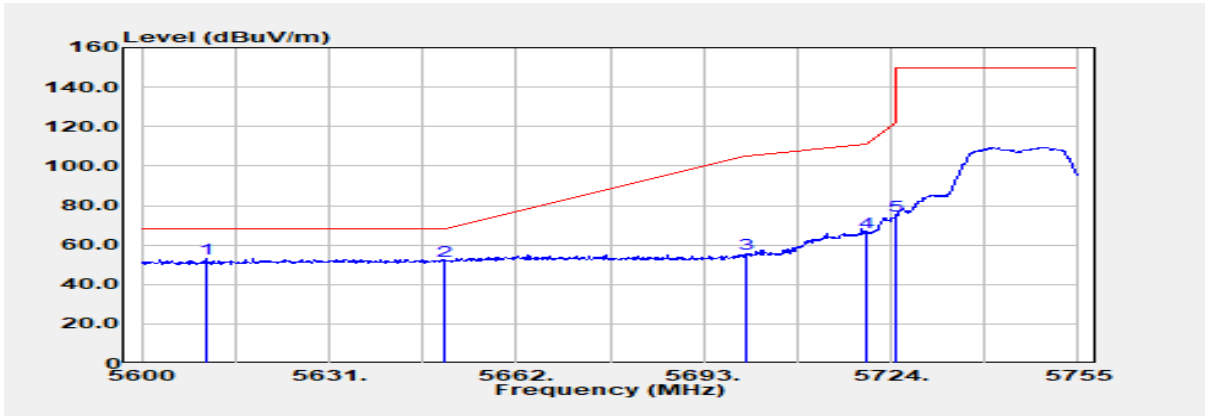

Freq. MHz	Detector Mode PK/QP/AV	Spectrum Reading Level dBuV	Factor dB	Actual FS dBuV/m	Limit @3m dBuV/m	Margin dB
5610.540	Peak	55.60	-2.37	53.23	68.20	-14.97
5650.000	Peak	53.81	-2.00	51.81	68.20	-16.39
5700.000	Peak	57.53	-2.17	55.37	105.20	-49.83
5720.000	Peak	67.97	-1.70	66.27	110.80	-44.53
5725.000	Peak	77.08	-1.98	75.10	122.20	-47.10

Unless otherwise stated the results shown in this test report refer only to the sample(s) tested and such sample(s) are retained for 90 days only.

除非另有說明，此報告結果僅對測試之樣品負責，同時此樣品僅保留90天。本報告未經本公司書面許可，不可部份複製。

This document is issued by the Company subject to its General Conditions of Service printed overleaf, available on request or accessible at <http://www.sgs.com.tw/Terms-and-Conditions> and for electronic format documents, subject to Terms and Conditions for Electronic Documents at <http://www.sgs.com.tw/Terms-and-Conditions>. Attention is drawn to the limitation of liability, indemnification and jurisdiction issues defined therein. Any holder of this document is advised that information contained hereon reflects the Company's findings at the time of its intervention only and within the limits of Client's instructions, if any. The Company's sole responsibility is to its Client and this document does not exonerate parties to a transaction from exercising all their rights and obligations under the transaction documents. This document cannot be reproduced except in full, without prior written approval of the Company. Any unauthorized alteration, forgery or falsification of the content or appearance of this document is unlawful and offenders may be prosecuted to the fullest extent of the law.

Report Number	:E2/2020/B0037	Test Site	:966 Chamber D
Operation Mode	:802.11a / Band 4	Test Date	:2021-01-08
Test Frequency	:5825 MHz	Temp./Humi.	: 22.9/66
Test Mode	:BE CH HIGH	Antenna Pol.	:Vertical
EUT Pol	:H Plan	Engineer	:Kailin Lee

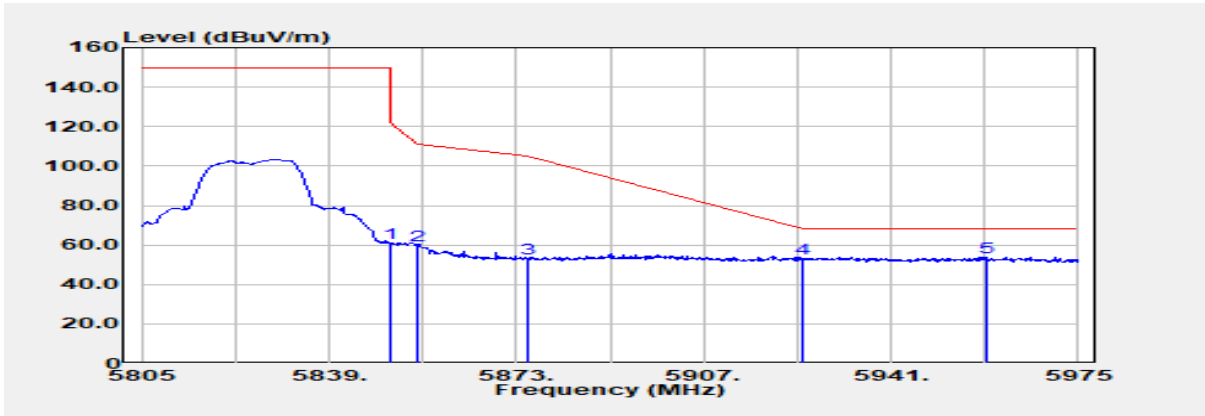

Freq. MHz	Detector Mode PK/QP/AV	Spectrum Reading Level dB $\mu$ V	Factor dB	Actual FS dB $\mu$ V/m	Limit @3m dB $\mu$ V/m	Margin dB
5850.000	Peak	62.64	-1.57	61.07	122.20	-61.13
5855.000	Peak	61.37	-1.42	59.95	110.80	-50.85
5875.000	Peak	54.28	-1.42	52.86	105.20	-52.34
5925.000	Peak	54.34	-0.99	53.35	68.20	-14.85
5958.340	Peak	54.61	-0.79	53.82	68.20	-14.38

Unless otherwise stated the results shown in this test report refer only to the sample(s) tested and such sample(s) are retained for 90 days only.

除非另有說明，此報告結果僅對測試之樣品負責，同時此樣品僅保留90天。本報告未經本公司書面許可，不可部份複製。

This document is issued by the Company subject to its General Conditions of Service printed overleaf, available on request or accessible at <http://www.sgs.com.tw/Terms-and-Conditions> and for electronic format documents, subject to Terms and Conditions for Electronic Documents at <http://www.sgs.com.tw/Terms-and-Conditions>. Attention is drawn to the limitation of liability, indemnification and jurisdiction issues defined therein. Any holder of this document is advised that information contained hereon reflects the Company's findings at the time of its intervention only and within the limits of Client's instructions, if any. The Company's sole responsibility is to its Client and this document does not exonerate parties to a transaction from exercising all their rights and obligations under the transaction documents. This document cannot be reproduced except in full, without prior written approval of the Company. Any unauthorized alteration, forgery or falsification of the content or appearance of this document is unlawful and offenders may be prosecuted to the fullest extent of the law.

Report Number	:E2/2020/B0037	Test Site	:966 Chamber D
Operation Mode	:802.11a / Band 4	Test Date	:2021-01-08
Test Frequency	:5825 MHz	Temp./Humi.	:22.9/66
Test Mode	:BE CH HIGH	Antenna Pol.	:Horizontal
EUT Pol	:H Plan	Engineer	:Kailin Lee

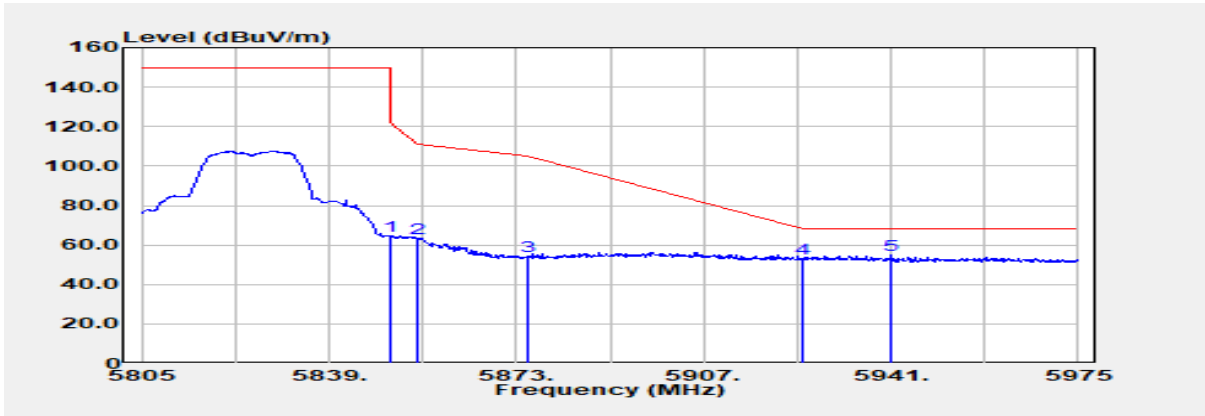

Freq. MHz	Detector Mode PK/QP/AV	Spectrum Reading Level dB $\mu$ V	Factor dB	Actual FS dB $\mu$ V/m	Limit @3m dB $\mu$ V/m	Margin dB
5850.000	Peak	65.91	-1.57	64.34	122.20	-57.86
5855.000	Peak	64.93	-1.42	63.51	110.80	-47.29
5875.000	Peak	55.58	-1.42	54.16	105.20	-51.04
5925.000	Peak	54.08	-0.99	53.09	68.20	-15.11
5941.000	Peak	55.87	-1.23	54.65	68.20	-13.55

Unless otherwise stated the results shown in this test report refer only to the sample(s) tested and such sample(s) are retained for 90 days only.

除非另有說明，此報告結果僅對測試之樣品負責，同時此樣品僅保留90天。本報告未經本公司書面許可，不可部份複製。

This document is issued by the Company subject to its General Conditions of Service printed overleaf, available on request or accessible at <http://www.sgs.com.tw/Terms-and-Conditions> and for electronic format documents, subject to Terms and Conditions for Electronic Documents at <http://www.sgs.com.tw/Terms-and-Conditions>. Attention is drawn to the limitation of liability, indemnification and jurisdiction issues defined therein. Any holder of this document is advised that information contained hereon reflects the Company's findings at the time of its intervention only and within the limits of Client's instructions, if any. The Company's sole responsibility is to its Client and this document does not exonerate parties to a transaction from exercising all their rights and obligations under the transaction documents. This document cannot be reproduced except in full, without prior written approval of the Company. Any unauthorized alteration, forgery or falsification of the content or appearance of this document is unlawful and offenders may be prosecuted to the fullest extent of the law.

Report Number	:E2/2020/B0037	Test Site	:966 Chamber D
Operation Mode	:802.11n20 / Band 1	Test Date	:2020-12-26
Test Frequency	:5180 MHz	Temp./Humi.	:22.5/63
Test Mode	:BE CH LOW	Antenna Pol.	:Vertical
EUT Pol	:H Plan	Engineer	:Kailin Lee

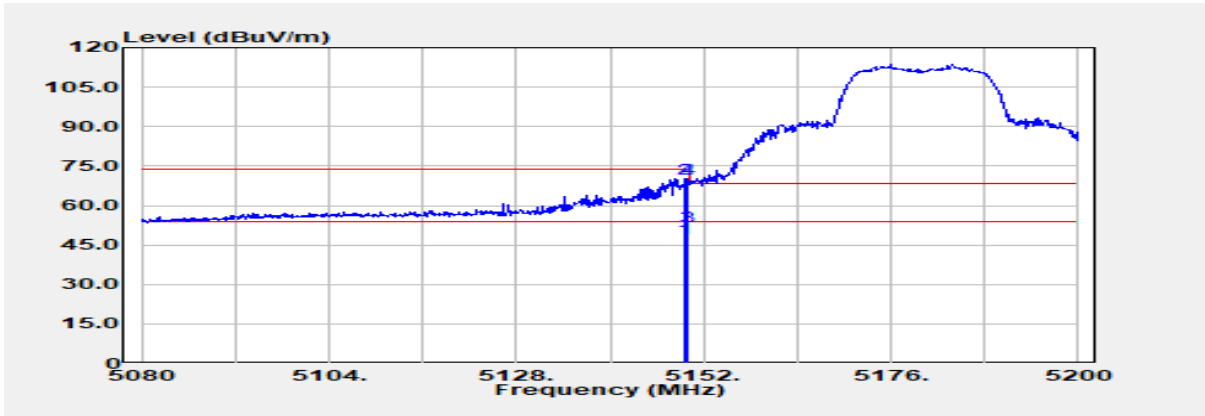

Freq. MHz	Detector Mode PK/QP/AV	Spectrum Reading Level dBuV	Factor dB	Actual FS dBuV/m	Limit @3m dBuV/m	Margin dB
5149.720	Average	49.76	-2.42	47.33	54.00	-6.67
5149.720	Peak	72.74	-2.42	70.32	74.00	-3.68
5150.000	Average	54.57	-2.43	52.14	54.00	-1.86
5150.000	Peak	72.40	-2.43	69.97	74.00	-4.03

Unless otherwise stated the results shown in this test report refer only to the sample(s) tested and such sample(s) are retained for 90 days only.

除非另有說明，此報告結果僅對測試之樣品負責，同時此樣品僅保留90天。本報告未經本公司書面許可，不可部份複製。

This document is issued by the Company subject to its General Conditions of Service printed overleaf, available on request or accessible at <http://www.sgs.com.tw/Terms-and-Conditions> and for electronic format documents, subject to Terms and Conditions for Electronic Documents at <http://www.sgs.com.tw/Terms-and-Conditions>. Attention is drawn to the limitation of liability, indemnification and jurisdiction issues defined therein. Any holder of this document is advised that information contained hereon reflects the Company's findings at the time of its intervention only and within the limits of Client's instructions, if any. The Company's sole responsibility is to its Client and this document does not exonerate parties to a transaction from exercising all their rights and obligations under the transaction documents. This document cannot be reproduced except in full, without prior written approval of the Company. Any unauthorized alteration, forgery or falsification of the content or appearance of this document is unlawful and offenders may be prosecuted to the fullest extent of the law.



Report Number	:E2/2020/B0037	Test Site	:966 Chamber D
Operation Mode	:802.11n20 / Band 1	Test Date	:2020-12-26
Test Frequency	:5180 MHz	Temp./Humi.	:22.5/63
Test Mode	:BE CH LOW	Antenna Pol.	:Horizontal
EUT Pol	:H Plan	Engineer	:Kailin Lee

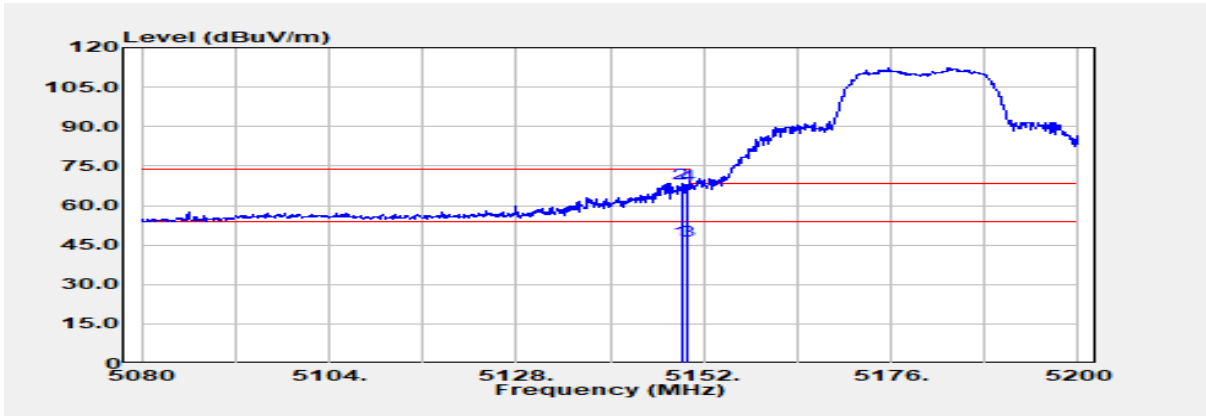

Freq. MHz	Detector Mode PK/QP/AV	Spectrum Reading Level dB $\mu$ V	Factor dB	Actual FS dB $\mu$ V/m	Limit @3m dB $\mu$ V/m	Margin dB
5149.120	Average	49.02	-2.42	46.60	54.00	-7.40
5149.120	Peak	70.93	-2.42	68.51	74.00	-5.49
5150.000	Average	49.19	-2.43	46.76	54.00	-7.24
5150.000	Peak	70.41	-2.43	67.98	74.00	-6.02

Unless otherwise stated the results shown in this test report refer only to the sample(s) tested and such sample(s) are retained for 90 days only.

除非另有說明，此報告結果僅對測試之樣品負責，同時此樣品僅保留90天。本報告未經本公司書面許可，不可部份複製。

This document is issued by the Company subject to its General Conditions of Service printed overleaf, available on request or accessible at <http://www.sgs.com.tw/Terms-and-Conditions> and for electronic format documents, subject to Terms and Conditions for Electronic Documents at <http://www.sgs.com.tw/Terms-and-Conditions>. Attention is drawn to the limitation of liability, indemnification and jurisdiction issues defined therein. Any holder of this document is advised that information contained hereon reflects the Company's findings at the time of its intervention only and within the limits of Client's instructions, if any. The Company's sole responsibility is to its Client and this document does not exonerate parties to a transaction from exercising all their rights and obligations under the transaction documents. This document cannot be reproduced except in full, without prior written approval of the Company. Any unauthorized alteration, forgery or falsification of the content or appearance of this document is unlawful and offenders may be prosecuted to the fullest extent of the law.

Report Number	:E2/2020/B0037	Test Site	:966 Chamber D
Operation Mode	:802.11n20 / Band 4	Test Date	:2021-01-08
Test Frequency	:5745 MHz	Temp./Humi.	:20.2/60
Test Mode	:BE CH LOW	Antenna Pol.	:Vertical
EUT Pol	:H Plan	Engineer	:Kailin Lee

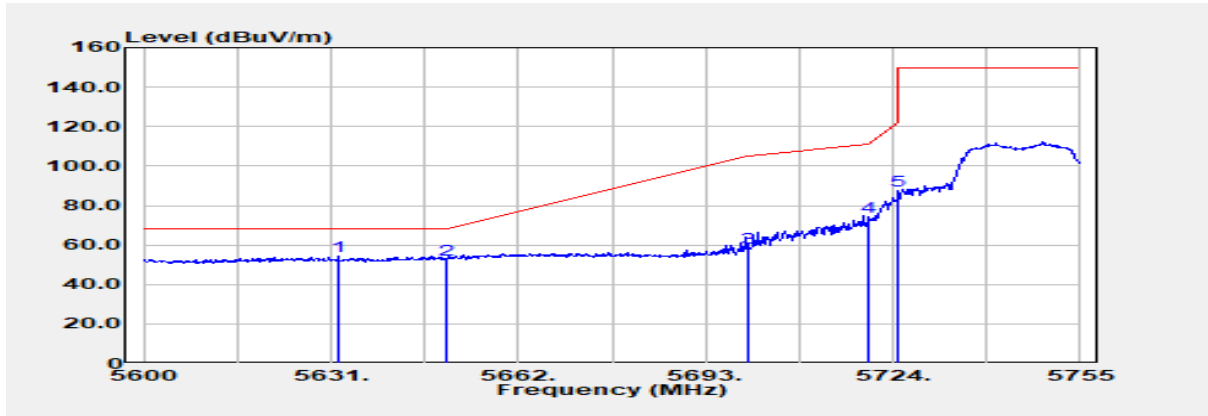

Freq. MHz	Detector Mode PK/QP/AV	Spectrum Reading Level dBuV	Factor dB	Actual FS dBuV/m	Limit @3m dBuV/m	Margin dB
5632.240	Peak	56.31	-2.02	54.30	68.20	-13.90
5650.000	Peak	54.83	-2.00	52.83	68.20	-15.37
5700.000	Peak	60.57	-2.17	58.40	105.20	-46.80
5720.000	Peak	75.75	-1.70	74.05	110.80	-36.75
5725.000	Peak	89.44	-1.98	87.47	122.20	-34.73

Unless otherwise stated the results shown in this test report refer only to the sample(s) tested and such sample(s) are retained for 90 days only.

除非另有說明，此報告結果僅對測試之樣品負責，同時此樣品僅保留90天。本報告未經本公司書面許可，不可部份複製。

This document is issued by the Company subject to its General Conditions of Service printed overleaf, available on request or accessible at <http://www.sgs.com.tw/Terms-and-Conditions> and for electronic format documents, subject to Terms and Conditions for Electronic Documents at <http://www.sgs.com.tw/Terms-and-Conditions>. Attention is drawn to the limitation of liability, indemnification and jurisdiction issues defined therein. Any holder of this document is advised that information contained hereon reflects the Company's findings at the time of its intervention only and within the limits of Client's instructions, if any. The Company's sole responsibility is to its Client and this document does not exonerate parties to a transaction from exercising all their rights and obligations under the transaction documents. This document cannot be reproduced except in full, without prior written approval of the Company. Any unauthorized alteration, forgery or falsification of the content or appearance of this document is unlawful and offenders may be prosecuted to the fullest extent of the law.

Report Number	:E2/2020/B0037	Test Site	:966 Chamber D
Operation Mode	:802.11n20 / Band 4	Test Date	:2021-01-08
Test Frequency	:5745 MHz	Temp./Humi.	:20.2/60
Test Mode	:BE CH LOW	Antenna Pol.	:Horizontal
EUT Pol	:H Plan	Engineer	:Kailin Lee

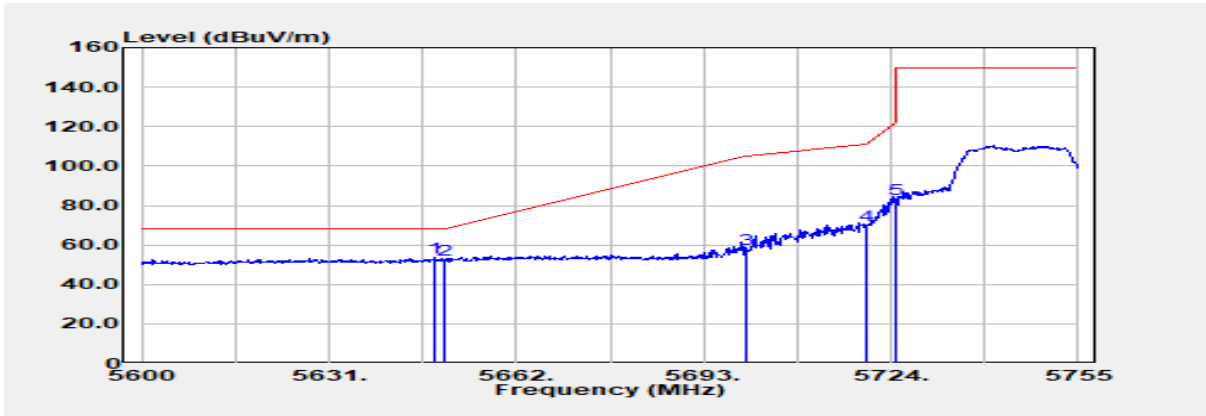

Freq. MHz	Detector Mode PK/QP/AV	Spectrum Reading Level dBuV	Factor dB	Actual FS dBuV/m	Limit @3m dBuV/m	Margin dB
5648.670	Peak	55.72	-2.02	53.70	68.20	-14.50
5650.000	Peak	54.82	-2.00	52.82	68.20	-15.38
5700.000	Peak	60.24	-2.17	58.07	105.20	-47.13
5720.000	Peak	71.57	-1.70	69.87	110.80	-40.93
5725.000	Peak	85.26	-1.98	83.28	122.20	-38.92

Unless otherwise stated the results shown in this test report refer only to the sample(s) tested and such sample(s) are retained for 90 days only.

除非另有說明，此報告結果僅對測試之樣品負責，同時此樣品僅保留90天。本報告未經本公司書面許可，不可部份複製。

This document is issued by the Company subject to its General Conditions of Service printed overleaf, available on request or accessible at <http://www.sgs.com.tw/Terms-and-Conditions> and for electronic format documents, subject to Terms and Conditions for Electronic Documents at <http://www.sgs.com.tw/Terms-and-Conditions>. Attention is drawn to the limitation of liability, indemnification and jurisdiction issues defined therein. Any holder of this document is advised that information contained hereon reflects the Company's findings at the time of its intervention only and within the limits of Client's instructions, if any. The Company's sole responsibility is to its Client and this document does not exonerate parties to a transaction from exercising all their rights and obligations under the transaction documents. This document cannot be reproduced except in full, without prior written approval of the Company. Any unauthorized alteration, forgery or falsification of the content or appearance of this document is unlawful and offenders may be prosecuted to the fullest extent of the law.

Report Number	:E2/2020/B0037	Test Site	:966 Chamber D
Operation Mode	:802.11n20 / Band 4	Test Date	:2021-01-08
Test Frequency	:5825 MHz	Temp./Humi.	: 20.2/60
Test Mode	:BE CH HIGH	Antenna Pol.	:Vertical
EUT Pol	:H Plan	Engineer	:Kailin Lee

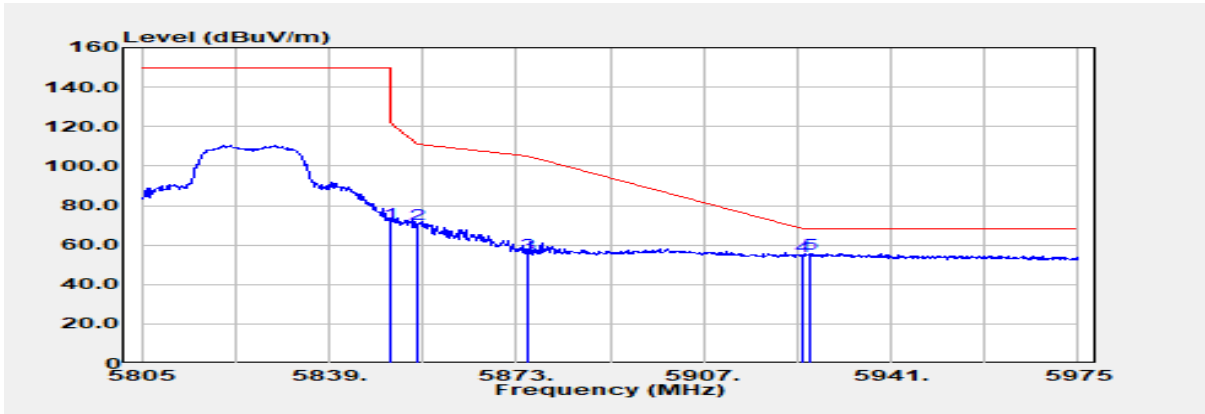

Freq. MHz	Detector Mode PK/QP/AV	Spectrum Reading Level dBuV	Factor dB	Actual FS dBuV/m	Limit @3m dBuV/m	Margin dB
5850.000	Peak	72.63	-1.57	71.06	122.20	-51.14
5855.000	Peak	71.88	-1.42	70.46	110.80	-40.34
5875.000	Peak	57.04	-1.42	55.62	105.20	-49.58
5925.000	Peak	55.57	-0.99	54.58	68.20	-13.62
5926.380	Peak	56.70	-0.96	55.74	68.20	-12.46

Unless otherwise stated the results shown in this test report refer only to the sample(s) tested and such sample(s) are retained for 90 days only.

除非另有說明，此報告結果僅對測試之樣品負責，同時此樣品僅保留90天。本報告未經本公司書面許可，不可部份複製。

This document is issued by the Company subject to its General Conditions of Service printed overleaf, available on request or accessible at <http://www.sgs.com.tw/Terms-and-Conditions> and for electronic format documents, subject to Terms and Conditions for Electronic Documents at <http://www.sgs.com.tw/Terms-and-Conditions>. Attention is drawn to the limitation of liability, indemnification and jurisdiction issues defined therein. Any holder of this document is advised that information contained hereon reflects the Company's findings at the time of its intervention only and within the limits of Client's instructions, if any. The Company's sole responsibility is to its Client and this document does not exonerate parties to a transaction from exercising all their rights and obligations under the transaction documents. This document cannot be reproduced except in full, without prior written approval of the Company. Any unauthorized alteration, forgery or falsification of the content or appearance of this document is unlawful and offenders may be prosecuted to the fullest extent of the law.

Report Number	:E2/2020/B0037	Test Site	:966 Chamber D
Operation Mode	:802.11n20 / Band 4	Test Date	:2021-01-08
Test Frequency	:5825 MHz	Temp./Humi.	: 20.2/60
Test Mode	:BE CH HIGH	Antenna Pol.	:Horizontal
EUT Pol	:H Plan	Engineer	:Kailin Lee

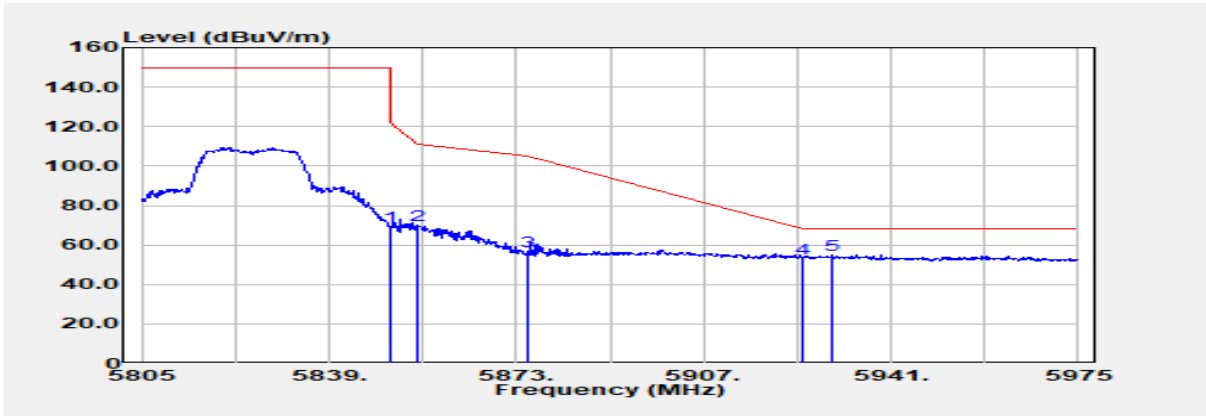

Freq. MHz	Detector Mode PK/QP/AV	Spectrum Reading Level dB $\mu$ V	Factor dB	Actual FS dB $\mu$ V/m	Limit @3m dB $\mu$ V/m	Margin dB
5850.000	Peak	71.01	-1.57	69.43	122.20	-52.77
5855.000	Peak	71.34	-1.42	69.92	110.80	-40.88
5875.000	Peak	58.46	-1.42	57.04	105.20	-48.16
5925.000	Peak	54.14	-0.99	53.15	68.20	-15.05
5930.290	Peak	55.71	-0.90	54.82	68.20	-13.38

Unless otherwise stated the results shown in this test report refer only to the sample(s) tested and such sample(s) are retained for 90 days only.

除非另有說明，此報告結果僅對測試之樣品負責，同時此樣品僅保留90天。本報告未經本公司書面許可，不可部份複製。

This document is issued by the Company subject to its General Conditions of Service printed overleaf, available on request or accessible at <http://www.sgs.com.tw/Terms-and-Conditions> and for electronic format documents, subject to Terms and Conditions for Electronic Documents at <http://www.sgs.com.tw/Terms-and-Conditions>. Attention is drawn to the limitation of liability, indemnification and jurisdiction issues defined therein. Any holder of this document is advised that information contained hereon reflects the Company's findings at the time of its intervention only and within the limits of Client's instructions, if any. The Company's sole responsibility is to its Client and this document does not exonerate parties to a transaction from exercising all their rights and obligations under the transaction documents. This document cannot be reproduced except in full, without prior written approval of the Company. Any unauthorized alteration, forgery or falsification of the content or appearance of this document is unlawful and offenders may be prosecuted to the fullest extent of the law.

Report Number	:E2/2020/B0037	Test Site	:966 Chamber D
Operation Mode	:802.11n40 / Band 1	Test Date	:2020-12-28
Test Frequency	:5190 MHz	Temp./Humi.	: 21.7/63
Test Mode	:BE CH LOW	Antenna Pol.	:Vertical
EUT Pol	:H Plan	Engineer	:Kailin Lee

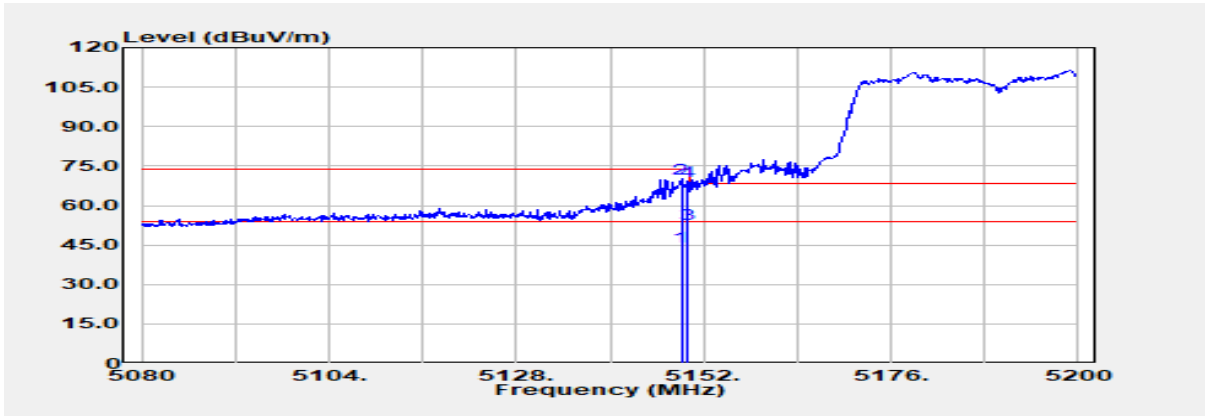

Freq. MHz	Detector Mode PK/QP/AV	Spectrum Reading Level dBuV	Factor dB	Actual FS dBuV/m	Limit @3m dBuV/m	Margin dB
5149.120	Average	46.80	-2.42	44.38	54.00	-9.62
5149.120	Peak	72.40	-2.42	69.98	74.00	-4.02
5150.000	Average	55.30	-2.43	52.87	54.00	-1.13
5150.000	Peak	71.88	-2.43	69.45	74.00	-4.55

Unless otherwise stated the results shown in this test report refer only to the sample(s) tested and such sample(s) are retained for 90 days only.

除非另有說明，此報告結果僅對測試之樣品負責，同時此樣品僅保留90天。本報告未經本公司書面許可，不可部份複製。

This document is issued by the Company subject to its General Conditions of Service printed overleaf, available on request or accessible at <http://www.sgs.com.tw/Terms-and-Conditions> and for electronic format documents, subject to Terms and Conditions for Electronic Documents at <http://www.sgs.com.tw/Terms-and-Conditions>. Attention is drawn to the limitation of liability, indemnification and jurisdiction issues defined therein. Any holder of this document is advised that information contained hereon reflects the Company's findings at the time of its intervention only and within the limits of Client's instructions, if any. The Company's sole responsibility is to its Client and this document does not exonerate parties to a transaction from exercising all their rights and obligations under the transaction documents. This document cannot be reproduced except in full, without prior written approval of the Company. Any unauthorized alteration, forgery or falsification of the content or appearance of this document is unlawful and offenders may be prosecuted to the fullest extent of the law.

Report Number	:E2/2020/B0037	Test Site	:966 Chamber D
Operation Mode	:802.11n40 / Band 1	Test Date	:2020-12-28
Test Frequency	:5190 MHz	Temp./Humi.	: 21.7/63
Test Mode	:BE CH LOW	Antenna Pol.	:Horizontal
EUT Pol	:H Plan	Engineer	:Kailin Lee

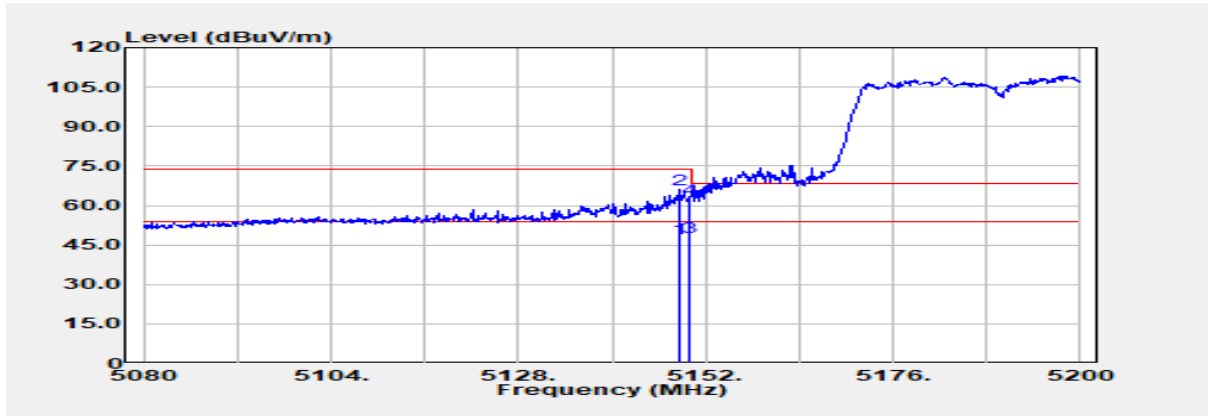

Freq. MHz	Detector Mode PK/QP/AV	Spectrum Reading Level dB $\mu$ V	Factor dB	Actual FS dB $\mu$ V/m	Limit @3m dB $\mu$ V/m	Margin dB
5148.520	Average	49.85	-2.41	47.44	54.00	-6.56
5148.520	Peak	68.41	-2.41	66.00	74.00	-8.00
5150.000	Average	50.27	-2.43	47.84	54.00	-6.16
5150.000	Peak	65.08	-2.43	62.65	74.00	-11.35

Unless otherwise stated the results shown in this test report refer only to the sample(s) tested and such sample(s) are retained for 90 days only.

除非另有說明，此報告結果僅對測試之樣品負責，同時此樣品僅保留90天。本報告未經本公司書面許可，不可部份複製。

This document is issued by the Company subject to its General Conditions of Service printed overleaf, available on request or accessible at <http://www.sgs.com.tw/Terms-and-Conditions> and for electronic format documents, subject to Terms and Conditions for Electronic Documents at <http://www.sgs.com.tw/Terms-and-Conditions>. Attention is drawn to the limitation of liability, indemnification and jurisdiction issues defined therein. Any holder of this document is advised that information contained hereon reflects the Company's findings at the time of its intervention only and within the limits of Client's instructions, if any. The Company's sole responsibility is to its Client and this document does not exonerate parties to a transaction from exercising all their rights and obligations under the transaction documents. This document cannot be reproduced except in full, without prior written approval of the Company. Any unauthorized alteration, forgery or falsification of the content or appearance of this document is unlawful and offenders may be prosecuted to the fullest extent of the law.

Report Number	:E2/2020/B0037	Test Site	:966 Chamber D
Operation Mode	:802.11n40 / Band 4	Test Date	:2021-01-08
Test Frequency	:5755 MHz	Temp./Humi.	: 20.2/60
Test Mode	:BE CH LOW	Antenna Pol.	:Vertical
EUT Pol	:H Plan	Engineer	:Kailin Lee

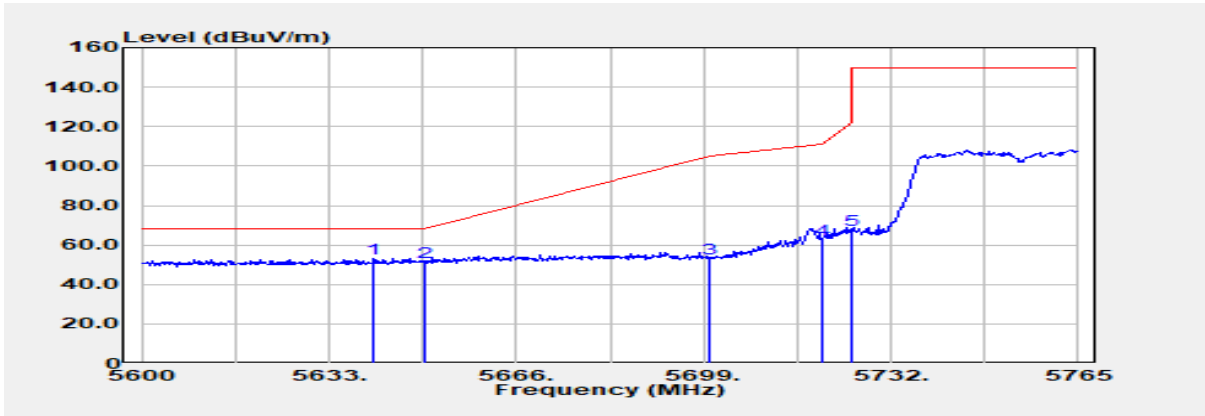

Freq. MHz	Detector Mode PK/QP/AV	Spectrum Reading Level dBuV	Factor dB	Actual FS dBuV/m	Limit @3m dBuV/m	Margin dB
5640.920	Peak	55.16	-2.14	53.02	68.20	-15.18
5650.000	Peak	53.59	-2.00	51.59	68.20	-16.61
5700.000	Peak	55.25	-2.17	53.08	105.20	-52.12
5720.000	Peak	64.38	-1.70	62.69	110.80	-48.11
5725.070	Peak	69.44	-1.98	67.46	150.00	-82.54

Unless otherwise stated the results shown in this test report refer only to the sample(s) tested and such sample(s) are retained for 90 days only.

除非另有說明，此報告結果僅對測試之樣品負責，同時此樣品僅保留90天。本報告未經本公司書面許可，不可部份複製。

This document is issued by the Company subject to its General Conditions of Service printed overleaf, available on request or accessible at <http://www.sgs.com.tw/Terms-and-Conditions> and for electronic format documents, subject to Terms and Conditions for Electronic Documents at <http://www.sgs.com.tw/Terms-and-Conditions>. Attention is drawn to the limitation of liability, indemnification and jurisdiction issues defined therein. Any holder of this document is advised that information contained hereon reflects the Company's findings at the time of its intervention only and within the limits of Client's instructions, if any. The Company's sole responsibility is to its Client and this document does not exonerate parties to a transaction from exercising all their rights and obligations under the transaction documents. This document cannot be reproduced except in full, without prior written approval of the Company. Any unauthorized alteration, forgery or falsification of the content or appearance of this document is unlawful and offenders may be prosecuted to the fullest extent of the law.



Report Number	:E2/2020/B0037	Test Site	:966 Chamber D
Operation Mode	:802.11n40 / Band 4	Test Date	:2021-01-08
Test Frequency	:5755 MHz	Temp./Humi.	: 20.2/60
Test Mode	:BE CH LOW	Antenna Pol.	:Horizontal
EUT Pol	:H Plan	Engineer	:Kailin Lee

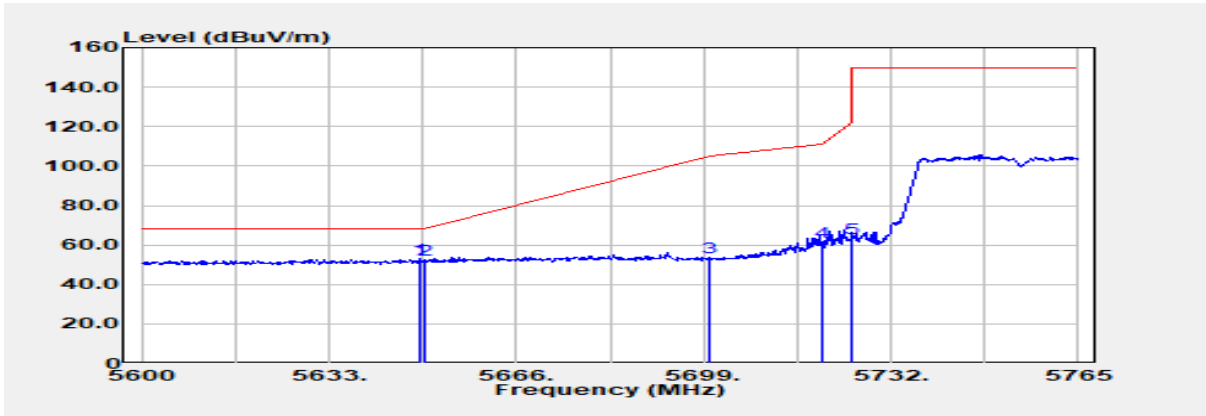

Freq. MHz	Detector Mode PK/QP/AV	Spectrum Reading Level dB $\mu$ V	Factor dB	Actual FS dB $\mu$ V/m	Limit @3m dB $\mu$ V/m	Margin dB
5648.840	Peak	54.94	-2.02	52.93	68.20	-15.27
5650.000	Peak	54.26	-2.00	52.27	68.20	-15.93
5700.000	Peak	56.09	-2.17	53.93	105.20	-51.27
5720.000	Peak	63.05	-1.70	61.35	110.80	-49.45
5725.000	Peak	65.07	-1.98	63.10	122.20	-59.10

Unless otherwise stated the results shown in this test report refer only to the sample(s) tested and such sample(s) are retained for 90 days only.

除非另有說明，此報告結果僅對測試之樣品負責，同時此樣品僅保留90天。本報告未經本公司書面許可，不可部份複製。

This document is issued by the Company subject to its General Conditions of Service printed overleaf, available on request or accessible at <http://www.sgs.com.tw/Terms-and-Conditions> and for electronic format documents, subject to Terms and Conditions for Electronic Documents at <http://www.sgs.com.tw/Terms-and-Conditions>. Attention is drawn to the limitation of liability, indemnification and jurisdiction issues defined therein. Any holder of this document is advised that information contained hereon reflects the Company's findings at the time of its intervention only and within the limits of Client's instructions, if any. The Company's sole responsibility is to its Client and this document does not exonerate parties to a transaction from exercising all their rights and obligations under the transaction documents. This document cannot be reproduced except in full, without prior written approval of the Company. Any unauthorized alteration, forgery or falsification of the content or appearance of this document is unlawful and offenders may be prosecuted to the fullest extent of the law.

Report Number	:E2/2020/B0037	Test Site	:966 Chamber D
Operation Mode	:802.11n40 / Band 4	Test Date	:2021-01-08
Test Frequency	:5795 MHz	Temp./Humi.	: 20.2/60
Test Mode	:BE CH HIGH	Antenna Pol.	:Vertical
EUT Pol	:H Plan	Engineer	:Kailin Lee

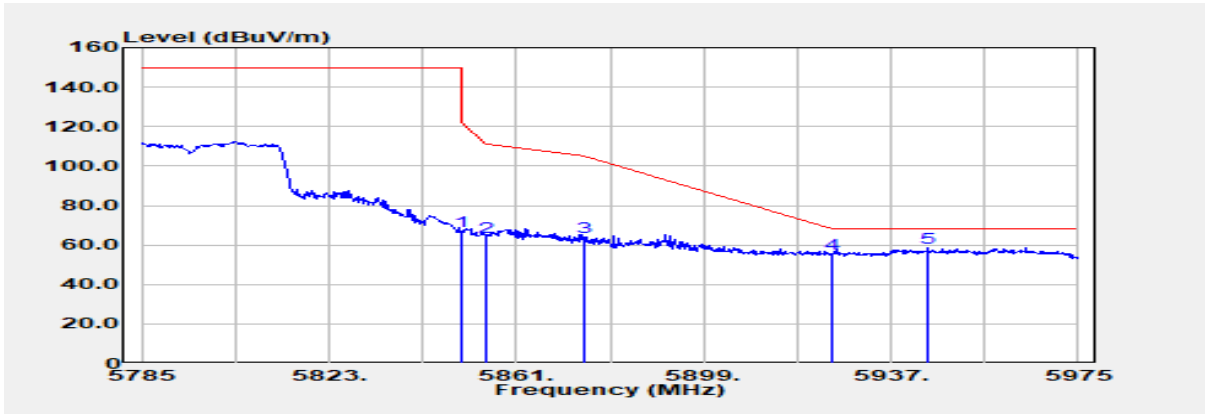

Freq. MHz	Detector Mode PK/QP/AV	Spectrum Reading Level dB $\mu$ V	Factor dB	Actual FS dB $\mu$ V/m	Limit @3m dB $\mu$ V/m	Margin dB
5850.000	Peak	68.33	-1.57	66.75	122.20	-55.45
5855.000	Peak	65.69	-1.42	64.28	110.80	-46.52
5875.000	Peak	65.70	-1.42	64.28	105.20	-40.92
5925.000	Peak	56.41	-0.99	55.42	68.20	-12.78
5944.410	Peak	59.70	-1.20	58.50	68.20	-9.70

Unless otherwise stated the results shown in this test report refer only to the sample(s) tested and such sample(s) are retained for 90 days only.

除非另有說明，此報告結果僅對測試之樣品負責，同時此樣品僅保留90天。本報告未經本公司書面許可，不可部份複製。

This document is issued by the Company subject to its General Conditions of Service printed overleaf, available on request or accessible at <http://www.sgs.com.tw/Terms-and-Conditions> and for electronic format documents, subject to Terms and Conditions for Electronic Documents at <http://www.sgs.com.tw/Terms-and-Conditions>. Attention is drawn to the limitation of liability, indemnification and jurisdiction issues defined therein. Any holder of this document is advised that information contained hereon reflects the Company's findings at the time of its intervention only and within the limits of Client's instructions, if any. The Company's sole responsibility is to its Client and this document does not exonerate parties to a transaction from exercising all their rights and obligations under the transaction documents. This document cannot be reproduced except in full, without prior written approval of the Company. Any unauthorized alteration, forgery or falsification of the content or appearance of this document is unlawful and offenders may be prosecuted to the fullest extent of the law.

Report Number	:E2/2020/B0037	Test Site	:966 Chamber D
Operation Mode	:802.11n40 / Band 4	Test Date	:2021-01-08
Test Frequency	:5795 MHz	Temp./Humi.	: 20.2/60
Test Mode	:BE CH HIGH	Antenna Pol.	:Horizontal
EUT Pol	:H Plan	Engineer	:Kailin Lee

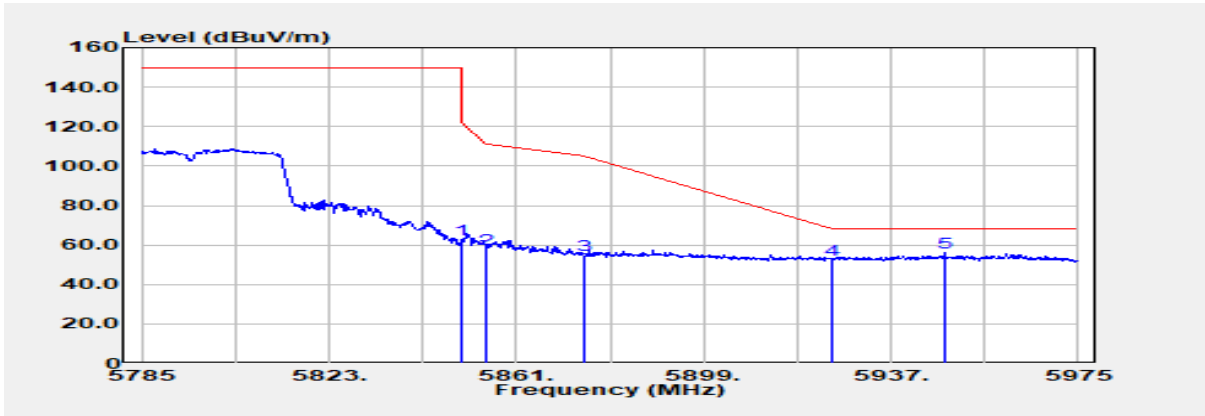

Freq. MHz	Detector Mode PK/QP/AV	Spectrum Reading Level dB $\mu$ V	Factor dB	Actual FS dB $\mu$ V/m	Limit @3m dB $\mu$ V/m	Margin dB
5850.000	Peak	64.39	-1.57	62.82	122.20	-59.38
5855.000	Peak	59.60	-1.42	58.18	110.80	-52.62
5875.000	Peak	56.48	-1.42	55.06	105.20	-50.14
5925.000	Peak	53.81	-0.99	52.82	68.20	-15.38
5947.830	Peak	57.21	-1.18	56.03	68.20	-12.17

Unless otherwise stated the results shown in this test report refer only to the sample(s) tested and such sample(s) are retained for 90 days only.

除非另有說明，此報告結果僅對測試之樣品負責，同時此樣品僅保留90天。本報告未經本公司書面許可，不可部份複製。

This document is issued by the Company subject to its General Conditions of Service printed overleaf, available on request or accessible at <http://www.sgs.com.tw/Terms-and-Conditions> and for electronic format documents, subject to Terms and Conditions for Electronic Documents at <http://www.sgs.com.tw/Terms-and-Conditions>. Attention is drawn to the limitation of liability, indemnification and jurisdiction issues defined therein. Any holder of this document is advised that information contained hereon reflects the Company's findings at the time of its intervention only and within the limits of Client's instructions, if any. The Company's sole responsibility is to its Client and this document does not exonerate parties to a transaction from exercising all their rights and obligations under the transaction documents. This document cannot be reproduced except in full, without prior written approval of the Company. Any unauthorized alteration, forgery or falsification of the content or appearance of this document is unlawful and offenders may be prosecuted to the fullest extent of the law.

Report Number	:E2/2020/B0037	Test Site	:966 Chamber D
Operation Mode	:802.11ac80 / Band 1	Test Date	:2020-12-28
Test Frequency	:5210 MHz	Temp./Humi.	:20.7/63
Test Mode	:BE CH LOW	Antenna Pol.	:Vertical
EUT Pol	:H Plan	Engineer	:Kailin Lee

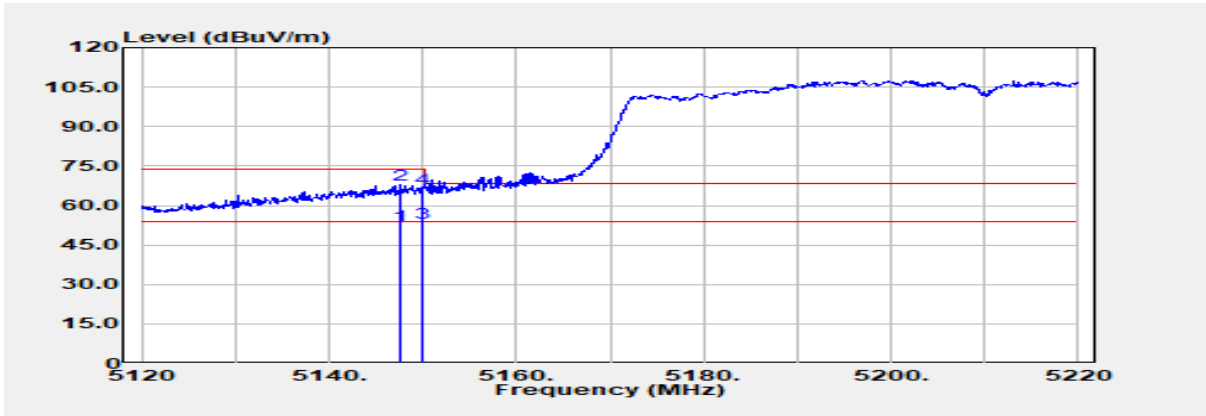

Freq. MHz	Detector Mode PK/QP/AV	Spectrum Reading Level dB $\mu$ V	Factor dB	Actual FS dB $\mu$ V/m	Limit @3m dB $\mu$ V/m	Margin dB
517.600	Average	55.13	-2.39	52.74	54.00	-1.26
517.600	Peak	70.50	-2.39	68.10	74.00	-5.90
515.000	Average	55.64	-2.43	53.21	54.00	-0.79
515.000	Peak	69.02	-2.43	66.59	74.00	-7.41

Unless otherwise stated the results shown in this test report refer only to the sample(s) tested and such sample(s) are retained for 90 days only.

除非另有說明，此報告結果僅對測試之樣品負責，同時此樣品僅保留90天。本報告未經本公司書面許可，不可部份複製。

This document is issued by the Company subject to its General Conditions of Service printed overleaf, available on request or accessible at <http://www.sgs.com.tw/Terms-and-Conditions> and for electronic format documents, subject to Terms and Conditions for Electronic Documents at <http://www.sgs.com.tw/Terms-and-Conditions>. Attention is drawn to the limitation of liability, indemnification and jurisdiction issues defined therein. Any holder of this document is advised that information contained hereon reflects the Company's findings at the time of its intervention only and within the limits of Client's instructions, if any. The Company's sole responsibility is to its Client and this document does not exonerate parties to a transaction from exercising all their rights and obligations under the transaction documents. This document cannot be reproduced except in full, without prior written approval of the Company. Any unauthorized alteration, forgery or falsification of the content or appearance of this document is unlawful and offenders may be prosecuted to the fullest extent of the law.

Report Number	:E2/2020/B0037	Test Site	:966 Chamber D
Operation Mode	:802.11ac80 / Band 1	Test Date	:2020-12-28
Test Frequency	:5210 MHz	Temp./Humi.	: 20.7/63
Test Mode	:BE CH LOW	Antenna Pol.	:Horizontal
EUT Pol	:H Plan	Engineer	:Kailin Lee

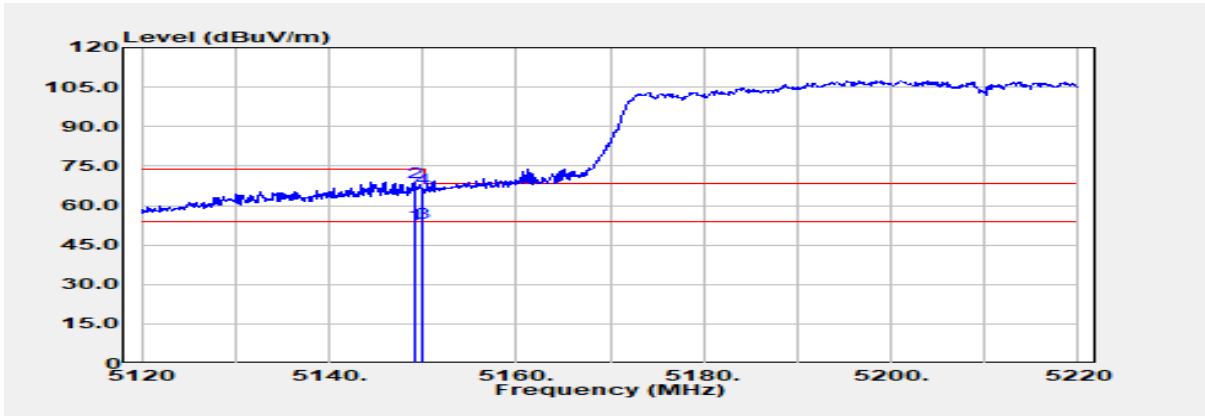

Freq. MHz	Detector Mode PK/QP/AV	Spectrum Reading Level dBuV	Factor dB	Actual FS dBuV/m	Limit @3m dBuV/m	Margin dB
5149.300	Average	55.59	-2.42	53.17	54.00	-0.83
5149.300	Peak	71.40	-2.42	68.98	74.00	-5.02
5150.000	Average	55.70	-2.43	53.27	54.00	-0.73
5150.000	Peak	68.84	-2.43	66.41	74.00	-7.59

Unless otherwise stated the results shown in this test report refer only to the sample(s) tested and such sample(s) are retained for 90 days only.

除非另有說明，此報告結果僅對測試之樣品負責，同時此樣品僅保留90天。本報告未經本公司書面許可，不可部份複製。

This document is issued by the Company subject to its General Conditions of Service printed overleaf, available on request or accessible at <http://www.sgs.com.tw/Terms-and-Conditions> and for electronic format documents, subject to Terms and Conditions for Electronic Documents at <http://www.sgs.com.tw/Terms-and-Conditions>. Attention is drawn to the limitation of liability, indemnification and jurisdiction issues defined therein. Any holder of this document is advised that information contained hereon reflects the Company's findings at the time of its intervention only and within the limits of Client's instructions, if any. The Company's sole responsibility is to its Client and this document does not exonerate parties to a transaction from exercising all their rights and obligations under the transaction documents. This document cannot be reproduced except in full, without prior written approval of the Company. Any unauthorized alteration, forgery or falsification of the content or appearance of this document is unlawful and offenders may be prosecuted to the fullest extent of the law.

Report Number :E2/2020/B0037  
 Operation Mode :802.11ac80 / Band 4  
 Test Frequency :5775 MHz  
 Test Mode :BE CH LOW  
 EUT Pol :H Plan

Test Site :966 Chamber D  
 Test Date :2021-12-28  
 Temp./Humi. : 20.7/63  
 Antenna Pol. :Vertical  
 Engineer :Kailin Lee

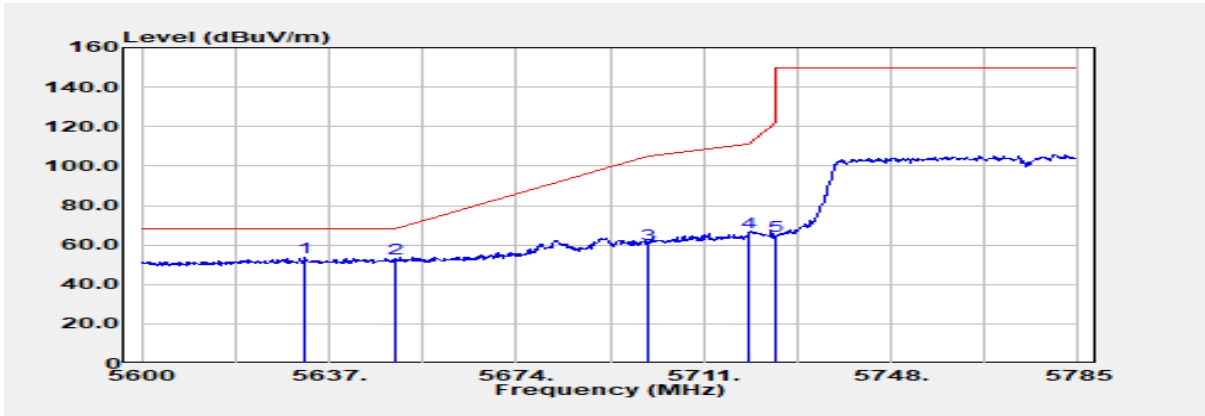

Freq. MHz	Detector Mode PK/QP/AV	Spectrum Reading Level dBuV	Factor dB	Actual FS dBuV/m	Limit @3m dBuV/m	Margin dB
5632.375	Peak	55.59	-2.02	53.57	68.20	-14.63
5650.000	Peak	55.06	-2.00	53.06	68.20	-15.14
5700.000	Peak	62.77	-2.17	60.60	105.20	-44.60
5720.000	Peak	68.09	-1.70	66.39	110.80	-44.41
5725.000	Peak	66.45	-1.98	64.48	122.20	-57.72

Unless otherwise stated the results shown in this test report refer only to the sample(s) tested and such sample(s) are retained for 90 days only.

除非另有說明，此報告結果僅對測試之樣品負責，同時此樣品僅保留90天。本報告未經本公司書面許可，不可部份複製。

This document is issued by the Company subject to its General Conditions of Service printed overleaf, available on request or accessible at <http://www.sgs.com.tw/Terms-and-Conditions> and for electronic format documents, subject to Terms and Conditions for Electronic Documents at <http://www.sgs.com.tw/Terms-and-Conditions>. Attention is drawn to the limitation of liability, indemnification and jurisdiction issues defined therein. Any holder of this document is advised that information contained hereon reflects the Company's findings at the time of its intervention only and within the limits of Client's instructions, if any. The Company's sole responsibility is to its Client and this document does not exonerate parties to a transaction from exercising all their rights and obligations under the transaction documents. This document cannot be reproduced except in full, without prior written approval of the Company. Any unauthorized alteration, forgery or falsification of the content or appearance of this document is unlawful and offenders may be prosecuted to the fullest extent of the law.

Report Number :E2/2020/B0037  
 Operation Mode :802.11ac80 / Band 4  
 Test Frequency :5775 MHz  
 Test Mode :BE CH LOW  
 EUT Pol :H Plan

Test Site :966 Chamber D  
 Test Date :2021-12-28  
 Temp./Humi. : 20.7/63  
 Antenna Pol. :Horizontal  
 Engineer :Kailin Lee

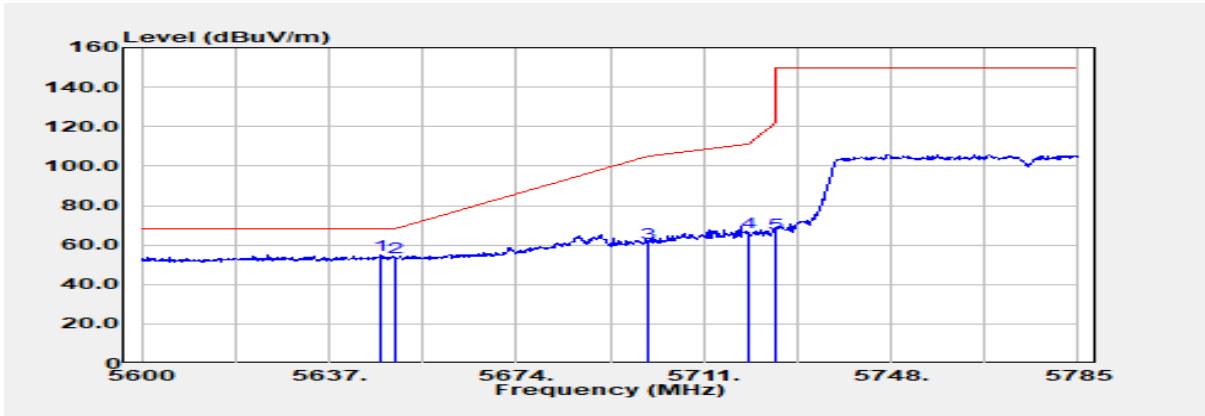

Freq. MHz	Detector Mode PK/QP/AV	Spectrum Reading Level dBuV	Factor dB	Actual FS dBuV/m	Limit @3m dBuV/m	Margin dB
5647.175	Peak	56.94	-2.04	54.89	68.20	-13.31
5650.000	Peak	55.93	-2.00	53.93	68.20	-14.27
5700.000	Peak	62.93	-2.17	60.76	105.20	-44.44
5720.000	Peak	68.35	-1.70	66.65	110.80	-44.15
5725.060	Peak	67.90	-1.98	65.92	150.00	-84.08

Unless otherwise stated the results shown in this test report refer only to the sample(s) tested and such sample(s) are retained for 90 days only.

除非另有說明，此報告結果僅對測試之樣品負責，同時此樣品僅保留90天。本報告未經本公司書面許可，不可部份複製。

This document is issued by the Company subject to its General Conditions of Service printed overleaf, available on request or accessible at <http://www.sgs.com.tw/Terms-and-Conditions> and for electronic format documents, subject to Terms and Conditions for Electronic Documents at <http://www.sgs.com.tw/Terms-and-Conditions>. Attention is drawn to the limitation of liability, indemnification and jurisdiction issues defined therein. Any holder of this document is advised that information contained hereon reflects the Company's findings at the time of its intervention only and within the limits of Client's instructions, if any. The Company's sole responsibility is to its Client and this document does not exonerate parties to a transaction from exercising all their rights and obligations under the transaction documents. This document cannot be reproduced except in full, without prior written approval of the Company. Any unauthorized alteration, forgery or falsification of the content or appearance of this document is unlawful and offenders may be prosecuted to the fullest extent of the law.

Report Number	:E2/2020/B0037	Test Site	:966 Chamber D
Operation Mode	:802.11ac80 / Band 4	Test Date	:2021-12-28
Test Frequency	:5775 MHz	Temp./Humi.	: 20.7/63
Test Mode	:BE CH HIGH	Antenna Pol.	:Vertical
EUT Pol	:H Plan	Engineer	:Kailin Lee

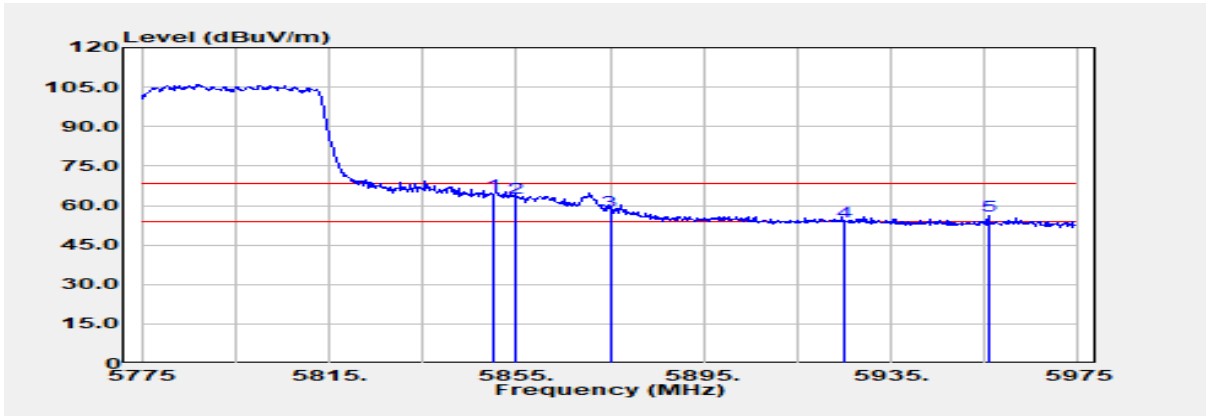

Freq. MHz	Detector Mode PK/QP/AV	Spectrum Reading Level dBuV	Factor dB	Actual FS dBuV/m	Limit @3m dBuV/m	Margin dB
5850.000	Peak	65.91	-1.57	64.34	68.20	-3.86
5855.000	Peak	64.28	-1.42	62.86	68.20	-5.34
5875.000	Peak	59.45	-1.42	58.02	68.20	-10.18
5925.000	Peak	54.67	-0.99	53.67	68.20	-14.53
5955.800	Peak	56.93	-0.90	56.03	68.20	-12.17

Unless otherwise stated the results shown in this test report refer only to the sample(s) tested and such sample(s) are retained for 90 days only.

除非另有說明，此報告結果僅對測試之樣品負責，同時此樣品僅保留90天。本報告未經本公司書面許可，不可部份複製。

This document is issued by the Company subject to its General Conditions of Service printed overleaf, available on request or accessible at <http://www.sgs.com.tw/Terms-and-Conditions> and for electronic format documents, subject to Terms and Conditions for Electronic Documents at <http://www.sgs.com.tw/Terms-and-Conditions>. Attention is drawn to the limitation of liability, indemnification and jurisdiction issues defined therein. Any holder of this document is advised that information contained hereon reflects the Company's findings at the time of its intervention only and within the limits of Client's instructions, if any. The Company's sole responsibility is to its Client and this document does not exonerate parties to a transaction from exercising all their rights and obligations under the transaction documents. This document cannot be reproduced except in full, without prior written approval of the Company. Any unauthorized alteration, forgery or falsification of the content or appearance of this document is unlawful and offenders may be prosecuted to the fullest extent of the law.



Report Number	:E2/2020/B0037	Test Site	:966 Chamber D
Operation Mode	:802.11ac80 / Band 4	Test Date	:2021-01-08
Test Frequency	:5775 MHz	Temp./Humi.	: 20.2/60
Test Mode	:BE CH HIGH	Antenna Pol.	:Horizontal
EUT Pol	:H Plan	Engineer	:Kailin Lee

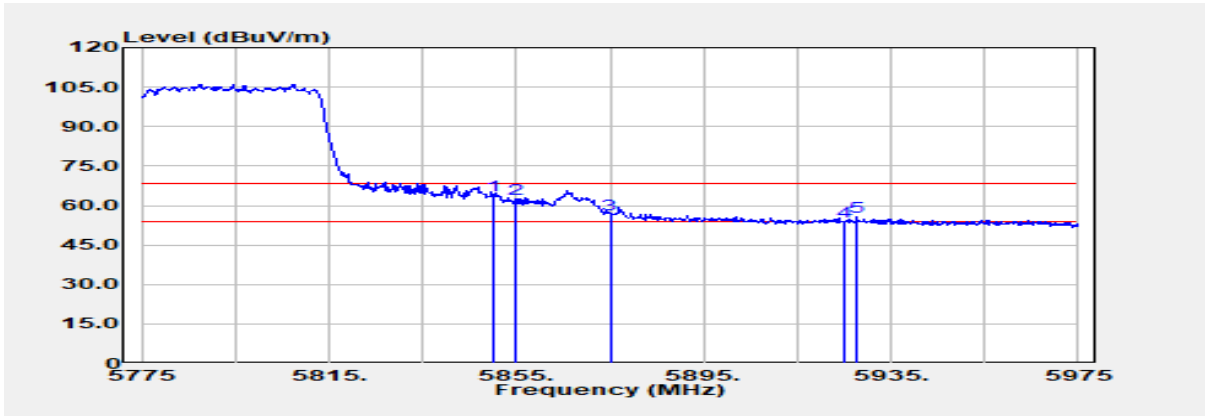

Freq. MHz	Detector Mode PK/QP/AV	Spectrum Reading Level dB $\mu$ V	Factor dB	Actual FS dB $\mu$ V/m	Limit @3m dB $\mu$ V/m	Margin dB
5850.000	Peak	65.57	-1.57	64.00	68.20	-4.20
5855.000	Peak	63.79	-1.42	62.37	68.20	-5.83
5875.000	Peak	58.24	-1.42	56.82	68.20	-11.38
5925.000	Peak	54.74	-0.99	53.75	68.20	-14.45
5927.600	Peak	56.45	-0.94	55.51	68.20	-12.69

Unless otherwise stated the results shown in this test report refer only to the sample(s) tested and such sample(s) are retained for 90 days only.

除非另有說明，此報告結果僅對測試之樣品負責，同時此樣品僅保留90天。本報告未經本公司書面許可，不可部份複製。

This document is issued by the Company subject to its General Conditions of Service printed overleaf, available on request or accessible at <http://www.sgs.com.tw/Terms-and-Conditions> and for electronic format documents, subject to Terms and Conditions for Electronic Documents at <http://www.sgs.com.tw/Terms-and-Conditions>. Attention is drawn to the limitation of liability, indemnification and jurisdiction issues defined therein. Any holder of this document is advised that information contained hereon reflects the Company's findings at the time of its intervention only and within the limits of Client's instructions, if any. The Company's sole responsibility is to its Client and this document does not exonerate parties to a transaction from exercising all their rights and obligations under the transaction documents. This document cannot be reproduced except in full, without prior written approval of the Company. Any unauthorized alteration, forgery or falsification of the content or appearance of this document is unlawful and offenders may be prosecuted to the fullest extent of the law.

## 12 TRANSMISSION IN THE ABSENCE OF DATA

### 12.1 Standard Applicable

According to §15.407(c)

The device shall automatically discontinue transmission in case of either absence of information to transmit or operational failure. These provisions are not intended to preclude the transmission of control or signaling information or the use of repetitive codes used by certain digital technologies to complete frame or burst intervals. Applicants shall include in their application for equipment authorization a description of how this requirement is met.

### 12.2 Result

While the EUT is not transmitting any information, the EUT can automatically discontinue transmission and become standby mode for power saving. The EUT can detect the controlling signal of ASK message transmitting from remote device and verify whether it shall resend or discontinue transmission.

Unless otherwise stated the results shown in this test report refer only to the sample(s) tested and such sample(s) are retained for 90 days only.

除非另有說明，此報告結果僅對測試之樣品負責，同時此樣品僅保留90天。本報告未經本公司書面許可，不可部份複製。

This document is issued by the Company subject to its General Conditions of Service printed overleaf, available on request or accessible at <http://www.sgs.com.tw/Terms-and-Conditions> and for electronic format documents, subject to Terms and Conditions for Electronic Documents at <http://www.sgs.com.tw/Terms-and-Conditions>. Attention is drawn to the limitation of liability, indemnification and jurisdiction issues defined therein. Any holder of this document is advised that information contained hereon reflects the Company's findings at the time of its intervention only and within the limits of Client's instructions, if any. The Company's sole responsibility is to its Client and this document does not exonerate parties to a transaction from exercising all their rights and obligations under the transaction documents. This document cannot be reproduced except in full, without prior written approval of the Company. Any unauthorized alteration, forgery or falsification of the content or appearance of this document is unlawful and offenders may be prosecuted to the fullest extent of the law.

## 13 ANTENNA REQUIREMENT

### 13.1 Standard Applicable

According to §15.203, an intentional radiator shall be designed to ensure that no antenna other than furnished by the responsible party shall be used with the device.

According to §15.407, If transmitting antennas of directional gain greater than 6 dBi are used, both the maximum conducted output power and the maximum power spectral density shall be reduced by the amount in dB that the directional gain of the antenna exceeds 6 dBi.

### 13.2 Antenna Connected Construction

The antenna is designed with unique RF connector and no consideration of replacement. Please see EUT photo for details.

*~ End of Report ~*

Unless otherwise stated the results shown in this test report refer only to the sample(s) tested and such sample(s) are retained for 90 days only.

除非另有說明，此報告結果僅對測試之樣品負責，同時此樣品僅保留90天。本報告未經本公司書面許可，不可部份複製。

This document is issued by the Company subject to its General Conditions of Service printed overleaf, available on request or accessible at <http://www.sgs.com.tw/Terms-and-Conditions> and for electronic format documents, subject to Terms and Conditions for Electronic Documents at <http://www.sgs.com.tw/Terms-and-Conditions>. Attention is drawn to the limitation of liability, indemnification and jurisdiction issues defined therein. Any holder of this document is advised that information contained hereon reflects the Company's findings at the time of its intervention only and within the limits of Client's instructions, if any. The Company's sole responsibility is to its Client and this document does not exonerate parties to a transaction from exercising all their rights and obligations under the transaction documents. This document cannot be reproduced except in full, without prior written approval of the Company. Any unauthorized alteration, forgery or falsification of the content or appearance of this document is unlawful and offenders may be prosecuted to the fullest extent of the law.