

DATE : 2008/07/18

CUSTOMER : CLEVO CO.

APPROVAL SHEET

MODEL	M735
DESCRIPTION	PIFA For Bluetooth Antenna 2.4~2.5GHZ / 5.15~5.875GHZ
SUPPLIER P/N	K05007007101
CUSTOMER P/N	6-23-7M735-010
FILE P/N	

FAVORTRON			CUSTOMER	
Manager	Supervisor	Engineer		
Dominic	Vincent	Kristy		



惠貿電子股份有限公司
FAVORTRON CO., LTD

台北縣新店市民權路 108-1 號 4F
4F, No. 108-1, Minchziuan Rd., SHzindian City,
Taipei HZsien 231, Taiwan. R.O.C

TEL: (02) 2218-2189
FAX: (02) 2218-5420
[URL: www.fvc.com.tw](http://www.fvc.com.tw)

1. DRAWING ASSEMBLY

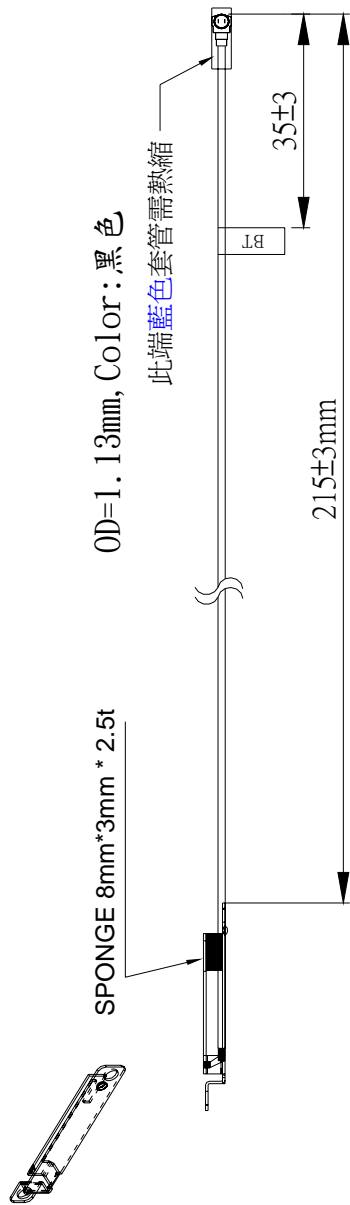

Label 1

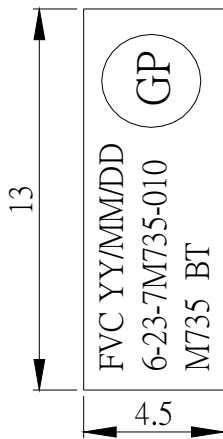

Label 2

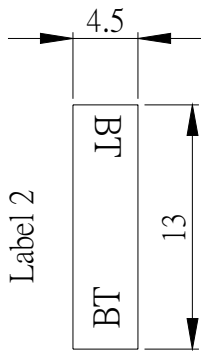

NOTES:

禁止使用1級環境管理物質，具體物質參見我司技術標準

△5			
△4			
△3			
△2			
△1			
REV	DESCRIPTION	DATE	Approval

REVISIONS



惠質電子股份有限公司
FAVORTRON CO.,LTD

備註				※未標註公差處，請參照下列標準。			
發	行	RANGE	TOLERANCE	Part No.	Check	Designed	
		OVER 101	±3.0	K05007007101			
		51-100	±2.5	TD-E-80325-A1			
		31-50	±2.0	CUS.Part No. 6-23-7M735-010			
		30 BELOW	±1.5	CUS.Rev. a1	Approval	Check	Designed
		Units mm	Scale 1:1				
		Size A4	Date 2008/07/14		Vincent	Vincent	Vincent
		Sheet 1/3	⊕				

機密
廠內專用

BOM

ITEM	COMPONENT	QTY	DESCRIPTION	FAVORTRON P/N	VENDER
1	M735T-BT-PIFA 鐵件	1	進口馬口鐵=0.4mm/H	M020007061001	品欣
2	同軸線(含接頭)	1	OD Ø 1.13mm/單頭I-PEX/242mm/黑色	M04007282001	FVC
3	SPONGE	1	8mm*3mm*1=2.5mm	M01009019002	昊泰
4	藍色熱縮套管	1	OD: .5*20mm(藍色) 3.0+0.25 /+0.05mm 壁厚0.22±0.08	B02020029121	三聯
5	LABEL	2	4.5x13mm 白色	G01013007001	亞識
6					
7					
8					
9					
10					

(M04007282001)

ITEM	COMPONENT	QTY	DESCRIPTION	FAVORTRON P/N	VENDER
1	Connector	1	接頭 MHF PLUG(I-PEX)鍍金(20278-11IR-13)	L07001001001	I-PEX
2	同軸線	1	同軸線 Ø 1.13*整捲241mm(黑色)	M04005019001	昭和



惠質電子股份有限公司
FAVORTRON CO.,LTD

Title:

M735T BT ANT BOM

Part No.	K05007007101
Draw No.	TD-E-80325-A1
CUS.Part No.	6-23-7M735-010
CUS.Rev.	a1
Approval	Check
Vincent	Vincent
Check	Designed
Vincent	Vincent

發行	備註
Date	2008/07/14
Sheet	2/3

機密

廠內專用

NOTES:

禁止使用1級環境管理物質，具體物質參見我司技術標準

鐵件

1 2 3 4 5 6

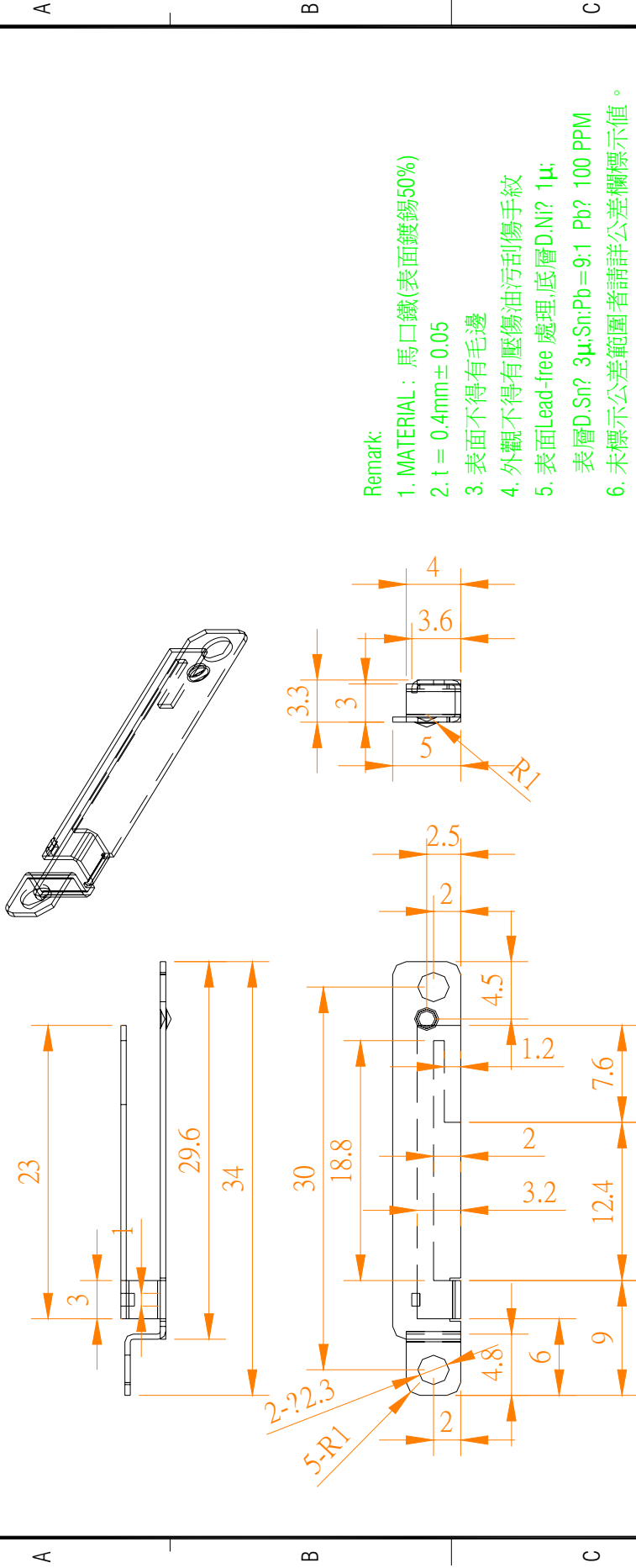

Remark:

1. MATERIAL : 馬口鐵(表面鍍錫50%)
2. t = 0.4mm ± 0.05
3. 表面不得有毛邊
4. 外觀不得有壓傷油刮傷手紋
5. 表面Lead-free 處理,底層D.Ni? 1μ; 表層D.Sn? 3μ;Sn:Pb = 9:1 Pb? 100 PPM
6. 未標示公差範圍者請詳公差欄標示值。

NOTES:

禁止使用1級環境管理物質，具體物質參見我司技術標準

⑤			
④			
③			
②			
①			
REV	DESCRIPTION	DATE	Approval
REVISIONS			

機密
廠內專用

備註 ※未標註公差處，請參照下列標準。		惠質電子股份有限公司 FAVORTRON CO.,LTD	
發行	RANGE	TOLERANCE	Title: 藍天M735T BT鐵件
	OVER 101	±0.20	Part No. M02007061001
	51-100	±0.15	FVC_Draw No. TD-E-80641-A1
	31-50	±0.10	SEL_Draw No. a1
	30 BELOW	±0.05	Approval
Units	mm	Scale	1:1
Size	A4	Date	2008/07/14
Sheet	1/1	Sheet	6
		Vincent	Vincent
		Check	Designed

1 2 3 4 5 6

1.

天線測試方法

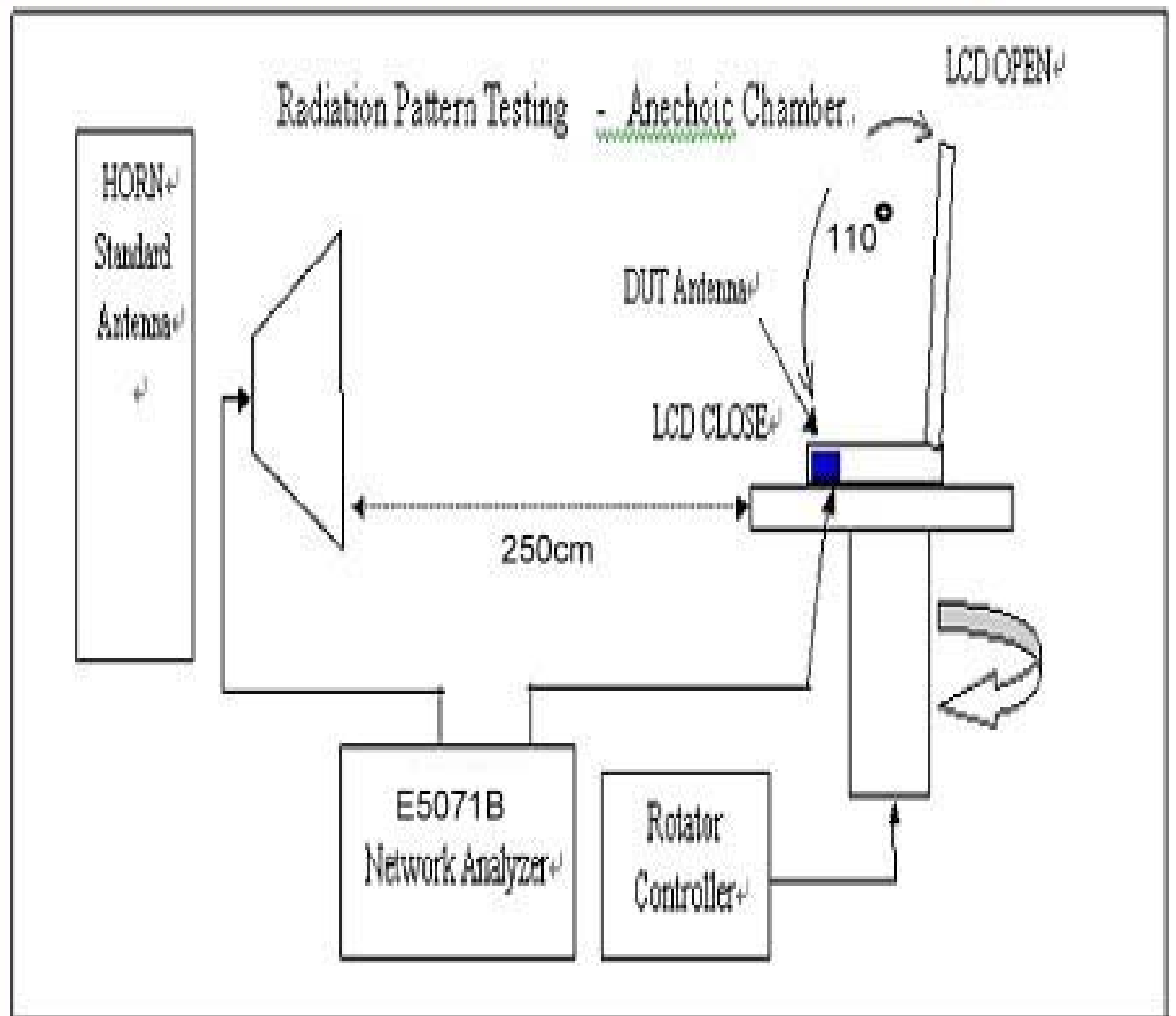

Coordinate Definition

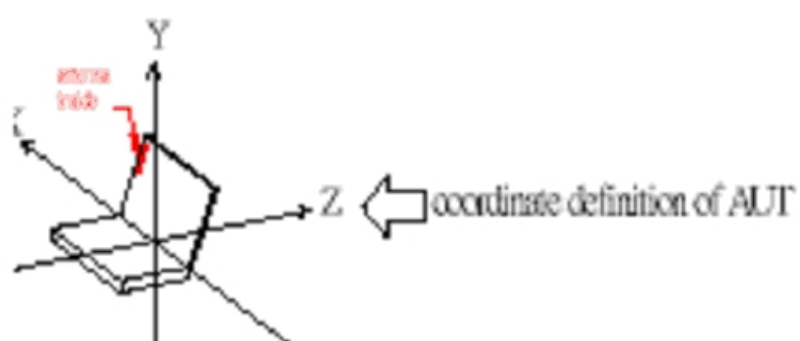

ORN ANTENNA

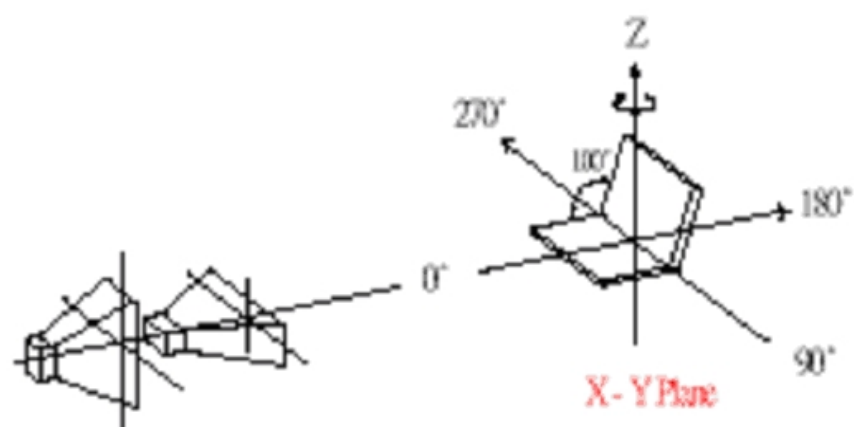
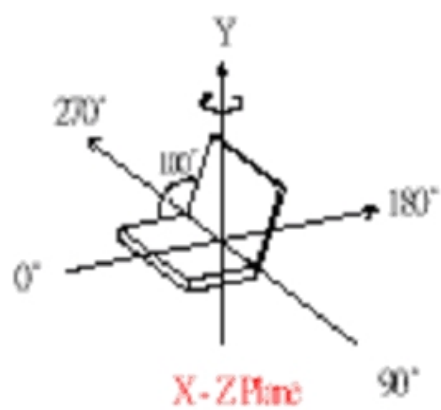

2. Bluetooth.

Model No.				
Test Mode	Ferq (MHz)	Max Gain(dBi)	Avg. Gain(dBi)	Source Polar
Bluetooth	2.4G	0.93/250	-5.64	V+H
Bluetooth	2.45G	-0.34/249	-6.25	V+H
Bluetooth	2.5G	0.34/254	-5.39	V+H

3.BT

2.4~2.5GHZ & 5.15~5.875GHZ / Return Loss

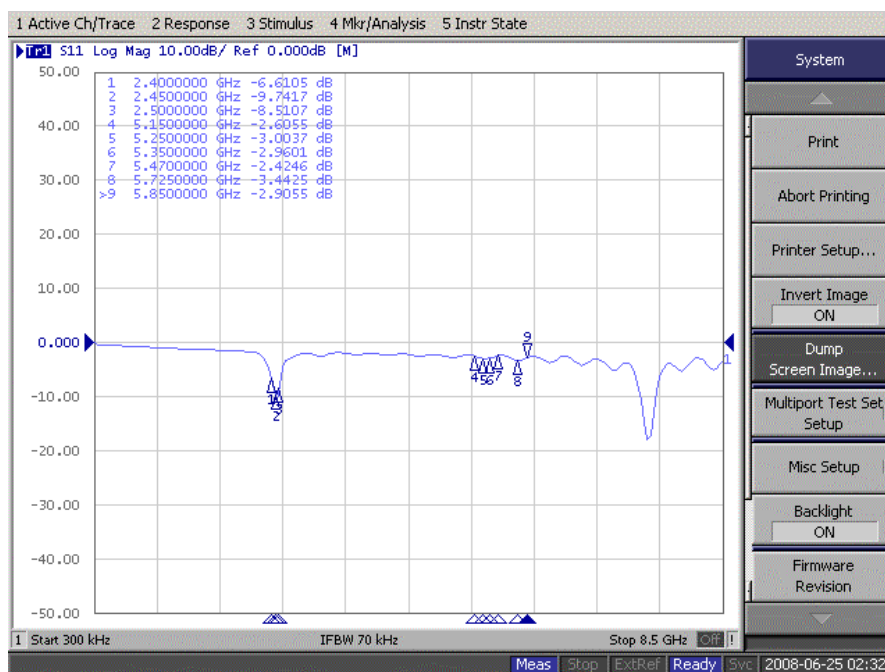

2.4~2.5GHZ & 5.15~5.875GHZ / VSWR

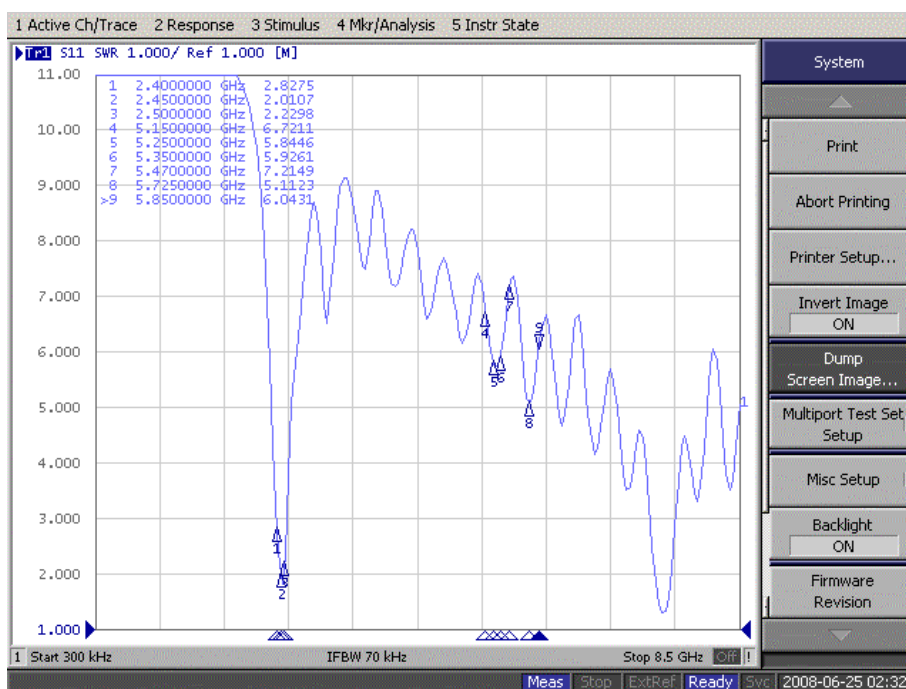

4.Gain & Pattern – BT.

a. 2.4GHz



FAVORTRON Co. Ltd

Antenna Pattern Measurement

4F, No. 108-1, Min Chuan Rd., Hsin-Tien City, Taipei, Taiwan, R.O.C. Tel:886-2-2218-2189,
Fax:886-2-2218-5760

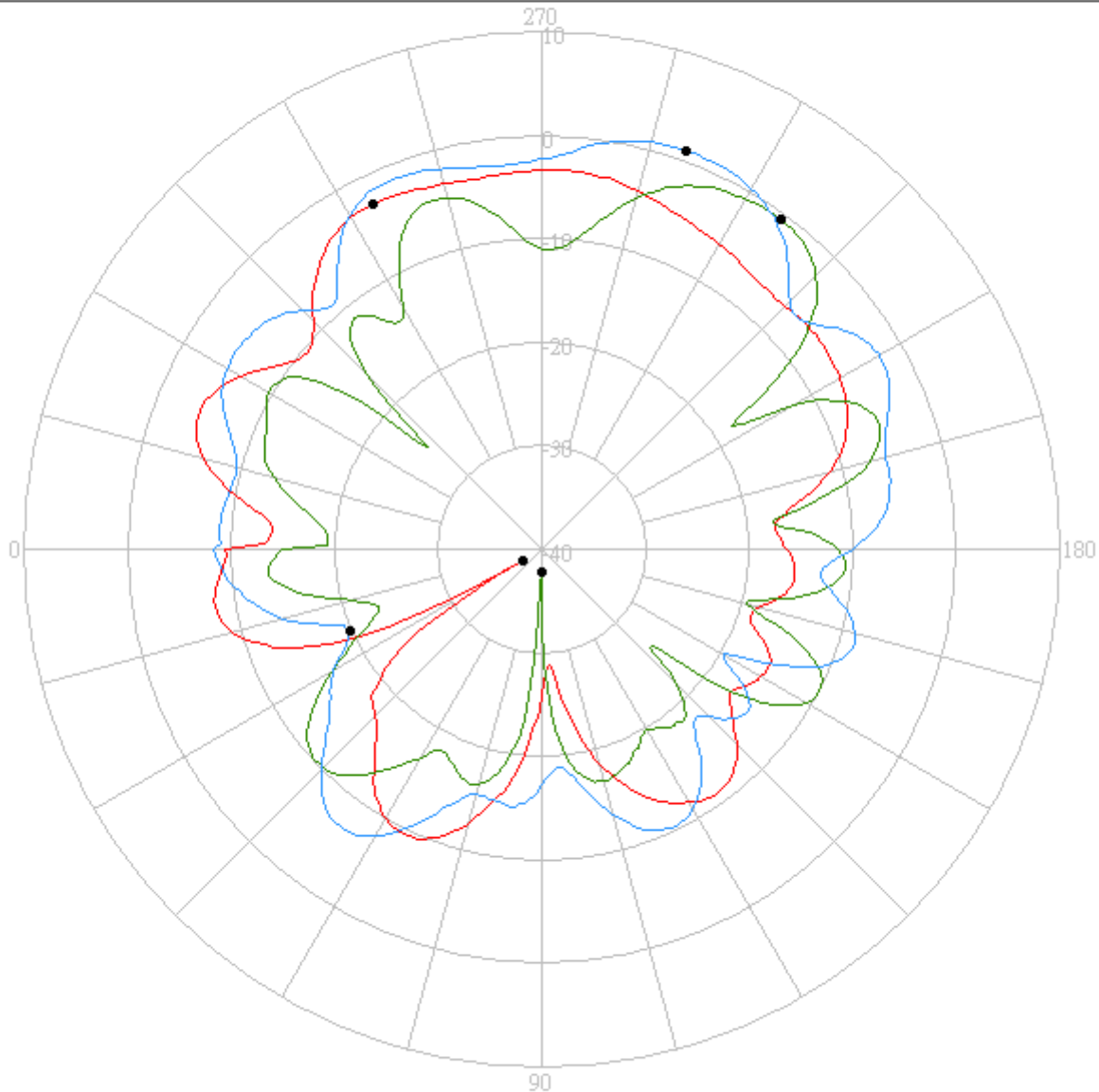

Pattern	Model No.	Test Mode	Freq(MHz)	Max Gain(dBi)	Min Gain(dBi)	Avg. Gain(dBi)	Source Polar.	Date
1	M735T	BT	2400.00	-2.91 / 296.00	-37.88 / 30.00	-8.13	Ver.	2008/6/24
2	M735T	BT	2400.00	-0.70 / 234.00	-37.78 / 89.00	-9.04	Hor.	2008/6/24
3	M735T	BT	2400.00	0.93 / 250.00	-19.85 / 23.00	-5.64	V+H	2008/6/24

b. 2.45GHz



FAVORTRON Co. Ltd

Antenna Pattern Measurement

4F, No. 108-1, Min Chuan Rd., Hsin-Tien City, Taipei, Taiwan, R.O.C. Tel:886-2-2218-2189,
Fax:886-2-2218-5760

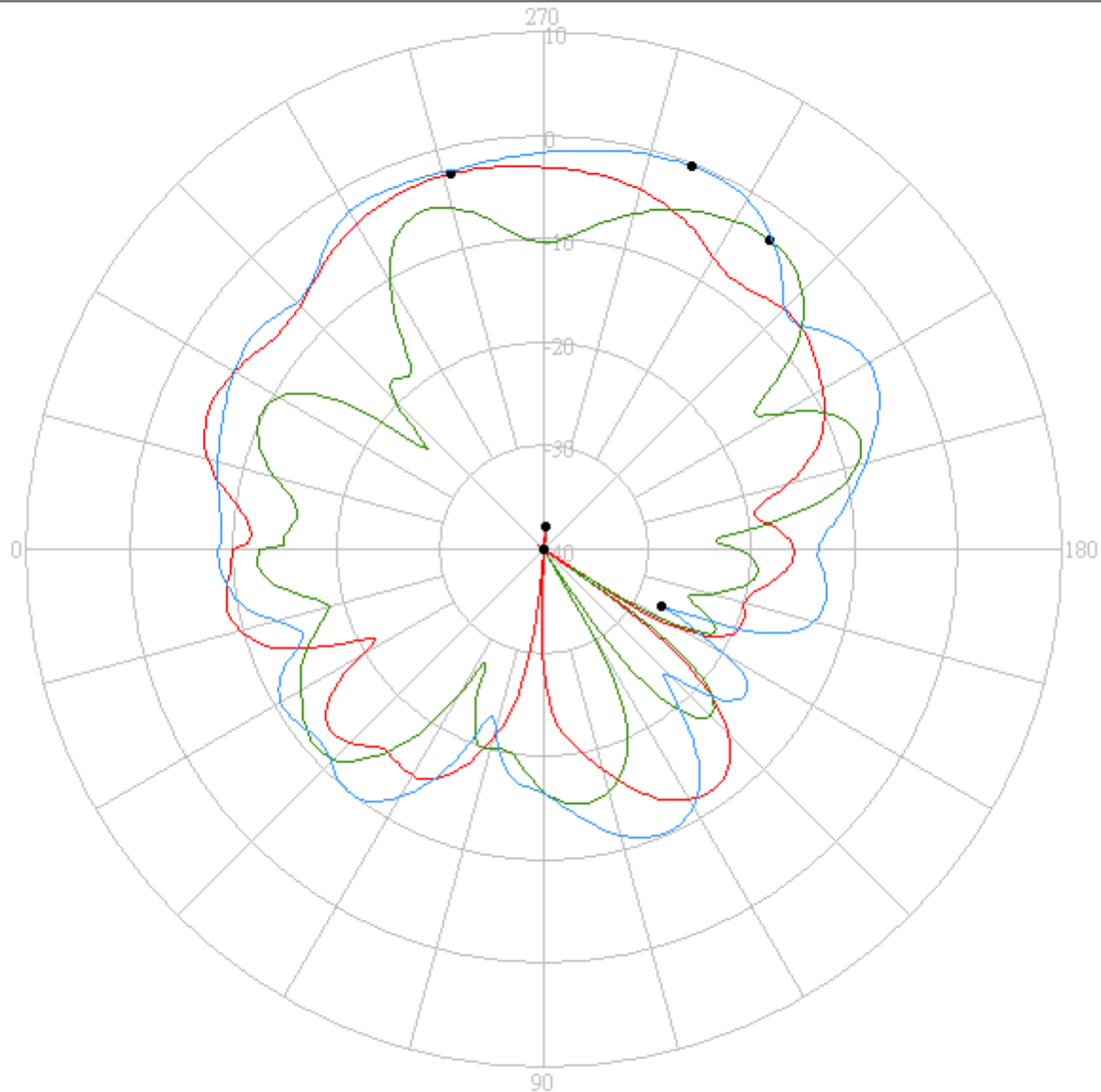

Pattern	Model No.	Test Mode	Freq(MHz)	Max Gain(dBi)	Min Gain(dBi)	Avg. Gain(dBi)	Source Polar.	Date
1	M735T	BT	2450.00	-2.66 / 284.00	-43.36 / 85.00	-8.33	Ver.	2008/6/24
2	M735T	BT	2450.00	-3.02 / 234.00	-49.20 / 122.00	-10.64	Hor.	2008/6/24
3	M735T	BT	2450.00	-0.34 / 249.00	-27.28 / 154.00	-6.25	V+H	2008/6/24

c. 2.5GHz



FAVORTRON Co. Ltd

Antenna Pattern Measurement

4F, No. 108-1, Min Chuan Rd., Hsin-Tien City, Taipei, Taiwan, R.O.C. Tel:886-2-2218-2189, Fax:886-2-2218-6760

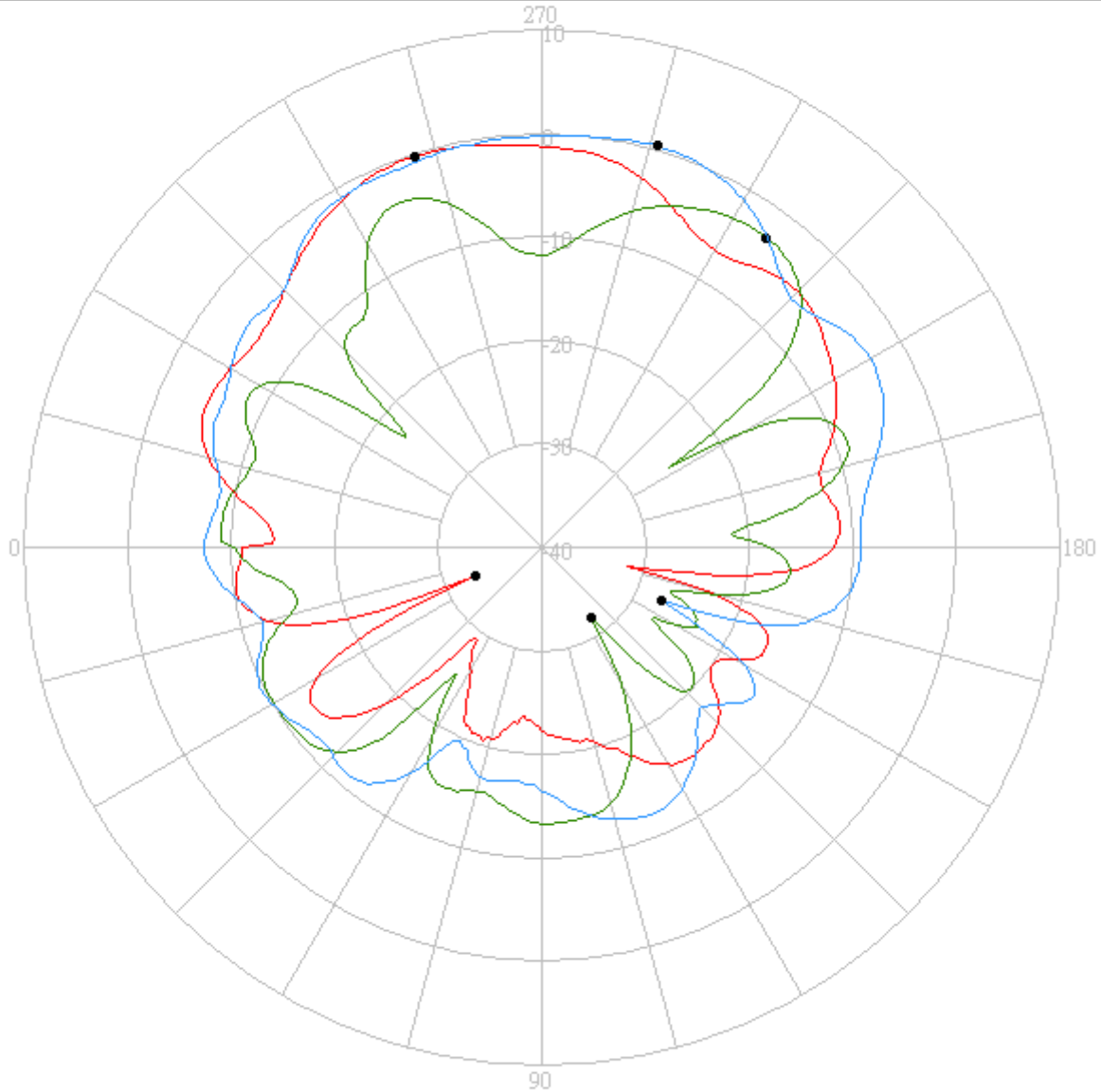

Pattern	Model No.	Test Mode	Freq(MHz)	Max Gain(dBi)	Min Gain(dBi)	Avg. Gain(dBi)	Source Polar.	Date
1	M735T	BT	2500.00	-0.28 / 288.00	-32.96 / 23.00	-6.98	Ver.	2008/6/24
2	M735T	BT	2500.00	-3.09 / 234.00	-31.65 / 125.00	-10.00	Hor.	2008/6/24
3	M735T	BT	2500.00	0.34 / 254.00	-27.28 / 156.00	-5.39	V+H	2008/6/24