

DATE : 2008/05/19

CUSTOMER : CLEVO CO.

# APPROVAL SHEET

<b>MODEL</b>	M860
<b>DESCRIPTION</b>	PIFA For Bluetooth Antenna 2.4~2.5GHZ / 5.15~5.875GHZ
<b>SUPPLIER P/N</b>	K05007006002
<b>CUSTOMER P/N</b>	6-23-7M860-051
<b>FILE P/N</b>	

FAVORTRON			CUSTOMER	
Manager	Supervisor	Engineer		
Dominic	Vincent	Kristy		



**惠貿電子股份有限公司**  
**FAVORTRON CO., LTD**

台北縣新店市民權路 108-1 號 4F  
4F, No. 108-1, Minchziuan Rd., SHzindian City,  
Taipei HZsien 231, Taiwan. R.O.C

TEL: (02) 2218-2189  
FAX: (02) 2218-5420  
[URL: www.fvc.com.tw](http://www.fvc.com.tw)

# 1. DRAWING ASSEMBLY

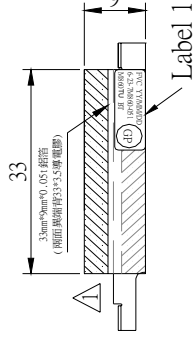
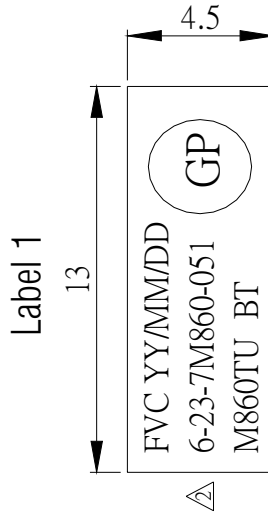
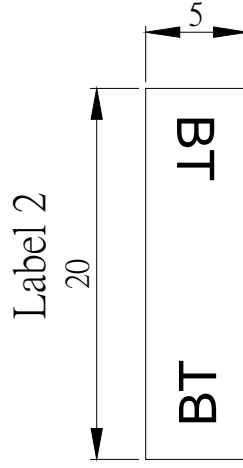
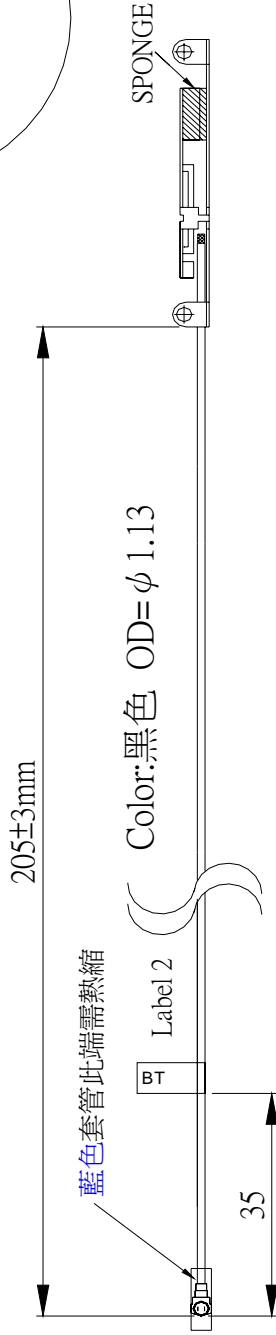
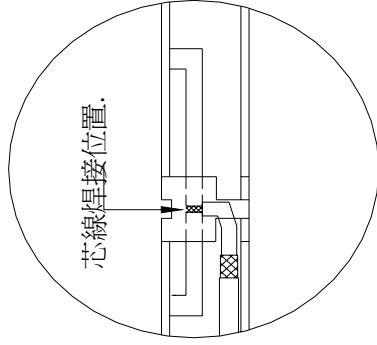

**FVC** 惠賢電子股份有限公司  
FAVORTRON CO.,LTD

備註		※未標註公差處，請參照下列標準。	
發行	RANGE	TOLERANCE	Title: M860TU Bluetooth ANT.成品圖
	OVER 101	±3.0	Part No. K05007006002
	51-100	±2.5	Draw No. TD-E-71180-A2
	31-50	±2.0	CUS.Part No. 6-23-7M860-051 △
	30 BELOW	±1.5	CUS.Rev. A2
Units	mm	Scale	1:1
Size	A4	Date	2008/05/19
Sheet	1/3	Check	Vincent
		Approval	Vincent
		Designed	Vincent

機密  
廠內專用

NOTES:  
禁止使用1級環境管理物質，具體物質參見我司技術標準

REV	DESCRIPTION	DATE	Approval
△1			
△2			
△3			
△4	客供料號6-23-7M860-050變更為6-23-7M860-051	08/05/19	鄒永冬
△5	導電鋁箔33*10*0.05mm變更為33*9*0.05mm	08/05/19	鄒永冬
REV	DESCRIPTION	DATE	Approval

REVISIONS

# BOM

## BOM

ITEM	COMPONENT	Q'TY	DESCRIPTION	FAVORTRON P/N	VENDER
1	M540G-LEFT- PIFA 鐵件	1	進口馬口鐵t=0.4mm/H	M02007003001	品欣
2	同軸線(含接頭)	1	OD1.13mm/單頭I-PEX/224mm/黑色	<b>M04007247001</b>	FVC
3	SPONGE	1	8mm*3mm*t=3.5mm	M01009001002	昊泰
4	藍色熱縮套管	1	OD2.5*20mm(藍色)3.0+0.2/-0 mm壁厚0.22±0.08	B02020029121	三聯
5	導電鉛箔	1	3.3mm*9mm*0.05t鉛箔(兩面異端背3*3.5導電膠)	M01005108002	強宇
6	LABEL	2	4.5x13mm 白色	G01013007001	亞識
7					
8					
9					
10					
11					
12					



### SUB BOM (M04007247001)

ITEM	COMPONENT	Q'TY	DESCRIPTION	FAVORTRON P/N	VENDER
1	Connector	1	接頭 MHF PLUG(I-PEX)鍍金(20278-111R-13)	L07001001001	I-PEX
2	同軸線	1	同軸線OD1.13*整捲223(黑色)	M04005019001	昭和



惠賢電子股份有限公司  
FAVORTRON CO.,LTD

Title:

M860TU Bluetooth ANT BOM 表

Part No. K05007006002

Draw No. TD-E-71180-A2

CUS.Part No. 6-23-7M860-051

CUS.Rev. A2

Approval Check Designed

Vincent Vincent Vincent

發行 備註

機密

廠內專用

NOTES:

禁止使用1級環境管理物質，具體物質參見我司技術標準

Date 2008/05/19 Sheet 2/3

# 鐵件

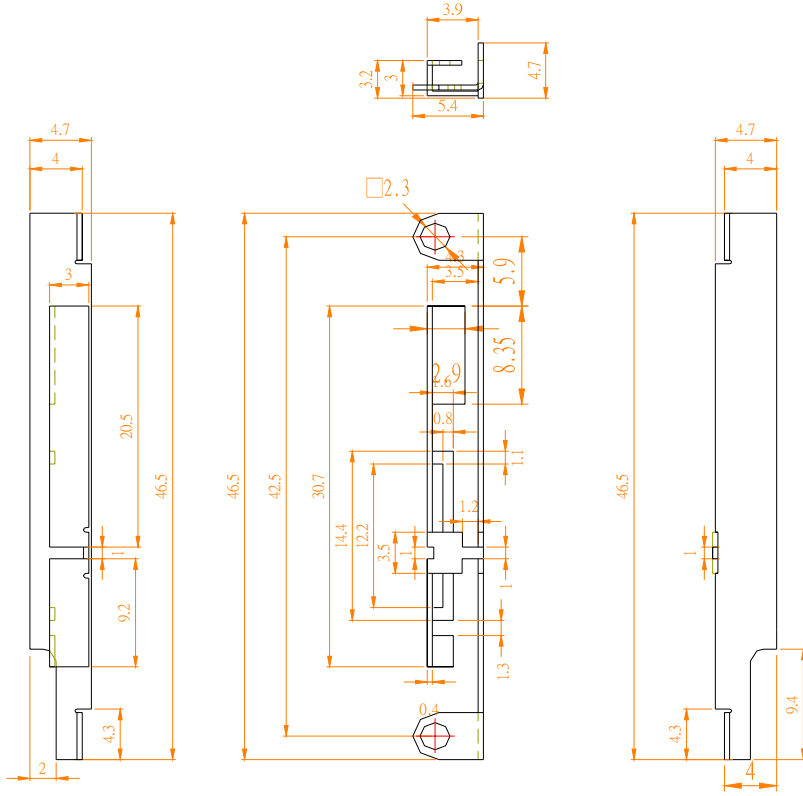

Remark:

1. MATERIAL : 馬口鐵
2. t = 0.4mm ±0.05
3. 表面不得有毛邊
4. 外觀不得有壓傷油污刮傷手紋
5. 未標示公差範圍者請詳公差欄標示值。



 惠賢電子股份有限公司  
 FAVORTRON CO.,LTD.

備註: ※未標註公差處, 請參照下列標準。

發 行		RANGE	TOLERANCE	PART NO.	TITLE:	
Units	MM	Over 101	±1.5	M02007003001	藍天M540G-LEFT-PIFA	
Size	A4	51-100	±1.0	DRAW NO.	TD-E-50657-A1	
Sheet	PAGE	31-50	±0.3	Customer No.		
		30 Below	±0.2	Customer REV.		
				APPROVAL	CHECKED	DRAWED
				Rev. A0		
				Scale 1:1		
					James	Kelly
					Nick	

1.

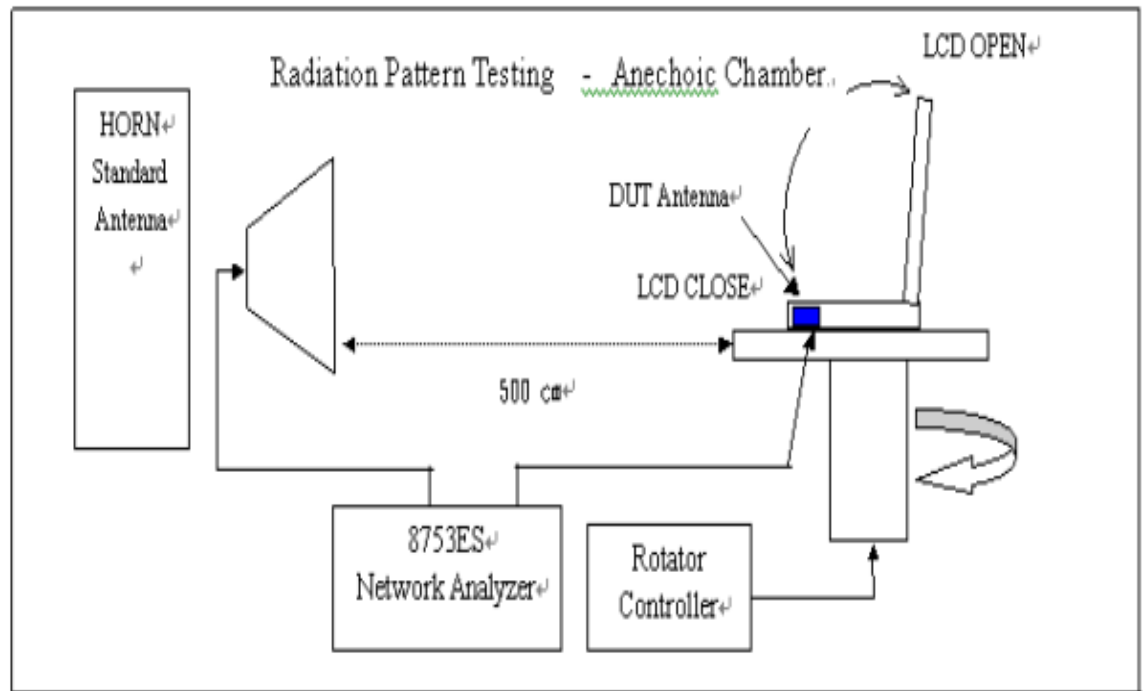
## 天線測試方法



## Coordinate Definition

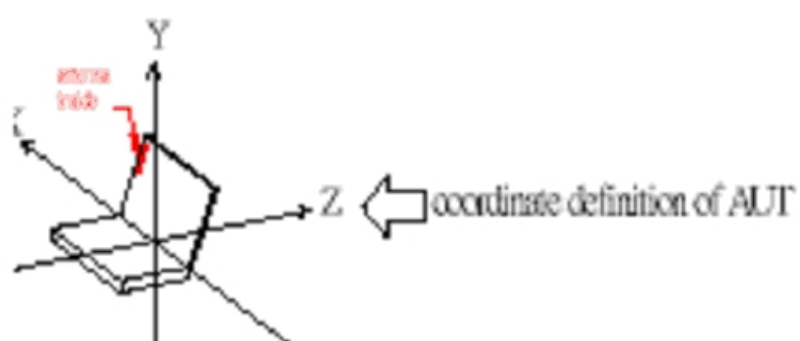

### **ORN ANTENNA**

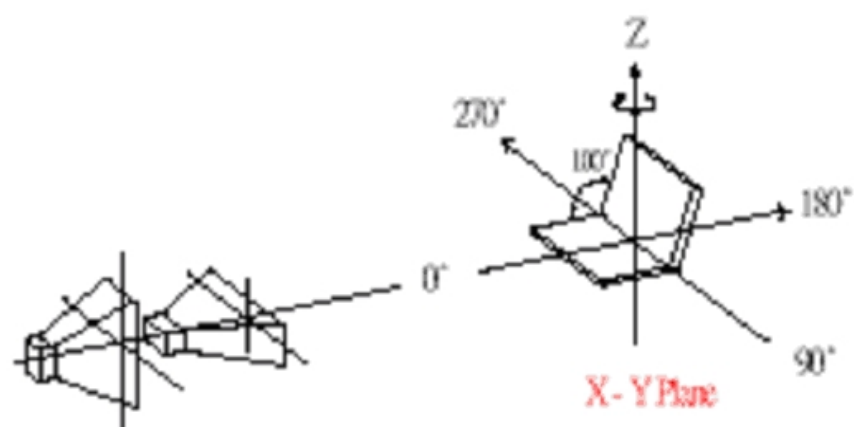
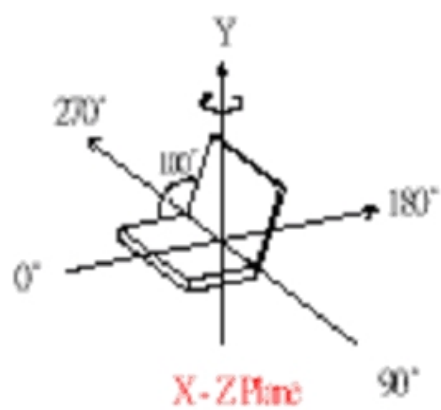

## 2. Bluetooth.

Model No.				
Test Mode	Ferq (MHz)	Max Gain(dBi)	Avg. Gain(dBi)	Source Polar
Bluetooth	2.4G	-1.39/81	-4.93	V+H
Bluetooth	2.45G	-1.05/66	-5.22	V+H
Bluetooth	2.5G	-0.25/67	-4.72	V+H

### 3.BT.

## 2.4~2.5GHZ & 5.15~5.875GHZ / Return Loss

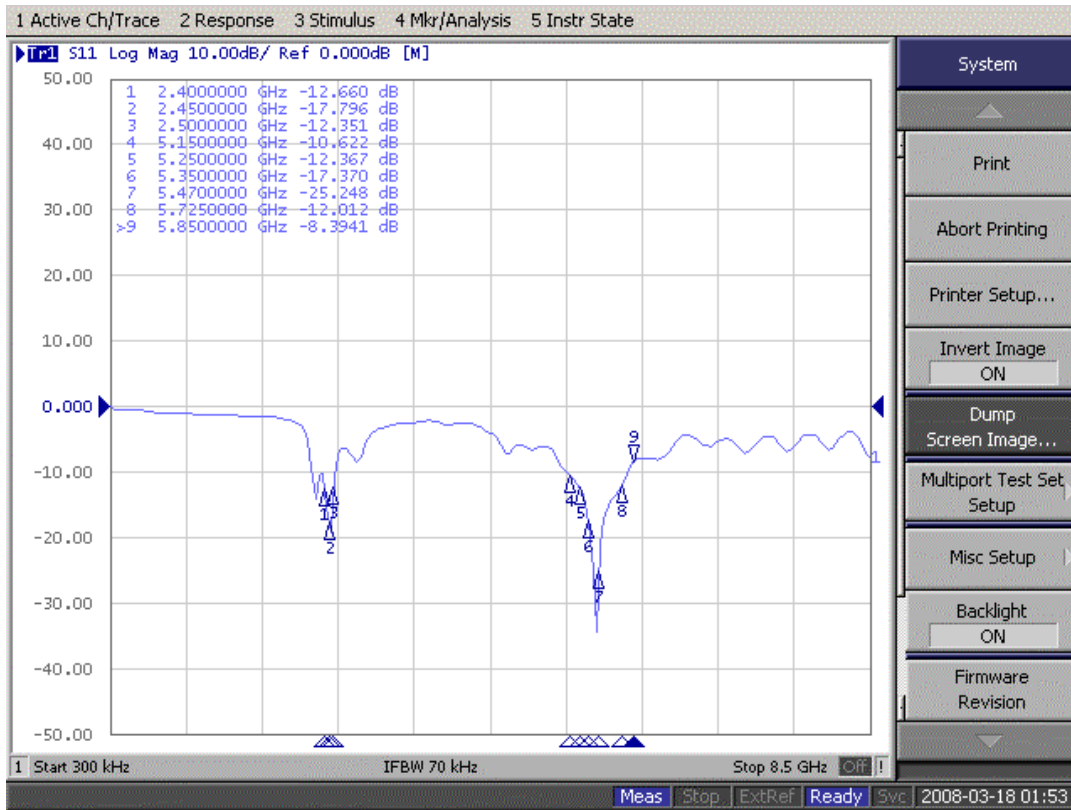

## 2.4~2.5GHZ & 5.15~5.875GHZ / VSWR

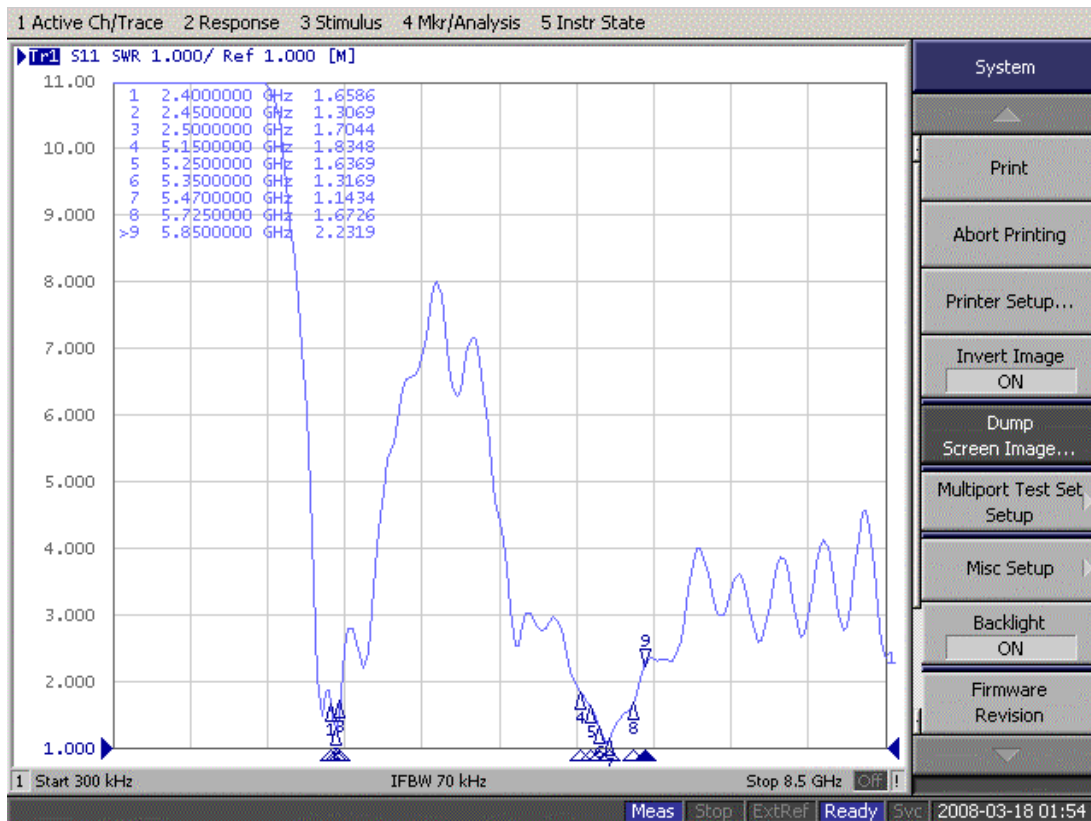



## 4.Gain & Pattern – BT.

### a. 2.4GHz



**FAVORTRON Co. Ltd**

## Antenna Pattern Measurement

4F, No. 108-1, Min Chuan Rd., Hsin-Tien City, Taipei, Taiwan, R.O.C. Tel:886-2-2218-2189,  
Fax:886-2-2218-5760

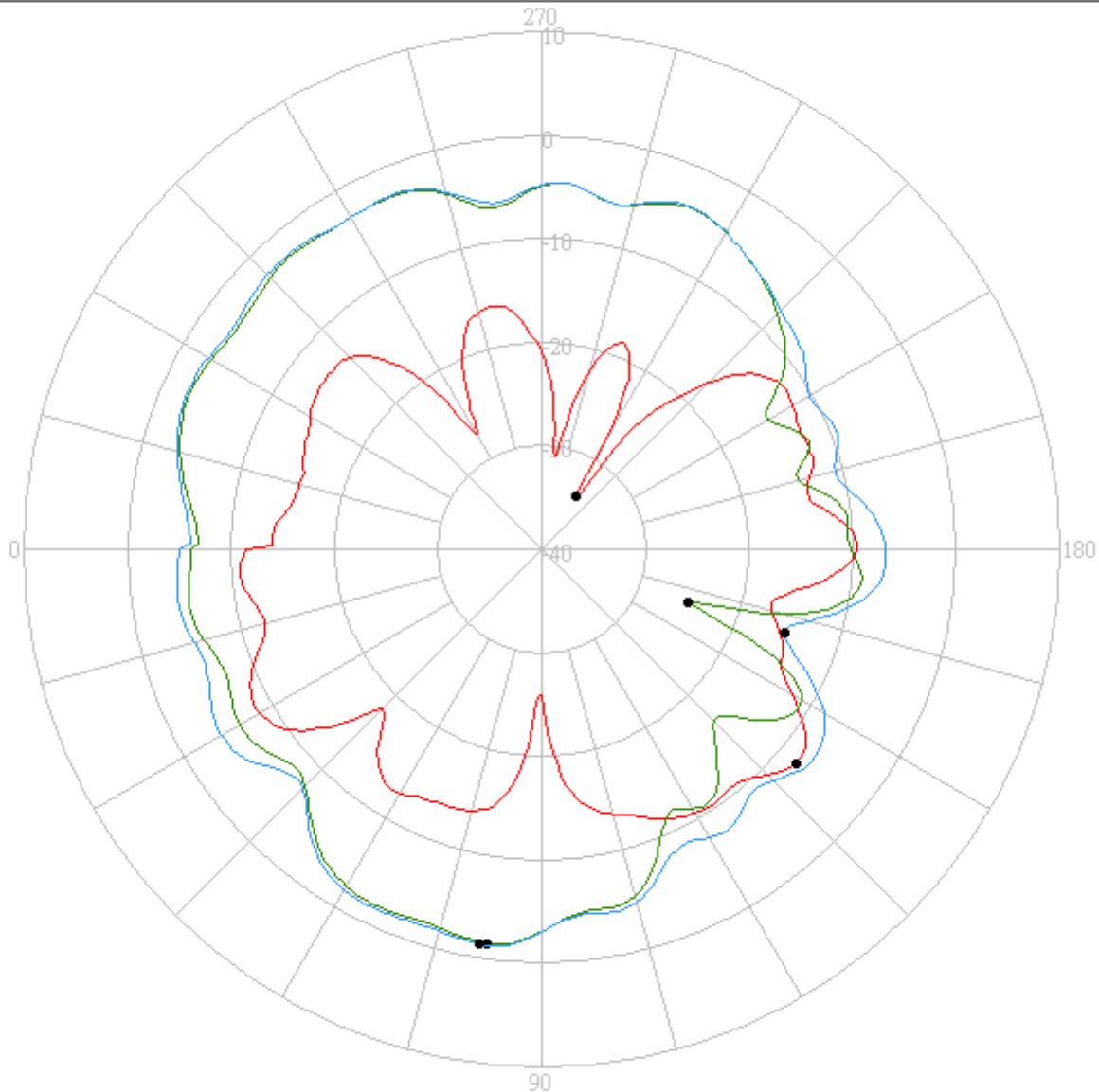

Pattern	Model No.	Test Mode	Freq(MHz)	Max Gain(dBi)	Min Gain(dBi)	Avg. Gain(dBi)	Source Polar.	Date
1	M860T	BT	2400.00	-7.91 / 140.00	-33.91 / 237.00	-13.38	Ver.	2008/3/18
2	M860T	BT	2400.00	-1.54 / 82.00	-25.07 / 160.00	-5.60	Hor.	2008/3/18
3	M860T	BT	2400.00	-1.39 / 81.00	-15.25 / 161.00	-4.93	V+H	2008/3/18

## b. 2.45GHz



# FAVORTRON Co. Ltd

## Antenna Pattern Measurement

4F, No. 108-1, Min Chuan Rd., Hsin-Tien City, Taipei, Taiwan, R.O.C. Tel:886-2-2218-2189,  
Fax:886-2-2218-5760

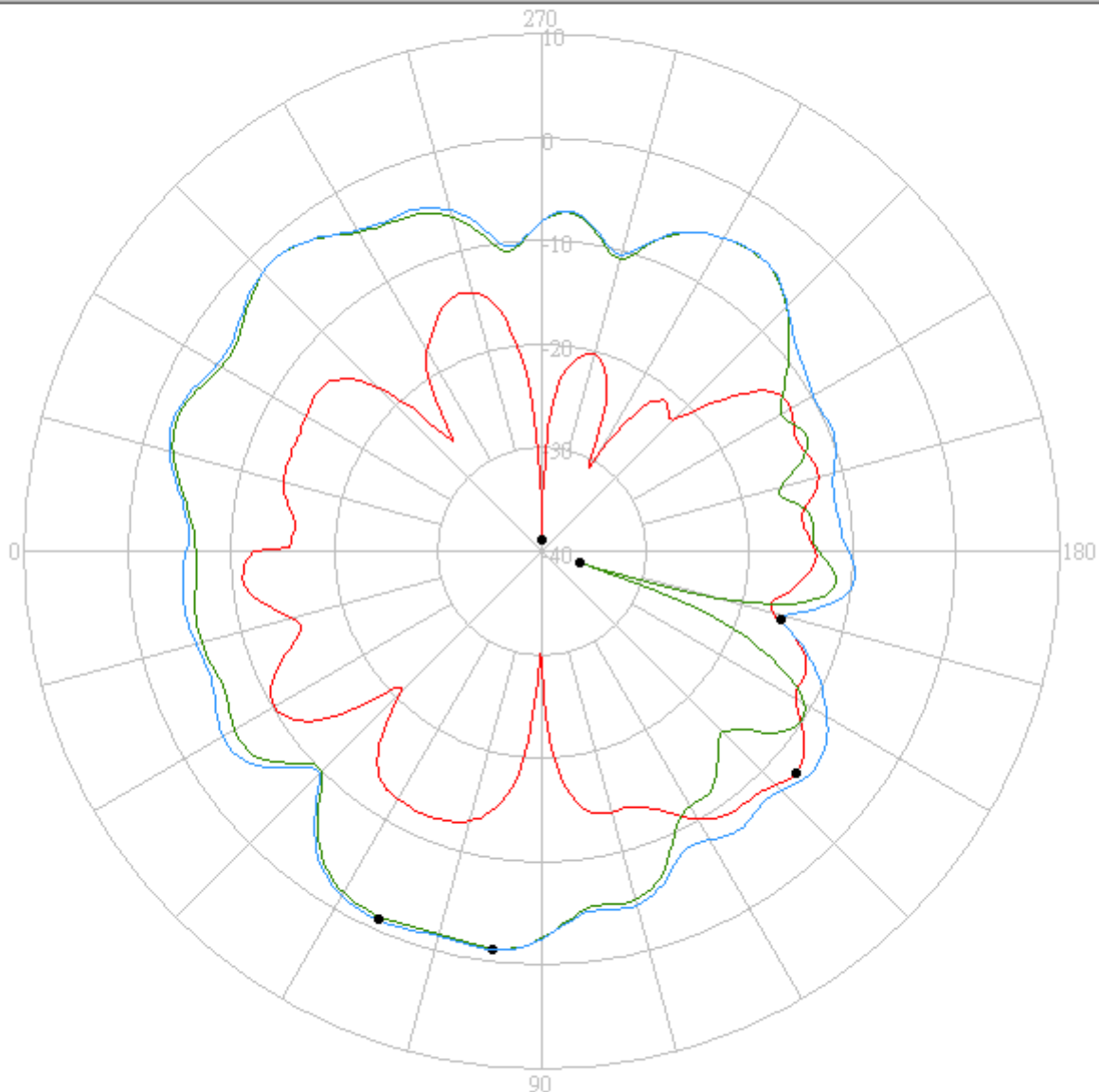

Pattern	Model No.	Test Mode	Freq(MHz)	Max Gain(dBi)	Min Gain(dBi)	Avg. Gain(dBi)	Source Polar.	Date
1	M860T	BT	2450.00	-7.43 / 139.00	-38.96 / 270.00	-13.71	Ver.	2008/3/18
2	M860T	BT	2450.00	-1.33 / 83.00	-36.17 / 162.00	-5.88	Hor.	2008/3/18
3	M860T	BT	2450.00	-1.05 / 66.00	-15.92 / 164.00	-5.22	V+H	2008/3/18

# c. 2.5GHz



## FAVORTRON Co. Ltd Antenna Pattern Measurement

4F, No. 108-1, Min Chuan Rd., Hsin-Tien City, Taipei, Taiwan, R.O.C. Tel:886-2-2218-2189,  
Fax:886-2-2218-5760

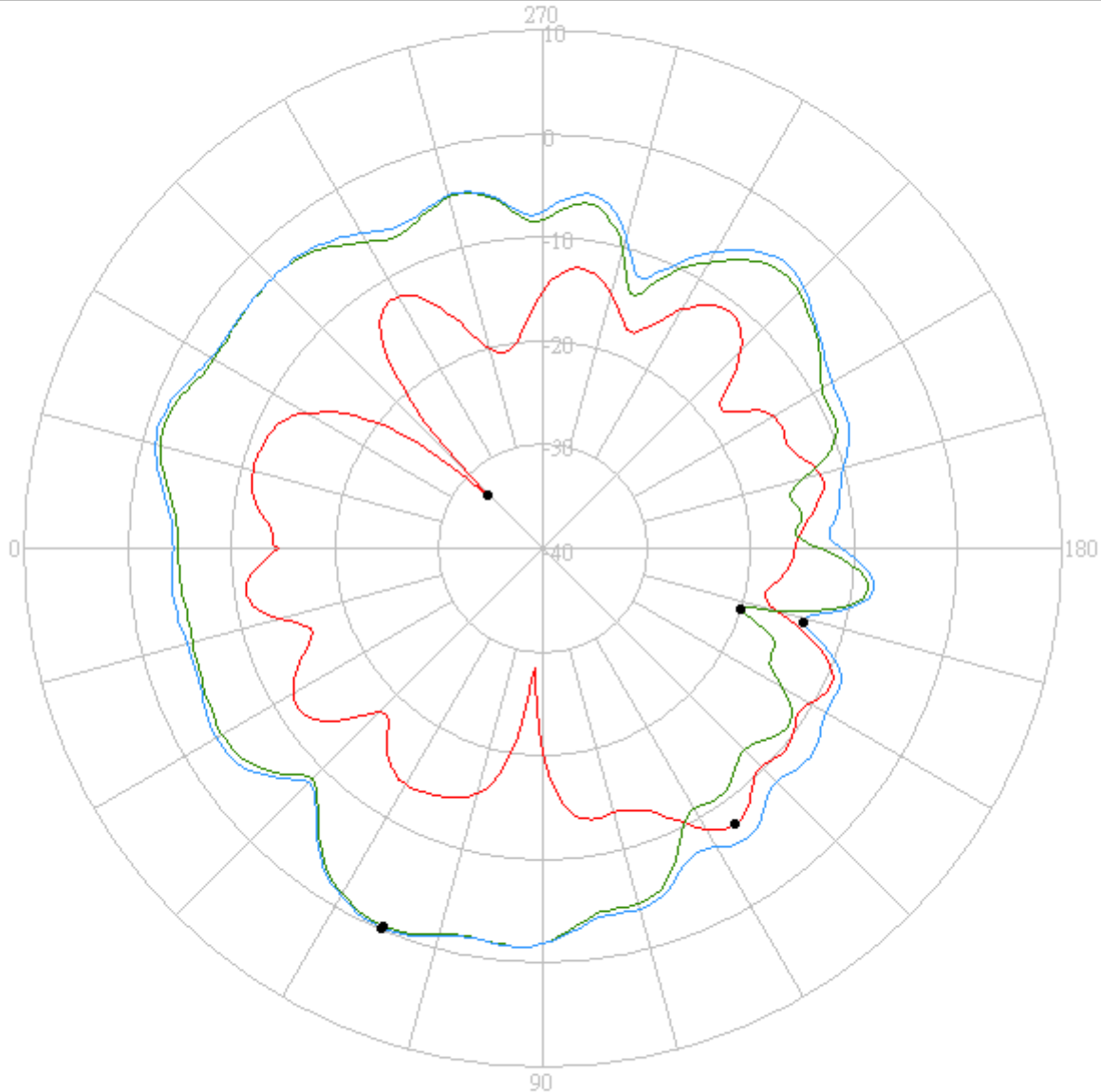

Pattern	Model No.	Test Mode	Freq(MHz)	Max Gain(dBi)	Min Gain(dBi)	Avg. Gain(dBi)	Source Polar.	Date
1	M860T	BT	2500.00	-7.60 / 125.00	-32.54 / 316.00	-13.25	Ver.	2008/3/18
2	M860T	BT	2500.00	-0.44 / 67.00	-20.13 / 163.00	-5.38	Hor.	2008/3/18
3	M860T	BT	2500.00	-0.25 / 67.00	-13.92 / 164.00	-4.72	V+H	2008/3/18