



FCC TEST REPORT

REPORT NO.: RF970806A01

MODEL NO.: BTC04R

RECEIVED: Aug. 6, 2008

TESTED: Aug. 6 ~ Oct. 8, 2008

ISSUED: Oct. 14, 2008

APPLICANT: CastleNet Technology Inc.

ADDRESS: No.64, Chung-Shan Rd. Tu-Cheng City , Taipei 236
Taiwan

ISSUED BY: Advance Data Technology Corporation

LAB LOCATION: No. 47, 14th Ling, Chia Pau Tsuen, Lin Kou Hsiang
244, Taipei Hsien, Taiwan, R.O.C.

This test report consists of 80 pages in total. It may be duplicated completely for legal use with the approval of the applicant. It should not be reproduced except in full, without the written approval of our laboratory. The client should not use it to claim product endorsement by TAF or any government agencies. The test results in the report only apply to the tested sample.





TABLE OF CONTENTS

1.	CERTIFICATION	4
2.	SUMMARY OF TEST RESULTS	5
2.1	MEASUREMENT UNCERTAINTY	6
3.	GENERAL INFORMATION	7
3.1	GENERAL DESCRIPTION OF EUT	7
3.2	DESCRIPTION OF TEST MODES	8
3.2.1	CONFIGURATION OF SYSTEM UNDER TEST	8
3.2.2	TEST MODE APPLICABILITY AND TESTED CHANNEL DETAIL	9
3.2.3	GENERAL DESCRIPTION OF APPLIED STANDARDS	11
3.2.4	DESCRIPTION OF SUPPORT UNITS	11
4.	TEST TYPES AND RESULTS	12
4.1	CONDUCTED EMISSION MEASUREMENT	12
4.1.1	LIMITS OF CONDUCTED EMISSION MEASUREMENT	12
4.1.2	TEST INSTRUMENTS	12
4.1.3	TEST PROCEDURES	13
4.1.4	DEVIATION FROM TEST STANDARD	13
4.1.5	TEST SETUP	13
4.1.6	EUT OPERATING CONDITIONS	14
4.1.7	TEST RESULTS	15
4.2	RADIATED EMISSION MEASUREMENT	19
4.2.1	LIMITS OF RADIATED EMISSION MEASUREMENT	19
4.2.2	TEST INSTRUMENTS	20
4.2.3	TEST PROCEDURES	21
4.2.4	DEVIATION FROM TEST STANDARD	21
4.2.5	TEST SETUP	22
4.2.6	EUT OPERATING CONDITIONS	22
4.2.7	TEST RESULTS	23
4.3	NUMBER OF HOPPING FREQUENCY USED	37
4.3.1	LIMIT OF HOPPING FREQUENCY USED	37
4.3.2	TEST INSTRUMENTS	37
4.3.3	TEST PROCEDURES	37
4.3.4	DEVIATION FROM TEST STANDARD	38
4.3.5	TEST SETUP	38
4.3.6	TEST RESULTS	38
4.4	DWELL TIME ON EACH CHANNEL	41
4.4.1	LIMIT OF DWELL TIME USED	41
4.4.2	TEST INSTRUMENTS	41
4.4.3	TEST PROCEDURES	41
4.4.4	DEVIATION FROM TEST STANDARD	41
4.4.5	TEST SETUP	42
4.4.6	TEST RESULTS	42
4.5	CHANNEL BANDWIDTH	50
4.5.1	LIMITS OF CHANNEL BANDWIDTH	50
4.5.2	TEST INSTRUMENTS	50
4.5.3	TEST PROCEDURE	50
4.5.4	DEVIATION FROM TEST STANDARD	51



4.5.5	TEST SETUP	51
4.5.6	EUT OPERATING CONDITION	51
4.5.7	TEST RESULTS.....	52
4.6	HOPPING CHANNEL SEPARATION	56
4.6.1	LIMIT OF HOPPING CHANNEL SEPARATION	56
4.6.2	TEST INSTRUMENTS	56
4.6.3	TEST PROCEDURES.....	56
4.6.4	DEVIATION FROM TEST STANDARD	57
4.6.5	TEST SETUP	57
4.6.6	TEST RESULTS.....	57
4.7	MAXIMUM PEAK OUTPUT POWER	62
4.7.1	LIMITS OF MAXIMUM PEAK OUTPUT POWER MEASUREMENT	62
4.7.2	TEST INSTRUMENTS	62
4.7.3	TEST PROCEDURES.....	62
4.7.4	DEVIATION FROM TEST STANDARD	62
4.7.5	TEST SETUP	63
4.7.6	EUT OPERATING CONDITION	63
4.7.7	TEST RESULTS.....	63
4.8	BAND EDGES MEASUREMENT	68
4.8.1	LIMITS OF BAND EDGES MEASUREMENT	68
4.8.2	TEST INSTRUMENTS	68
4.8.3	TEST PROCEDURE	68
4.8.4	DEVIATION FROM TEST STANDARD	68
4.8.5	EUT OPERATING CONDITION	68
4.8.6	TEST RESULTS.....	69
4.9	ANTENNA REQUIREMENT	77
4.9.1	STANDARD APPLICABLE	77
4.9.2	ANTENNA CONNECTED CONSTRUCTION	77
5.	PHOTOGRAPHS OF THE TEST CONFIGURATION.....	78
6.	INFORMATION ON THE TESTING LABORATORIES	78
7.	APPENDIX A – MODIFICATIONS RECORDERS FOR ENGINEERING CHANGES TO THE EUT BY THE LAB	80



1. CERTIFICATION

PRODUCT: Bluetooth Module
BRAND NAME: CastleNet
MODEL NO.: BTC04R
APPLICANT: CastleNet Technology Inc.
TESTED: Aug. 6 ~ Oct. 8, 2008
TEST SAMPLE: ENGINEERING SAMPLE
STANDARDS: FCC Part 15, Subpart C (Section 15.247),
ANSI C63.4-2003

The above equipment has been tested by **Advance Data Technology Corporation**, and found compliance with the requirement of the above standards. The test record, data evaluation & Equipment Under Test (EUT) configurations represented herein are true and accurate accounts of the measurements of the sample's EMC characteristics under the conditions specified in this report.

PREPARED BY : *Jessica Cheng* , **DATE:** Oct. 14, 2008
(Jessica Cheng / Specialist)

**TECHNICAL
ACCEPTANCE** : *Jamison Chan* , **DATE:** Oct. 14, 2008
Responsible for RF (Jamison Chan / Supervisor)

APPROVED BY : *Ken Liu* , **DATE:** Oct. 14, 2008
(Ken Liu / Deputy Manager)

2. SUMMARY OF TEST RESULTS

The EUT has been tested according to the following specifications:

APPLIED STANDARD: FCC Part 15, Subpart C			
STANDARD SECTION	TEST TYPE AND LIMIT	RESULT	REMARK
15.207	AC Power Conducted Emission	PASS	Meet the requirement of limit. Minimum passing margin is -14.08dB at 0.182MHz.
15.247(a)(1)(iii)	Number of Hopping Frequency Used Spec.: At least 15 channels	PASS	Meet the requirement of limit.
15.247(a)(1)(iii)	Dwell Time on Each Channel Spec. : Max. 0.4 second within 31.6 second	PASS	Meet the requirement of limit.
15.247(a)(1)	1. Hopping Channel Separation Spec. : Min. 25 kHz or 20 dB bandwidth, whichever is greater (see Note) 2. Spectrum Bandwidth of a Frequency Hopping Sequence Spread Spectrum System	PASS	Meet the requirement of limit.
15.247(b)	Maximum Peak Output Power Spec.: max. 21dBm (see Note)	PASS	Meet the requirement of limit.
15.247(d)	Transmitter Radiated Emissions Spec.: Table 15.209	PASS	Meet the requirement of limit. Minimum passing margin is -0.82dB at 1602.000MHz.
15.247(d)	Band Edge Measurement	PASS	Meet the requirement of limit.

NOTE: If The Frequency Hopping System operating in 2400-2483.5MHz band and the output power less than 125mW. The hopping channel carrier frequencies separated by a minimum of 25kHz or two-thirds of the 20dB bandwidth of hopping channel whichever is greater.

2.1 MEASUREMENT UNCERTAINTY

Where relevant, the following measurement uncertainty levels have been estimated for tests performed on the EUT as specified in CISPR 16-4-2:

This uncertainty represents an expanded uncertainty expressed at approximately the 95% confidence level using a coverage factor of $k=2$.

MEASUREMENT	FREQUENCY	UNCERTAINTY
Conducted emissions	9kHz ~ 30MHz	2.44 dB
Radiated emissions	30MHz ~ 1GHz	3.72 dB
	1GHz ~ 40GHz	2.89 dB

3. GENERAL INFORMATION

3.1 GENERAL DESCRIPTION OF EUT

PRODUCT	Bluetooth Module
MODEL NO.	BTC04R
FCC ID	RK9-BTC04R
POWER SUPPLY	5Vdc from host equipment
MODULATION TYPE	GFSK, π /4-DQPSK, 8DPSK
RADIO TECHNOLOGY	FHSS
TRANSFER RATE	1/2/3Mbps
OPERATING FREQUENCY	2402 ~ 2480MHz
NUMBER OF CHANNEL	79
OUTPUT POWER	3.206mW
ANTENNA TYPE	Refer to note 2 as below
DATA CABLE	NA
I/O PORTS	NA

NOTE:

1. The EUT is a Bluetooth Module, with Bluetooth technology.
2. The following antennas were provided to this EUT.

NO.	BRAND	MODEL NO.	ANTENNA TYPE	ANTENNA CONNECTOR	ANTENNA GAIN (dBi)
1	MAG.LAYERS	LTA-6025-2G 4S3-B1-RW	Chip Ant.	NA	-4.69
2	FVC	M730x	PIFA Ant.	U.FL	2.25
3	WGT	L390x	PIFA Ant.	U.FL	1.07
4	FVC	M540x	PIFA Ant.	U.FL	-0.07
5	FVC	M570x	PIFA Ant.	U.FL	2.18
6	WGT	M720x	PIFA Ant.	U.FL	-0.09
7	FVC	M735x	PIFA Ant.	U.FL	-5.39
8	WGT	M740x	PIFA Ant.	U.FL	2.08
9	FVC	M760x	PIFA Ant.	U.FL	-3.24
10	SA	M770x	PIFA Ant.	U.FL	-0.21
11	FVC	M860x	PIFA Ant.	U.FL	-0.25
12	FVC	TN120R	PIFA Ant.	U.FL	-0.3

For PIFA antenna, only highest antenna gain was chosen for the final test and presented in the test report.

3. The above EUT information was declared by the manufacturer and for more detailed features description, please refer to the manufacturer's specifications or User's Manual.

3.2 DESCRIPTION OF TEST MODES

79 channels are provided to this EUT:

CHANNEL	FREQ. (MHz)	CHANNEL	FREQ. (MHz)	CHANNEL	FREQ. (MHz)	CHANNEL	FREQ. (MHz)
0	2402	20	2422	40	2442	60	2462
1	2403	21	2423	41	2443	61	2463
2	2404	22	2424	42	2444	62	2464
3	2405	23	2425	43	2445	63	2465
4	2406	24	2426	44	2446	64	2466
5	2407	25	2427	45	2447	65	2467
6	2408	26	2428	46	2448	66	2468
7	2409	27	2429	47	2449	67	2469
8	2410	28	2430	48	2450	68	2470
9	2411	29	2431	49	2451	69	2471
10	2412	30	2432	50	2452	70	2472
11	2413	31	2433	51	2453	71	2473
12	2414	32	2434	52	2454	72	2474
13	2415	33	2435	53	2455	73	2475
14	2416	34	2436	54	2456	74	2476
15	2417	35	2437	55	2457	75	2477
16	2418	36	2438	56	2458	76	2478
17	2419	37	2439	57	2459	77	2479
18	2420	38	2440	58	2460	78	2480
19	2421	39	2441	59	2461		

3.2.1 CONFIGURATION OF SYSTEM UNDER TEST

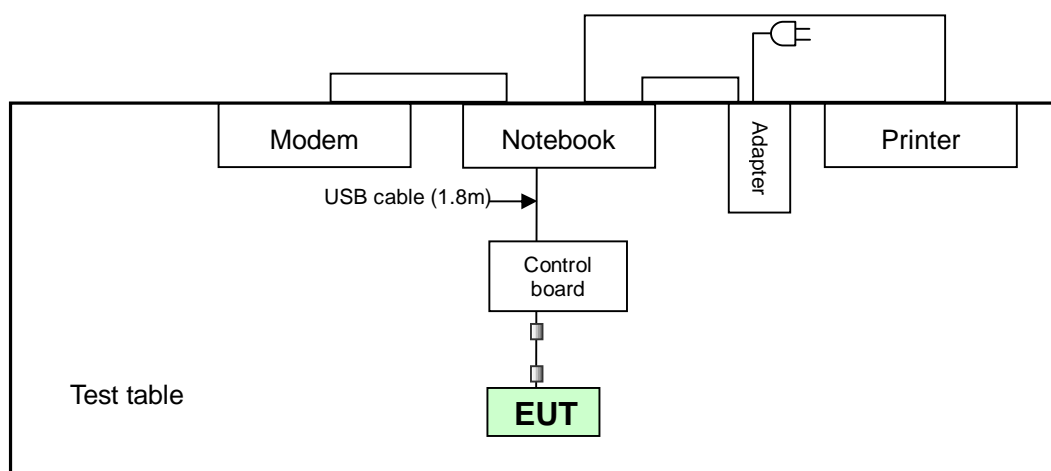



3.2.2 TEST MODE APPLICABILITY AND TESTED CHANNEL DETAIL

EUT CONFIGURE MODE	Applicable to				Description
	PLC	RE<1G	RE [≥] 1G	APCM	
A	√	√	√	√	Antenna No.: 1
B	√	√	√	-	Antenna No.: 2

Where **PLC**: Power Line Conducted Emission **RE<1G**: Radiated Emission below 1GHz
RE[≥]1G: Radiated Emission above 1GHz **APCM**: Antenna Port Conducted Measurement
 “-“ : Mean no effect

POWER LINE CONDUCTED EMISSION TEST:

- Pre-Scan has been conducted to determine the worst-case mode from all possible combinations between available modulations and packet types.
- Following channel(s) was (were) selected for the final test as listed below.

EUT CONFIGURE MODE	AVAILABLE CHANNEL	TESTED CHANNEL	MODULATION TECHNOLOGY	MODULATION TYPE	DATA RATE (Mbps)	PACKET TYPE
A	0 to 78	0	FHSS	GFSK	DH5	1
B	0 to 78	0	FHSS	GFSK	DH5	1

RADIATED EMISSION TEST (BELOW 1 GHz):

- Pre-Scan has been conducted to determine the worst-case mode from all possible combinations between available modulations, data rates, packet type, X,Y,Z Axis and antenna ports (if EUT with antenna diversity architecture).
- Following channel(s) was (were) selected for the final test as listed below.

EUT CONFIGURE MODE	AVAILABLE CHANNEL	TESTED CHANNEL	MODULATION TECHNOLOGY	MODULATION TYPE	DATA RATE (Mbps)	PACKET TYPE	AXIS
A	0 to 78	0	FHSS	GFSK	DH5	1	X
B	0 to 78	0	FHSS	GFSK	DH5	1	Z



RADIATED EMISSION TEST (ABOVE 1 GHz):

- Pre-Scan has been conducted to determine the worst-case mode from all possible combinations between available modulations, data rates, packet type, X,Y,Z Axis and antenna ports (if EUT with antenna diversity architecture).
- Following channel(s) was (were) selected for the final test as listed below.

EUT CONFIGURE MODE	AVAILABLE CHANNEL	TESTED CHANNEL	MODULATION TECHNOLOGY	MODULATION TYPE	DATA RATE (Mbps)	PACKET TYPE	AXIS
A	0 to 78	0, 39, 78	FHSS	GFSK	DH5	1	X
A	0 to 78	0, 39, 78	FHSS	8DPSK	DH5	3	X
B	0 to 78	0, 39, 78	FHSS	GFSK	DH5	1	Z
B	0 to 78	0, 39, 78	FHSS	8DPSK	DH5	3	Z

BANDEDGE MEASUREMENT:

- Pre-Scan has been conducted to determine the worst-case mode from all possible combinations between available modulations and packet types of the antenna and antenna ports (if EUT with antenna diversity architecture).
- Following channel(s) was (were) selected for the final test as listed below.

EUT CONFIGURE MODE	AVAILABLE CHANNEL	TESTED CHANNEL	MODULATION TECHNOLOGY	MODULATION TYPE	DATA RATE (Mbps)	PACKET TYPE
A, B	0 to 78	0, 78	FHSS	GFSK	DH5	1
A, B	0 to 78	0, 78	FHSS	8DPSK	DH5	3

ANTENNA PORT CONDUCTED MEASUREMENT:

- Pre-Scan has been conducted to determine the worst-case mode from all possible combinations between available modulations and packet types of the antenna and antenna ports (if EUT with antenna diversity architecture).
- Following channel(s) was (were) selected for the final test as listed below.

EUT CONFIGURE MODE	AVAILABLE CHANNEL	TESTED CHANNEL	MODULATION TECHNOLOGY	MODULATION TYPE	DATA RATE (Mbps)	PACKET TYPE
A	0 to 78	0, 39, 78	FHSS	GFSK	DH5	1
A	0 to 78	0, 39, 78	FHSS	8DPSK	DH5	3



3.2.3 GENERAL DESCRIPTION OF APPLIED STANDARDS

The EUT is a RF Product. According to the specifications of the manufacturer, it must comply with the requirements of the following standards:

FCC Part 15, Subpart C. (15.247)

ANSI C63.4- 2003

All test items have been performed and recorded as per the above standards.

NOTE: The product has been verified to comply with the requirements of FCC Part 15, Subpart B, Class B (DoC). The test report has been issued separately.

3.2.4 DESCRIPTION OF SUPPORT UNITS

The EUT has been tested as an independent unit together with other necessary accessories or support units. The following support units or accessories were used to form a representative test configuration during the tests.

NO.	PRODUCT	BRAND	MODEL NO.	SERIAL NO.	FCC ID
1	NOTEBOOK COMPUTER	DELL	PP05L	20375526736	FCC DoC Approved
2	PRINTER	EPSON	LQ-300+	DCGY017054	FCC DoC Approved
3	MODEM	ACEEX	1414	980020520	IFAXDM1414

NO.	SIGNAL CABLE DESCRIPTION OF THE ABOVE SUPPORT UNITS
1	N/A
2	1.8m braid shielded wire, terminated with DB25 and Centronics connector via metallic frame, w/o core
3	1.2 m braid shielded wire, terminated with DB25 and DB9 connector via metallic frame, w/o core.

NOTE: 1. All power cords of the above support units are non-shielded (1.8m).
2. One USB cable (1.8m) was connected from EUT to PC.



4. TEST TYPES AND RESULTS

4.1 CONDUCTED EMISSION MEASUREMENT

4.1.1 LIMITS OF CONDUCTED EMISSION MEASUREMENT

FREQUENCY OF EMISSION (MHz)	CONDUCTED LIMIT (dB μ V)	
	Quasi-peak	Average
0.15 ~ 0.5	66 to 56	56 to 46
0.5 ~ 5	56	46
5 ~ 30	60	50

- NOTE:**
1. The lower limit shall apply at the transition frequencies.
 2. The limit decreases in line with the logarithm of the frequency in the range of 0.15 to 0.50 MHz.
 3. All emanations from a class A/B digital device or system, including any network of conductors and apparatus connected thereto, shall not exceed the level of field strengths specified above.

4.1.2 TEST INSTRUMENTS

DESCRIPTION & MANUFACTURER	MODEL NO.	SERIAL NO.	CALIBRATED DATE	CALIBRATED UNTIL
ROHDE & SCHWARZ Test Receiver	ESCS 30	838251/021	Dec. 20, 2007	Dec. 19, 2008
ROHDE & SCHWARZ Artificial Mains Network (for EUT)	ESH3-Z5	100218	Nov. 21, 2007	Nov. 20, 2008
LISN With Adapter (for EUT)	AD10	C10Ada-001	Nov. 22, 2007	Nov. 21, 2008
ROHDE & SCHWARZ Artificial Mains Network (for peripherals)	ESH3-Z5	100219	Nov. 09, 2007	Nov. 08, 2008
ROHDE & SCHWARZ Artificial Mains Network (for peripherals)	ESH3-Z5	100220	Oct. 26, 2007	Oct. 25, 2008
Software	ADT_Cond_V7.3.5	NA	NA	NA
Software	ADT_ISN_V7.3.5	NA	NA	NA
RF cable (JYEBAO)	5D-FB	Cable-C10.01	Feb. 27, 2008	Feb. 26, 2009
SUHNTER Terminator (For ROHDE & SCHWARZ LISN)	65BNC-5001	E1-010773	Feb. 14, 2008	Feb. 13, 2009

- NOTE:**
1. The calibration interval of the above test instruments is 12 months and the calibrations are traceable to NML/ROC and NIST/USA.
 2. The test was performed in Shielded Room No. 10.
 3. The VCCI Site Registration No. C-1852.

4.1.3 TEST PROCEDURES

- a. The EUT was placed 0.4 meters from the conducting wall of the shielded room with EUT being connected to the power mains through a line impedance stabilization network (LISN). Other support units were connected to the power mains through another LISN. The two LISNs provide 50 ohm/ 50uH of coupling impedance for the measuring instrument.
- b. Both lines of the power mains connected to the EUT were checked for maximum conducted interference.
- c. The frequency range from 150kHz to 30MHz was searched. Emission levels under (Limit - 20dB) was not recorded.

4.1.4 DEVIATION FROM TEST STANDARD

No deviation

4.1.5 TEST SETUP

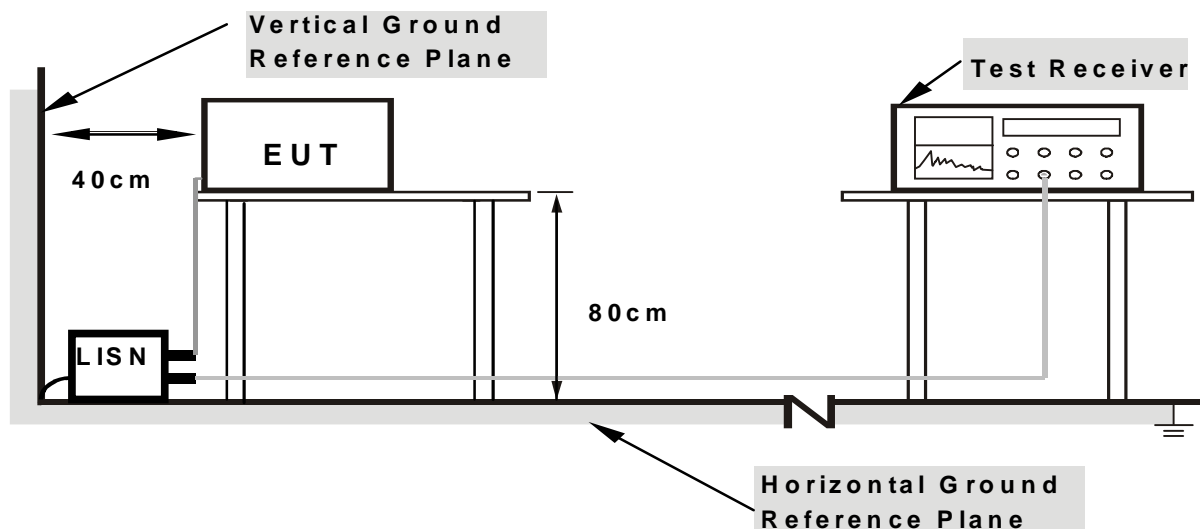

- Note:**
1. Support units were connected to second LISN.
 2. Both of LISNs (AMN) are 80 cm from EUT and at least 80 cm from other units and other metal planes support units.

For the actual test configuration, please refer to the related item – Photographs of the Test Configuration.

4.1.6 EUT OPERATING CONDITIONS

- a. Connected EUT with notebook system via control board and placed on testing table.
- b. The notebook system ran a test program (provided by manufacturer) to enable EUT under transmitting condition continuously at specific channel frequency.
- c. The necessary accessories enable the system in full functions.

4.1.7 TEST RESULTS

TEST MODE	A	CHANNEL	0
MODULATION TYPE	GFSK	6dB BANDWIDTH	9 kHz
INPUT POWER (SYSTEM)	120Vac, 60 Hz	PHASE	Line 1
ENVIRONMENTAL CONDITIONS	27deg. C, 55% RH, 1000hPa	TESTED BY	Chad Lee

No	Freq. [MHz]	Corr. Factor (dB)	Reading Value		Emission Level		Limit		Margin	
			[dB (uV)]		[dB (uV)]		[dB (uV)]		(dB)	
			Q.P.	AV.	Q.P.	AV.	Q.P.	AV.	Q.P.	AV.
1	0.180	0.19	49.49	-	49.68	-	64.48	54.48	-14.80	-
2	0.242	0.19	42.47	-	42.66	-	62.04	52.04	-19.38	-
3	0.360	0.20	33.82	-	34.02	-	58.73	48.73	-24.71	-
4	0.480	0.20	28.53	-	28.73	-	56.34	46.34	-27.61	-
5	1.795	0.25	36.78	-	37.03	-	56.00	46.00	-18.97	-
6	3.773	0.41	38.48	-	38.89	-	56.00	46.00	-17.11	-

- REMARKS:**
1. Q.P. and AV. are abbreviations of quasi-peak and average individually.
 2. "-": The Quasi-peak reading value also meets average limit and measurement with the average detector is unnecessary.
 3. The emission levels of other frequencies were very low against the limit.
 4. Margin value = Emission level - Limit value
 5. Correction factor = Insertion loss + Cable loss
 6. Emission Level = Correction Factor + Reading Value.

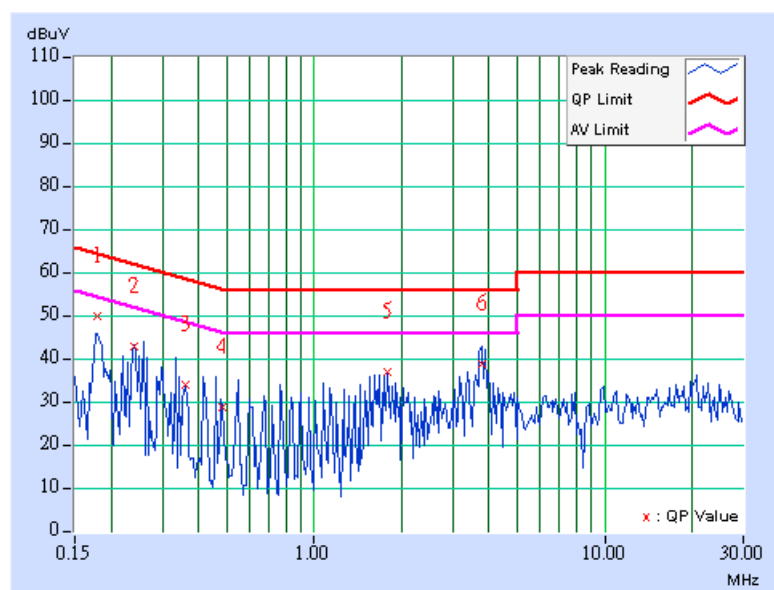

TEST MODE	A	CHANNEL	0
MODULATION TYPE	GFSK	6dB BANDWIDTH	9 kHz
INPUT POWER (SYSTEM)	120Vac, 60 Hz	PHASE	Line 2
ENVIRONMENTAL CONDITIONS	27deg. C, 55% RH, 1000hPa	TESTED BY	Chad Lee

No	Freq. [MHz]	Corr. Factor (dB)	Reading Value [dB (uV)]		Emission Level [dB (uV)]		Limit [dB (uV)]		Margin (dB)	
			Q.P.	AV.	Q.P.	AV.	Q.P.	AV.	Q.P.	AV.
			1	0.182	0.19	50.11	-	50.30	-	64.38
2	0.241	0.19	43.59	-	43.78	-	62.08	52.08	-18.30	-
3	0.302	0.20	39.72	-	39.92	-	60.19	50.19	-20.28	-
4	0.422	0.20	33.63	-	33.83	-	57.41	47.41	-23.58	-
5	1.982	0.26	38.08	-	38.34	-	56.00	46.00	-17.66	-
6	3.846	0.43	40.14	-	40.57	-	56.00	46.00	-15.43	-

- REMARKS:**
1. Q.P. and AV. are abbreviations of quasi-peak and average individually.
 2. "-": The Quasi-peak reading value also meets average limit and measurement with the average detector is unnecessary.
 3. The emission levels of other frequencies were very low against the limit.
 4. Margin value = Emission level - Limit value
 5. Correction factor = Insertion loss + Cable loss
 6. Emission Level = Correction Factor + Reading Value.

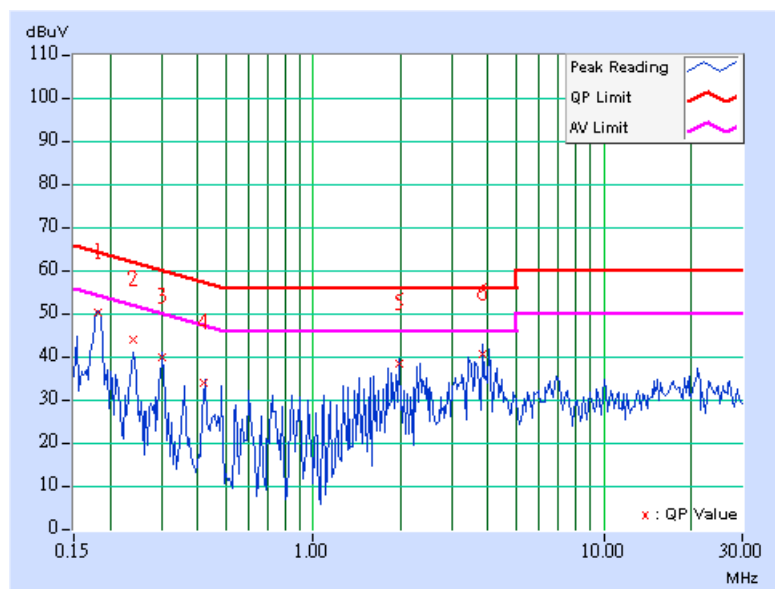

TEST MODE	B	CHANNEL	0
MODULATION TYPE	GFSK	6dB BANDWIDTH	9 kHz
INPUT POWER (SYSTEM)	120Vac, 60 Hz	PHASE	Line 1
ENVIRONMENTAL CONDITIONS	25deg. C, 80% RH, 1002hPa	TESTED BY	Chad Lee

No	Freq. [MHz]	Corr. Factor (dB)	Reading Value		Emission Level		Limit		Margin	
			[dB (uV)]		[dB (uV)]		[dB (uV)]		(dB)	
			Q.P.	AV.	Q.P.	AV.	Q.P.	AV.	Q.P.	AV.
1	0.181	0.20	43.97	-	44.17	-	64.43	54.43	-20.26	-
2	0.240	0.22	41.70	-	41.92	-	62.10	52.10	-20.18	-
3	0.298	0.22	35.42	-	35.64	-	60.29	50.29	-24.64	-
4	0.358	0.23	33.42	-	33.65	-	58.77	48.77	-25.12	-
5	1.675	0.27	35.91	-	36.18	-	56.00	46.00	-19.82	-
6	3.529	0.34	36.82	-	37.16	-	56.00	46.00	-18.84	-

- REMARKS:**
1. Q.P. and AV. are abbreviations of quasi-peak and average individually.
 2. "-": The Quasi-peak reading value also meets average limit and measurement with the average detector is unnecessary.
 3. The emission levels of other frequencies were very low against the limit.
 4. Margin value = Emission level - Limit value
 5. Correction factor = Insertion loss + Cable loss
 6. Emission Level = Correction Factor + Reading Value.

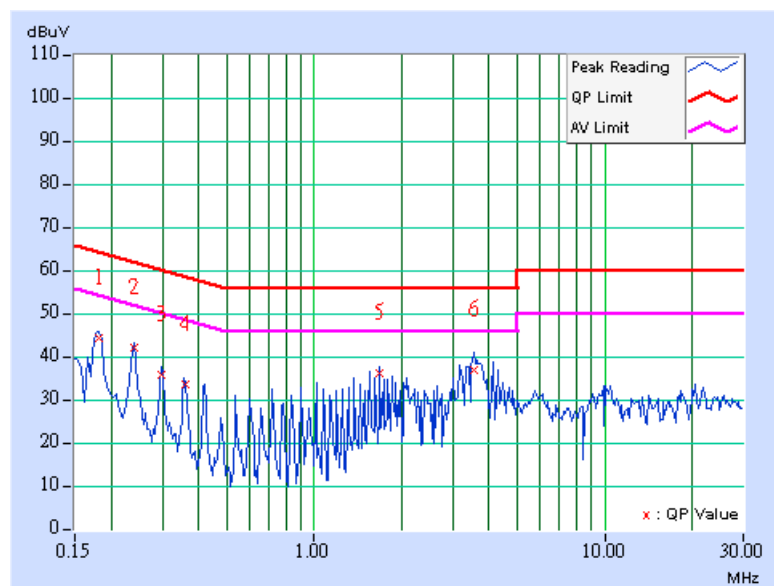

TEST MODE	B	CHANNEL	0
MODULATION TYPE	GFSK	6dB BANDWIDTH	9 kHz
INPUT POWER (SYSTEM)	120Vac, 60 Hz	PHASE	Line 2
ENVIRONMENTAL CONDITIONS	25deg. C, 80% RH, 1002hPa	TESTED BY	Chad Lee

No	Freq. [MHz]	Corr. Factor (dB)	Reading Value		Emission Level		Limit		Margin	
			[dB (uV)]		[dB (uV)]		[dB (uV)]		(dB)	
			Q.P.	AV.	Q.P.	AV.	Q.P.	AV.	Q.P.	AV.
1	0.181	0.20	45.17	-	45.37	-	64.43	54.43	-19.06	-
2	0.240	0.22	39.31	-	39.53	-	62.10	52.10	-22.57	-
3	0.300	0.22	38.64	-	38.86	-	60.25	50.25	-21.39	-
4	0.420	0.22	34.53	-	34.75	-	57.46	47.46	-22.71	-
5	1.797	0.26	35.12	-	35.38	-	56.00	46.00	-20.62	-
6	3.467	0.32	36.05	-	36.37	-	56.00	46.00	-19.63	-

- REMARKS:**
1. Q.P. and AV. are abbreviations of quasi-peak and average individually.
 2. "-": The Quasi-peak reading value also meets average limit and measurement with the average detector is unnecessary.
 3. The emission levels of other frequencies were very low against the limit.
 4. Margin value = Emission level - Limit value
 5. Correction factor = Insertion loss + Cable loss
 6. Emission Level = Correction Factor + Reading Value.

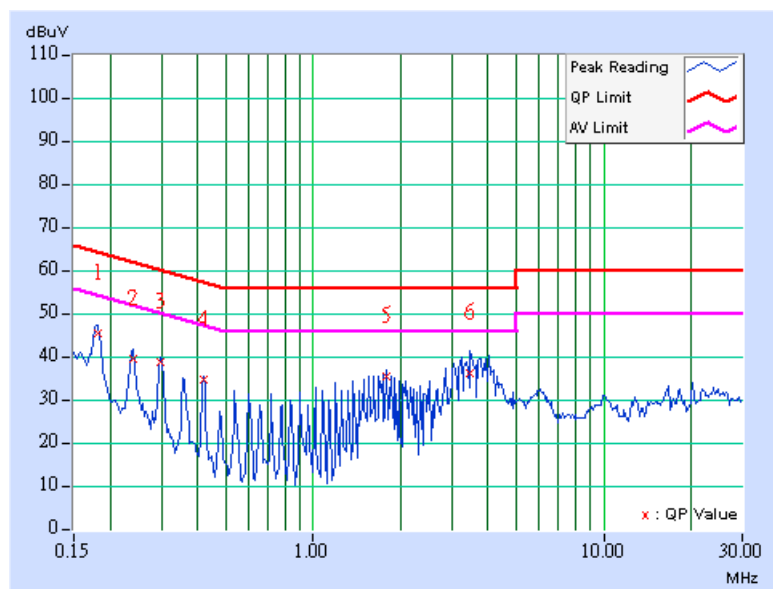



4.2 RADIATED EMISSION MEASUREMENT

4.2.1 LIMITS OF RADIATED EMISSION MEASUREMENT

Emissions radiated outside of the specified bands, shall be according to the general radiated limits in 15.209 as following:

FREQUENCIES (MHz)	FIELD STRENGTH (microvolts/meter)	MEASUREMENT DISTANCE (meters)
0.009 ~ 0.490	2400/F(kHz)	300
0.490 ~ 1.705	24000/F(kHz)	30
1.705 ~ 30.0	30	30
30 ~ 88	100	3
88 ~ 216	150	3
216 ~ 960	200	3
Above 960	500	3

NOTE:

1. The lower limit shall apply at the transition frequencies.
2. Emission level (dBuV/m) = 20 log Emission level (uV/m).
3. As shown in 15.35(b), for frequencies above 1000MHz, the field strength limits are based on average detector, however, the peak field strength of any emission shall not exceed the maximum permitted average limits, specified above by more than 20dB under any condition of modulation.



4.2.2 TEST INSTRUMENTS

DESCRIPTION & MANUFACTURER	MODEL NO.	SERIAL NO.	CALIBRATED DATE	CALIBRATED UNTIL
HP Preamplifier	8447D	2432A03504	May 09, 2008	May 08, 2009
HP Preamplifier	8449B	3008A01924	Sep. 03, 2008	Sep. 02, 2009
HP Preamplifier	8449B	3008A01292	Aug. 06, 2008	Aug. 05, 2009
ROHDE & SCHWARZ TEST RECEIVER	ESI7	836697/012	Dec. 06, 2007	Dec. 05, 2008
Schwarzbeck Antenna	VULB 9168	137	May 02, 2008	May 01, 2009
Schwarzbeck Antenna	VHBA 9123	480	Apr. 23, 2008	Apr. 22, 2009
EMCO Horn Antenna	3115	6714	Oct. 19, 2007	Oct. 18, 2008
EMCO Horn Antenna	3115	9312-4192	Apr. 21, 2008	Apr. 20, 2009
ADT. Turn Table	TT100	0306	NA	NA
ADT. Tower	AT100	0306	NA	NA
Software	ADT_Radiated_V 7.6.15	NA	NA	NA
SUHNER RF cable	SF104-26.5	CABLE-CH6-17m -01	Nov. 05, 2007	Nov. 04, 2008
ROHDE & SCHWARZ Spectrum Analyzer	FSP 40	100035	Mar. 26, 2008	Mar. 25, 2009

- NOTE:**
1. The calibration interval of the above test instruments is 12 months. And the calibrations are traceable to NML/ROC and NIST/USA.
 2. The horn antenna and HP preamplifier (model: 8449B) are used only for the measurement of emission frequency above 1GHz if tested.
 3. The test was performed in Chamber No. 6.
 4. The Industry Canada Reference No. IC 3789-6.
 5. The FCC Site Registration No. is 447212.

4.2.3 TEST PROCEDURES

- a. The EUT was placed on the top of a rotating table 0.8 meters above the ground at a 3 meter semi-anechoic chamber. The table was rotated 360 degrees to determine the position of the highest radiation.
- b. The EUT was set 3 meters away from the interference-receiving antenna, which was mounted on the top of a variable-height antenna tower.
- c. The antenna is a broadband antenna, and its height is varied from one meter to four meters above the ground to determine the maximum value of the field strength. Both horizontal and vertical polarizations of the antenna are set to make the measurement.
- d. For each suspected emission, the EUT was arranged to its worst case and then the antenna was tuned to heights from 1 meter to 4 meters and the rotatable table was turned from 0 degrees to 360 degrees to find the maximum reading.
- e. The test-receiver system was set to Peak Detect Function and Specified Bandwidth with Maximum Hold Mode.
- f. If the emission level of the EUT in peak mode was lower than the limit specified, then testing could be stopped and the peak values of the EUT would be reported. Otherwise the emissions would be re-tested one by one using peak, quasi-peak or average method as specified and then reported in a data sheet.

NOTE:

1. The resolution bandwidth of test receiver/spectrum analyzer is 120kHz for Quasi-peak detection at frequency below 1GHz.
2. The resolution bandwidth is 1MHz and video bandwidth of test receiver/spectrum analyzer is 3MHz for Peak detection at frequency above 1GHz. The resolution bandwidth of test receiver/spectrum analyzer is 1 MHz for Average detection (AV) at frequency above 1GHz.
3. For measurement of frequency above 1000 MHz, the EUT was set 3 meters away from the interference-receiving antenna.

4.2.4 DEVIATION FROM TEST STANDARD

No deviation

4.2.5 TEST SETUP

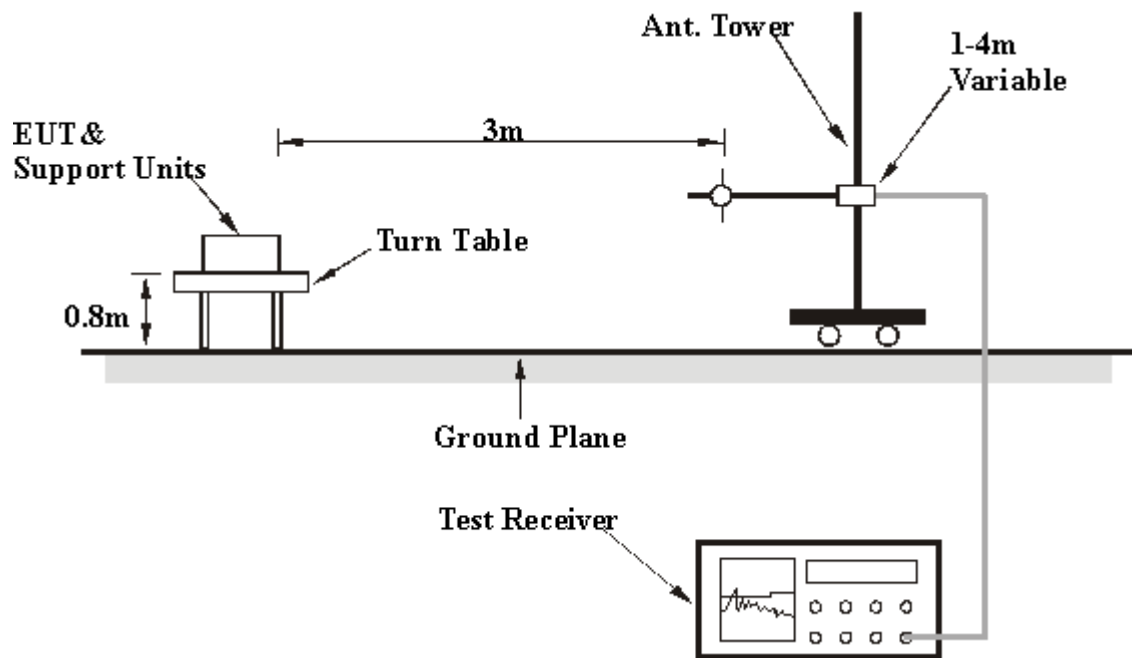

For the actual test configuration, please refer to the related item – Photographs of the Test Configuration.

4.2.6 EUT OPERATING CONDITIONS

Same as item 4.1.6.



4.2.7 TEST RESULTS

RADIATED WORST CASE DATA: FOR GFSK (BELOW 1GHz)

TEST MODE	A	CHANNEL	0
MODULATION TYPE	GFSK	FREQUENCY RANGE	Below 1000MHz
INPUT POWER (SYSTEM)	120Vac, 60 Hz	DETECTOR FUNCTION	Quasi-Peak
ENVIRONMENTAL CONDITIONS	25deg. C, 80% RH, 996hPa	TESTED BY	Chad Lee

ANTENNA POLARITY & TEST DISTANCE: HORIZONTAL AT 3 M

No.	Freq. (MHz)	Emission Level (dBuV/m)	Limit (dBuV/m)	Margin (dB)	Antenna Height (m)	Table Angle (Degree)	Raw Value (dBuV)	Correction Factor (dB/m)
1	92.204	32.61 QP	43.50	-10.89	1.98 H	196	22.31	10.30
2	131.082	31.65 QP	43.50	-11.85	1.00 H	256	17.85	13.80
3	166.072	31.92 QP	43.50	-11.58	1.00 H	277	18.12	13.80
4	199.118	32.19 QP	43.50	-11.31	1.00 H	259	20.50	11.69
5	500.421	34.98 QP	46.00	-11.02	1.00 H	187	13.71	21.27
6	900.862	33.82 QP	46.00	-12.18	1.00 H	22	5.41	28.41

ANTENNA POLARITY & TEST DISTANCE: VERTICAL AT 3 M

No.	Freq. (MHz)	Emission Level (dBuV/m)	Limit (dBuV/m)	Margin (dB)	Antenna Height (m)	Table Angle (Degree)	Raw Value (dBuV)	Correction Factor (dB/m)
1	166.072	29.60 QP	43.50	-13.90	1.00 V	301	15.80	13.80
2	199.118	29.40 QP	43.50	-14.10	1.00 V	55	17.72	11.69
3	280.762	31.42 QP	46.00	-14.58	1.44 V	193	15.73	15.69
4	399.339	32.79 QP	46.00	-13.21	1.63 V	172	13.93	18.86
5	465.431	32.68 QP	46.00	-13.32	1.00 V	166	12.22	20.46
6	735.631	31.41 QP	46.00	-14.59	1.55 V	217	6.01	25.40

- REMARKS:**
1. Emission level (dBuV/m) = Raw Value (dBuV) + Correction Factor (dB/m).
 2. Correction Factor (dB/m) = Antenna Factor (dB/m) + Cable Factor (dB).
 3. The other emission levels were very low against the limit.
 4. Margin value = Emission level – Limit value.



TEST MODE	B	CHANNEL	0
MODULATION TYPE	GFSK	FREQUENCY RANGE	Below 1000MHz
INPUT POWER (SYSTEM)	120Vac, 60 Hz	DETECTOR FUNCTION	Quasi-Peak
ENVIRONMENTAL CONDITIONS	24deg. C, 85% RH, 1002hPa	TESTED BY	Chad Lee

ANTENNA POLARITY & TEST DISTANCE: HORIZONTAL AT 3 M

No.	Freq. (MHz)	Emission Level (dBuV/m)	Limit (dBuV/m)	Margin (dB)	Antenna Height (m)	Table Angle (Degree)	Raw Value (dBuV)	Correction Factor (dB/m)
1	108.297	36.34 QP	43.50	-7.16	1.00 H	271	24.21	12.13
2	119.419	35.13 QP	43.50	-8.37	1.50 H	202	21.91	13.22
3	164.128	35.74 QP	43.50	-7.76	1.62 H	169	21.81	13.93
4	210.782	33.65 QP	43.50	-9.85	1.00 H	274	21.23	12.42
5	249.659	39.67 QP	46.00	-6.33	1.00 H	157	24.48	15.19
6	867.816	36.77 QP	46.00	-9.23	1.00 H	127	8.82	27.95

ANTENNA POLARITY & TEST DISTANCE: VERTICAL AT 3 M

No.	Freq. (MHz)	Emission Level (dBuV/m)	Limit (dBuV/m)	Margin (dB)	Antenna Height (m)	Table Angle (Degree)	Raw Value (dBuV)	Correction Factor (dB/m)
1	43.607	35.90 QP	40.00	-4.10	1.00 V	274	21.08	14.82
2	94.148	35.44 QP	43.50	-8.06	1.04 V	259	24.89	10.55
3	125.251	35.96 QP	43.50	-7.54	1.05 V	262	22.44	13.52
4	133.026	37.39 QP	43.50	-6.11	1.07 V	70	23.50	13.89
5	166.072	36.45 QP	43.50	-7.05	1.09 V	229	22.65	13.80
6	249.659	37.99 QP	46.00	-8.01	1.46 V	130	22.80	15.19

- REMARKS:**
1. Emission level (dBuV/m) = Raw Value (dBuV) + Correction Factor (dB/m).
 2. Correction Factor (dB/m) = Antenna Factor (dB/m) + Cable Factor (dB).
 3. The other emission levels were very low against the limit.
 4. Margin value = Emission level – Limit value.



RADIATED DATA: FOR GFSK (ABOVE 1GHz)

TEST MODE	A	CHANNEL	0
MODULATION TYPE	GFSK	FREQUENCY RANGE	1 ~ 25GHz
INPUT POWER (SYSTEM)	120Vac, 60 Hz	DETECTOR FUNCTION	Peak (PK) Average (AV)
ENVIRONMENTAL CONDITIONS	27deg. C, 68% RH, 995hPa	TESTED BY	Chad Lee

ANTENNA POLARITY & TEST DISTANCE: HORIZONTAL AT 3 M

No.	Freq. (MHz)	Emission Level (dBuV/m)	Limit (dBuV/m)	Margin (dB)	Antenna Height (m)	Table Angle (Degree)	Raw Value (dBuV)	Correction Factor (dB/m)
1	1602.000	54.54 PK	74.00	-19.46	1.00 H	265	22.16	32.38
2	1602.000	52.60 AV	54.00	-1.40	1.00 H	265	20.22	32.38
3	2390.000	59.02 PK	74.00	-14.98	1.18 H	328	24.36	34.66
4	2390.000	28.92 AV	54.00	-25.08	1.18 H	328	-5.74	34.66
5	*2402.000	95.35 PK			1.18 H	328	60.66	34.69
6	*2402.000	65.25 AV			1.18 H	328	30.56	34.69
7	3204.000	53.78 PK	74.00	-20.22	1.04 H	300	15.65	38.13
8	3204.000	46.97 AV	54.00	-7.03	1.04 H	300	8.84	38.13
9	4804.000	63.14 PK	74.00	-10.86	1.03 H	6	21.23	41.91
10	4804.000	33.04 AV	54.00	-20.96	1.03 H	6	-8.87	41.91
11	7206.000	57.25 PK	74.00	-16.75	1.00 H	21	10.06	47.19
12	7206.000	27.15 AV	54.00	-26.85	1.00 H	21	-20.04	47.19

ANTENNA POLARITY & TEST DISTANCE: VERTICAL AT 3 M

No.	Freq. (MHz)	Emission Level (dBuV/m)	Limit (dBuV/m)	Margin (dB)	Antenna Height (m)	Table Angle (Degree)	Raw Value (dBuV)	Correction Factor (dB/m)
1	1602.000	46.79 PK	74.00	-27.21	1.05 V	64	14.41	32.38
2	1602.000	41.21 AV	54.00	-12.79	1.05 V	64	8.83	32.38
3	2390.000	58.71 PK	74.00	-15.29	1.00 V	23	24.05	34.66
4	2390.000	28.61 AV	54.00	-25.39	1.00 V	23	-6.05	34.66
5	*2402.000	89.71 PK			1.00 V	23	55.02	34.69
6	*2402.000	59.61 AV			1.00 V	23	24.92	34.69
7	3204.000	52.63 PK	74.00	-21.37	1.12 V	36	14.50	38.13
8	3204.000	44.84 AV	54.00	-9.16	1.12 V	36	6.71	38.13
9	4804.000	67.51 PK	74.00	-6.49	1.00 V	7	25.60	41.91
10	4804.000	37.41 AV	54.00	-16.59	1.00 V	7	-4.50	41.91
11	7206.000	60.89 PK	74.00	-13.11	4.00 V	3	13.70	47.19
12	7206.000	30.79 AV	54.00	-23.21	4.00 V	3	-16.40	47.19

- REMARKS:**
1. Emission level (dBuV/m) = Raw Value (dBuV) + Correction Factor (dB/m).
 2. Correction Factor (dB/m) = Antenna Factor (dB/m) + Cable Factor (dB).
 3. The other emission levels were very low against the limit.
 4. Margin value = Emission level – Limit value.
 5. The DH5 packet was the worse case duty cycle for a transmit dwell time on a channel, based upon bluetooth theory the transmitter is on 0.625 * 5 per 296.25 ms per channel. Therefore, the duty cycle be equal to: $20\log(3.125/100) = -30.1$ dB.
 6. Average value = peak reading + $20\log(\text{duty cycle})$.



TEST MODE	A	CHANNEL	39
MODULATION TYPE	GFSK	FREQUENCY RANGE	1 ~ 25GHz
INPUT POWER (SYSTEM)	120Vac, 60 Hz	DETECTOR FUNCTION	Peak (PK) Average (AV)
ENVIRONMENTAL CONDITIONS	27deg. C, 68% RH, 995hPa	TESTED BY	Chad Lee

ANTENNA POLARITY & TEST DISTANCE: HORIZONTAL AT 3 M

No.	Freq. (MHz)	Emission Level (dBuV/m)	Limit (dBuV/m)	Margin (dB)	Antenna Height (m)	Table Angle (Degree)	Raw Value (dBuV)	Correction Factor (dB/m)
1	1628.000	53.94 PK	74.00	-20.06	1.00 H	265	21.46	32.48
2	1628.000	52.06 AV	54.00	-1.94	1.00 H	265	19.58	32.48
3	*2441.000	93.79 PK			1.00 H	151	59.02	34.77
4	*2441.000	63.69 AV			1.00 H	151	28.92	34.77
5	3256.000	51.52 PK	74.00	-22.48	1.00 H	243	13.25	38.27
6	3256.000	44.08 AV	54.00	-9.92	1.00 H	243	5.81	38.27
7	4882.000	67.77 PK	74.00	-6.23	1.28 H	9	25.64	42.13
8	4882.000	37.67 AV	54.00	-16.33	1.28 H	9	-4.46	42.13
9	7323.000	58.43 PK	74.00	-15.57	1.17 H	318	10.80	47.63
10	7323.000	28.33 AV	54.00	-25.67	1.17 H	318	-19.30	47.63

ANTENNA POLARITY & TEST DISTANCE: VERTICAL AT 3 M

No.	Freq. (MHz)	Emission Level (dBuV/m)	Limit (dBuV/m)	Margin (dB)	Antenna Height (m)	Table Angle (Degree)	Raw Value (dBuV)	Correction Factor (dB/m)
1	1628.000	45.14 PK	74.00	-28.86	1.04 V	67	12.66	32.48
2	1628.000	38.57 AV	54.00	-15.43	1.04 V	67	6.09	32.48
3	*2441.000	89.91 PK			1.00 V	13	55.14	34.77
4	*2441.000	59.81 AV			1.00 V	13	25.04	34.77
5	3256.000	50.52 PK	74.00	-23.48	1.00 V	114	12.25	38.27
6	3256.000	40.34 AV	54.00	-13.66	1.00 V	114	2.07	38.27
7	4882.000	70.54 PK	74.00	-3.46	1.12 V	337	28.41	42.13
8	4882.000	40.44 AV	54.00	-13.56	1.12 V	337	-1.69	42.13
9	7323.000	60.61 PK	74.00	-13.39	1.00 V	22	12.98	47.63
10	7323.000	30.51 AV	54.00	-23.49	1.00 V	22	-17.12	47.63

- REMARKS:**
1. Emission level (dBuV/m) = Raw Value (dBuV) + Correction Factor (dB/m).
 2. Correction Factor (dB/m) = Antenna Factor (dB/m) + Cable Factor (dB).
 3. The other emission levels were very low against the limit.
 4. Margin value = Emission level – Limit value.
 5. The DH5 packet was the worse case duty cycle for a transmit dwell time on a channel, based upon bluetooth theory the transmitter is on 0.625 * 5 per 296.25 ms per channel. Therefore, the duty cycle be equal to: $20\log(3.125/100) = -30.1$ dB.
 6. Average value = peak reading + $20\log(\text{duty cycle})$.



TEST MODE	A	CHANNEL	78
MODULATION TYPE	GFSK	FREQUENCY RANGE	1 ~ 25GHz
INPUT POWER (SYSTEM)	120Vac, 60 Hz	DETECTOR FUNCTION	Peak (PK) Average (AV)
ENVIRONMENTAL CONDITIONS	27deg. C, 68% RH, 995hPa	TESTED BY	Chad Lee

ANTENNA POLARITY & TEST DISTANCE: HORIZONTAL AT 3 M

No.	Freq. (MHz)	Emission Level (dBuV/m)	Limit (dBuV/m)	Margin (dB)	Antenna Height (m)	Table Angle (Degree)	Raw Value (dBuV)	Correction Factor (dB/m)
1	1654.000	52.73 PK	74.00	-21.27	1.00 H	265	20.16	32.57
2	1654.000	50.75 AV	54.00	-3.25	1.00 H	265	18.18	32.57
3	*2480.000	92.82 PK			1.28 H	289	57.97	34.85
4	*2480.000	62.72 AV			1.28 H	289	27.87	34.85
5	2483.500	51.23 PK	74.00	-22.77	1.28 H	289	16.37	34.86
6	2483.500	21.13 AV	54.00	-32.87	1.28 H	289	-13.73	34.86
7	3308.000	48.60 PK	74.00	-25.40	1.00 H	155	10.18	38.42
8	3308.000	36.67 AV	54.00	-17.33	1.00 H	155	-1.75	38.42
9	4960.000	68.18 PK	74.00	-5.82	1.00 H	9	25.84	42.35
10	4960.000	38.08 AV	54.00	-15.92	1.00 H	9	-4.26	42.35
11	7440.000	57.88 PK	74.00	-16.12	1.15 H	319	9.82	48.07
12	7440.000	27.78 AV	54.00	-26.22	1.15 H	319	-20.28	48.07

ANTENNA POLARITY & TEST DISTANCE: VERTICAL AT 3 M

No.	Freq. (MHz)	Emission Level (dBuV/m)	Limit (dBuV/m)	Margin (dB)	Antenna Height (m)	Table Angle (Degree)	Raw Value (dBuV)	Correction Factor (dB/m)
1	1654.000	49.98 PK	74.00	-24.02	1.00 V	60	17.41	32.57
2	1654.000	43.34 AV	54.00	-10.66	1.00 V	60	10.77	32.57
3	*2480.000	88.98 PK			1.00 V	180	54.13	34.85
4	*2480.000	58.88 AV			1.00 V	180	24.03	34.85
5	2483.500	48.96 PK	74.00	-25.04	1.00 V	180	14.10	34.86
6	2483.500	18.86 AV	54.00	-35.14	1.00 V	180	-16.00	34.86
7	3308.000	47.36 PK	74.00	-26.64	1.18 V	185	8.94	38.42
8	3308.000	37.25 AV	54.00	-16.75	1.18 V	185	-1.17	38.42
9	4960.000	72.43 PK	74.00	-1.57	1.00 V	176	30.09	42.35
10	4960.000	42.33 AV	54.00	-11.67	1.00 V	176	-0.01	42.35
11	7440.000	60.52 PK	74.00	-13.48	1.13 V	108	12.46	48.07
12	7440.000	30.42 AV	54.00	-23.58	1.13 V	108	-17.64	48.07

- REMARKS:**
1. Emission level (dBuV/m) = Raw Value (dBuV) + Correction Factor (dB/m).
 2. Correction Factor (dB/m) = Antenna Factor (dB/m) + Cable Factor (dB).
 3. The other emission levels were very low against the limit.
 4. Margin value = Emission level – Limit value.
 5. The DH5 packet was the worse case duty cycle for a transmit dwell time on a channel, based upon bluetooth theory the transmitter is on $0.625 * 5$ per 296.25 ms per channel. Therefore, the duty cycle be equal to: $20\log(3.125/100) = -30.1$ dB.
 6. Average value = peak reading + $20\log(\text{duty cycle})$.



TEST MODE	B	CHANNEL	0
MODULATION TYPE	GFSK	FREQUENCY RANGE	1 ~ 25GHz
INPUT POWER (SYSTEM)	120Vac, 60 Hz	DETECTOR FUNCTION	Peak (PK) Average (AV)
ENVIRONMENTAL CONDITIONS	24deg. C, 85% RH, 1001hPa	TESTED BY	Chad Lee

ANTENNA POLARITY & TEST DISTANCE: HORIZONTAL AT 3 M

No.	Freq. (MHz)	Emission Level (dBuV/m)	Limit (dBuV/m)	Margin (dB)	Antenna Height (m)	Table Angle (Degree)	Raw Value (dBuV)	Correction Factor (dB/m)
1	1602.000	49.97 PK	74.00	-24.03	1.00 H	266	18.70	31.27
2	1602.000	46.63 AV	54.00	-7.37	1.00 H	266	15.36	31.27
3	2390.000	57.47 PK	74.00	-16.53	1.20 H	128	24.17	33.30
4	2390.000	27.37 AV	54.00	-26.63	1.20 H	128	-5.93	33.30
5	*2402.000	100.86 PK			1.20 H	128	67.51	33.35
6	*2402.000	70.76 AV			1.20 H	128	37.41	33.35
7	4804.000	64.75 PK	74.00	-9.25	1.12 H	127	24.36	40.39
8	4804.000	34.65 AV	54.00	-19.35	1.12 H	127	-5.74	40.39

ANTENNA POLARITY & TEST DISTANCE: VERTICAL AT 3 M

No.	Freq. (MHz)	Emission Level (dBuV/m)	Limit (dBuV/m)	Margin (dB)	Antenna Height (m)	Table Angle (Degree)	Raw Value (dBuV)	Correction Factor (dB/m)
1	1602.000	46.47 PK	74.00	-27.53	1.00 V	191	15.20	31.27
2	1602.000	41.10 AV	54.00	-12.90	1.00 V	191	9.83	31.27
3	2390.000	57.56 PK	74.00	-16.44	1.01 V	252	24.26	33.30
4	2390.000	27.46 AV	54.00	-26.54	1.01 V	252	-5.84	33.30
5	*2402.000	95.56 PK			1.01 V	252	62.21	33.35
6	*2402.000	65.46 AV			1.01 V	252	32.11	33.35
7	4804.000	63.47 PK	74.00	-10.53	1.00 V	18	23.08	40.39
8	4804.000	33.37 AV	54.00	-20.63	1.00 V	18	-7.02	40.39

- REMARKS:**
1. Emission level (dBuV/m) = Raw Value (dBuV) + Correction Factor (dB/m).
 2. Correction Factor (dB/m) = Antenna Factor (dB/m) + Cable Factor (dB).
 3. The other emission levels were very low against the limit.
 4. Margin value = Emission level – Limit value.
 5. The DH5 packet was the worse case duty cycle for a transmit dwell time on a channel, based upon bluetooth theory the transmitter is on 0.625 * 5 per 296.25 ms per channel. Therefore, the duty cycle be equal to: $20\log(3.125/100) = -30.1$ dB.
 6. Average value = peak reading + $20\log(\text{duty cycle})$.



TEST MODE	B	CHANNEL	39
MODULATION TYPE	GFSK	FREQUENCY RANGE	1 ~ 25GHz
INPUT POWER (SYSTEM)	120Vac, 60 Hz	DETECTOR FUNCTION	Peak (PK) Average (AV)
ENVIRONMENTAL CONDITIONS	24deg. C, 85% RH, 1001hPa	TESTED BY	Chad Lee

ANTENNA POLARITY & TEST DISTANCE: HORIZONTAL AT 3 M

No.	Freq. (MHz)	Emission Level (dBuV/m)	Limit (dBuV/m)	Margin (dB)	Antenna Height (m)	Table Angle (Degree)	Raw Value (dBuV)	Correction Factor (dB/m)
1	1628.000	49.19 PK	74.00	-24.81	1.00 H	276	17.90	31.29
2	1628.000	46.24 AV	54.00	-7.76	1.00 H	276	14.95	31.29
3	*2441.000	103.17 PK			1.15 H	131	69.64	33.53
4	*2441.000	73.07 AV			1.15 H	131	39.54	33.53
5	4882.000	66.69 PK	74.00	-7.31	1.09 H	175	26.12	40.57
6	4882.000	36.59 AV	54.00	-17.41	1.09 H	175	-3.98	40.57

ANTENNA POLARITY & TEST DISTANCE: VERTICAL AT 3 M

No.	Freq. (MHz)	Emission Level (dBuV/m)	Limit (dBuV/m)	Margin (dB)	Antenna Height (m)	Table Angle (Degree)	Raw Value (dBuV)	Correction Factor (dB/m)
1	1628.000	46.58 PK	74.00	-27.42	1.00 V	142	15.29	31.29
2	1628.000	41.07 AV	54.00	-12.93	1.00 V	142	9.78	31.29
3	*2441.000	96.95 PK			1.00 V	250	63.42	33.53
4	*2441.000	66.85 AV			1.00 V	250	33.32	33.53
5	4882.000	63.02 PK	74.00	-10.98	1.00 V	260	22.45	40.57
6	4882.000	32.92 AV	54.00	-21.08	1.00 V	260	-7.65	40.57

- REMARKS:**
1. Emission level (dBuV/m) = Raw Value (dBuV) + Correction Factor (dB/m).
 2. Correction Factor (dB/m) = Antenna Factor (dB/m) + Cable Factor (dB).
 3. The other emission levels were very low against the limit.
 4. Margin value = Emission level – Limit value.
 5. The DH5 packet was the worse case duty cycle for a transmit dwell time on a channel, based upon bluetooth theory the transmitter is on 0.625 * 5 per 296.25 ms per channel. Therefore, the duty cycle be equal to: $20\log(3.125/100) = -30.1$ dB.
 6. Average value = peak reading + $20\log(\text{duty cycle})$.



TEST MODE	B	CHANNEL	78
MODULATION TYPE	GFSK	FREQUENCY RANGE	1 ~ 25GHz
INPUT POWER (SYSTEM)	120Vac, 60 Hz	DETECTOR FUNCTION	Peak (PK) Average (AV)
ENVIRONMENTAL CONDITIONS	24deg. C, 85% RH, 1001hPa	TESTED BY	Chad Lee

ANTENNA POLARITY & TEST DISTANCE: HORIZONTAL AT 3 M

No.	Freq. (MHz)	Emission Level (dBuV/m)	Limit (dBuV/m)	Margin (dB)	Antenna Height (m)	Table Angle (Degree)	Raw Value (dBuV)	Correction Factor (dB/m)
1	1654.000	49.13 PK	74.00	-24.87	1.00 H	279	17.82	31.31
2	1654.000	45.14 AV	54.00	-8.86	1.00 H	279	13.83	31.31
3	*2480.000	100.97 PK			1.11 H	163	67.27	33.70
4	*2480.000	70.87 AV			1.11 H	163	37.17	33.70
5	2483.500	69.92 PK	74.00	-4.08	1.11 H	163	36.20	33.72
6	2483.500	39.82 AV	54.00	-14.18	1.11 H	163	6.10	33.72
7	4960.000	61.29 PK	74.00	-12.71	1.00 H	133	20.53	40.76
8	4960.000	31.19 AV	54.00	-22.81	1.00 H	133	-9.57	40.76

ANTENNA POLARITY & TEST DISTANCE: VERTICAL AT 3 M

No.	Freq. (MHz)	Emission Level (dBuV/m)	Limit (dBuV/m)	Margin (dB)	Antenna Height (m)	Table Angle (Degree)	Raw Value (dBuV)	Correction Factor (dB/m)
1	1654.000	46.90 PK	74.00	-27.10	1.00 V	145	15.59	31.31
2	1654.000	41.39 AV	54.00	-12.61	1.00 V	145	10.08	31.31
3	*2480.000	94.16 PK			1.09 V	167	60.46	33.70
4	*2480.000	64.06 AV			1.09 V	167	30.36	33.70
5	2483.500	69.31 PK	74.00	-4.69	1.09 V	167	35.59	33.72
6	2483.500	39.21 AV	54.00	-14.79	1.09 V	167	5.49	33.72
7	4960.000	62.99 PK	74.00	-11.01	1.00 V	300	22.23	40.76
8	4960.000	32.89 AV	54.00	-21.11	1.00 V	300	-7.87	40.76

- REMARKS:**
1. Emission level (dBuV/m) = Raw Value (dBuV) + Correction Factor (dB/m).
 2. Correction Factor (dB/m) = Antenna Factor (dB/m) + Cable Factor (dB).
 3. The other emission levels were very low against the limit.
 4. Margin value = Emission level – Limit value.
 5. The DH5 packet was the worse case duty cycle for a transmit dwell time on a channel, based upon bluetooth theory the transmitter is on $0.625 * 5$ per 296.25 ms per channel. Therefore, the duty cycle be equal to: $20\log(3.125/100) = -30.1$ dB.
 6. Average value = peak reading + $20\log(\text{duty cycle})$.



RADIATED DATA: FOR 8DPSK (ABOVE 1GHz)

TEST MODE	A	CHANNEL	0
MODULATION TYPE	8DPSK	FREQUENCY RANGE	1 ~ 25GHz
INPUT POWER (SYSTEM)	120Vac, 60 Hz	DETECTOR FUNCTION	Peak (PK) Average (AV)
ENVIRONMENTAL CONDITIONS	27deg. C, 68% RH, 995hPa	TESTED BY	Chad Lee

ANTENNA POLARITY & TEST DISTANCE: HORIZONTAL AT 3 M

No.	Freq. (MHz)	Emission Level (dBuV/m)	Limit (dBuV/m)	Margin (dB)	Antenna Height (m)	Table Angle (Degree)	Raw Value (dBuV)	Correction Factor (dB/m)
1	1602.000	54.80 PK	74.00	-19.20	1.00 H	267	22.42	32.38
2	1602.000	53.18 AV	54.00	-0.82	1.00 H	267	20.80	32.38
3	2390.000	57.79 PK	74.00	-16.21	1.00 H	151	23.13	34.66
4	2390.000	27.69 AV	54.00	-26.31	1.00 H	151	-6.97	34.66
5	*2402.000	93.08 PK			1.00 H	151	58.39	34.69
6	*2402.000	62.98 AV			1.00 H	151	28.29	34.69
7	3204.000	51.17 PK	74.00	-22.83	1.00 H	242	13.04	38.13
8	3204.000	45.23 AV	54.00	-8.77	1.00 H	242	7.10	38.13
9	4804.000	57.83 PK	74.00	-16.17	1.14 H	246	15.92	41.91
10	4804.000	27.73 AV	54.00	-26.27	1.14 H	246	-14.18	41.91
11	7206.000	56.23 PK	74.00	-17.77	1.08 H	35	9.04	47.19
12	7206.000	26.13 AV	54.00	-27.87	1.08 H	35	-21.06	47.19

ANTENNA POLARITY & TEST DISTANCE: VERTICAL AT 3 M

No.	Freq. (MHz)	Emission Level (dBuV/m)	Limit (dBuV/m)	Margin (dB)	Antenna Height (m)	Table Angle (Degree)	Raw Value (dBuV)	Correction Factor (dB/m)
1	1602.000	46.73 PK	74.00	-27.27	1.18 V	175	14.35	32.38
2	1602.000	42.40 AV	54.00	-11.60	1.18 V	175	10.02	32.38
3	2390.000	58.07 PK	74.00	-15.93	1.43 V	20	23.41	34.66
4	2390.000	27.97 AV	54.00	-26.03	1.43 V	20	-6.69	34.66
5	*2402.000	86.62 PK			1.43 V	20	51.93	34.69
6	*2402.000	56.52 AV			1.43 V	20	21.83	34.69
7	3204.000	49.58 PK	74.00	-24.42	1.21 V	206	11.45	38.13
8	3204.000	40.20 AV	54.00	-13.80	1.21 V	206	2.07	38.13
9	4804.000	61.21 PK	74.00	-12.79	1.00 V	2	19.30	41.91
10	4804.000	31.11 AV	54.00	-22.89	1.00 V	2	-10.80	41.91
11	7206.000	56.33 PK	74.00	-17.67	1.00 V	152	9.14	47.19
12	7206.000	26.23 AV	54.00	-27.77	1.00 V	152	-20.96	47.19

- REMARKS:**
1. Emission level (dBuV/m) = Raw Value (dBuV) + Correction Factor (dB/m).
 2. Correction Factor (dB/m) = Antenna Factor (dB/m) + Cable Factor (dB).
 3. The other emission levels were very low against the limit.
 4. Margin value = Emission level – Limit value.
 5. The DH5 packet was the worse case duty cycle for a transmit dwell time on a channel, based upon bluetooth theory the transmitter is on 0.625 * 5 per 296.25 ms per channel. Therefore, the duty cycle be equal to: $20\log(3.125/100) = -30.1$ dB.
 6. Average value = peak reading + $20\log(\text{duty cycle})$.



TEST MODE	A	CHANNEL	39
MODULATION TYPE	8DPSK	FREQUENCY RANGE	1 ~ 25GHz
INPUT POWER (SYSTEM)	120Vac, 60 Hz	DETECTOR FUNCTION	Peak (PK) Average (AV)
ENVIRONMENTAL CONDITIONS	27deg. C, 68% RH, 995hPa	TESTED BY	Chad Lee

ANTENNA POLARITY & TEST DISTANCE: HORIZONTAL AT 3 M

No.	Freq. (MHz)	Emission Level (dBuV/m)	Limit (dBuV/m)	Margin (dB)	Antenna Height (m)	Table Angle (Degree)	Raw Value (dBuV)	Correction Factor (dB/m)
1	1628.000	52.27 PK	74.00	-21.73	1.03 H	90	19.79	32.48
2	1628.000	49.26 AV	54.00	-4.74	1.03 H	90	16.78	32.48
3	*2441.000	91.91 PK			1.00 H	258	57.14	34.77
4	*2441.000	61.81 AV			1.00 H	258	27.04	34.77
5	3256.000	50.74 PK	74.00	-23.26	1.00 H	120	12.47	38.27
6	3256.000	42.47 AV	54.00	-11.53	1.00 H	120	4.20	38.27
7	4882.000	61.48 PK	74.00	-12.52	1.00 H	10	19.35	42.13
8	4882.000	31.38 AV	54.00	-22.62	1.00 H	10	-10.75	42.13
9	7323.000	54.80 PK	74.00	-19.20	1.00 H	1	7.17	47.63
10	7323.000	24.70 AV	54.00	-29.30	1.00 H	1	-22.93	47.63

ANTENNA POLARITY & TEST DISTANCE: VERTICAL AT 3 M

No.	Freq. (MHz)	Emission Level (dBuV/m)	Limit (dBuV/m)	Margin (dB)	Antenna Height (m)	Table Angle (Degree)	Raw Value (dBuV)	Correction Factor (dB/m)
1	1628.000	45.22 PK	74.00	-28.78	1.00 V	132	12.74	32.48
2	1628.000	39.29 AV	54.00	-14.71	1.00 V	132	6.81	32.48
3	*2441.000	87.07 PK			1.00 V	23	52.30	34.77
4	*2441.000	56.97 AV			1.00 V	23	22.20	34.77
5	3256.000	50.44 PK	74.00	-23.56	1.20 V	160	12.17	38.27
6	3256.000	41.24 AV	54.00	-12.76	1.20 V	160	2.97	38.27
7	4882.000	63.47 PK	74.00	-10.53	1.00 V	355	21.34	42.13
8	4882.000	33.37 AV	54.00	-20.63	1.00 V	355	-8.76	42.13
9	7323.000	56.53 PK	74.00	-17.47	1.00 V	15	8.90	47.63
10	7323.000	26.43 AV	54.00	-27.57	1.00 V	15	-21.20	47.63

- REMARKS:**
1. Emission level (dBuV/m) = Raw Value (dBuV) + Correction Factor (dB/m).
 2. Correction Factor (dB/m) = Antenna Factor (dB/m) + Cable Factor (dB).
 3. The other emission levels were very low against the limit.
 4. Margin value = Emission level – Limit value.
 5. The DH5 packet was the worse case duty cycle for a transmit dwell time on a channel, based upon bluetooth theory the transmitter is on 0.625 * 5 per 296.25 ms per channel. Therefore, the duty cycle be equal to: $20\log(3.125/100) = -30.1$ dB.
 6. Average value = peak reading + $20\log(\text{duty cycle})$.



TEST MODE	A	CHANNEL	78
MODULATION TYPE	8DPSK	FREQUENCY RANGE	1 ~ 25GHz
INPUT POWER (SYSTEM)	120Vac, 60 Hz	DETECTOR FUNCTION	Peak (PK) Average (AV)
ENVIRONMENTAL CONDITIONS	27deg. C, 68% RH, 995hPa	TESTED BY	Chad Lee

ANTENNA POLARITY & TEST DISTANCE: HORIZONTAL AT 3 M

No.	Freq. (MHz)	Emission Level (dBuV/m)	Limit (dBuV/m)	Margin (dB)	Antenna Height (m)	Table Angle (Degree)	Raw Value (dBuV)	Correction Factor (dB/m)
1	1654.000	53.38 PK	74.00	-20.62	1.02 H	264	20.81	32.57
2	1654.000	51.64 AV	54.00	-2.36	1.02 H	264	19.07	32.57
3	*2480.000	91.05 PK			1.00 H	152	56.20	34.85
4	*2480.000	60.95 AV			1.00 H	152	26.10	34.85
5	2483.500	50.52 PK	74.00	-23.48	1.00 H	152	15.66	34.86
6	2483.500	20.42 AV	54.00	-33.58	1.00 H	152	-14.44	34.86
7	3308.000	49.44 PK	74.00	-24.56	1.00 H	245	11.02	38.42
8	3308.000	40.71 AV	54.00	-13.29	1.00 H	245	2.29	38.42
9	4960.000	62.79 PK	74.00	-11.21	1.00 H	360	20.45	42.35
10	4960.000	32.69 AV	54.00	-21.31	1.00 H	360	-9.65	42.35
11	7440.000	56.61 PK	74.00	-17.39	1.00 H	3	8.55	48.07
12	7440.000	26.51 AV	54.00	-27.49	1.00 H	3	-21.55	48.07

ANTENNA POLARITY & TEST DISTANCE: VERTICAL AT 3 M

No.	Freq. (MHz)	Emission Level (dBuV/m)	Limit (dBuV/m)	Margin (dB)	Antenna Height (m)	Table Angle (Degree)	Raw Value (dBuV)	Correction Factor (dB/m)
1	1654.000	45.66 PK	74.00	-28.34	1.00 V	61	13.09	32.57
2	1654.000	38.97 AV	54.00	-15.03	1.00 V	61	6.40	32.57
3	*2480.000	86.91 PK			1.00 V	208	52.06	34.85
4	*2480.000	56.81 AV			1.00 V	208	21.96	34.85
5	2483.500	45.82 PK	74.00	-28.18	1.00 V	208	10.96	34.86
6	2483.500	15.72 AV	54.00	-38.28	1.00 V	208	-19.14	34.86
7	3308.000	49.07 PK	74.00	-24.93	1.22 V	333	10.65	38.42
8	3308.000	37.60 AV	54.00	-16.40	1.22 V	333	-0.82	38.42
9	4960.000	66.60 PK	74.00	-7.40	1.00 V	175	24.26	42.35
10	4960.000	36.50 AV	54.00	-17.50	1.00 V	175	-5.84	42.35
11	7440.000	56.75 PK	74.00	-17.25	1.00 V	74	8.69	48.07
12	7440.000	26.65 AV	54.00	-27.35	1.00 V	74	-21.41	48.07

- REMARKS:**
1. Emission level (dBuV/m) = Raw Value (dBuV) + Correction Factor (dB/m).
 2. Correction Factor (dB/m) = Antenna Factor (dB/m) + Cable Factor (dB).
 3. The other emission levels were very low against the limit.
 4. Margin value = Emission level – Limit value.
 5. The DH5 packet was the worse case duty cycle for a transmit dwell time on a channel, based upon bluetooth theory the transmitter is on $0.625 * 5$ per 296.25 ms per channel. Therefore, the duty cycle be equal to: $20\log(3.125/100) = -30.1$ dB.
 6. Average value = peak reading + $20\log(\text{duty cycle})$.



TEST MODE	B	CHANNEL	0
MODULATION TYPE	8DPSK	FREQUENCY RANGE	1 ~ 25GHz
INPUT POWER (SYSTEM)	120Vac, 60 Hz	DETECTOR FUNCTION	Peak (PK) Average (AV)
ENVIRONMENTAL CONDITIONS	24deg. C, 85% RH, 1001hPa	TESTED BY	Chad Lee

ANTENNA POLARITY & TEST DISTANCE: HORIZONTAL AT 3 M

No.	Freq. (MHz)	Emission Level (dBuV/m)	Limit (dBuV/m)	Margin (dB)	Antenna Height (m)	Table Angle (Degree)	Raw Value (dBuV)	Correction Factor (dB/m)
1	1602.000	50.53 PK	74.00	-23.47	1.00 H	277	19.26	31.27
2	1602.000	47.34 AV	54.00	-6.66	1.00 H	277	16.07	31.27
3	2390.000	58.35 PK	74.00	-15.65	1.44 H	131	25.05	33.30
4	2390.000	28.29 AV	54.00	-25.71	1.44 H	131	-5.01	33.30
5	*2402.000	98.93 PK			1.44 H	131	65.58	33.35
6	*2402.000	68.83 AV			1.44 H	131	35.48	33.35
7	4804.000	58.18 PK	74.00	-15.82	1.08 H	126	17.79	40.39
8	4804.000	28.08 AV	54.00	-25.92	1.08 H	126	-12.31	40.39

ANTENNA POLARITY & TEST DISTANCE: VERTICAL AT 3 M

No.	Freq. (MHz)	Emission Level (dBuV/m)	Limit (dBuV/m)	Margin (dB)	Antenna Height (m)	Table Angle (Degree)	Raw Value (dBuV)	Correction Factor (dB/m)
1	1602.000	46.62 PK	74.00	-27.38	1.00 V	193	15.35	31.27
2	1602.000	41.91 AV	54.00	-12.09	1.00 V	193	10.64	31.27
3	2390.000	57.46 PK	74.00	-16.54	1.00 V	71	24.16	33.30
4	2390.000	27.36 AV	54.00	-26.64	1.00 V	71	-5.94	33.30
5	*2402.000	92.55 PK			1.00 V	71	59.20	33.35
6	*2402.000	62.45 AV			1.00 V	71	29.10	33.35
7	4804.000	57.30 PK	74.00	-16.70	1.00 V	273	16.91	40.39
8	4804.000	27.20 AV	54.00	-26.80	1.00 V	273	-13.19	40.39

- REMARKS:**
1. Emission level (dBuV/m) = Raw Value (dBuV) + Correction Factor (dB/m).
 2. Correction Factor (dB/m) = Antenna Factor (dB/m) + Cable Factor (dB).
 3. The other emission levels were very low against the limit.
 4. Margin value = Emission level – Limit value.
 5. The DH5 packet was the worse case duty cycle for a transmit dwell time on a channel, based upon bluetooth theory the transmitter is on $0.625 * 5$ per 296.25 ms per channel. Therefore, the duty cycle be equal to: $20\log(3.125/100) = -30.1$ dB.
 6. Average value = peak reading + $20\log(\text{duty cycle})$.



TEST MODE	B	CHANNEL	39
MODULATION TYPE	8DPSK	FREQUENCY RANGE	1 ~ 25GHz
INPUT POWER (SYSTEM)	120Vac, 60 Hz	DETECTOR FUNCTION	Peak (PK) Average (AV)
ENVIRONMENTAL CONDITIONS	24deg. C, 85% RH, 1001hPa	TESTED BY	Chad Lee

ANTENNA POLARITY & TEST DISTANCE: HORIZONTAL AT 3 M

No.	Freq. (MHz)	Emission Level (dBuV/m)	Limit (dBuV/m)	Margin (dB)	Antenna Height (m)	Table Angle (Degree)	Raw Value (dBuV)	Correction Factor (dB/m)
1	1628.000	50.06 PK	74.00	-23.94	1.06 H	100	18.77	31.29
2	1628.000	46.75 AV	54.00	-7.25	1.06 H	100	15.46	31.29
3	*2441.000	100.17 PK			1.41 H	134	66.64	33.53
4	*2441.000	70.07 AV			1.41 H	134	36.54	33.53
5	4882.000	59.59 PK	74.00	-14.41	1.00 H	90	19.02	40.57
6	4882.000	29.49 AV	54.00	-24.51	1.00 H	90	-11.08	40.57

ANTENNA POLARITY & TEST DISTANCE: VERTICAL AT 3 M

No.	Freq. (MHz)	Emission Level (dBuV/m)	Limit (dBuV/m)	Margin (dB)	Antenna Height (m)	Table Angle (Degree)	Raw Value (dBuV)	Correction Factor (dB/m)
1	1628.000	46.75 PK	74.00	-27.25	1.00 V	141	15.46	31.29
2	1628.000	41.24 AV	54.00	-12.76	1.00 V	141	9.95	31.29
3	*2441.000	94.20 PK			1.00 V	250	60.67	33.53
4	*2441.000	64.10 AV			1.00 V	250	30.57	33.53
5	4882.000	60.40 PK	74.00	-13.60	1.05 V	296	19.83	40.57
6	4882.000	30.30 AV	54.00	-23.70	1.05 V	296	-10.27	40.57

- REMARKS:**
1. Emission level (dBuV/m) = Raw Value (dBuV) + Correction Factor (dB/m).
 2. Correction Factor (dB/m) = Antenna Factor (dB/m) + Cable Factor (dB).
 3. The other emission levels were very low against the limit.
 4. Margin value = Emission level – Limit value.
 5. The DH5 packet was the worse case duty cycle for a transmit dwell time on a channel, based upon bluetooth theory the transmitter is on $0.625 * 5$ per 296.25 ms per channel. Therefore, the duty cycle be equal to: $20\log(3.125/100) = -30.1$ dB.
 6. Average value = peak reading + $20\log(\text{duty cycle})$.



TEST MODE	B	CHANNEL	78
MODULATION TYPE	8DPSK	FREQUENCY RANGE	1 ~ 25GHz
INPUT POWER (SYSTEM)	120Vac, 60 Hz	DETECTOR FUNCTION	Peak (PK) Average (AV)
ENVIRONMENTAL CONDITIONS	24deg. C, 85% RH, 1001hPa	TESTED BY	Chad Lee

ANTENNA POLARITY & TEST DISTANCE: HORIZONTAL AT 3 M

No.	Freq. (MHz)	Emission Level (dBuV/m)	Limit (dBuV/m)	Margin (dB)	Antenna Height (m)	Table Angle (Degree)	Raw Value (dBuV)	Correction Factor (dB/m)
1	1654.000	49.19 PK	74.00	-24.81	1.00 H	279	17.88	31.31
2	1654.000	45.68 AV	54.00	-8.32	1.00 H	279	14.37	31.31
3	*2480.000	100.18 PK			1.40 H	132	66.48	33.70
4	*2480.000	70.08 AV			1.40 H	132	36.38	33.70
5	2483.500	67.75 PK	74.00	-6.25	1.40 H	132	34.03	33.72
6	2483.500	37.65 AV	54.00	-16.35	1.40 H	132	3.93	33.72
7	4960.000	54.54 PK	74.00	-19.46	1.00 H	169	13.78	40.76
8	4960.000	24.44 AV	54.00	-29.56	1.00 H	169	-16.32	40.76

ANTENNA POLARITY & TEST DISTANCE: VERTICAL AT 3 M

No.	Freq. (MHz)	Emission Level (dBuV/m)	Limit (dBuV/m)	Margin (dB)	Antenna Height (m)	Table Angle (Degree)	Raw Value (dBuV)	Correction Factor (dB/m)
1	1654.000	46.74 PK	74.00	-27.26	1.00 V	141	15.43	31.31
2	1654.000	41.50 AV	54.00	-12.50	1.00 V	141	10.19	31.31
3	*2480.000	93.61 PK			1.00 V	248	59.91	33.70
4	*2480.000	63.51 AV			1.00 V	248	29.81	33.70
5	2483.500	63.14 PK	74.00	-10.86	1.00 V	248	29.42	33.72
6	2483.500	33.04 AV	54.00	-20.96	1.00 V	248	-0.68	33.72
7	4960.000	58.18 PK	74.00	-15.82	1.00 V	297	17.42	40.76
8	4960.000	28.08 AV	54.00	-25.92	1.00 V	297	-12.68	40.76

- REMARKS:**
1. Emission level (dBuV/m) = Raw Value (dBuV) + Correction Factor (dB/m).
 2. Correction Factor (dB/m) = Antenna Factor (dB/m) + Cable Factor (dB).
 3. The other emission levels were very low against the limit.
 4. Margin value = Emission level – Limit value.
 5. The DH5 packet was the worse case duty cycle for a transmit dwell time on a channel, based upon bluetooth theory the transmitter is on 0.625 * 5 per 296.25 ms per channel. Therefore, the duty cycle be equal to: $20\log(3.125/100) = -30.1$ dB.
 6. Average value = peak reading + $20\log(\text{duty cycle})$.



4.3 NUMBER OF HOPPING FREQUENCY USED

4.3.1 LIMIT OF HOPPING FREQUENCY USED

At least 15 channels frequencies, and should be equally spaced.

4.3.2 TEST INSTRUMENTS

DESCRIPTION & MANUFACTURER	MODEL NO.	SERIAL NO.	CALIBRATED DATE	CALIBRATED UNTIL
SPECTRUM ANALYZER	FSP 40	100035	Mar. 26, 2008	Mar. 25, 2009

NOTE: The calibration interval of the above test instruments is 12 months and the calibrations are traceable to NML/ROC and NIST/USA.

4.3.3 TEST PROCEDURES

- a. Check the calibration of the measuring instrument (SA) using either an internal calibrator or a known signal from an external generator.
- b. Turn on the EUT and connect its antenna terminal to measurement via a low loss cable. Then set it to any one measured frequency within its operating range and make sure the instrument is operated in its linear range.
- c. Set the SA on MaxHold Mode, and then keep the EUT in hopping mode. Record all the signals from each channel until each one has been recorded.
- d. Set the SA on View mode and then plot the result on SA screen.
- e. Repeat above procedures until all frequencies measured were complete.

4.3.4 DEVIATION FROM TEST STANDARD

No deviation.

4.3.5 TEST SETUP



4.3.6 TEST RESULTS

There are 79 hopping frequencies in the hopping mode. Please refer to next two pages for the test result. On the plots, it shows that the hopping frequencies are equally spaced.

FOR GFSK MODULATION

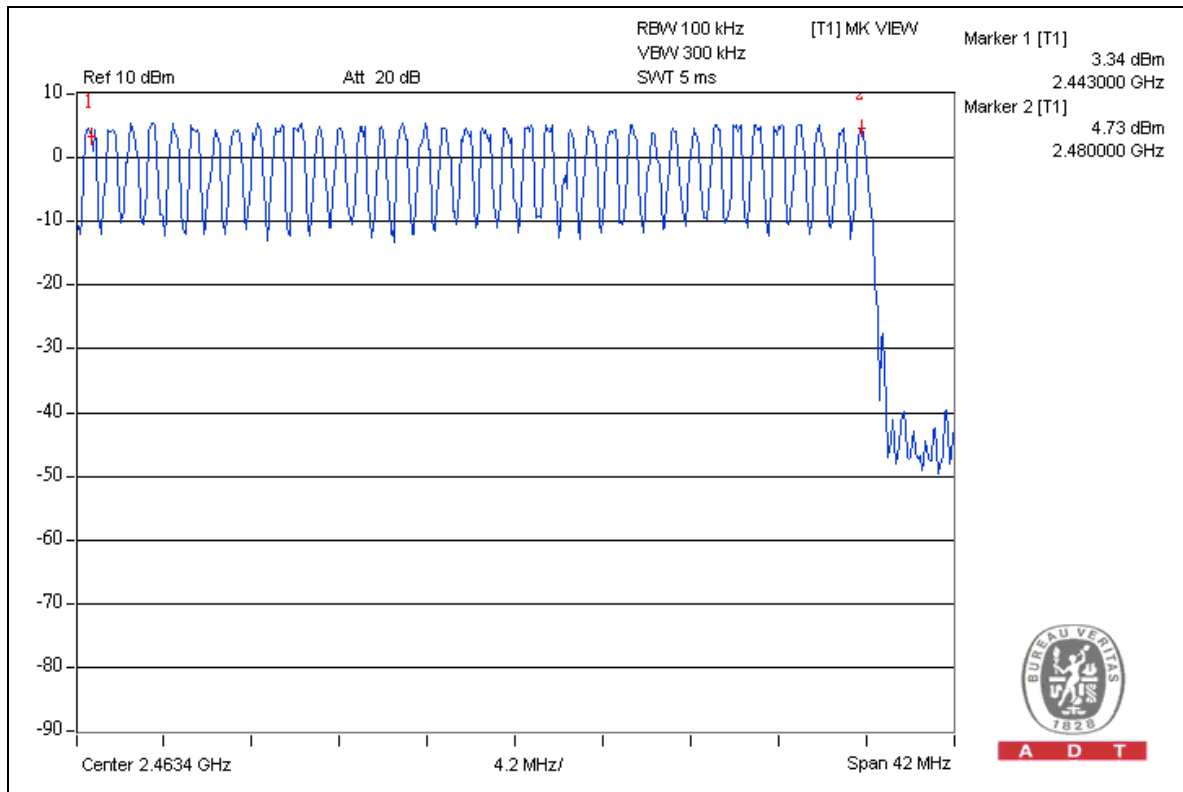
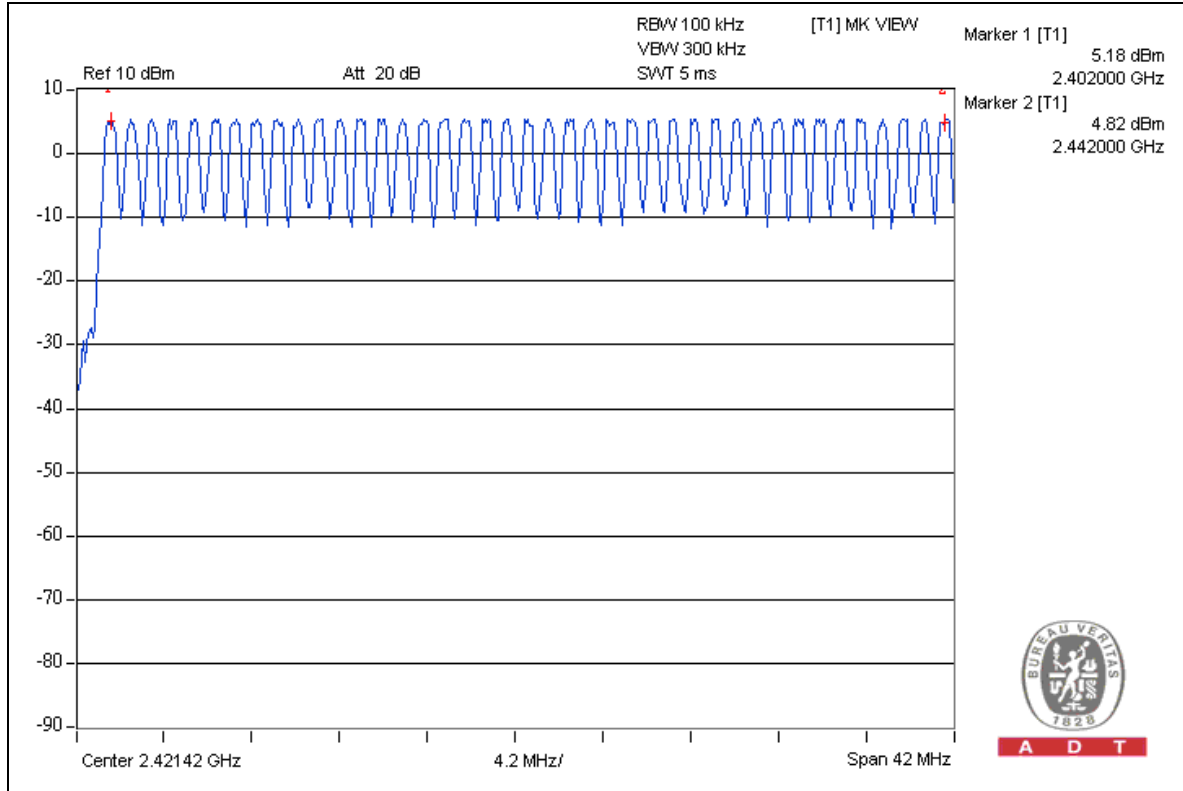

FOR 8DPSK MODULATION

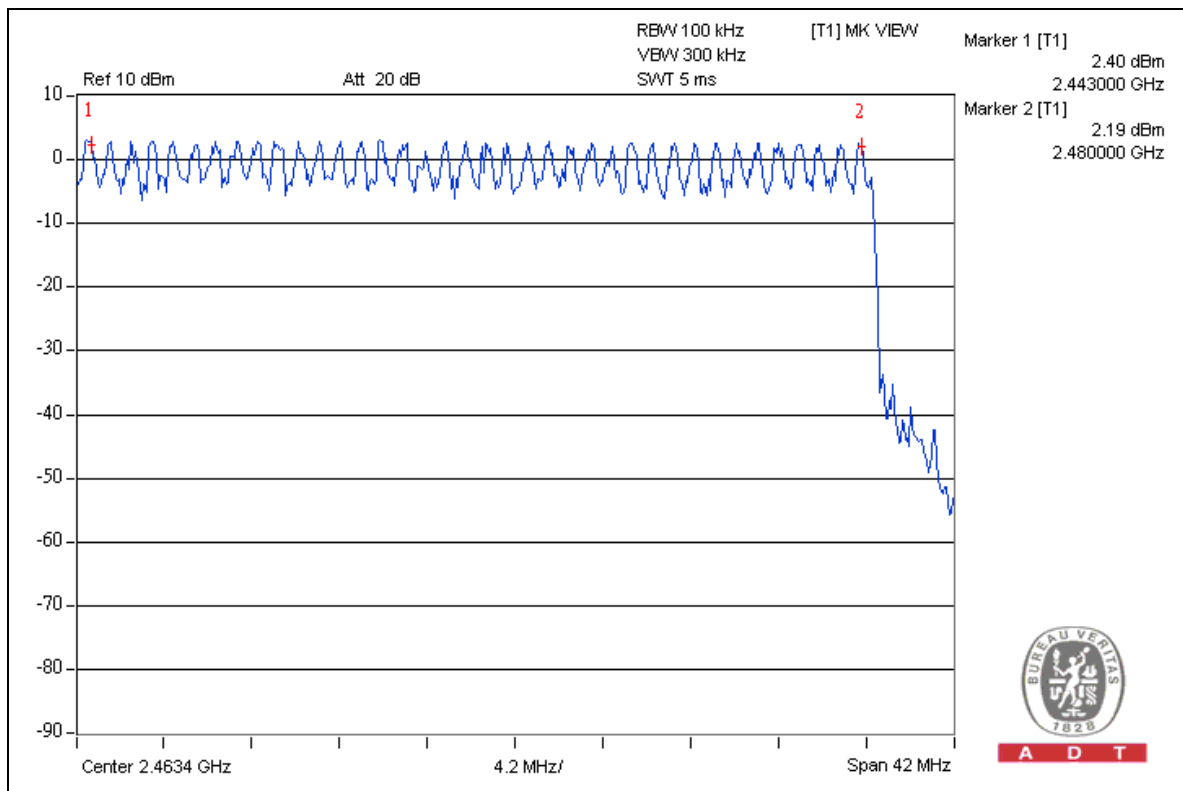
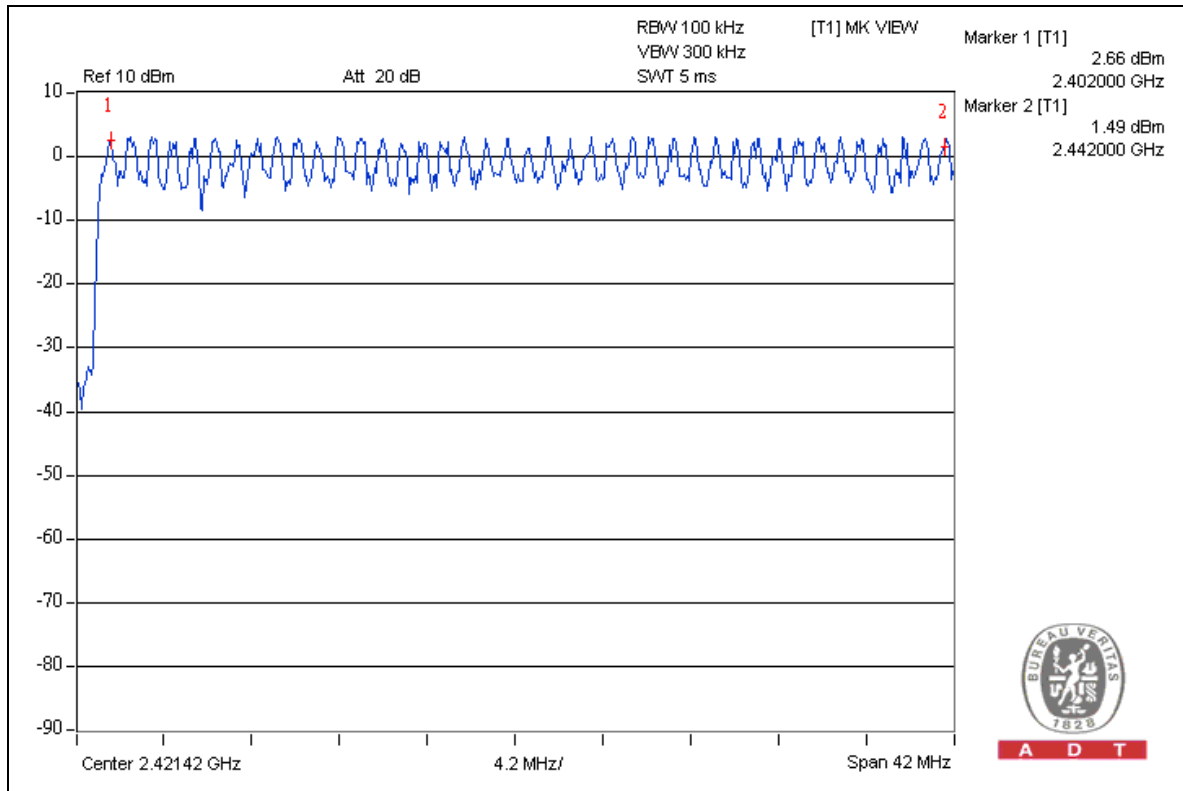



4.4 DWELL TIME ON EACH CHANNEL

4.4.1 LIMIT OF DWELL TIME USED

The average time of occupancy on any channel shall not be greater than 0.4 seconds within a period of 0.4 seconds multiplied by the number of hopping channels employed.

4.4.2 TEST INSTRUMENTS

DESCRIPTION & MANUFACTURER	MODEL NO.	SERIAL NO.	CALIBRATED DATE	CALIBRATED UNTIL
SPECTRUM ANALYZER	FSP 40	100035	Mar. 26, 2008	Mar. 25, 2009

NOTE: The calibration interval of the above test instruments is 12 months and the calibrations are traceable to NML/ROC and NIST/USA.

4.4.3 TEST PROCEDURES

- a. Check the calibration of the measuring instrument (SA) using either an internal calibrator or a known signal from an external generator.
- b. Turn on the EUT and connect its antenna terminal to measurement via a low loss cable. Then set it to any one measured frequency within its operating range and make sure the instrument is operated in its linear range.
- c. Adjust the center frequency of SA on any frequency to be measured and set SA to zero span mode. And then, set RBW and VBW of spectrum analyzer to proper value.
- d. Measure the time duration of one transmission on the measured frequency. And then plot the result with time difference of this time duration.
- e. Repeat above procedures until all different time-slot modes have been completed.

4.4.4 DEVIATION FROM TEST STANDARD

No deviation.

4.4.5 TEST SETUP

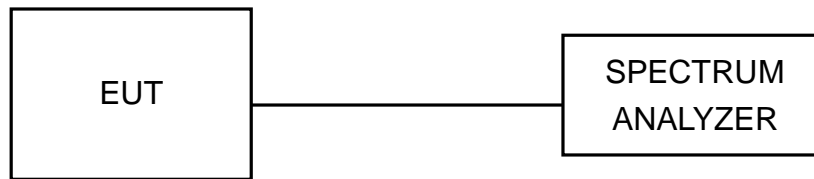

4.4.6 TEST RESULTS

FOR GFSK MODULATION

Mode	Number of transmission in a 31.6 (79Hopping*0.4)	Length of transmission time (msec)	Result (msec)	Limit (msec)
DH1	50 (times / 5 sec) *6.32=316.00 times	0.486	153.576	400
DH3	25 (times / 5 sec) *6.32=158.00 times	1.716	271.128	400
DH5	17 (times / 5 sec) *6.32=107.44times	2.970	319.0968	400

NOTE: Test plots of the transmitting time slot are shown on next 3 pages.

DH1

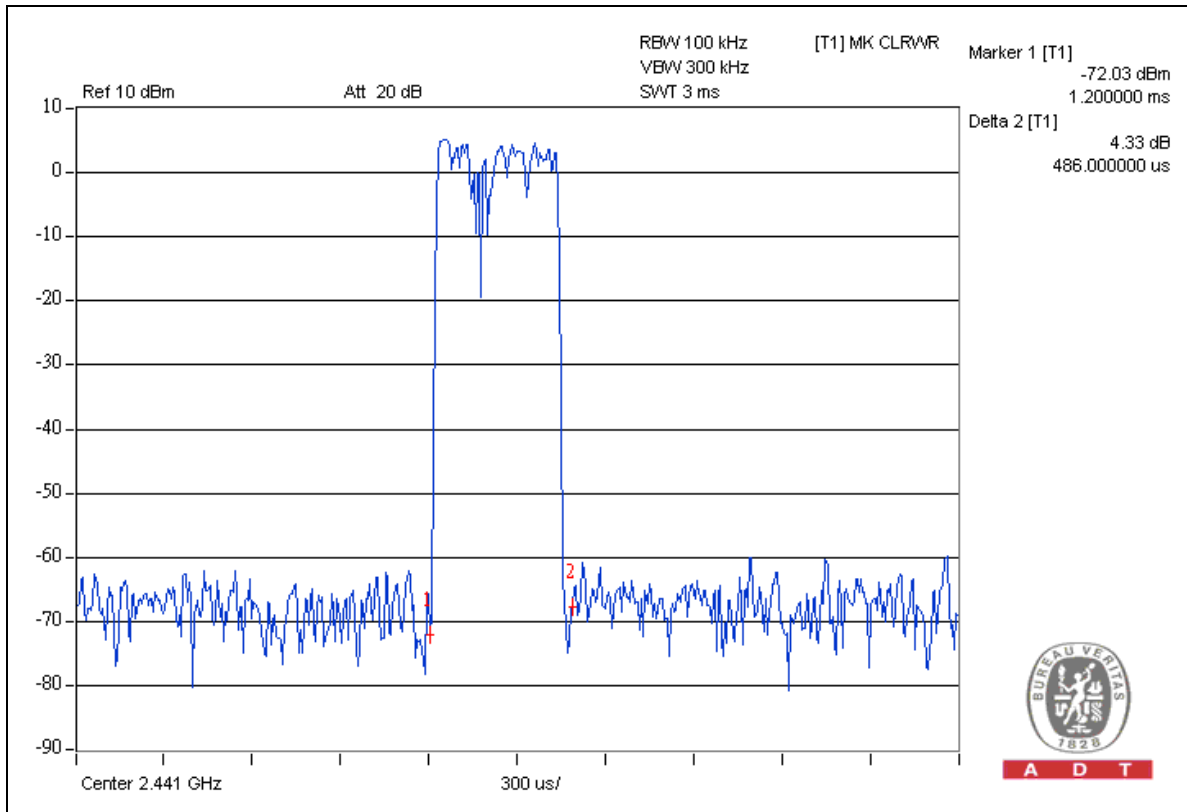
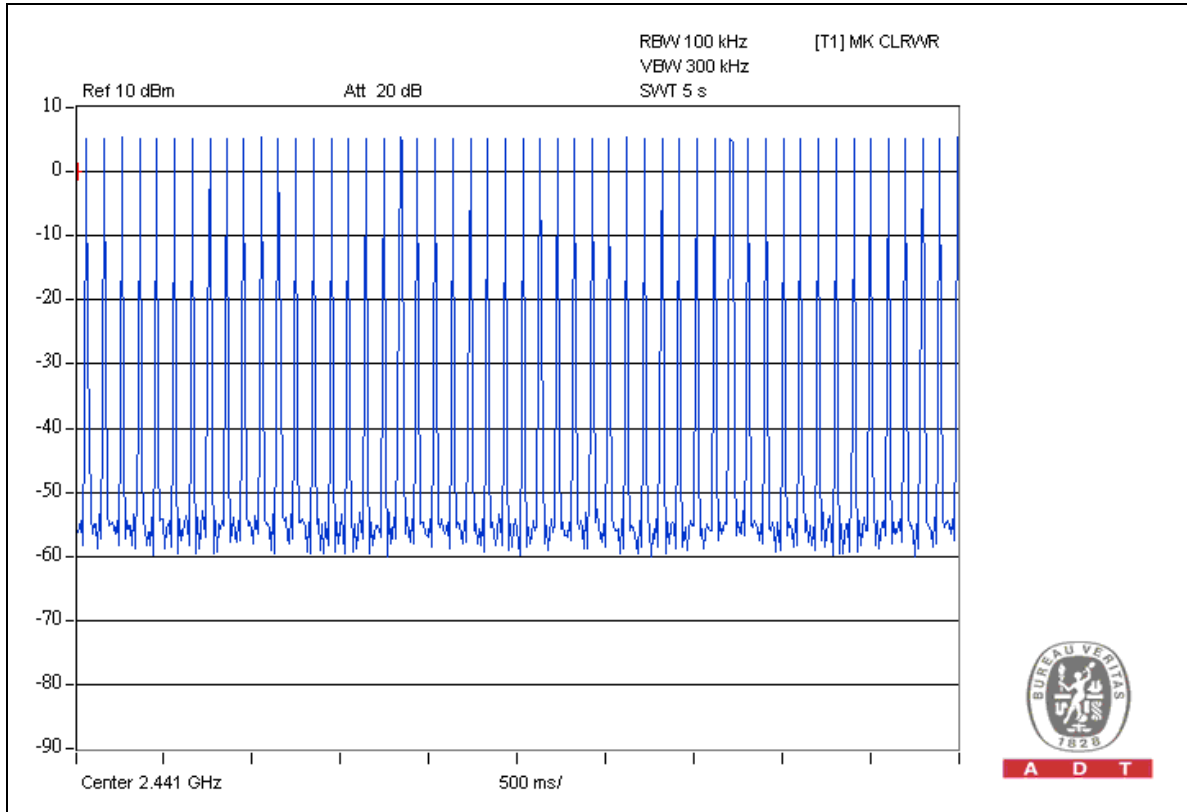

DH3

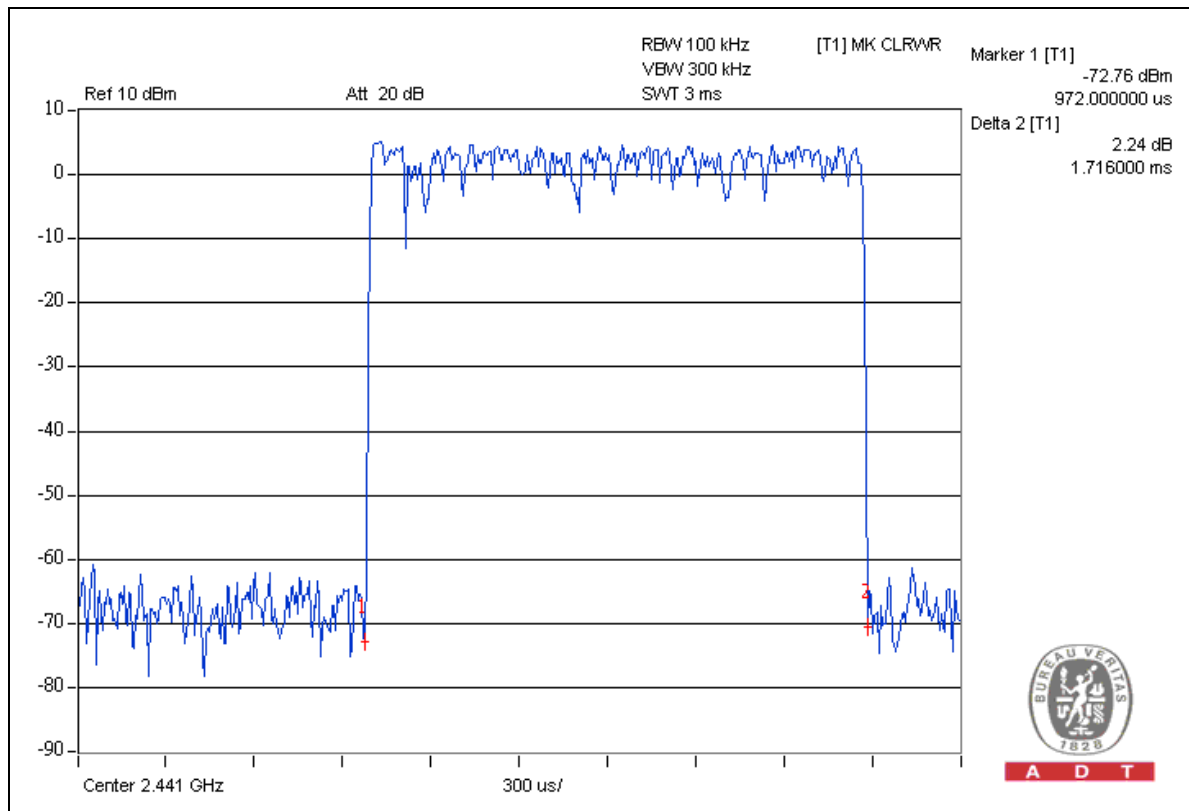
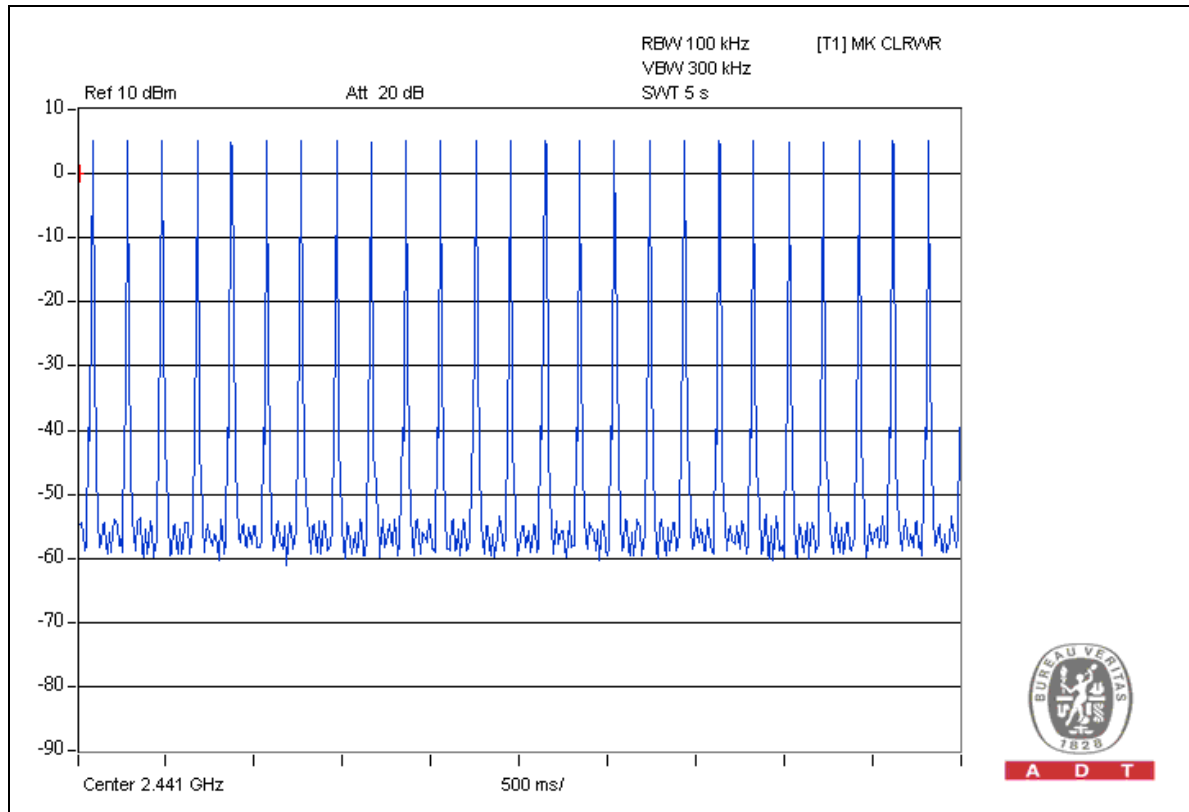

DH5

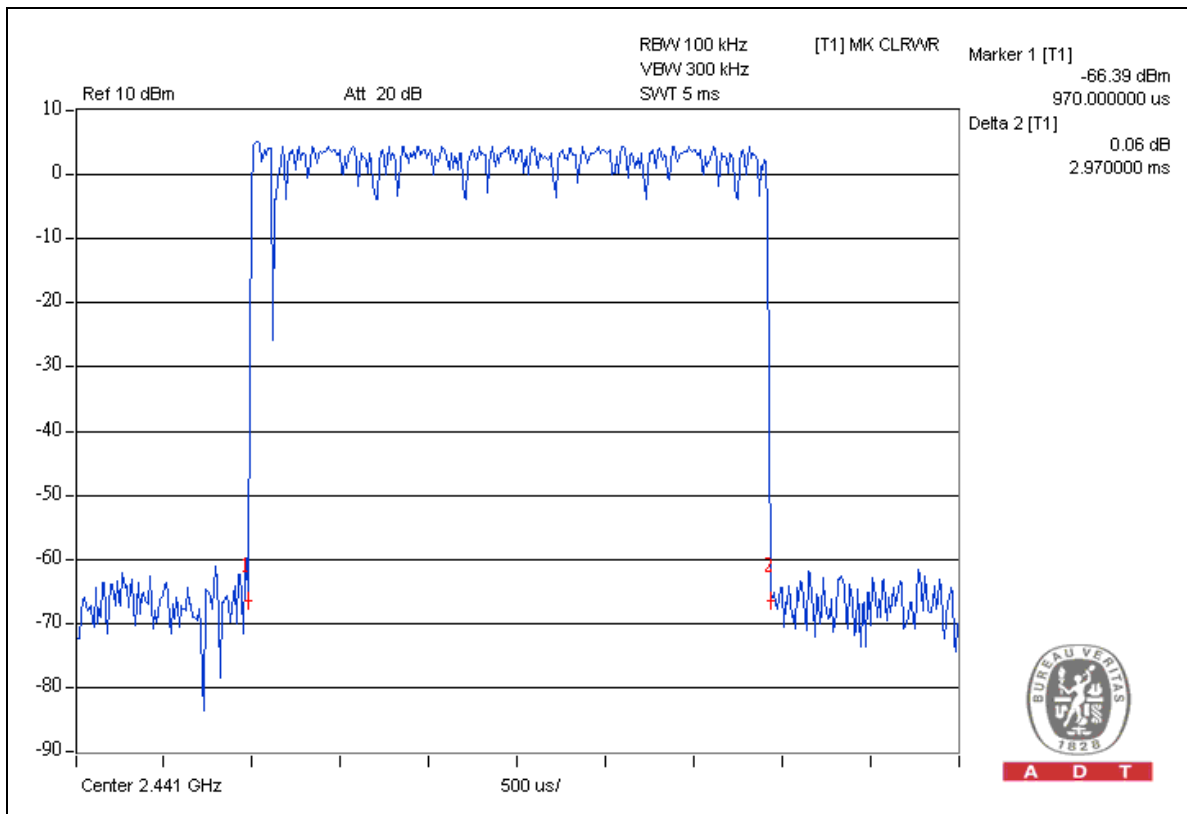
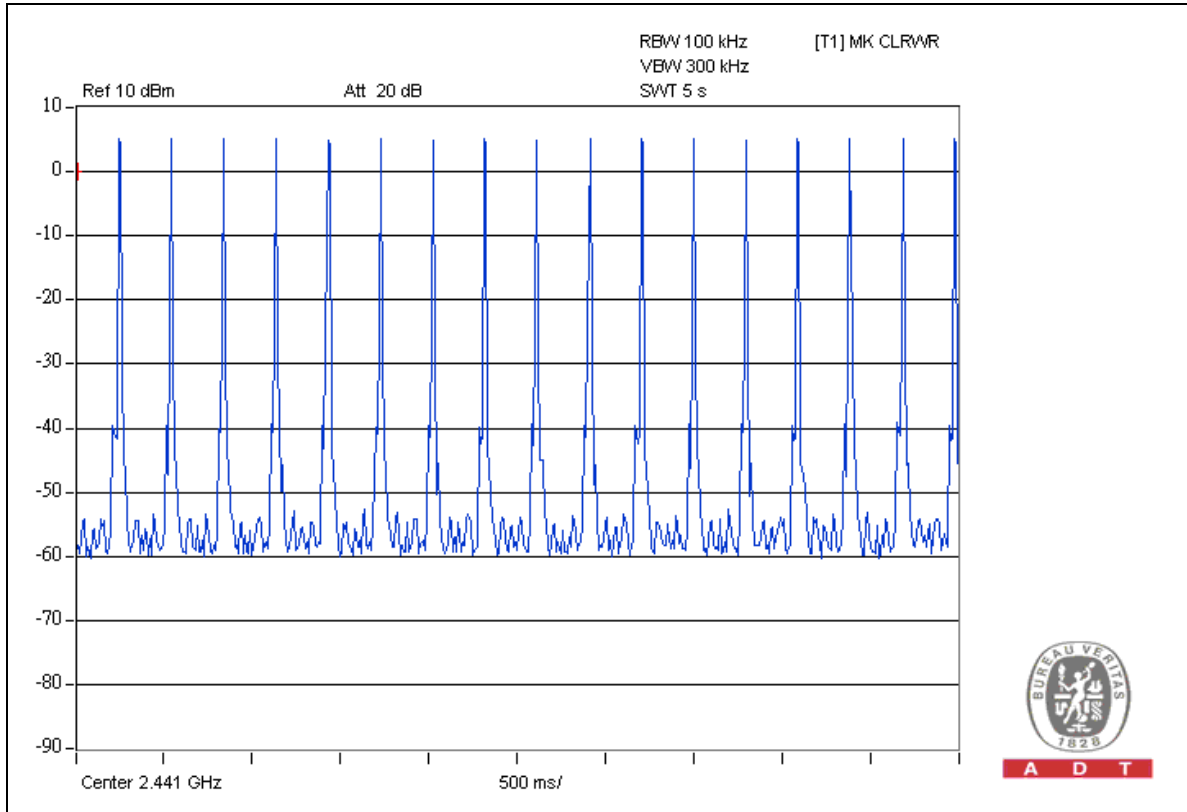



FOR 8DPSK MODULATION

Mode	Number of transmission in a 31.6 (79Hopping*0.4)	Length of transmission time (msec)	Result (msec)	Limit (msec)
DH1	50 (times / 5 sec) *6.32=316.00 times	0.480	151.68	400
DH3	25 (times / 5 sec) *6.32=158.00 times	1.764	278.712	400
DH5	16 (times / 5 sec) *6.32=101.12 times	2.990	302.3488	400

NOTE: Test plots of the transmitting time slot are shown on next 3 pages.

DH1

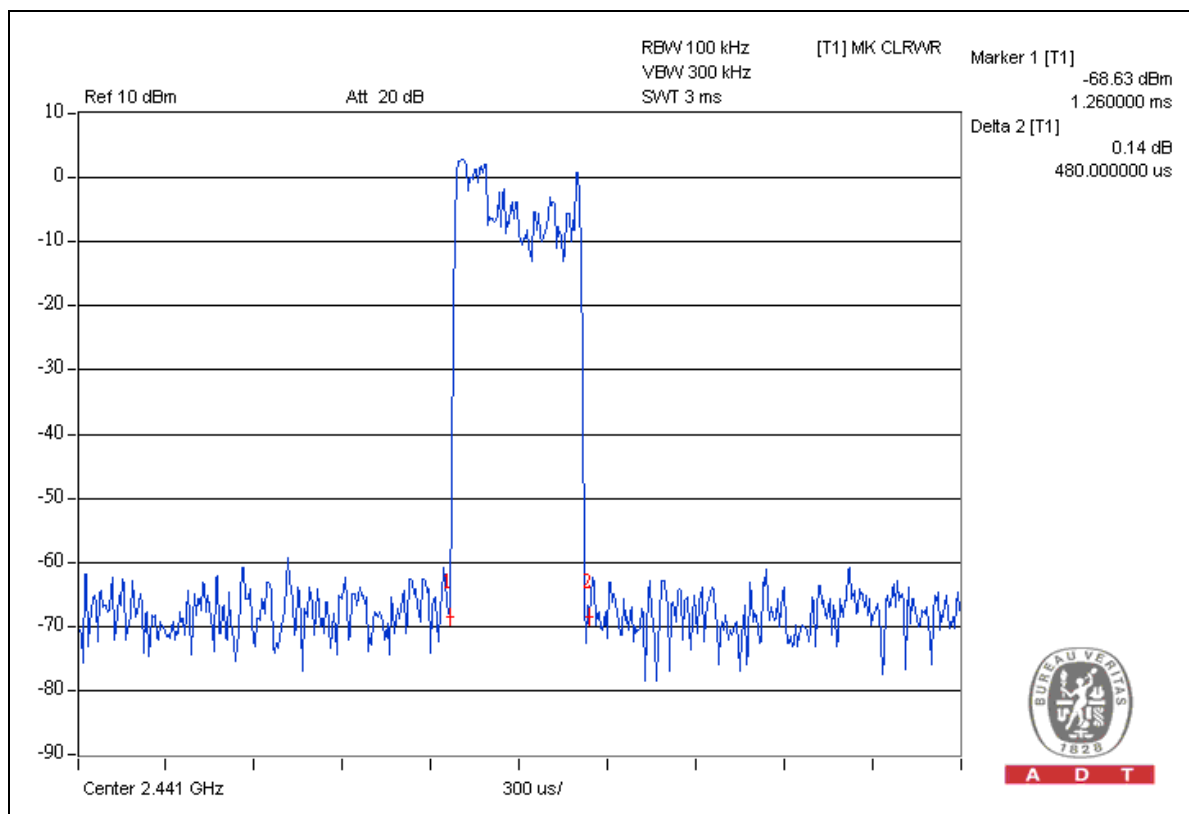
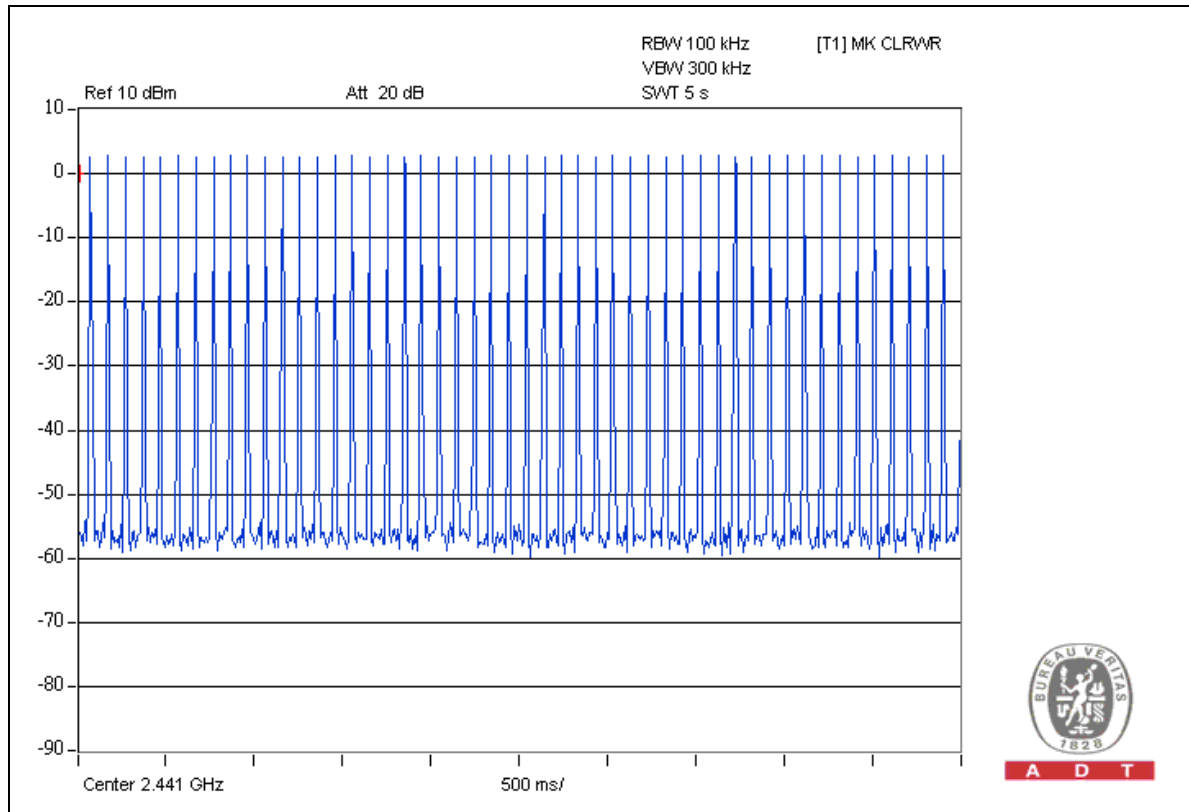

DH3

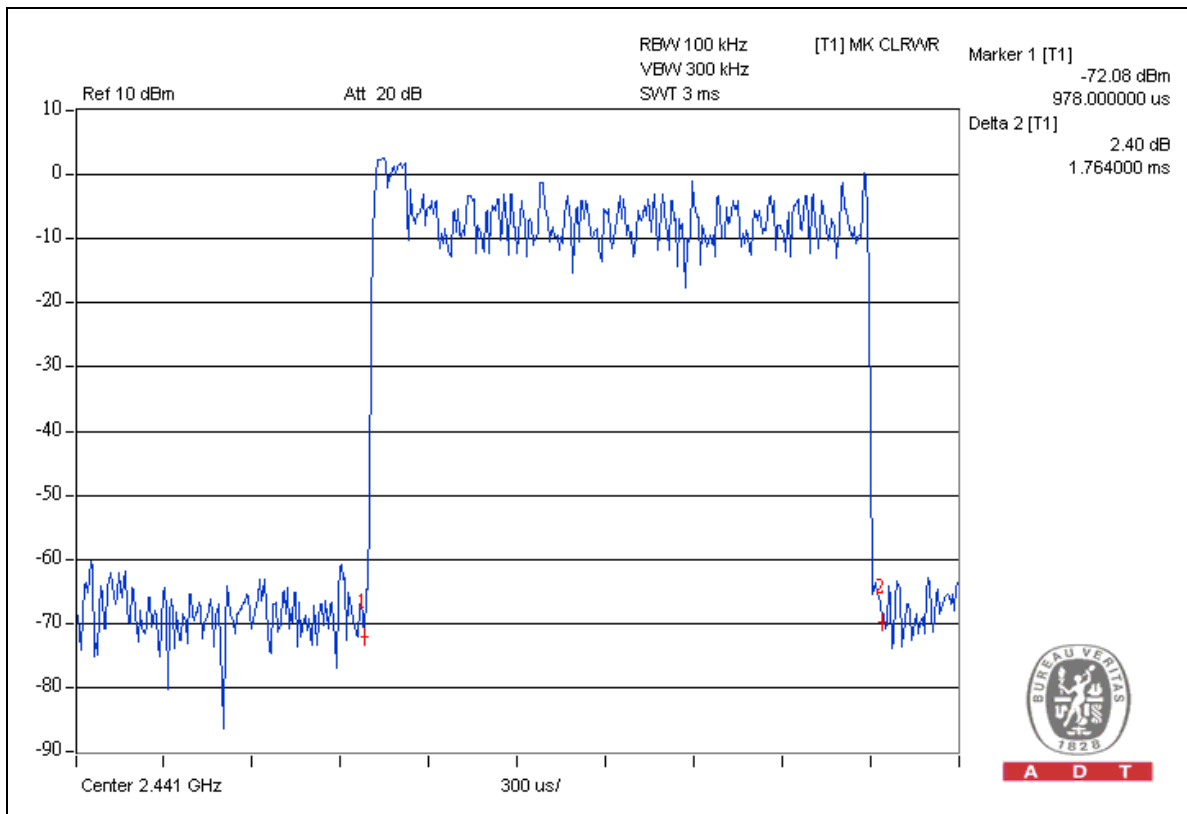
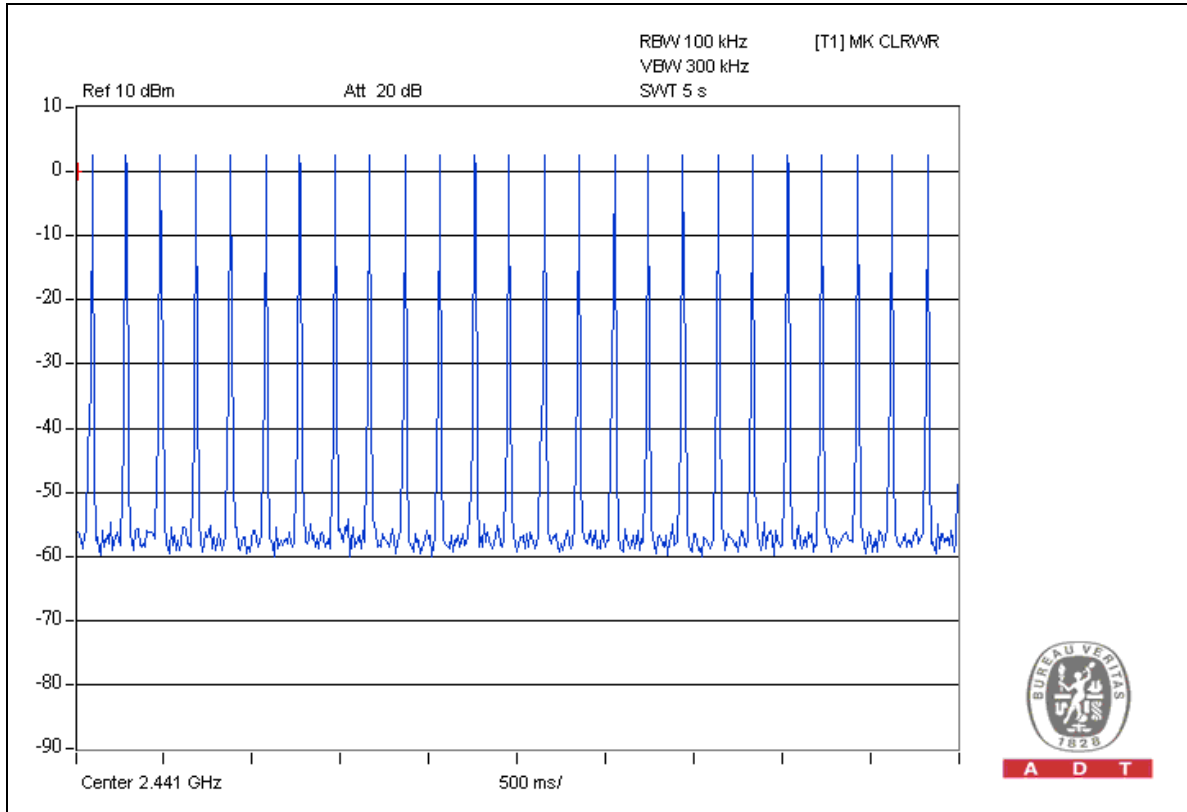

DH5

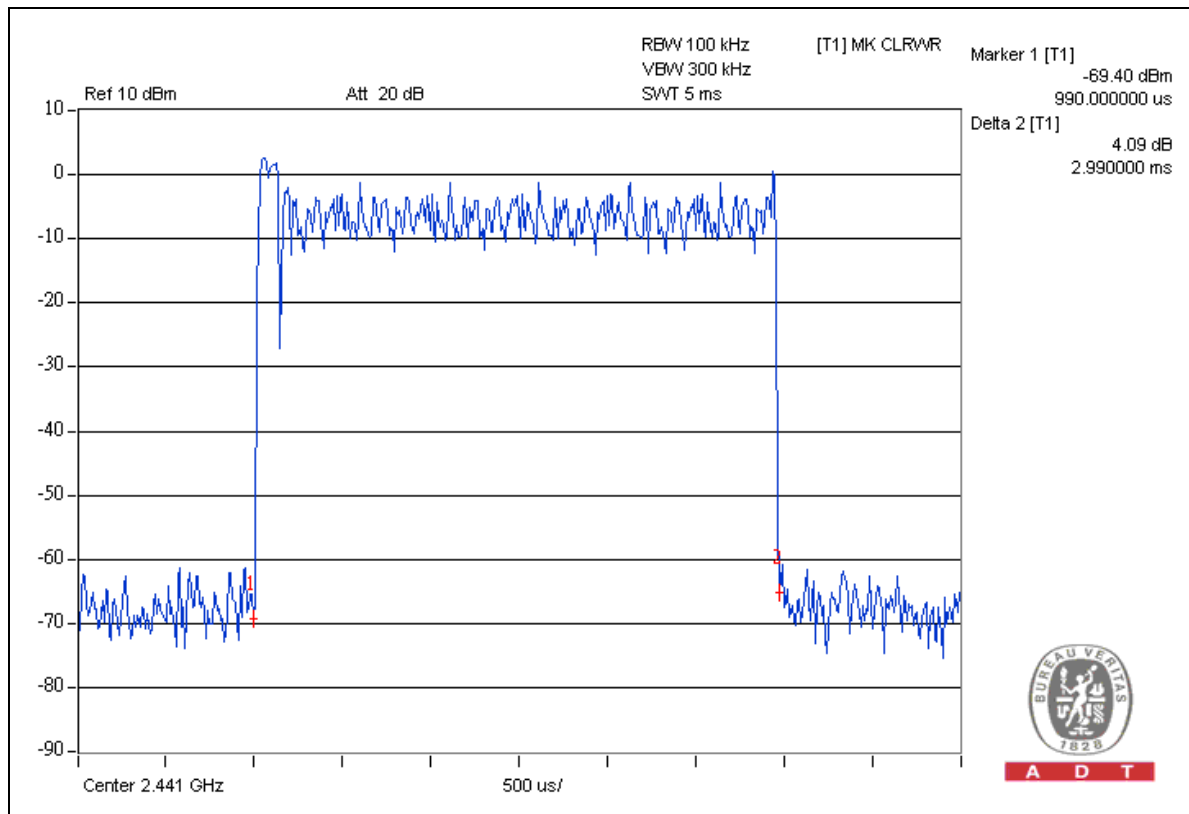
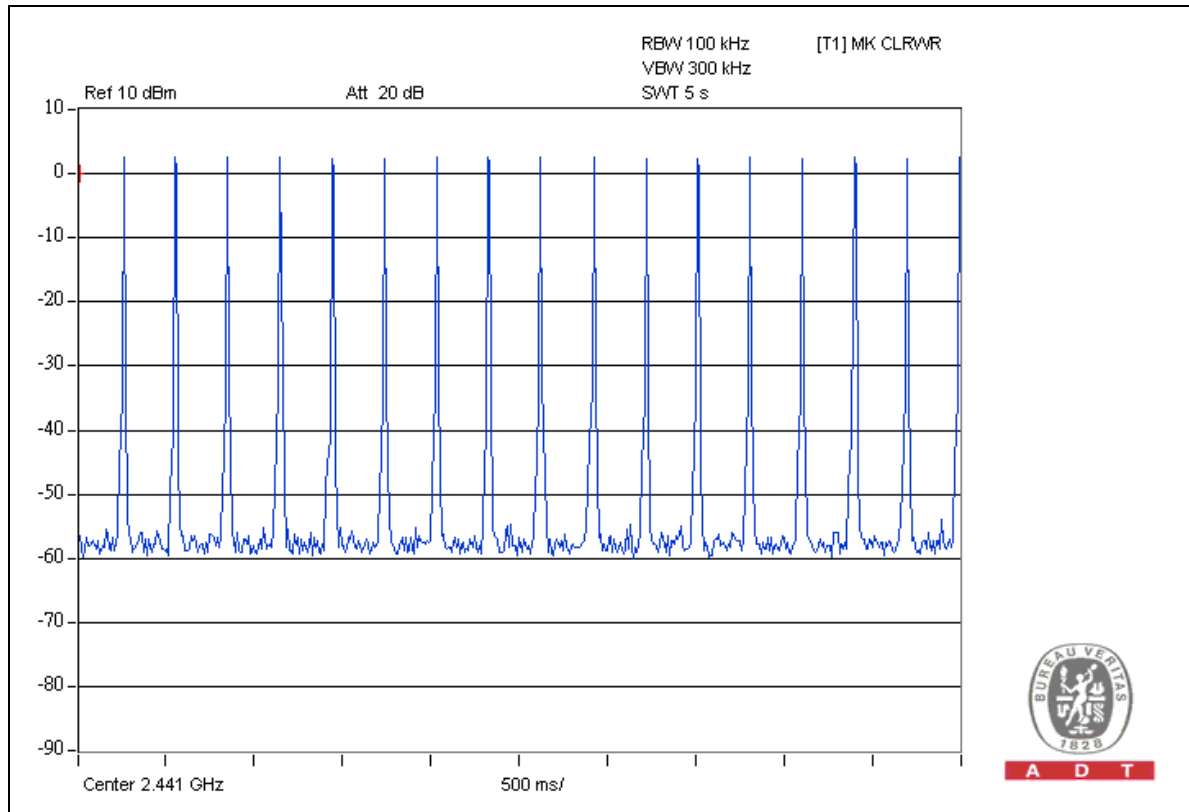



4.5 CHANNEL BANDWIDTH

4.5.1 LIMITS OF CHANNEL BANDWIDTH

For frequency hopping system operating in the 2400-2483.5MHz, If the 20dB bandwidth of hopping channel is greater than 25kHz, two-thirds 20dB bandwidth of hopping channel shall be a minimum limit for the hopping channel separation.

4.5.2 TEST INSTRUMENTS

DESCRIPTION & MANUFACTURER	MODEL NO.	SERIAL NO.	CALIBRATED DATE	CALIBRATED UNTIL
SPECTRUM ANALYZER	FSP 40	100035	Mar. 26, 2008	Mar. 25, 2009

NOTE: The calibration interval of the above test instruments is 12 months and the calibrations are traceable to NML/ROC and NIST/USA.

4.5.3 TEST PROCEDURE

- a. Check the calibration of the measuring instrument using either an internal calibrator or a known signal from an external generator.
- b. Turn on the EUT and connect it to measurement instrument. Then set it to any one convenient frequency within its operating range. Set a reference level on the measuring instrument equal to the highest peak value.
- c. Measure the frequency difference of two frequencies that were attenuated 20dB from the reference level. Record the frequency difference as the emission bandwidth.
- d. Repeat above procedures until all frequencies measured were complete.

4.5.4 DEVIATION FROM TEST STANDARD

No deviation.

4.5.5 TEST SETUP



4.5.6 EUT OPERATING CONDITION

The software provided by client enabled the EUT to transmit and receive data at lowest, middle and highest channel frequencies individually.

4.5.7 TEST RESULTS

FOR GFSK MODULATION

MODULATION TYPE	GFSK	CHANNEL	0, 39, 78
INPUT POWER (SYSTEM)	120Vac, 60 Hz	ENVIRONMENTAL CONDITIONS	26deg. C, 75% RH, 1001hPa
TESTED BY	Jamison Chan		

CHANNEL	CHANNEL FREQUENCY (MHz)	20dB BANDWIDTH (MHz)
0	2402	0.784
39	2441	0.830
78	2480	0.820

CH 0

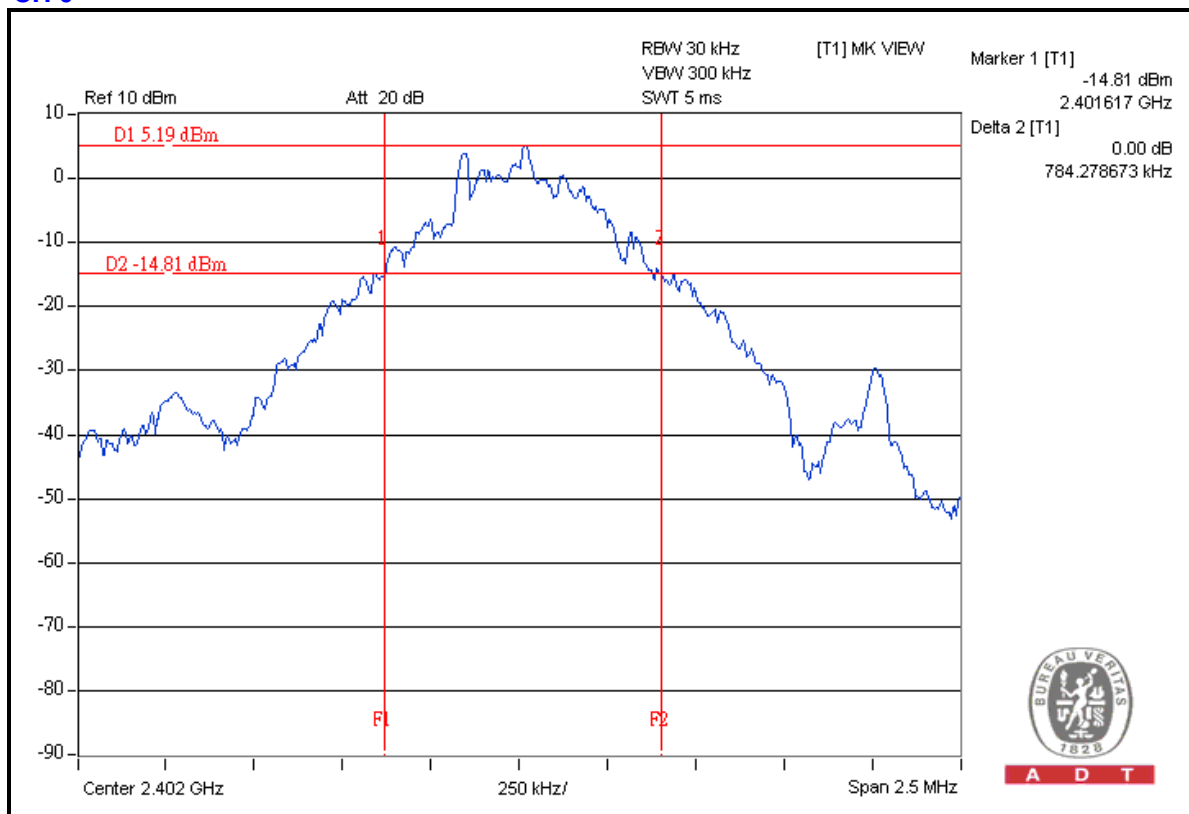

CH 39

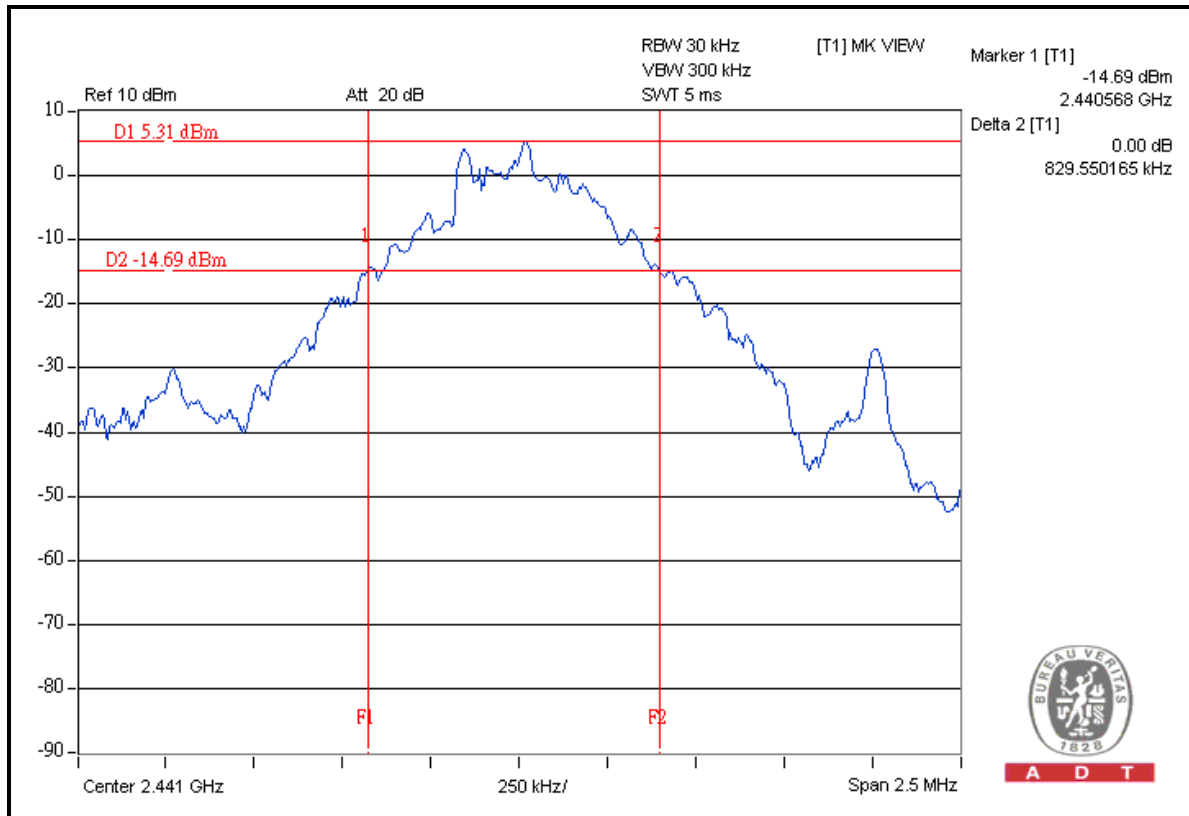

CH 78

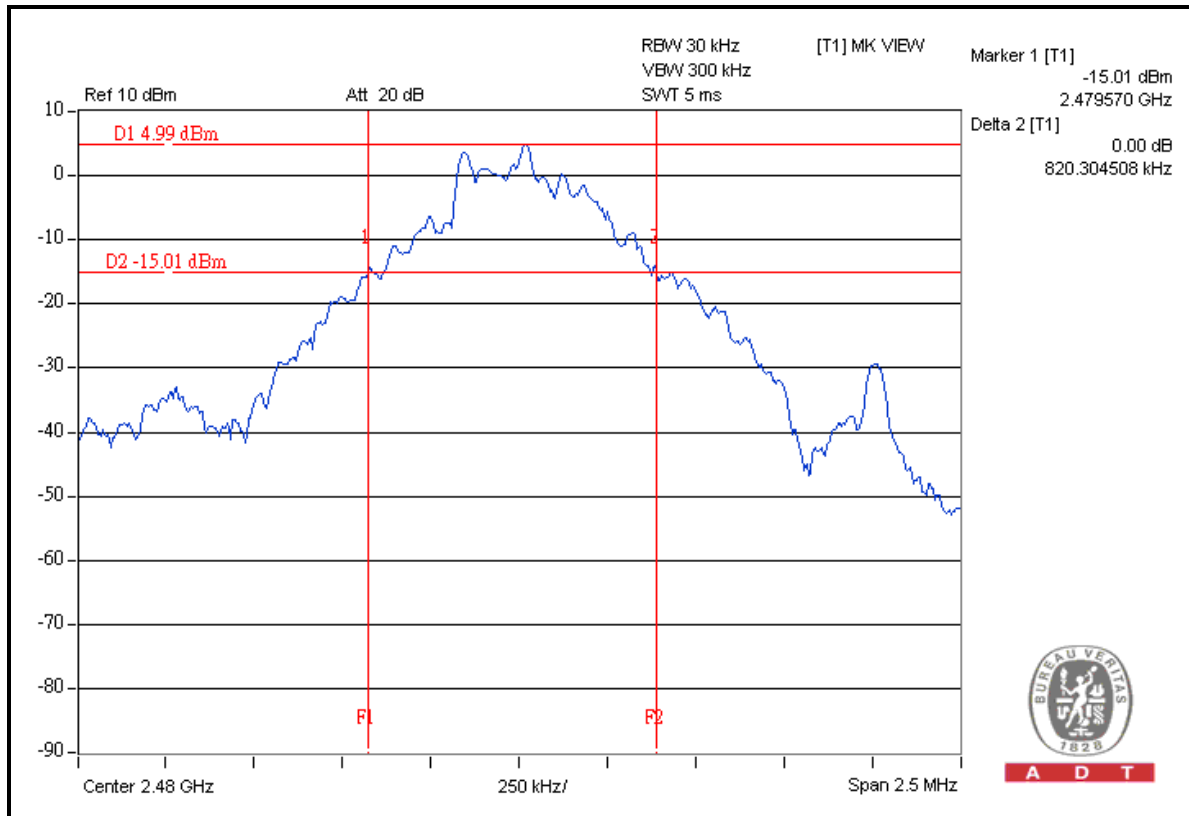

CH 39

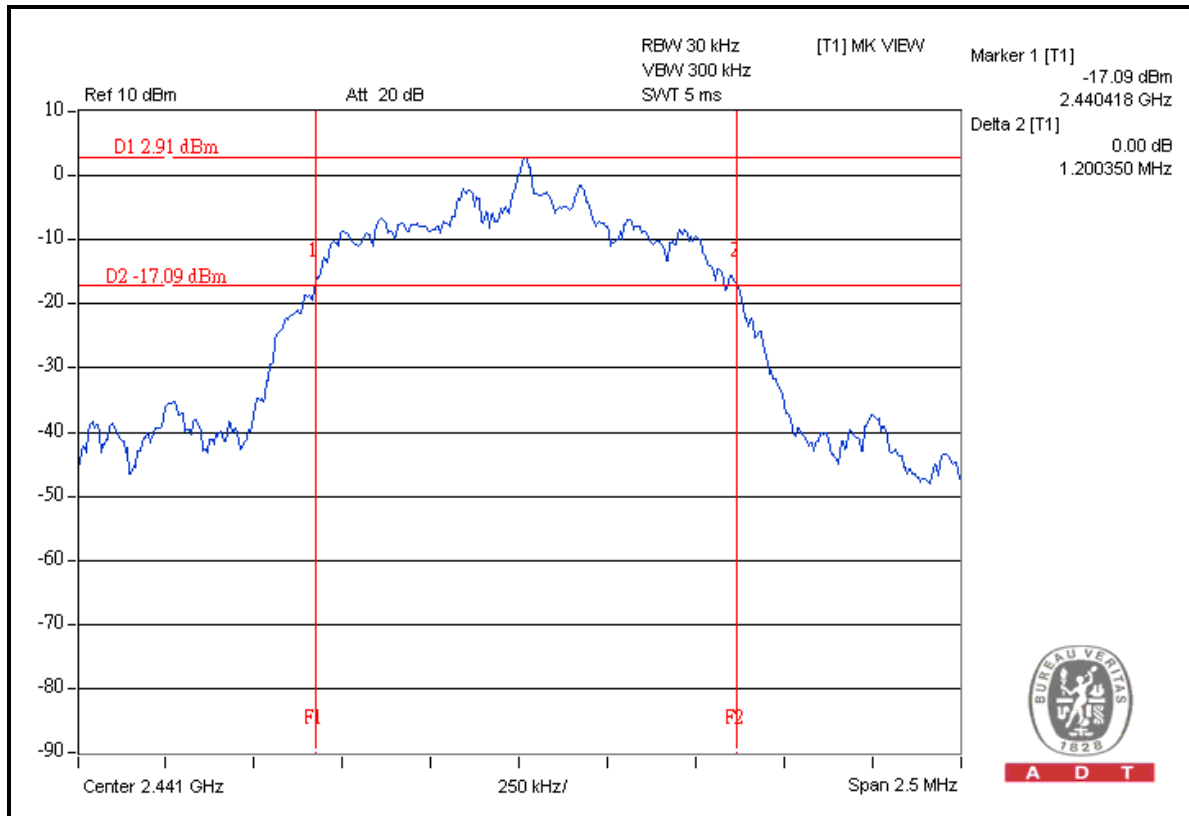

CH 78

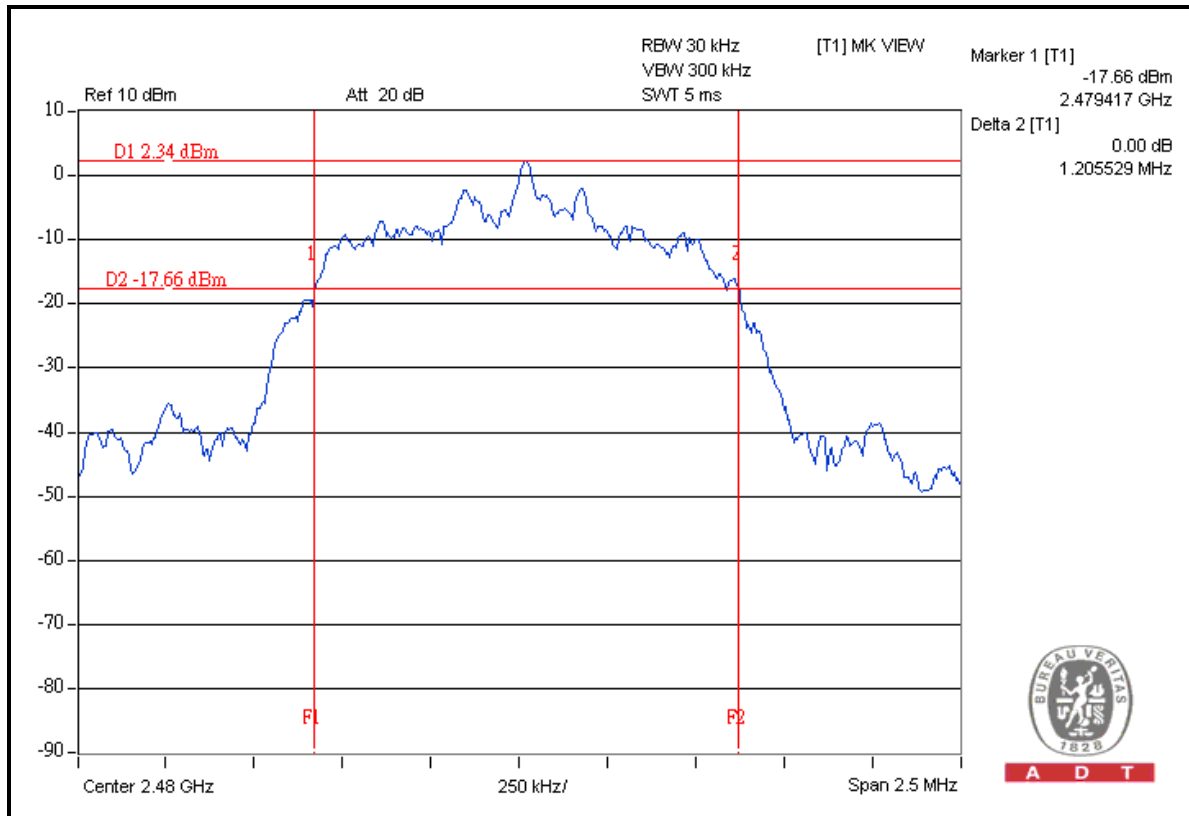



4.6 HOPPING CHANNEL SEPARATION

4.6.1 LIMIT OF HOPPING CHANNEL SEPARATION

At least 25kHz or two-third of 20dB hopping channel bandwidth (whichever is greater).

4.6.2 TEST INSTRUMENTS

DESCRIPTION & MANUFACTURER	MODEL NO.	SERIAL NO.	CALIBRATED DATE	CALIBRATED UNTIL
SPECTRUM ANALYZER	FSP 40	100035	Mar. 26, 2008	Mar. 25, 2009

NOTE: The calibration interval of the above test instruments is 12 months and the calibrations are traceable to NML/ROC and NIST/USA.

4.6.3 TEST PROCEDURES

1. Check the calibration of the measuring instrument using either an internal calibrator or a known signal from an external generator.
2. Turn on the EUT and connect it to measurement instrument. Then set it to any one convenient frequency within its operating range.
3. By using the MaxHold function record the separation of two adjacent channels.
4. Measure the frequency difference of these two adjacent channels by SA MARK function. And then plot the result on SA screen.
5. Repeat above procedures until all frequencies measured were complete.

4.6.4 DEVIATION FROM TEST STANDARD

No deviation.

4.6.5 TEST SETUP

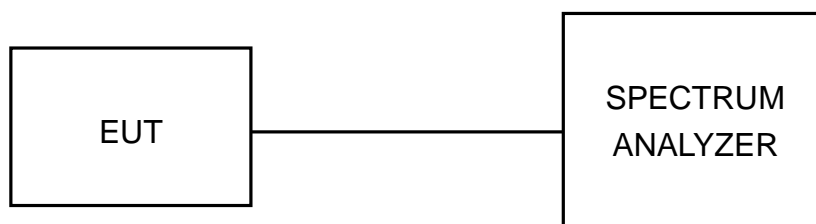

4.6.6 TEST RESULTS

FOR GFSK MODULATION

MODULATION TYPE	GFSK	CHANNEL	0, 39, 78
INPUT POWER (SYSTEM)	120Vac, 60 Hz	ENVIRONMENTAL CONDITIONS	26deg. C, 75% RH, 1001hPa
TESTED BY	Jamison Chan		

CHANNEL	FREQUENCY (MHz)	ADJACENT CHANNEL SEPARATION (MHz)	20dB BANDWIDTH (MHz)	MINIMUM LIMIT (MHz)	PASS / FAIL
0	2402	1.007	0.784	0.523	PASS
39	2441	1.006	0.830	0.553	PASS
78	2480	1.004	0.820	0.547	PASS

NOTE: The minimum limit is two-third 20dB bandwidth. Test results please refer to following three plots.

CH 0

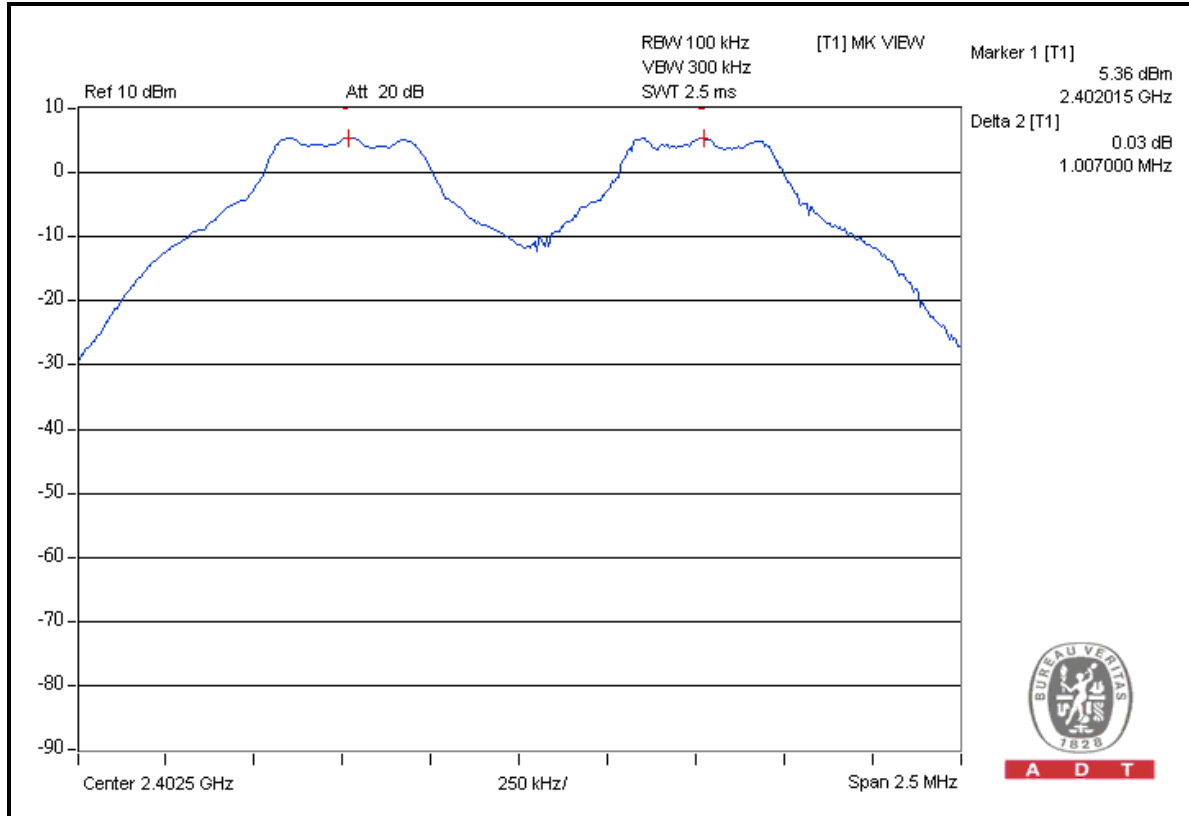

CH 39

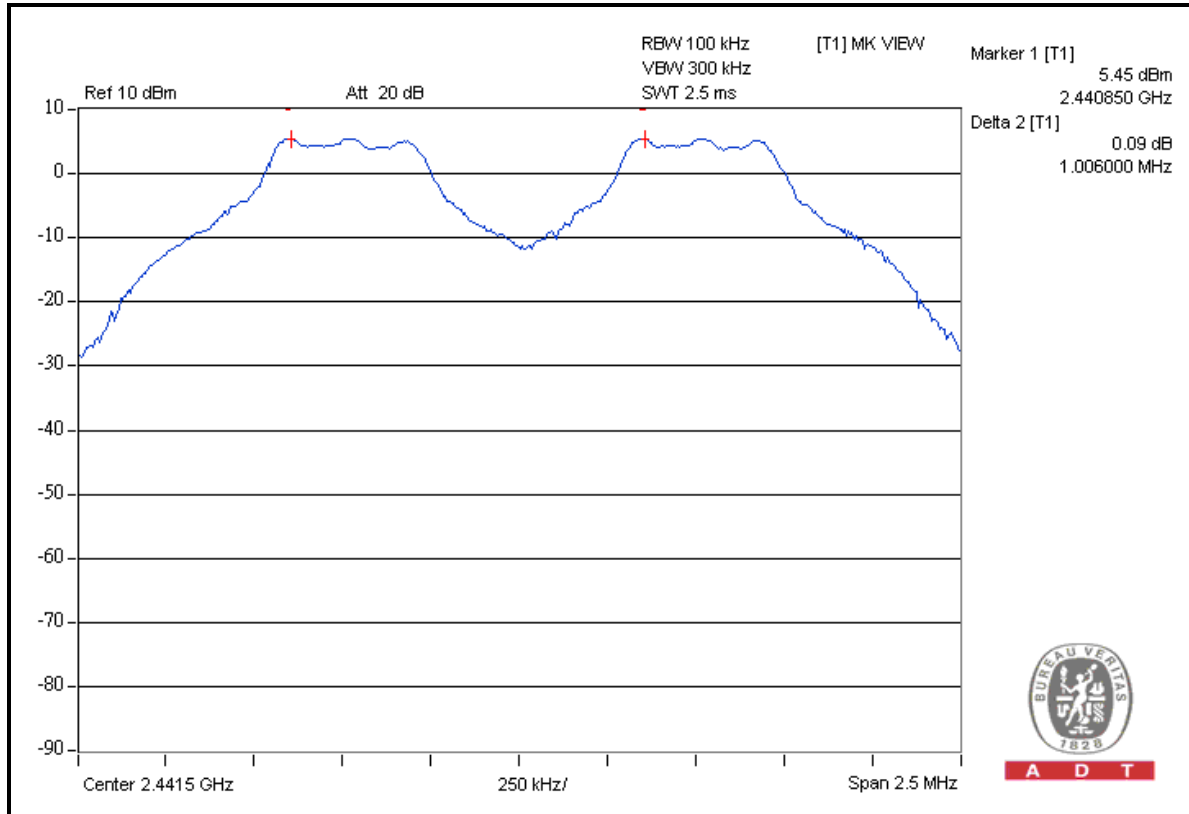

CH 78

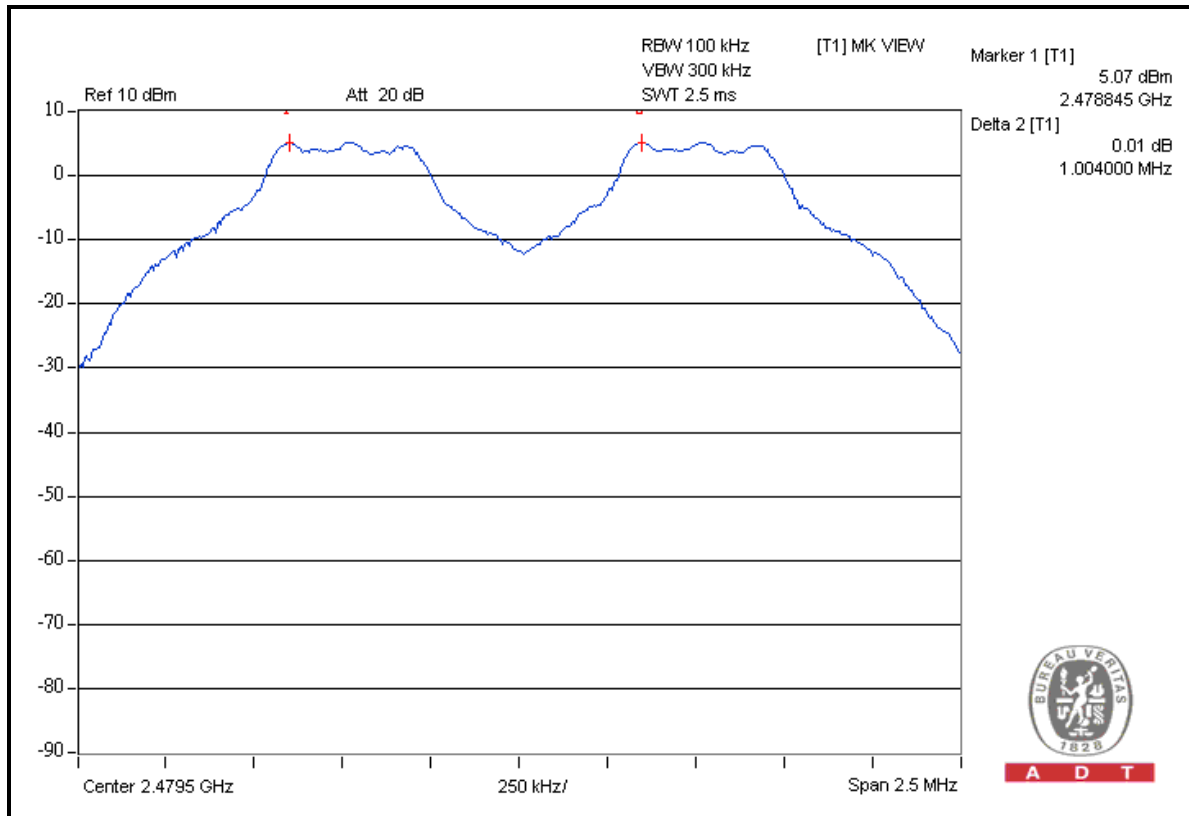



FOR 8DPSK MODULATION

MODULATION TYPE	8DPSK	CHANNEL	0, 39, 78
INPUT POWER (SYSTEM)	120Vac, 60 Hz	ENVIRONMENTAL CONDITIONS	26deg. C, 75% RH, 1001hPa
TESTED BY	Jamison Chan		

CHANNEL	FREQUENCY (MHz)	ADJACENT CHANNEL SEPARATION (MHz)	20dB BANDWIDTH (MHz)	MINIMUM LIMIT (MHz)	PASS / FAIL
0	2402	1.006	1.203	0.802	PASS
39	2441	1.008	1.200	0.800	PASS
78	2480	1.006	1.206	0.804	PASS

NOTE: The minimum limit is two-third 20dB bandwidth. Test results please refer to following three plots.

CH 0

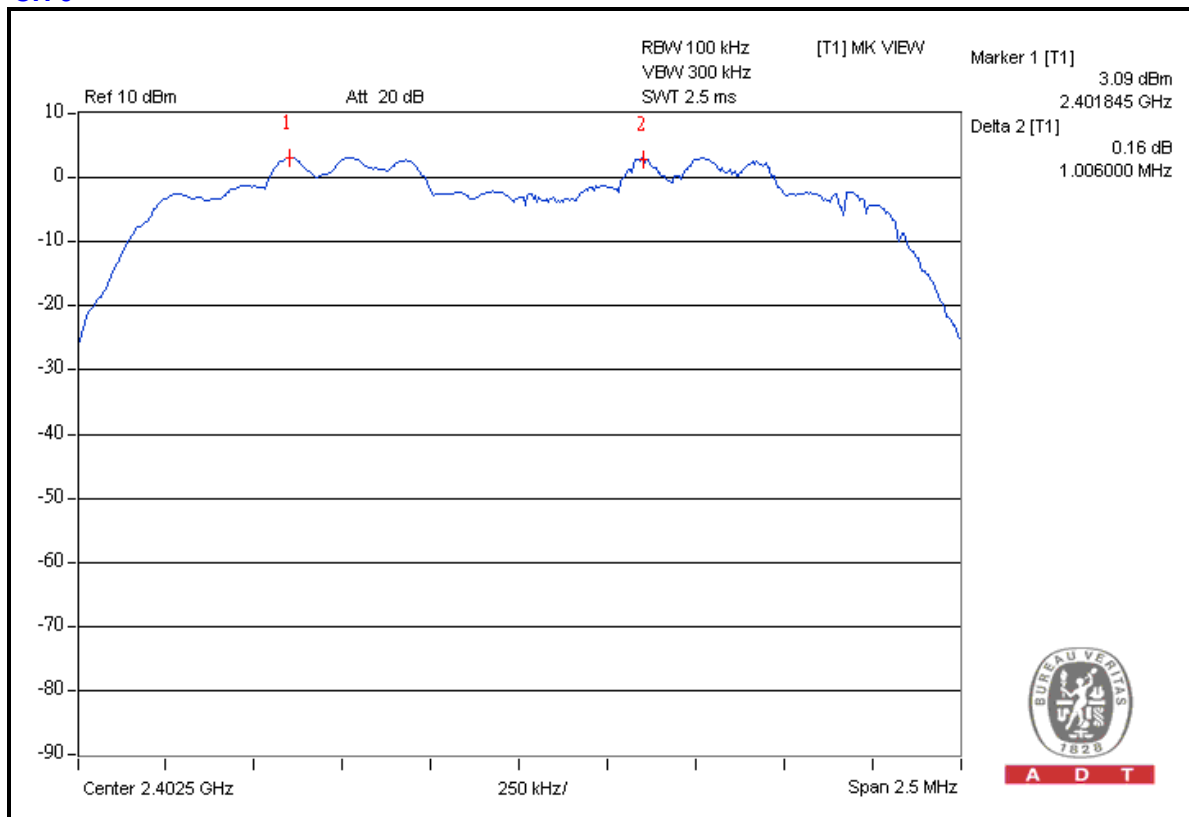

CH 39

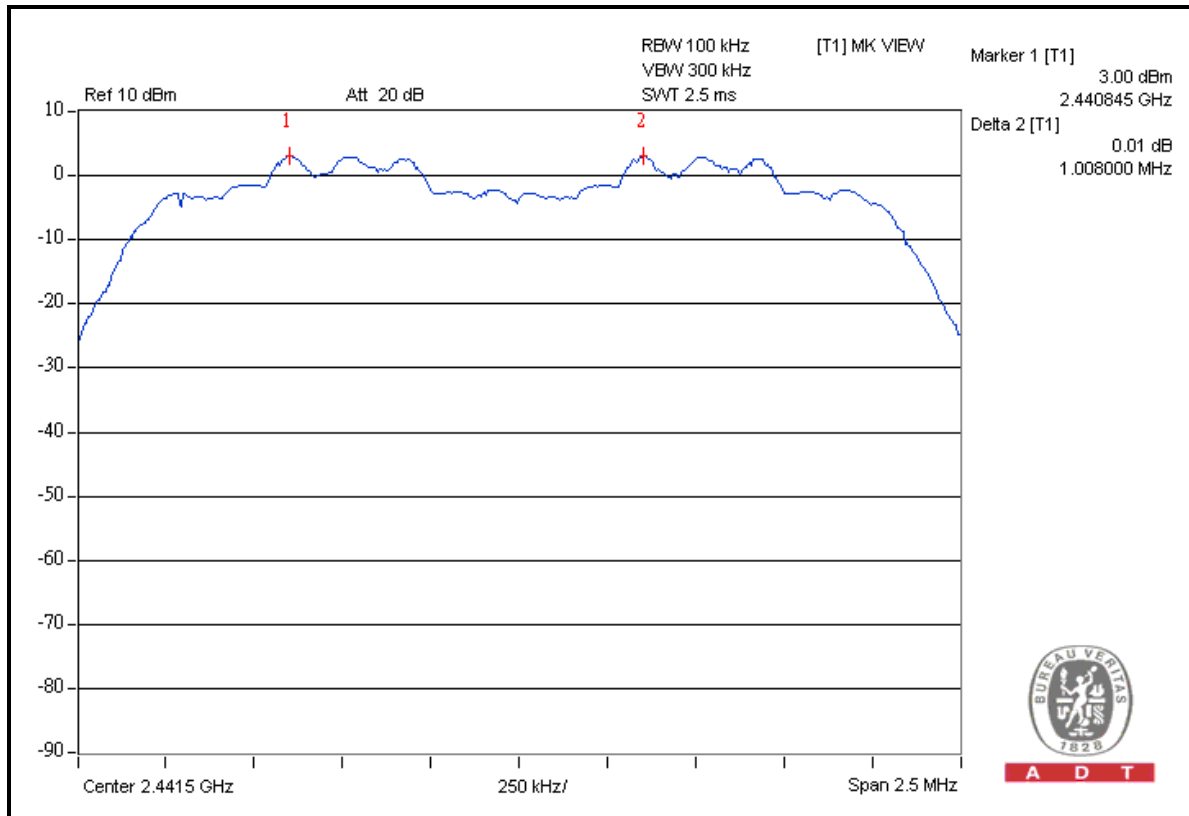

CH 78

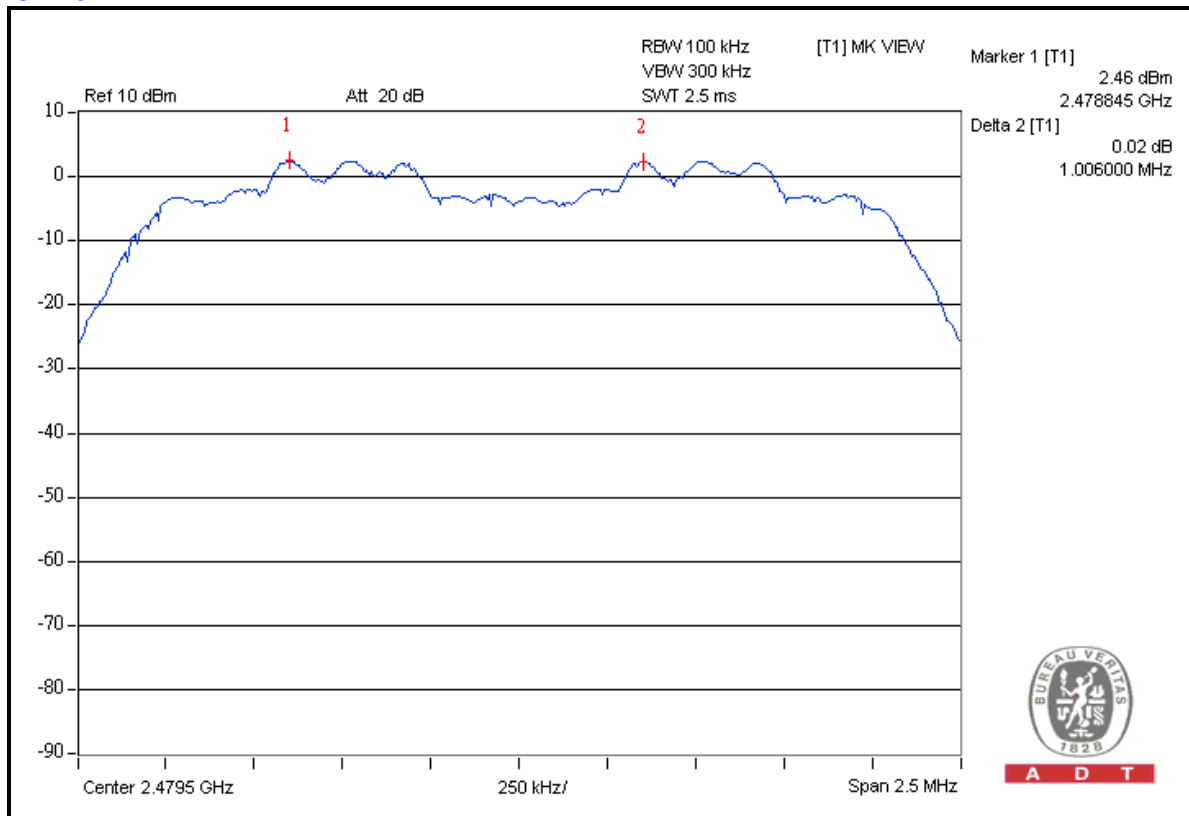



4.7 MAXIMUM PEAK OUTPUT POWER

4.7.1 LIMITS OF MAXIMUM PEAK OUTPUT POWER MEASUREMENT

The Maximum Peak Output Power Measurement is 125mW.

4.7.2 TEST INSTRUMENTS

DESCRIPTION & MANUFACTURER	MODEL NO.	SERIAL NO.	CALIBRATED DATE	CALIBRATED UNTIL
SPECTRUM ANALYZER	FSP 40	100035	Mar. 26, 2008	Mar. 25, 2009

NOTE: The calibration interval of the above test instruments is 12 months and the calibrations are traceable to NML/ROC and NIST/USA.

4.7.3 TEST PROCEDURES

- a. Check the calibration of the measuring instrument using either an internal calibrator or a known signal from an external generator.
- b. Turn on the EUT and connect it to measurement instrument. Then set it to any one convenient frequency within its operating range. Set a reference level on the measuring instrument equal to the highest peak value.
- c. The center frequency of the spectrum analyzer is set to the fundamental frequency and using 3MHz RBW and 10 MHz VBW.
- d. Measure the captured power within the band and recording the plot.
- e. Repeat above procedures until all frequencies required were complete.

4.7.4 DEVIATION FROM TEST STANDARD

No deviation

4.7.5 TEST SETUP

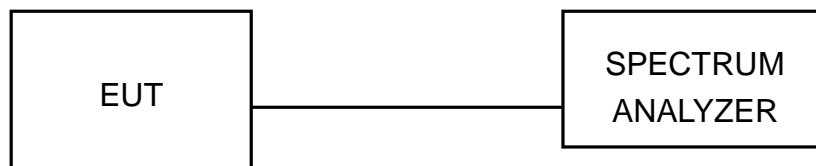

For the actual test configuration, please refer to the related Item – Photographs of the Test Configuration.

4.7.6 EUT OPERATING CONDITION

The software provided by client enabled the EUT to transmit and receive data at lowest, middle and highest channel frequencies individually.

4.7.7 TEST RESULTS

FOR GFSK MODULATION

MODULATION TYPE	GFSK	CHANNEL	0, 39, 78
INPUT POWER (SYSTEM)	120Vac, 60 Hz	ENVIRONMENTAL CONDITIONS	26deg. C, 75% RH, 1001hPa
TESTED BY	Jamison Chan		

CHANNEL	CHANNEL FREQUENCY (MHz)	PEAK POWER OUTPUT (mW)	PEAK POWER OUTPUT (dBm)	PEAK POWER LIMIT (mW)	PASS/FAIL
0	2402	3.184	5.03	125	PASS
39	2441	3.206	5.06	125	PASS
78	2480	2.965	4.72	125	PASS

CH 0

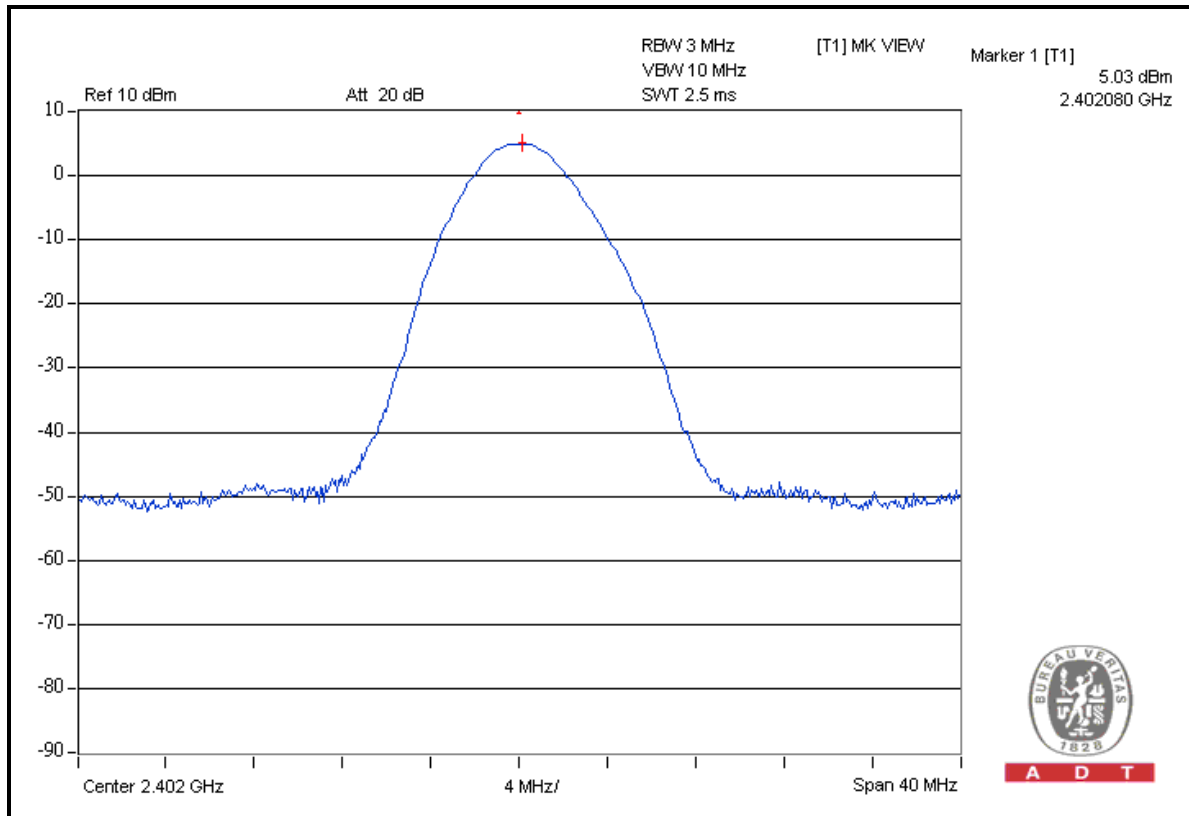

CH 39

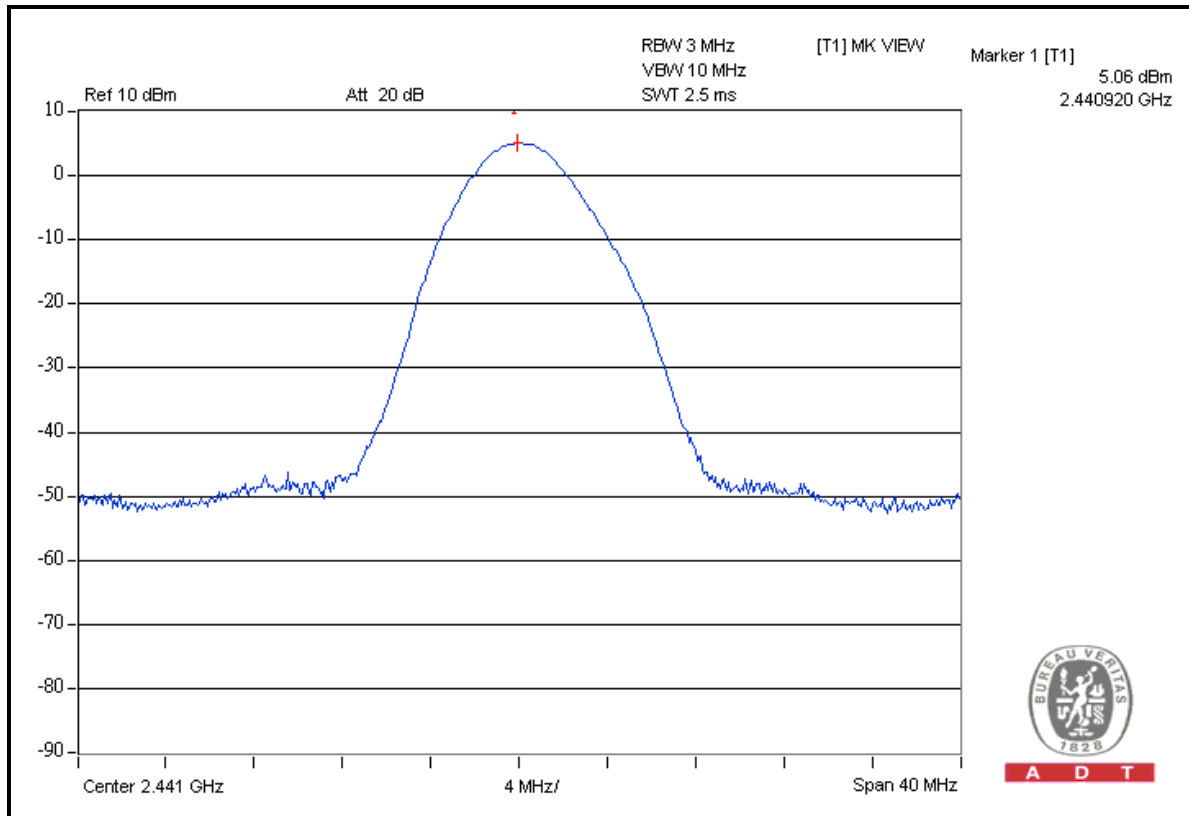

CH 78

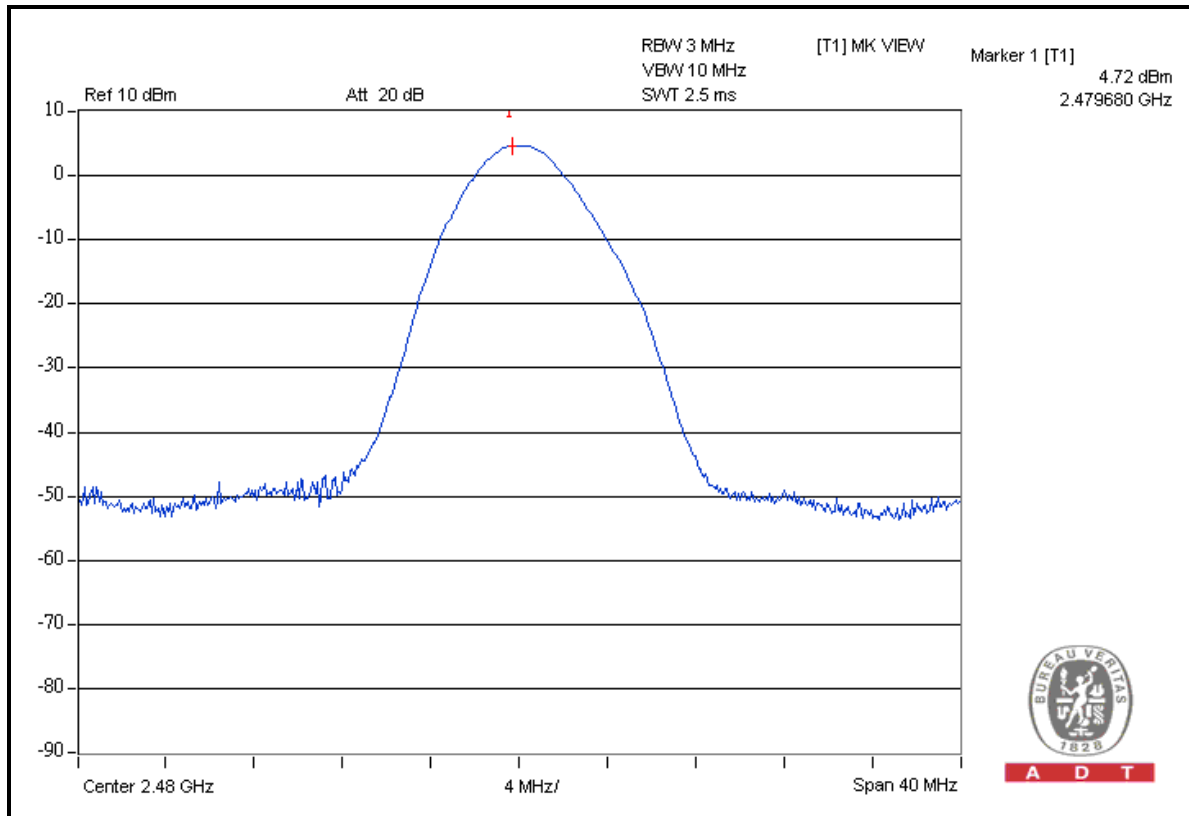



FOR 8DPSK MODULATION

MODULATION TYPE	8DPSK	CHANNEL	0, 39, 78
INPUT POWER (SYSTEM)	120Vac, 60 Hz	ENVIRONMENTAL CONDITIONS	26deg. C, 75% RH, 1001hPa
TESTED BY	Jamison Chan		

CHANNEL	CHANNEL FREQUENCY (MHz)	PEAK POWER OUTPUT (mW)	PEAK POWER OUTPUT (dBm)	PEAK POWER LIMIT (mW)	PASS/FAIL
0	2402	2.099	3.22	125	PASS
39	2441	2.084	3.19	125	PASS
78	2480	1.811	2.58	125	PASS

CH 0

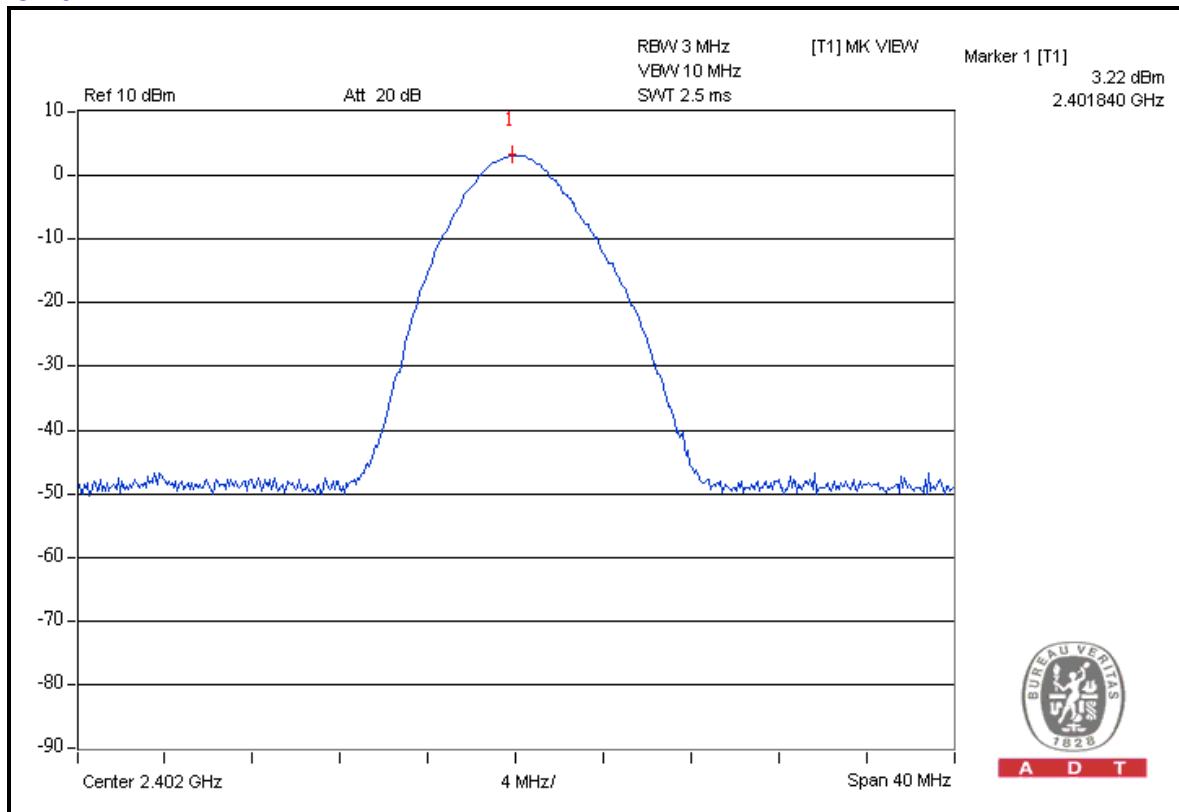

CH 39

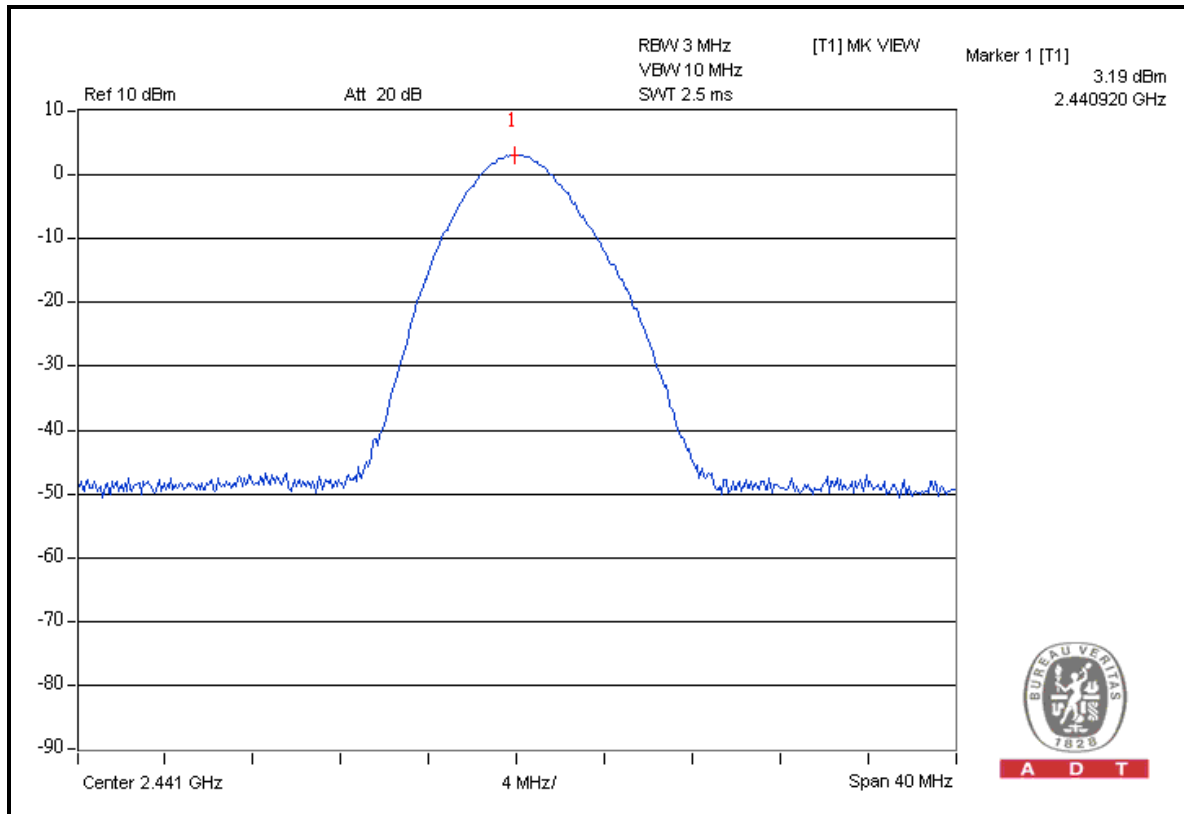

CH 78

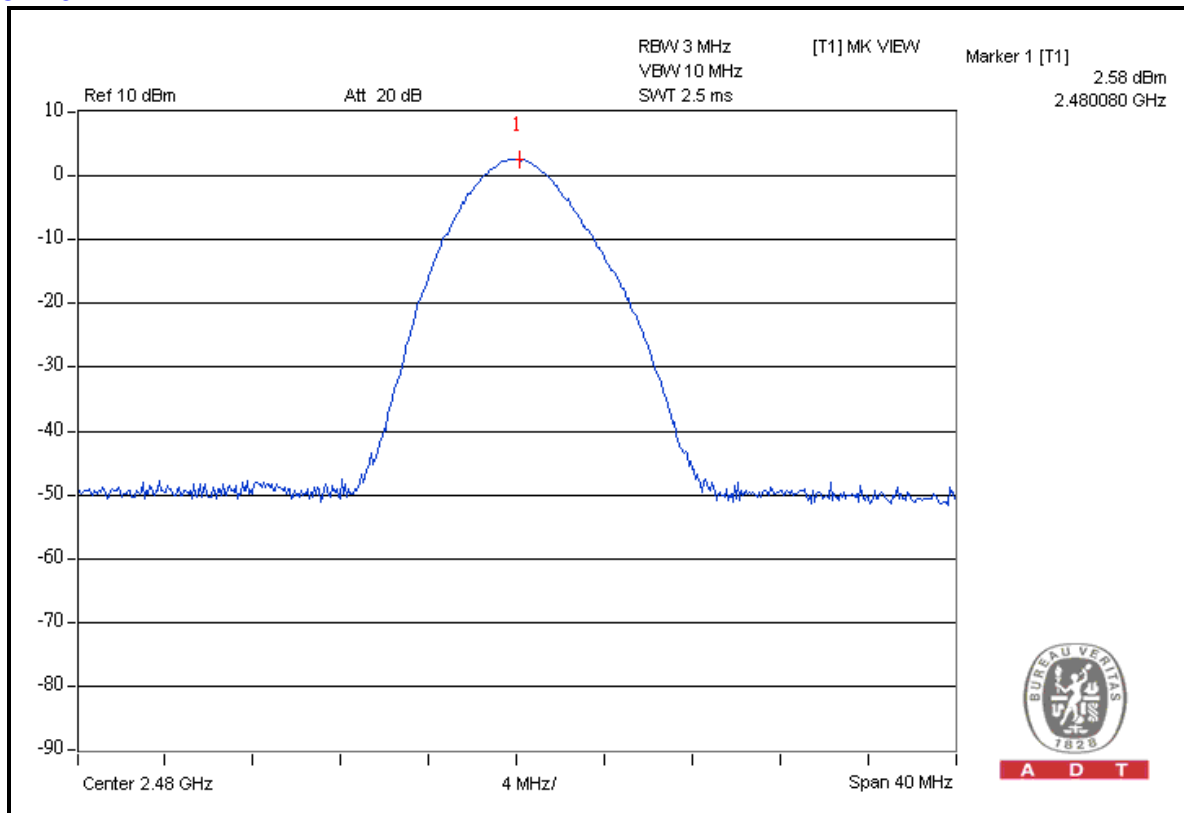



4.8 BAND EDGES MEASUREMENT

4.8.1 LIMITS OF BAND EDGES MEASUREMENT

Below -20dB of the highest emission level of operating band (in 100KHz RBW).

4.8.2 TEST INSTRUMENTS

DESCRIPTION & MANUFACTURER	MODEL NO.	SERIAL NO.	CALIBRATED DATE	CALIBRATED UNTIL
SPECTRUM ANALYZER	FSP 40	100035	Mar. 26, 2008	Mar. 25, 2009

NOTE: The calibration interval of the above test instruments is 12 months and the calibrations are traceable to NML/ROC and NIST/USA.

4.8.3 TEST PROCEDURE

The transmitter output was connected to the spectrum analyzer via a low lose cable. Set both RBW and VBW of spectrum analyzer to 100 kHz and 300 kHz with suitable frequency span including 100 MHz bandwidth from band edge. The band edges was measured and recorded.

The spectrum plots are attached on the following pages.

4.8.4 DEVIATION FROM TEST STANDARD

No deviation.

4.8.5 EUT OPERATING CONDITION

The software provided by client enabled the EUT to transmit and receive data at lowest, middle and highest channel frequencies individually.



4.8.6 TEST RESULTS

The spectrum plots are attached on the following 8 images. D1 line indicates the highest level, D2 line indicates the 20dB offset below D1. It shows compliance with the requirement in part 15.247(d).

TEST MODE A FOR GFSK MODULATION

NOTE 1:

The band edge emission plot on the next page shows 59.44dBc between carrier maximum power and local maximum emission in restrict band (2.3760GHz). The emission of carrier strength list in the test result of channel 0 at the item 4.2.7 is 95.35dBuV/m (Peak), so the maximum field strength in restrict band is $95.35 - 59.44 = 35.91$ dBuV/m, which is under 74 dBuV/m limit.

Average value = $35.91 - 30.10 = 5.81$ dBuV/m, which is under 54dBuV/m limit.

*The DH5 packet was the worse case duty cycle for a transmit dwell time on a channel, based upon bluetooth theory the transmitter is on $0.625 * 5$ per 296.25 ms per channel. Therefore, the duty cycle be equal to: $20\log(3.125/100) = -30.1$ dB.

Average value = peak reading -30.10 .

NOTE 2:

The band edge emission plot on the next second page shows 44.64dBc between carrier maximum power and local maximum emission in restrict band (2.48460GHz). The emission of carrier strength list in the test result of channel 78 at the item 4.2.7 is 92.82dBuV/m (Peak), so the maximum field strength in restrict band is $92.82 - 44.64 = 48.18$ dBuV/m, which is under 74 dBuV/m limit.

Average value = $48.18 - 30.10 = 18.08$ dBuV/m, which is under 54dBuV/m limit.

*The DH5 packet was the worse case duty cycle for a transmit dwell time on a channel, based upon bluetooth theory the transmitter is on $0.625 * 5$ per 296.25 ms per channel. Therefore, the duty cycle be equal to: $20\log(3.125/100) = -30.1$ dB.

Average value = peak reading -30.10 .



TEST MODE B FOR GFSK MODULATION

NOTE 1:

The band edge emission plot on the next page shows 59.44dBc between carrier maximum power and local maximum emission in restrict band (2.3760GHz). The emission of carrier strength list in the test result of channel 0 at the item 4.2.7 is 100.86dBuV/m (Peak), so the maximum field strength in restrict band is $100.86 - 59.44 = 41.42$ dBuV/m, which is under 74 dBuV/m limit.

Average value = $41.42 - 30.10 = 11.32$ dBuV/m, which is under 54dBuV/m limit.

*The DH5 packet was the worse case duty cycle for a transmit dwell time on a channel, based upon bluetooth theory the transmitter is on $0.625 * 5$ per 296.25 ms per channel. Therefore, the duty cycle be equal to: $20\log(3.125/100) = -30.1$ dB.

Average value = peak reading -30.10 .

NOTE 2:

The band edge emission plot on the next second page shows 44.64dBc between carrier maximum power and local maximum emission in restrict band (2.48460GHz). The emission of carrier strength list in the test result of channel 78 at the item 4.2.7 is 100.97dBuV/m (Peak), so the maximum field strength in restrict band is $100.97 - 44.64 = 56.33$ dBuV/m, which is under 74 dBuV/m limit.

Average value = $56.33 - 30.10 = 26.23$ dBuV/m, which is under 54dBuV/m limit.

*The DH5 packet was the worse case duty cycle for a transmit dwell time on a channel, based upon bluetooth theory the transmitter is on $0.625 * 5$ per 296.25 ms per channel. Therefore, the duty cycle be equal to: $20\log(3.125/100) = -30.1$ dB.

Average value = peak reading -30.10 .

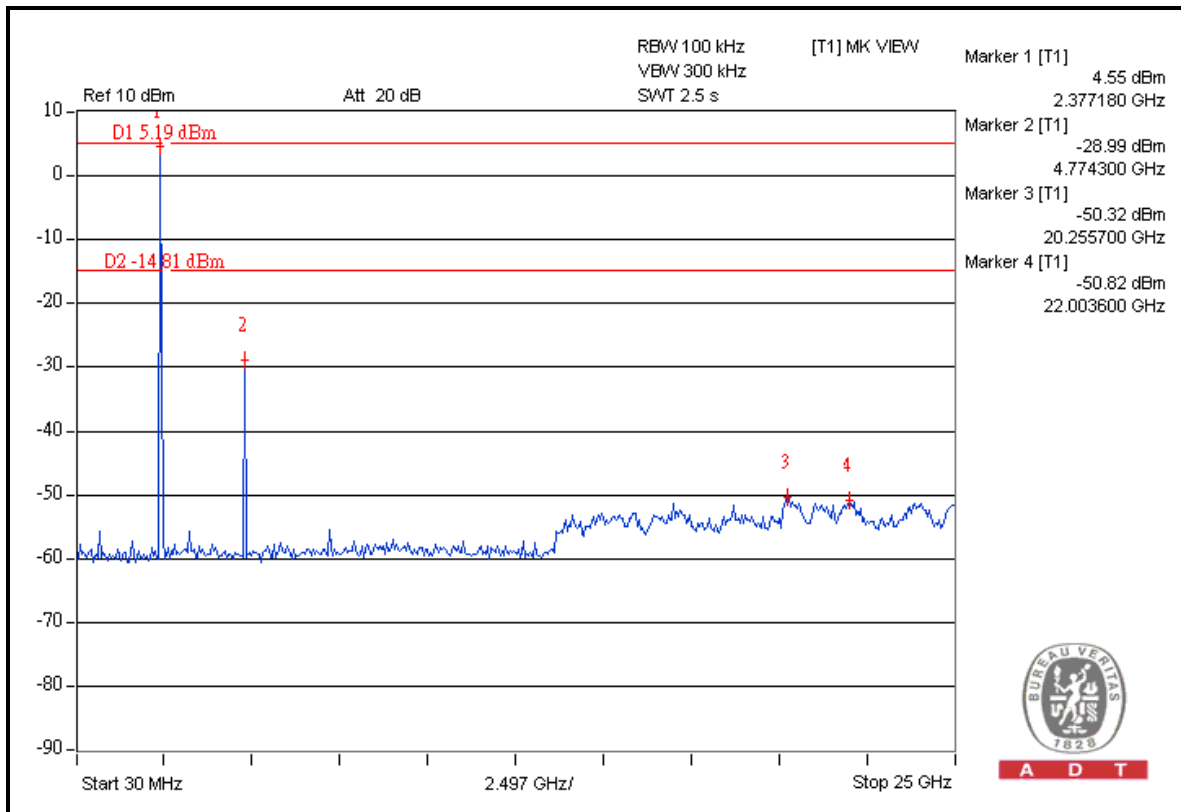
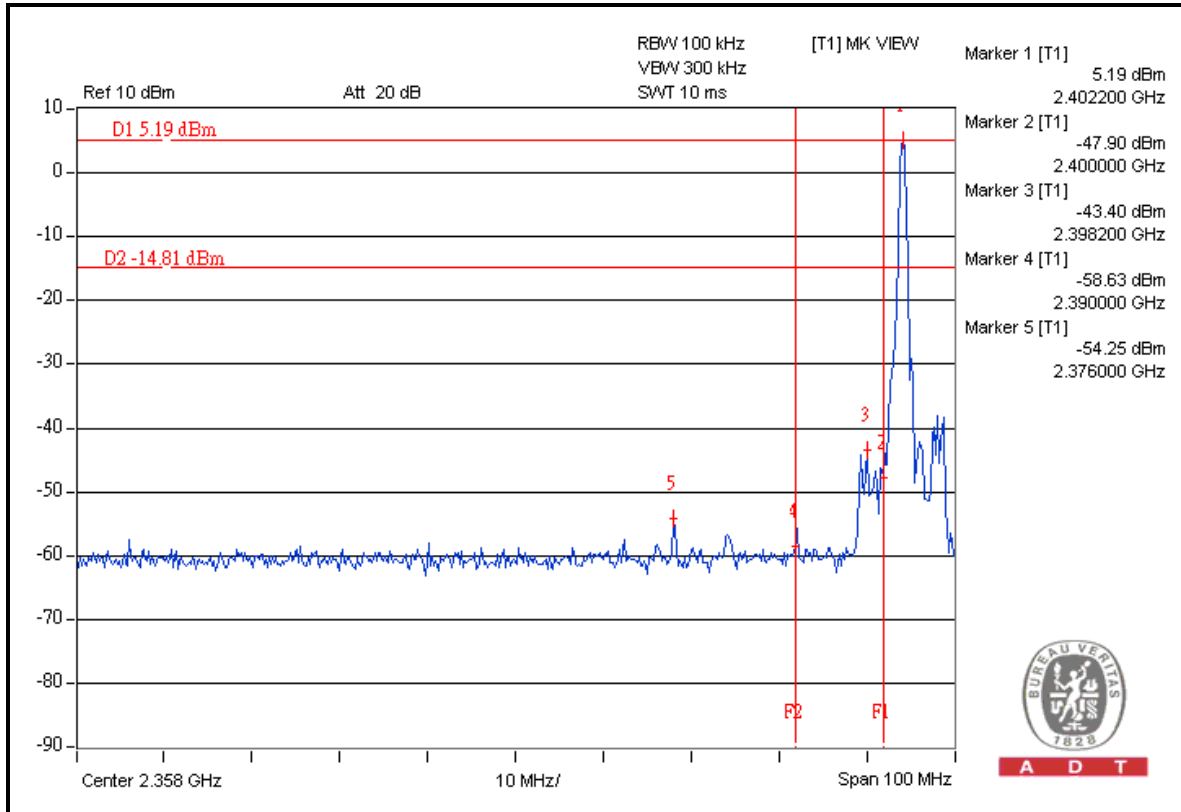

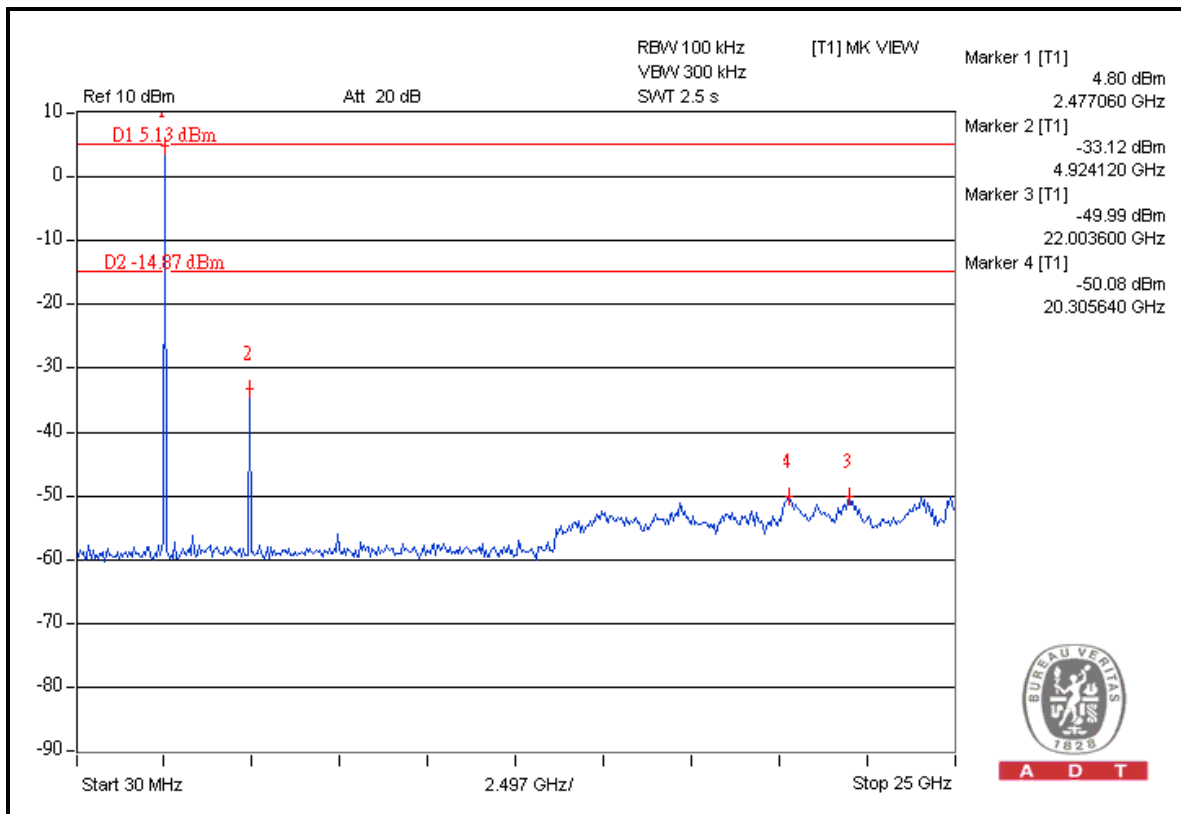
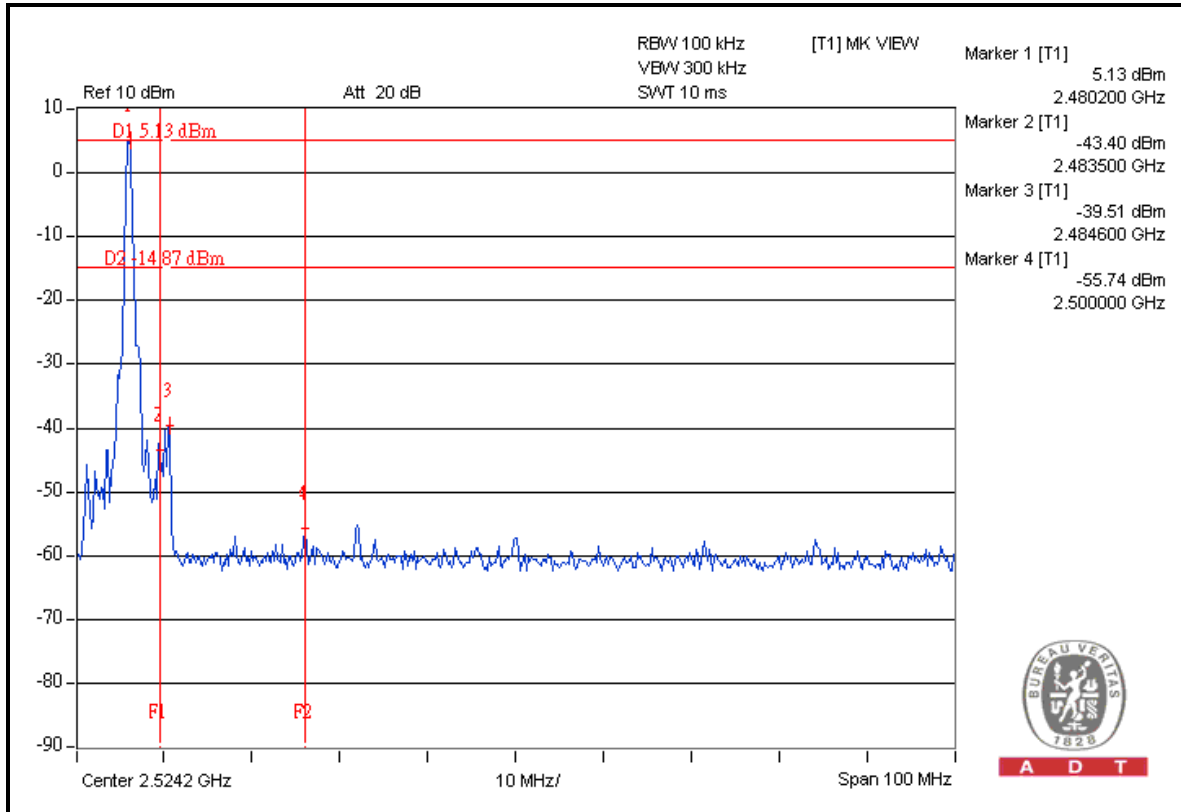



TEST MODE A FOR 8DPSK MODULATION

NOTE 1:

The band edge emission plot on the next page shows 57.35dBc between carrier maximum power and local maximum emission in restrict band (2.3864GHz). The emission of carrier strength list in the test result of channel 0 at the item 4.2.7 is 93.08dBuV/m (Peak), so the maximum field strength in restrict band is $93.08 - 57.35 = 35.73$ dBuV/m, which is under 74 dBuV/m limit.

Average value = $35.73 - 30.10 = 5.63$ dBuV/m, which is under 54dBuV/m limit.

*The DH5 packet was the worse case duty cycle for a transmit dwell time on a channel, based upon bluetooth theory the transmitter is on $0.625 * 5$ per 296.25 ms per channel. Therefore, the duty cycle be equal to: $20\log(3.125/100) = -30.1$ dB.

Average value = peak reading -30.10 .

NOTE 2:

The band edge emission plot on the next second page shows 48.23dBc between carrier maximum power and local maximum emission in restrict band (2.4835GHz). The emission of carrier strength list in the test result of channel 78 at the item 4.2.7 is 92.82dBuV/m (Peak), so the maximum field strength in restrict band is $91.05 - 48.23 = 42.82$ BuV/m, which is under 74 dBuV/m limit.

Average value = $42.82 - 30.10 = 12.72$ dBuV/m, which is under 54dBuV/m limit.

*The DH5 packet was the worse case duty cycle for a transmit dwell time on a channel, based upon bluetooth theory the transmitter is on $0.625 * 5$ per 296.25 ms per channel. Therefore, the duty cycle be equal to: $20\log(3.125/100) = -30.1$ dB.

Average value = peak reading -30.10 .



TEST MODE B FOR 8DPSK MODULATION

NOTE 1:

The band edge emission plot on the next page shows 57.35dBc between carrier maximum power and local maximum emission in restrict band (2.3864GHz). The emission of carrier strength list in the test result of channel 0 at the item 4.2.7 is 98.93dBuV/m (Peak), so the maximum field strength in restrict band is $98.93 - 57.35 = 41.58$ dBuV/m, which is under 74 dBuV/m limit.

Average value = $41.58 - 30.10 = 11.48$ dBuV/m, which is under 54dBuV/m limit.

*The DH5 packet was the worse case duty cycle for a transmit dwell time on a channel, based upon bluetooth theory the transmitter is on $0.625 * 5$ per 296.25 ms per channel. Therefore, the duty cycle be equal to: $20\log(3.125/100) = -30.1$ dB.

Average value = peak reading -30.10 .

NOTE 2:

The band edge emission plot on the next second page shows 48.23dBc between carrier maximum power and local maximum emission in restrict band (2.4835GHz). The emission of carrier strength list in the test result of channel 78 at the item 4.2.7 is 100.18dBuV/m (Peak), so the maximum field strength in restrict band is $100.18 - 48.23 = 51.95$ BuV/m, which is under 74 dBuV/m limit.

Average value = $51.95 - 30.10 = 21.85$ dBuV/m, which is under 54dBuV/m limit.

*The DH5 packet was the worse case duty cycle for a transmit dwell time on a channel, based upon bluetooth theory the transmitter is on $0.625 * 5$ per 296.25 ms per channel. Therefore, the duty cycle be equal to: $20\log(3.125/100) = -30.1$ dB.

Average value = peak reading -30.10 .

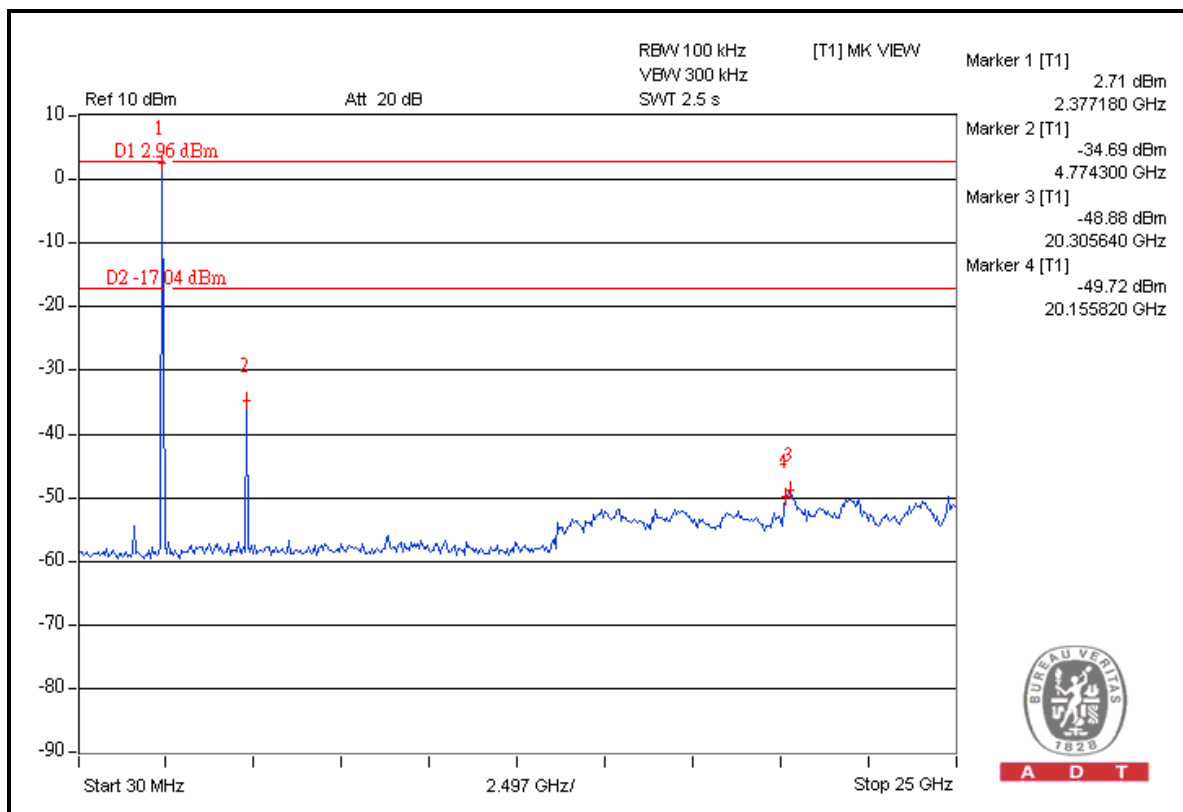
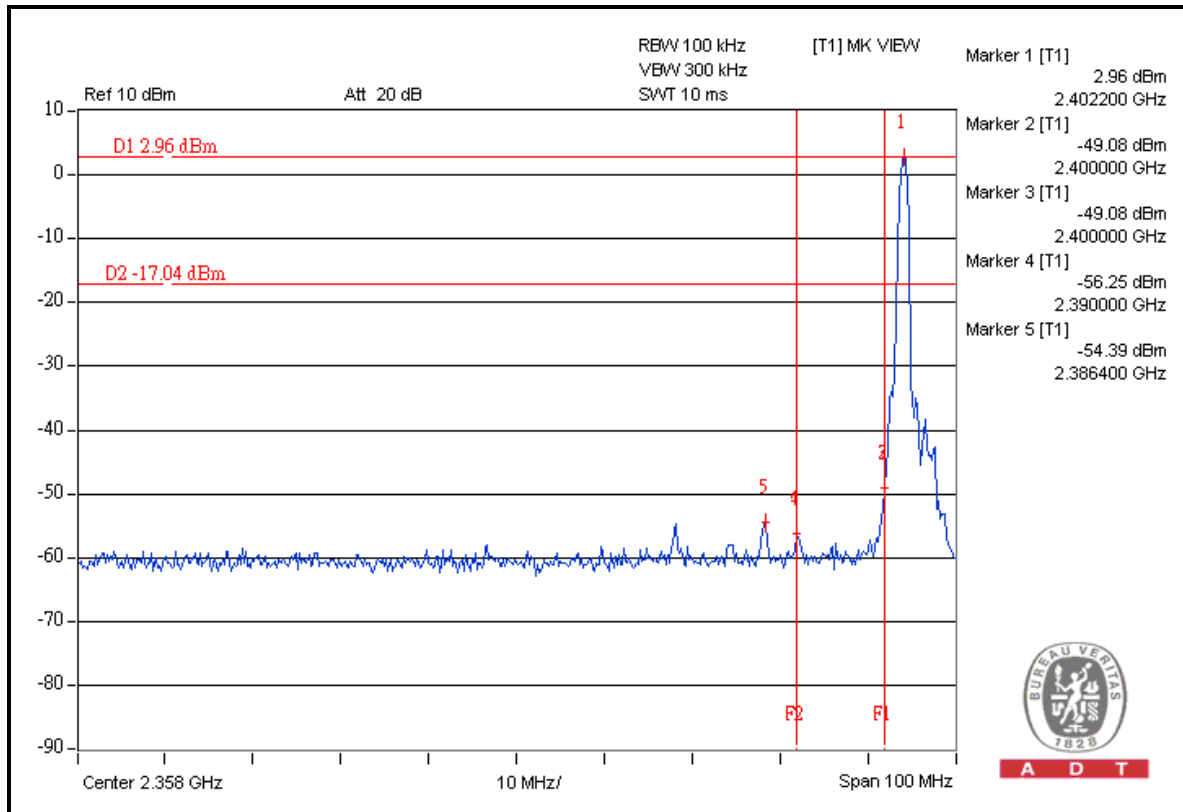

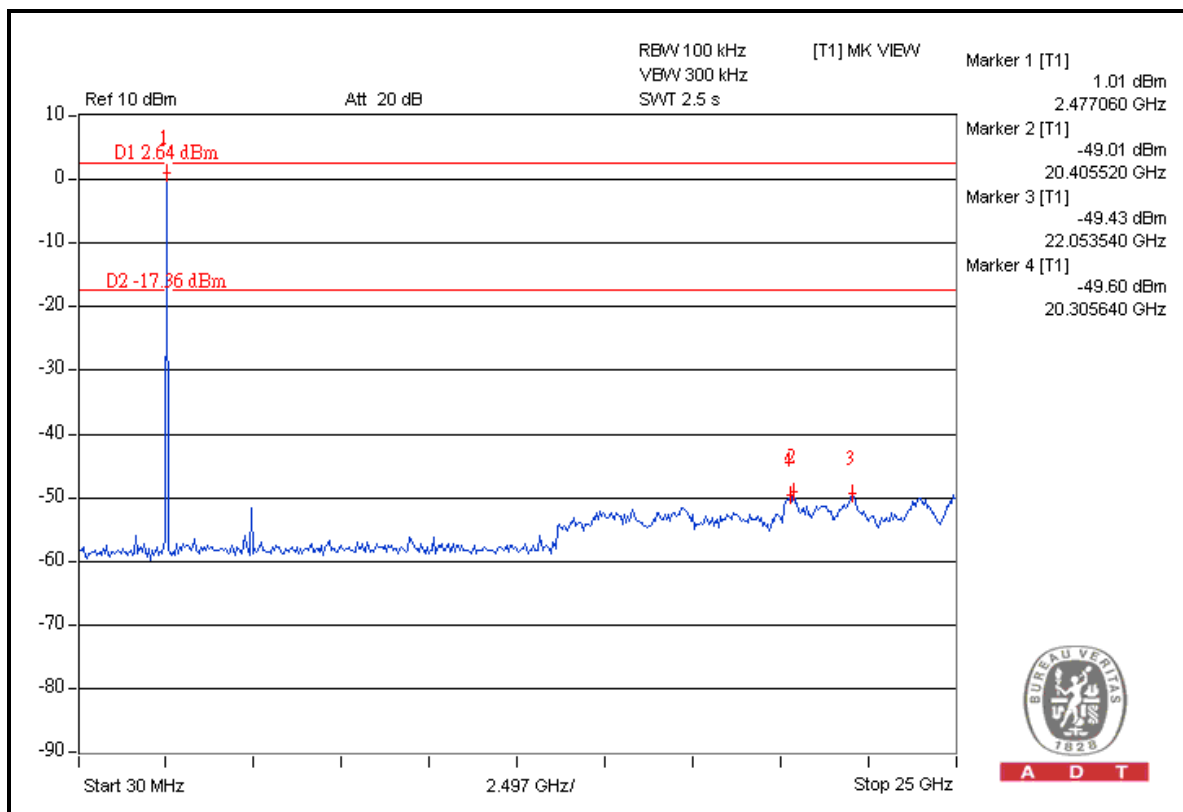
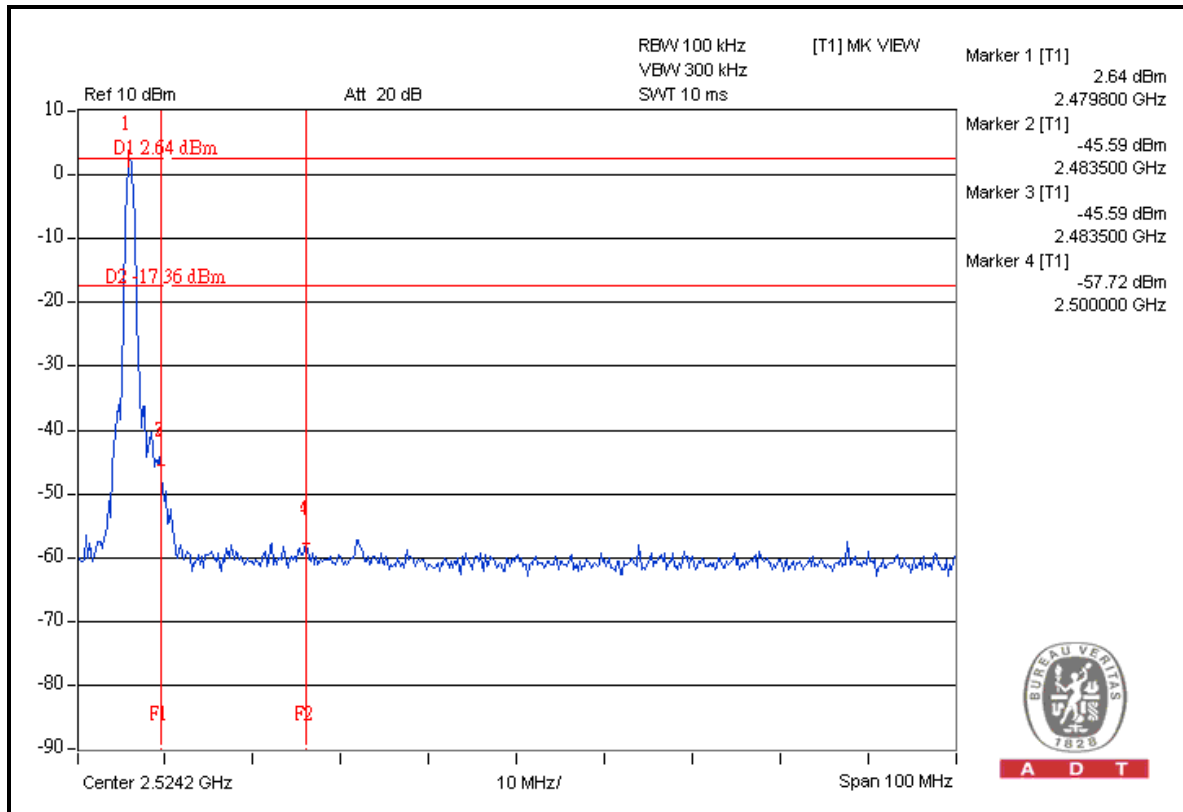



4.9 ANTENNA REQUIREMENT

4.9.1 STANDARD APPLICABLE

For intentional device, according to FCC 47 CFR Section 15.203, an intentional radiator shall be designed to ensure that no antenna other than that furnished by the responsible party shall be used with the device.

And according to FCC 47 CFR Section 15.247 (b), if transmitting antennas of directional gain greater than 6 dBi are used, the power shall be reduced by the amount in dB that the directional gain of the antenna exceeds 6 dBi.

4.9.2 ANTENNA CONNECTED CONSTRUCTION

The antennas used in this product are Chip antenna, PIFA antenna that with U.FL antenna connector but Chip antenna without connector. The maximum gain of this antenna is 2.25dBi.



5. PHOTOGRAPHS OF THE TEST CONFIGURATION

Please refer to the attached file (Test Setup Photo).



6. INFORMATION ON THE TESTING LABORATORIES

We, ADT Corp., were founded in 1988 to provide our best service in EMC, Radio, Telecom and Safety consultation. Our laboratories are accredited and approved by the following approval agencies according to ISO/IEC 17025.

USA	FCC, UL
Germany	TUV Rheinland
Japan	VCCI
Norway	NEMKO
Canada	INDUSTRY CANADA, CSA
R.O.C.	TAF, BSMI, NCC
Netherlands	Telefication
Singapore	GOST-ASIA(MOU)
Russia	CERTIS(MOU)

Copies of accreditation certificates of our laboratories obtained from approval agencies can be downloaded from our web site: www.adt.com.tw/index.5/phtml.

If you have any comments, please feel free to contact us at the following:

Linko EMC/RF Lab:
Tel: 886-2-26052180
Fax: 886-2-26051924

Hsin Chu EMC/RF Lab:
Tel: 886-3-5935343
Fax: 886-3-5935342

Hwa Ya EMC/RF/Safety Telecom Lab:
Tel: 886-3-3183232
Fax: 886-3-3185050

Web Site: www.adt.com.tw

The address and road map of all our labs can be found in our web site also.

7. APPENDIX A – MODIFICATIONS RECORDERS FOR ENGINEERING CHANGES TO THE EUT BY THE LAB

No any modifications are made to the EUT by the lab during the test.

---END---