

TO: 凱碩科技股份有限公司

SPECIFICATION FOR APPROVAL

DESCRIPTION : ANTENNA-2.4G (BLACK)+1.13(90mm)+CORE+UFL
CONNECTOR

PART NO : _____

慶陸 PART NO : 6602113051-090

DATE : 2007/12/24

PLEASE RETURN TO US ONE COPY OF “ SPECIFICATION FOR APPROVAL ” WITH YOUR APPROVED SIGNATURES

APPROVED SIGNATURES

			
--	--	--	---

蘇州慶旺電子



慶陸工業股份有限公司 KINSUN INDUSTRIES INC.

桃園縣中壢市普忠路 211 巷 20 號

TEL : 886-3-4353551

FAX : 886-3-4353951

[Http://www.kinsun.com](http://www.kinsun.com)

e-mail: jason@kinsun.com

TECHNICAL DATA

Electrical Properties

Frequency Range: 2.4~2.5GHz

Impedance: 50 Ohm nominal

V.S.W.R : ≤ 2.0

Gain: 2dBi \pm 0.25

Radiation: Omni

Polarization: Vertical

Electrical Wave: Dipole Array

Connector: UFL Plug

Mechanical Properties

Antenna Cover: PU

Color : BLACK

Operation Temperature:-20°C~+60°C

Storage Temperature:-30°C~+75°C

RoHS COMPLIANT

MECHANICAL

Antenna Cover : PU

Antenna Base : PC UL 94V-0

Color : Black

ELECTRICAL

Frequency : 2.4GHz

Connector : UFL

Cable : Coaxial Cable ϕ 1.13

Core : 4x10x2 mm

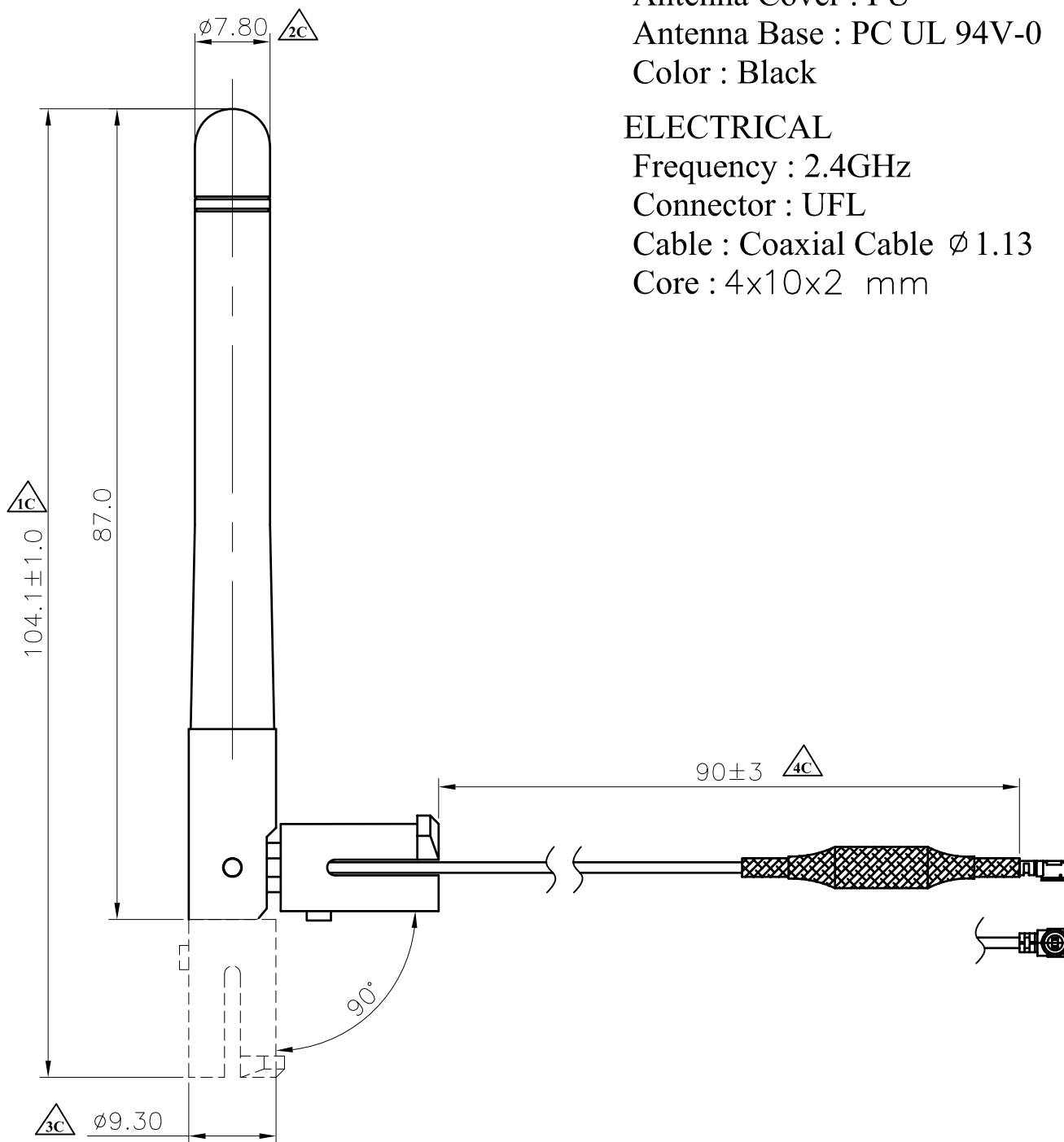

※凡標註△記號者，為品管檢驗之尺寸

設計DR. Marco 2007/12/20	核准APPD. Jerry 2007/12/20	容許公差 .XXX ±0.10 .XX ±0.25 .X ±0.38 X ±0.50 ANG ±3°	TOLERANCE	品名 ARTICLE 6602-2.4G-UFL
版本說明 REVISION NOTE				圖號 DWG NO. 6602113051-090
KINSUN 慶陞		單位 UNIT mm		比例 SCALE 1.5/1
		張數 SHEET 1/1		版本 REV. A

Brand / Model : 6602113051-090

Remark : 2450MHz

Tested by : Allen Yu

Date : 2007/12/25

Time : 下午 03 : 00

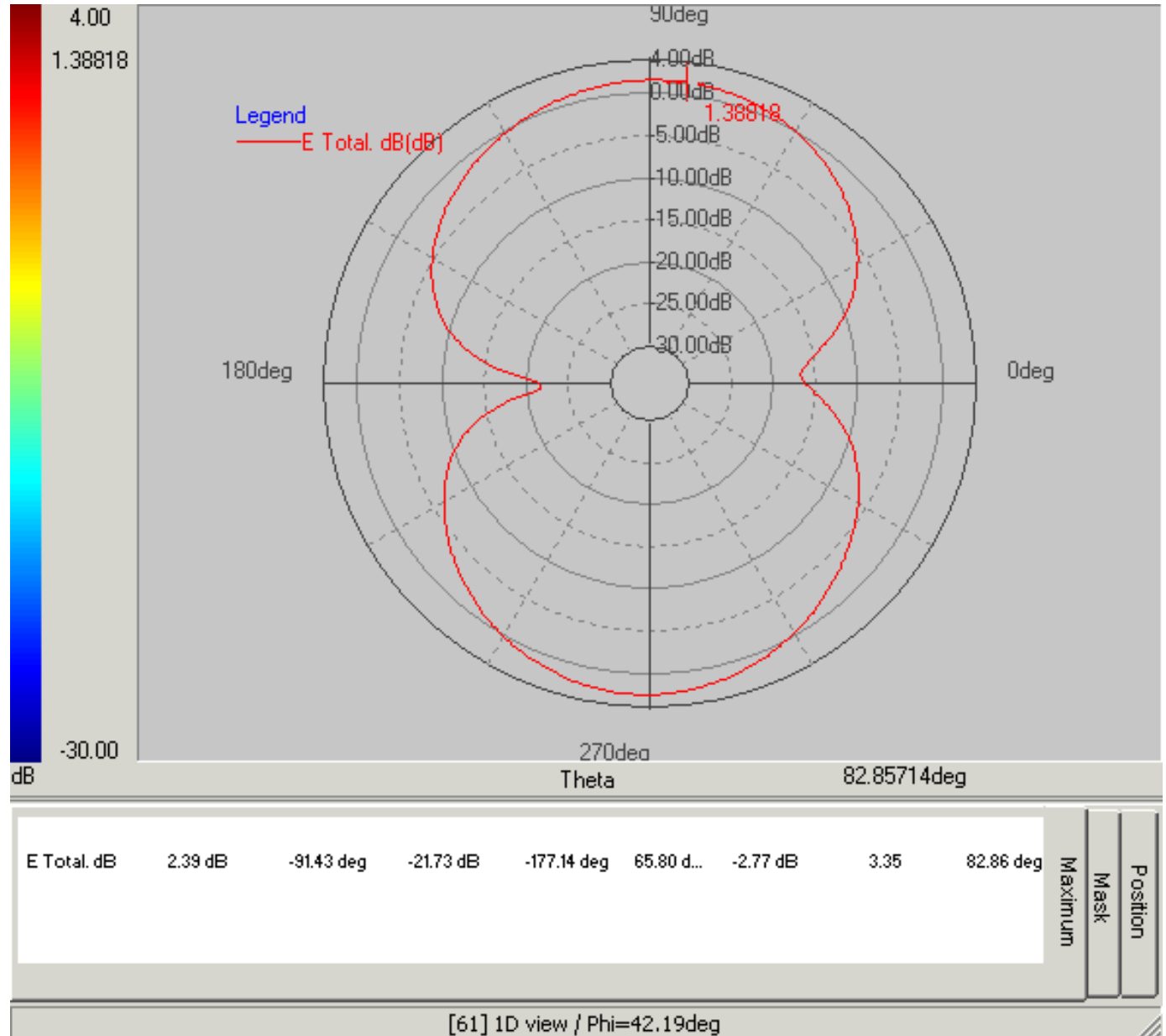

-- : Max. deg

*Unit : dBi

Frequency(MHz) : 2450.00

Pattern Field : E plane

Average Gain(dB) : -2.77dB

Maximum Gain(dB) : 2.39dB

Maximum Gain(degree) : -91.43

Minimum Gain(dB) : -21.73dB

Minimum Gain(degree) : -177.14

Brand / Model : 6602113051-090

Remark : 2450MHz

Tested by : Allen Yu

Date : 2007/12/25

Time : 下午 03 : 00

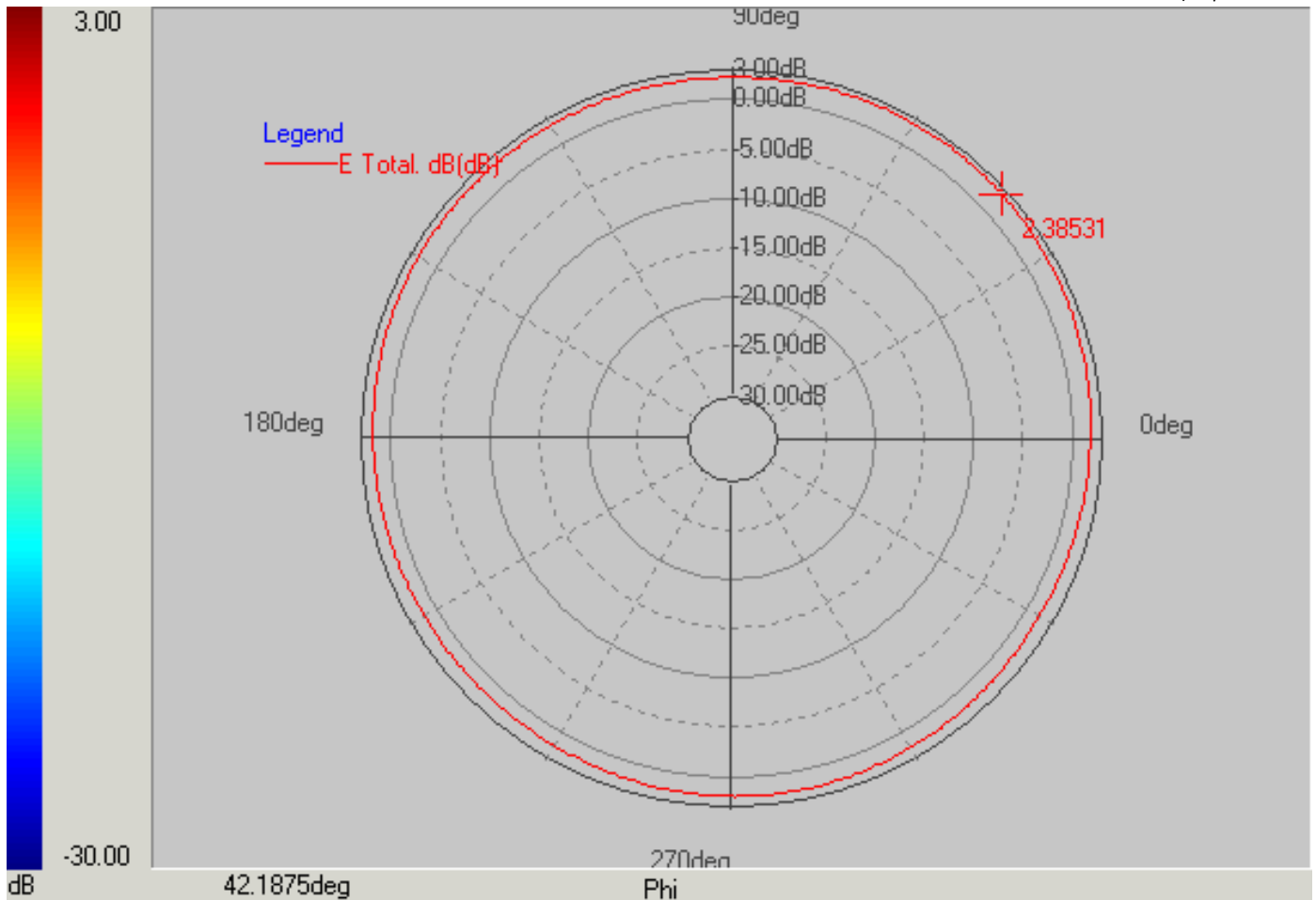

E Total. dB	2.39 dB	42.19 deg	1.38 dB	222.19 d...	---	1.89 dB	0.47	42.19 de	Maximum	Mask	Position
-------------	---------	-----------	---------	-------------	-----	---------	------	----------	---------	------	----------

[66] 1D view / Theta=-91.43deg

-- : Max. deg

*Unit : dBi

Frequency(MHz) : 2450.00

Pattern Field : H plane

Average Gain(dB) : 1.89dB

Maximum Gain(dB) : 2.39dB

Maximum Gain(degree) : 42.19

Minimum Gain(dB) : 1.38dB

Minimum Gain(degree) : 222.19

6602113051-090

S11

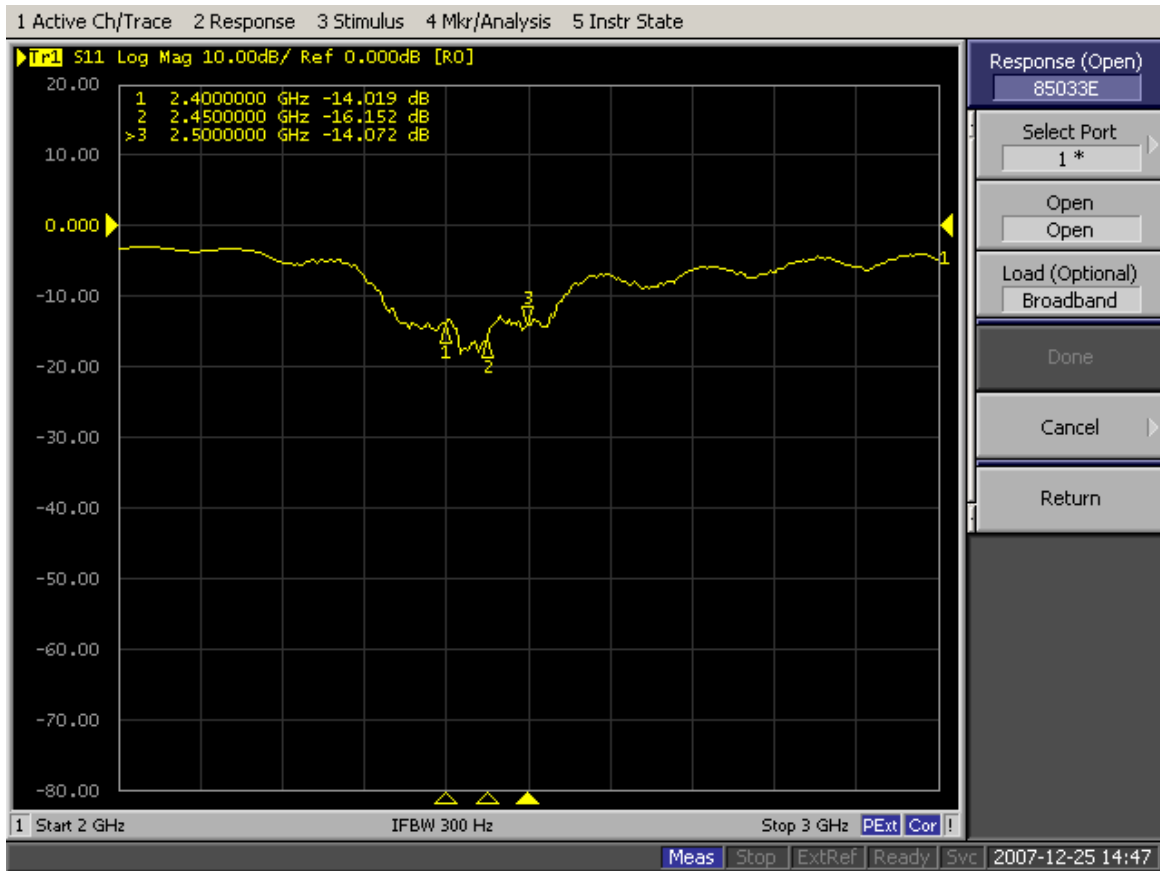

VSWR

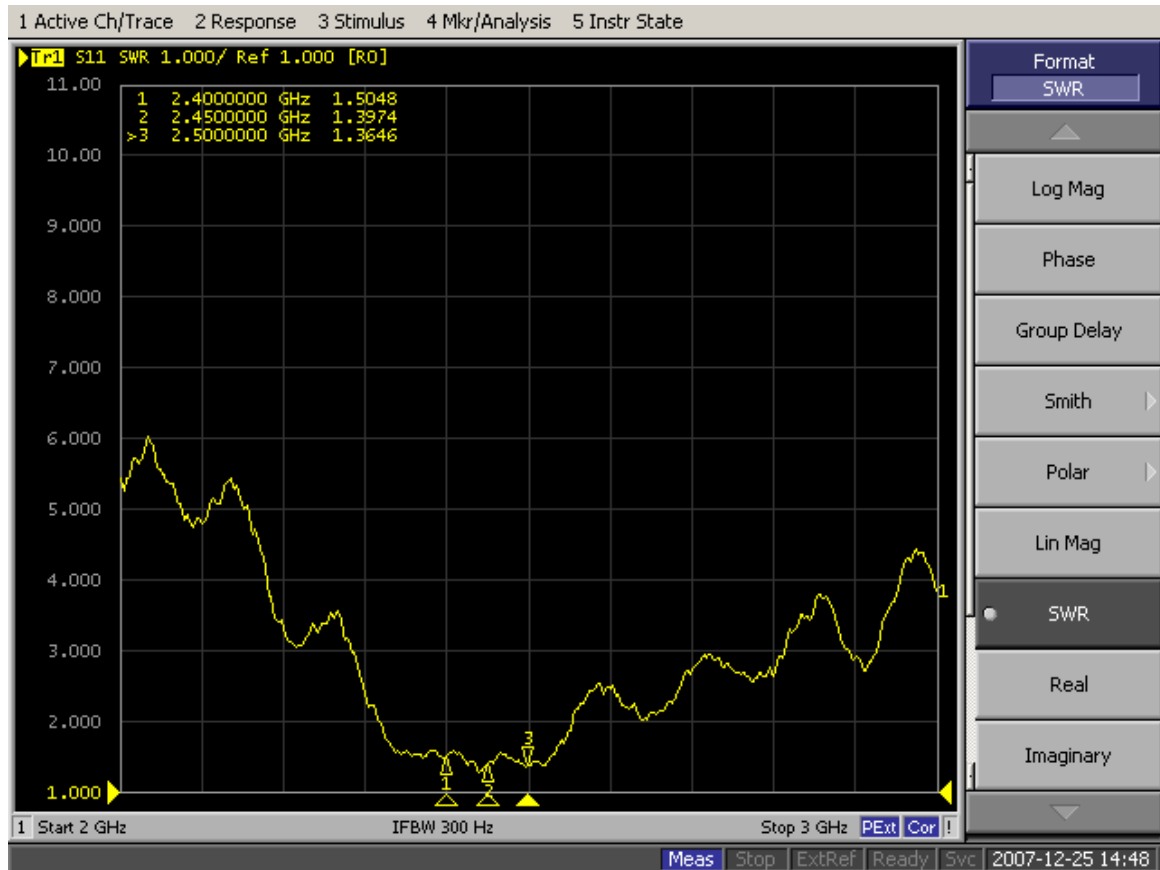

Elastollan[®] S Series

Technical Bulletin

Polyester Type

Elastollan[®] S series of products are polyester-based thermoplastic polyurethanes that exhibit good hydrolytic stability. They also exhibit good oil, fuel and solvent resistance. These products can be injection molded, blow molded and extruded. All grades should be dried before processing. Elastollan[®] products can be stored for up to 1 year in their original container. Containers should be stored in a cool, dry area.

Extrusion grades: S90A

Injection molding grades: S80A to S60D

Physical Properties	Units	ASTM Method	S80A ³	S85A ³	S90A ³	S95A ³	S98A ³	S60D ³
Specific gravity	gr./cm ³	D-792	1.21	1.22	1.23	1.23	1.24	1.25
Hardness	Shore A D	D-2240	80 ± 2	85 ± 2	92 ± 2	96 ± 2	98 ± 2	-
				-	41 ± 2	48 ± 2	54 ± 2	60 ± 2
Tensile strength	MPa psi	D-412	27.5	34	39	42	42	43
			4000	4900	5600	6100	6100	6200
Tensile stress @100 % elongation	MPa psi	D-412	5.5	6.9	11	14	19	22
			800	1000	1550	2000	2700	3200
@300 % elongation	MPa psi		9.6	14	20	26	32	37
			1400	1980	2900	3800	4700	5300
Elongation @brk.	%	D-412	650	690	540	510	425	450
Tensile set @brk.	%	D-412	45	35	55	70	80	110
Tear strength	N/mm lb./in.	D-624 DIE C		104	128	154	185	195
				590	730	875	1050	1150
Abrasion resistance	mg (Loss)	D-1044 ² (Taber)	25	25	25	30	50	50

Test samples were cured 20 hours @ 100 °C before testing.

- NOTE:** ¹ These products can only be ordered in minimum quantities. Please contact your sales representative for details.
² H-18 wheel, 1000 gm weight and 1000 cycles.
³ Products with an N designation do not contain hydrolytic stabilizers. Contact Elastollan Technical Service Rep for further information

Caution: Contact with product dusts from regrinding operations may cause temporary irritation of the eyes and the respiratory tract. Use with local exhaust. Under hot melt processing conditions (170-230 °C), wear personal protective equipment to prevent thermal burns.

First aid: *Eyes*-Flush eyes with flowing water at least 15 minutes. If irritation develops, consult a physician. *Skin*-Skin contact with hot melt may cause thermal burns. Call a physician immediately. *Inhalation*-If vapors generated from the hot melt process are inhaled, move to fresh air. Aid in breathing. If breathing difficulties develop, see a physician immediately.

In case of fire: Use water fog, foam, CO₂, or dry chemical extinguishing media. Firefighters should be equipped with self-contained breathing apparatus and turnout gear.

Disposal: Waste material, unused contents and empty containers must be disposed of in accordance with applicable local, state or federal regulations. Refer to our Material Safety Data Sheet for specific disposal instructions.

In case of chemical emergency: Call CHEMTREC day or night for assistance and information concerning spilled material, fire, exposure and other chemical accidents. 800-424-9300

Attention: This product is sold solely for use by industrial institutions. Refer to our Material Safety Data Sheet regarding safety, usage, applications, hazards, procedures and disposal of this product. Consult your supervisor for additional information.

No warranties of any kind, either express or implied, including warranties of merchantability or fitness for a particular purpose, are made regarding products described or designs, data or information set forth or that the products designs, data or information may be used without infringing the intellectual property rights of others in no case shall the descriptions information, data or designs provided be considered a part of our terms and conditions of sale. Further, you expressly understand and agree that the descriptions, designs, data and information furnished by BASF hereunder are provided gratis and BASF assumes no obligation or liability for the description, designs data and information given or results obtained, all such being given and accepted at your risk.

BASF Corporation, 1609 Biddle Avenue, Wyandotte, Michigan 48192 (800) 892-3111 x21, www.basf.com/elastollan

©BASF Corporation 2000

BASF

日本帝人化成聚碳酸酯樹脂 POLYCARBONATE RESIN "TEIJIN PANLITE"

規 格 型 號 特 性	比 重 g/cm ³	透 光 率 3mm 厚度 %	彎 曲 強 度 kg/cm ²	衝 擊 強 度 3mm 厚度 kg.cm/cm	熱 變 形 度 12.5kg °C	吸 收 率 %		防 火 等 級 UL-94	
						混 向	透 向		
高衝擊級	I.E-1250	高衝擊、射出級	1.18	半透明	21,500	85	134	0.5 ~ 0.9	H5
防火級	LN-1250 LN-2250	射出防火 V-0 無煙型	1.22	80	22,300	80	136	0.5 ~ 0.7	V-0
	LN-1250G	射出防火 V-0 有煙型	1.22	半透明	23,000	80	133	0.5 ~ 0.7	V-0
光反射射級	I.D-1000RM	全反射耐衝擊透光性級	1.23	光線反射率 2mm 厚 96 以上	25,000	80	134	0.4 ~ 0.6	
玻璃纖維強化級 PANLITE-G GLASS FIBRE REIN- FORCED GRADE	G-3110	射出玻璃纖維 10 %	1.27	半透明	36,000	9	146	0.3 ~ 0.5 0.4 ~ 0.5	V-2 V-0
	G-3115	射出玻璃纖維 15 %	1.30	半透明	45,000	12	147	0.2 ~ 0.4 0.4 ~ 0.5	V-2 V-0
	G-3120	射出玻璃纖維 20 %	1.34	半透明	55,000	14	148	0.1 ~ 0.3 0.4 ~ 0.6	V-2 V-1
	G-3130	射出玻璃纖維 30 %	1.43	半透明	74,000	16	149	0.02 ~ 0.2 0.3 ~ 0.5	V-2 V-1
易成型級 PANLITE-G MOLD RELEASE GRADE	G-3110R	射出、易成型含玻璃纖維 10 %	1.27	不透明	36,000	9	145	0.2 ~ 0.4 0.4 ~ 0.5	V-2 V-0
	G-3130R	射出、易成型含玻璃纖維 30 %	1.43	不透明	74,000	12	150	0.02 ~ 0.2 0.3 ~ 0.5	V-2 V-1
外觀良好級 PANLITE-G GOOD APPEARANCE G- RADE	G-3110H	射出、低屈曲含玻璃纖維 10 %	1.27	半透明	34,000	5	140	0.3 ~ 0.5 0.4 ~ 0.5	V-2 V-0
	G-3115H	射出、低屈曲含玻璃纖維 15 %	1.30	半透明	40,000	6		0.2 ~ 0.4 0.4 ~ 0.6	V-2 V-1
	G-3120H	射出、低屈曲含玻璃纖維 20 %	1.34	半透明	47,000	6		0.2 ~ 0.4 0.4 ~ 0.5	V-2 V-1
	G-3124H	射出、低屈曲含玻璃纖維 24 %		半透明	52,000	7		0.1 ~ 0.3 0.4 ~ 0.5	V-2 V-1
	G-3130H	射出、低屈曲含玻璃纖維 30 %	1.43	半透明	65,000	9	142	0.1 ~ 0.3 0.3 ~ 0.5	V-2 V-1
低屈曲級 PANLITE-G LOW ANISOTROPIC G- RADE	G-3110M	射出超低屈曲、外觀良好 含玻璃纖維 10 %	1.27	半透明	26,000	8	133	0.5 ~ 0.7	V-2 V-0
	G-3115M	射出超低屈曲、外觀良好含玻璃纖維 15 %	1.30	半透明	28,500	5	140	0.1 ~ 0.6	V-2
	G-3120M	射出超低屈曲、外觀良好含玻璃纖維 20 %	1.34	半透明	31,000	4	141	0.4 ~ 0.5	V-2
	G-3130M	射出超低屈曲、外觀良好 含玻璃纖維 30 %	1.43	半透明	40,000	2	135	0.3 ~ 0.5	V-2 V-1
玻璃纖維強化難燃級 FLAME RETARD GRADE	GN-3110	射出防火含玻璃纖維 10 %	1.26	半透明	35,000	7	146	0.3 ~ 0.5 0.4 ~ 0.6	V-0
	GN-3120	射出防火含玻璃纖維 20 %		半透明					V-0
	GN-3130	射出防火含玻璃纖維 30 %	1.44	半透明	75,000	12	149	0.02 ~ 0.2 0.3 ~ 0.5	V-0
FRICTION & ABRASION RESISTANT 耐磨、耐蝕級	GS-3130	射出、耐磨、耐蝕含玻璃纖維 30 %	1.51	半透明	77,000	14	150	0.02 ~ 0.2 0.3 ~ 0.5	V-1 V-0
	LS-1250	射出耐磨、耐蝕	1.23	半透明	21,500	12	136	0.5 ~ 0.7	V-2 V-0

◎ 以上表所列數值 僅供參考用

QMFZ2 Component - Plastics

Sunday, March 15, 1998

E50075

TEIJIN CHEMICALS LTD

HIBIYA DAIBIRU BLDG 2-2 UCHISAIWAI-CHO 1-CHOME CHIYODA-KU TOKYO 100-0011 JAPAN

Material Designation: **LN-1250G#(f1)***

Product Description: Polycarbonate (PC), designated "Panlife" furnished as pellets, powder.

Color	Min. Thick (mm)	Flame Class	HWI	HAI	RTIElec	RTIImp	RTI Str	IEC GWIT	IEC GWFI
ALL	1.0	V-0	1	2	125	105	115	-	-
	1.5	V-0	3	0	125	115	125	-	-
	3.0	V-0	3	0	125	115	125	-	-
	6.0	V-0	2	0	125	115	125	-	-

CTI: 3

HVTR: 3

D495: 6

IEC BP: -

Material designation may be suffixed with any one or two letters.

(f1) Suitable for outdoor use with respect to exposure to Ultraviolet Light, Water Exposure and Immersion in accordance with UL 746C.

* All colors except clear.

Report Date: 05/11/1989

Underwriters Laboratories Inc®

699748006

UL94 small-scale test data does not pertain to building materials, furnishings and related contents. UL 94 small-scale test data is intended solely for determining the flammability of plastic materials used in components and parts of end-product devices and appliances, where the acceptability of the combination is determined by ULL.

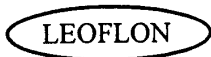

藍菱電子科技有限公司

LEOFLON ELECTRONICS INDUSTRIAL CO., LTD.

TEL:886-2-2903-8223 FAX:886-2-2908-1221

台北縣新莊市中正路649-3號10樓

鐵氟龍高頻同軸電纜線

FEP TEFLON Coaxial Cable

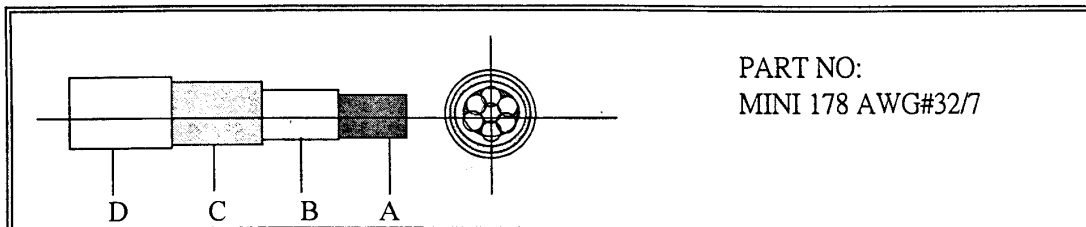

SPECIFICATION

A: CONDUCTOR

Material	Silver Plated Copper
Stranding	7x0.079mm
Diameter	0.237mm

B: INSULATION

Material	FEP
Thickness	0.211mm
Diameter	0.66mm

C: SHIELD

Shield Type	Braid
Material	Silver Plated Copper
Coverage	95%
Diameter	0.9mm

D: JACKET

Material	FEP
Thickness	0.115mm
Overall Diameter	1.13mm

MECHANICAL CHARACTERISTICS

Operating Temperature Range	-70°C ~ 200°C
Voltage	30V
Flame Test	UL-94



藍菱電子科技有限公司

LEOFLON ELECTRONICS INDUSTRIAL CO., LTD.

TEL:886-2-2903-8223 FAX:886-2-2908-1221

台北縣新莊市中正路649-3號10樓

Tensile Strength	Insulation 3789PSI
	Jacket: 4399PSI
Elongation	Insulation 320%
	Jacket: 330%

ELECTRONICAL CHARACTERISTICS

Nom. Impedance	50Ohms
Nom. Capacitance	95pF/M
Nom. Velocity of Propagation	69%
Dielectric Strength	6KV 0.5mA/Minute
Spark Test	6KV
VSWR (0~6GHz)	Less 1.3
Attenuation (dB/M)	

500MHz	2.4GHz	5.2GHz	6GHz
1.23	2.7	4.89	5.12

SPECIFICATION FOR APPROVAL

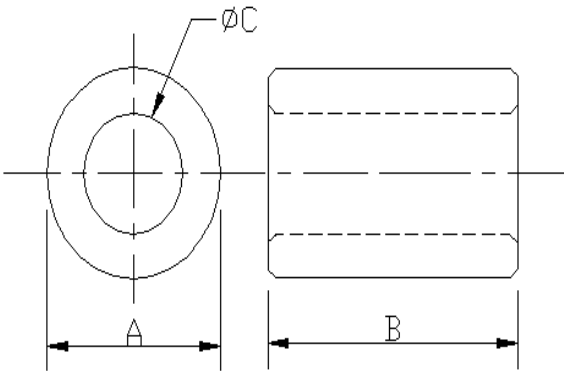
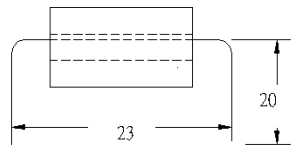
CUSTOMER:		CUST.P/N:
ITEM:	K5B RH 4x10x2	K.C.P/N: PS0404IA
(1) SHAPE : 	A	4.0±0.2 m/m
	B	10.0±0.4 m/m
	C	2.0±0.15 m/m
	D	m/m
	E	m/m
	F	m/m
	G	m/m
(2) ELECTRICAL REQUIREMENTS: $Z_1 = 37^{-0}$ OHM AT 25 MHz $Z_2 = 63^{-0}$ OHM AT 100 MHz	(3) TEST CONDITIONS: 1 IMPEDANCE ANALYZER IHP4191A TEST FIXTURE: HP16092A 2. WIRE: $\Phi 0.65$ T.C.W*63m/m/2Ts 3. DRAWING: 	
(4) PACKING <input checked="" type="checkbox"/> IN BULK <input type="checkbox"/> VACUUM <input type="checkbox"/> INSERTION 2000 PCS/BAGS* 4 BAG/INNER BOX* 4 BOXES/CARTON = 32000 PCS PCS/PLATE* PLATES/CARTON= PCS PCS/TRAY* TRAYS/CARTON= PCS	(5) APPEARANCE (1) AREA OF BREAK : <2 m/m ² (2) SUM OF BREAKING AREA : <3 m/m ² (3) DEPTH OF BREAK : <1 m/m	
(6) REMARK:	Approved by 黃國章	
	Checked by 吳明珠	
	Drawn by 吳明珠	
	DWG.NO.	

TEST DATA FOR PREPRODUCTION SAMPLES

CUSTOMER				CUST. P/N		
ITEM	<i>K5B RH 4x10x2</i>			K.C. P/N	<i>PS0404IA</i>	
TEMP.	24 °C	RH	69 %	DWG.NO.		
WIRE	0.65x63m/m T.C.W	WINDING	1/2 Ts	Q'TY		
Test Instruments						
Meas. Item.	Z (OHM)	Z (OHM)	A m/m	B m/m	C m/m	
Spec./ Yours.						
Spec./Suggest.	37⁻⁰	63⁻⁰	4.0±0.2	10.0±0.4	2.0±0.15	
Test Freq.	25 MHZ	100 MHZ				
1	51	85	4.08	10.06	2.04	
2	50	84	4.06	10.12	2.02	
3	50	84	4.04	10.10	2.00	
4	50	84	4.04	10.10	2.00	
5	51	85	4.04	10.06	2.00	
6						
7						
8						
9						
10						
\bar{X}	50	84	4.05	10.09	2.01	
R	1	1	0.04	0.06	0.04	
Your Sample.						
REMARK:				Approved by: 吴明珠		
				Checked by: 吴明珠		
				Drawn by: 吴明珠		

KING CORE ELECTRONICS INC.

K5B RH 4x10x2

