



RADIO TEST REPORT

Report No.: STS2211100W01

Issued for

ENJOY TECHNOLOGY CO., LIMITED

Unit 04, 7/F, Bright Way Tower No.33 Mong Kok Road,
Kowloon, Hongkong

Product Name:	Buzzer clicker galaxy audience response system
Brand:	EnjoyTech, Trebisky
Model Number:	206
Series Model(s):	106, 306, 406, 506, 237, 337, 437, 215, 205, 303, 305, 307
FCC ID:	RJM206305306215
Test Standard:	FCC Part 15.249

Any reproduction of this document must be done in full. No single part of this document may be reproduced without permission from STS, All Test Data Presented in this report is only applicable to presented Test sample.





TEST RESULT CERTIFICATION

Applicant's Name: ENJOY TECHNOLOGY CO., LIMITED
Address.....: Unit 04, 7/F, Bright Way Tower No.33 Mong Kok Road, Kowloon, Hongkong

Manufacture's Name: GUANGZHOU QILE TECHNOLOGY CO.,LTD
Address.....: No.226,Peizheng North Road, Huadu District, Guangzhou, Guangdong Province, China.

Product Description

Product Name: Buzzer clicker galaxy audience response system
Brand: EnjoyTech, Trebisky
Model Number.....: 206
Series Model(s): 106, 306, 406, 506, 237, 337, 437, 215, 205, 303, 305, 307

Test Standards.....: FCC Part15.249

Test Procedure.....: ANSI C63.10-2013

This device described above has been tested by STS, the test results show that the equipment under test (EUT) is in compliance with the FCC requirements. And it is applicable only to the tested sample identified in the report.
This report shall not be reproduced except in full, without the written approval of STS, this document only be altered or revised by STS, personal only, and shall be noted in the revision of the document.

Date of Test.....:
Date of receipt of test item.....: 17 Nov. 2022
Date of performance of tests ...: 17 Nov. 2022 ~ 22 Nov. 2022
Date of Issue.....: 22 Nov. 2022
Test Result: Pass

Testing Engineer : [Signature]
(Chris Chen)

Technical Manager : [Signature]
(Sean she)

Authorized Signatory : [Signature]
(Bovey Yang)





Table of Contents	Page
1. SUMMARY OF TEST RESULTS	5
1.1 TEST FACTORY	6
1.2 MEASUREMENT UNCERTAINTY	6
2. GENERAL INFORMATION	7
2.1 GENERAL DESCRIPTION OF THE EUT	7
2.2 DESCRIPTION OF THE TEST MODES	9
2.3 TEST SOFTWARE AND POWER LEVEL	9
2.4 BLOCK DIGRAM SHOWING THE CONFIGURATION OF SYSTEM TESTED	10
2.5 DESCRIPTION OF NECESSARY ACCESSORIES AND SUPPORT UNITS	11
2.6 EQUIPMENTS LIST FOR ALL TEST ITEMS	12
3. EMC EMISSION TEST	13
3.1 CONDUCTED EMISSION MEASUREMENT	13
3.2 RADIATED EMISSION MEASUREMENT	17
4. BANDWIDTH TEST	34
4.1 TEST PROCEDURE	34
4.2 TEST SETUP	34
4.3 EUT OPERATION CONDITIONS	34
4.4 TEST RESULTS	35
5. ANTENNA REQUIREMENT	37
5.1 STANDARD REQUIREMENT	37
5.2 EUT ANTENNA	37
APPENDIX- PHOTOS OF TEST SETUP	38



Revision History

Rev.	Issue Date	Report NO.	Effect Page	Contents
00	22 Nov. 2022	STS2211100W01	ALL	Initial Issue





1. SUMMARY OF TEST RESULTS

Test procedures according to the technical standards:

FCC Part 15.249 , Subpart C			
Standard Section	Test Item	Judgment	Remark
15.207	Conducted Emission	Pass	
15.203	Antenna Requirement	Pass	
15.249	Radiated Spurious Emission	Pass	
15.249	Radiated Band Edge Emission	Pass	
15.249	Field Strength of fundamental	Pass	
15.215(c)	20dB Bandwidth	Pass	

NOTE:

- (1) 'N/A' denotes test is not applicable in this Test Report.
- (2) All tests are according to ANSI C63.10-2013.

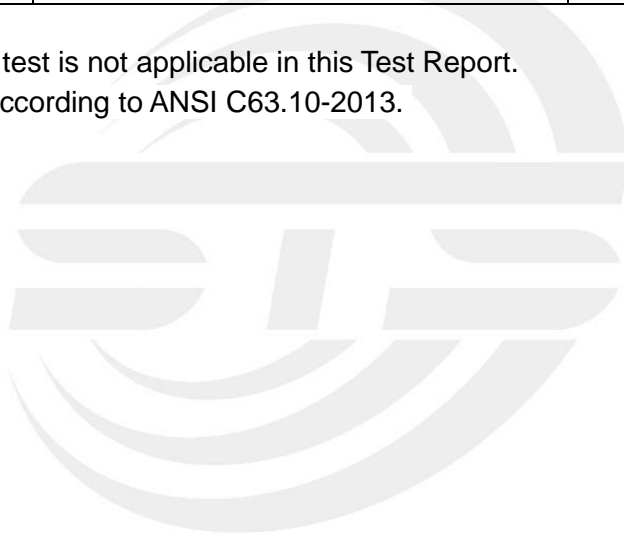



1.1 TEST FACTORY

SHENZHEN STS TEST SERVICES CO., LTD

Add. : A 1/F, Building B, Zhuoke Science Park, No.190 Chongqing Road, HepingShequ, Fuyong Sub-District, Bao'an District, Shenzhen, Guang Dong, China

FCC test Firm Registration Number: 625569

IC test Firm Registration Number: 12108A

A2LA Certificate No.: 4338.01

1.2 MEASUREMENT UNCERTAINTY

The reported uncertainty of measurement $y \pm U$, where expanded uncertainty U is based on a standard uncertainty multiplied by a coverage factor of $k=2$, providing a level of confidence of approximately **95 %**.

No.	Item	Uncertainty
1	RF output power, conducted	± 0.87 dB
2	Unwanted Emissions, conducted	± 2.895 dB
3	All emissions, radiated 9K-30MHz	± 3.80 dB
4	All emissions, radiated 30M-1GHz	± 4.09 dB
5	All emissions, radiated 1G-6GHz	± 4.92 dB
6	All emissions, radiated >6G	± 5.49 dB
7	Conducted Emission (9KHz-30MHz)	± 2.73 dB



2. GENERAL INFORMATION

2.1 GENERAL DESCRIPTION OF THE EUT

Product Name	Buzzer clicker galaxy audience response system								
Brand	EnjoyTech, Trebisky								
Model Number	206								
Series Model(s)	106, 306, 406, 506, 237, 337, 437, 215, 205, 303, 305, 307								
Model Difference	Product models are named differently								
Product Description	<p>The EUT is a Buzzer clicker galaxy audience response system</p> <table border="1"><tr><td>Operation Frequency:</td><td>2404~2480MHz</td></tr><tr><td>Modulation Type:</td><td>FSK</td></tr><tr><td>Antenna Designation:</td><td>Monopole</td></tr><tr><td>Antenna Gain(Peak):</td><td>0dBi</td></tr></table> <p>Based on the application, features, or specification exhibited in User Manual, the EUT is considered as an ITE/Computing Device. More details of EUT technical specification, please refer to the User Manual.</p>	Operation Frequency:	2404~2480MHz	Modulation Type:	FSK	Antenna Designation:	Monopole	Antenna Gain(Peak):	0dBi
Operation Frequency:	2404~2480MHz								
Modulation Type:	FSK								
Antenna Designation:	Monopole								
Antenna Gain(Peak):	0dBi								
Channel List	Please refer to the Note 3.								
Rating	Input: DC 5V 500mA								
Battery	DC 3.7V 55mA								
Hardware version number	N/A								
Software version number	N/A								
Connecting I/O Port(s)	Please refer to the Note 1.								

Note:

1. For a more detailed features description, please refer to the manufacturer's specifications or the User Manual.
2. The antenna information refer the manufacturer provide report, applicable only to the tested sample identified in the report. Due to the incorrect antenna information, a series of problems such as the accuracy of the test results will be borne by the customer.



3.

Channel List					
Channel	Frequency (MHz)	Channel	Frequency (MHz)	Channel	Frequency (MHz)
01	2404	27	2430	53	2456
02	2405	28	2431	54	2457
03	2406	29	2432	55	2458
04	2407	30	2433	56	2459
05	2408	31	2434	57	2460
06	2409	32	2435	58	2461
07	2410	33	2436	59	2462
08	2411	34	2437	60	2463
09	2412	35	2438	61	2464
10	2413	36	2439	62	2465
11	2414	37	2440	63	2466
12	2415	38	2441	64	2467
13	2416	39	2442	65	2468
14	2417	40	2443	66	2469
15	2418	41	2444	67	2470
16	2419	42	2445	68	2471
17	2420	43	2446	69	2472
18	2421	44	2447	70	2473
19	2422	45	2448	71	2474
20	2423	46	2449	72	2475
21	2424	47	2450	73	2476
22	2425	48	2451	74	2477
23	2426	49	2452	75	2478
24	2427	50	2453	76	2479
25	2428	51	2454	77	2480
26	2429	52	2455		



2.2 DESCRIPTION OF THE TEST MODES

For conducted test items and radiated spurious emissions

Each of these EUT operation mode(s) or test configuration mode(s) mentioned below was evaluated respectively.

Pretest Mode	Description	Data/Modulation
Mode 1	TX Low channel	FSK
Mode 2	TX Mid channel	FSK
Mode 3	TX High channel	FSK

Note:

(1) All above mode have been measurement, only worst data was reported.

(2) We have be tested for all avaiable U.S. voltage and frequencies(For 120V,50/60Hz and 240V, 50/60Hz) for which the device is capable of operation, and the worst case of 120V,50/60Hz is shown in the report.

For AC Conducted Emission

Test Case	
AC Conducted Emission	Mode 4 : Keeping TX

2.3 TEST SOFTWARE AND POWER LEVEL

During testing channel & power controlling software provided by the customer was used to control the operating channel as well as the output power level.

RF Function	Type	Mode Or Modulation type	ANT Gain(dBi)	Power Class	Software For Testing
Other SRD	2.4G	FSK	0	Default	The EUT has signal transmission when it is powered on

2.4 BLOCK DIGRAM SHOWING THE CONFIGURATION OF SYSTEM TESTED

During testing channel & power controlling software provided by the customer was used to control the operating channel as well as the output power level. The RF output power selection is for the setting of RF output power expected by the customer and is going to be fixed on the firmware of the final end product power parameters.

Radiated Spurious Emission Test

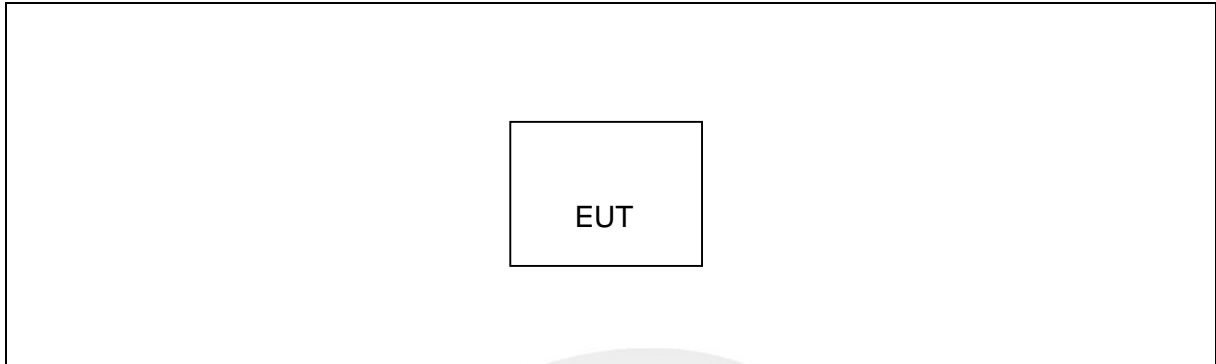

Conducted Emission Test

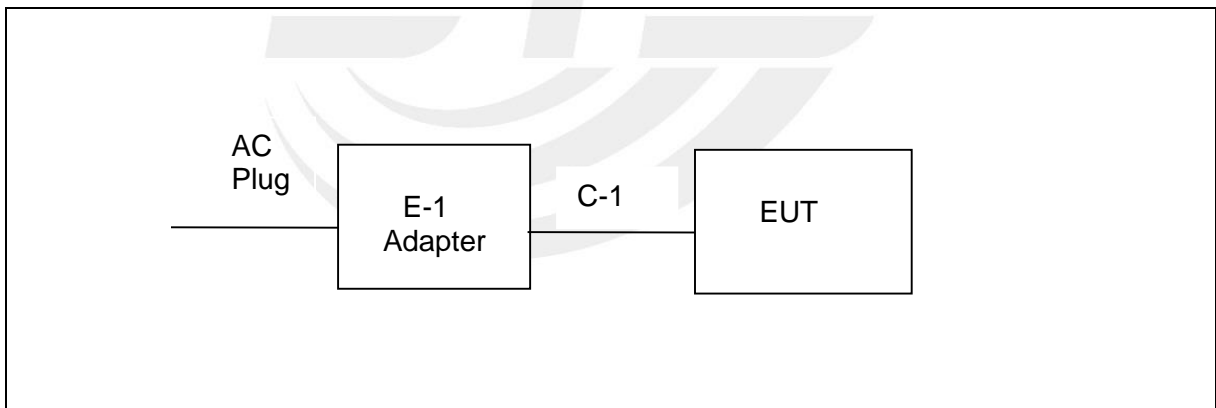



2.5 DESCRIPTION OF NECESSARY ACCESSORIES AND SUPPORT UNITS

The EUT has been tested as an independent unit together with other necessary accessories or support units. The following support units or accessories were used to form a representative test configuration during the tests.

Necessary accessories

Item	Equipment	Mfr/Brand	Model/Type No.	Length	Note
C-1	USB Cable	N/A	N/A	30cm	NO

Support units

Item	Equipment	Mfr/Brand	Model/Type No.	Length	Note
E-1	Adapter	HUAWEI	HW-050450C00	N/A	N/A

Note:

- (1) The support equipment was authorized by Declaration of Confirmation.
- (2) For detachable type I/O cable should be specified the length in cm in 『Length』 column.



2.6 EQUIPMENTS LIST FOR ALL TEST ITEMS

RF Radiation Test Equipment					
Kind of Equipment	Manufacturer	Type No.	Serial No.	Last Calibration	Calibrated Until
Temperature & Humidity	SW-108	SuWei	N/A	2022.03.02	2023.03.01
Pre-Amplifier(0.1M-3GHz)	EM	EM330	060665	2022.07.04	2023.07.03
Pre-Amplifier (1G-18GHz)	SKET	LNPA-01018G-45	SK2018080901	2022.09.29	2023.09.28
Pre-mpifier(18G-40G)	SKET	LNPA_1840-50	SK2018101801	2022.07.23	2023.07.22
Positioning Controller	MF	MF-7802	MF-780208587	N/A	N/A
Signal Analyzer	R&S	FSV 40-N	101823	2022.09.29	2023.09.28
Switch Control Box	N/A	N/A	N/A	N/A	N/A
Filter Box	BALUN Technology	SU319E	BL-SZ1530051	N/A	N/A
Active loop Antenna	ZHINAN	ZN30900C	16035	2022.03.02	2023.03.01
Bilog Antenna	TESEQ	CBL6111D	34678	2022.09.30	2024.09.29
Horn Antenna	SCHWARZBECK	BBHA 9120D	02014	2021.10.11	2023.10.10
Horn Antenna	A-INFOMW	LB-180400-KF	J211020657	2021.09.28	2023.09.27
Antenna Mast	MF	MFA-440H	N/A	N/A	N/A
Turn Table	MF	SC100_1	60531	N/A	N/A
AC Power Source	APC	KDF-11010G	F214050035	N/A	N/A
DC Power Supply	Zhaoxin	RXN 605D	20R605D11010081	N/A	N/A
Test SW	EZ-EMC	Ver.STSLAB-03A1 RE			
Conduction Test equipment					
Kind of Equipment	Manufacturer	Type No.	Serial No.	Last calibration	Calibrated until
Test Receiver	R&S	ESCI	101427	2022.09.29	2023.09.28
LISN	R&S	ENV216	101242	2022.09.28	2023.09.27
LISN	EMCO	3810/2NM	23625	2022.09.28	2023.09.27
Temperature & Humidity	HH660	Mieo	N/A	2022.09.30	2023.09.29
Test SW	EZ-EMC	Ver.STSLAB-03A1 CE			
RF Connected Test					
Kind of Equipment	Manufacturer	Type No.	Serial No.	Last calibration	Calibrated until
Signal Analyzer	Agilent	N9020A	MY51510623	2022.03.01	2023.02.28
Switch control box	MW	MW100-RFCB	N/A	N/A	N/A
Temperature & Humidity	HH660	Mieo	N/A	2022.09.30	2023.09.29
Test SW	MW	MTS 8310_2.0.0.0			

3. EMC EMISSION TEST

3.1 CONDUCTED EMISSION MEASUREMENT

3.1.1 POWER LINE CONDUCTED EMISSION LIMITS

Operating frequency band. In case the emission fall within the restricted band specified on Part 15.249 limit in the table below has to be followed.

FREQUENCY (MHz)	Quasi-peak	Average
0.15 -0.5	66 - 56 *	56 - 46 *
0.50 -5.0	56.00	46.00
5.0 -30.0	60.00	50.00

Note:

- (1) The tighter limit applies at the band edges.
- (2) The limit of “ * ” marked band means the limitation decreases linearly with the logarithm of the frequency in the range.

The following table is the setting of the receiver

Receiver Parameters	Setting
Attenuation	10 dB
Start Frequency	0.15 MHz
Stop Frequency	30 MHz
IF Bandwidth	9 kHz

3.1.2 TEST PROCEDURE

- a. The EUT was 0.8 meters from the horizontal ground plane and 0.4 meters from the vertical ground plane with EUT being connected to the power mains through a line impedance stabilization network (LISN). All other support equipments powered from additional LISN(s). The LISN provide 50 Ohm/ 50uH of coupling impedance for the measuring instrument.
- b. Interconnecting cables that hang closer than 40 cm to the ground plane shall be folded back and forth in the center forming a bundle 30 to 40 cm long.
- c. I/O cables that are not connected to a peripheral shall be bundled in the center. The end of the cable may be terminated, if required, using the correct terminating impedance. The overall length shall not exceed 1 m.
- d. LISN at least 80 cm from nearest part of EUT chassis.
- e. For the actual test configuration, please refer to the related Item –EUT Test Photos.

3.1.3 TEST SETUP

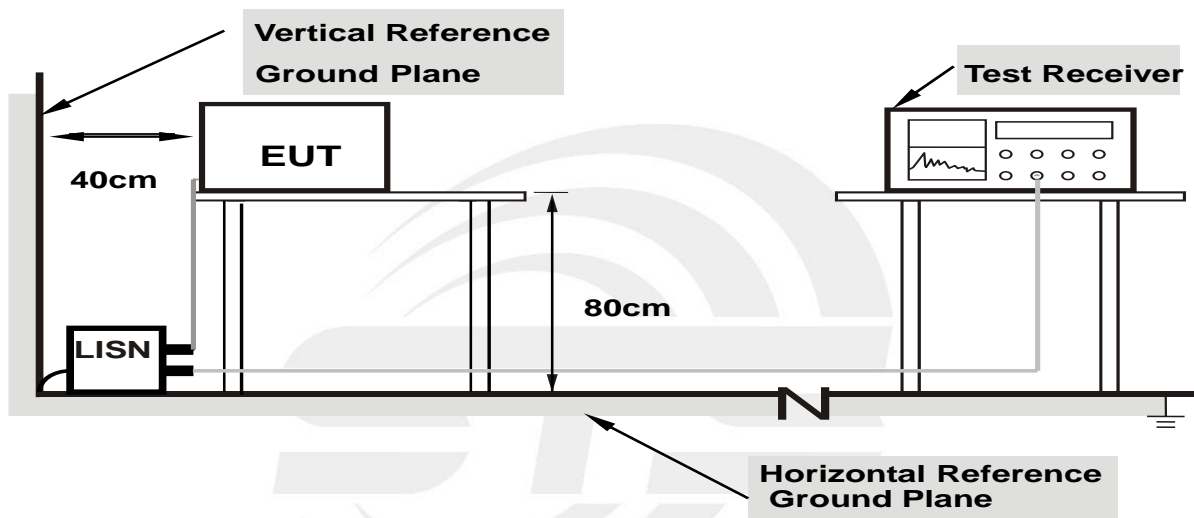

- Note: 1.Support units were connected to second LISN.**
2.Both of LISNs (AMN) are 80 cm from EUT and at least 80 from other units and other metal planes

3.1.4 EUT OPERATING CONDITIONS

The EUT was configured for testing in a typical fashion (as a customer would normally use it). The EUT has been programmed to continuously transmit during test. This operating condition was tested and used to collect the included data.



3.1.5 TEST RESULT

Temperature:	25.6(C)	Relative Humidity:	45%RH
Test Voltage:	AC 120V/60Hz	Phase:	L
Test Mode:	Mode 4		

No.	Frequency (MHz)	Reading (dBuV)	Correct Factor(dB)	Result (dBuV)	Limit (dBuV)	Margin (dB)	Remark
1	0.1580	50.21	10.33	60.54	65.57	-5.03	QP
2	0.1580	29.30	10.33	39.63	55.57	-15.94	AVG
3	0.1980	43.35	10.31	53.66	63.69	-10.03	QP
4	0.1980	20.74	10.31	31.05	53.69	-22.64	AVG
5	0.5540	24.45	10.49	34.94	56.00	-21.06	QP
6	0.5540	13.41	10.49	23.90	46.00	-22.10	AVG
7	2.0300	26.82	10.30	37.12	56.00	-18.88	QP
8	2.0300	19.16	10.30	29.46	46.00	-16.54	AVG
9	4.8020	18.91	10.45	29.36	56.00	-26.64	QP
10	4.8020	5.31	10.45	15.76	46.00	-30.24	AVG
11	21.7300	16.47	12.80	29.27	60.00	-30.73	QP
12	21.7300	10.15	12.80	22.95	50.00	-27.05	AVG

Remark:

1. All readings are Quasi-Peak and Average values
2. Margin = Result (Result = Reading + Factor) – Limit
3. Factor=LISN factor+Cable loss+Limiter (10dB)

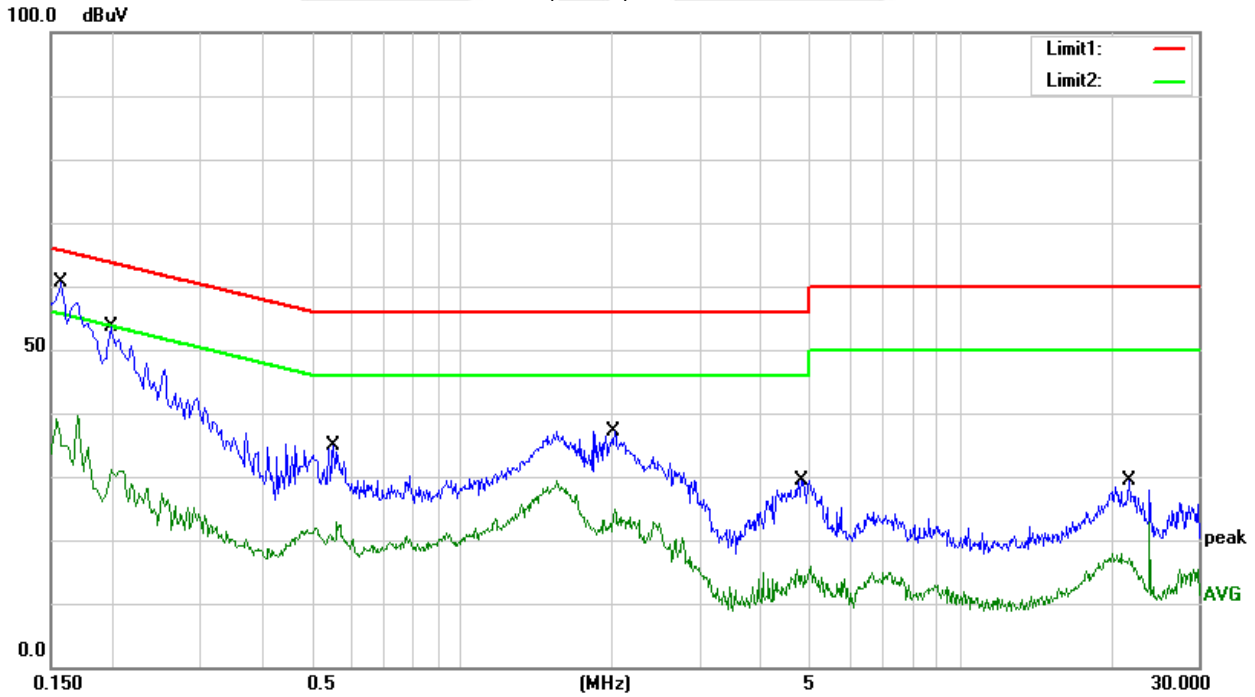



Temperature:	25.6(C)	Relative Humidity:	45%RH
Test Voltage:	AC 120V/60Hz	Phase:	N
Test Mode:	Mode 4		

No.	Frequency (MHz)	Reading (dBuV)	Correct Factor(dB)	Result (dBuV)	Limit (dBuV)	Margin (dB)	Remark
1	0.1540	49.40	10.33	59.73	65.78	-6.05	QP
2	0.1540	28.67	10.33	39.00	55.78	-16.78	AVG
3	0.1780	47.47	10.31	57.78	64.58	-6.80	QP
4	0.1780	27.72	10.31	38.03	54.58	-16.55	AVG
5	0.5620	25.06	10.48	35.54	56.00	-20.46	QP
6	0.5620	15.38	10.48	25.86	46.00	-20.14	AVG
7	2.0500	28.54	10.30	38.84	56.00	-17.16	QP
8	2.0500	20.44	10.30	30.74	46.00	-15.26	AVG
9	4.9700	23.70	10.46	34.16	56.00	-21.84	QP
10	4.9700	13.54	10.46	24.00	46.00	-22.00	AVG
11	21.9380	18.00	12.78	30.78	60.00	-29.22	QP
12	21.9380	9.50	12.78	22.28	50.00	-27.72	AVG

Remark:

1. All readings are Quasi-Peak and Average values
2. Margin = Result (Result =Reading + Factor)–Limit
3. Factor=LISN factor+Cable loss+Limiter (10dB)

100.0 dBuV

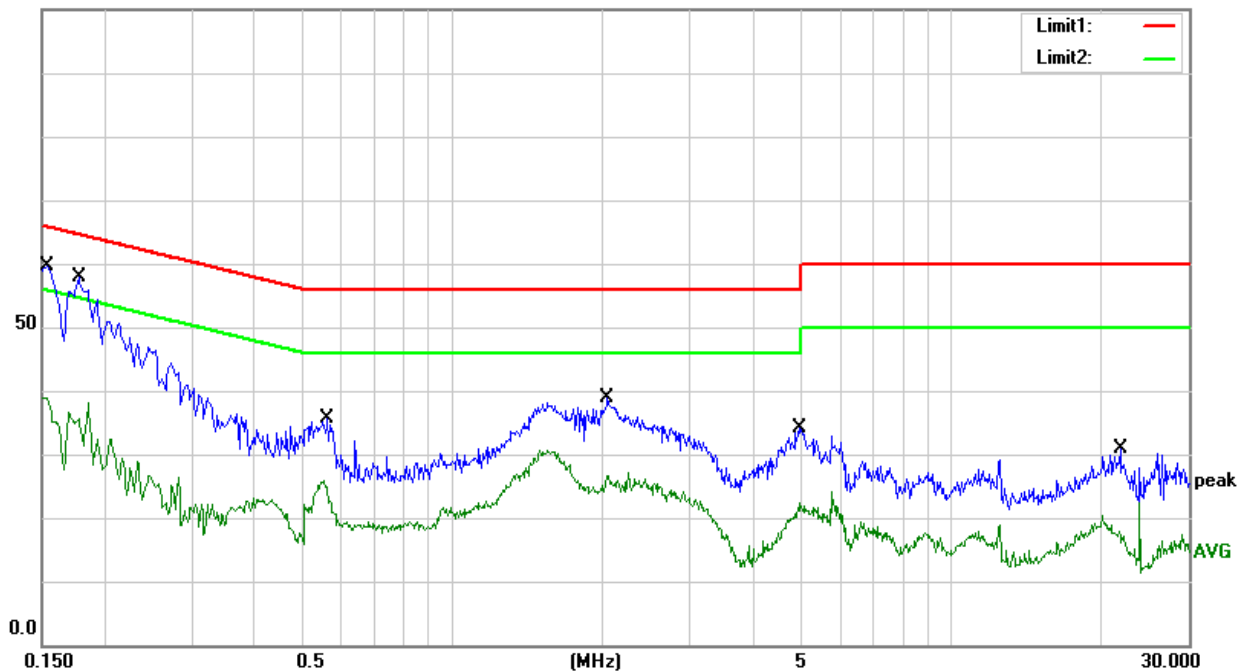



3.2 RADIATED EMISSION MEASUREMENT

3.2.1 RADIATED EMISSION LIMITS

20dBc in any 100 kHz bandwidth outside the operating frequency band. In case the emission fall within the restricted band specified on Part 15.249 and the Part 15.209(a) limit in the table below has to be followed.

Standard FCC 15.209

Frequencies (MHz)	Field Strength (micovolts/meter)	Measurement Distance (meters)
0.009~0.490	2400/F(KHz)	300
0.490~1.705	24000/F(KHz)	30
1.705~30.0	30	30
30~88	100	3
88~216	150	3
216~960	200	3
960~1000	500	3
Above 1000	Other:74.0 dB(μ V)/m (Peak) 54.0 dB(μ V)/m (Average)	3

Standard FCC 15.249

Frequency of Emission (MHz)	Field Strength of fundamental (millivolts /meter)	Field Strength of Harmonics (microvolts/meter)
900~928	50	500
2400~2483.5	50	500
5725~5875	50	500
24000~242500	250	2500

Notes:

- (1) Emissions radiated outside of the specified frequency bands, except for harmonics, shall be attenuated by at least 50 dB below the level of the fundamental or to the general radiated emission limits in Section 15.209, whichever is the lesser attenuation.

LIMITS OF RESTRICTED FREQUENCY BANDS

FREQUENCY (MHz)	FREQUENCY (MHz)	FREQUENCY (MHz)	FREQUENCY (GHz)
0.090-0.110	16.42-16.423	399.9-410	4.5-5.15
0.495-0.505	16.69475-16.69525	608-614	5.35-5.46
2.1735-2.1905	16.80425-16.80475	960-1240	7.25-7.75
4.125-4.128	25.5-25.67	1300-1427	8.025-8.5
4.17725-4.17775	37.5-38.25	1435-1626.5	9.0-9.2
4.20725-4.20775	73-74.6	1645.5-1646.5	9.3-9.5
6.215-6.218	74.8-75.2	1660-1710	10.6-12.7



6.26775-6.26825	108-121.94	1718.8-1722.2	13.25-13.4
6.31175-6.31225	123-138	2200-2300	14.47-14.5
8.291-8.294	149.9-150.05	2310-2390	15.35-16.2
8.362-8.366	156.52475-156.52525	2483.5-2500	17.7-21.4
8.37625-8.38675	156.7-156.9	2690-2900	22.01-23.12
8.41425-8.41475	162.0125-167.17	3260-3267	23.6-24.0
12.29-12.293	167.72-173.2	3332-3339	31.2-31.8
12.51975-12.52025	240-285	3345.8-3358	36.43-36.5
12.57675-12.57725	322-335.4	3600-4400	Above 38.6
13.36-13.41			

Spectrum Parameter	Setting
Detector	Peak/AV
Attenuation	Auto
Start Frequency	1000 MHz
Stop Frequency	10th carrier harmonic
RB (emission in restricted band)	>20BW
VB (emission in restricted band)	=3xRB

Receiver Parameter	Setting
Attenuation	Auto
Start ~ Stop Frequency	9kHz~90kHz / RB 200Hz for PK & AV
	90kHz~110kHz / RB 200Hz for QP
	110kHz~490kHz / RB 200Hz for PK & AV
	490kHz~30MHz / RB 9kHz for QP
	30MHz~1000MHz / RB 120kHz for QP



3.2.2 TEST PROCEDURE

- a. The measuring distance of 3m shall be used for measurements. The EUT was placed on the top of a rotating table 0.8 meter above the ground at a 3 meter semi-anechoic chamber. The table was rotated 360 degrees to determine the position of the highest radiation (Below 1GHz)
- b. The measuring distance of 3m shall be used for measurements. The EUT was placed on the top of a rotating table 1.5 meter above the ground at a 3 meter semi-anechoic chamber. The table was rotated 360 degrees to determine the position of the highest radiation (Above 1GHz)
- c. The height of the test antenna shall vary between 1m to 4m. Both horizontal and vertical polarization of the antenna are set to make the measurement.
- d. The initial step in collecting radiated emission data is a receive peak detector mode. Pre-scanning the measurement frequency range. Significant peaks are then marked and then Quasi Peak detector mode re-measured.
- e. All readings are peak unless otherwise stated QP in column of Note. Peak denoted that the Peak reading compliance with the QP limits and then QP Mode measurement didn't perform (Below 1GHz)
- f. All readings are Peak mode value unless otherwise stated AVG in column of Note. If the Peak mode measured value compliance with the Peak limits and lower than AVG Limits, the EUT shall be deemed to meet Peak & AVG limits and then only Peak mode was measured, but AVG mode didn't perform. (Above 1GHz)
- g. For the actual test configuration, please refer to the related Item –EUT Test Photos.
Note: Both horizontal and vertical antenna polarities were tested and performed pretest to three orthogonal axis. The worst case emissions were reported.

3.2.3 DEVIATION FROM TEST STANDARD

No deviation

3.2.4 TEST SETUP

(A) Radiated Emission Test-Up Frequency Below 30MHz

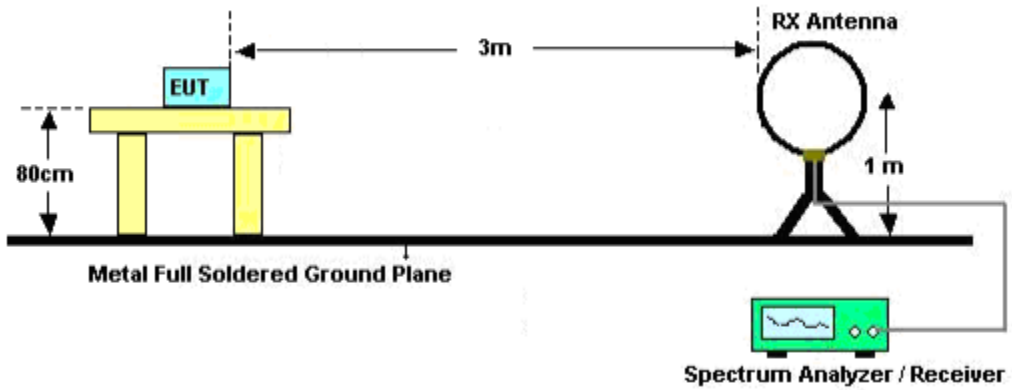

(B) Radiated Emission Test-Up Frequency 30MHz~1GHz

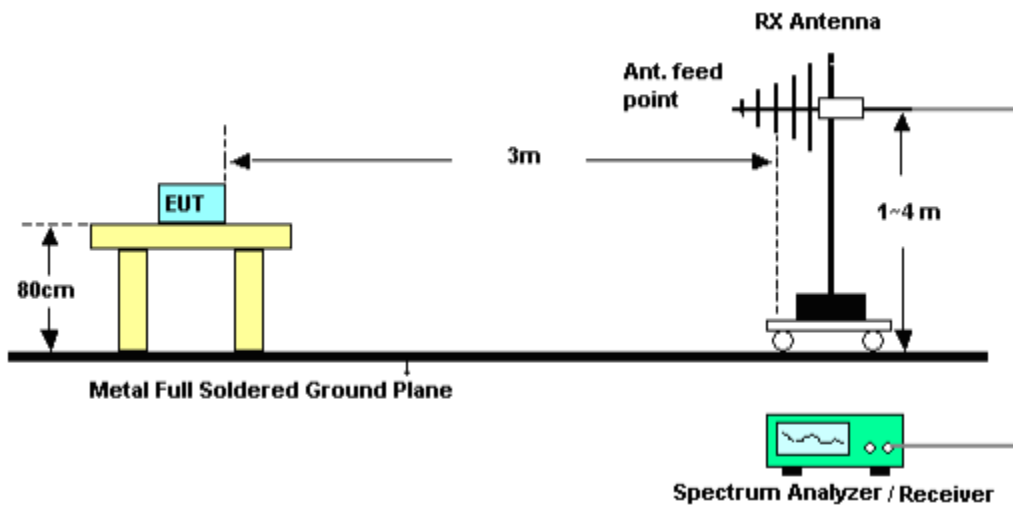

(C) Radiated Emission Test-Up Frequency Above 1GHz

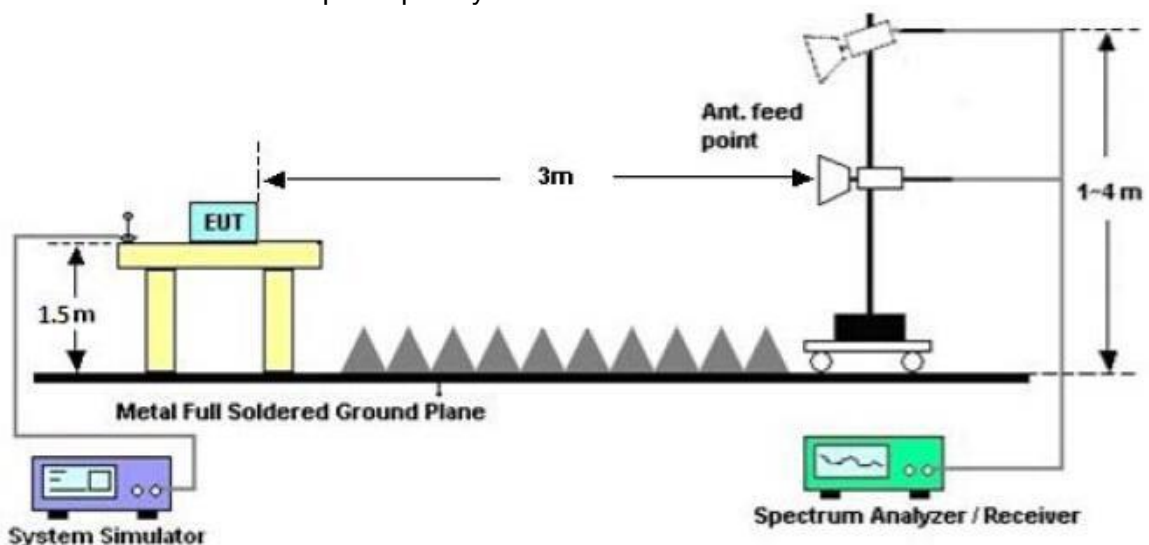



3.2.5 FIELD STRENGTH CALCULATION

The field strength is calculated by adding the Antenna Factor and Cable Factor and subtracting the Amplifier Gain and Duty Cycle Correction Factor (if any) from the measured reading. The basic equation with a sample calculation is as follows:

Margin=PL-PK L or AL- AV L; Margin only shown the worst case.

Where

PR = Peak Reading

AR = Average Reading

PL = Peak Level

AL = Average Level

AF = Antenna Factor

PK L = Peak Limit

AV L = AV Limit

For example

Frequency	PR	AR	AF	PL	AL	PK L	AV L	Margin
(MHz)	(dB μ V/m)	(dB μ V/m)	(dB)	(dB μ V/m)	(dB μ V/m)	(dB μ V/m)	(dB μ V/m)	(dB)
2178	40.23	30.31	9.83	50.06	40.14	74.00	54.00	-13.86





3.2.6 EUT OPERATING CONDITIONS

The EUT tested system was configured as the statements of 2.4 Unless otherwise a special operating condition is specified in the follows during the testing.

Below 30 MHz

Temperature:	23.1(C)	Relative Humidity:	60%RH
Test Voltage:	DC 3.7V	Polarization:	---
Test Mode:	TX Mode		

Freq. (MHz)	Reading (dBuV/m)	Limit (dBuV/m)	Margin (dB)	State P/F
--	--	--	--	PASS
--	--	--	--	PASS

NOTE:

The amplitude of spurious emissions which are attenuated by more than 20dB below the permissible value has no need to be reported.

Distance extrapolation factor = $40 \log(\text{specific distance}/\text{test distance})$ (dB);

Limit line = specific limits(dBuv) + distance extrapolation factor.

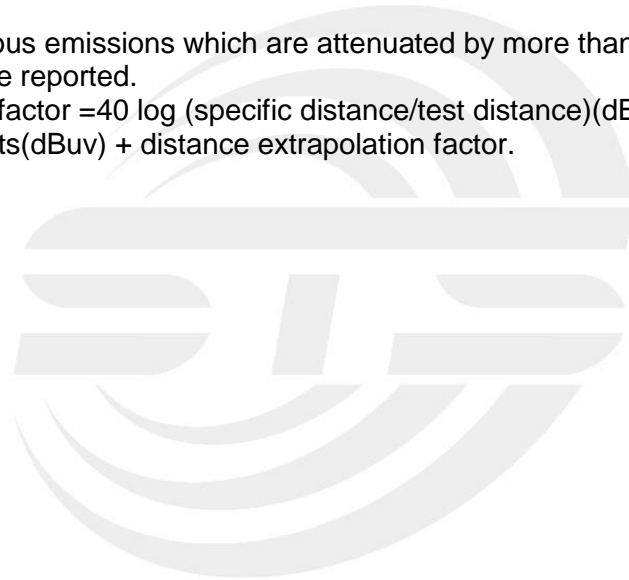



Between 30MHz – 1000 MHz Radiation Spurious

Temperature:	23.1(C)	Relative Humidity:	60%RH
Test Voltage:	DC 3.7V	Phase:	Horizontal
Test Mode:	Mode 1/2/3 (Mode 3 worst mode)		

No.	Frequency (MHz)	Reading (dBuV)	Correct Factor(dB/m)	Result (dBuV/m)	Limit (dBuV/m)	Margin (dB)	Remark
1	94.9900	41.26	-20.78	20.48	43.50	-23.02	peak
2	366.5900	31.75	-12.62	19.13	46.00	-26.87	peak
3	592.6000	29.03	-5.83	23.20	46.00	-22.80	peak
4	760.4100	28.90	-2.18	26.72	46.00	-19.28	peak
5	939.8600	27.96	1.37	29.33	46.00	-16.67	peak
6	995.1500	28.76	2.04	30.80	54.00	-23.20	peak

Remark:

- Margin = Result (Result =Reading + Factor)-Limit
- Factor= Antenna factor+Cable attenuation factor(cable loss)-Amplifier gain

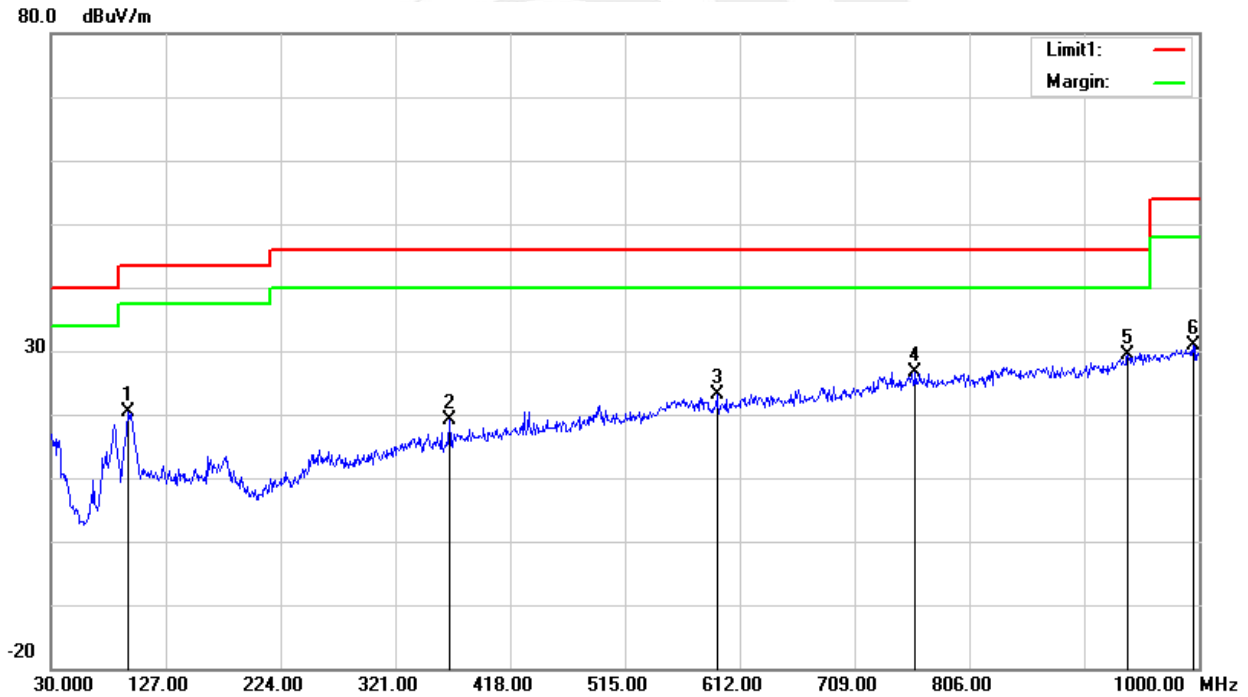



Temperature:	23.1(C)	Relative Humidity:	60%RH
Test Voltage:	DC 3.7V	Phase:	Vertical
Test Mode:	Mode 1/2/3 (Mode 3 worst mode)		

No.	Frequency (MHz)	Reading (dBuV)	Correct Factor(dB/m)	Result (dBuV/m)	Limit (dBuV/m)	Margin (dB)	Remark
1	36.7900	46.46	-16.39	30.07	40.00	-9.93	peak
2	76.5600	44.97	-23.61	21.36	40.00	-18.64	peak
3	399.5700	29.01	-11.16	17.85	46.00	-28.15	peak
4	642.0700	28.09	-4.85	23.24	46.00	-22.76	peak
5	869.0500	32.86	-0.52	32.34	46.00	-13.66	peak
6	975.7500	28.68	2.38	31.06	54.00	-22.94	peak

Remark:

- 1. Margin = Result (Result =Reading + Factor)-Limit
- 2. Factor= Antenna factor+Cable attenuation factor(cable loss)-Amplifier gain

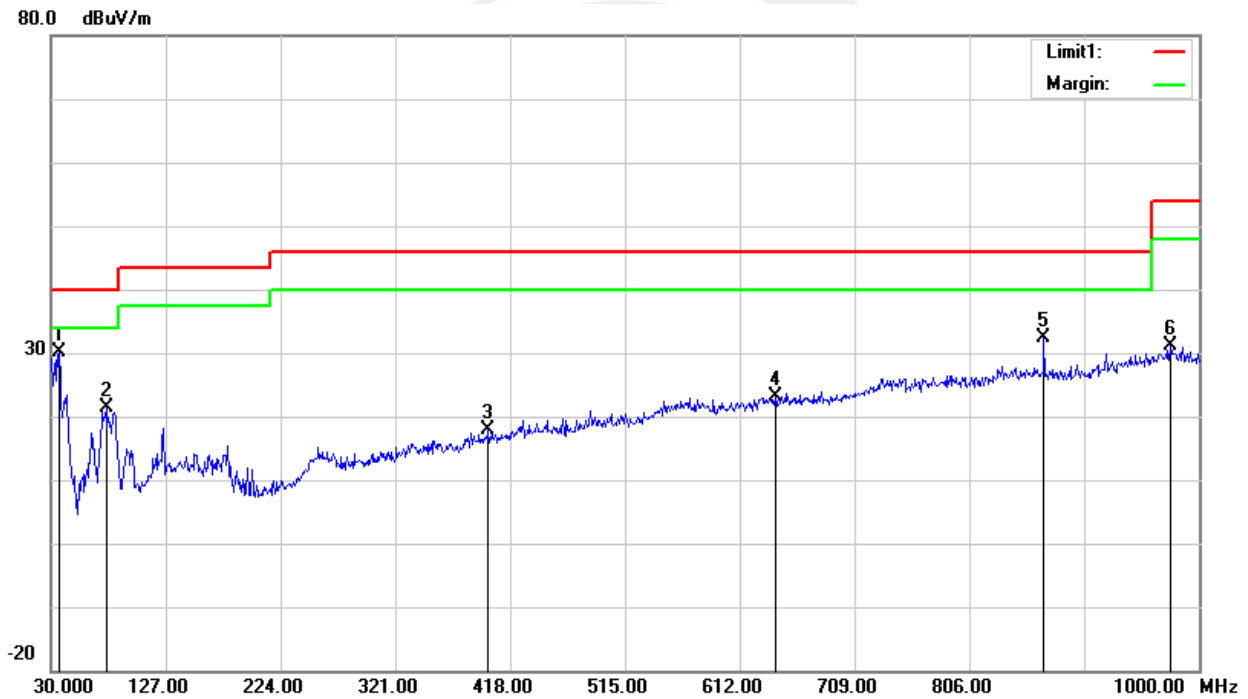



Above 1G Radiation Spurious

Low channel

PK

Frequency (MHz)	Meter Reading (dBµV/m)	Detector (PK/QP/AV)	Amplifier (dB)	Loss (dB)	Antenna Factor (dB/m)	Orrected Factor (dB)	Corrected Amplitude (dBµV/m)	FCC Part 15.249/15.209/205		RX Antenna
								Limit (dBµV/m)	Margin (dB)	Polar (H/V)
4808.04	66.22	PK	50.33	8.84	31.22	-10.27	55.95	74	-18.05	H
4808.04	65.61	PK	50.33	8.84	31.22	-10.27	55.34	74	-18.66	V
7211.92	63.38	PK	55.48	9.31	34.05	-12.12	51.26	74	-22.74	H
7211.92	61.75	PK	55.48	9.31	34.05	-12.12	49.63	74	-24.37	V
9615.89	66.72	PK	59.13	9.89	36.99	-12.25	54.47	74	-19.53	H
9615.89	65.88	PK	59.13	9.89	36.99	-12.25	53.63	74	-20.37	V

AV

Frequency (MHz)	PK Reading (dBµV/m)	Duty cycle factor (dB)	AV Reading (dBµV/m)	Orrected Factor (dB)	Corrected Amplitude (dBµV/m)	FCC Part 15.249/15.209/205		RX Antenna
						Limit (dBµV/m)	Margin (dB)	Polar (H/V)
4808.04	66.22	-3.86	62.36	-10.27	52.09	54.00	-1.91	H
4808.04	65.61	-3.86	61.75	-10.27	51.48	54.00	-2.52	V
7211.92	63.38	-3.86	59.52	-12.12	47.40	54.00	-6.60	H
7211.92	61.75	-3.86	57.89	-12.12	45.77	54.00	-8.23	V
9615.89	66.72	-3.86	62.86	-12.25	50.61	54.00	-3.39	H
9615.89	65.88	-3.86	62.02	-12.25	49.77	54.00	-4.23	V

AV = Peak +20Log10(duty cycle factor) =PK+(-3.86)



Mid channel

PK

Frequency (MHz)	Meter Reading (dBµV/m)	Detector (PK/QP/AV)	Amplifier (dB)	Loss (dB)	Antenna Factor (dB/m)	Orrected Factor (dB)	Corrected Amplitude (dBµV/m)	FCC Part 15.249/15.209/205		RX Antenna
								Limit (dBµV/m)	Margin (dB)	Polar (H/V)
4884.12	65.15	PK	50.33	8.84	31.22	-10.27	54.88	74	-19.12	H
4884.12	64.32	PK	50.33	8.84	31.22	-10.27	54.05	74	-19.95	V
7325.93	62.36	PK	55.48	9.31	34.05	-12.12	50.24	74	-23.76	H
7325.93	60.45	PK	55.48	9.31	34.05	-12.12	48.33	74	-25.67	V
9768.15	65.37	PK	59.13	9.89	36.99	-12.25	53.12	74	-20.88	H
9768.15	64.56	PK	59.13	9.89	36.99	-12.25	52.31	74	-21.69	V

AV

Frequency (MHz)	PK Reading (dBµV/m)	Duty cycle factor (dB)	AV Reading (dBµV/m)	Orrected Factor (dB)	Corrected Amplitude (dBµV/m)	FCC Part 15.249/15.209/205		RX Antenna
						Limit (dBµV/m)	Margin (dB)	Polar (H/V)
4884.12	65.15	-3.86	61.29	-10.27	51.02	54.00	-2.98	H
4884.12	64.32	-3.86	60.46	-10.27	50.19	54.00	-3.81	V
7325.93	62.36	-3.86	58.50	-12.12	46.38	54.00	-7.62	H
7325.93	60.45	-3.86	56.59	-12.12	44.47	54.00	-9.53	V
9768.15	65.37	-3.86	61.51	-12.25	49.26	54.00	-4.74	H
9768.15	64.56	-3.86	60.70	-12.25	48.45	54.00	-5.55	V

AV = Peak +20Log10(duty cycle factor) =PK+(-3.86)



High channel

PK

Frequency (MHz)	Meter Reading (dBµV/m)	Detector (PK/QP/AV)	Amplifier (dB)	Loss (dB)	Antenna Factor (dB/m)	Orrected Factor (dB)	Corrected Amplitude (dBµV/m)	FCC Part 15.249/15.209/205		RX Antenna
								Limit (dBµV/m)	Margin (dB)	Polar (H/V)
4960.09	65.05	PK	50.33	8.84	31.22	-10.27	54.78	74	-19.22	H
4960.09	64.13	PK	50.33	8.84	31.22	-10.27	53.86	74	-20.14	V
7439.98	62.01	PK	55.48	9.31	34.05	-12.12	49.89	74	-24.11	H
7439.98	60.28	PK	55.48	9.31	34.05	-12.12	48.16	74	-25.84	V
9920.07	65.37	PK	59.13	9.89	36.99	-12.25	53.12	74	-20.88	H
9920.07	64.77	PK	59.13	9.89	36.99	-12.25	52.52	74	-21.48	V

AV

Frequency (MHz)	PK Reading (dBµV/m)	Duty cycle factor (dB)	AV Reading (dBµV/m)	Orrected Factor (dB)	Corrected Amplitude (dBµV/m)	FCC Part 15.249/15.209/205		RX Antenna
						Limit (dBµV/m)	Margin (dB)	Polar (H/V)
4960.09	65.05	-3.86	61.19	-10.27	50.92	54.00	-3.08	H
4960.09	64.13	-3.86	60.27	-10.27	50.00	54.00	-4.00	V
7439.98	62.01	-3.86	58.15	-12.12	46.03	54.00	-7.97	H
7439.98	60.28	-3.86	56.42	-12.12	44.30	54.00	-9.70	V
9920.07	65.37	-3.86	61.51	-12.25	49.26	54.00	-4.74	H
9920.07	64.77	-3.86	60.91	-12.25	48.66	54.00	-5.34	V

AV = Peak +20Log10(duty cycle factor) =PK+(-3.86)



Duty cycle

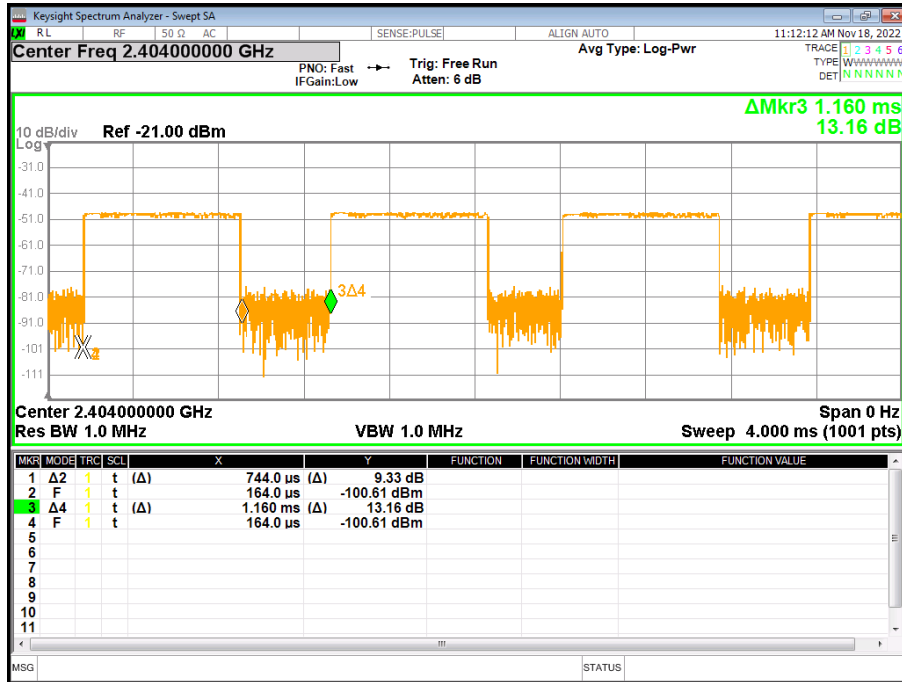

Ton (μ s)	Tp (μ s)	Duty Factor
744	1160	3.86

Note: Duty Factor=20*LOG10(1/(Ton/Tp))



(Radiation Band edge)

Low channel
Horizontal

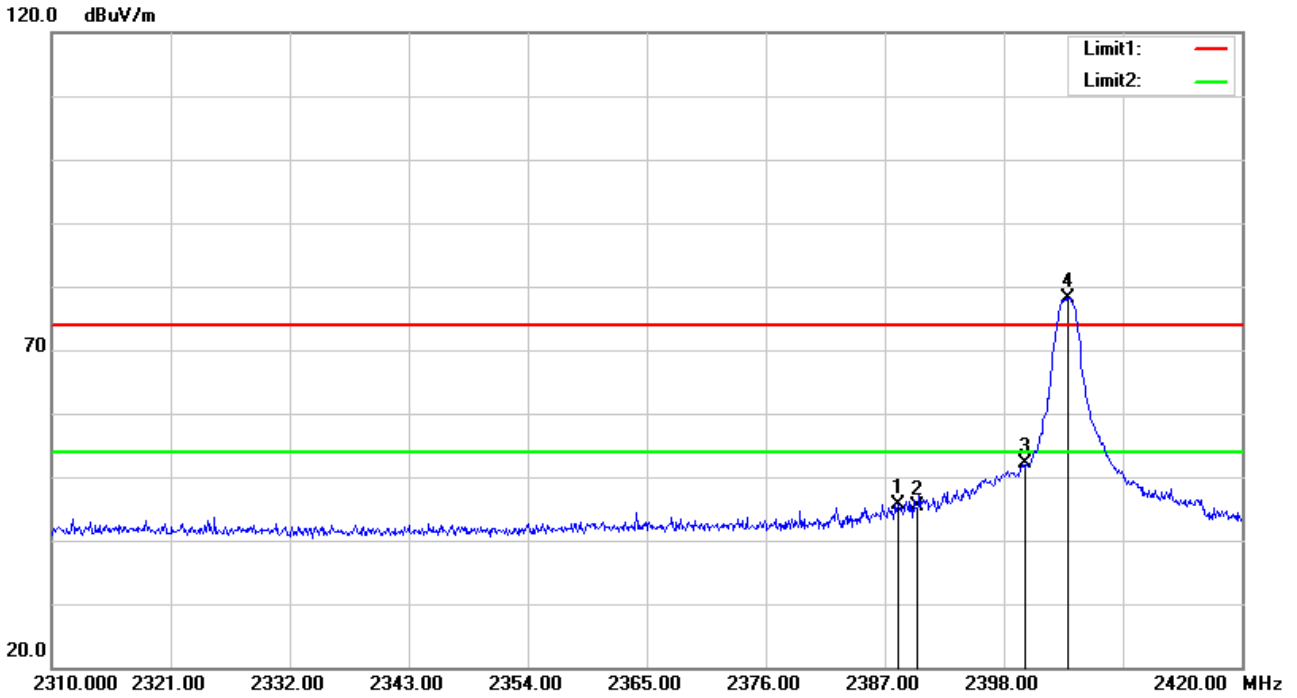

No.	Frequency (MHz)	Reading (dBuV)	Correct Factor(dB/m)	Result (dBuV/m)	Limit (dBuV/m)	Margin (dB)	Remark
1	2388.210	41.44	4.31	45.75	74.00	-28.25	peak
2	2390.000	40.97	4.34	45.31	74.00	-28.69	peak
3	2400.000	47.66	4.49	52.15	74.00	-21.85	peak

Fundamental Frequency

No.	Frequency (MHz)	Reading (dBuV)	Correct Factor(dB/m)	Duty cycle Factor(dB/m)	Result (dBuV/m)	Limit (dBuV/m)	Margin (dB)	Remark
4	2404.000	73.65	4.49	-	78.14	114	-35.86	peak
5	2404.000	73.65	4.49	3.86	74.28	94	-19.72	AV



Vertical

120.0 dBuV/m

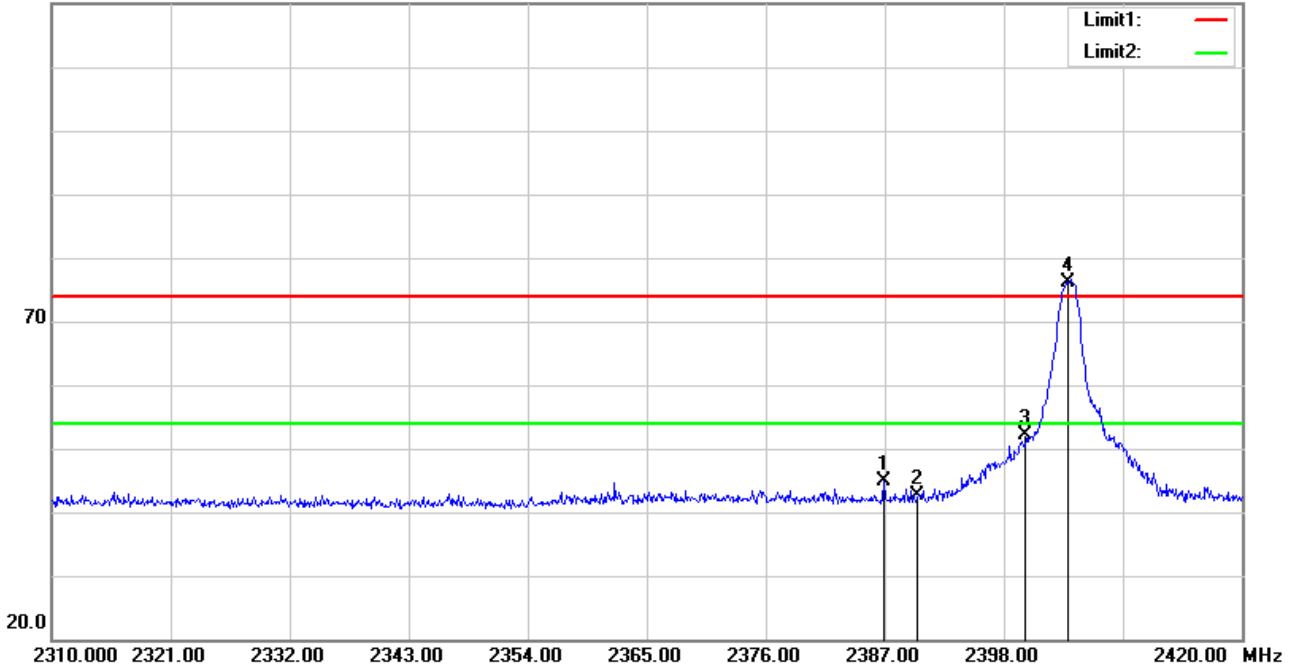

No.	Frequency (MHz)	Reading (dBuV)	Correct Factor(dB/m)	Result (dBuV/m)	Limit (dBuV/m)	Margin (dB)	Remark
1	2386.890	40.47	4.30	44.77	74.00	-29.23	peak
2	2390.000	38.40	4.34	42.74	74.00	-31.26	peak
3	2400.000	47.61	4.49	52.10	74.00	-21.90	peak

Fundamental Frequency

No.	Frequency (MHz)	Reading (dBuV)	Correct Factor(dB/m)	Duty cycle Factor(dB/m)	Result (dBuV/m)	Limit (dBuV/m)	Margin (dB)	Remark
4	2404.000	71.71	4.49	-	76.20	114	-37.8	peak
5	2404.000	71.71	4.49	3.86	72.34	94	-21.66	AV



Mid channel
Horizontal

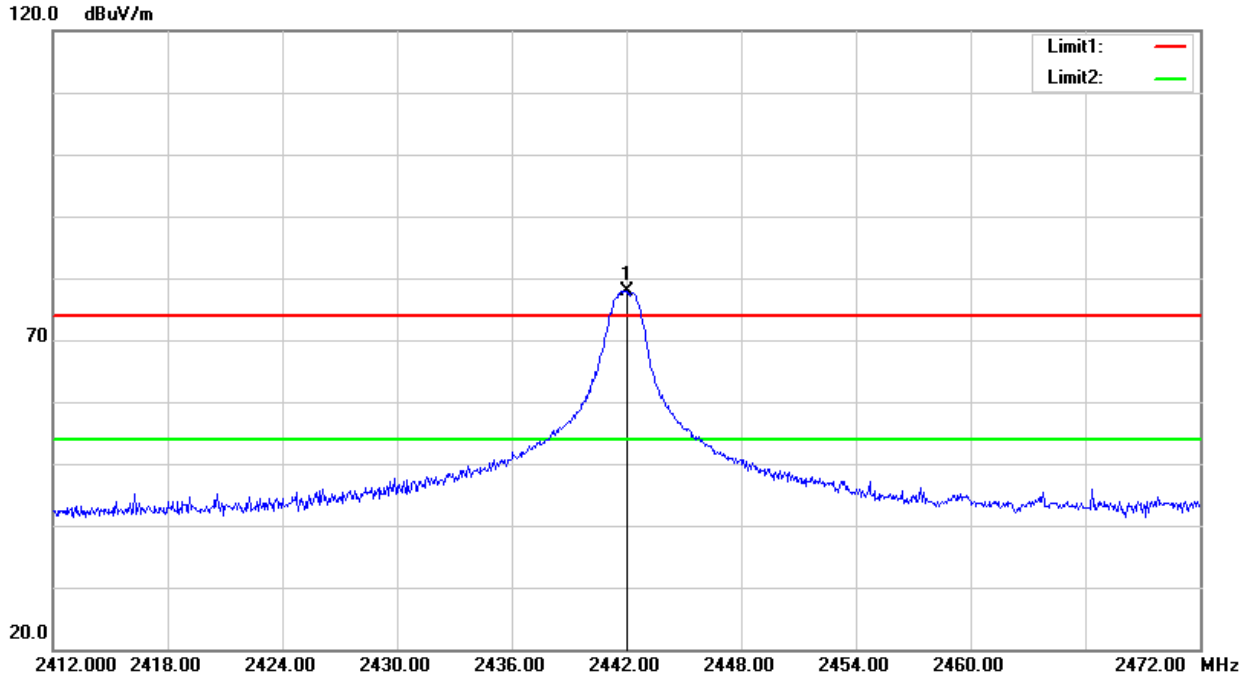

No.	Frequency (MHz)	Reading (dBuV)	Correct Factor(dB/m)	Duty cycle Factor(dB/m)	Result (dBuV/m)	Limit (dBuV/m)	Margin (dB)	Remark
1	2442.000	73.30	4.51	-	77.81	114	-36.19	peak
2	2442.000	73.30	4.51	3.86	73.95	94	-20.05	AV

Vertical

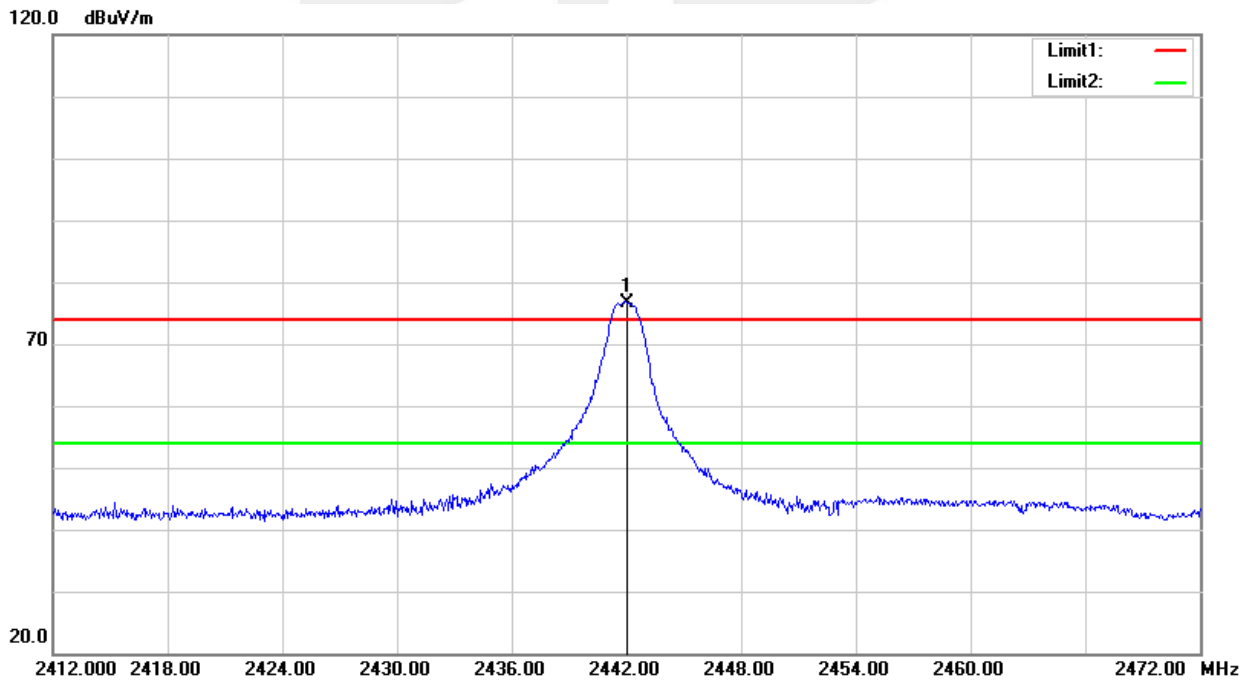

No.	Frequency (MHz)	Reading (dBuV)	Correct Factor(dB/m)	Duty cycle Factor(dB/m)	Result (dBuV/m)	Limit (dBuV/m)	Margin (dB)	Remark
1	2442.000	72.23	4.51	-	76.74	114	-37.26	peak
2	2442.000	72.23	4.51	3.86	72.88	94	-21.12	AV



High channel
Horizontal

120.0 dBuV/m

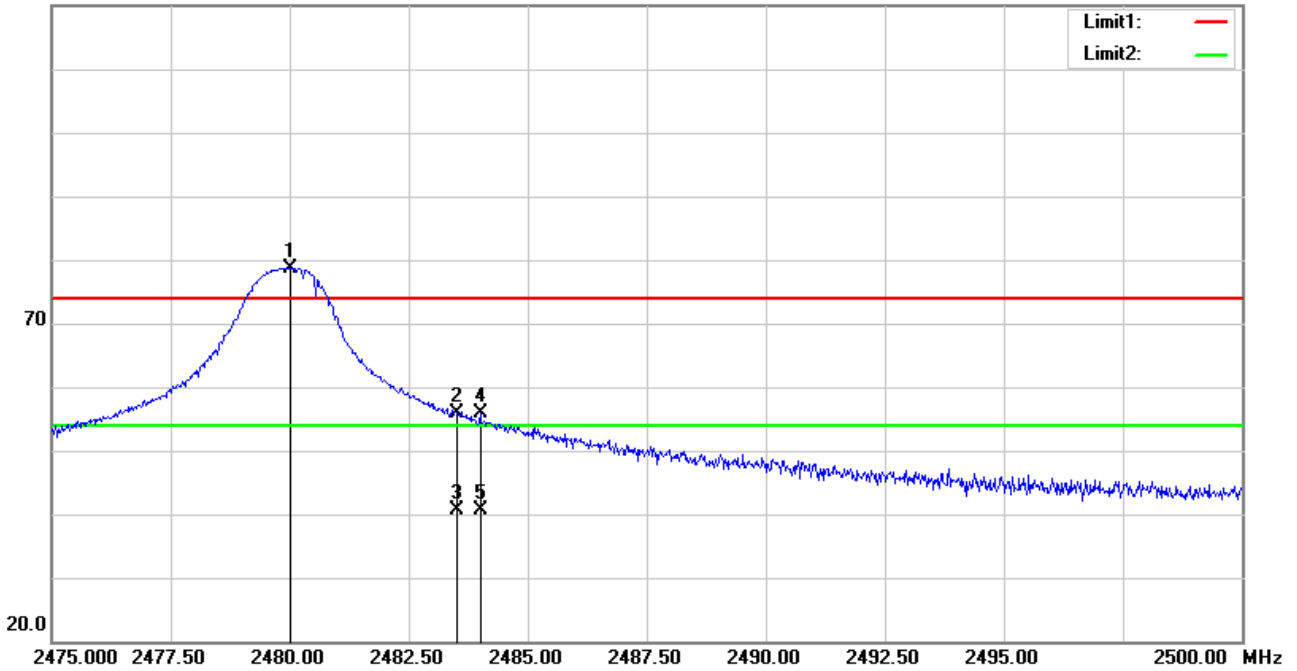

No.	Frequency (MHz)	Reading (dBuV)	Correct Factor(dB/m)	Result (dBuV/m)	Limit (dBuV/m)	Margin (dB)	Remark
2	2483.500	51.34	4.60	55.94	74.00	-18.06	peak
3	2483.500	35.98	4.60	40.58	54.00	-13.42	AVG
4	2484.000	51.18	4.61	55.79	74.00	-18.21	peak
5	2484.000	35.98	4.61	40.59	54.00	-13.41	AVG

Fundamental Frequency

No.	Frequency (MHz)	Reading (dBuV)	Correct Factor(dB/m)	Duty cycle Factor(dB/m)	Result (dBuV/m)	Limit (dBuV/m)	Margin (dB)	Remark
1	2480.000	73.97	4.60	-	78.57	114	-35.43	peak
6	2480.000	73.97	4.60	3.86	74.71	94	-19.29	AV



Vertical

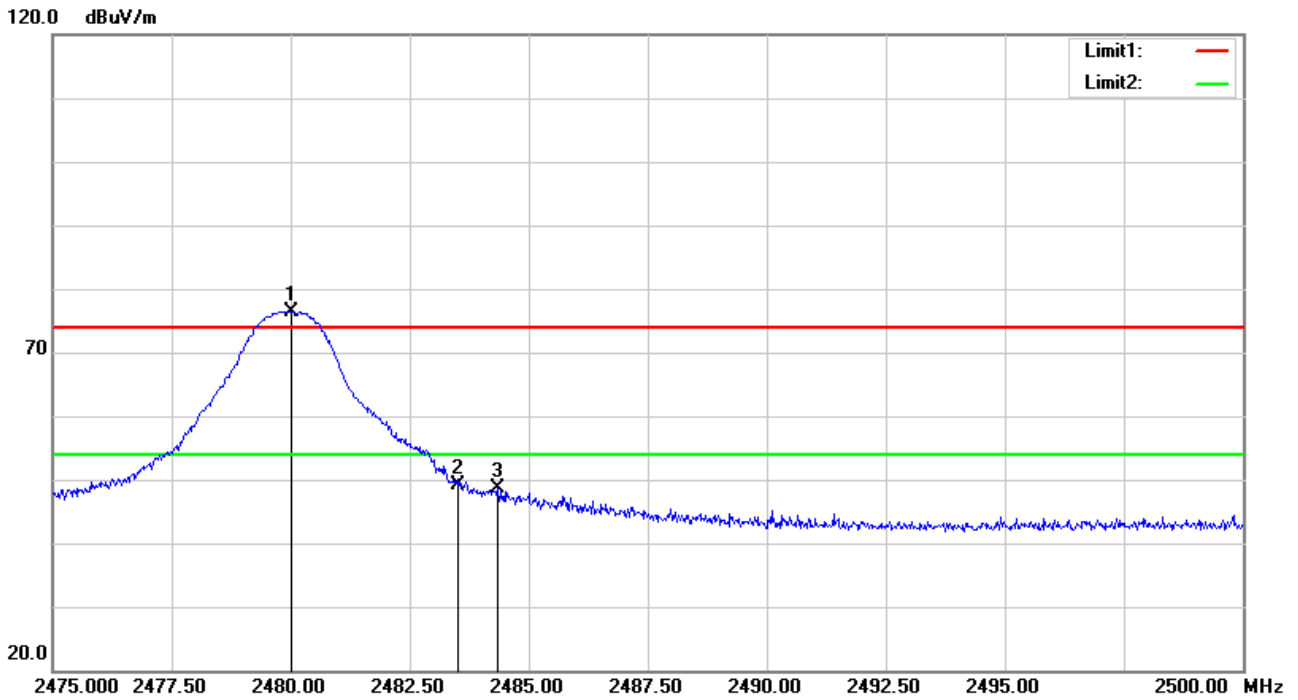

No.	Frequency (MHz)	Reading (dBuV)	Correct Factor(dB/m)	Result (dBuV/m)	Limit (dBuV/m)	Margin (dB)	Remark
2	2483.500	44.64	4.60	49.24	74.00	-24.76	peak
3	2484.350	44.13	4.61	48.74	74.00	-25.26	peak

Fundamental Frequency

No.	Frequency (MHz)	Reading (dBuV)	Correct Factor(dB/m)	Duty cycle Factor(dB/m)	Result (dBuV/m)	Limit (dBuV/m)	Margin (dB)	Remark
1	2480.000	71.81	4.60	-	76.41	114	-37.59	peak
4	2480.000	71.81	4.60	3.86	72.55	94	-21.45	AV

4. BANDWIDTH TEST

4.1 TEST PROCEDURE

- a. The EUT was directly connected to the spectrum analyzer and antenna output port as show in the block diagram below.
- b. Spectrum Setting : RBW= 1% to 5% OBW, VBW \geq RBW, Sweep time = Auto.

4.2 TEST SETUP



4.3 EUT OPERATION CONDITIONS

TX mode.





4.4 TEST RESULTS

Temperature:	25 °C	Relative Humidity:	50%
Test Voltage:	DC 5V		

Test Channel	Frequency(MHz)	20 dB Bandwidth(KHz)	99% Bandwidth(KHz)
CH01	2404	567.5	676.21
CH39	2442	589.3	766.20
CH77	2480	583.4	685.23

Low Channel

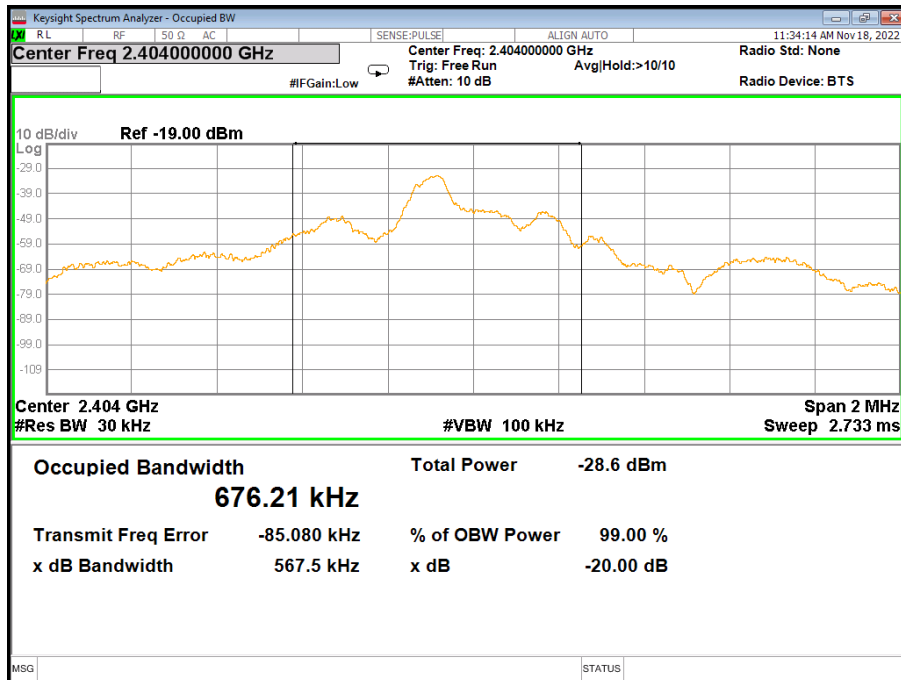



Mid Channel

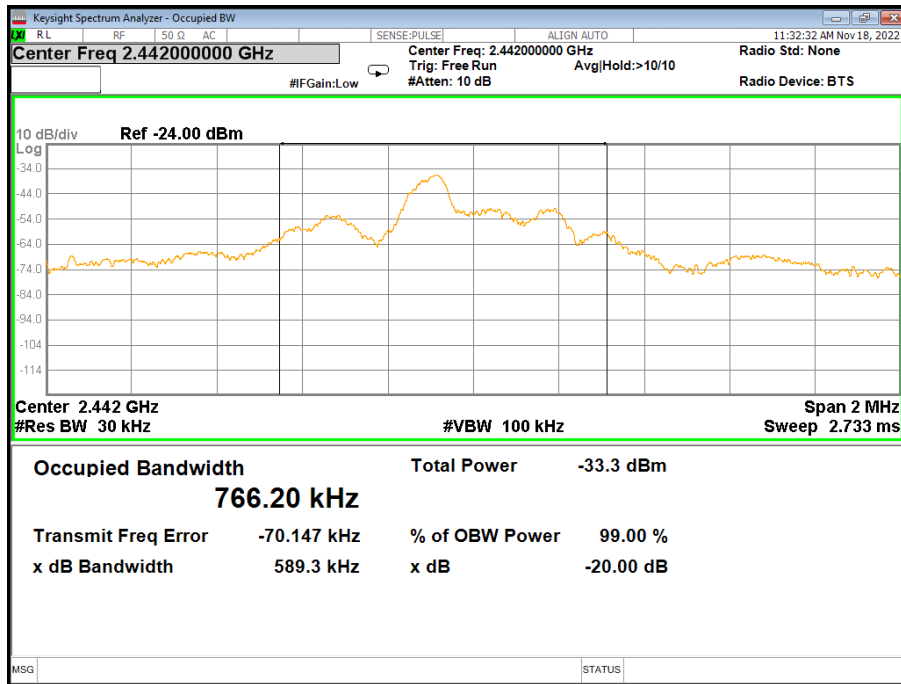

High Channel

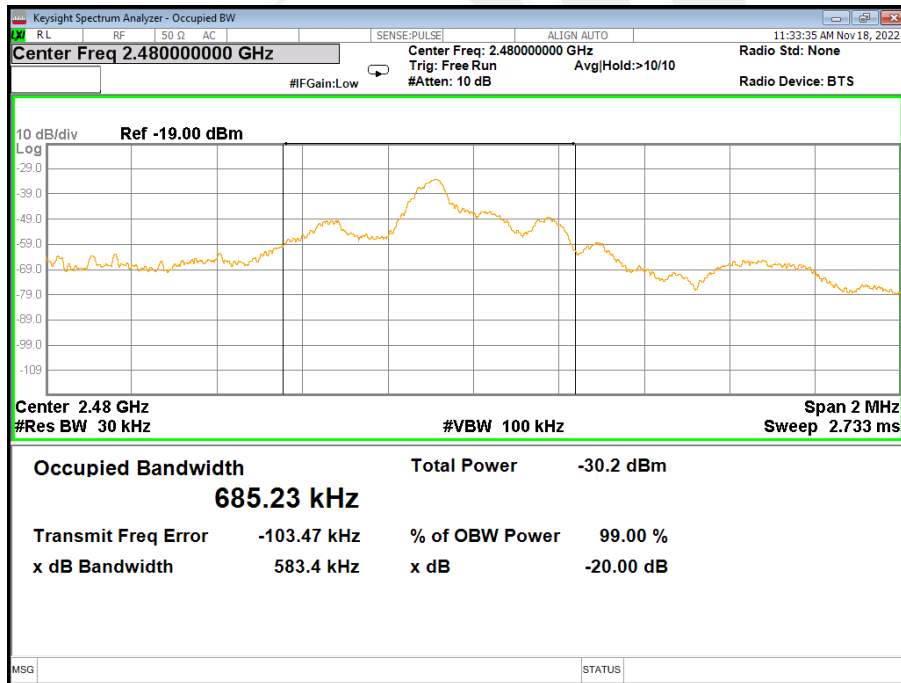



5. ANTENNA REQUIREMENT

5.1 STANDARD REQUIREMENT

According to the FCC Part 15 Paragraph 15.203, an intentional radiator shall be designed to ensure that no antenna other than that furnished by the responsible party shall be used with the device.

5.2 EUT ANTENNA

The EUT antenna is Monopole Antenna. It conforms to the standard requirements.





APPENDIX- PHOTOS OF TEST SETUP

Note: See test photos in setup photo document for the actual connections between Product and support equipment.

*****END OF THE REPORT*****

