

Test Point

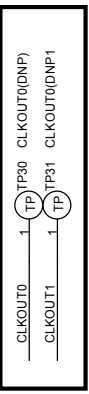

Holux Technology, Inc.

Nav-55

Document Number

Date: _____ Sheet _____ of _____

Rev

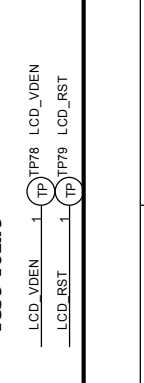
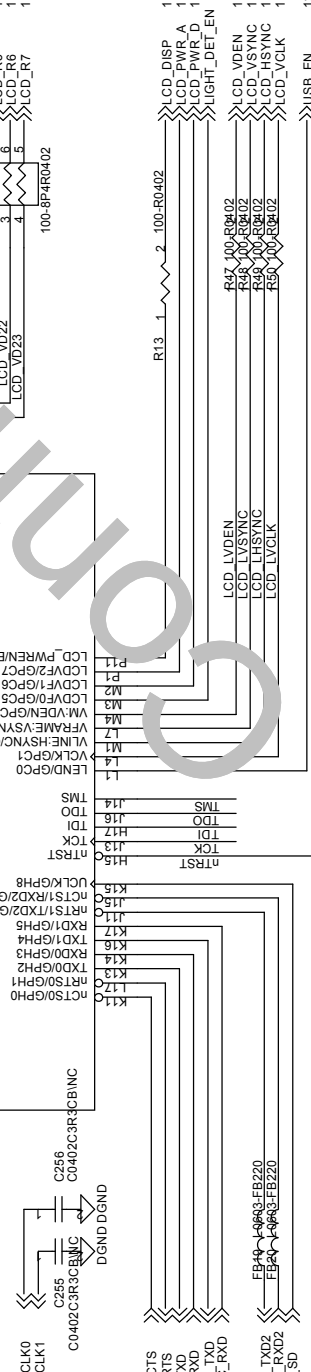
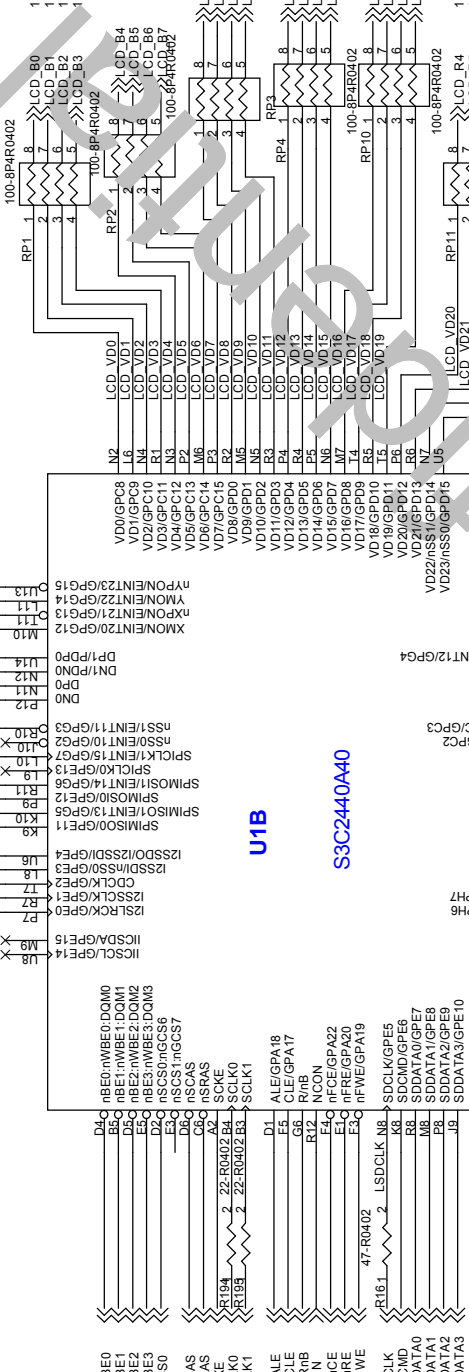
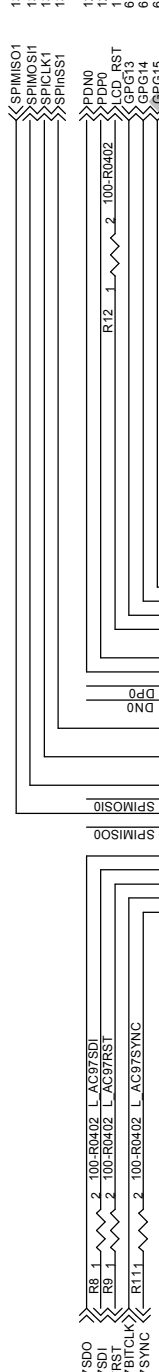
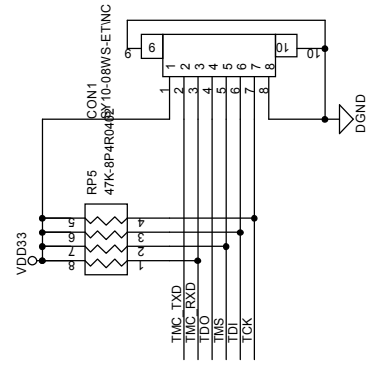
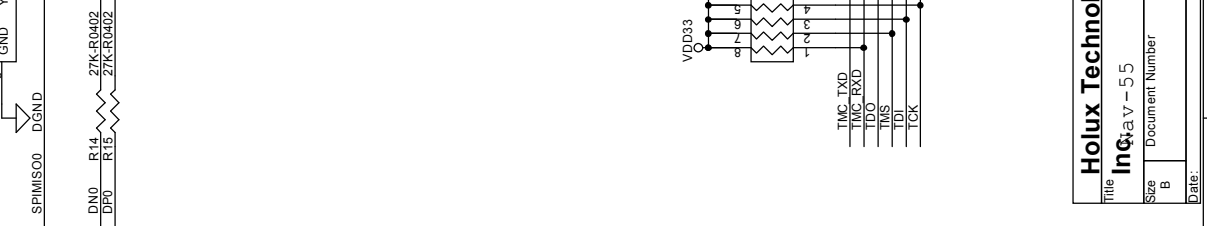

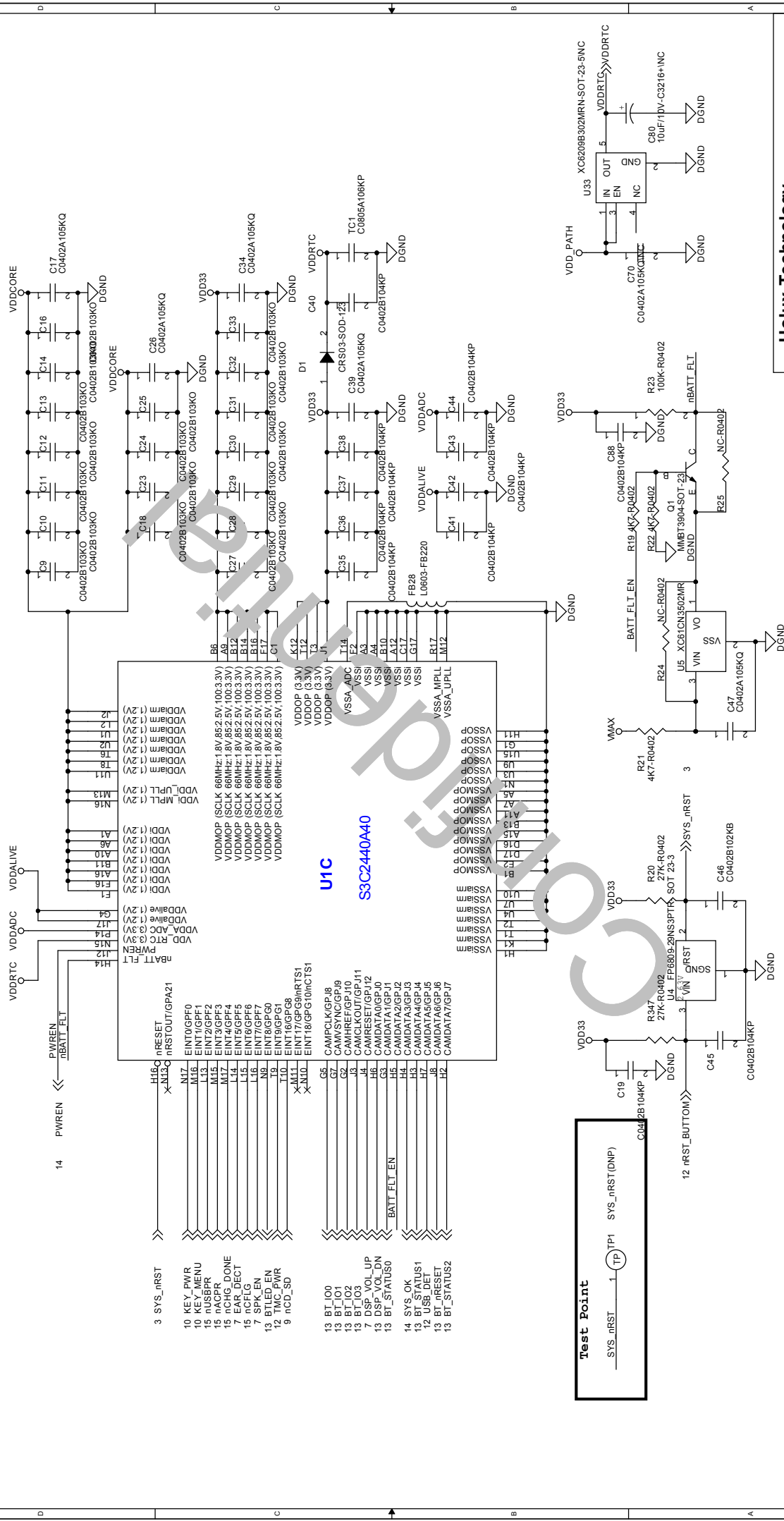

Holux Technology.

Infoc V - 55

Document Number

Rev

Date:

Sheet

of

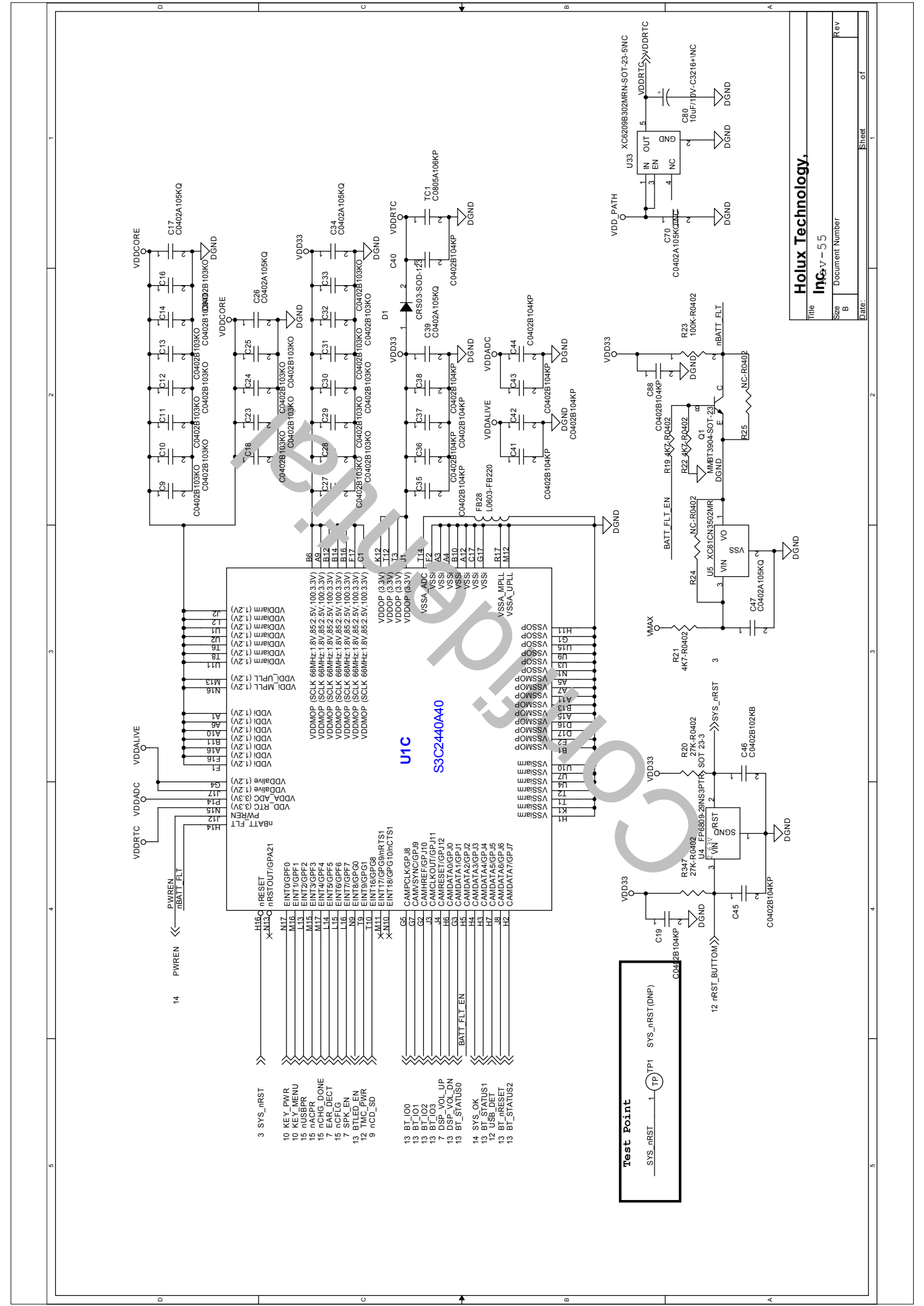

U1C

S3C2440A40

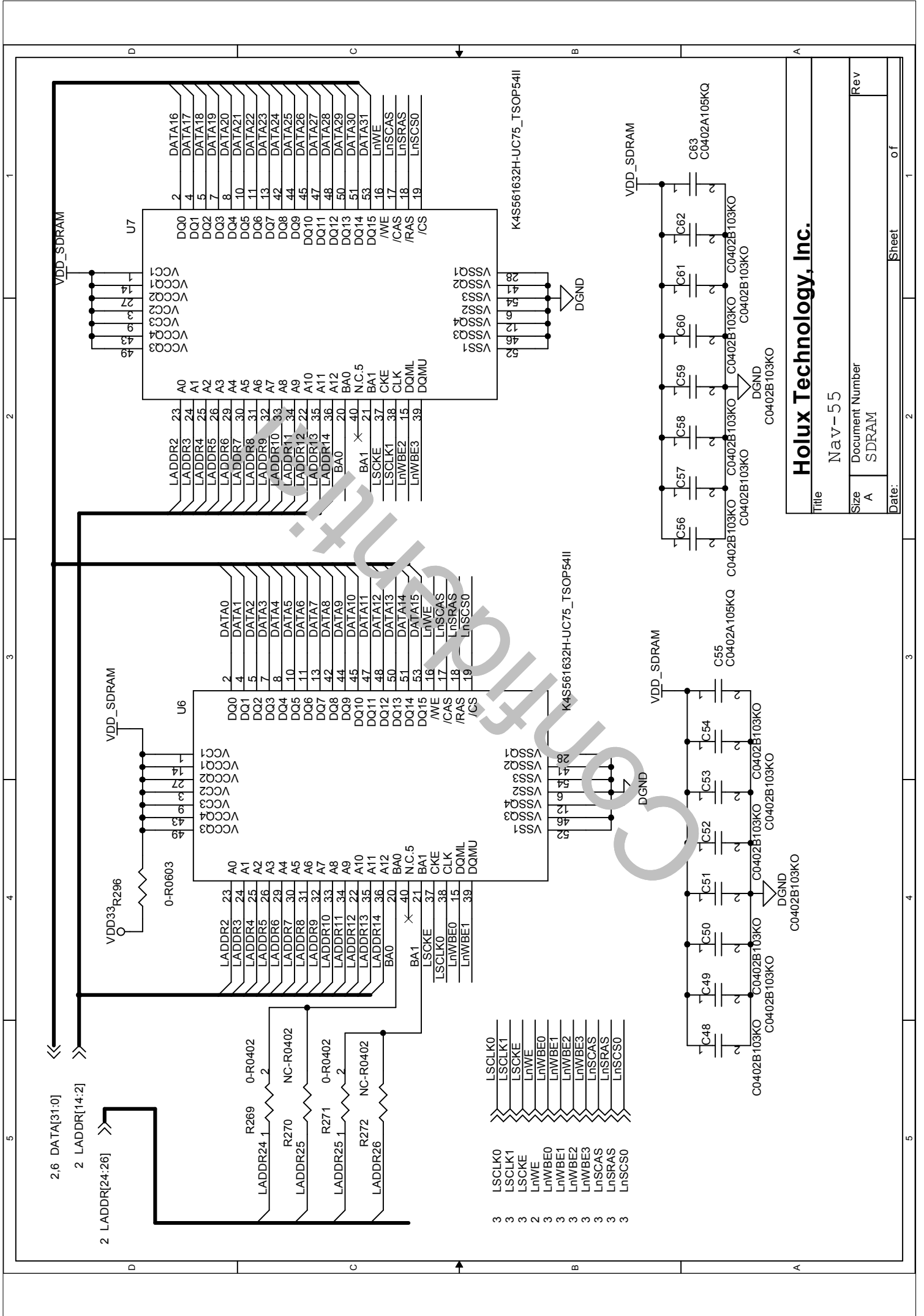

Holux Technology, Inc.

Nav-55

Document Number
A SDRAM

Date: _____ Sheet _____ of _____

OK

nCD_SD TP27 nCD_SD
 SD_CLK TP28 SDCLK
 VDDSD TP29 VDDSD

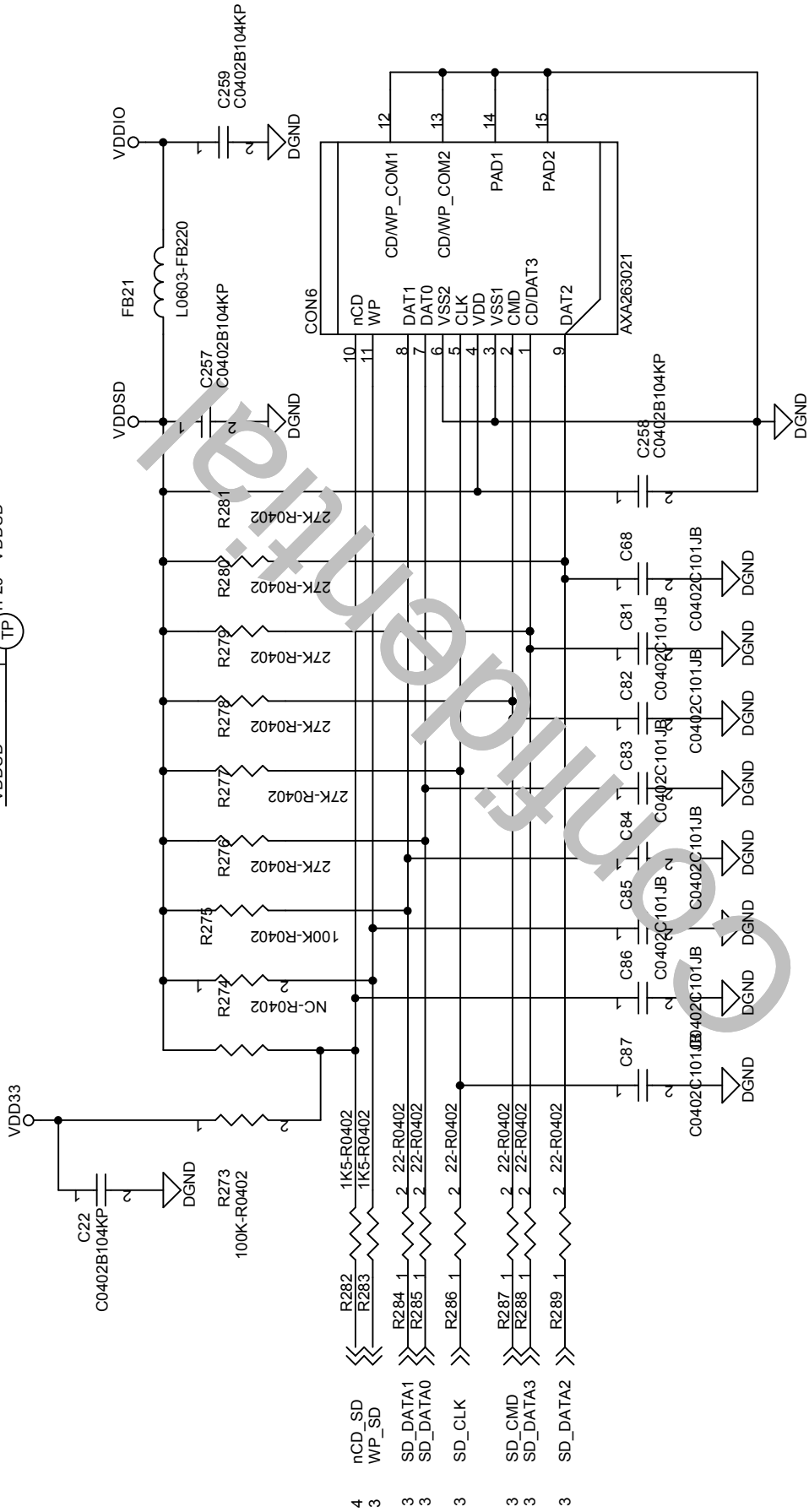

Holux Technology, Inc.

Title Nav-55

Size Document Number
 A SDCARD

Date: Sheet of

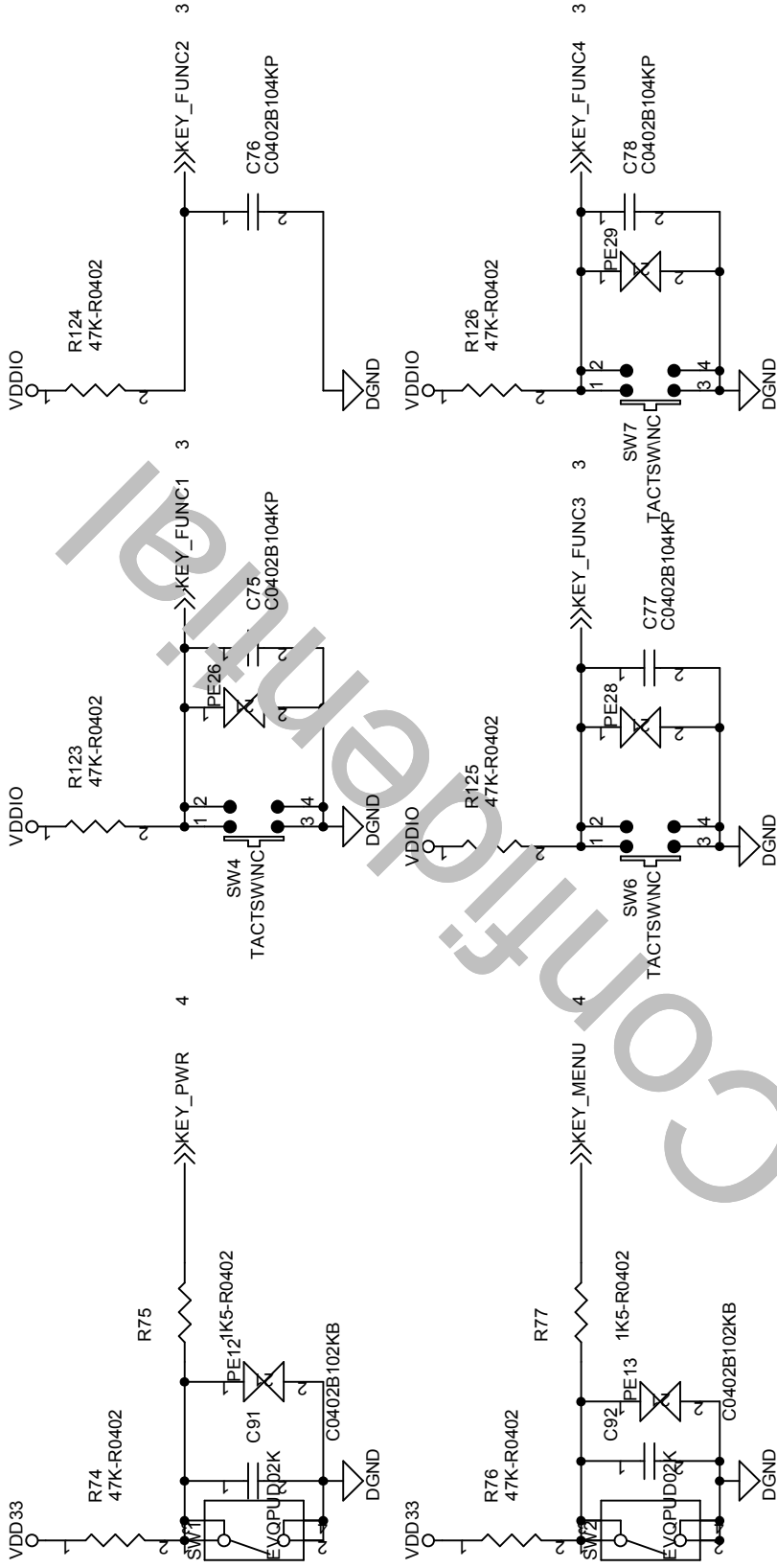

Holux Technology, Inc.

Title Nav-55

Size A
Document Number
Keypad

Date: Sheet 1 of 1

Test Point

VDDLCD25	1	TP4	VDDLCD25(DNP)
VDDLCD50	1	TP5	VDDLCD50(DNP)
VBL+	1	TP6	VBL+(DNP)

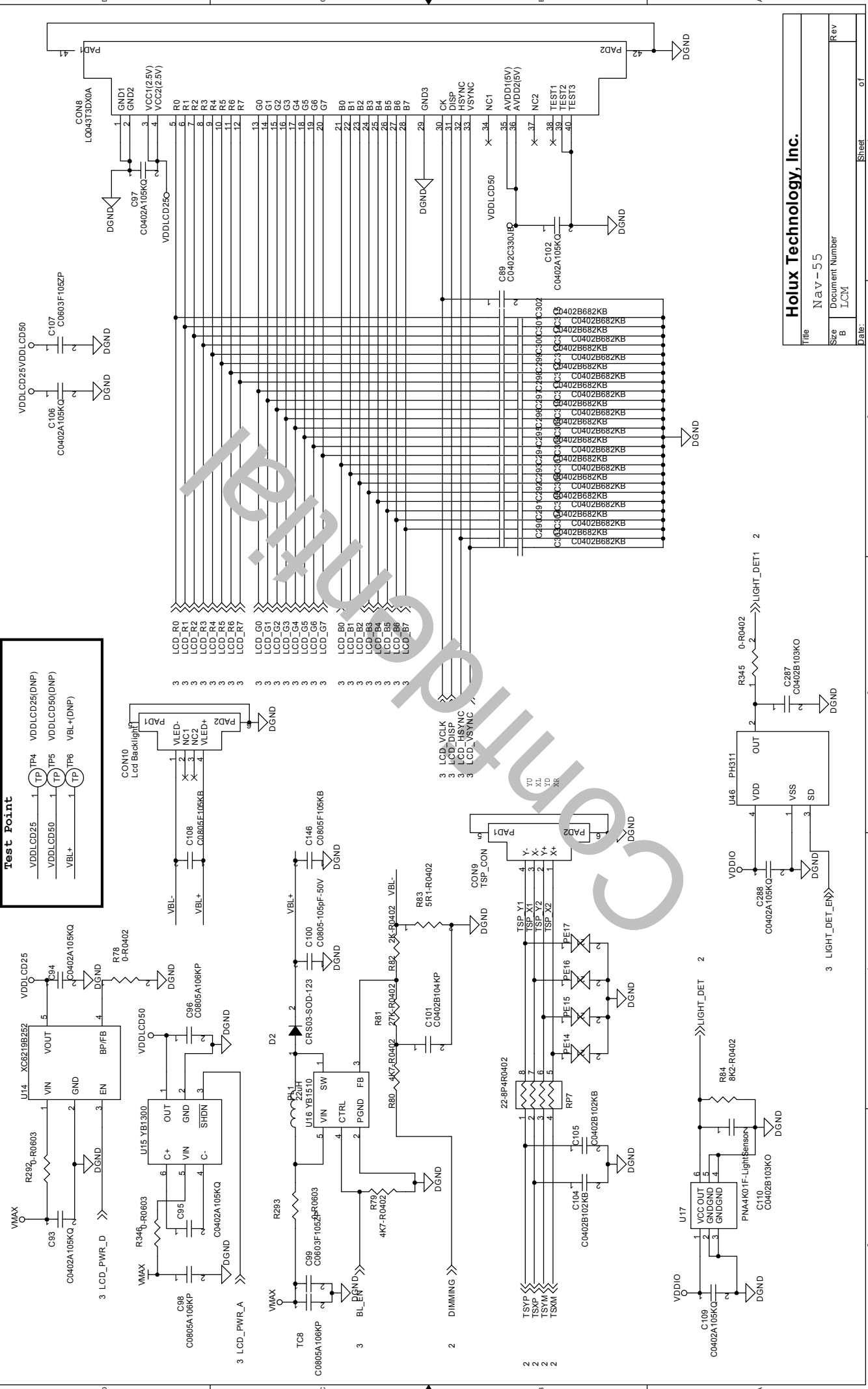

Holux Technology, Inc.
 Title: Nav-55
 Size: B
 Document Number: LCM
 Date: _____
 Sheet 1 of 1

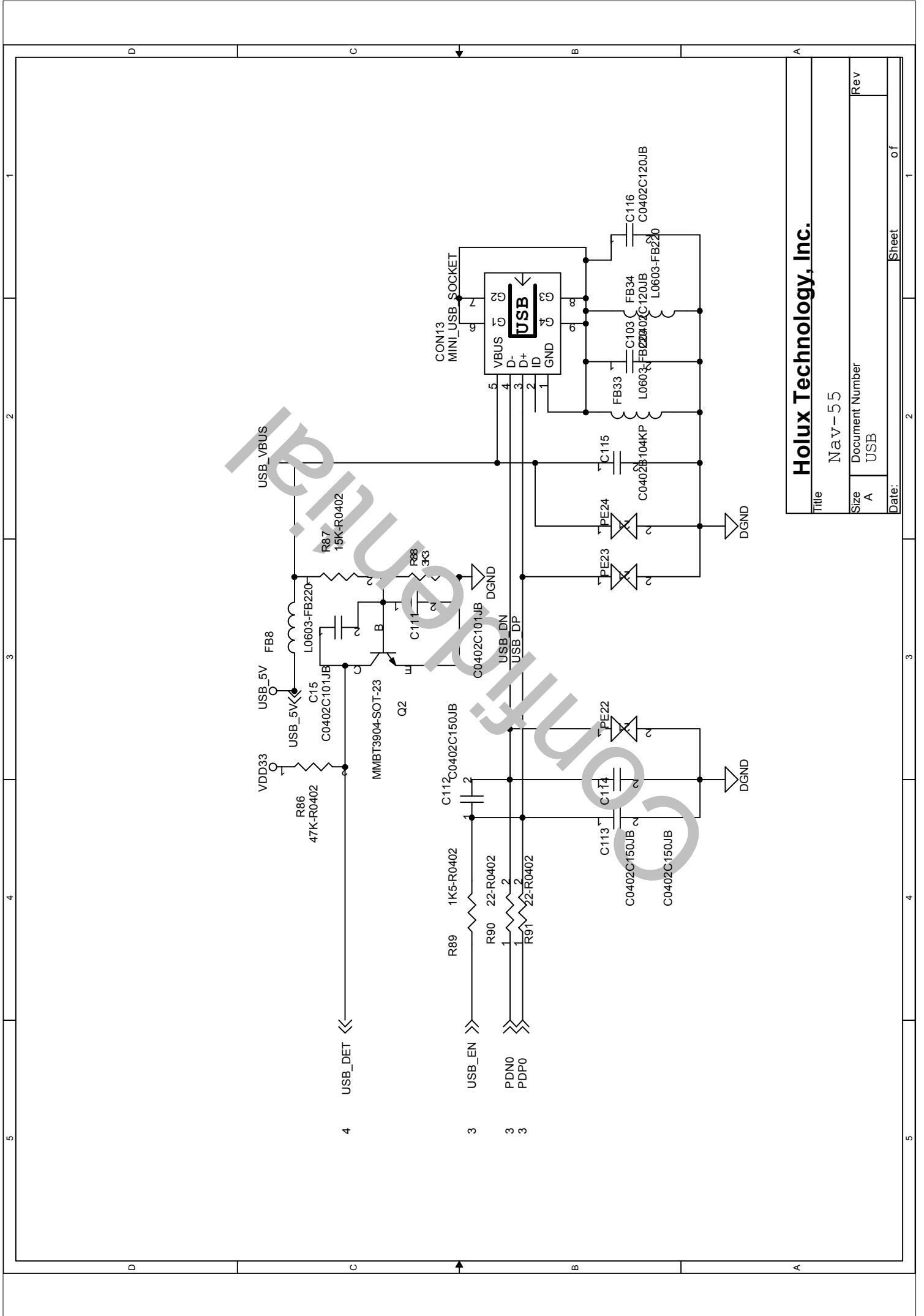

Holux Technology, Inc.

Title Nav-55

Size Document Number

A USB

Rev

Date: Sheet of

1

2

3

4

5

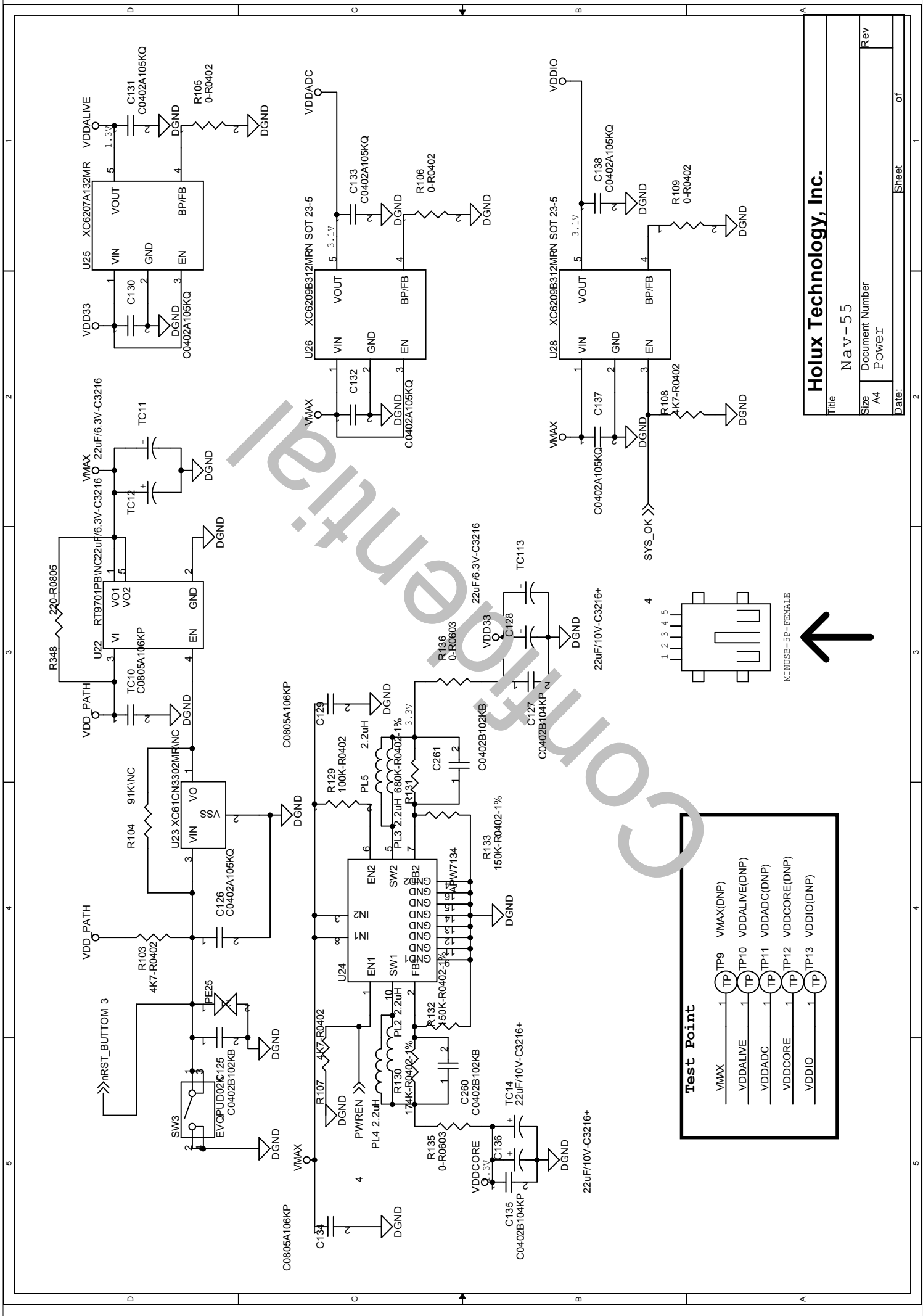

Test Point

VMAX	TP9	VMAX(DNP)
VDDALIVE	TP10	VDDALIVE(DNP)
VDDADC	TP11	VDDADC(DNP)
VDDCORE	TP12	VDDCORE(DNP)
VDDIO	TP13	VDDIO(DNP)

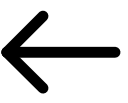

MINIUSB-5P-FEMALE

Holux Technology, Inc.

Title		Nav-55	
Size	A4	Document Number	Rev
Date:		Power	of
		Sheet	1

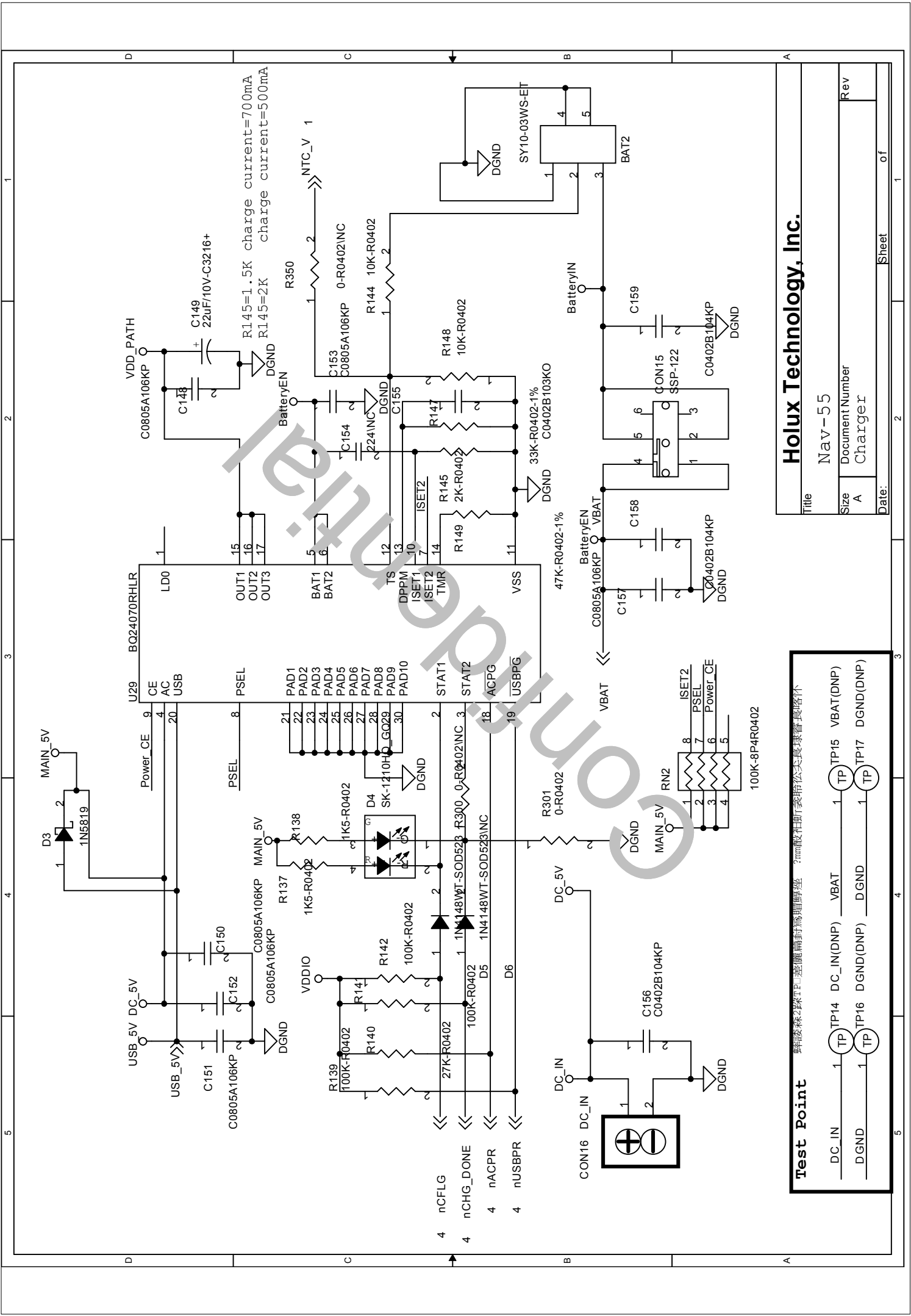

Test Point 轉接線2線TP1-臺灣編封為單線型 2mm線在腳1臺灣倍忒尖長球管長略伸

DC_IN	1	TP14	DC_IN(DNP)	VBAT	1	TP15	VBAT(DNP)
D_GND	1	TP16	D_GND(DNP)	D_GND	1	TP17	D_GND(DNP)

Holux Technology, Inc.	
Title	Nav-55
Size	Document Number
A	Charger
Date:	Rev
Sheet	of
2	1

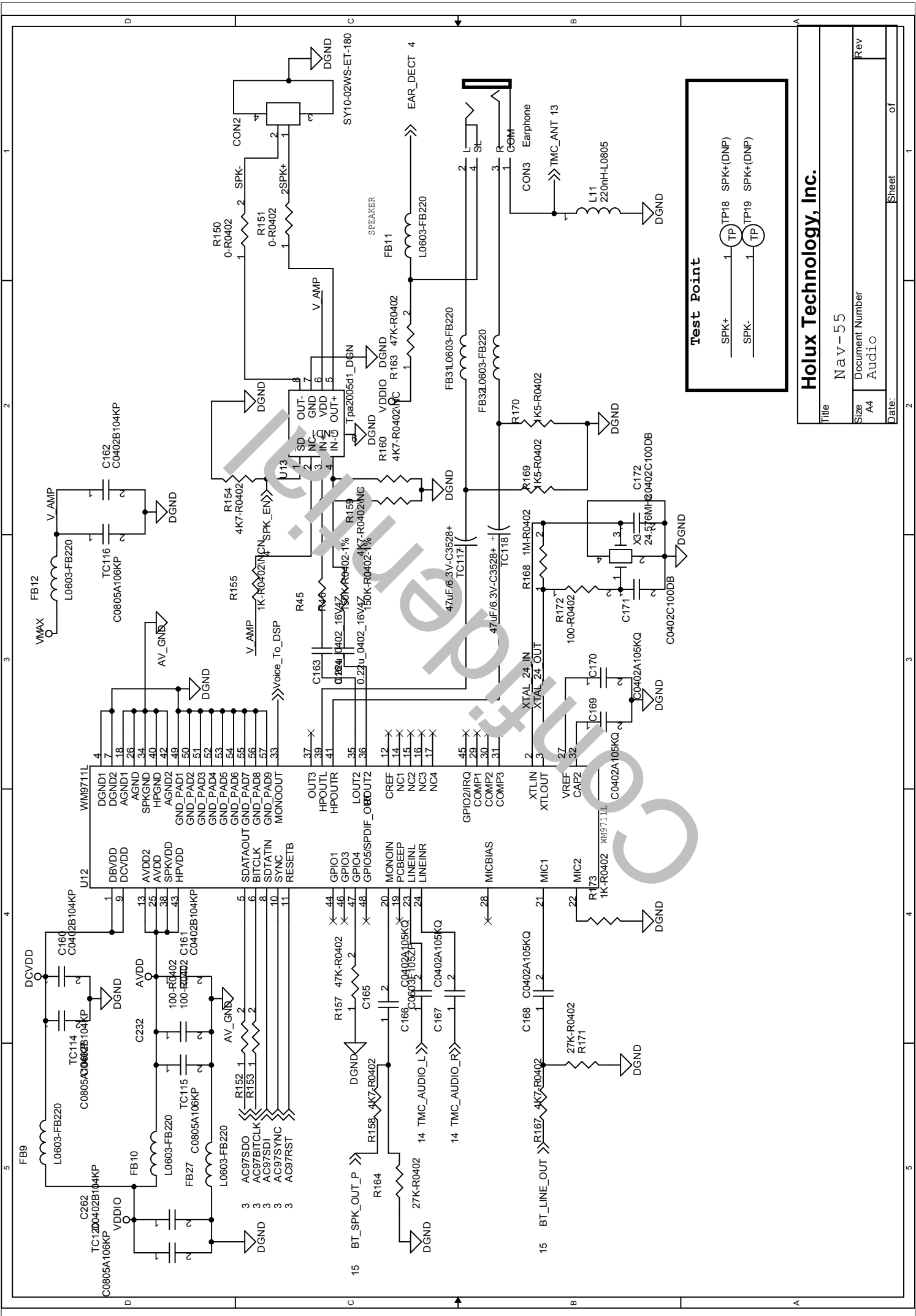

Test Point

- SPK+ 1 TP18 SPK+(DNP)
- SPK- 1 TP19 SPK+(DNP)

Holux Technology, Inc.

Title		Nav-55
Size	Document Number	Audio
A4	Date:	
Sheet		of

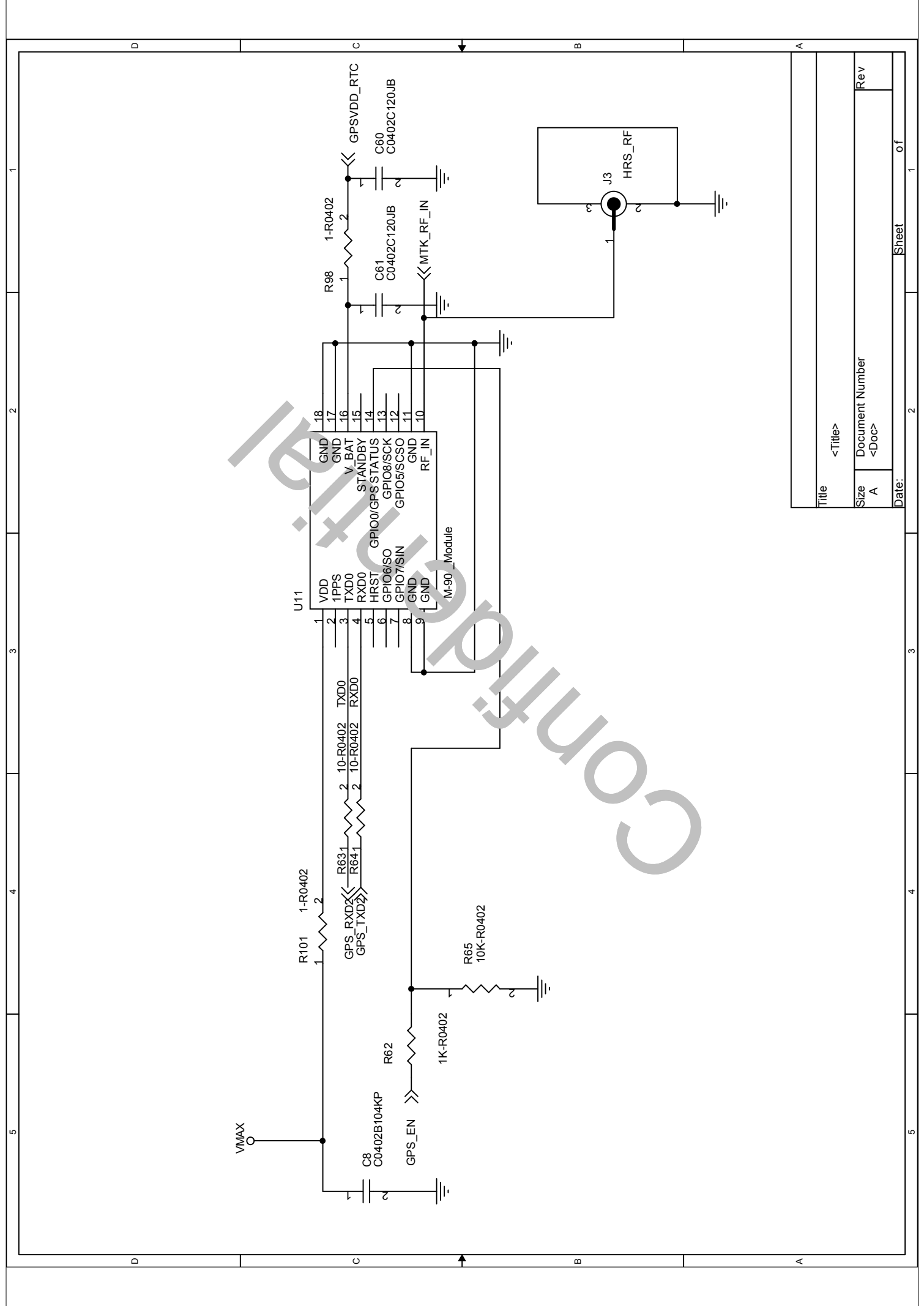

1 2 3 4 5

D C B A

Title		<Title>
Size	Document Number	Rev
A	<Doc>	
Date:	Sheet	of
	2	1