

HOLUX

Heart-Rate Smartband Impulse 8060



User Manual

V1.0

Safety instructions

- Read this manual carefully before use to ensure safe operation of the device.
- The device is not a medical device and only used for the measurement in normal exercises. Make sure the device is worn in the correct measuring position. If you feel uncomfortable during the exercise, stop and seek medical advice immediately. The user must use the device carefully and it is up to the user rather than HOLUX to take all safety responsibilities.
- If you feel discomfort in your skin or an allergic reaction occurs, stop wearing the device and seek medical advice immediately.
- Do not use or store the device in the following environments to avoid failure or damage.
 - Don't expose the device to extreme temperatures or humidity or operate it in such environments;
 - Do not use the device in dusty areas.
- Though the device provides waterproof function (IPX8 water resistance), the following instructions must be followed when you use the device:
 - Don't soak the device or use it in water;
 - Don't take shower or sauna bath with the device worn around the wrist to avoid affecting or damaging the

waterproof function;

- Do not rinse the device directly under a faucet to avoid affecting or damaging the waterproof function.
- Do not remove or replace the battery. Only well trained service personnel are allowed to disassemble/install the internal components. Note: Explosion may occur if the battery is not replaced with a new one of the same model or equivalent type. Contact the manufacturer to dispatch professional service personnel for battery replacement.
- Do not try to disassemble or repair device yourself to avoid failure or device malfunction or occurrence of accidents.

Warranty Statement

- This warranty applies to parts and services that are manufactured and sold through HOLUX. The warranty length is one year from date of purchase (starting from the date on the sales receipt). Under normal user operation, HOLUX provides free repair services.
- HOLUX is not responsible for providing repairs or replacements of any software; HOLUX does not provide any warranty service for third party software/hardware.
- Important instructions
 1. Note: This warranty does not cover damage or malfunction from the below causes: unauthorized disassembly/modification of unit, abuse or incorrect usage, accidental and other unpreventable causes, operation under variables mentioned that are different from those in this product user manual, using parts not made or sold by HOLUX, or repairs done by anyone other than HOLUX and authorized retail/service providers.
 2. Expendable parts are not covered in the warranty.
 3. HOLUX is not responsible for any program, data, or portable storage media damages or loss. Please contact your local HOLUX authorized service provider to learn more about geographical limitations, proof of purchase requests, response time agreements, and other specific maintenance service requests.

4. The content of this user manual is subject to change without prior notice. Please contact us if you have any question or notice any errors in descriptions in the user manual.

Copyright Information

No part of this manual, including the products and software described in it, may be reproduced, transmitted, transcribed, stored in a retrieval system, or translated into any language in any form or by any mean, without the express written permission of Holux Technology, Inc.

Copyright, All Rights Reserved.

Federal Communications Commission (FCC) Statement

This device complies with Part 15 of the FCC Rules. Operation is subject to the following two conditions: (1) this device may not cause harmful interference, and (2) this device must accept any interference received, including interference that may cause undesired operation.

This equipment has been tested and found to comply with the limits for a Class B digital device, pursuant to Part 15 of the FCC Rules. These limits are designed to provide reasonable protection against harmful interference in a residential installation. This equipment generates, uses and can radiate radio frequency energy and, if not installed and used in accordance with the instructions, may cause harmful interference to radio communications. However, there is no guarantee that interference will not occur in a particular installation. If this equipment does cause harmful interference to radio or television reception, which can be determined by turning the equipment off and on, the user is encouraged to try to correct the interference by one or more of the following measures:

- Reorient or relocate the receiving antenna.
- Increase the separation between the equipment and receiver.
- Connect the equipment into an outlet on a circuit different from that to which the receiver is connected.
- Consult the dealer or an experienced radio/TV technician for help.

CAUTION:

Any changes or modifications not expressly approved by the grantee of this device could void the user's authority to operate the equipment.

RF exposure warning:

The equipment complies with FCC RF exposure limits set forth for an uncontrolled environment.

The equipment must not be co-located or operating in conjunction with any other antenna or transmitter.

Content

Product Introduction	9
Product Overview	10
Key function	11
Accessories.....	12
Charging the Battery.....	13
Wear the Smartband.....	15
Maintenance of the product	15
How to use Impulse 8060	16
Menu function	17
Main screen	17
Legends.....	23
APP Installation	24
Normal Care and Maintenance.....	28
Specification.....	30

Product Introduction

Thank you for purchasing HOLUX Heart-Rate Smartband Impulse 8060.

Impulse 8060 is a smartband designed for people who are in pursuit of a healthy lifestyle and convenience in exercising. It has the most advanced integrated physical monitoring technology and can accurately measure the heart-rate for long periods continuously so that users can monitor their heart and lung functions and exercise effectiveness. It can also provides sleep analyses and uses the steps and Calorie function to help remind the amount of daily exercise achieved.

Otherwise, it add a function which can raise to wake the display, let users are more convenience to see info.

Impulse 8060 supports Bluetooth pairing with various smartphones to be used to remind users of incoming calls and messages, and record their exercising status. It can also be used with a dedicated APP to help tracking the exercising results. Results are integrated into cloud data to perform analysis and management of the physical conditions.

Product Overview

Front View

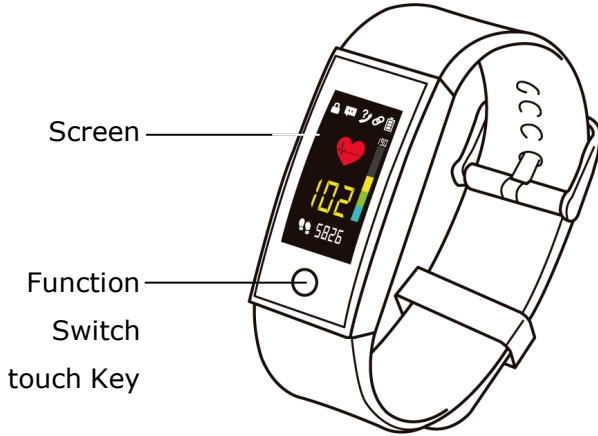

Rear View

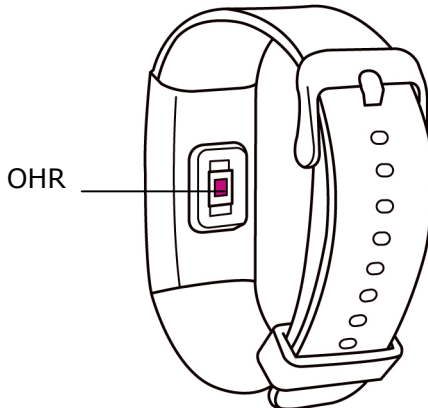

Key function

Key	Operation and Function
Function Switch Key	<p>Switch function: Touch the key shortly to switch Time/ Step-Calorie/ Heart-rate function.</p> <p>Enable/ disable function: In Heart-rate function page, Touch and hold the key for 3 seconds to Enable/ disable the Heart-rate.</p> <p>If the Impulse 8060 cannot operate normally, please run out the battery, then charging it to reset the system.</p>

HOLUX Heart-Rate Smartband Impulse 8060

Accessories

Check the box for the following supplied accessories. If any is missing, contact your supplier immediately.

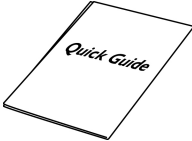
Impulse 8060	Quick Guide
	

Charging the Battery

Before using your Impulse 8060 for the first time, you need to charge it for approximately 2 hours.

As following figure, takes off the Impulse 8060's watchstrap, then using the USB adapter or connect to the USB port of the PC for charging. Make sure Impulse 8060 will vibrate and show a flashing icon after Inserting the device's USB plug to charging.

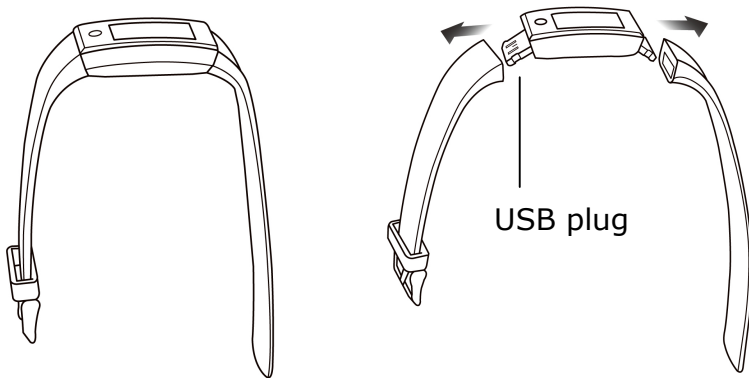

Using the USB adapter (Optional)

Connect the Impulse 8060's USB plug cradle to the optional USB adapter, then insert the USB adapter into a power outlet.

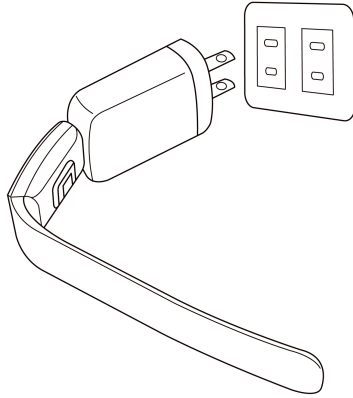

Connecting to a PC

Insert Impulse 8060's USB plug into a free USB port on your PC.

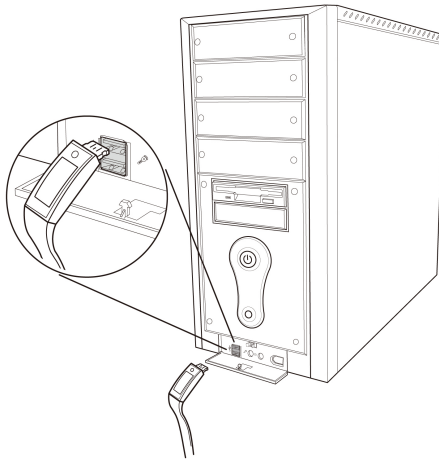

Wear the Impulse 8060

When using Impulse 8060, wear your Impulse 8060 on the wrist below the wrist bone as shown in the following figure. To measure the heart rate correctly, make sure the strap fits snugly around the wrist to ensure the Impulse 8060 is pressed against the skin.

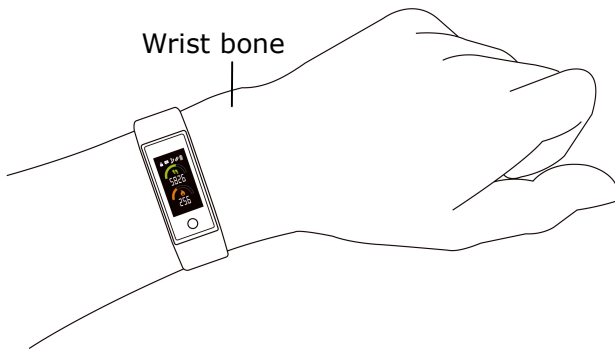

Maintenance of the product

- You can use a damp cloth to wipe the Impulse 8060 or use gentle soap solution to remove oil or dirt.
- Use a wet cotton swab to clean the area around the sensor. Clean it every week if you use the product frequently.
- Be careful not to scratch the sensor part to avoid damage.
- Keep the Impulse 8060 away from any powerful chemical agents, such as gasoline and acetone, to avoid damage.

How to use Impulse 8060

Make sure the battery is fully charged (charging time: about 2 hours) before using Impulse 8060 to ensure normal operation of the system. When using the Impulse 8060 for the first time, **long press the [Function Switch Key] for 6 seconds to enable Impulse 8060.**

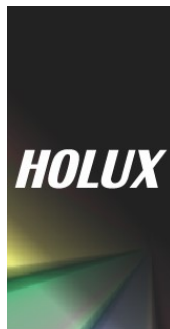
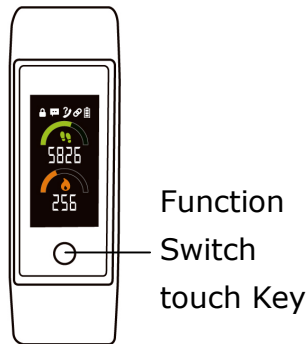

Startup screen

Menu function

The time page appears once you start to use the Impulse 8060. Touch the [Function Switch touch Key] to switch function pages. The following table lists the available functions.

Main screen



Time Function: Display current time.

 hour

 minute

 month/ date

※ Time calibration: using the Bluetooth connection, Impulse APP can be used to calibrate time.

 Screen lock

 Unread Messages prompt on mobile phone

 Missed Calls prompt on mobile phone



Connected to mobile phone via Bluetooth



Power level display



Power level 65~100%;



Power level 35~65%;



Power level 10~35%;



Power level <10%; a low power message appears.



Step Function: Calculate and record the number of steps users have walked.

※ Impulse 8060 lets you know when you reach your goals.



Calorie Calculation : calculate and display calorie consumption.

※ Impulse 8060 lets you know when you reach your goals.



Heart-rate Measurement: Perform continuous and long term heart-rate measurement.

※ Enable/ Disable Heart-rate Measurement:

In the heart-rate measurement function page, touch and hold the [function Switch touch Key] for 3 seconds to Enable/ disable the function. Once the function is enabled, the icon will be displayed as “solid”.

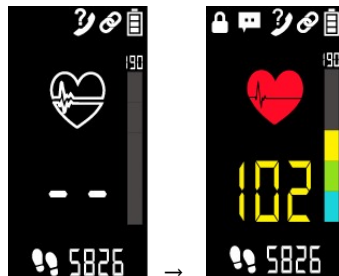

- ※ After enabling the heart-rate measurement function, please first remain stationary for about 20-30 seconds. A big and small heart symbol (beating continuously) will be displayed on the screen. When Impulse 8060 detects heart-rate status, Impulse 8060 will vibrate for 3 seconds. The screen will also display the number and zone of heart-rate.

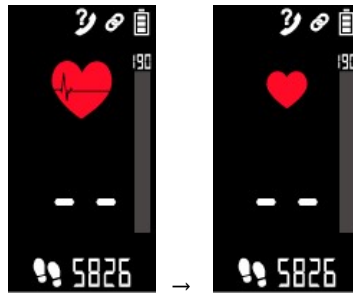

- ※ The Impulse APP can be used to set heart-rate zone. The heart-rate zone 1-5 as shown in the following figures.

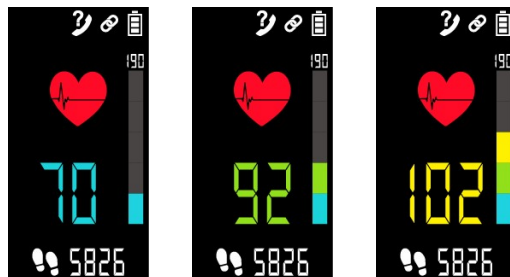

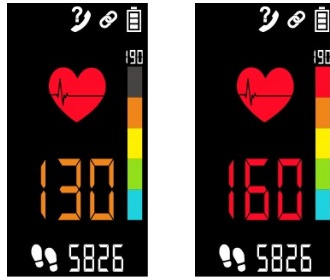

※ If the heart-rate value is not displayed after 2 minutes of detection, Impulse 8060 will disable detection automatically. Please verify the position where Impulse 8060 is worn and perform the measurement again. Then, wait until Impulse 8060 detects the heartbeat before starting normal activities.

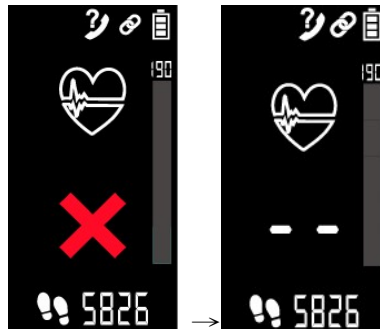

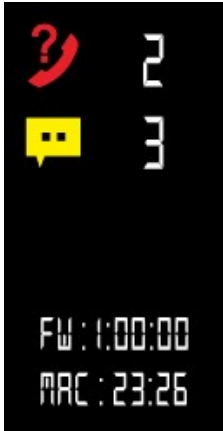

Unread Messages prompt on mobile phone.

Missed Calls prompt on mobile phone



Bluetooth connection and battery status:
Display the Bluetooth connection and power status.

※ When pairing with Bluetooth, the screen will display a link symbol.



Low Power : In low power status, touch [Function Switch touch Key] will only enter Time function.



In charging status: When charging, touch[Function Switch touch Key] does not work. After charging is completed, the screen will show battery status page.



Legends



Insufficient memory space: indicates the memory usage is more than 90%. Short press [Function Switch touch Key] to close the page. This page will appear every ten minutes, until synchronize/ upload data to APP and memory usage is less than 90%.

※ When the memory capacity has been reached, Impulse 8060 will continue to record (the step and heart-rate value) and overwrite the oldest information on the memory.



Synchronize/ upload data: indicates the data is synchronized and uploaded to APP. After uploading, the page will close automatically.



Update FW

The page will close automatically after the FW update is finished.

APP Installation

Using the Bluetooth connection, this device can be used with the Impulse APP installed on your smartphone. The Impulse APP can be used to display related activity and training records.

Step 1: On your smartphone, go to the Google Play Store, search for the "Impulse" APP. Then download and install the APP.

※ Please confirm that both the "Internet Communication" and "Bluetooth" functions on the smartphone are enabled.

For more information on related smartphone operations, please refer to the instructions in the user manual of the smartphone.

Step 2: Launch the Impulse APP .

Step 3: Follow the on-screen instructions to complete account registration and related settings.

※ Please enable the "Bluetooth" function on the smartphone and connect to the Internet either using Wi-Fi or 3G/4G connection.

Register and Login

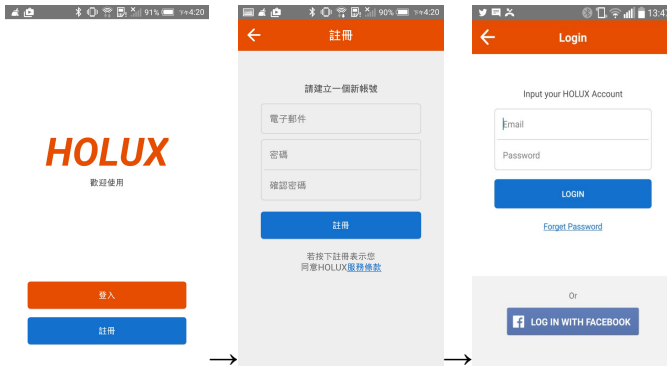

Device pairing and binding (make sure the Bluetooth functions on both the smartphone and Impulse 8060 are enabled)



※ If you do not want to bind to a device, select "Ignore and Next".

Basic Data Setting

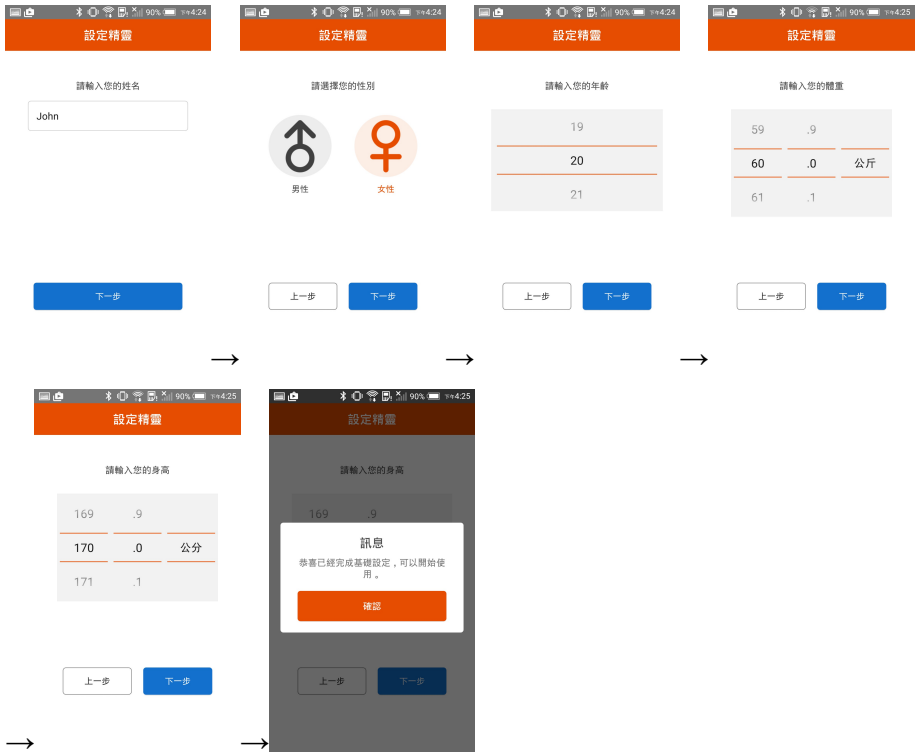

You can start using the Impulse APP after completing the settings.

Remove Device Pairing and Binding

The device information under the "Setup" function can be used to remove device binding.

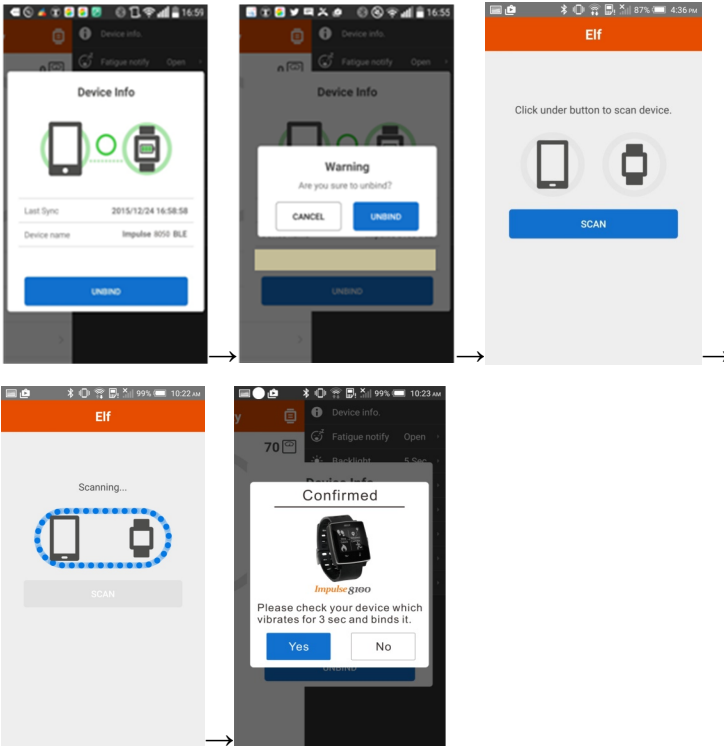

Normal Care and Maintenance

To ensure the unit's normal operation and extended life span, please note the following while using and storing:

- **Do not drop the unit**

If violently impacted or shocked, serious damage may be caused.

- **Avoid sudden temperature changes**

Condensation may occur when entering a warm room on a cold day. To prevent condensation from damaging the unit, please place into an airtight plastic bag before sudden temperature changes.

- **Keep away from strong magnetic fields**

When using or storing, please keep away from strong electromagnetic/ radioactive or magnetic field equipment. °

- **Operating temperature**

The products operating temperature is between 0°C ~ 60°C; please do not operate under extreme temperatures.

- **Avoid exposure to sunlight**

Please avoid long periods of sunlight or high temperature exposure.

- **Cleaning the screen**

Using a soft clean cloth to wipe the screen is recommended; do not use ordinary tissue to wipe the screen.

- **Do not disassemble**

HOLUX Heart-Rate Smartband Impulse 8060

Please do not disassemble the product, this may void the warranty and damage the unit.

• **Storage**

When the product is not being used for a long period, store Impulse 8060 in a cool and dry place. For long-term storage, keeping the unit in a dry box is recommended.

Please do not keep Impulse 8060 in the following environments:

- Unventilated and humid locations.
- In an environment where humidity is over 90%.

Specification

Processor	Low power 32bit processor
Memory	2MB for activity log
Display	0.96" TFT LCD Color screen
Sensor	Optical Heart Rate (OHR) Sensor G-sensor
Bluetooth	4.0 low energy (BLE)
Battery	Rechargeable Li-ion Time mode: 11 days (Disable heart-rate measurement function) Normal operation: 6 days (Enable heart-rate measurement function on average one hour per day) Continuous OHR Mode : 10 hours
Dimension	51(W)x20(L)x13(H)mm
Weight	15g
Mobile application	Android/ iOS
Waterproof	IP68