

ENGINEERING TEST REPORT

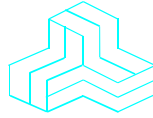

Altitude 350-2 Access Point Model No.: Altitude 350-2

FCC ID: RJF-A3502

Applicant:

Extreme Networks
3585 Monroe Street
Santa Clara, CA 95051
United States

In Accordance With

FEDERAL COMMUNICATIONS COMMISSION (FCC)
Part 15, Subpart C, Section 15.247 - Digital Modulation Transmitters Operating in the
Frequency Band 2400 - 2483.5 MHz
&
Part 15, Subpart E / FCC Docket No.: FCC 03-287
Unlicensed National Information Infrastructure Devices
Operating in Frequency Bands 5.15-5.25 GHz (indoor operation only)
5.25-5.35 GHz and 5.725-5.825 GHz

UltraTech's File No.: CNI-027FCC15CE

This Test report is Issued under the Authority of
Tri M. Luu, Professional Engineer,
Vice President of Engineering
UltraTech Group of Labs

Date: June 10, 2005



Report Prepared by: Dan Huynh

Tested by: Mr. Hung Trinh, RFI Technologist

Issued Date: June 10, 2005

Test Dates: Jan. 25 - Mar. 29 & Jul. 16 - Aug. 1, 2004

- *The results in this Test Report apply only to the sample(s) tested, and the sample tested is randomly selected.*
- *This report must not be used by the client to claim product endorsement by NVLAP or any agency of the US Government.*

UltraTech

3000 Bristol Circle, Oakville, Ontario, Canada, L6H 6G4
Tel.: (905) 829-1570 Fax.: (905) 829-8050
Website: www.ultratech-labs.com, Email: vic@ultratech-labs.com, Email: tri@ultratech-labs.com



31040/SIT



C-1376



46390-2049



200093-0



SL2-IN-E-1119R



00-034



TABLE OF CONTENTS

EXHIBIT 1.	SUBMITTAL CHECK LIST	1
EXHIBIT 2.	INTRODUCTION.....	2
2.1.	SCOPE	2
2.2.	RELATED SUBMITTAL(S)/GRANT(S).....	2
2.3.	NORMATIVE REFERENCES	2
EXHIBIT 3.	PERFORMANCE ASSESSMENT	3
3.1.	CLIENT INFORMATION	3
3.2.	EQUIPMENT UNDER TEST (EUT) INFORMATION	3
3.3.	EUT'S TECHNICAL SPECIFICATIONS	4
3.4.	LIST OF EUT'S PORTS.....	5
3.5.	ANCILLARY EQUIPMENT	6
3.6.	GENERAL TEST SETUP.....	6
EXHIBIT 4.	EUT OPERATING CONDITIONS AND CONFIGURATIONS DURING TESTS.....	7
4.1.	CLIMATE TEST CONDITIONS	7
4.2.	OPERATIONAL TEST CONDITIONS & ARRANGEMENT FOR TESTS	7
EXHIBIT 5.	SUMMARY OF TEST RESULTS.....	8
5.1.	LOCATION OF TESTS.....	8
5.2.	MODIFICATIONS INCORPORATED IN THE EUT FOR COMPLIANCE PURPOSES.....	8
5.3.	APPLICABILITY & SUMMARY OF EMC EMISSION TEST RESULTS @ FCC 15.247	8
5.4.	APPLICABILITY & SUMMARY OF EMC EMISSION TEST RESULTS @ FCC 15.407	9
EXHIBIT 6.	TEST DATA @ FCC 15, SUBPART C – GENERAL REQUIREMENTS	10
6.1.	COMPLIANCE WITH FCC PART 15 – GENERAL TECHNICAL REQUIREMENTS	10
EXHIBIT 7.	TEST DATA [§15.247 – OPERATION IN 2.4-2.4835 GHz]	11
7.1.	6 dB BANDWIDTH [§ 15.247(a)(2)]	11
7.2.	PEAK OUTPUT POWER (CONDUCTED) [§ 15.247(b)]	18
7.3.	RF EXPOSURE REQUIRMENTS [§§ 15.247(b)(4), 1.1310 & 2.1091]	23
7.4.	TRANSMITTER BAND-EDGE & SPURIOUS EMISSIONS (CONDUCTED) [§ 15.247(c)]	25
7.5.	TRANSMITTED POWER DENSITY OF A DIGITAL MODULATION SYSTEM [§ 15.247(d)]	48
7.6.	SPURIOUS EMISSIONS (RADIATED @ 3 METERS) [§§ 15.247(c), 15.209 & 15.205]	75
EXHIBIT 8.	TEST DATA [§ 15.407 – OPERATION IN 5.15-5.825 GHz]	104
8.1.	DISCONTINUATION OF TRANSMISSION [§ 15.407(c)]	104
8.2.	FREQUENCY STABILITY [§ 15.407(g)]	105
8.3.	POWER LIMITS & 26 dB BANDWIDTH [§ 15.407(a)]	107
8.4.	RF EXPOSURE REQUIRMENTS [§§ 15.407(f), 1.1310 & 2.1091]	156
8.5.	BAND-EDGE & UNDESIRE EMISSIONS (CONDUCTED) [§ 15.407(b)]	158
8.6.	BAND-EDGE AND UNDESIRE EMISSIONS (RADIATED @ 3 METERS) [§ 15.407(b)]	199
EXHIBIT 9.	MEASUREMENT UNCERTAINTY.....	222
9.1.	LINE CONDUCTED EMISSION MEASUREMENT UNCERTAINTY.....	222
9.2.	RADIATED EMISSION MEASUREMENT UNCERTAINTY	223

EXHIBIT 10.	MEASUREMENT METHODS	224
10.1.	GENERAL TEST CONDITIONS	224
10.2.	METHOD OF MEASUREMENTS - AC MAINS CONDUCTED EMISSIONS	225
10.3.	PEAK CONDUCTED POWER & PEAK EIRP	226
10.4.	SPURIOUS EMISSIONS (CONDUCTED & RADIATED)	229
10.5.	ALTERNATIVE TEST PROCEDURES.....	232
10.6.	TRANSMITTED POWER DENSITY OF A DIGITAL MODULATION SYSTEM.....	233

EXHIBIT 1. SUBMITTAL CHECK LIST

Annex No.	Exhibit Type	Description of Contents	Quality Check (OK)
--	Test Report	<ul style="list-style-type: none"> • Exhibit 1: Submittal check lists • Exhibit 2: Introduction • Exhibit 3: Performance Assessment • Exhibit 4: EUT Operation and Configuration during Tests • Exhibit 5: Summary of test Results • Exhibit 6: Measurement Data • Exhibit 7: Measurement Uncertainty • Exhibit 8: Measurement Methods 	OK
1	Test Setup Photos	Radiated Emission Test Setup Photos	OK
2	External Photos of EUT	External EUT Photos	OK
3	Internal Photos of EUT	Internal EUT Photos	OK
4	Cover Letters	<ul style="list-style-type: none"> ▪ Letter from Ultratech for Certification Request ▪ Letter from the Applicant to appoint Ultratech to act as an agent ▪ Letter from the Applicant to request for Confidentiality Filing 	OK
5	Attestation Statements	--	--
6	ID Label/Location Info	<ul style="list-style-type: none"> ▪ ID Label ▪ Location of ID Label 	OK
7	Block Diagrams	Block Diagram	OK
8	Schematic Diagrams	Schematics	OK
9	Parts List/Tune Up Info	N/A	N/A
10	Operational Description	System Overview and Operational Description	OK
11	RF Exposure Info	See Sections 7.3 and 8.4 MPE Evaluations	OK
12	Users Manual	<ul style="list-style-type: none"> ▪ User Guide ▪ Installation Guide 	OK

ULTRATECH GROUP OF LABS

3000 Bristol Circle, Oakville, Ontario, Canada L6H 6G4
 Tel. #: 905-829-1570, Fax. #: 905-829-8050, Email: vic@ultratech-labs.com, Website: <http://www.ultratech-labs.com>

File #: CNI-027FCC15CE

June 10, 2005

All test results contained in this engineering test report are traceable to National Institute of Standards and Technology (NIST)

EXHIBIT 2. INTRODUCTION

2.1. SCOPE

Reference:	<ul style="list-style-type: none">FCC Part 15, Subpart C, Section 15.247FCC Part 15, Subpart E / FCC Docket No.: FCC 03-287 - Unlicensed National Information Infrastructure Devices
Title:	Code of Federal Regulations (CFR) Title 47 - Telecommunication, Part 15
Purpose of Test:	<ul style="list-style-type: none">To gain FCC Certification Authorization for Digital Modulation Transmitters operating in the Frequency Band 2400 - 2483.5 MHz .This report covered test results for Certification compliance with FCC regulations for Unlicensed National Information Infrastructure (U-NII) devices operating in the 5.15-5.25 GHz (indoor operation only), 5.25-5.35 GHz and 5.725-5.825 GHz bands
Test Procedures:	Both conducted and radiated emissions measurements were conducted in accordance with American National Standards Institute ANSI C63.4 - American National Standard for Methods of Measurement of Radio-Noise Emissions from Low-Voltage Electrical and Electronic Equipment in the Range of 9 kHz to 40 GHz.
Environmental Classification:	<ul style="list-style-type: none">ResidentialLight-industry, CommercialIndustry

2.2. RELATED SUBMITTAL(S)/GRANT(S)

None.

2.3. NORMATIVE REFERENCES

Publication	Year	Title
FCC CFR Parts 0-19	2004	Code of Federal Regulations – Telecommunication
ANSI C63.4	2003	American National Standard for Methods of Measurement of Radio-Noise Emissions from Low-Voltage Electrical and Electronic Equipment in the Range of 9 kHz to 40 GHz
CISPR 22 +A1 EN 55022	2003-04-10 2004-10-14 2003	Limits and Methods of Measurements of Radio Disturbance Characteristics of Information Technology Equipment
CISPR 16-1-1	2003	Specification for Radio Disturbance and Immunity measuring apparatus and methods
FCC ET Docket No. 99-231	2002	Amendment to FCC Part 15 of the Commission's Rules Regarding to Spread Spectrum Devices
FCC Docket	2003	Revision of Parts 2 and 15 of Commission's Rules to permit Unlicensed National Information Infrastructure (U-NII) Devices in the 5 GHz band
FCC Procedures	2001	Guidelines for Assessing Unlicensed National Information Infrastructure Devices (UNII)-Part 15 Subpart E - November 2001

ULTRATECH GROUP OF LABS

3000 Bristol Circle, Oakville, Ontario, Canada L6H 6G4
Tel. #: 905-829-1570, Fax. #: 905-829-8050, Email: vic@ultratech-labs.com, Website: <http://www.ultratech-labs.com>

File #: CNI-027FCC15CE
June 10, 2005

All test results contained in this engineering test report are traceable to National Institute of Standards and Technology (NIST)

EXHIBIT 3. PERFORMANCE ASSESSMENT

3.1. CLIENT INFORMATION

APPLICANT	
Name:	Extreme Networks
Address:	3585 Monroe Street Santa Clara, CA 95051 United States
Contact Person:	Mr. Mark Darula Phone #: 408 579-3249 Fax #: 408 579-3000 Email Address: mdarula@extremenetworks.com

MANUFACTURER	
Name:	Celestica Inc.
Address:	9 Northeastern Blvd Salem, New Hampshire 03079 USA
Contact Person:	Kirit Patel Phone #: 1-603-890-8158 Fax #: n/a Email Address: kiritbh@celestica.com

3.2. EQUIPMENT UNDER TEST (EUT) INFORMATION

The following information (with the exception of the Date of Receipt) has been supplied by the applicant.

Brand Name:	Extreme Networks
Product Name:	Altitude 350-2 Access Point
Model Name or Number:	Altitude 350-2 , there are two internal models to differentiate between the detachable antennas and integral antennas. Integral antennas unit will be identified and labeled as “ 15938 Altitude 350-2 Integ. Ant AP ” and detachable antennas will be identified and labeled as “ 15939 Altitude 350-2 Detach. Ant. AP ”
Oscillators’ Frequencies:	802.11b/g: IF is 672MHz (fixed) LO adjusts between 1740MHz –1812MHz for Channels 1 – 14. 802.11a: IF adjusts between 1727MHz to 1747MHz for channels 36-48; 1753-1773MHz (Channels 52-64); 1833MHz – 1900MHz (channels 100-140); 1915-1935MHz (channels 149-161) LO adjusts between 3453-3493MHz (Channels 36-48);3507-3547MHz (Channels 52-64);3667-3800MHz (Channels 100-140); 3830-3870MHz (Channels 149-161)
CPU’s Frequencies:	25 MHz and 40 MHz
Power input source:	Generic External AC/DC Adapter

ULTRATECH GROUP OF LABS

3000 Bristol Circle, Oakville, Ontario, Canada L6H 6G4
 Tel. #: 905-829-1570, Fax. #: 905-829-8050, Email: vic@ultratech-labs.com, Website: <http://www.ultratech-labs.com>

File #: CNI-027FCC15CE
 June 10, 2005

All test results contained in this engineering test report are traceable to National Institute of Standards and Technology (NIST)

3.3. EUT’S TECHNICAL SPECIFICATIONS

TRANSMITTER	
Equipment Type:	Mobile
Intended Operating Environment:	<ul style="list-style-type: none"> ▪ Residential ▪ Commercial, light industry & heavy industry
Power Supply Requirement:	6.0V @ 2.0A at input of unit.
RF Output Power Rating:	<ul style="list-style-type: none"> ▪ 802.11b: 17-20dBm (Channels 1-14); ▪ 802.11g: 14-17dBm (Channels 1-14); ▪ 802.11a: 13-15dBm (Channels 36-48) 13-20dBm (Channels 52-60) 13-17dBm (Channel 64) 13-21dBm (Channels 100-140) 13-20dBm (Channels 149-161)
Operating Frequency Range:	<ul style="list-style-type: none"> ▪ 2.412GHz - 2.484GHz (channels 1 - 14), ▪ 5.15GHz – 5.25GHz (Channels 36 - 48), ▪ 5.25GHz – 5.35GHz (Channels 52 - 64) ▪ 5.725GHz – 5.825GHz (Channels 149 - 161)
RF Output Impedance:	50 ohms
Channel Spacing:	<ul style="list-style-type: none"> ▪ 5 MHz for 802.11b/g ▪ 20MHz for 802.11a
Duty Cycle:	100%
Modulation Type:	BPSK, QPSK, CCK and OFDM
Oscillator Frequencies:	<p>802.11b/g: IF is 672MHz (fixed) LO adjusts between 1740MHz –1812MHz for Channels 1 – 14.</p> <p>802.11a: IF adjusts between 1727MHz to 1747MHz for channels 36-48; 1753-1773MHz (Channels 52-64); 1833MHz – 1900MHz (channels 100-140); 1915-1935MHz (channels 149-161) LO adjusts between 3453-3493MHz (Channels 36-48); 3507-3547MHz (Channels 52-64);3667-3800MHz (Channels 100-140); 3830-3870MHz (Channels 149-161)</p>
Antenna Connector Type:	<ul style="list-style-type: none"> ▪ Non-integral (2 external antennas, using RPSMA for mating, if operating in 5.15-5.25GHz band, this antenna coupling will be permanently affixed with cyanoacrylate type glue for compliance to section 15.407 (d)) ▪ Integral (2 internal antennas soldered onto PCB and located inside the enclosure)
Antenna Description:	<p>External: Manufacturer: Joymax Electronics Co. Type: Omnidirectional Tri Band Swivel RPSMA Interface Antenna Model: FW-614RS-406 Frequency Range: 2300-2500MHz and 4.9GHz – 5.85GHz In/Out Impedance: 50 Ohms Gain: 4 dBi (2.45 GHz) and 5 dBi (5.5 GHz)</p>

	<p>Internal: Manufacturer: Etenna Corporation Type: Omnidirectional Tri Band Embedded Antenna Model: EE5801 Frequency Range: 2300 - 2500 MHz and 4.9 – 5.85 GHz In/Out Impedance: 50 Ohms Gain: 4.3 dBi (Max.)</p>
--	---

RECEIVER	
Operating Frequency Range:	<ul style="list-style-type: none"> ▪ 2.412 - 2.484GHz ▪ 5.15 - 5.25GHz ▪ 5.25 - 5.35GHz ▪ 5.725 – 5.825GHz
RF Output Impedance:	50 ohms
Channel Spacing:	5 MHz for 802.11b/g and 20MHz for 802.11a
Antenna Connector Type:	Same as transmitter
Antenna Description:	Same as transmitter
Oscillator Frequencies:	<p>802.11b/g: IF is 672MHz (fixed) LO adjusts between 1740MHz –1812MHz for Channels 1 – 14.</p> <p>802.11a: IF adjusts between 1727MHz to 1747MHz for channels 36-48; 1753-1773MHz (Channels 52-64); 1833MHz – 1900MHz (channels 100-140); 1915-1935MHz (channels 149-161) LO adjusts between 3453-3493MHz (Channels 36-48);3507-3547MHz (Channels 52-64);3667-3800MHz (Channels 100-140); 3830-3870MHz (Channels 149-161)</p>

3.4. LIST OF EUT’S PORTS

Port Number	EUT’s Port Description	Number of Identical Ports	Connector Type	Cable Type (Shielded/Non-shielded)
1	Ethernet port	1	RJ45	Non-shielded
2	DC in port	1	RAPC712 equivalent	Non-shielded
3	RF Antenna port (external antenna version only)	2	Reverse-polarity SMA (RPSMA)	N/A – mates directly to antennae.

Note: The internal antenna unit does not have RF Antenna Port.

3.5. ANCILLARY EQUIPMENT

The EUT was tested while connected to the following representative configuration of ancillary equipment necessary to exercise the ports during tests:

Ancillary Equipment # 1	
Description:	Laptop Computer
Brand name:	Dell
Model Name or Number:	PP01L
FCC Approval:	FCC Class B -DoC
Connected to EUT's Port:	RJ-45 Ethernet

3.6. GENERAL TEST SETUP

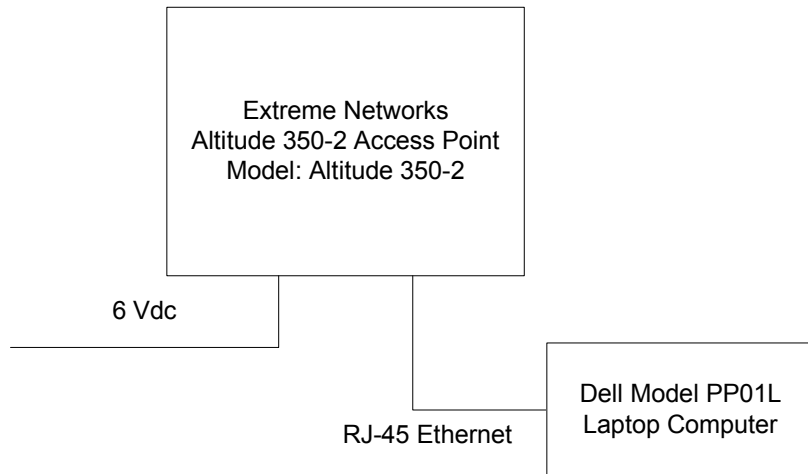

EXHIBIT 4. EUT OPERATING CONDITIONS AND CONFIGURATIONS DURING TESTS

4.1. CLIMATE TEST CONDITIONS

The climate conditions of the test environment are as follows:

Temperature:	21°C
Humidity:	51%
Pressure:	102 kPa
Power input source:	6 Vdc using external AC/DC adaptor

4.2. OPERATIONAL TEST CONDITIONS & ARRANGEMENT FOR TESTS

Operating Modes:	<ul style="list-style-type: none"> ▪ Each of lowest, middle and highest channel frequencies transmits continuously for emissions measurements. ▪ The EUT operates in normal Direct Sequence mode for occupancy duration, and frequency separation.
Special Test Software:	Special software is provided by the Applicant to select and operate the EUT at each channel frequency continuously. For example, the transmitter will be operated at each of lowest, middle and highest frequencies individually continuously during testing.
Special Hardware Used:	N/A
Transmitter Test Antenna:	The EUT is tested with the antenna fitted in a manner typical of normal intended use.

Transmitter Test Signals	
Frequency Band(s):	<ul style="list-style-type: none"> ▪ 2412 - 2462 MHz ▪ 5.15 - 5.25 GHz ▪ 5.25 - 5.35 GHz ▪ 5.725 - 5.825 GHz
Frequency(ies) Tested: (Near lowest, near middle & near highest frequencies in the frequency range of operation.)	<ul style="list-style-type: none"> ▪ 2412, 2437 and 2462 MHz ▪ 5180, 5220 and 5240 MHz ▪ 5260, 5300 and 5320 MHz ▪ 5745, 5785 and 5805 MHz
Transmitter Wanted Output Test Signals:	
<ul style="list-style-type: none"> ▪ RF Power Output (measured maximum output power): 	<ul style="list-style-type: none"> ▪ 2412 - 2462 MHz: 20.70 dBm (0.117 W) ▪ 5.15 – 5.25 GHz: 16.00 dBm (0.040 W) ▪ 5.25 – 5.35 GHz: 16.87 dBm (0.049 W) ▪ 5.725 – 5.825 GHz: 12.99 dBm (0.020 W)
<ul style="list-style-type: none"> ▪ Normal Test Modulation: 	See test data for details.
<ul style="list-style-type: none"> ▪ Modulating signal source: 	Internal

EXHIBIT 5. SUMMARY OF TEST RESULTS

5.1. LOCATION OF TESTS

All of the measurements described in this report were performed at Ultratech Group of Labs located in the city of Oakville, Province of Ontario, Canada.

- AC Powerline Conducted Emissions were performed in UltraTech's shielded room, 16'(L) by 12'(W) by 12'(H).
- Radiated Emissions were performed at the Ultratech's 3 Meter Open Field Test Site (OFTS) situated in the Town of Oakville, province of Ontario.

The above sites have been calibrated in accordance with ANSI C63.4, and found to be in compliance with the requirements of Sec. 2.948 of the FCC Rules. The descriptions and site measurement data of the Oakville Open Field Test Site has been filed with FCC office (FCC File No.: 31040/SIT 1300B3) and Industry Canada office (Industry Canada File No.: IC2049). Last Date of Site Calibration: Nov. 04, 2003.

5.2. MODIFICATIONS INCORPORATED IN THE EUT FOR COMPLIANCE PURPOSES

None.

5.3. APPLICABILITY & SUMMARY OF EMC EMISSION TEST RESULTS @ FCC 15.247

FCC Section(s)	Test Requirements	Compliance (Yes/No)
Public Notice DA 00-1407	Part 15 Unlicensed Modular Transmitter Approval	N/A
15.107(a) & 207	AC Power Conducted Emissions	Yes
15.247(a)(2)	6dB Bandwidth of a Digital Modulation System	Yes
15.247(b) & 1.1310	Maximum Peak Power (Conducted)	Yes
1.1307, 1.1310, 2.1091 & 2.1093	RF Exposure Limit	Yes
15.247(c)	RF Conducted Spurious Emissions at the Transmitter Antenna Terminal	Yes
15.247(d)	Transmitted Power Density of a Digital Modulation System	Yes
15.247(c), 15.209 & 15.205	Transmitter Radiated Emissions	Yes
FCC Part 15, Sub. B, Section 15.109	Class B Radiated Emissions	Yes. (See Note)

Note: A separate engineering test report for compliance with FCC Part 15, Subpart B - Class B Unintentional Radiators will be provided upon request.

ULTRATECH GROUP OF LABS

3000 Bristol Circle, Oakville, Ontario, Canada L6H 6G4
Tel. #: 905-829-1570, Fax. #: 905-829-8050, Email: vic@ultratech-labs.com, Website: <http://www.ultratech-labs.com>

File #: CNI-027FCC15CE
June 10, 2005

All test results contained in this engineering test report are traceable to National Institute of Standards and Technology (NIST)

5.4. APPLICABILITY & SUMMARY OF EMC EMISSION TEST RESULTS @ FCC 15.407

FCC Section(s)	Test Requirements	Compliance (Yes/No)
15.407(d), 15.203 & 15.204	Any U-NII device that operates in the 5.15-5.25 GHz (indoor operation only) band shall use a transmitting antenna that is an integral part of the device	Yes.
15.407(e)	Within the 5.15-5.25 GHz band, U-NII devices will be restricted to indoor operations to reduce any potential for harmful interference to co-channel MSS operations	Yes.
15.407(c)	The device shall automatically discontinue transmission in case of either absence of information to transmit or operational failure. These provisions are not intended to preclude the transmission of control or signalling information or the use of repetitive codes used by certain digital technologies to complete frame or burst intervals. Applicants shall include in their application for equipment authorization a description of how this requirement is met.	Yes.
15.407(g)	Manufacturers of U-NII devices are responsible for ensuring frequency stability such that an emission is maintained within the band of operation under all conditions of normal operation as specified in the users manual	Yes.
15.407(a)	Power Limits (Peak Transmit Power and Power Spectral Density) & 26 dB Bandwidth	Yes.
15.407(f), 1.1307, 1.1310, 2.1091 & 2.1093	RF Exposure Limit	Yes.
15.407(b)	Band-edge & Undesired Emissions (Conducted)	Yes.
15.407(b), 15.205 & 15.209	Band-edge & Undesired Emissions (Radiated)	Yes.
15.107 & 15.207	Class B - AC Power Conducted Emissions on Tx, Rx and standby modes	Yes. A separate test report will be provided upon request.
15.109(a)	Class B - Radiated Emissions from Unintentional Radiators	Yes. A separate test report will be provided upon request.

EXHIBIT 6. TEST DATA @ FCC 15, SUBPART C – GENERAL REQUIREMENTS

6.1. COMPLIANCE WITH FCC PART 15 – GENERAL TECHNICAL REQUIREMENTS

FCC Section (s)	FCC Rules	Comments
15.203	<p>Described how the EUT complies with the requirement that either its antenna is permanently attached, or that it employs a unique antenna connector, for every antenna proposed for use with the EUT.</p> <p>The exception is in those cases where EUT must be professionally installed. In order to demonstrate that professional installation is required, the following 3 points must be addressed:</p> <ul style="list-style-type: none"> • The application (or intended use) of the EUT • The installation requirements of the EUT • The method by which the EUT will be marketed 	<p>Conform.</p> <p>External antennas: The EUT is equipped with Swivel RPSMA interface antennas, if operating in 5.15-5.25GHz band, this antenna coupling will be permanently affixed with cyanoacrylate type glue for compliance to section 15.407 (d)</p> <p>Internal antennas: The internal antennas are integral components mounted on the PCB and located inside the enclosure.</p>
15.204	<p>Provided the information for every antenna proposed for use with the EUT:</p> <p>(a) type (e.g. Yagi, patch, grid, dish, etc...), (b) manufacturer and model number (c) gain with reference to an isotropic radiator</p>	<p>External, permanently attached: Manufacturer: Joymax Electronics Co. Type: Omnidirectional Tri Band Swivel RPSMA interface Antenna Model: FW-614RS-406 Frequency Range: 2300-2500MHz and 4.9GHz – 5.85GHz In/Out Impedance: 50 Ohms Gain: 4dBi (2.45GHz) and 5dBi (5.5GHz)</p> <p>Internal, permanently attached: Manufacturer: Etenna Company Type: Omnidirectional Tri Band Embedded Antenna Model: EE5801 Frequency Range: 2300-2500 MHz and 4.9 GHz – 5.85 GHz In/Out Impedance: 50 Ohms Gain: 4.3 dBi (Max.) 2.45 GHz & 5.5 GHz</p>

EXHIBIT 7. TEST DATA [§15.247 – OPERATION IN 2.4-2.4835 GHz]

7.1. 6 dB BANDWIDTH [§ 15.247(a)(2)]

7.1.1. Limits

For a Digital Modulation System, the minimum 6dB bandwidth shall be at least 500 KHz.

7.1.2. Method of Measurements

The transmitter output was connected to the spectrum analyzer through an attenuator. The bandwidth of the fundamental frequency was measured with the spectrum analyzer using 30 KHz RBW, VBW = 100 KHz. The 6 dB bandwidth was measured and recorded.

7.1.3. Test Arrangement

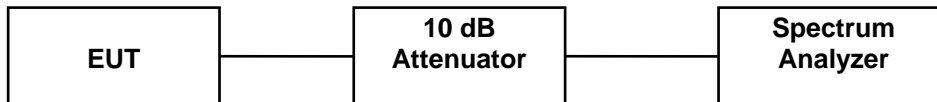

7.1.4. Test Equipment List

Test Instruments	Manufacturer	Model No.	Serial No.	Frequency Range
Spectrum Analyzer	Rohde & Schwarz	FSEK20/B4/B21	834157/005	9 kHz – 40 GHz

7.1.5. Test Data

Channel Frequency (MHz)	Modulation *	6 dB Bandwidth (MHz)	Minimum Limit (MHz)	Pass/Fail
2412	IEEE 802.11b (CCK 11 Mb/s)	11.4	0.5	Pass
2437	IEEE 802.11b (CCK 11 Mb/s)	11.5	0.5	Pass
2462	IEEE 802.11b (CCK 11 Mb/s)	11.6	0.5	Pass
2412	IEEE 802.11g (OFDM @ 54 Mb/s)	16.6	0.5	Pass
2437	IEEE 802.11g (OFDM @ 54 Mb/s)	16.6	0.5	Pass
2462	IEEE 802.11g (OFDM @ 54 Mb/s)	16.6	0.5	Pass

* The 6 dB Bandwidths were found to be the same for all different modulations. Please refer to Plot # 1 to 6 for detailed measurements.

7.2. PEAK OUTPUT POWER (CONDUCTED) [§ 15.247(b)]

7.2.1. Limits

- **FCC 15.247(b)(3):** Maximum peak output power of the transmitter shall not exceed 1 Watt.
- **FCC 15.247(b)(4):** If transmitting antennas of directional gain greater than 6 dBi are used the peak output power from the intentional radiator shall be reduced below the stated values, as appropriate, by the amount in dB that the directional gain of the antenna exceeds 6 dBi.

7.2.2. Method of Measurements & Test Arrangement

Refer to Exhibit 10, Section 10.3 of this test report, FCC 15.247(b)(1)&(3), ANSI C63.4 & ETSI 300 328

Note: The conducted peak power measurement method was performed in accordance with ETSI 300 328 since it was proven to be independent with the peak power meter characteristics.

7.2.3. Test Equipment List

Test Instruments	Manufacturer	Model No.	Serial No.	Frequency Range
RF Signal Generator	Hewlett Packard	HP 83752B	3610A00457	0.01 – 20 GHz
67297 RF Detector (Diode Detector)	Herotex	DZ122-553	63400	..
Storage Oscilloscope	Philips	PM3320A	ST9907959	--

7.2.4. Test Data

The following test data is the worst-case measurements.

7.2.4.1. External Antenna, Test Configuration #1: Modulation IEEE 802.11b

Frequency (MHz)	Modulation	(full bandwidth) Peak Power at Antenna Terminals (dBm)	Maximum Antenna Gain (dBi)	(full bandwidth) Peak EIRP (dBm)	Limit for Power at Antenna Port (dBm)	Limit for EIRP (dBm)
2412	CCK @ 1 Mb/s	20.5	4.0	24.5	30.0	36.0
2437	CCK @ 1 Mb/s	20.6	4.0	24.6	30.0	36.0
2462	CCK @ 1 Mb/s	20.7	4.0	24.7	30.0	36.0
2412	CCK @ 2 Mb/s	20.5	4.0	24.5	30.0	36.0
2437	CCK @ 2 Mb/s	20.6	4.0	24.6	30.0	36.0
2462	CCK @ 2 Mb/s	20.7	4.0	24.7	30.0	36.0
2412	CCK @ 5.5 Mb/s	20.5	4.0	24.5	30.0	36.0
2437	CCK @ 5.5 Mb/s	20.5	4.0	24.5	30.0	36.0
2462	CCK @ 5.5 Mb/s	20.6	4.0	24.6	30.0	36.0
2412	CCK @ 11 Mb/s	20.4	4.0	24.4	30.0	36.0
2437	CCK @ 11 Mb/s	20.5	4.0	24.5	30.0	36.0
2462	CCK @ 11 Mb/s	20.6	4.0	24.6	30.0	36.0

7.2.4.2. External Antenna, Test Configuration #2: Modulation IEEE 802.11g (OFDM)

Frequency (MHz)	Modulation	(full bandwidth) Peak Power at Antenna Terminals (dBm)	Maximum Antenna Gain (dBi)	(full bandwidth) Peak EIRP (dBm)	Limit for Power at Antenna Port (dBm)	Limit for EIRP (dBm)
2412	OFDM @ 9 Mb/s	20.5	4.0	24.5	30.0	36.0
2437	OFDM @ 9 Mb/s	20.6	4.0	24.6	30.0	36.0
2462	OFDM @ 9 Mb/s	20.7	4.0	24.7	30.0	36.0
2412	OFDM @ 18 Mb/s	19.5	4.0	23.5	30.0	36.0
2437	OFDM @ 18 Mb/s	19.8	4.0	23.8	30.0	36.0
2462	OFDM @ 18 Mb/s	20.0	4.0	24.0	30.0	36.0
2412	OFDM @ 36 Mb/s	18.9	4.0	22.9	30.0	36.0
2437	OFDM @ 36 Mb/s	19.1	4.0	23.1	30.0	36.0
2462	OFDM @ 36 Mb/s	18.8	4.0	22.8	30.0	36.0
2412	OFDM @ 54 Mb/s	18.0	4.0	22.0	30.0	36.0
2437	OFDM @ 54 Mb/s	17.8	4.0	21.8	30.0	36.0
2462	OFDM @ 54 Mb/s	17.7	4.0	21.7	30.0	36.0

7.2.4.3. Internal Antenna, Test Configuration #1: Modulation IEEE 802.11b

Frequency (MHz)	Modulation	(full bandwidth) Peak Power at Antenna Terminals (dBm)	Maximum Antenna Gain (dBi)	(full bandwidth) Peak EIRP (dBm)	Limit for Power at Antenna Port (dBm)	Limit for EIRP (dBm)
2412	CCK @ 1 Mb/s	19.1	4.3	23.4	30.0	36.0
2437	CCK @ 1 Mb/s	20.6	4.3	24.9	30.0	36.0
2462	CCK @ 1 Mb/s	19.0	4.3	23.3	30.0	36.0
2412	CCK @ 2 Mb/s	19.1	4.3	23.4	30.0	36.0
2437	CCK @ 2 Mb/s	20.6	4.3	24.9	30.0	36.0
2462	CCK @ 2 Mb/s	18.9	4.3	23.2	30.0	36.0
2412	CCK @ 5.5 Mb/s	19.1	4.3	23.4	30.0	36.0
2437	CCK @ 5.5 Mb/s	20.5	4.3	24.8	30.0	36.0
2462	CCK @ 5.5 Mb/s	18.9	4.3	23.2	30.0	36.0
2412	CCK @ 11 Mb/s	19.1	4.3	23.4	30.0	36.0
2437	CCK @ 11 Mb/s	20.6	4.3	24.9	30.0	36.0
2462	CCK @ 11 Mb/s	18.9	4.3	23.2	30.0	36.0

7.2.4.4. Internal Antenna, Test Configuration #2: Modulation IEEE 802.11g (OFDM)

Frequency (MHz)	Modulation	(full bandwidth) Peak Power at Antenna Terminals (dBm)	Maximum Antenna Gain (dBi)	(full bandwidth) Peak EIRP (dBm)	Limit for Power at Antenna Port (dBm)	Limit for EIRP (dBm)
2412	OFDM @ 9 Mb/s	19.7	4.3	24.0	30.0	36.0
2437	OFDM @ 9 Mb/s	20.2	4.3	24.5	30.0	36.0
2462	OFDM @ 9 Mb/s	20.2	4.3	24.5	30.0	36.0
2412	OFDM @ 18 Mb/s	19.0	4.3	23.3	30.0	36.0
2437	OFDM @ 18 Mb/s	19.4	4.3	23.7	30.0	36.0
2462	OFDM @ 18 Mb/s	19.5	4.3	23.8	30.0	36.0
2412	OFDM @ 36 Mb/s	18.6	4.3	22.9	30.0	36.0
2437	OFDM @ 36 Mb/s	18.3	4.3	22.6	30.0	36.0
2462	OFDM @ 36 Mb/s	18.7	4.3	23.0	30.0	36.0
2412	OFDM @ 54 Mb/s	17.5	4.3	21.8	30.0	36.0
2437	OFDM @ 54 Mb/s	17.3	4.3	21.6	30.0	36.0
2462	OFDM @ 54 Mb/s	17.4	4.3	21.7	30.0	36.0

7.3. RF EXPOSURE REQUIRMENTS [§§ 15.247(b)(4), 1.1310 & 2.1091]

7.3.1. Limits

- **FCC 15.247(b)(4):** Systems operating under provisions of this section shall be operated in a manner that ensures that the public is not exposed to radio frequency energy levels in excess of the Commission’s guidelines. See @ 1.1307(b)(1).
- **FCC 1.1310:-** The criteria listed in the following table shall be used to evaluate the environmental impact of human exposure to radio-frequency (RF) radiation as specified in 1.1307(b).

LIMITS FOR MAXIMUM PERMISSIBLE EXPOSURE (MPE)

Frequency Range (MHz)	Electric Field Strength (V/m)	Magnetic Field Strength (A/m)	Power Density (mW/cm ²)	Average Time (minutes)
(A) Limits for Occupational/Control Exposures				
1500-100,000	5	6
(B) Limits for General Population/Uncontrolled Exposure				
1500-100,000	1.0	30

F = Frequency in MHz

7.3.2. Method of Measurements

In order to demonstrate compliance with MPE requirements (see Section 2.1091), the following information is typically needed:

- (1) Calculation that estimates the minimum separation distance (20 cm or more) between an antenna and persons required to satisfy power density limits defined for free space.

Calculation Method of RF Safety Distance:

$$S = PG/4\pi r^2 = EIRP/4\pi r^2$$

Where: P: power input to the antenna in mW
 EIRP: Equivalent (effective) isotropic radiated power.
 S: power density mW/cm²
 G: numeric gain of antenna relative to isotropic radiator
 r: distance to centre of radiation in cm

$$r = \sqrt{PG/4\pi S}$$

- (2) Antenna installation and device operating instructions for installers (professional/unskilled users), and the parties responsible for ensuring compliance with the RF exposure requirement
- (3) Any caution statements and/or warning labels that are necessary in order to comply with the exposure limits
- (4) Any other RF exposure related issues that may affect MPE compliance

7.3.3. Test Data

Frequency (MHz)	Highest Conducted Peak Power at the Antenna Terminal (dBm)	Maximum Antenna Gain (dBi)	Maximum Measured Total EIRP (dBm)	Minimum RF Safety Distance r (cm)
External Antenna				
2412 – 2462	20.7	4.0	24.7	4.8
Internal Antenna				
2412 – 2462	20.6	4.3	24.9	5.0

Note: RF EXPOSURE DISTANCE LIMITS: $r = (PG/4\Pi S)^{1/2} = (EIRP/4\Pi S)^{1/2}$
 Limits for General Population/Uncontrolled Exposure: **S = 1.0 mW/cm²**

Evaluation of RF Exposure Compliance Requirements	
RF Exposure Requirements	Compliance with FCC Rules
Minimum calculated separation distance between antenna and persons: 5.0 cm	Manufacturer' instruction for separation distance between antenna and persons required: 20 cm.
Antenna installation and device operating instructions for installers (professional/unskilled users), and the parties responsible for ensuring compliance with the RF exposure requirement	N/A
Caution statements and/or warning labels that are necessary in order to comply with the exposure limits	Refer to user's manual for RF Exposure information.
Any other RF exposure related issues that may affect MPE compliance	N/A

7.4. TRANSMITTER BAND-EDGE & SPURIOUS EMISSIONS (CONDUCTED) [§ 15.247(c)]

7.4.1. Limits

In any 100 KHz bandwidth outside the operating frequency band, the radio frequency power that is produced by modulation products of the spreading sequence, the information sequence and the carrier frequency shall be at least 20 dB below that in any 100 KHz bandwidth within the band that contains the highest level of the desired power.

7.4.2. Method of Measurements

Refer to Exhibit 10, Section 10.4 of this test report, FCC 15.247(c) & ANSI C63.4

7.4.3. Test Arrangement

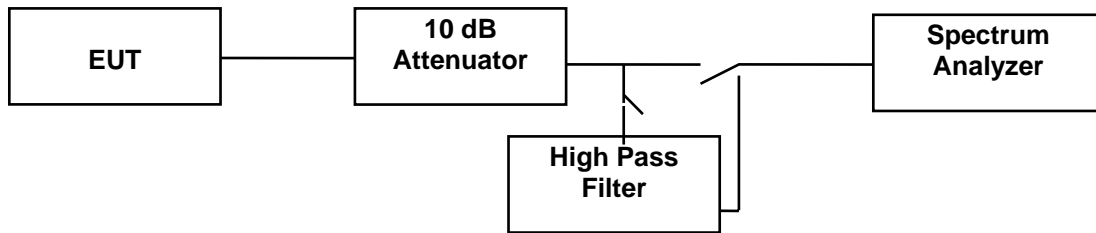

7.4.4. Test Equipment List

Test Instruments	Manufacturer	Model No.	Serial No.	Frequency Range
Spectrum Analyzer	Rohde & Schwarz	FSEK20/B4/B21	834157/005	9 kHz – 40 GHz
High Pass Filter	K & L	11SH10-4000T/T12000-0/0	4	DC kHz – 26 GHz

7.4.5. Test Data

7.4.5.1. Emissions at the band-edges of the FCC Permitted Band

Please refer to Plots # 7 to 16 for detailed measurements of Band-edge emissions at lower and upper permitted band.

Plot #7: Lower Band-Edge Conducted Emissions
Channel Freq.: 2412 MHz, Modulation: IEEE 802.11b – CCK 11 Mbps

Note: The band-edge emissions were found to be the same for all modulation schemes (BPSK @ 1Mb/s, QPSK @ 2 Mb/s, CCK @ 5.5 Mb/s and 11 Mb/s)

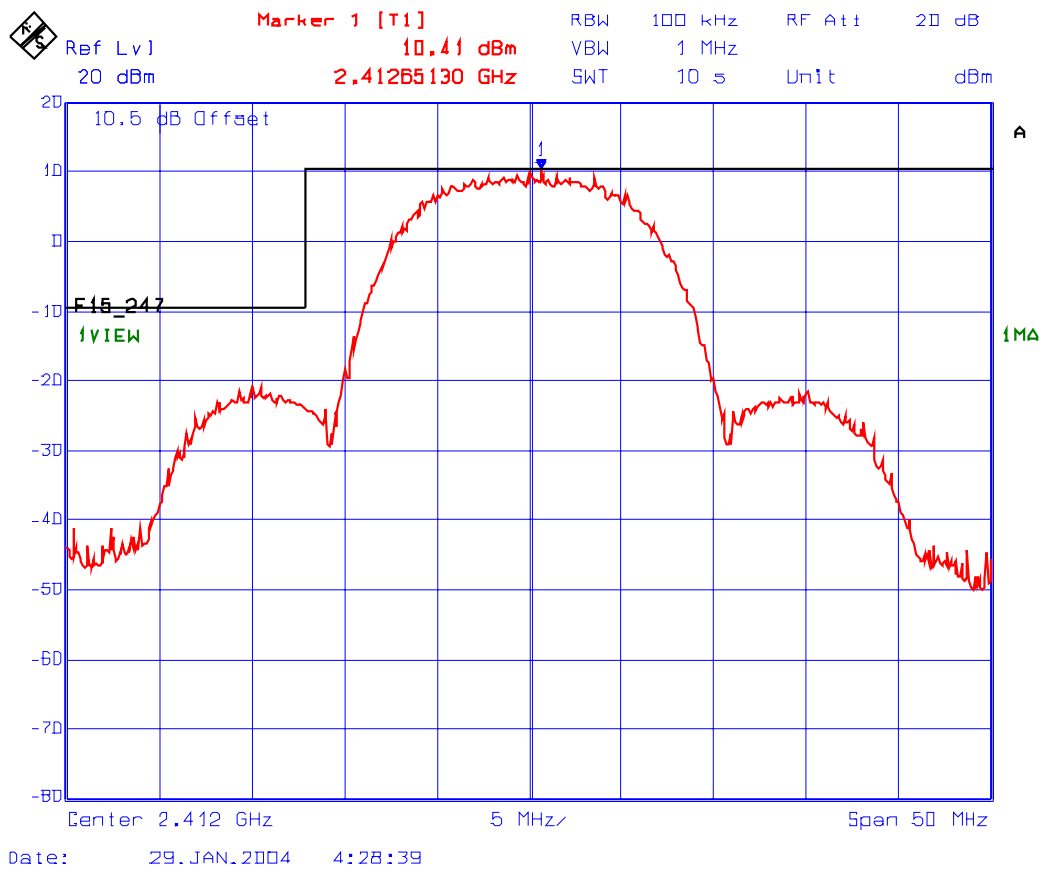

Plot #8: Upper Band-Edge Conducted Emissions
Channel Freq.: 2462 MHz, Modulation: IEEE 802.11b – CCK 11 Mbps

Note: The band-edge emissions were found to be the same for all modulation schemes (BPSK @ 1Mb/s, QPSK @ 2 Mb/s, CCK @ 5.5 Mb/s and 11 Mb/s)

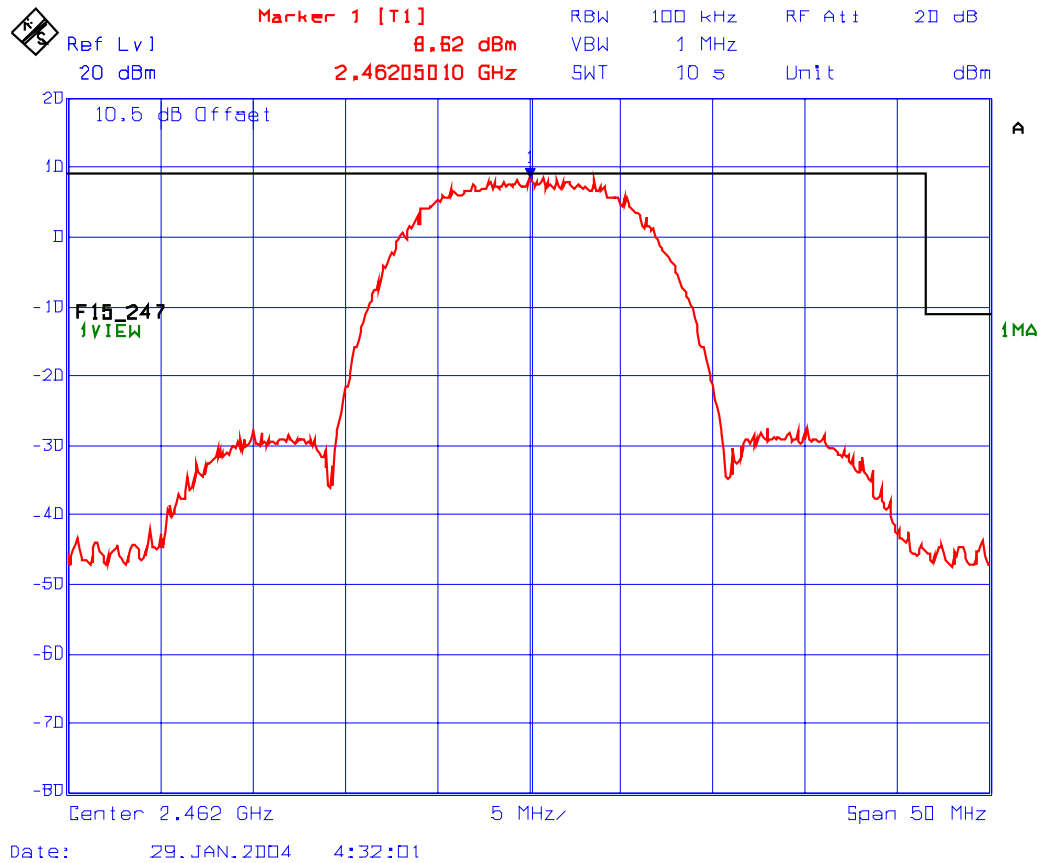

Plot #9: Lower Band-Edge Conducted Emissions
Channel Freq.: 2412 MHz, Modulation: IEEE 802.11g – OFDM @ 9 Mb/s

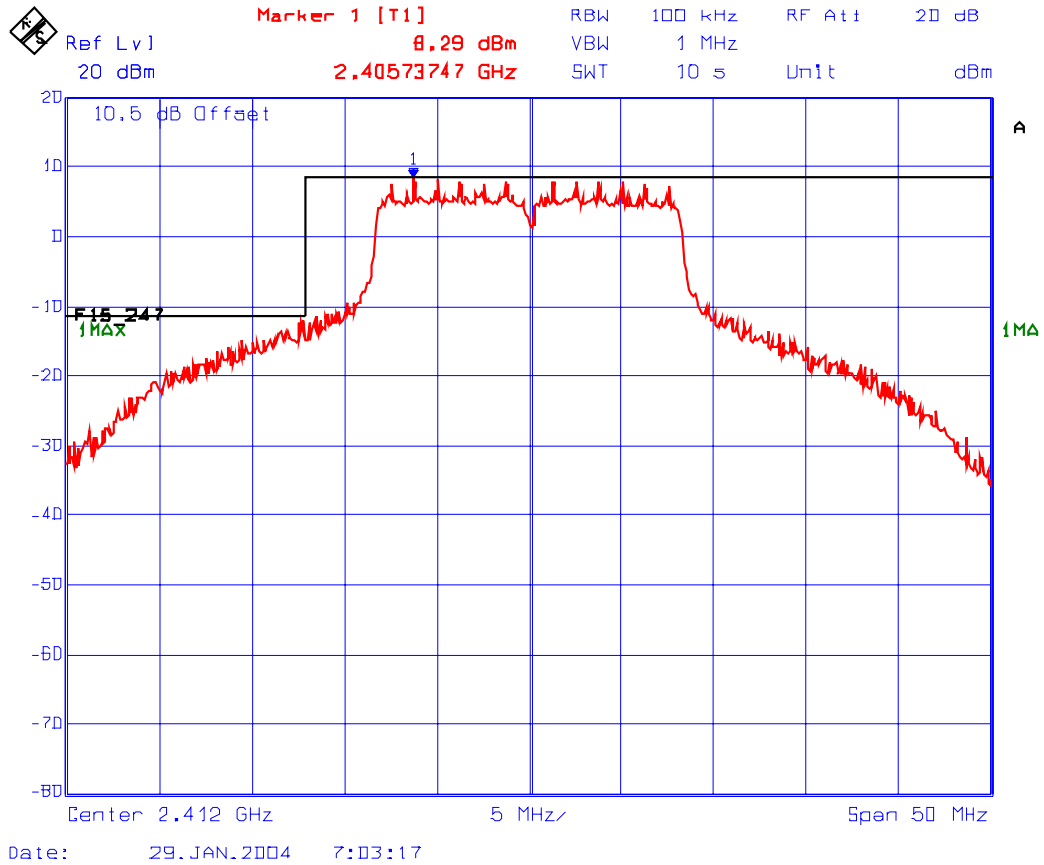

Plot #10: Upper Band-Edge Conducted Emissions
Channel Freq.: 2462 MHz, Modulation: IEEE 802.11g – OFDM @ 9 Mb/s

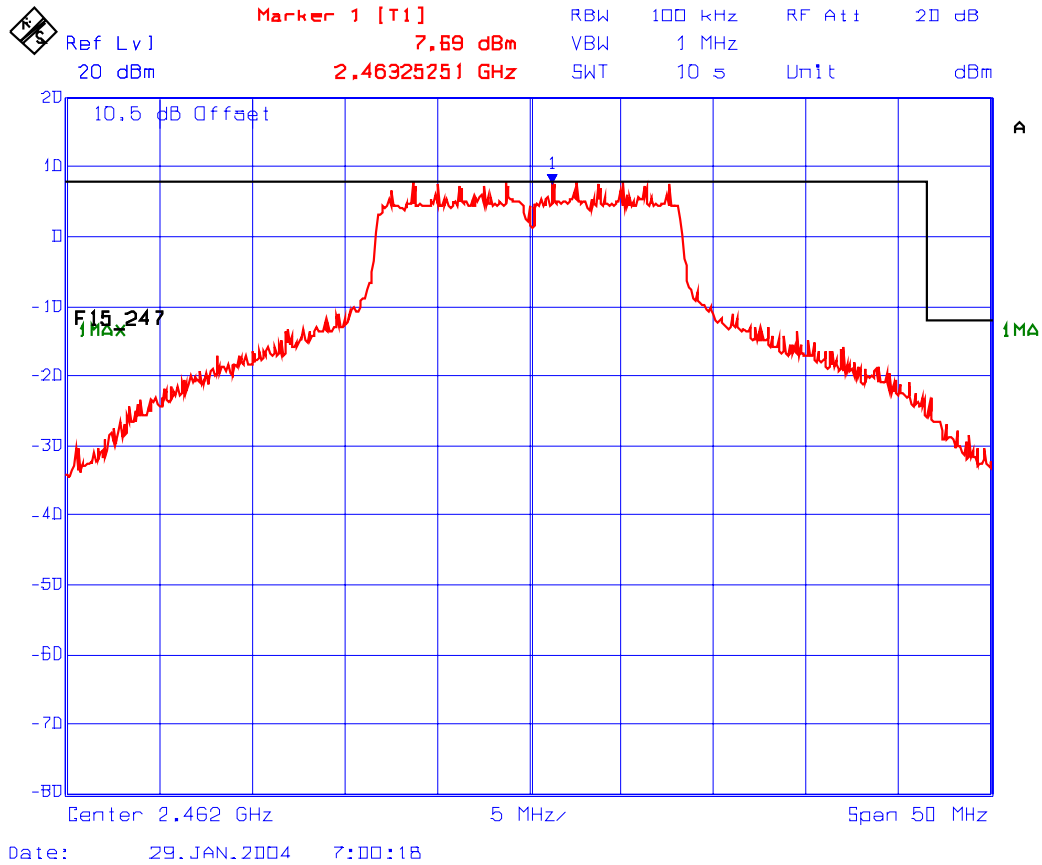

ULTRATECH GROUP OF LABS

3000 Bristol Circle, Oakville, Ontario, Canada L6H 6G4
Tel. #: 905-829-1570, Fax. #: 905-829-8050, Email: vic@ultratech-labs.com, Website: <http://www.ultratech-labs.com>

File #: CNI-027FCC15CE

June 10, 2005

All test results contained in this engineering test report are traceable to National Institute of Standards and Technology (NIST)

Plot #11: Lower Band-Edge Conducted Emissions
Channel Freq.: 2412 MHz, Modulation: IEEE 802.11g – OFDM @ 18 Mb/s

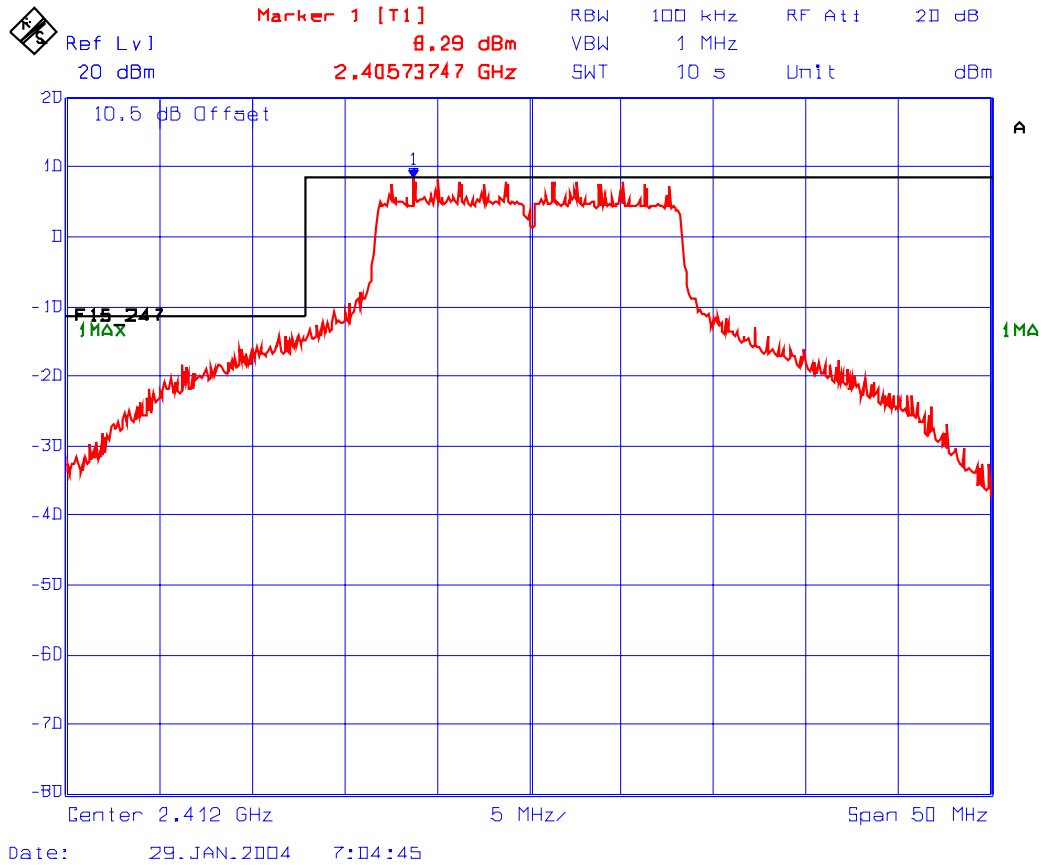

Plot #12: Upper Band-Edge Conducted Emissions
Channel Freq.: 2462 MHz, Modulation: IEEE 802.11g – OFDM @ 18 Mb/s

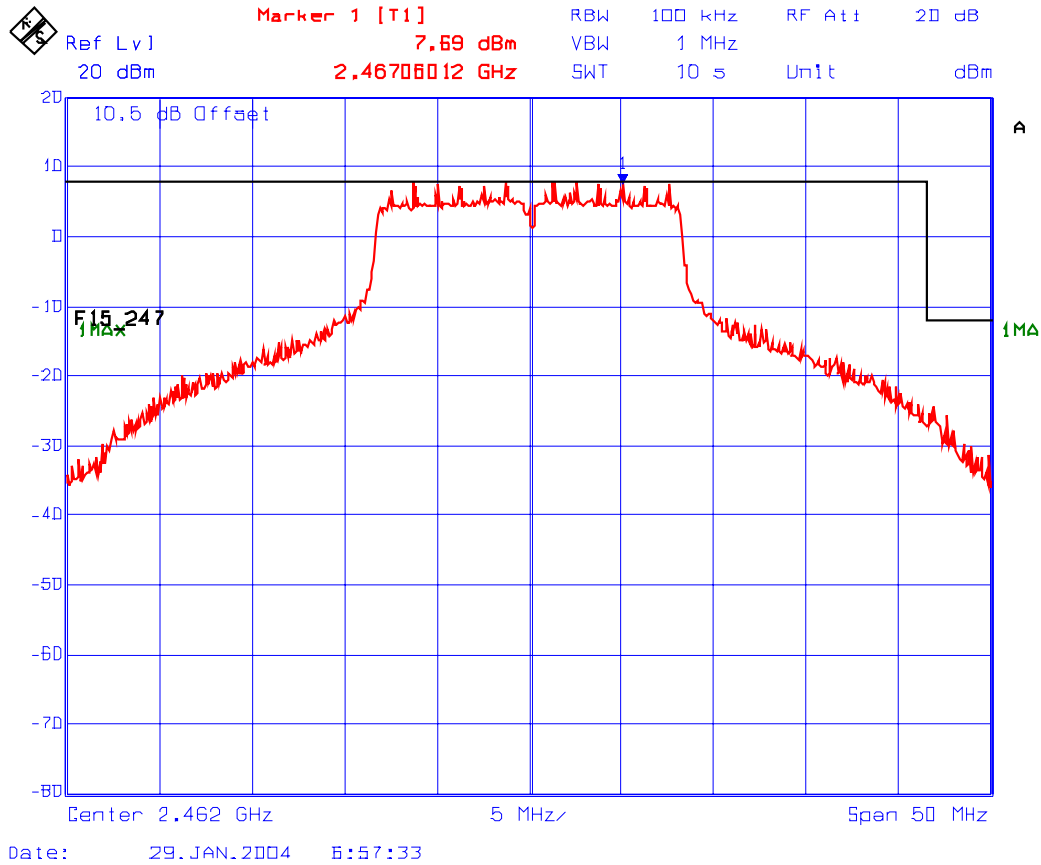

Plot #13: Lower Band-Edge Conducted Emissions
Channel Freq.: 2412 MHz, Modulation: IEEE 802.11g – OFDM @ 36 Mb/s

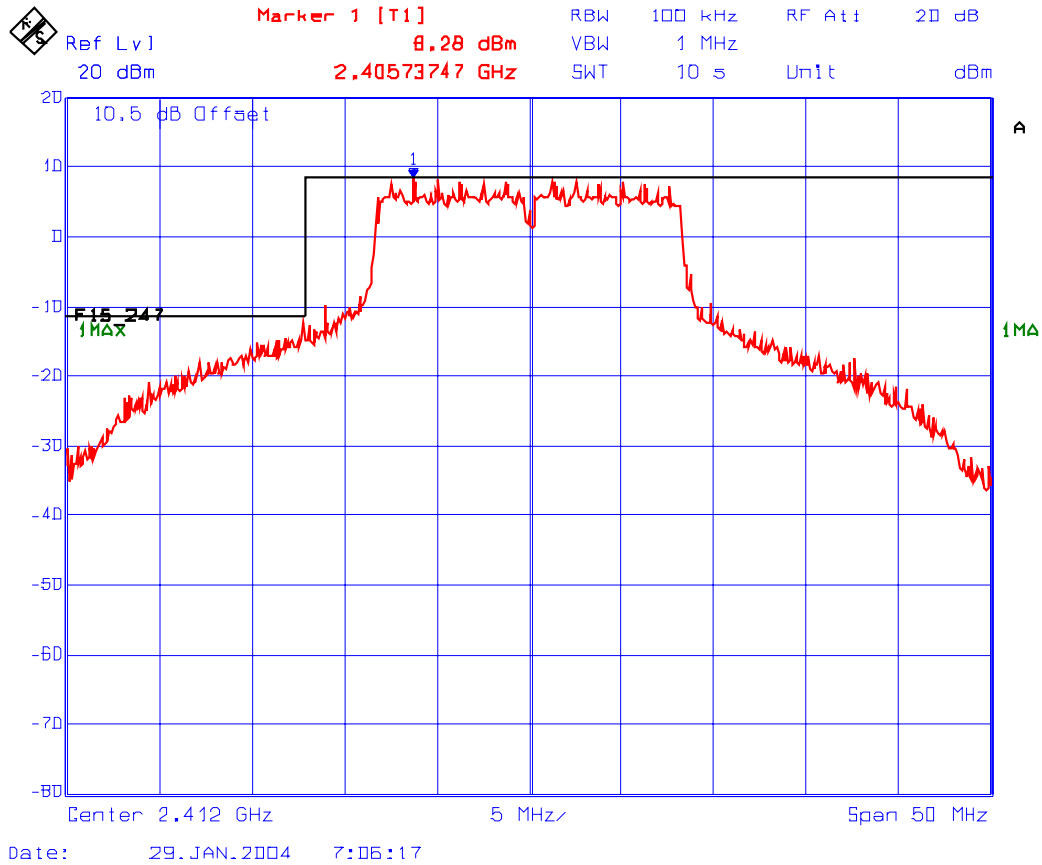

Plot #14: Upper Band-Edge Conducted Emissions
Channel Freq.: 2462 MHz, Modulation: IEEE 802.11g – OFDM @ 36 Mb/s

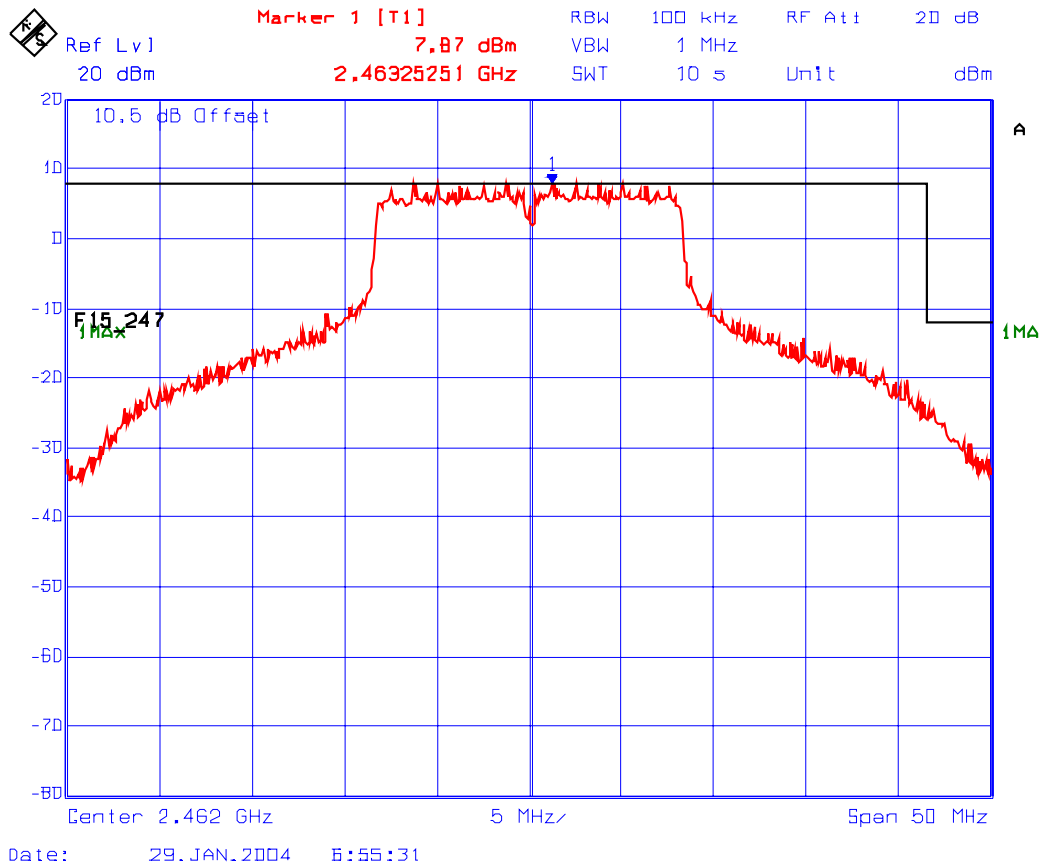

Plot #15: Lower Band-Edge Conducted Emissions
Channel Freq.: 2412 MHz, Modulation: IEEE 802.11g – OFDM @ 54 Mb/s

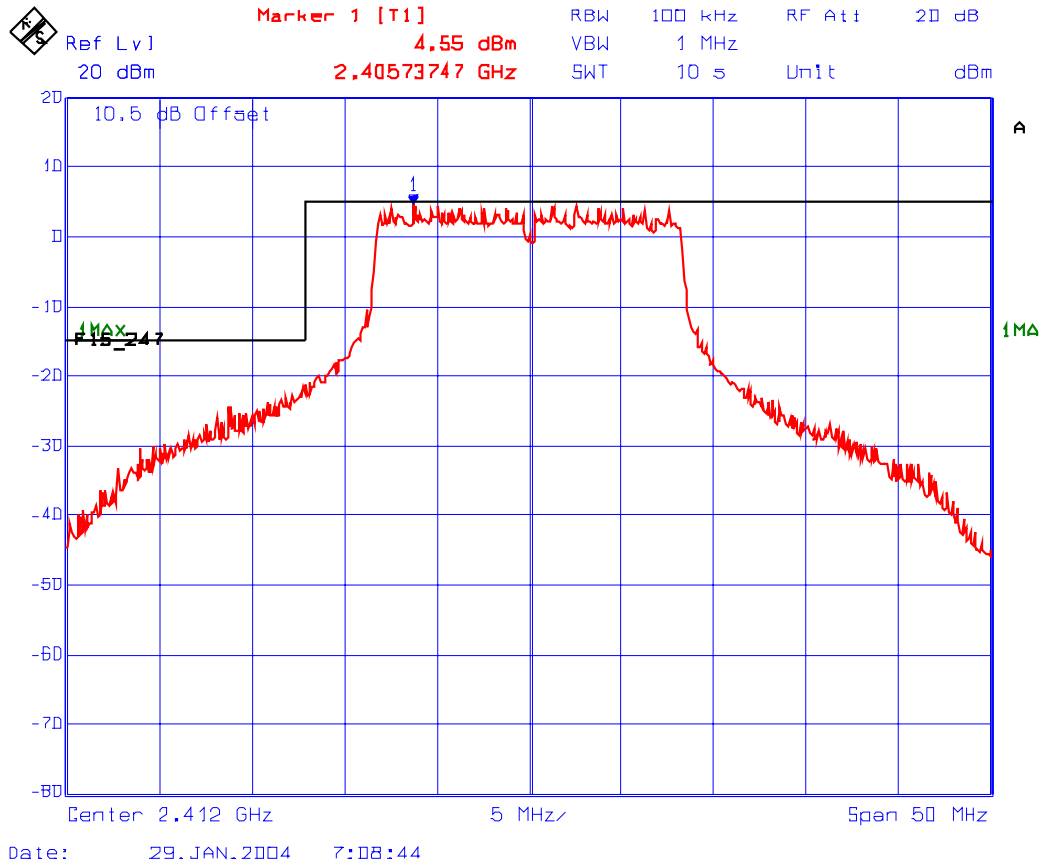

Plot #16: Upper Band-Edge Conducted Emissions
Channel Freq.: 2462 MHz, Modulation: IEEE 802.11g – OFDM @ 54 Mb/s

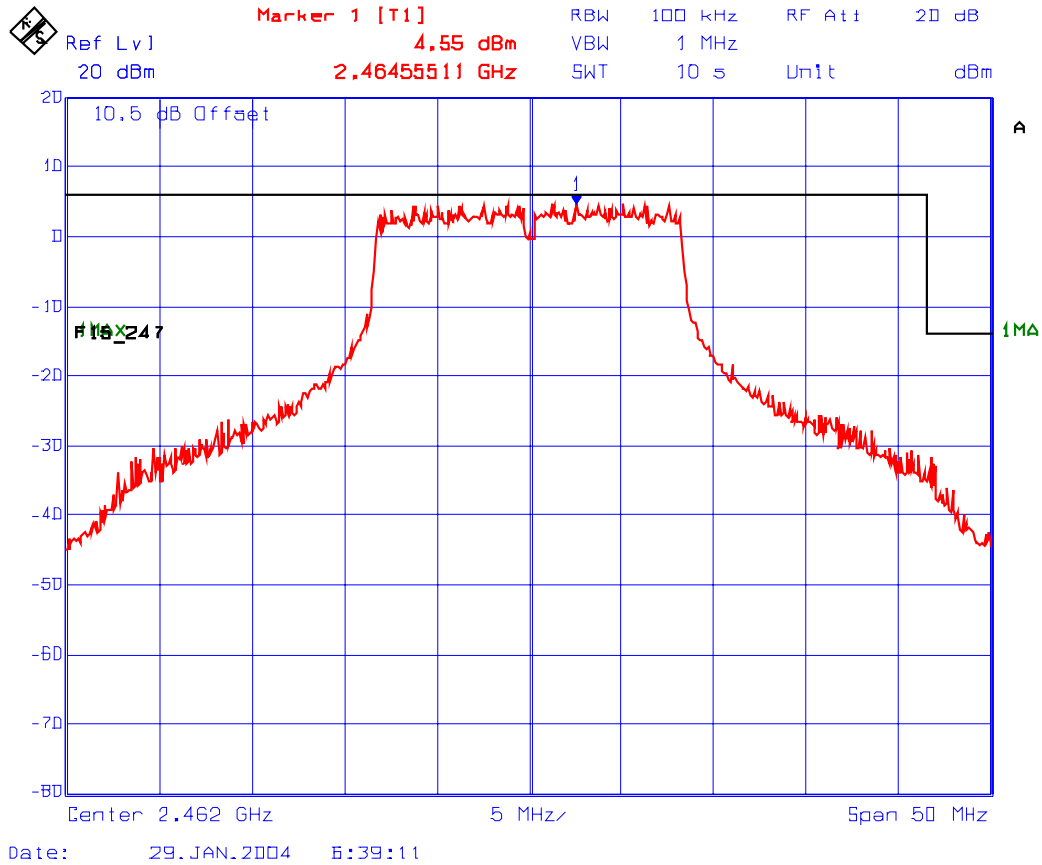

7.4.5.2. Tx Conducted Emissions - Channel Freq.: 2412 MHz, Modulation IEEE 802.11b

The emissions were scanned from 10 MHz to 25 GHz and all RF emissions found in this range are plotted. See the following plots # 17 & 18 for detailed measurements.

Plot #17: Transmitter Spurious Conducted Emissions
Channel Freq.: 2412 MHz, Modulation: IEEE 802.11b
Measurement Conditions: Max hold with Data Rate set to 1, 2, 5.5, and 11 Mbps

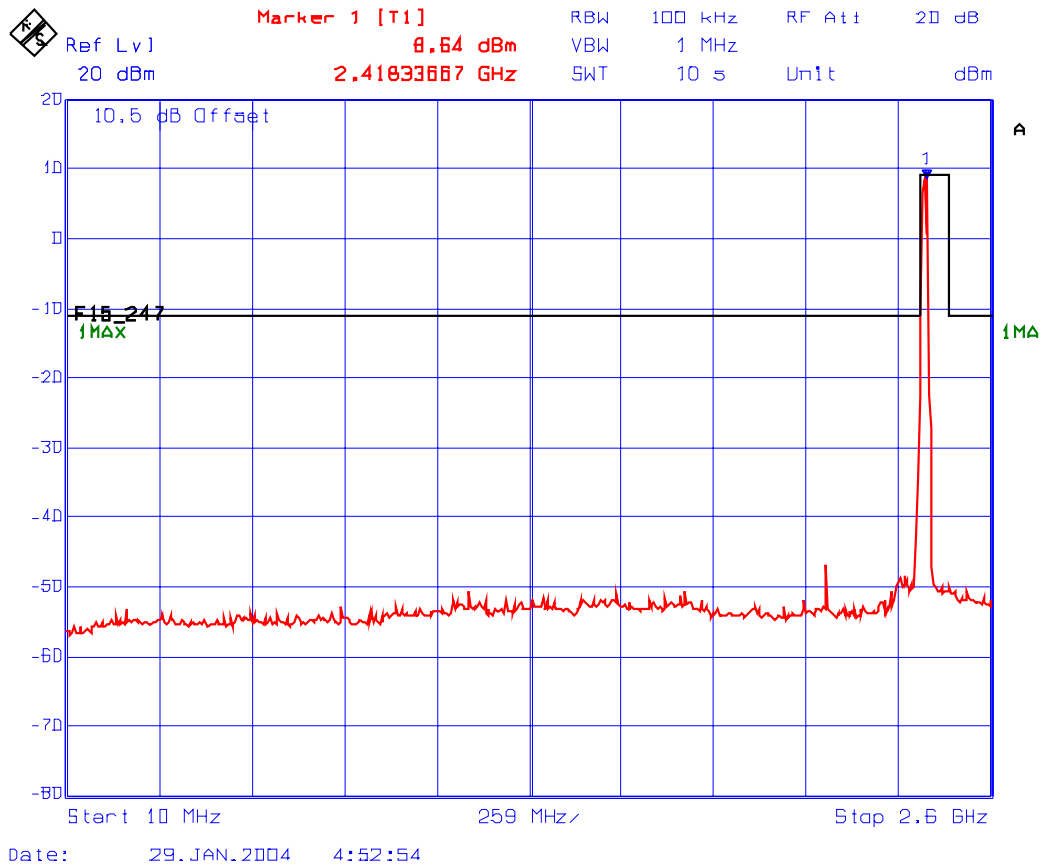

Plot #18: Transmitter Spurious Conducted Emissions
Channel Freq.: 2412 MHz, Modulation: IEEE 802.11b
Measurement Conditions: Max hold with Data Rate set to 1, 2, 5.5, and 11 Mbps

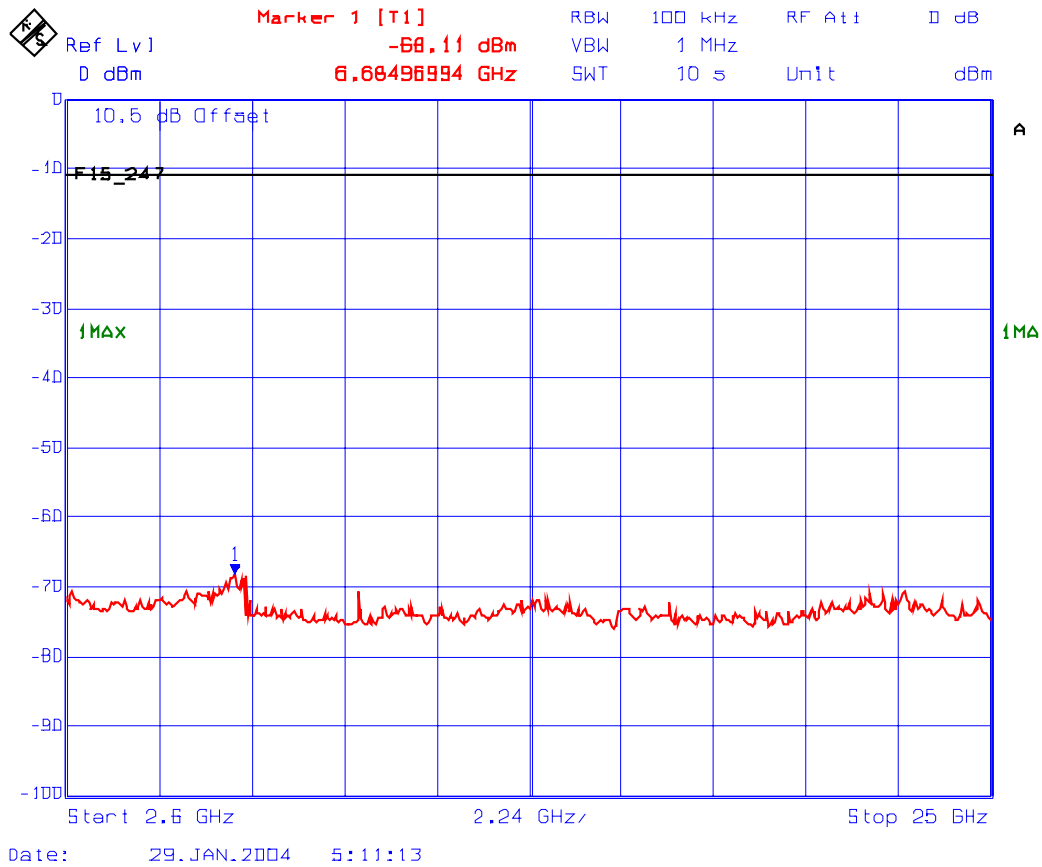

7.4.5.3. Tx Conducted Emissions - Channel Freq.: 2437 MHz, Modulation IEEE 802.11b

The emissions were scanned from 10 MHz to 25 GHz and all RF emissions found in this range are plotted. See the following plots # 19 & 20 for detailed measurements.

Plot #19: Transmitter Spurious Conducted Emissions
Channel Freq.: 2437 MHz, Modulation: IEEE 802.11b
Measurement Conditions: Max hold with Data Rate set to 1, 2, 5.5, and 11 Mbps

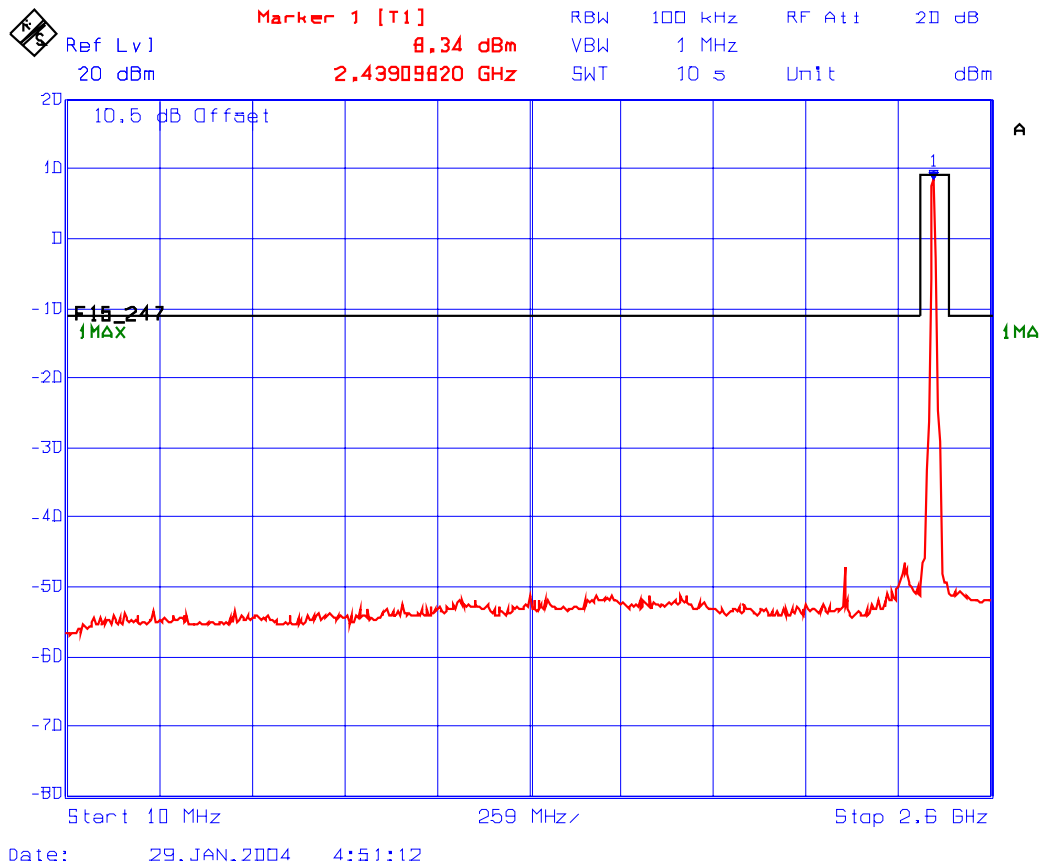

Plot #20: Transmitter Spurious Conducted Emissions
Channel Freq.: 2437 MHz, Modulation: IEEE 802.11b
Measurement Conditions: Max hold with Data Rate set to 1, 2, 5.5, and 11 Mbps

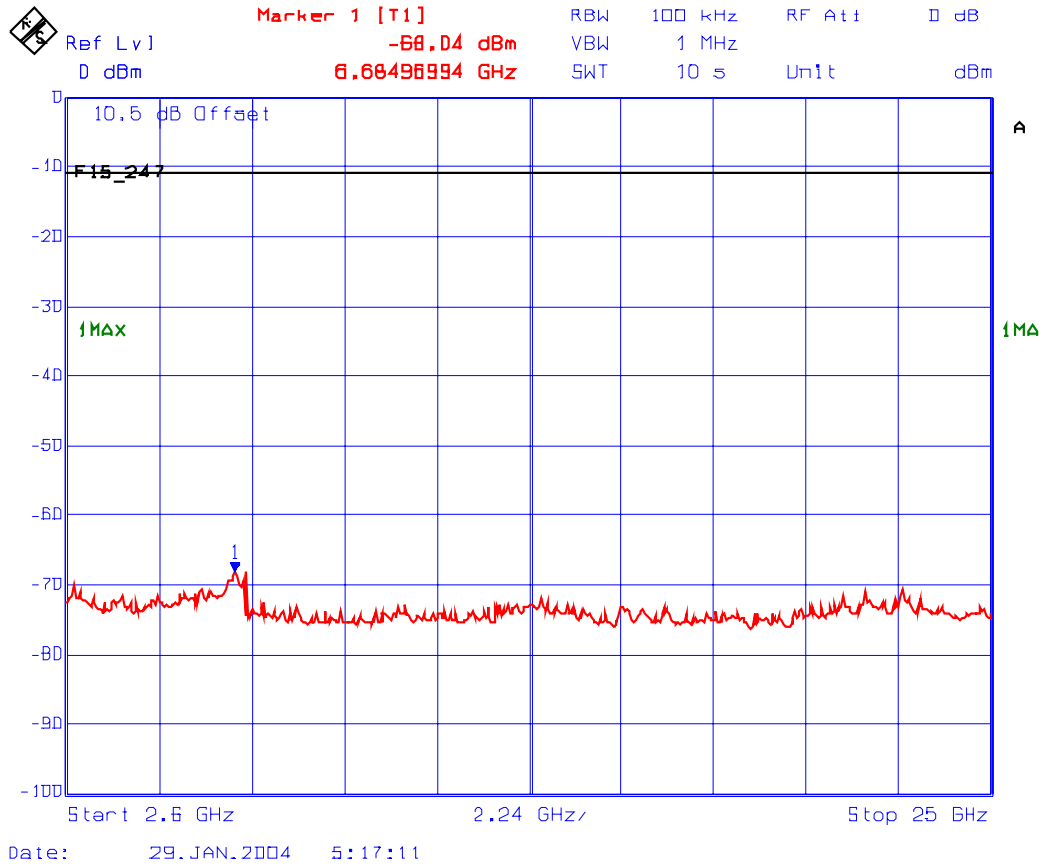

ULTRATECH GROUP OF LABS

3000 Bristol Circle, Oakville, Ontario, Canada L6H 6G4
Tel. #: 905-829-1570, Fax. #: 905-829-8050, Email: vic@ultratech-labs.com, Website: <http://www.ultratech-labs.com>

File #: CNI-027FCC15CE

June 10, 2005

All test results contained in this engineering test report are traceable to National Institute of Standards and Technology (NIST)

7.4.5.4. Tx Conducted Emissions - Channel Freq.: 2462 MHz, Modulation IEEE 802.11b

The emissions were scanned from 10 MHz to 25 GHz and all RF emissions found in this range are plotted. See the following plots # 21 & 22 for detailed measurements.

**Plot #21: Transmitter Spurious Conducted Emissions
Channel Freq.: 2462 MHz, Modulation: IEEE 802.11b
Measurement Conditions: Max hold with Data Rate set to 1, 2, 5.5, and 11 Mbps**

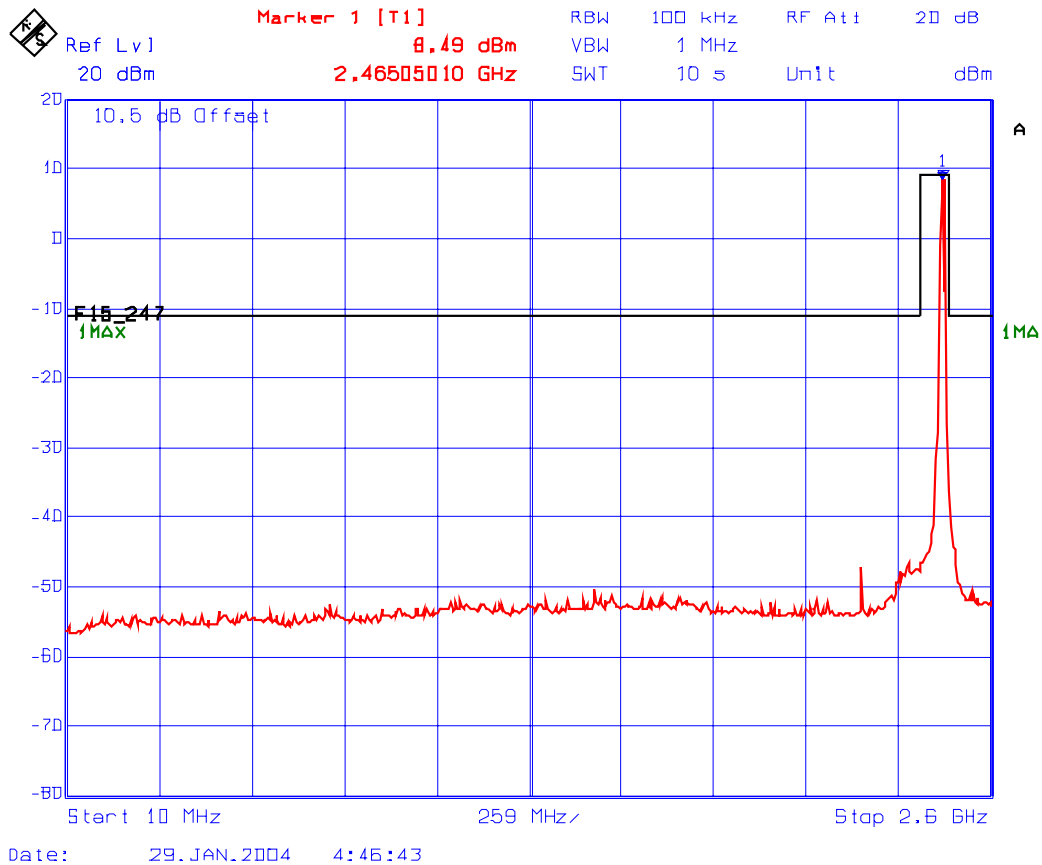

Plot #22: Transmitter Spurious Conducted Emissions
Channel Freq.: 2462 MHz, Modulation: IEEE 802.11b
Measurement Conditions: Max hold with Data Rate set to 1, 2, 5.5, and 11 Mbps

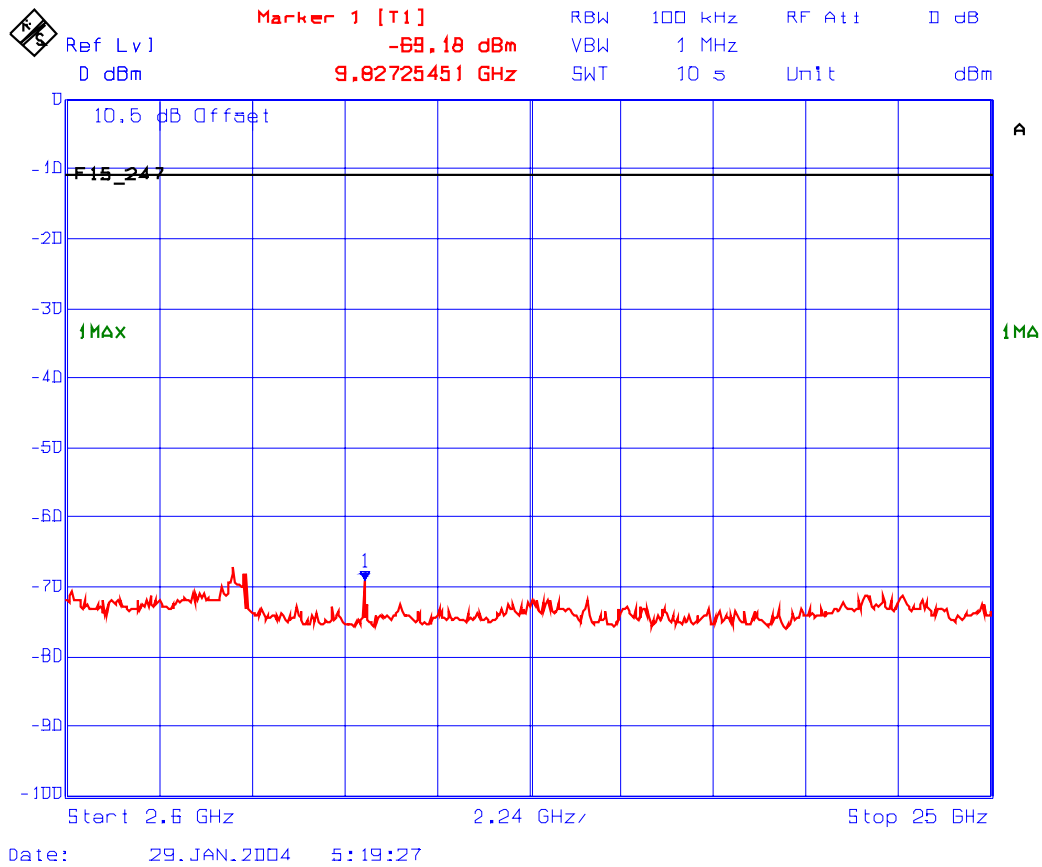

ULTRATECH GROUP OF LABS

3000 Bristol Circle, Oakville, Ontario, Canada L6H 6G4
Tel. #: 905-829-1570, Fax. #: 905-829-8050, Email: vic@ultratech-labs.com, Website: <http://www.ultratech-labs.com>

File #: CNI-027FCC15CE
June 10, 2005

All test results contained in this engineering test report are traceable to National Institute of Standards and Technology (NIST)

7.4.5.5. Tx Conducted Emissions - Channel Freq.: 2412 MHz, Modulation IEEE 802.11g

The emissions were scanned from 10 MHz to 25 GHz and all RF emissions found in this range are plotted. See the following plots # 23 & 24 for detailed measurements.

Plot #23: Transmitter Spurious Conducted Emissions
Channel Freq.: 2412 MHz, Modulation: IEEE 802.11g
Measurement Conditions: Max hold with Data Rate set to 6, 9, 12, 18, 24, 36, 48 and 54Mbps

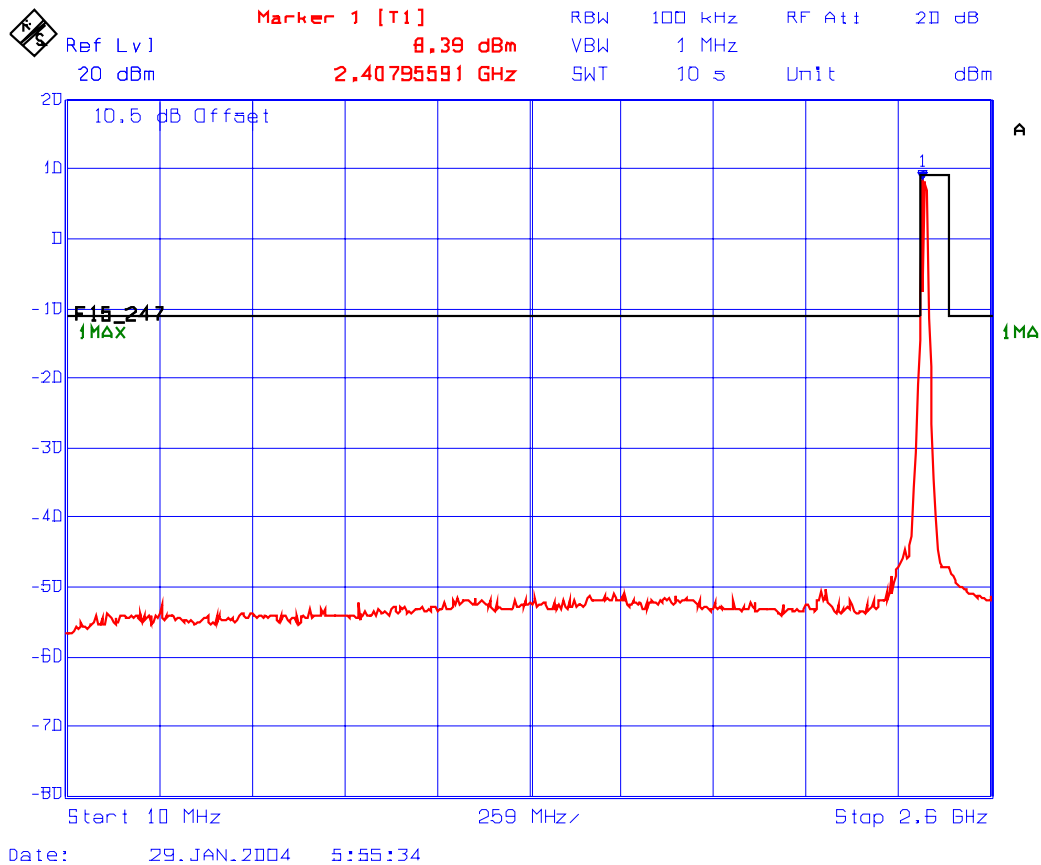

Plot #24: Transmitter Spurious Conducted Emissions
Channel Freq.: 2412 MHz, Modulation: IEEE 802.11g
Measurement Conditions: Max hold with Data Rate set to 6, 9, 12, 18, 24, 36, 48 and 54Mbps

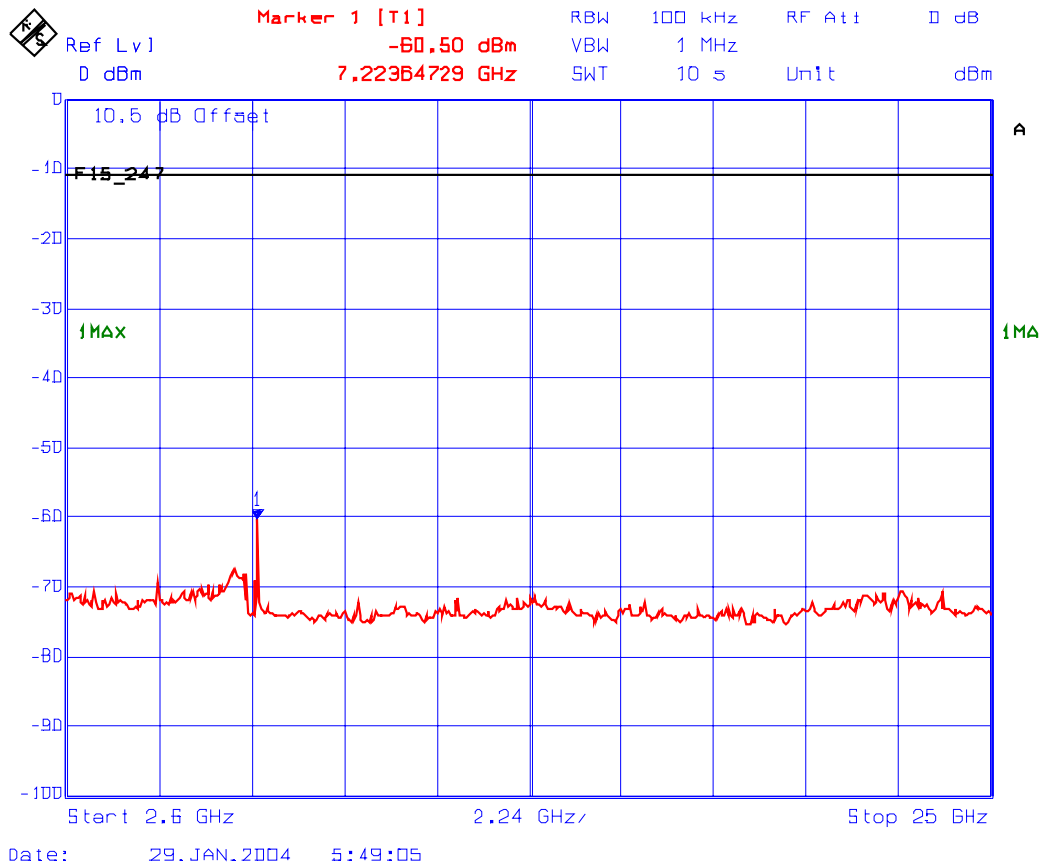

ULTRATECH GROUP OF LABS

3000 Bristol Circle, Oakville, Ontario, Canada L6H 6G4
Tel. #: 905-829-1570, Fax. #: 905-829-8050, Email: vic@ultratech-labs.com, Website: <http://www.ultratech-labs.com>

File #: CNI-027FCC15CE

June 10, 2005

All test results contained in this engineering test report are traceable to National Institute of Standards and Technology (NIST)

7.4.5.6. Tx Conducted Emissions - Channel Freq.: 2437 MHz, Modulation IEEE 802.11g

The emissions were scanned from 10 MHz to 25 GHz and all RF emissions found in this range are plotted. See the following plots # 25 & 26 for detailed measurements.

Plot #25: Transmitter Spurious Conducted Emissions
Channel Freq.: 2437 MHz, Modulation: IEEE 802.11g
Measurement Conditions: Max hold with Data Rate set to 6, 9, 12, 18, 24, 36, 48 and 54Mbps

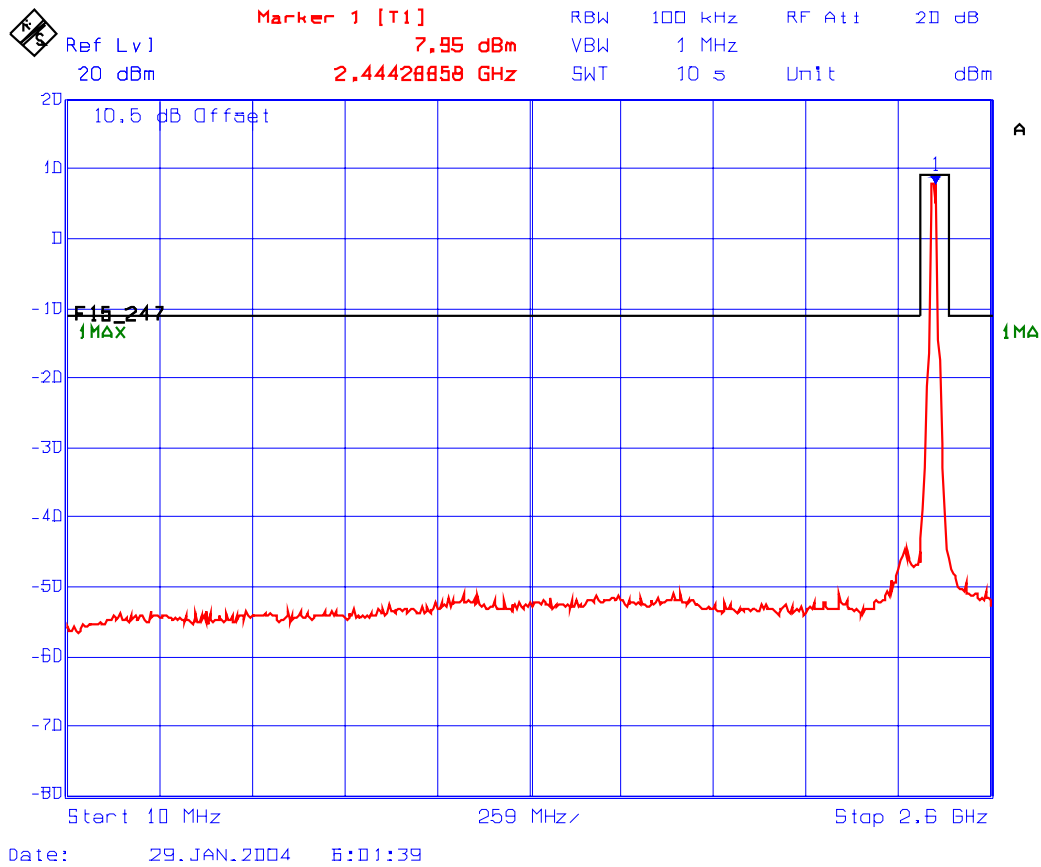

Plot #26: Transmitter Spurious Conducted Emissions
Channel Freq.: 2437 MHz, Modulation: IEEE 802.11g
Measurement Conditions: Max hold with Data Rate set to 6, 9, 12, 18, 24, 36, 48 and 54Mbps

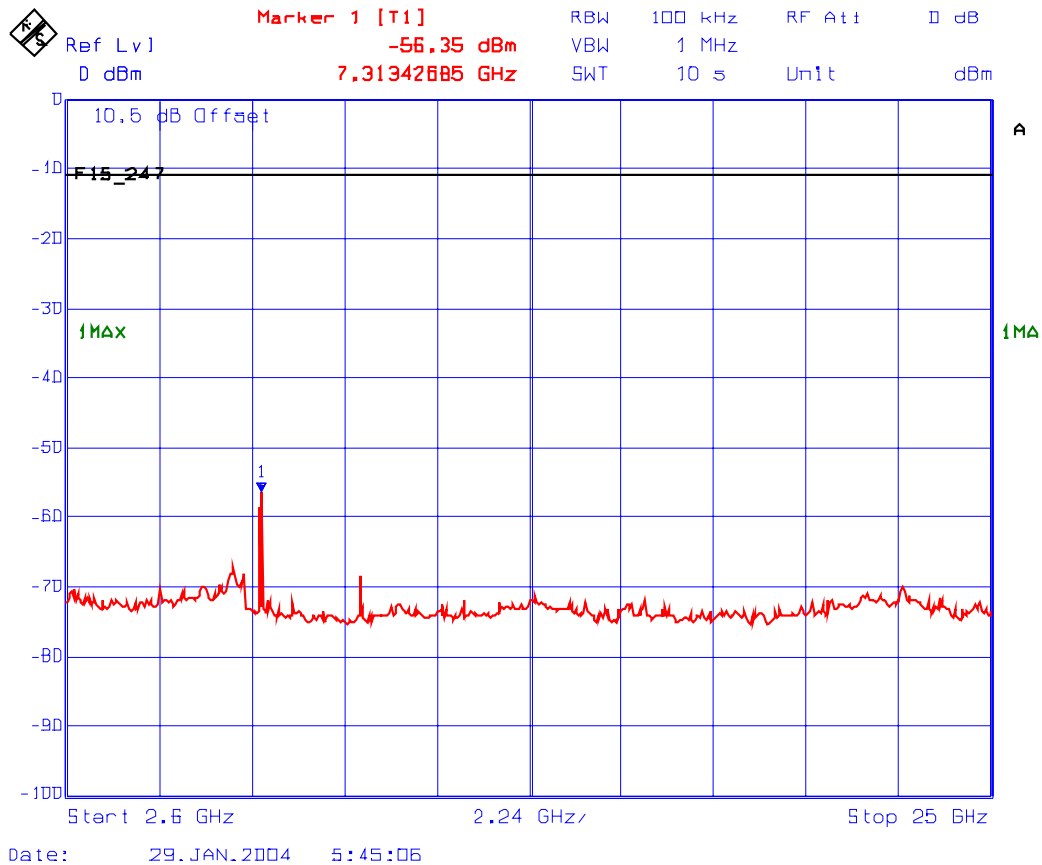

ULTRATECH GROUP OF LABS

3000 Bristol Circle, Oakville, Ontario, Canada L6H 6G4
Tel. #: 905-829-1570, Fax. #: 905-829-8050, Email: vic@ultratech-labs.com, Website: <http://www.ultratech-labs.com>

File #: CNI-027FCC15CE
June 10, 2005

All test results contained in this engineering test report are traceable to National Institute of Standards and Technology (NIST)

7.4.5.7. Tx Conducted Emissions - Channel Freq.: 2462 MHz, Modulation IEEE 802.11g

The emissions were scanned from 10 MHz to 25 GHz and all RF emissions found in this range are plotted. See the following plots # 27 & 28 for detailed measurements.

Plot #27: Transmitter Spurious Conducted Emissions
Channel Freq.: 2462 MHz, Modulation: IEEE 802.11g
Measurement Conditions: Max hold with Data Rate set to 6, 9, 12, 18, 24, 36, 48 and 54Mbps

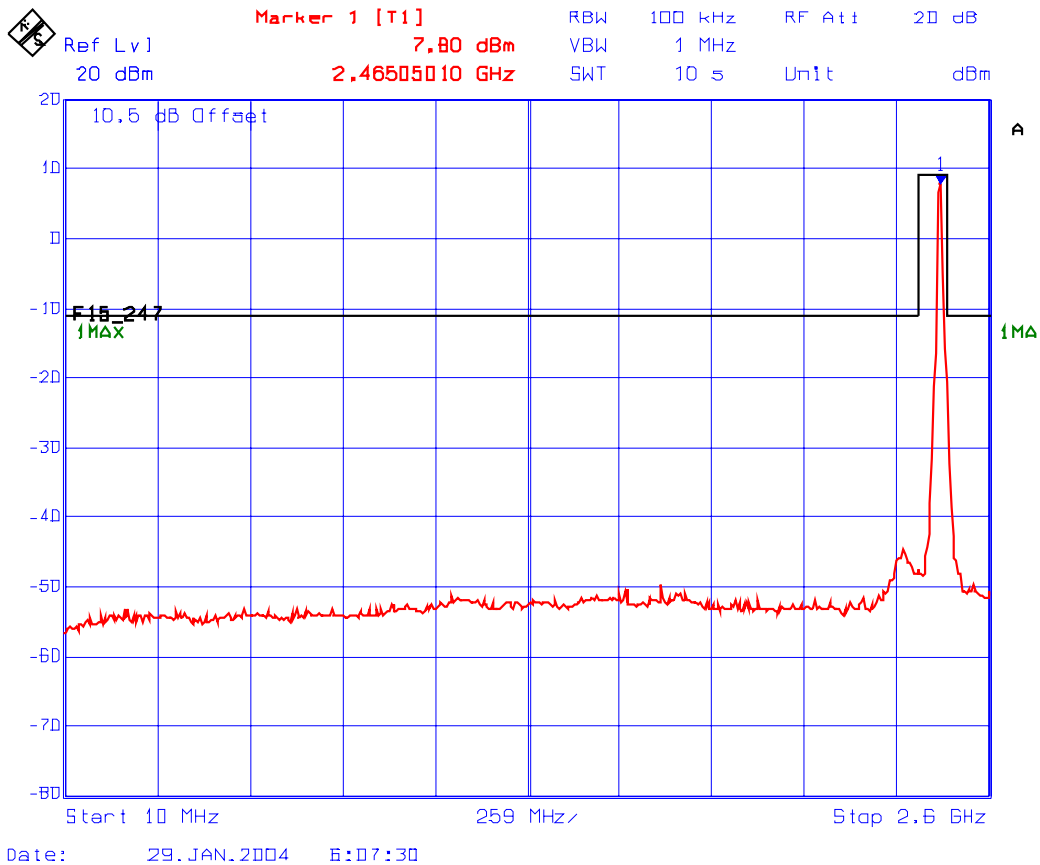

Plot #28: Transmitter Spurious Conducted Emissions
Channel Freq.: 2462 MHz, Modulation: IEEE 802.11g
Measurement Conditions: Max hold with Data Rate set to 6, 9, 12, 18, 24, 36, 48 and 54Mbps

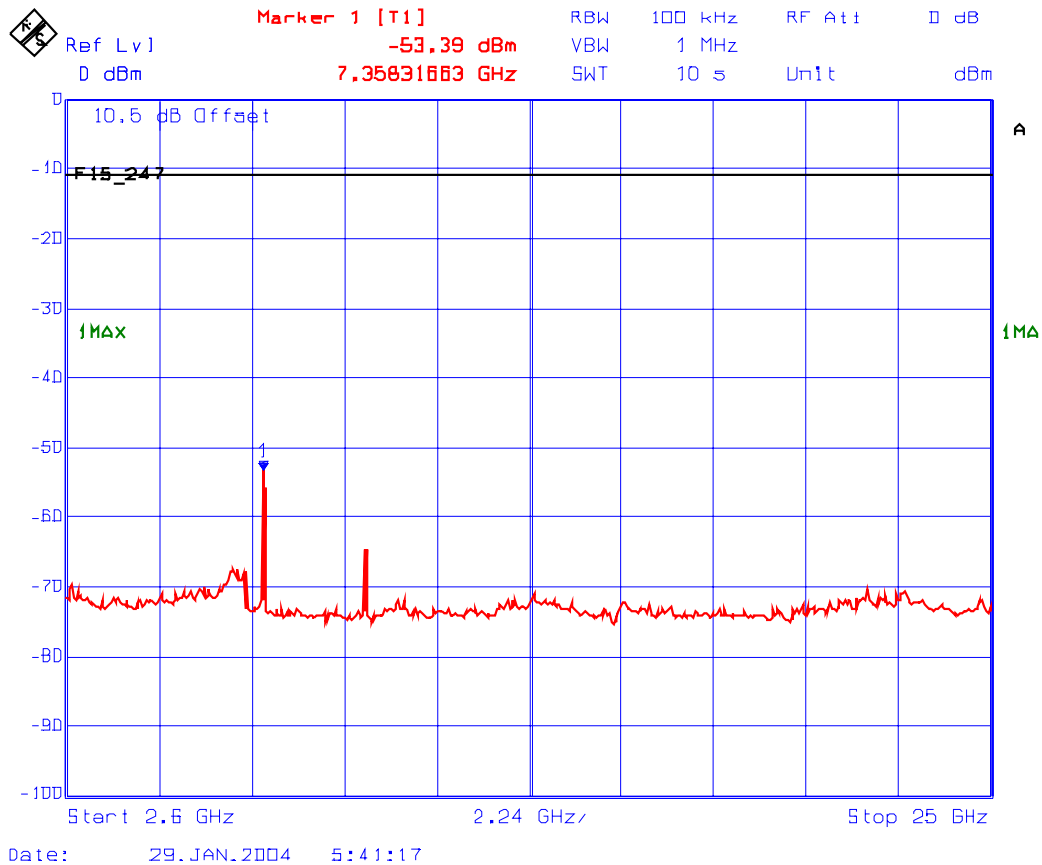

ULTRATECH GROUP OF LABS

3000 Bristol Circle, Oakville, Ontario, Canada L6H 6G4
Tel. #: 905-829-1570, Fax. #: 905-829-8050, Email: vic@ultratech-labs.com, Website: <http://www.ultratech-labs.com>

File #: CNI-027FCC15CE

June 10, 2005

All test results contained in this engineering test report are traceable to National Institute of Standards and Technology (NIST)

7.5. TRANSMITTED POWER DENSITY OF A DIGITAL MODULATION SYSTEM [§ 15.247(d)]

7.5.1. Limits

For a direct sequence system, the transmitted power density average over any 1 second interval shall not be greater than 8 dBm in any 3 KHz bandwidth within this band.

7.5.2. Method of Measurements

Refer to Exhibit 10, Section 10.6 of this test report for detailed measurement procedures

7.5.3. Test Arrangement

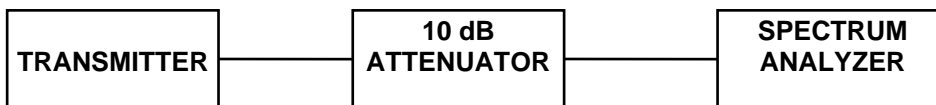

7.5.4. Test Equipment List

Test Instruments	Manufacturer	Model No.	Serial No.	Frequency Range
Spectrum Analyzer	Rohde & Schwarz	FSEK20/B4/B21	834157/005	9 kHz – 40 GHz

7.5.5. Test Data

Modulation Scheme: IEEE 802.11b					
Channel Frequency (MHz)	Modulation Data Rate	RF Power Level in 3 KHz BW (dBm)	Limit (dBm)	Margin (dB)	Comments (Pass/Fail)
2412	DBPSK 1 Mbps	-3.8	8.0	-11.8	Pass
2437	DBPSK 1 Mbps	-3.4	8.0	-11.4	Pass
2462	DBPSK 1 Mbps	-2.7	8.0	-10.7	Pass
2412	DQPSK 2 Mbps	-3.3	8.0	-11.3	Pass
2437	DQPSK 2 Mbps	-3.6	8.0	-11.6	Pass
2462	DQPSK 2 Mbps	-2.9	8.0	-10.9	Pass
2412	CCK 5.5 Mbps	-0.5	8.0	-8.5	Pass
2437	DQPSK 1 Mbps	-1.2	8.0	-9.2	Pass
2462	CCK 5.5 Mbps	-0.3	8.0	-8.3	Pass
2412	CCK 11 Mbps	-0.2	8.0	-8.2	Pass
2437	CCK 11 Mbps	-1.0	8.0	-9.0	Pass
2462	CCK 11 Mbps	-0.3	8.0	-8.3	Pass

Refer to Plots # 29 to 40 for detailed of measurements

Plot #29: Transmitter Power Spectral Density
Channel Freq.: 2412 MHz,
Modulation: IEEE 802.11b – BPSK @ 1 Mb/s long data rate

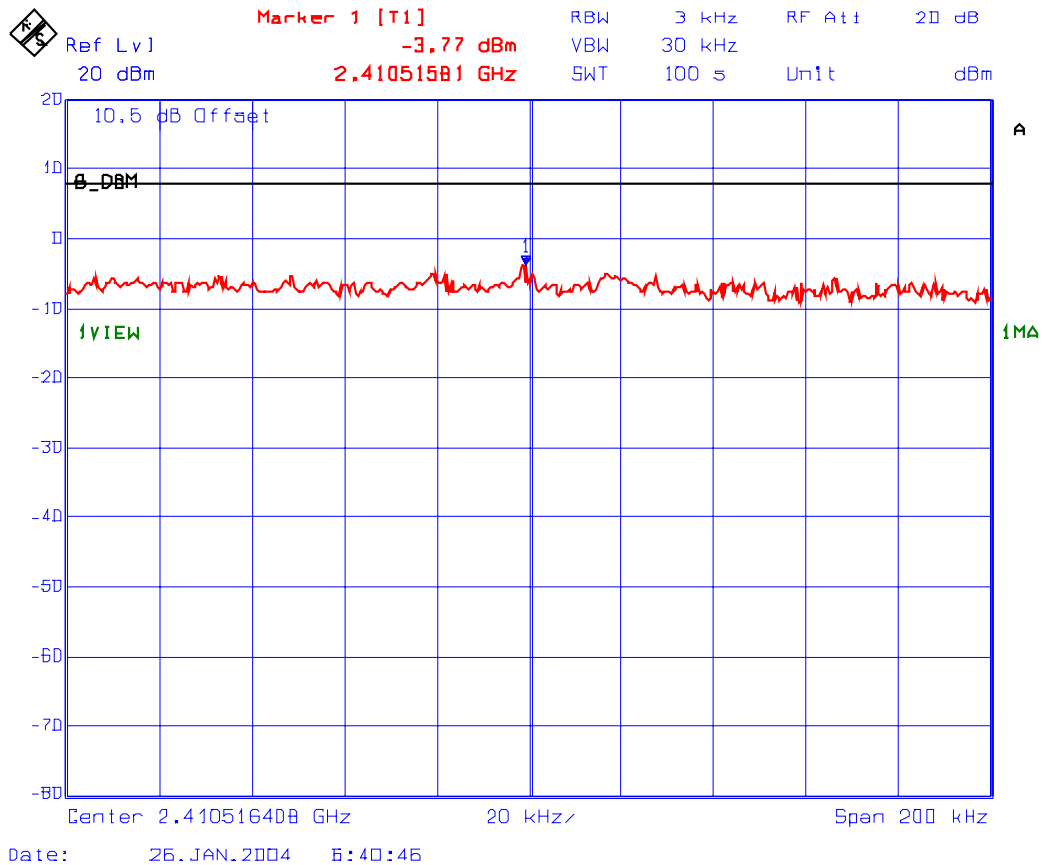

ULTRATECH GROUP OF LABS

3000 Bristol Circle, Oakville, Ontario, Canada L6H 6G4
Tel. #: 905-829-1570, Fax. #: 905-829-8050, Email: vic@ultratech-labs.com, Website: <http://www.ultratech-labs.com>

File #: CNI-027FCC15CE
June 10, 2005

All test results contained in this engineering test report are traceable to National Institute of Standards and Technology (NIST)

Plot #30: Transmitter Power Spectral Density
Channel Freq.: 2437 MHz,
Modulation: IEEE 802.11b – BPSK @ 1 Mb/s long data rate

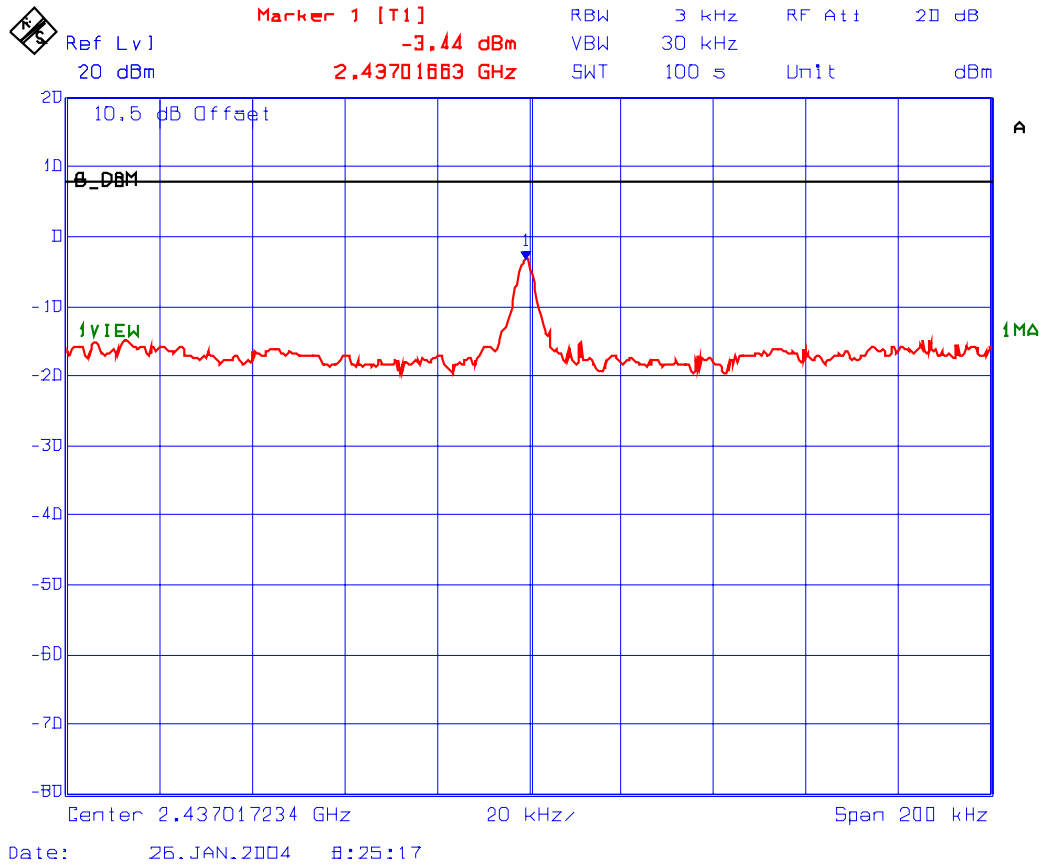

ULTRATECH GROUP OF LABS

3000 Bristol Circle, Oakville, Ontario, Canada L6H 6G4
Tel. #: 905-829-1570, Fax. #: 905-829-8050, Email: vic@ultratech-labs.com, Website: <http://www.ultratech-labs.com>

File #: CNI-027FCC15CE

June 10, 2005

All test results contained in this engineering test report are traceable to National Institute of Standards and Technology (NIST)

Plot #31: Transmitter Power Spectral Density
Channel Freq.: 2462 MHz,
Modulation: IEEE 802.11b – BPSK @ 1 Mb/s long data rate

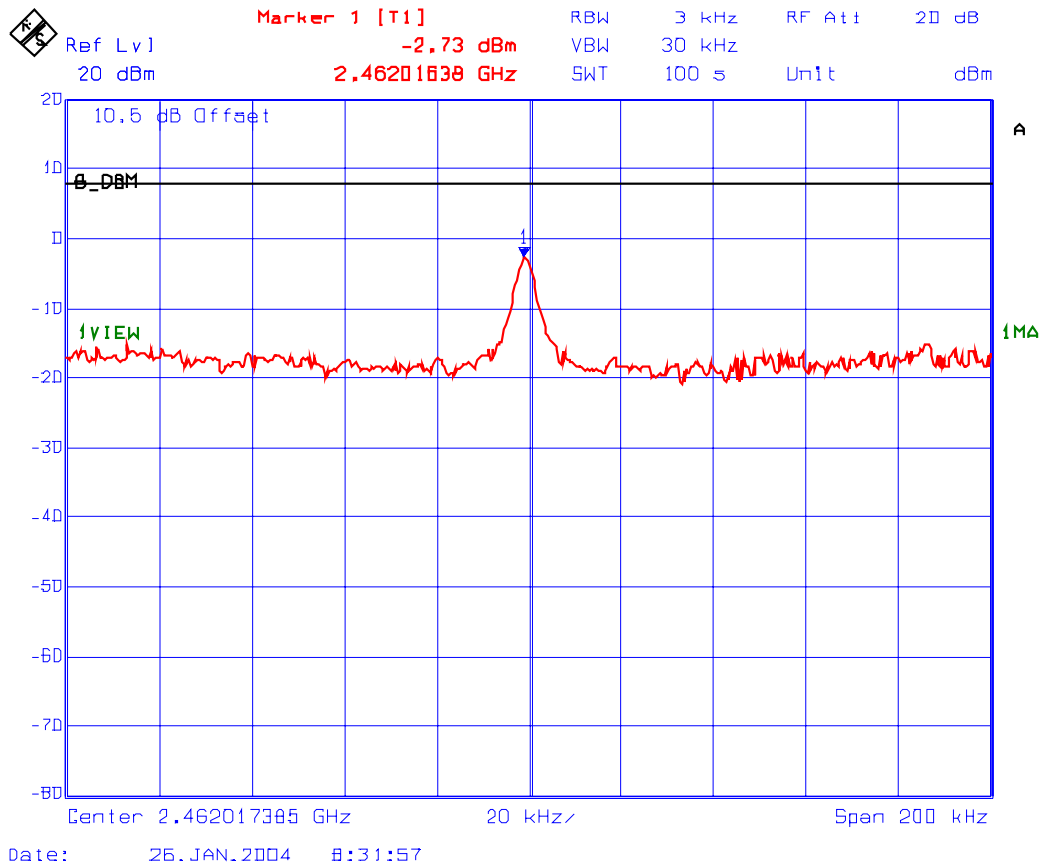

Plot #32: Transmitter Power Spectral Density
Channel Freq.: 2412 MHz,
Modulation: IEEE 802.11b – QPSK @ 2 Mb/s long data rate

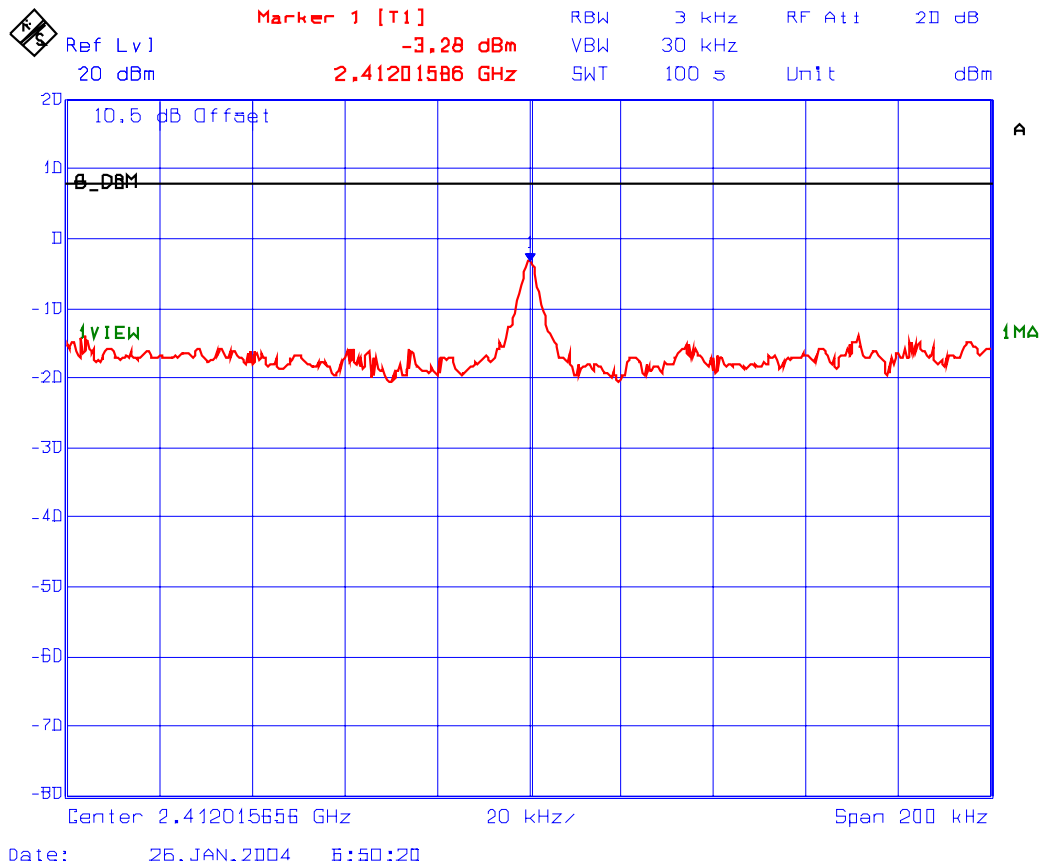

ULTRATECH GROUP OF LABS

3000 Bristol Circle, Oakville, Ontario, Canada L6H 6G4
Tel. #: 905-829-1570, Fax. #: 905-829-8050, Email: vic@ultratech-labs.com, Website: <http://www.ultratech-labs.com>

File #: CNI-027FCC15CE

June 10, 2005

All test results contained in this engineering test report are traceable to National Institute of Standards and Technology (NIST)

Plot #33: Transmitter Power Spectral Density
Channel Freq.: 2437 MHz,
Modulation: IEEE 802.11b – QPSK @ 2 Mb/s long data rate

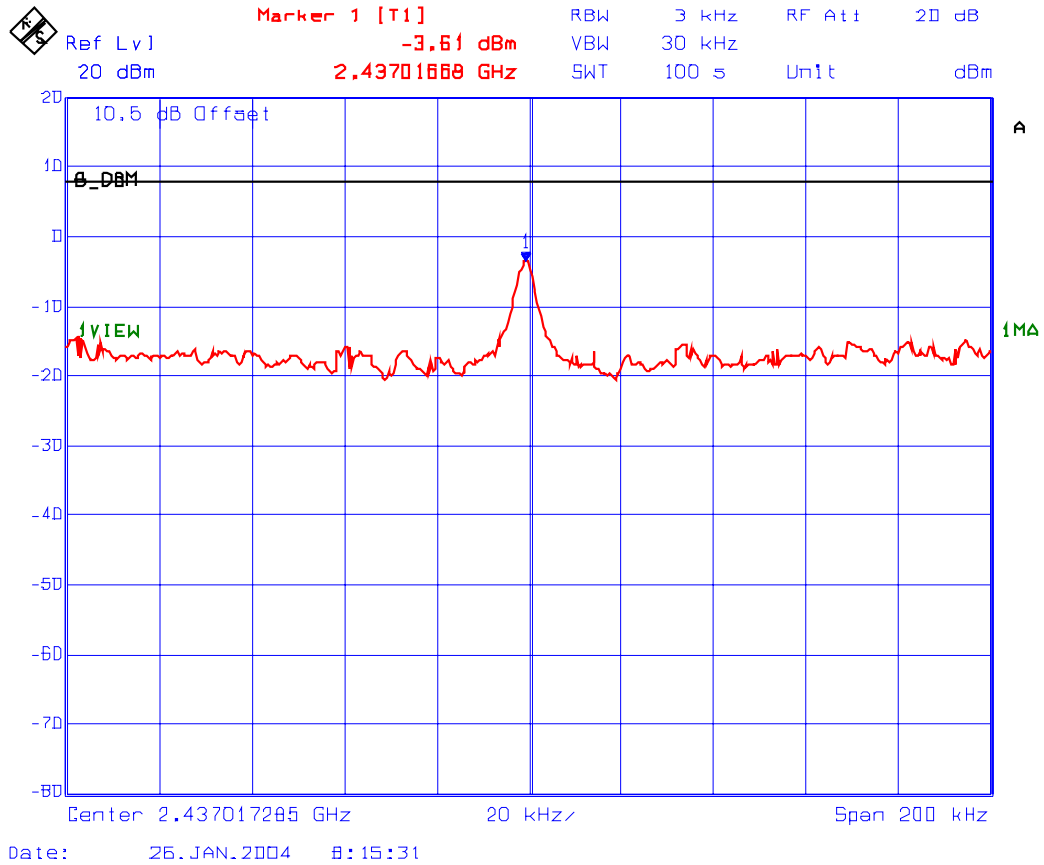

Plot #34: Transmitter Power Spectral Density
Channel Freq.: 2462 MHz,
Modulation: IEEE 802.11b – QPSK @ 2 Mb/s long data rate

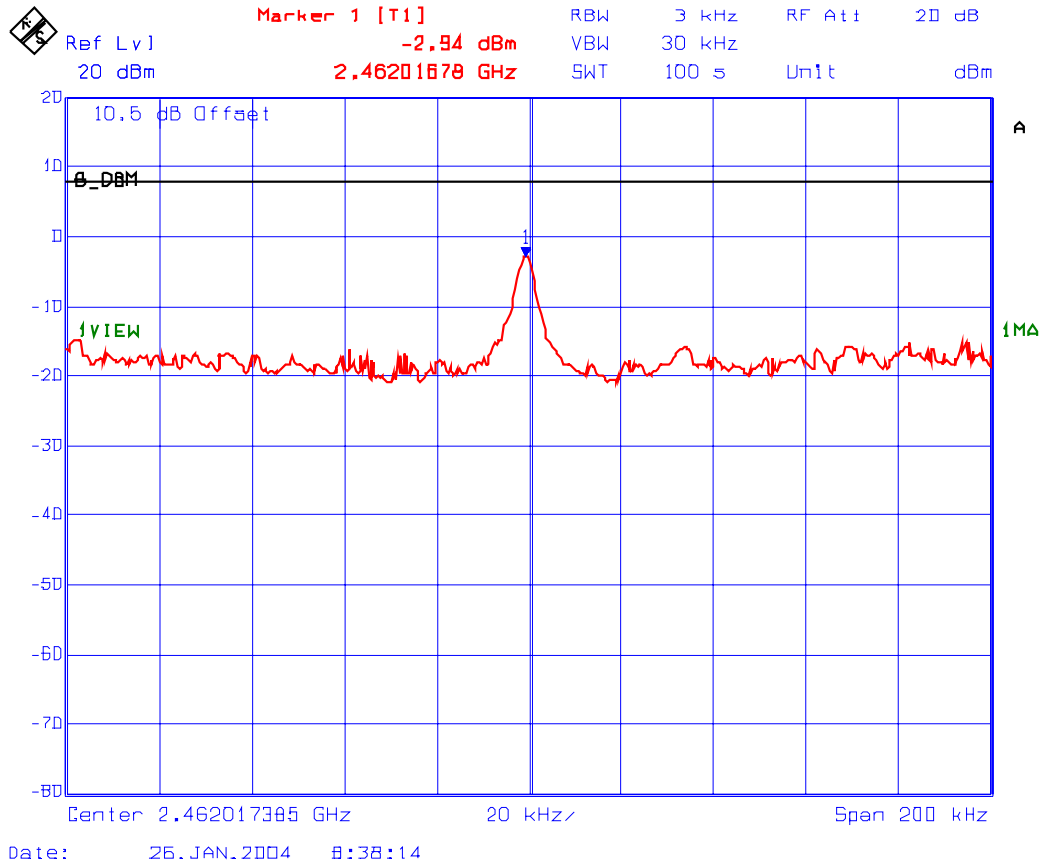

Plot #35: Transmitter Power Spectral Density
Channel Freq.: 2412 MHz,
Modulation: IEEE 802.11b – CCK @ 5.5 Mb/s long data rate

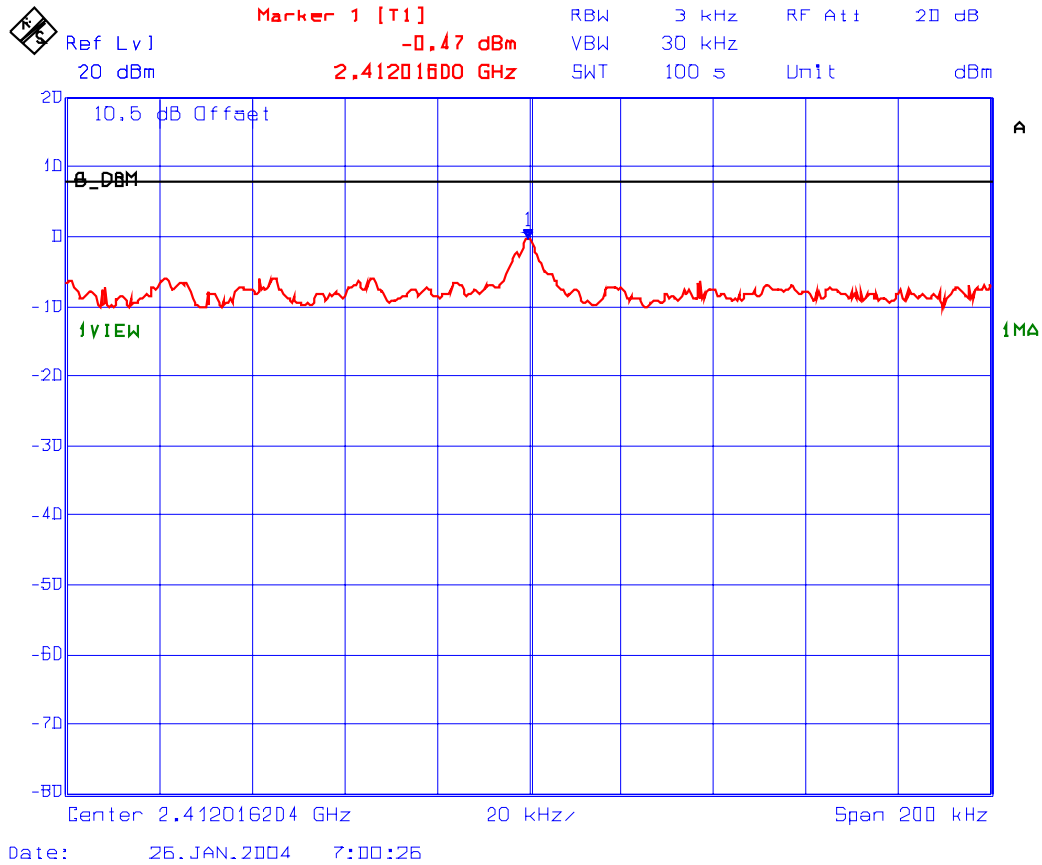

ULTRATECH GROUP OF LABS

3000 Bristol Circle, Oakville, Ontario, Canada L6H 6G4
Tel. #: 905-829-1570, Fax. #: 905-829-8050, Email: vic@ultratech-labs.com, Website: <http://www.ultratech-labs.com>

File #: CNI-027FCC15CE

June 10, 2005

All test results contained in this engineering test report are traceable to National Institute of Standards and Technology (NIST)

Plot #36: Transmitter Power Spectral Density
Channel Freq.: 2437 MHz,
Modulation: IEEE 802.11b – CCK @ 5.5 Mb/s long data rate

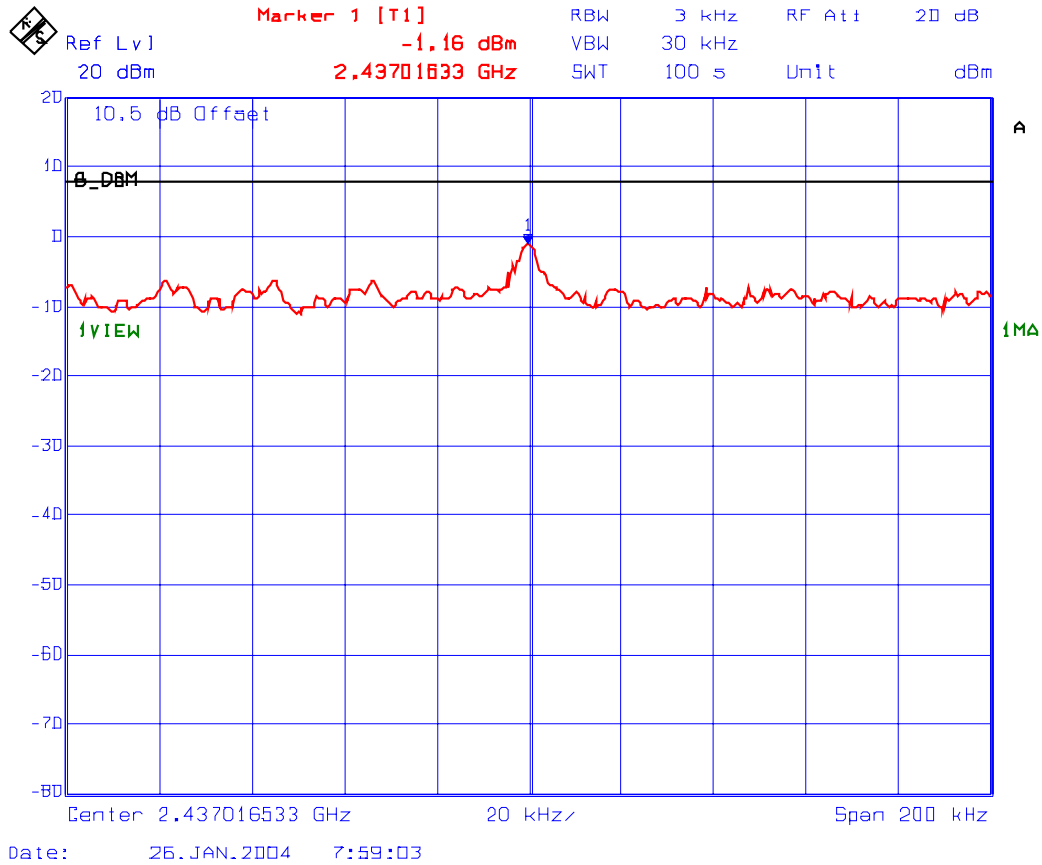

Plot #37: Transmitter Power Spectral Density
Channel Freq.: 2462 MHz,
Modulation: IEEE 802.11b – CCK @ 5.5 Mb/s long data rate

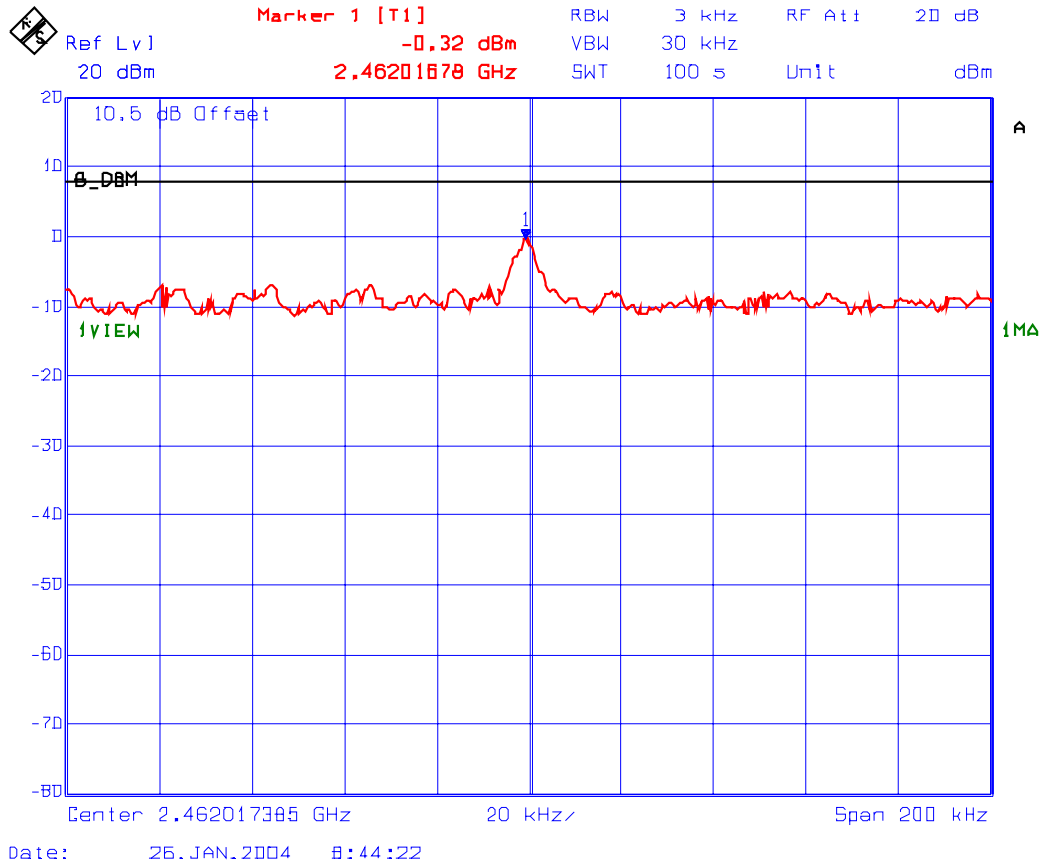

ULTRATECH GROUP OF LABS

3000 Bristol Circle, Oakville, Ontario, Canada L6H 6G4
Tel. #: 905-829-1570, Fax. #: 905-829-8050, Email: vic@ultratech-labs.com, Website: <http://www.ultratech-labs.com>

File #: CNI-027FCC15CE

June 10, 2005

All test results contained in this engineering test report are traceable to National Institute of Standards and Technology (NIST)

Plot #38: Transmitter Power Spectral Density
Channel Freq.: 2412 MHz,
Modulation: IEEE 802.11b – CCK @ 11 Mb/s long data rate

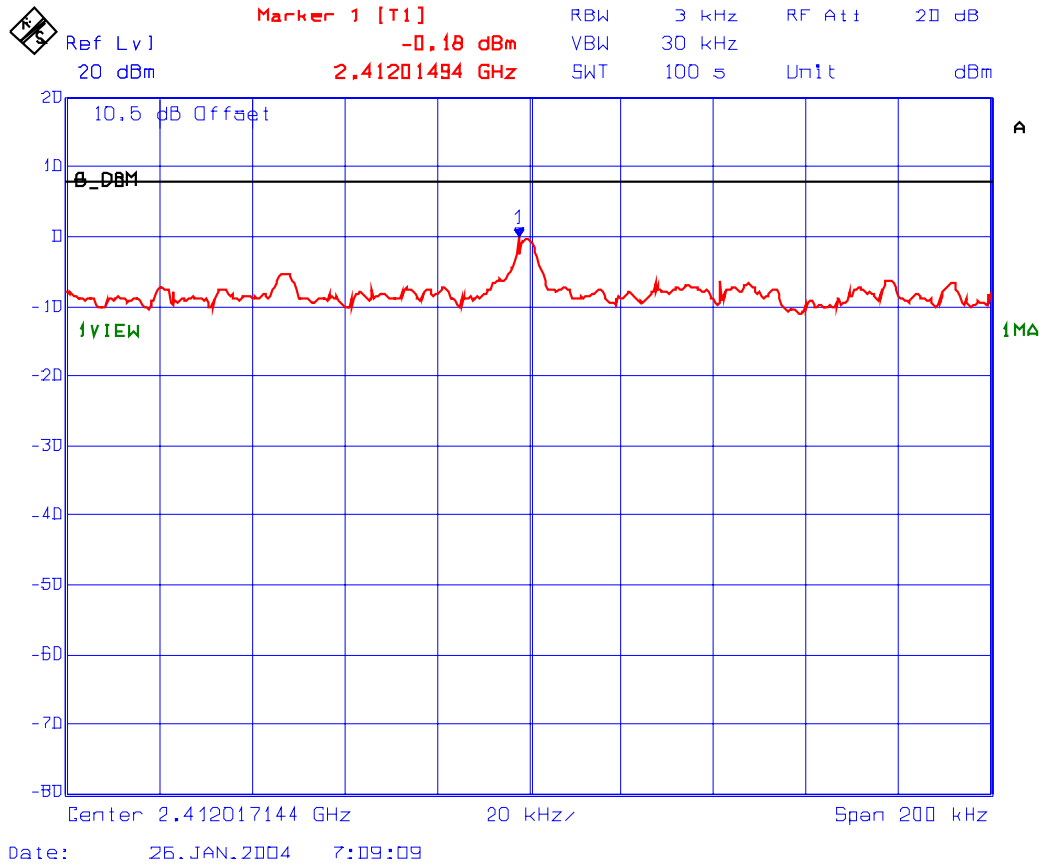

Plot #39: Transmitter Power Spectral Density
Channel Freq.: 2437 MHz,
Modulation: IEEE 802.11b – CCK @ 11 Mb/s long data rate

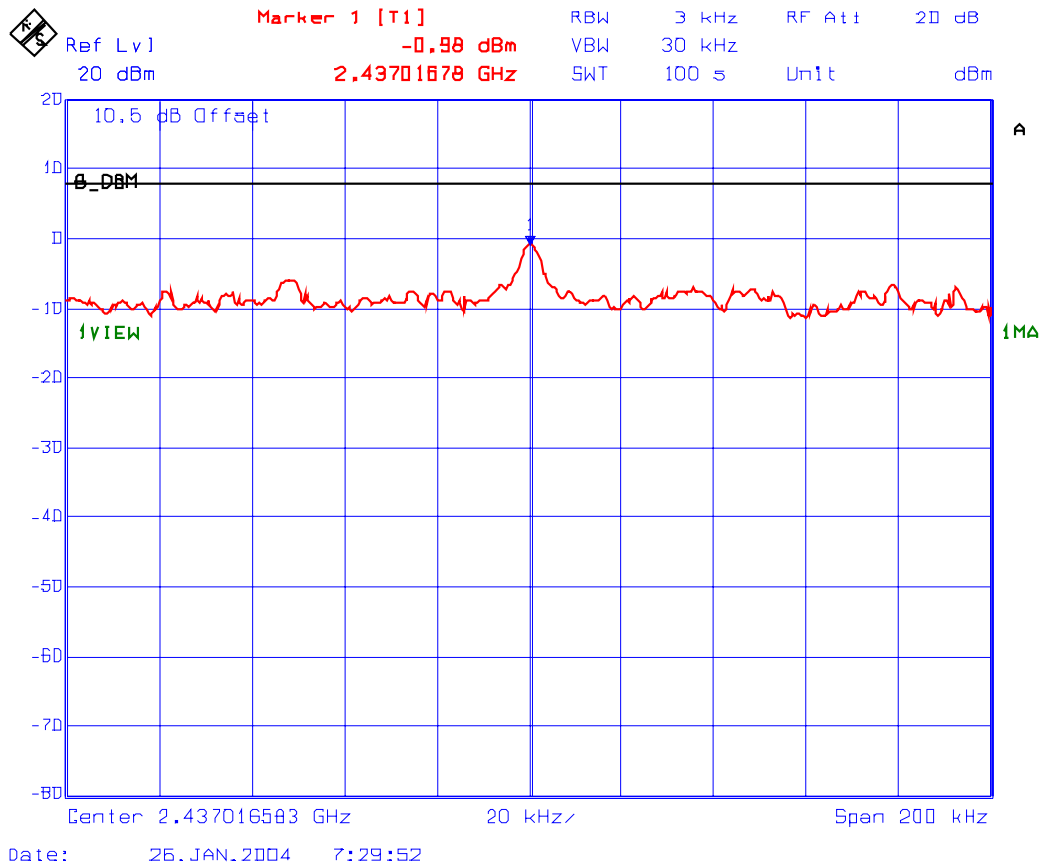

Plot #40: Transmitter Power Spectral Density
 Channel Freq.: 2462 MHz,
 Modulation: IEEE 802.11b – CCK @ 11 Mb/s long data rate

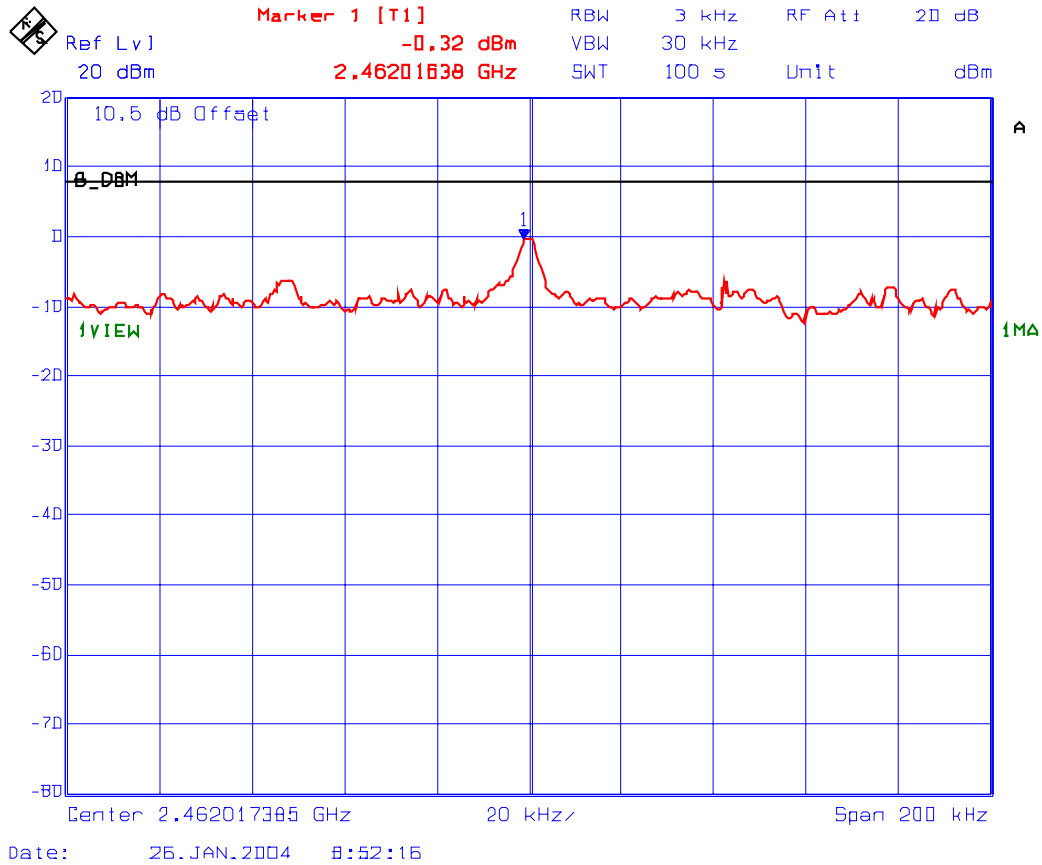

ULTRATECH GROUP OF LABS

3000 Bristol Circle, Oakville, Ontario, Canada L6H 6G4
 Tel. #: 905-829-1570, Fax. #: 905-829-8050, Email: vic@ultratech-labs.com, Website: <http://www.ultratech-labs.com>

File #: CNI-027FCC15CE

June 10, 2005

All test results contained in this engineering test report are traceable to National Institute of Standards and Technology (NIST)

Modulation Scheme: IEEE 802.11g					
Channel Frequency (MHz)	Modulation Data Rate	RF Power Level in 3 KHz BW (dBm)	Limit (dBm)	Margin (dB)	Comments (Pass/Fail)
2412	OFDM 9 Mb/s long data	-2.2	8.0	-10.2	Pass
2437	OFDM 9 Mb/s long data	-1.6	8.0	-9.6	Pass
2462	OFDM 9 Mb/s long data	-0.3	8.0	-8.3	Pass
2412	OFDM 18 Mb/s long data	-2.3	8.0	-10.3	Pass
2437	OFDM 18 Mb/s long data	-1.9	8.0	-9.9	Pass
2462	OFDM 18 Mb/s long data	-0.7	8.0	-8.7	Pass
2412	OFDM 36 Mb/s long data	-1.7	8.0	-9.7	Pass
2437	OFDM 36 Mb/s long data	-1.6	8.0	-9.6	Pass
2462	OFDM 36 Mb/s long data	-0.6	8.0	-8.6	Pass
2412	OFDM 54 Mb/s long data	-5.7	8.0	-13.7	Pass
2437	OFDM 54 Mb/s long data	-5.6	8.0	-13.6	Pass
2462	OFDM 54 Mb/s long data	-4.4	8.0	-12.4	Pass

Refer to Plots # 41 to 52 for detailed of measurements

Plot #41: Transmitter Power Spectral Density
Channel Freq.: 2412 MHz,
Modulation: IEEE 802.11g – OFDM @ 9 Mb/s long data rate

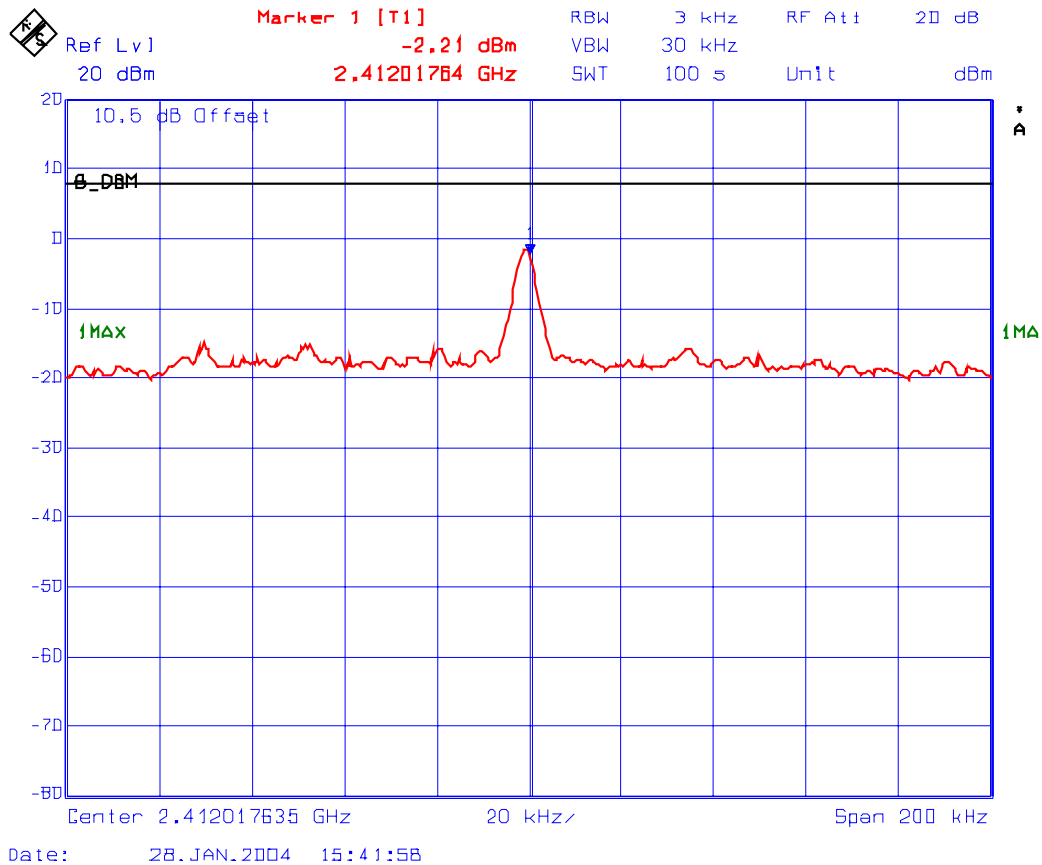

ULTRATECH GROUP OF LABS

3000 Bristol Circle, Oakville, Ontario, Canada L6H 6G4
Tel. #: 905-829-1570, Fax. #: 905-829-8050, Email: vic@ultratech-labs.com, Website: <http://www.ultratech-labs.com>

File #: CNI-027FCC15CE
June 10, 2005

All test results contained in this engineering test report are traceable to National Institute of Standards and Technology (NIST)

Plot #42: Transmitter Power Spectral Density
Channel Freq.: 2437 MHz,
Modulation: IEEE 802.11g – OFDM @ 9 Mb/s long data rate

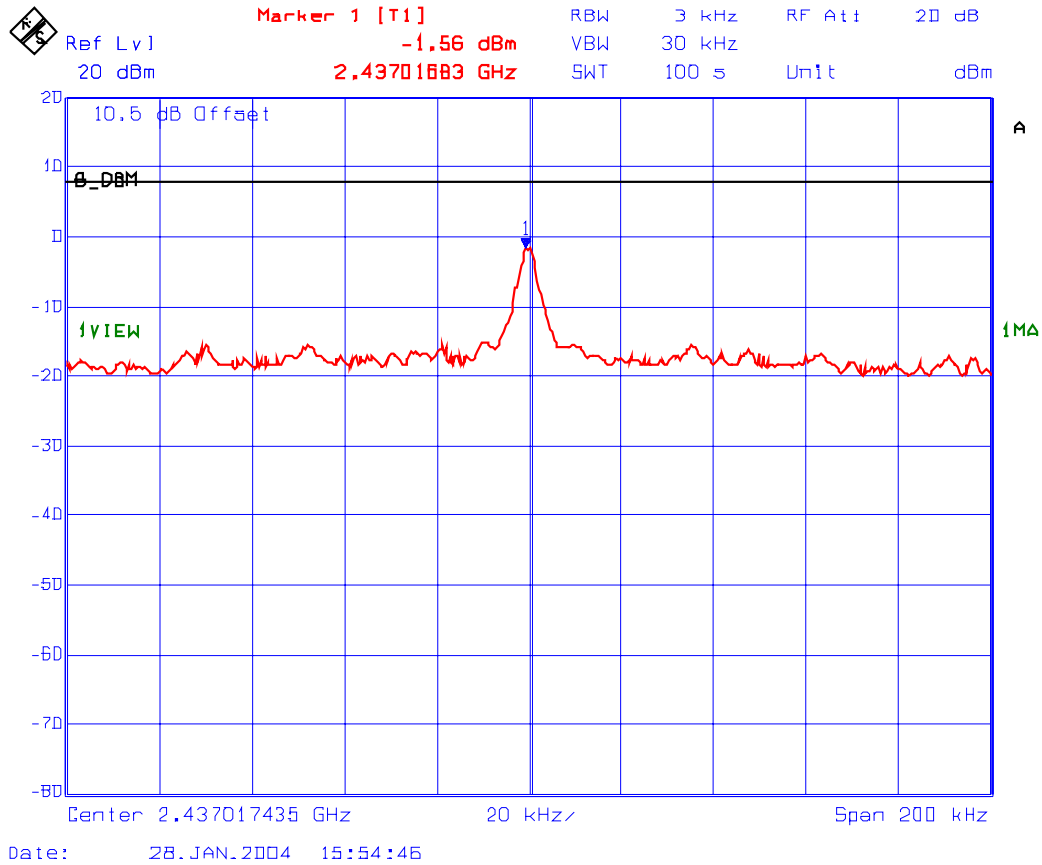

ULTRATECH GROUP OF LABS

3000 Bristol Circle, Oakville, Ontario, Canada L6H 6G4
Tel. #: 905-829-1570, Fax. #: 905-829-8050, Email: vic@ultratech-labs.com, Website: <http://www.ultratech-labs.com>

File #: CNI-027FCC15CE

June 10, 2005

All test results contained in this engineering test report are traceable to National Institute of Standards and Technology (NIST)

Plot #43: Transmitter Power Spectral Density
Channel Freq.: 2462 MHz,
Modulation: IEEE 802.11g – OFDM @ 9 Mb/s long data rate

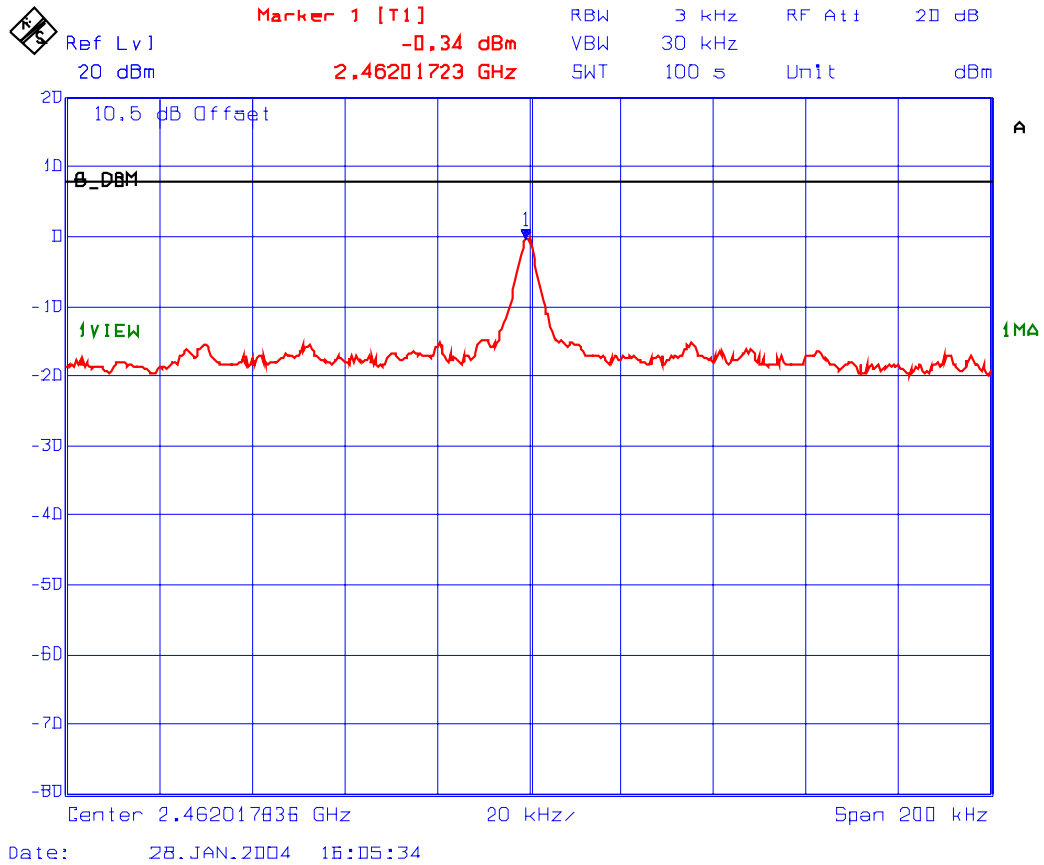

Plot #44: Transmitter Power Spectral Density
Channel Freq.: 2412 MHz,
Modulation: IEEE 802.11g – OFDM @ 18 Mb/s long data rate

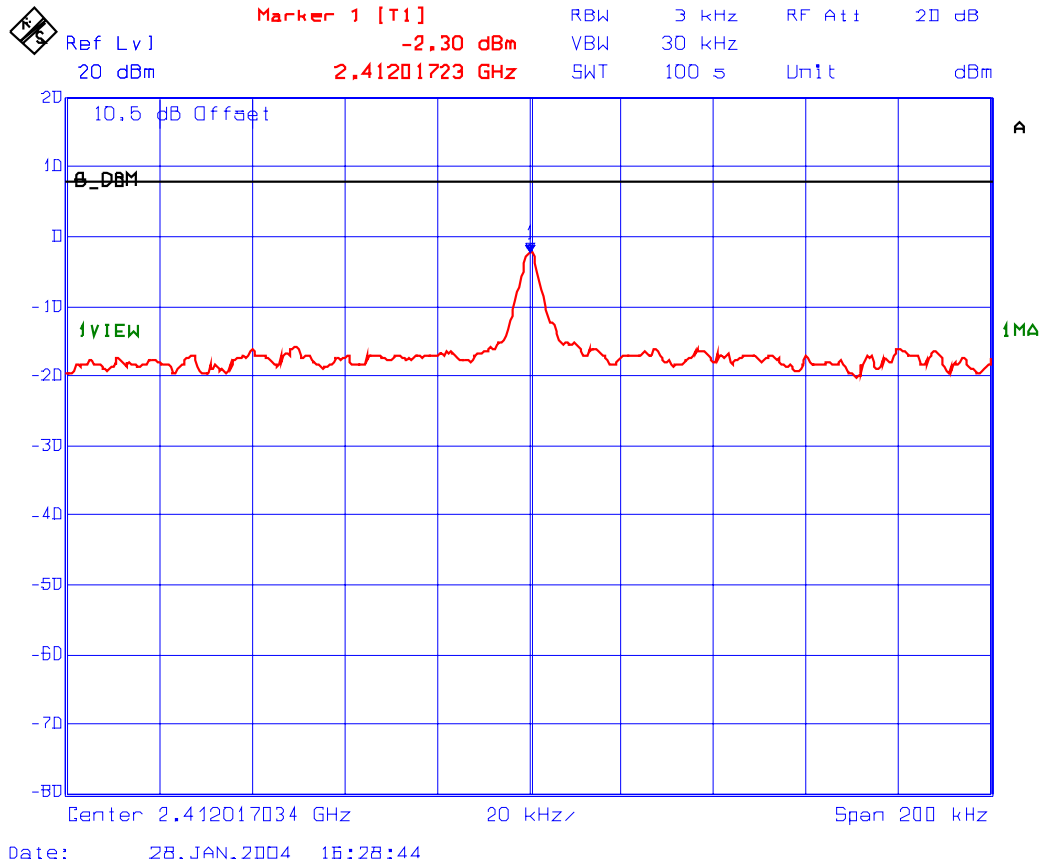

ULTRATECH GROUP OF LABS

3000 Bristol Circle, Oakville, Ontario, Canada L6H 6G4
Tel. #: 905-829-1570, Fax. #: 905-829-8050, Email: vic@ultratech-labs.com, Website: <http://www.ultratech-labs.com>

File #: CNI-027FCC15CE

June 10, 2005

All test results contained in this engineering test report are traceable to National Institute of Standards and Technology (NIST)

Plot #45: Transmitter Power Spectral Density
Channel Freq.: 2437 MHz,
Modulation: IEEE 802.11g – OFDM @ 18 Mb/s long data rate

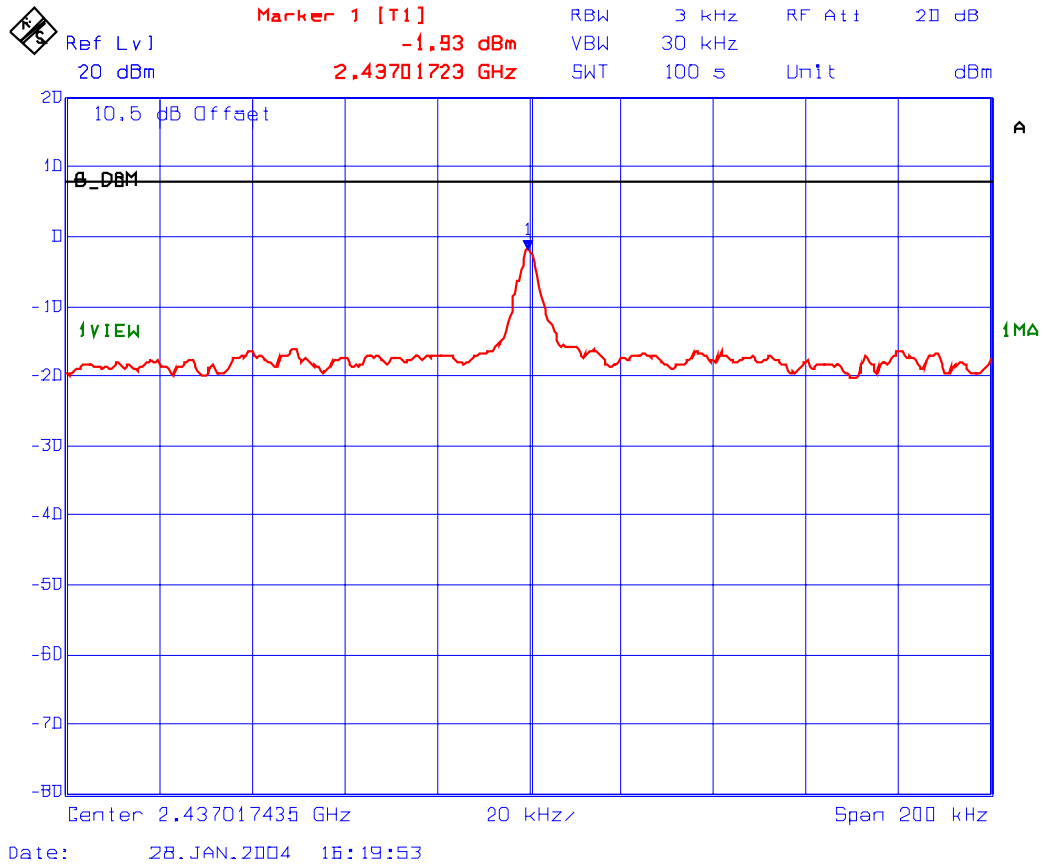

Plot #46: Transmitter Power Spectral Density
Channel Freq.: 2462 MHz,
Modulation: IEEE 802.11g – OFDM @ 18 Mb/s long data rate

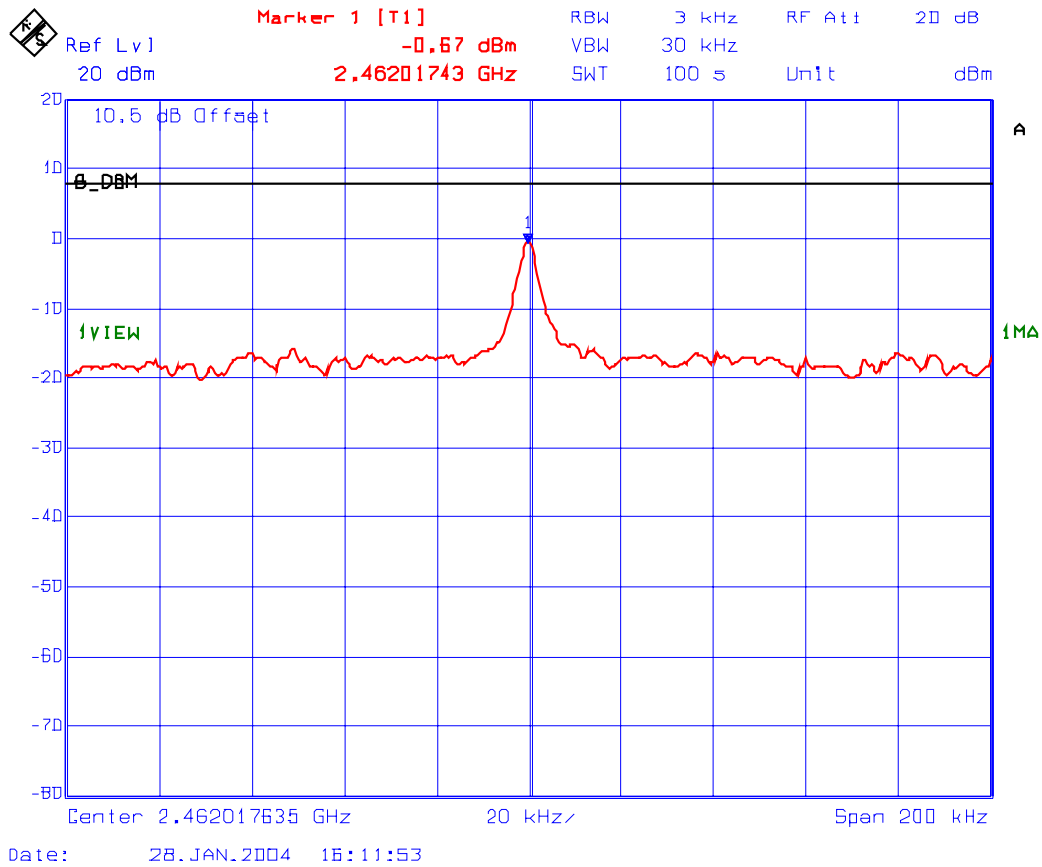

Plot #47: Transmitter Power Spectral Density
Channel Freq.: 2412 MHz,
Modulation: IEEE 802.11g – OFDM @ 36 Mb/s long data rate

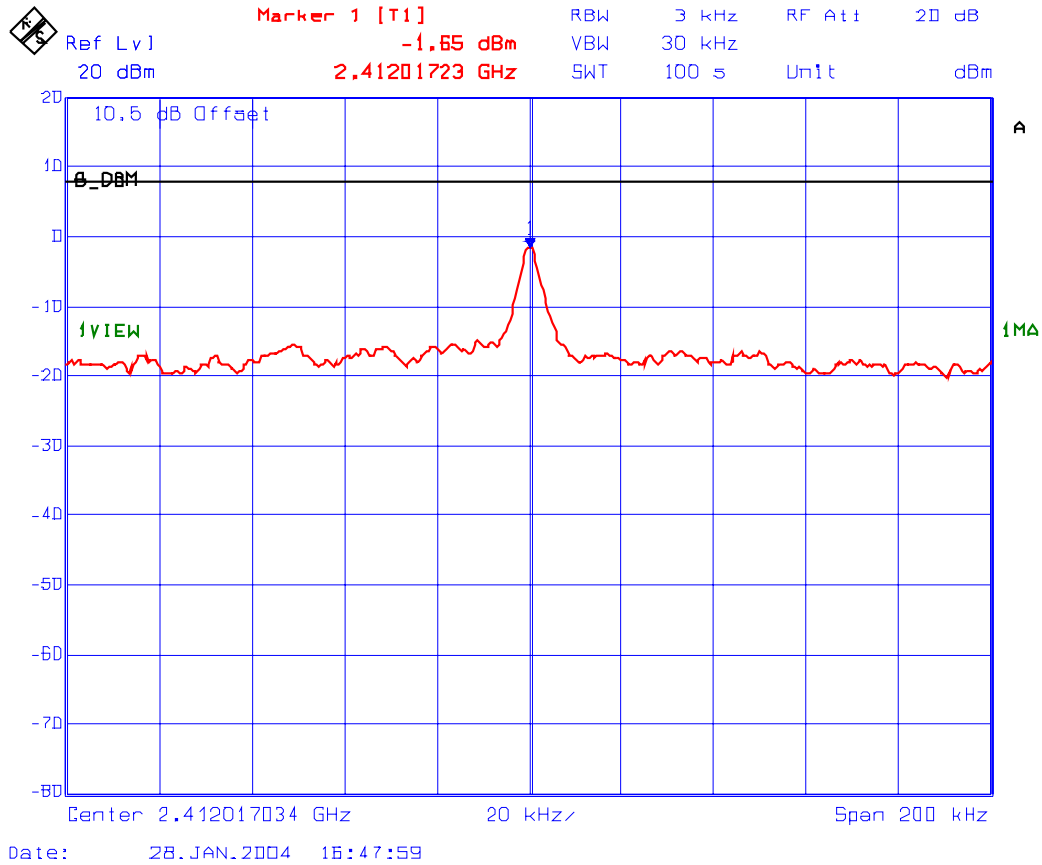

Plot #48: Transmitter Power Spectral Density
Channel Freq.: 2437 MHz,
Modulation: IEEE 802.11g – OFDM @ 36 Mb/s long data rate

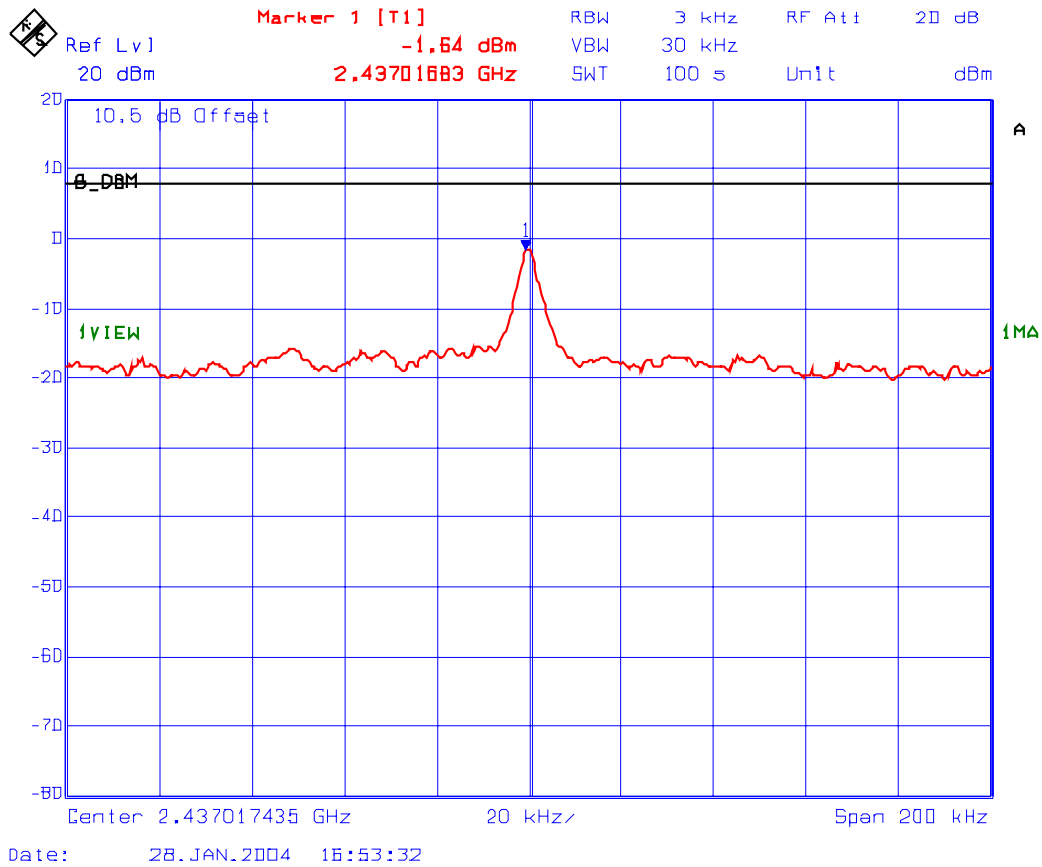

ULTRATECH GROUP OF LABS

3000 Bristol Circle, Oakville, Ontario, Canada L6H 6G4
Tel. #: 905-829-1570, Fax. #: 905-829-8050, Email: vic@ultratech-labs.com, Website: <http://www.ultratech-labs.com>

File #: CNI-027FCC15CE

June 10, 2005

All test results contained in this engineering test report are traceable to National Institute of Standards and Technology (NIST)

Plot #49: Transmitter Power Spectral Density
Channel Freq.: 2462 MHz,
Modulation: IEEE 802.11g – OFDM @ 36 Mb/s long data rate

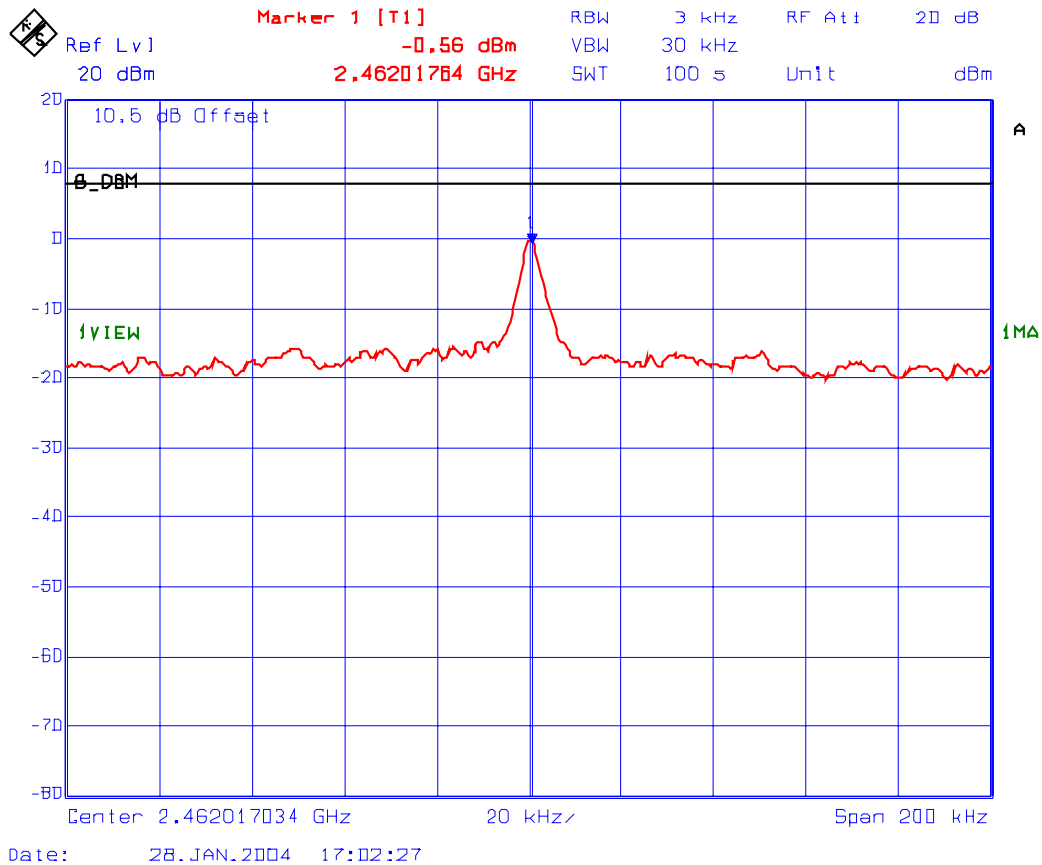

ULTRATECH GROUP OF LABS

3000 Bristol Circle, Oakville, Ontario, Canada L6H 6G4
Tel. #: 905-829-1570, Fax. #: 905-829-8050, Email: vic@ultratech-labs.com, Website: <http://www.ultratech-labs.com>

File #: CNI-027FCC15CE
June 10, 2005

All test results contained in this engineering test report are traceable to National Institute of Standards and Technology (NIST)

Plot #50: Transmitter Power Spectral Density
Channel Freq.: 2412 MHz,
Modulation: IEEE 802.11g – OFDM @ 54 Mb/s long data rate

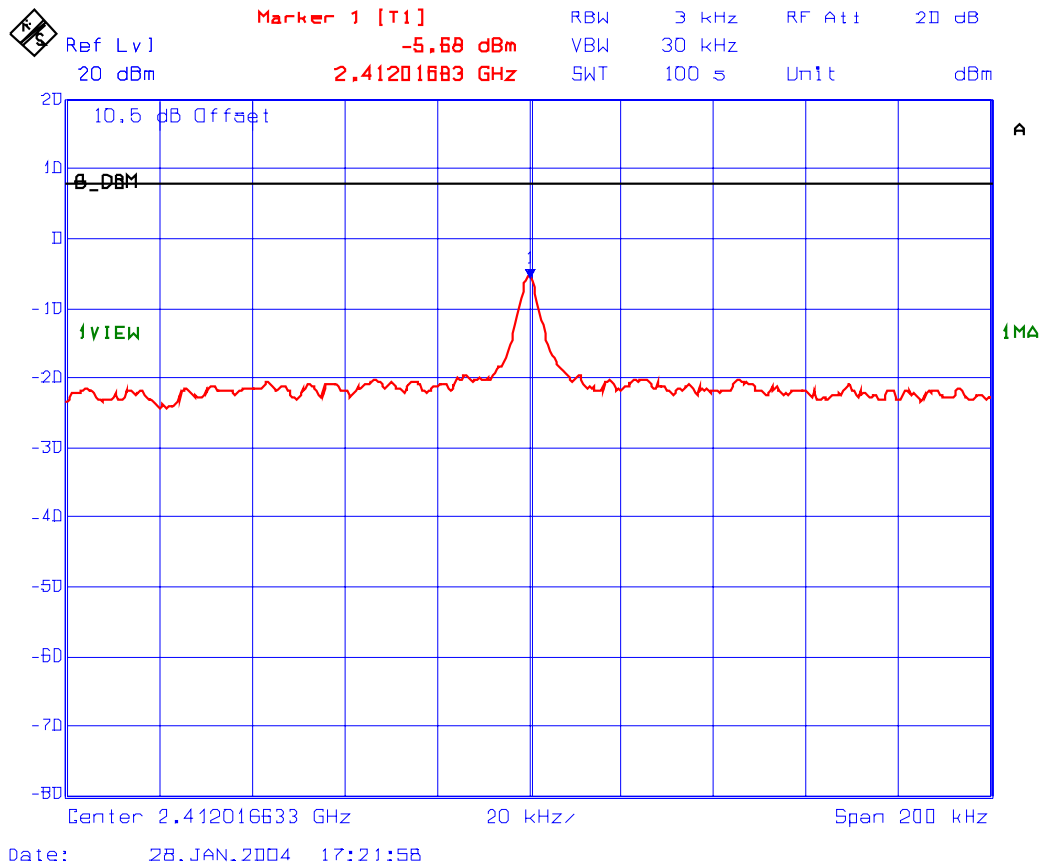

Plot #51: Transmitter Power Spectral Density
Channel Freq.: 2437 MHz,
Modulation: IEEE 802.11g – OFDM @ 54 Mb/s long data rate

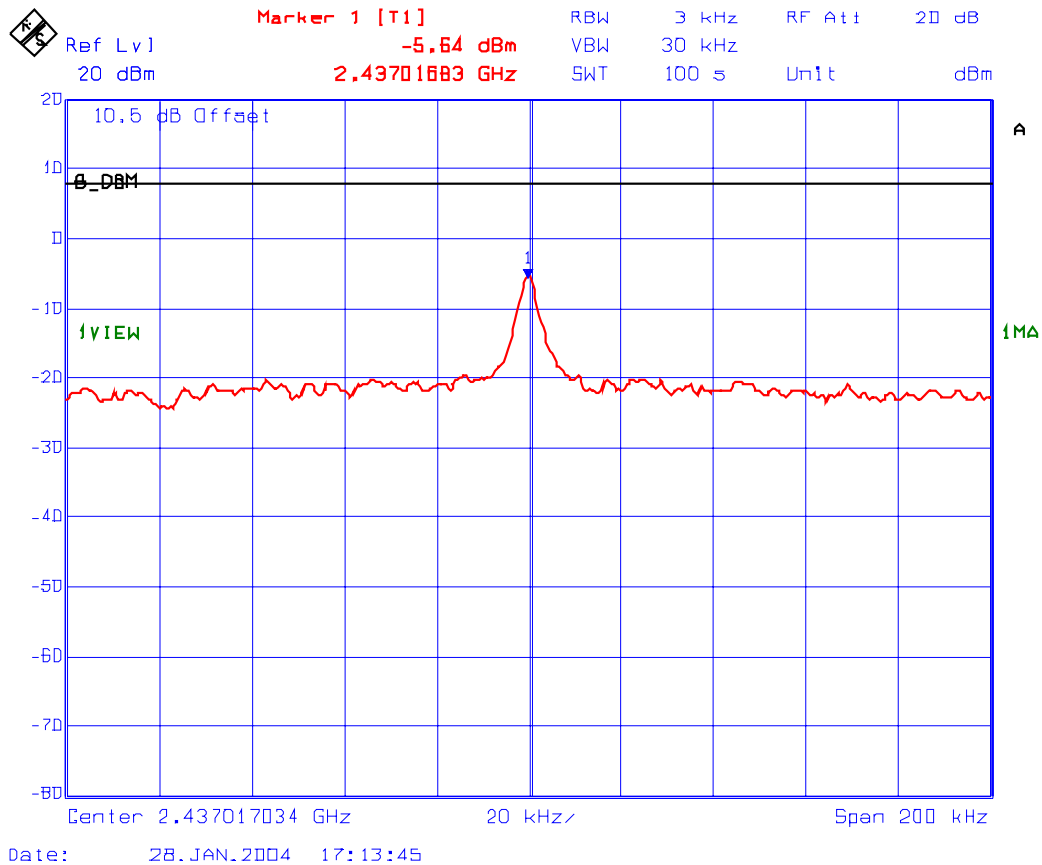

Plot #52: Transmitter Power Spectral Density
Channel Freq.: 2462 MHz
Modulation: IEEE 802.11g – OFDM @ 54 Mb/s long data rate

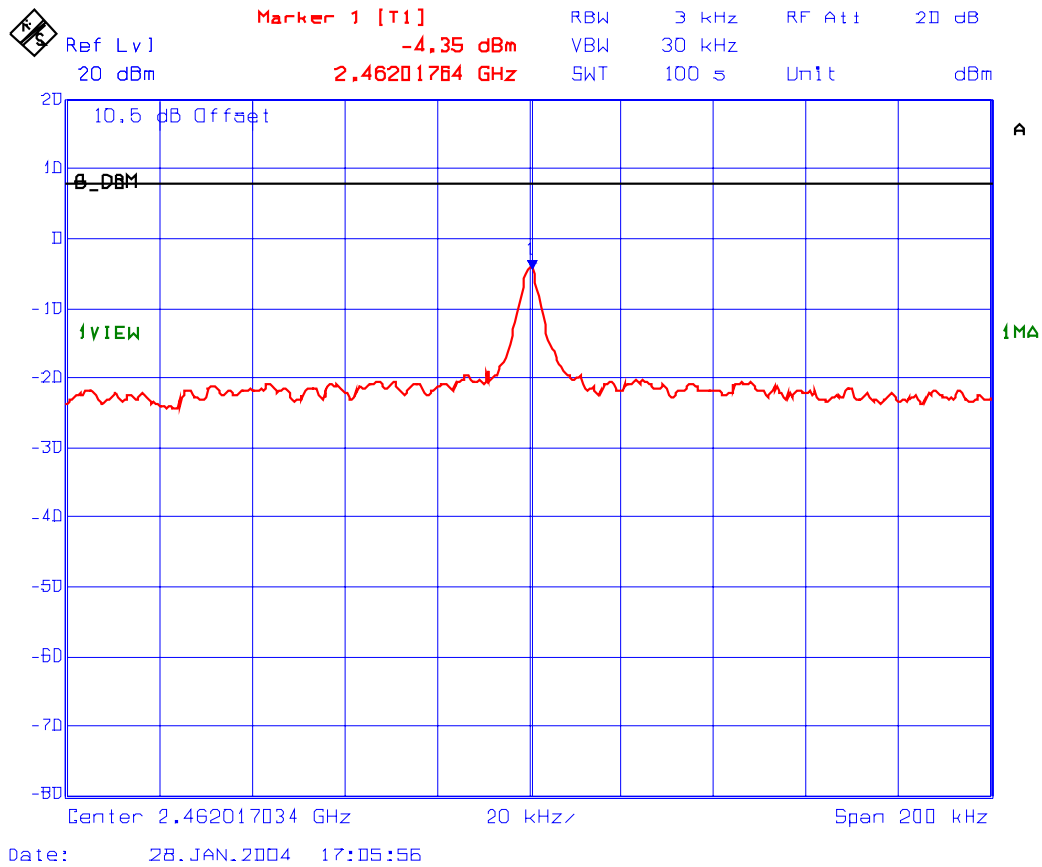

7.6. SPURIOUS EMISSIONS (RADIATED @ 3 METERS) [§§ 15.247(c), 15.209 & 15.205]

7.6.1. Limits

In any 100 KHz bandwidth outside the operating frequency band, the radio frequency power that is produced by modulation products of the spreading sequence, the information sequence and the carrier frequency shall be either at least 20 dB below that in any 100 KHz bandwidth within the band that contains the highest level of the desired power or shall not exceed the general levels specified in @ 15.209(a), which lesser attenuation.

All other emissions inside restricted bands specified in @ 15.205(a) shall not exceed the general radiated emission limits specified in @ 15.209(a)

Remarks:

- Applies to harmonics/spurious emissions that fall in the restricted bands listed in Section 15.205. The maximum permitted average field strength is listed in Section 15.209.
- @ **FCC CFR 47, Para. 15.237(c)** - The emission limits as specified above are based on measurement instrument employing an average detector. The provisions in @15.35 for limiting peak emissions apply.

FCC 47 CFR § 15.205(a) - Restricted Frequency Bands

MHz	MHz	MHz	GHz
0.090 - 0.110	162.0125 - 167.17	2310 - 2390	9.3 - 9.5
0.49 - 0.51	167.72 - 173.2	2483.5 - 2500	10.6 - 12.7
2.1735 - 2.1905	240 - 285	2655 - 2900	13.25 - 13.4
8.362 - 8.366	322 - 335.4	3260 - 3267	14.47 - 14.5
13.36 - 13.41	399.9 - 410	3332 - 3339	14.35 - 16.2
25.5 - 25.67	608 - 614	3345.8 - 3358	17.7 - 21.4
37.5 - 38.25	960 - 1240	3600 - 4400	22.01 - 23.12
73 - 75.4	1300 - 1427	4500 - 5250	23.6 - 24.0
108 - 121.94	1435 - 1626.5	5350 - 5460	31.2 - 31.8
123 - 138	1660 - 1710	7250 - 7750	36.43 - 36.5
149.9 - 150.05	1718.8 - 1722.2	8025 - 8500	Above 38.6
156.7 - 156.9	2200 - 2300	9000 - 9200	

**FCC 47 CFR § 15.209(a)
 -- Field Strength Limits within Restricted Frequency Bands --**

FREQUENCY (MHz)	FIELD STRENGTH LIMITS (microvolts/m)	DISTANCE (Meters)
0.009 - 0.490	2,400 / F (KHz)	300
0.490 - 1.705	24,000 / F (KHz)	30
1.705 - 30.0	30	30
30 - 88	100	3
88 - 216	150	3
216 - 960	200	3
Above 960	500	3

7.6.2. Method of Measurements

Refer to Exhibit 10, Section 10.4 of this test report and **ANSI 63.4, Para. 8** for detailed radiated emissions measurement procedures.

The following measurement procedures were also applied:

- Applies to harmonics/spurious that fall in the restricted bands listed in Section 15.205. the maximum permitted average field strength is listed in Section 15.209. A Pre-Amp and highpass filter are used for this measurement.
- For measurement below 1 GHz, set RBW = 100 KHz, VBW \geq 100 KHz, SWEEP=AUTO.
- For measurement above 1 GHz, set RBW = 1 MHz, VBW = 1 MHz (Peak) & VBW = 10 Hz (Average), SWEEP=AUTO.
- If the emission is pulsed, modified the unit for continuous operation, then use the settings above for measurements, then correct the reading by subtracting the peak-average correction factor derived from the appropriate duty cycle calculation. See Section 15.35(b) and (c).

7.6.3. Test Arrangement

Please refer to Test Arrangement in Section 3.6 for details of test setup for emission measurements.

7.6.4. Test Equipment List

Test Instruments	Manufacturer	Model No.	Serial No.	Frequency Range
Spectrum Analyzer	Rohde & Schwarz	FSEK20/B4/B21	834157/005	9 kHz – 40 GHz
Microwave Amplifier	Hewlett Packard	HP 83017A		1 GHz to 26.5 GHz
Biconilog Antenna	EMCO	3143	1029	20 MHz to 2 GHz
Horn Antenna	EMCO	3155	9701-5061	1 GHz – 18 GHz
Highpass Filter	K&L	11SH10-1500-T8000	--	Cut-off at 1500 MHz used for 902-928 MHz Radio
Highpass Filter	Michael Lab	XD40N	--	Cut-off at 4 GHz used for 2.4-2.4835 GHz

7.6.5. Test Data

7.6.5.1. Band-edges Emissions (Radiated at 3 Meters)

See the following test data plots (53 – 76) for detailed measurements of band-edge emissions.

7.6.5.1.1. External Antennas

Plot 53: Lower Band-Edge, Horizontal Polarization
Power Setting: 20 dBm, Frequency: 2412 MHz, Modulation: IEEE 802.11b - 11 Mbps
Delta Trace 1 & Trace 2: 6.8 dB
Trace 1 ___: RBW = 1 MHz, VBW = 3 MHz
Trace 2 ___: RBW = 100 kHz, VBW = 1 MHz
Marker 2: 2385.23 MHz, 63.64 dB μ V/m (Peak), 53.04 dB μ V/m (Avg)

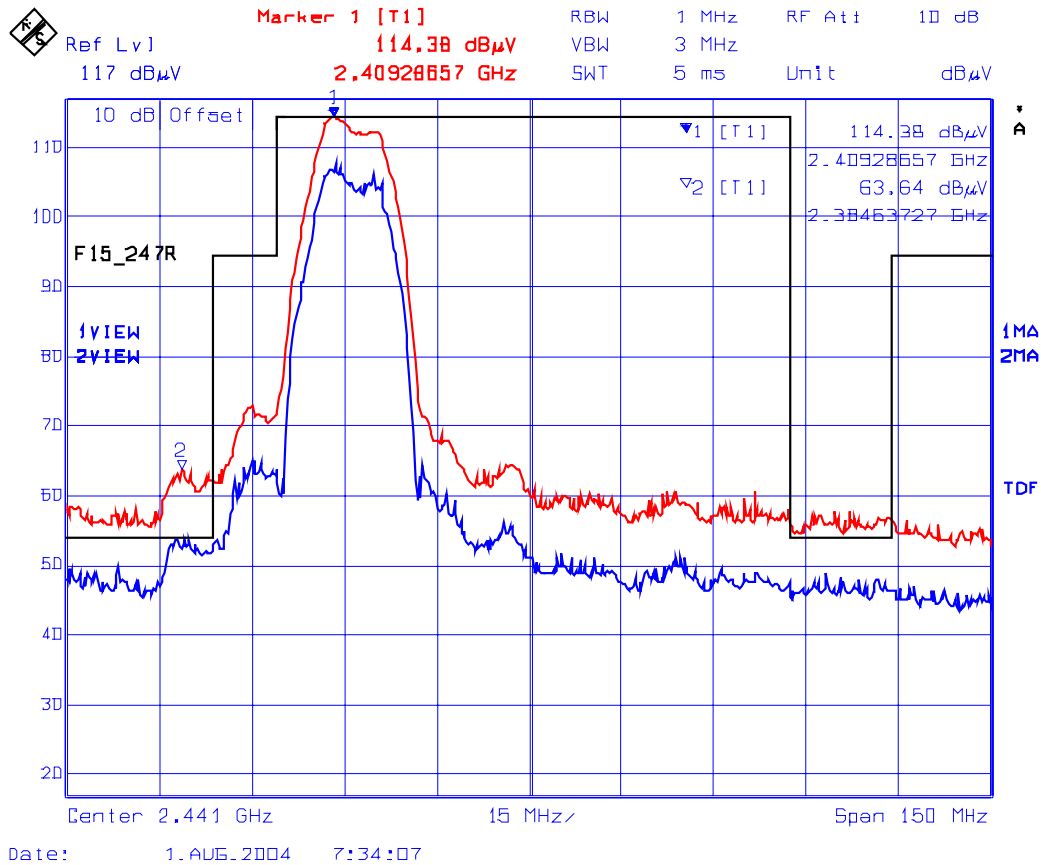

ULTRATECH GROUP OF LABS

3000 Bristol Circle, Oakville, Ontario, Canada L6H 6G4
Tel. #: 905-829-1570, Fax. #: 905-829-8050, Email: vic@ultratech-labs.com, Website: <http://www.ultratech-labs.com>

File #: CNI-027FCC15CE
June 10, 2005

All test results contained in this engineering test report are traceable to National Institute of Standards and Technology (NIST)

Plot 54: Lower Band-Edge, Vertical Polarization
Power Setting: 20 dBm, Frequency: 2412 MHz, Modulation: IEEE 802.11b - 11 Mbps,
Delta Trace 1 & Trace 2: 7.21 dB
Trace 1 : RBW= 1 MHz, VBW= 3 MHz
Trace 2 : RBW= 100 kHz, VBW= 1 MHz
Marker 2: 2385.23 MHz, 63.47 dB μ V/m (Peak), 51.09 dB μ V/m (Avg)

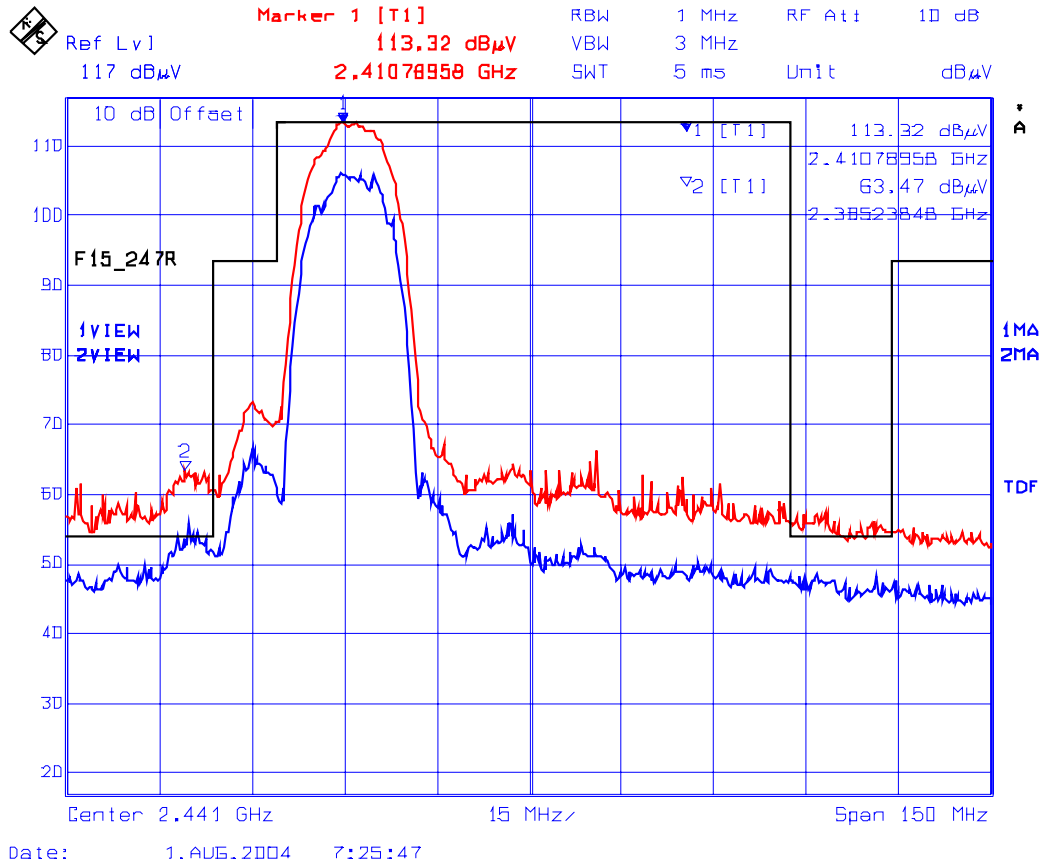

Plot 55: Upper Band-Edge, Horizontal Polarization
Power Setting: 20 dBm, Frequency: 2462 MHz, Modulation: IEEE 802.11b - 11 Mbps
Delta Trace 1 & Trace 2: 5.81 dB
 Trace 1 : RBW = 1 MHz, VBW = 3 MHz
 Trace 2 : RBW = 100 kHz, VBW = 1 MHz
 Marker 2: 2498.26 MHz, 60.96 dB μ V/m (Peak), 48.91 dB μ V/m (Avg)

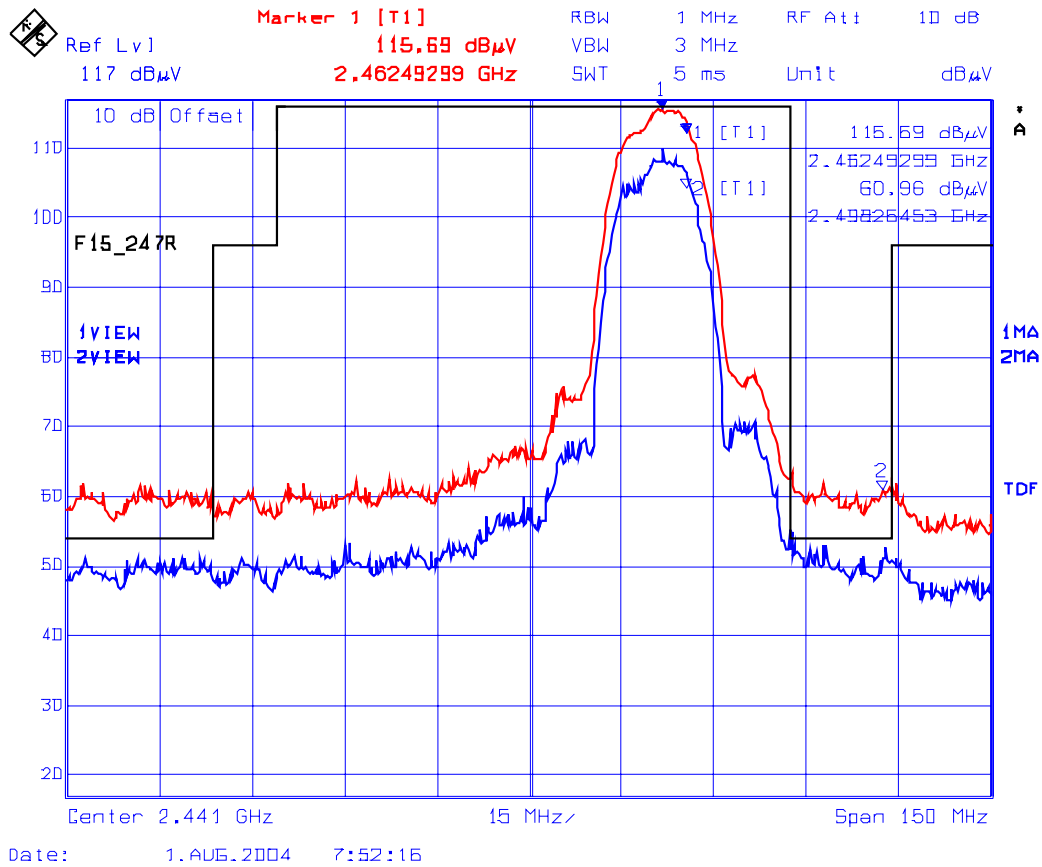

Plot 56: Upper Band-Edge, Vertical Polarization
 Power Setting: 20 dBm, Frequency: 2462 MHz, Modulation: IEEE 802.11b - 11 Mbps
 Delta Trace 1 & Trace 2: 6.58 dB
 Trace 1 : RBW = 1 MHz, VBW = 3 MHz
 Trace 2 : RBW = 100 kHz, VBW = 1 MHz
 Marker 2: 2498.26 MHz, 59.44 dB μ V/m (Peak), 47.74 dB μ V/m (Avg)

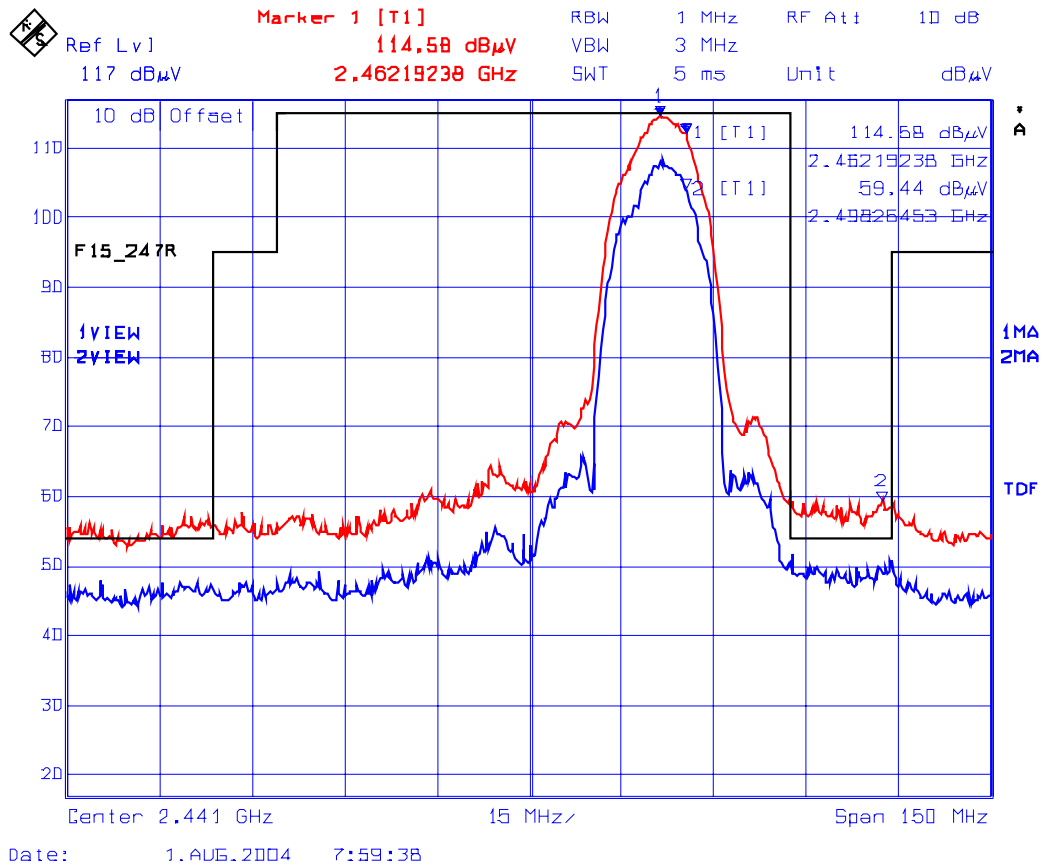

Plot 57: Lower Band-Edge, Horizontal Polarization
Power Setting: 13 dBm, Frequency: 2412 MHz, Modulation: IEEE 802.11g - 9 Mbps
Delta Trace 1 & Trace 2: 9.47 dB
Trace 1 : RBW= 1 MHz, VBW= 3 MHz
Trace 2 : RBW= 100 kHz, VBW= 1 MHz

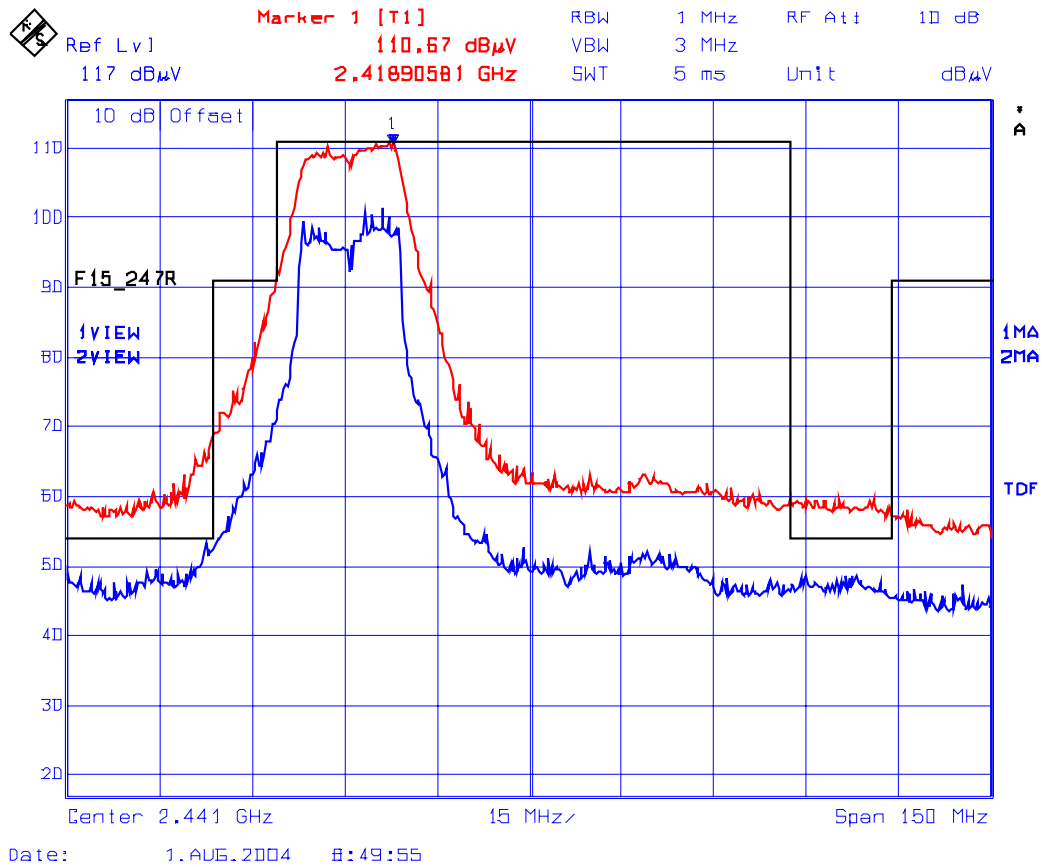

ULTRATECH GROUP OF LABS

3000 Bristol Circle, Oakville, Ontario, Canada L6H 6G4
Tel. #: 905-829-1570, Fax. #: 905-829-8050, Email: vic@ultratech-labs.com, Website: <http://www.ultratech-labs.com>

File #: CNI-027FCC15CE
June 10, 2005

All test results contained in this engineering test report are traceable to National Institute of Standards and Technology (NIST)

Plot 58: Lower Band-Edge, Vertical Polarization
Power Setting: 13 dBm, Frequency: 2412 MHz, Modulation: IEEE 802.11g - 9 Mbps
Delta Trace 1 & Trace 2: 9.91 dB
Trace 1 : RBW= 1 MHz, VBW= 3 MHz
Trace 2 : RBW= 100 kHz, VBW= 1 MHz

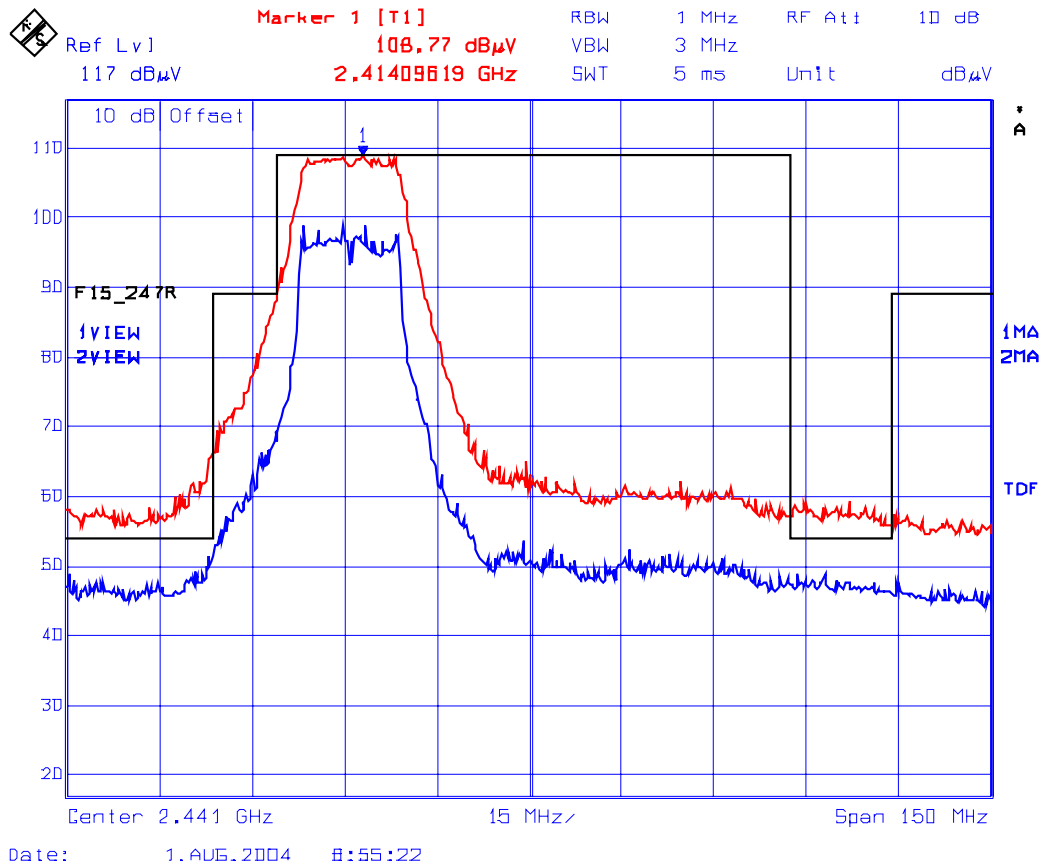

Plot 59: Upper Band-Edge, Horizontal Polarization
Power Setting 13 dBm, Frequency: 2462 MHz, Modulation: IEEE 802.11g - 9 Mbps
Delta Trace 1 & Trace 2: 8.83 dB
Trace 1 : RBW= 1 MHz, VBW= 3 MHz
Trace 2 : RBW= 100 kHz, VBW= 1 MHz

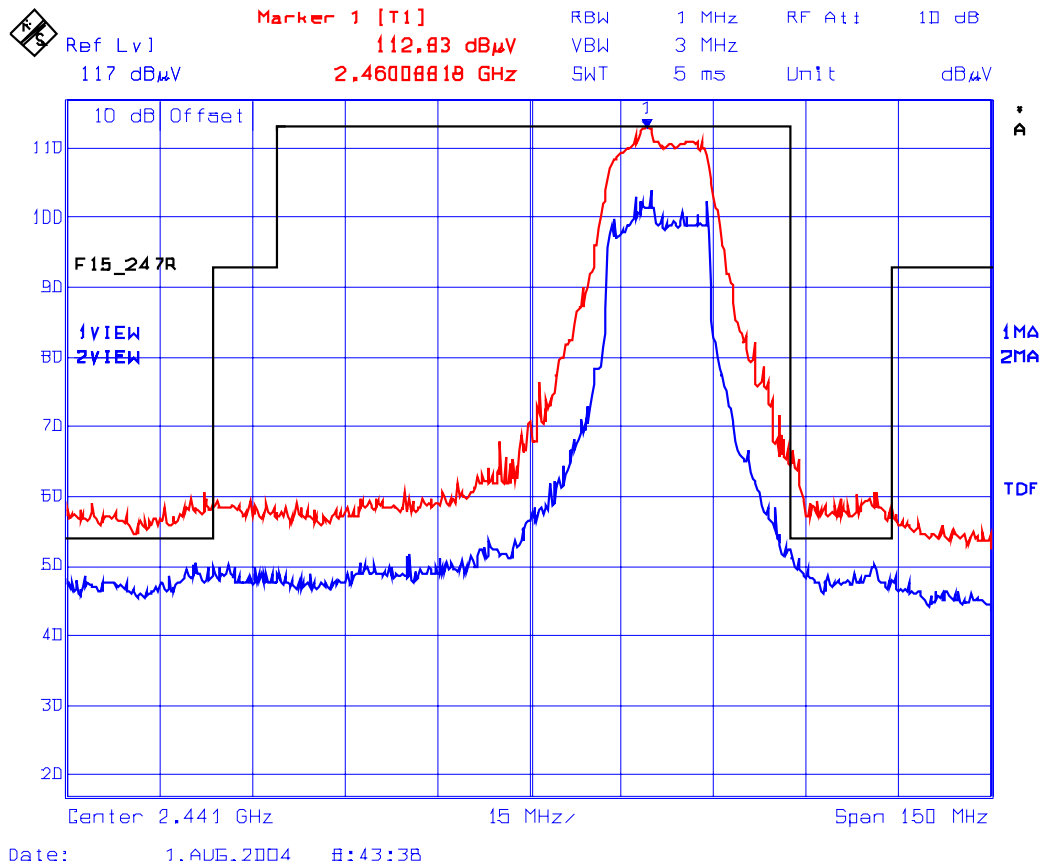

Plot 60: Upper Band-Edge, Vertical Polarization
Power Setting: 13 dBm, Frequency: 2462 MHz, Modulation: IEEE 802.11g - 9 Mbps
Delta Trace 1 & Trace 2: 9.04 dB
Trace 1 : RBW= 1 MHz, VBW= 3 MHz
Trace 2 : RBW= 100 kHz, VBW= 1 MHz

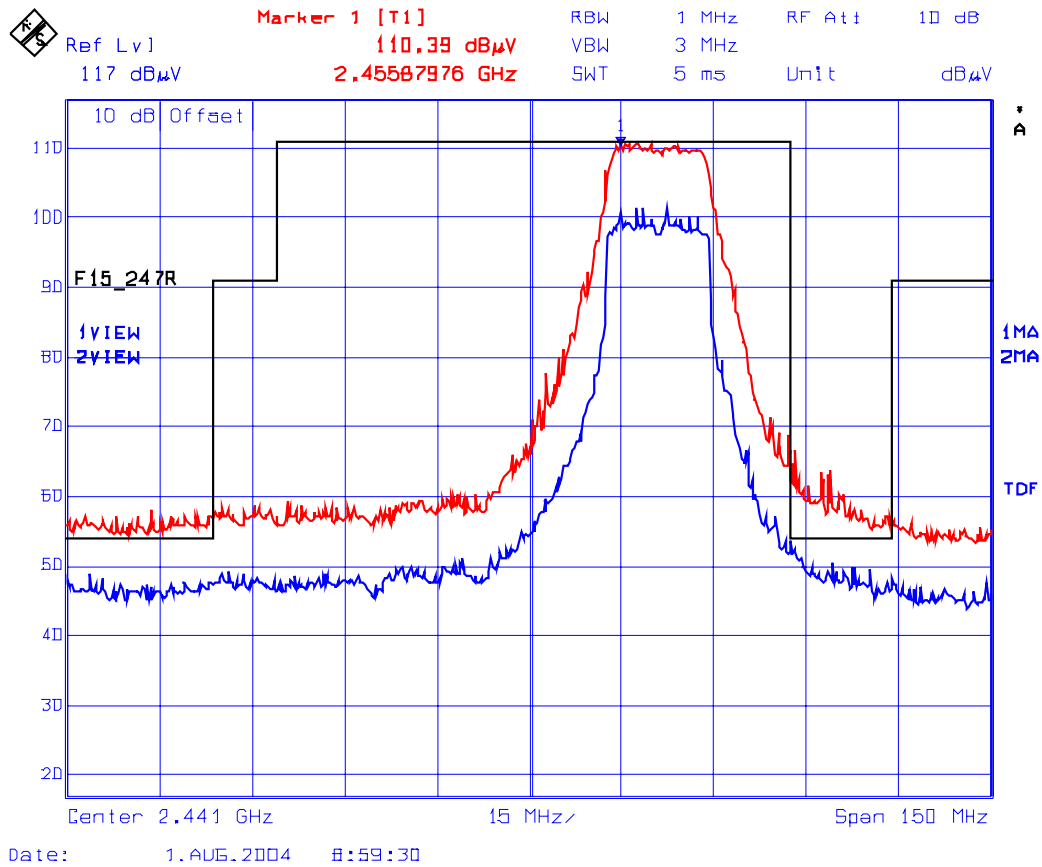

ULTRATECH GROUP OF LABS

3000 Bristol Circle, Oakville, Ontario, Canada L6H 6G4
Tel. #: 905-829-1570, Fax. #: 905-829-8050, Email: vic@ultratech-labs.com, Website: <http://www.ultratech-labs.com>

File #: CNI-027FCC15CE

June 10, 2005

All test results contained in this engineering test report are traceable to National Institute of Standards and Technology (NIST)

Plot 61: Lower Band-Edge, Horizontal Polarization
Power Setting: 10 dBm, Frequency: 2412 MHz, Modulation: IEEE 802.11g - 54 Mbps
Delta Trace 1 & Trace 2: 9.22 dB
Trace 1 : RBW= 1 MHz, VBW= 3 MHz
Trace 2 : RBW= 100 kHz, VBW= 1 MHz

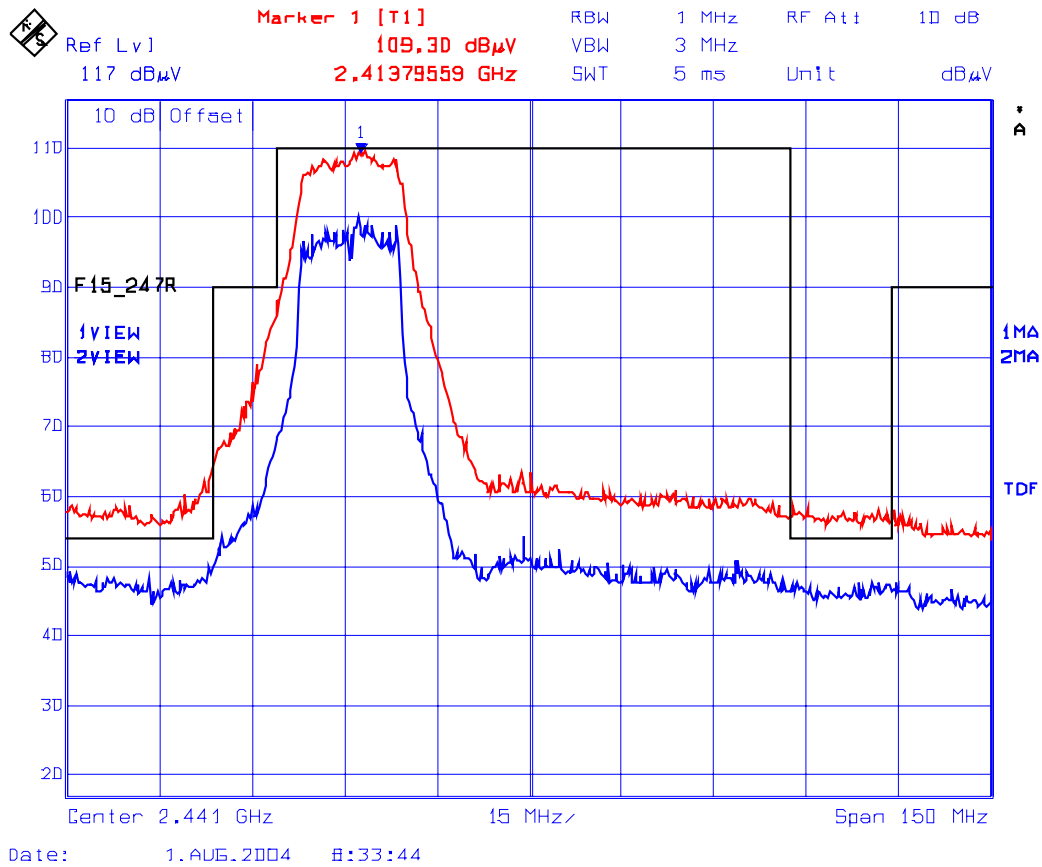

ULTRATECH GROUP OF LABS

3000 Bristol Circle, Oakville, Ontario, Canada L6H 6G4
Tel. #: 905-829-1570, Fax. #: 905-829-8050, Email: vic@ultratech-labs.com, Website: <http://www.ultratech-labs.com>

File #: CNI-027FCC15CE

June 10, 2005

All test results contained in this engineering test report are traceable to National Institute of Standards and Technology (NIST)

Plot 62: Lower Band-Edge, Vertical Polarization
Power Setting: 10 dBm, Frequency: 2412 MHz, Modulation: IEEE 802.11g - 54 Mbps
Delta Trace 1 & Trace 2: 9.73 dB
Trace 1 : RBW= 1 MHz, VBW= 3 MHz
Trace 2 : RBW= 100 kHz, VBW= 1 MHz

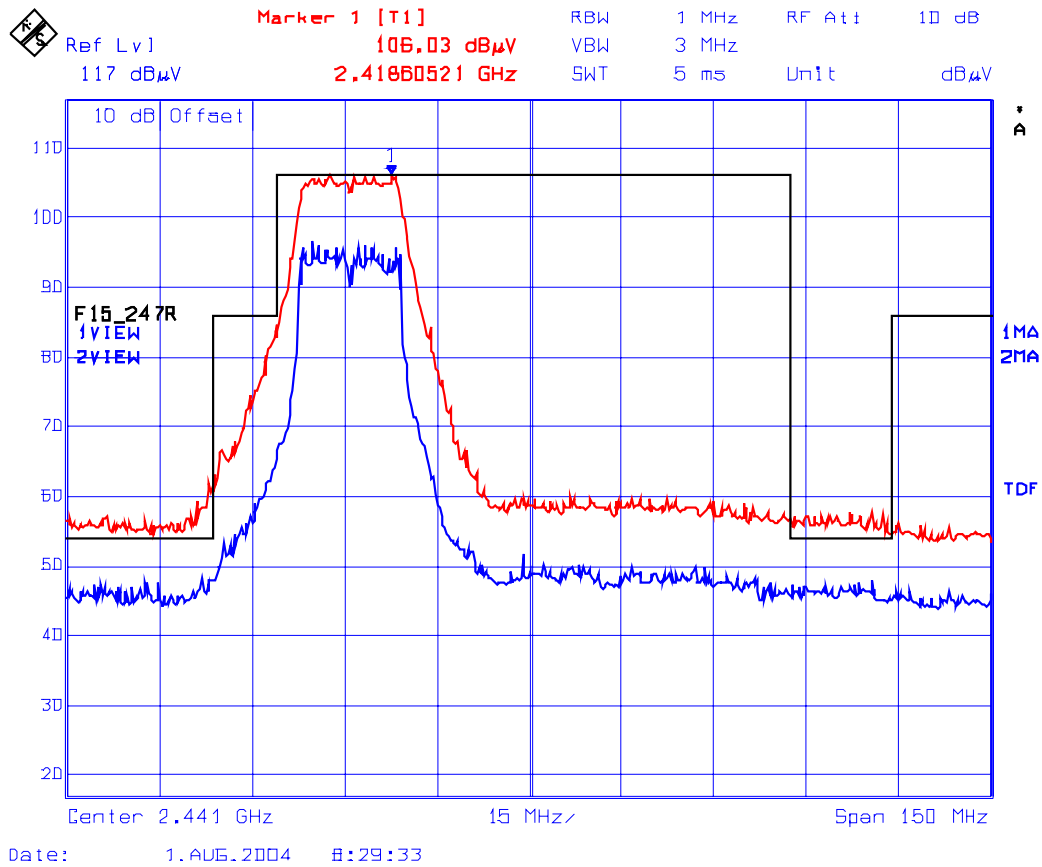

Plot 63: **Upper Band-Edge, Horizontal Polarization**
Power Setting: 10 dBm, Frequency: 2462 MHz, Modulation: IEEE 802.11g - 54 Mbps
Delta Trace 1 & Trace 2: 9.96 dB
Trace 1 : RBW= 1 MHz, VBW= 3 MHz
Trace 2 : RBW= 100 kHz, VBW= 1 MHz

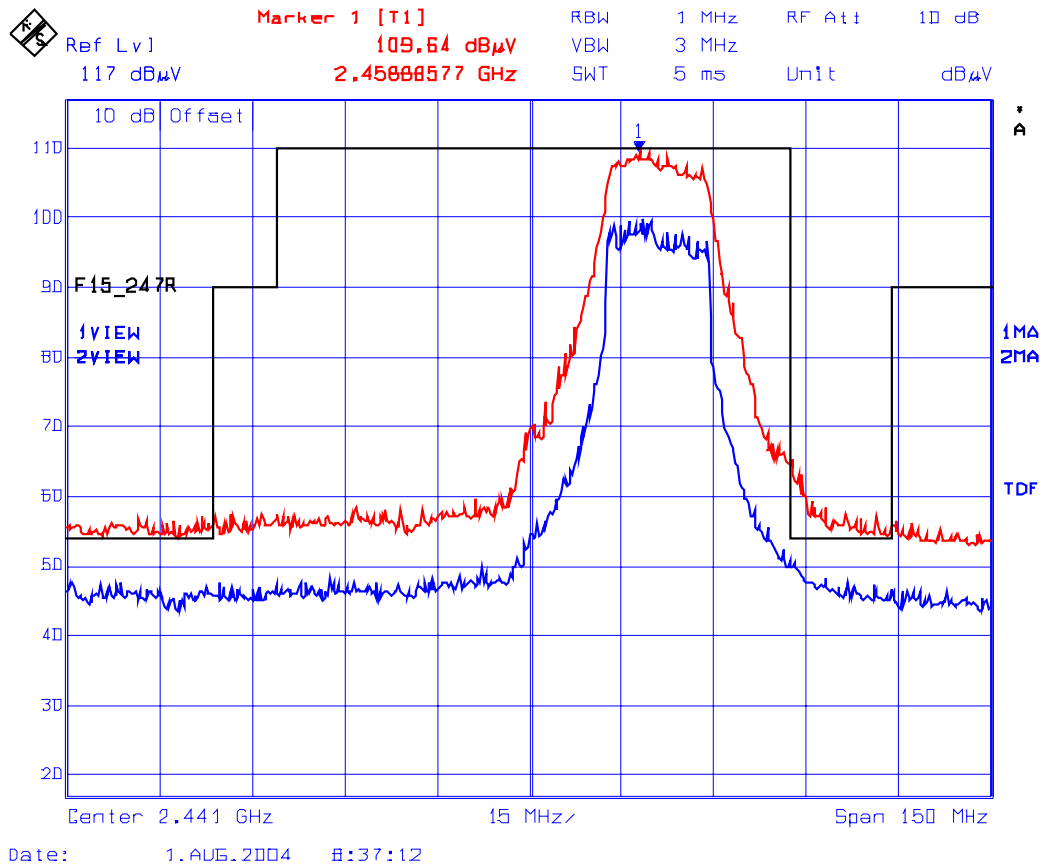

Plot 64: Upper Band-Edge, Vertical Polarization
Power Setting: 10 dBm, Frequency: 2462 MHz, Modulation: IEEE 802.11g - 54 Mbps
Delta Trace 1 & Trace 2: 9.44 dB
Trace 1 : RBW= 1 MHz, VBW= 3 MHz
Trace 2 : RBW= 100 kHz, VBW= 1 MHz

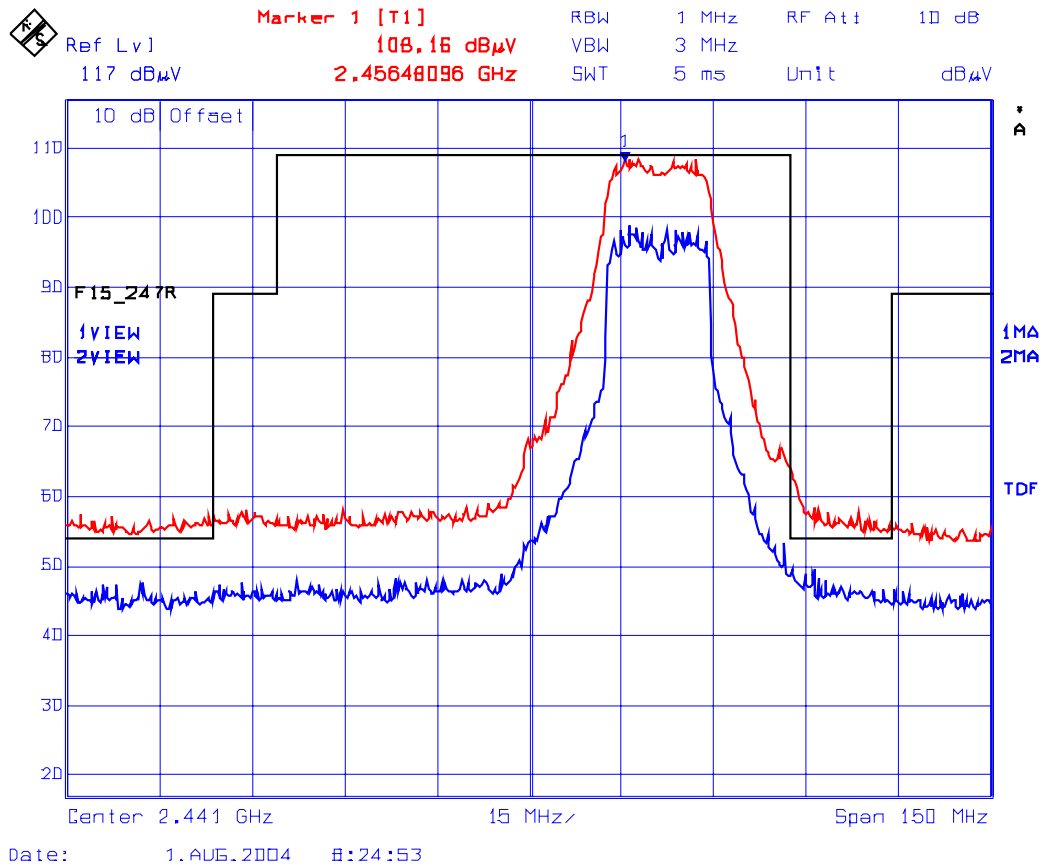

7.6.5.1.2. Internal Antenna

Note: Power setting for 802.11b modulation type was reduced from 20dBm to 18dBm for compliance with band-edge emissions.

Plot 65: Lower Band-Edge, Horizontal Polarization
Power Setting: 18dBm, Frequency: 2412 MHz, Modulation: IEEE 802.11b - 11 Mbps
Delta Trace 1 & Trace 2: 6.11 dB
Trace 1 (red): RBW= 1 MHz, VBW= 3 MHz
Trace 2 (blue): RBW= 100 kHz, VBW= 1 MHz
Marker 2: 2386.14 MHz, 63.97 dBμV/m (Peak), 52.04 dBμV/m (Avg)

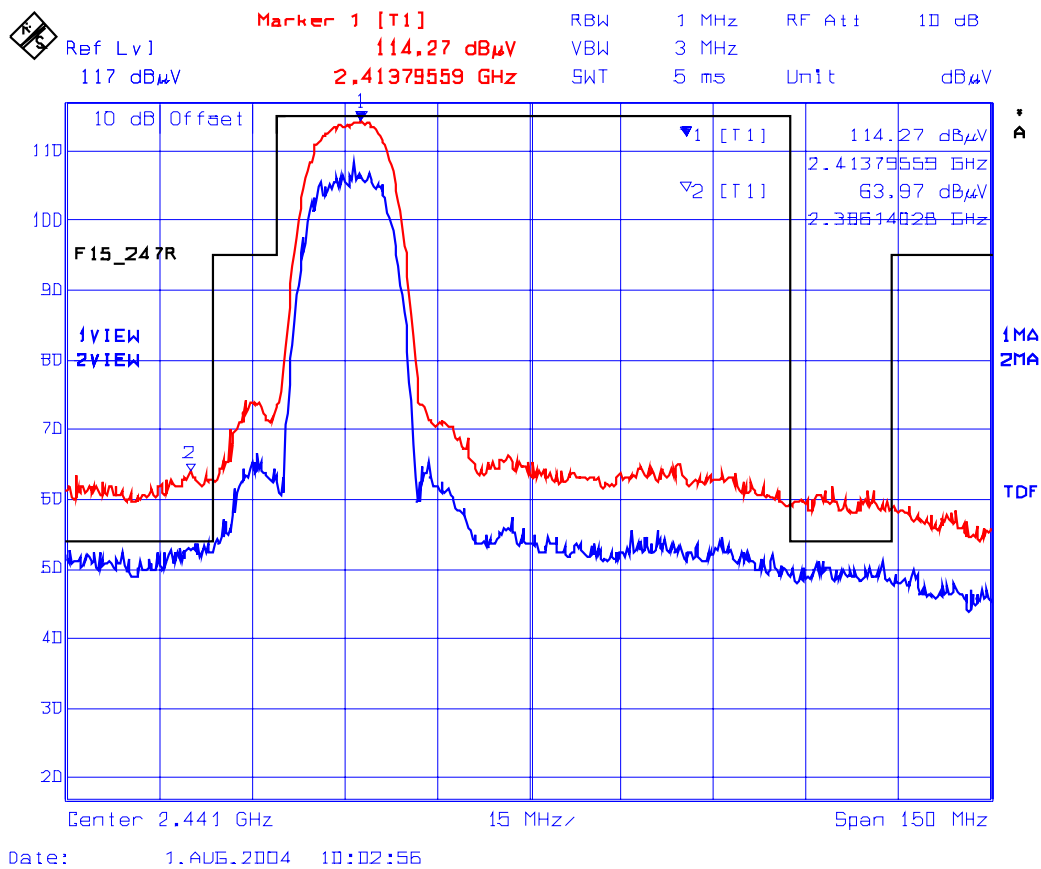

Plot 66: Lower Band-Edge, Vertical Polarization
 Power Setting: 18dBm, Frequency: 2412 MHz, Modulation: IEEE 802.11b - 11 Mbps
 Delta Trace 1 & Trace 2: 5.80 dB
 Trace 1 : RBW= 1 MHz, VBW= 3 MHz
 Trace 2 : RBW= 100 kHz, VBW= 1 MHz
 Marker 2: 2385.83 MHz, 61.52 dBμV/m (Peak), 50.59 dBμV/m (Avg)

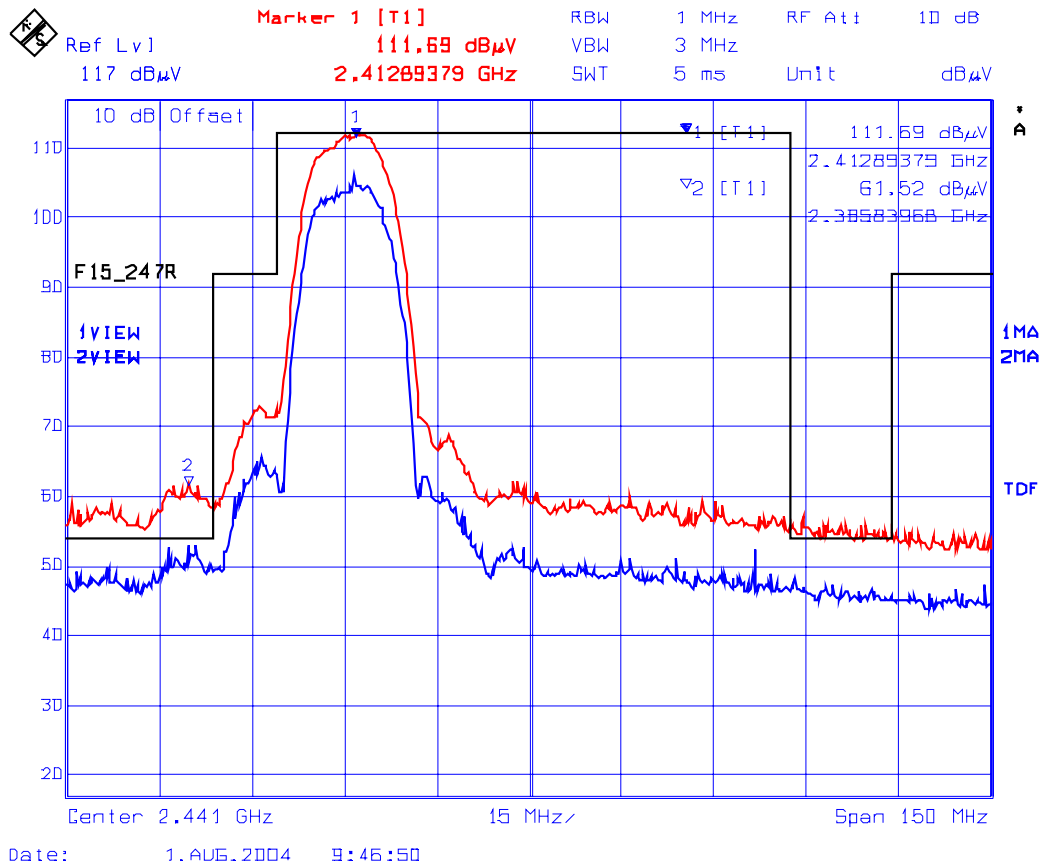

Plot 67: Upper Band-Edge, Horizontal Polarization
 Power Setting: 18dBm, Frequency: 2462 MHz, Modulation: IEEE 802.11b - 11 Mbps
 Delta Trace 1 & Trace 2: 7 dB
 Trace 1 : RBW= 1 MHz, VBW= 3 MHz
 Trace 2 : RBW= 100 kHz, VBW= 1 MHz
 Marker 2: 2488.04 MHz, 60.87 dB μ V/m (Peak), 48.91 dB μ V/m (Avg)

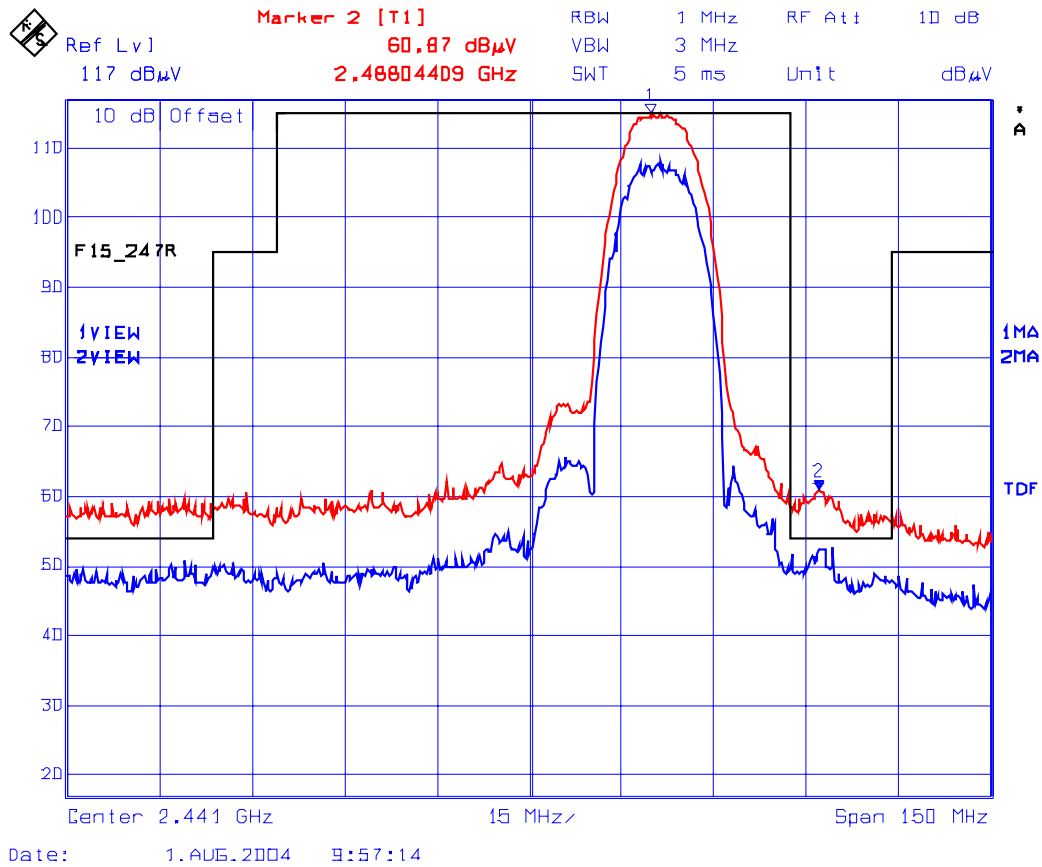

Plot 68: Upper Band-Edge, Vertical Polarization
Power Setting: 18dBm, Frequency: 2462 MHz, Modulation: IEEE 802.11b - 11 Mbps
Delta Trace 1 & Trace 2: 7.58 dB
Trace 1 : RBW= 1 MHz, VBW= 3 MHz
Trace 2 : RBW= 100 kHz, VBW= 1 MHz
Marker 2: 2489.54 MHz, 58.71 dB μ V/m (Peak), 47.74 dB μ V/m (Avg)

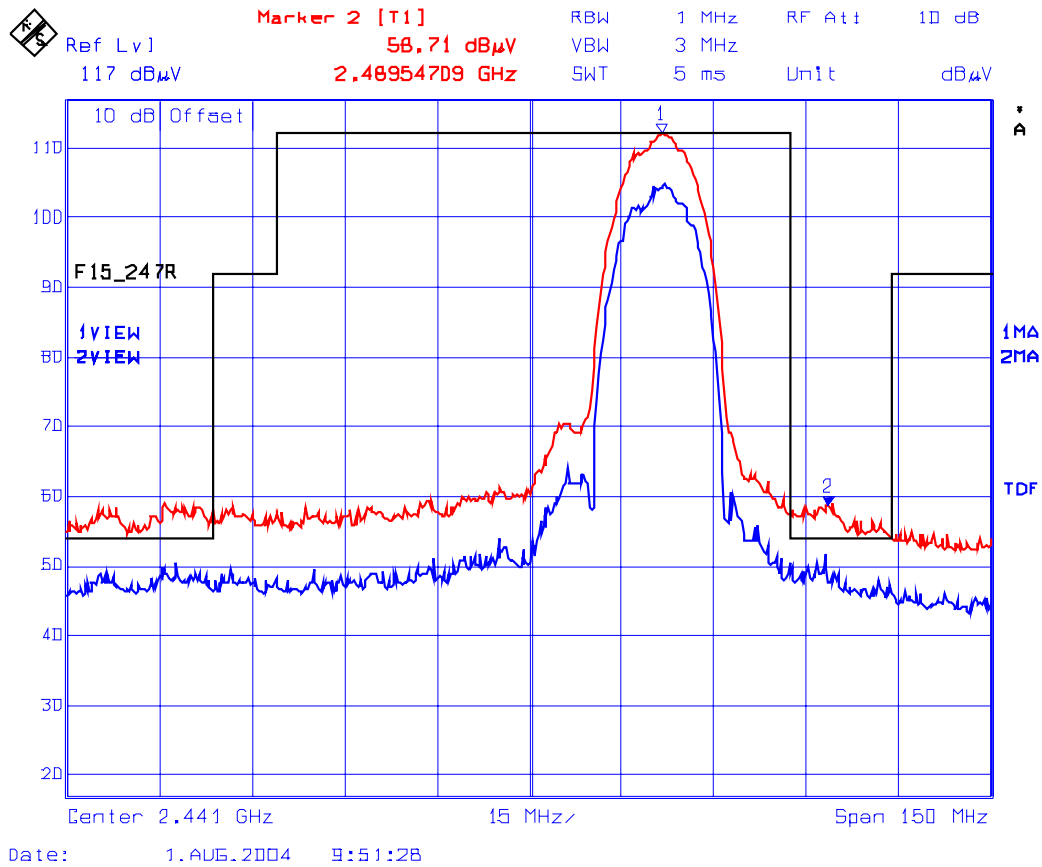

Plot 69: Lower Band-Edge, Horizontal Polarization
Power Setting: 13 dBm, Frequency: 2412 MHz, Modulation: IEEE 802.11g - 9 Mbps
Delta Trace 1 & Trace 2: 9.34 dB
Trace 1 : RBW= 1 MHz, VBW= 3 MHz
Trace 2 : RBW= 100 kHz, VBW= 1 MHz
Marker 2: 2388.54 MHz, 70.64 dB μ V/m (Peak), 50.86 dB μ V/m

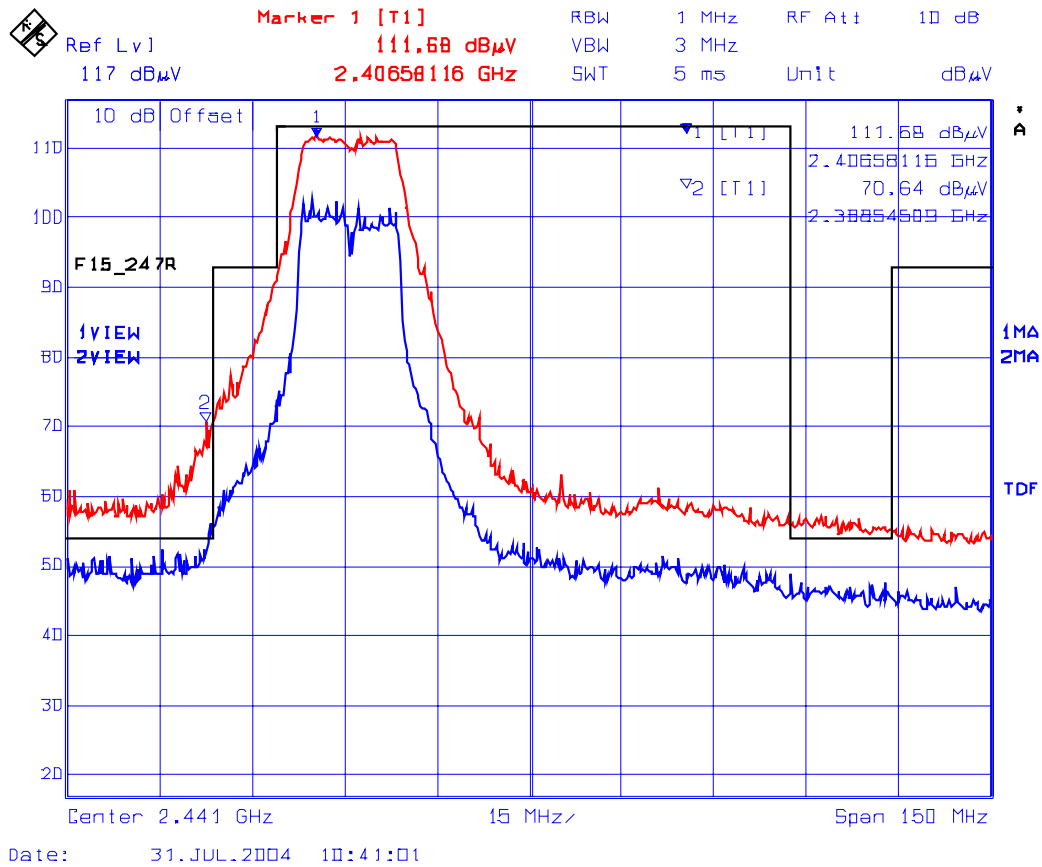

Plot 70: Lower Band-Edge, Vertical Polarization
Power Setting: 13 dBm, Frequency: 2412 MHz, Modulation: IEEE 802.11g - 9 Mbps
Delta Trace 1 & Trace 2: 8.91 dB
Trace 1 : RBW = 1 MHz, VBW = 3 MHz
Trace 2 : RBW = 100 kHz, VBW = 1 MHz

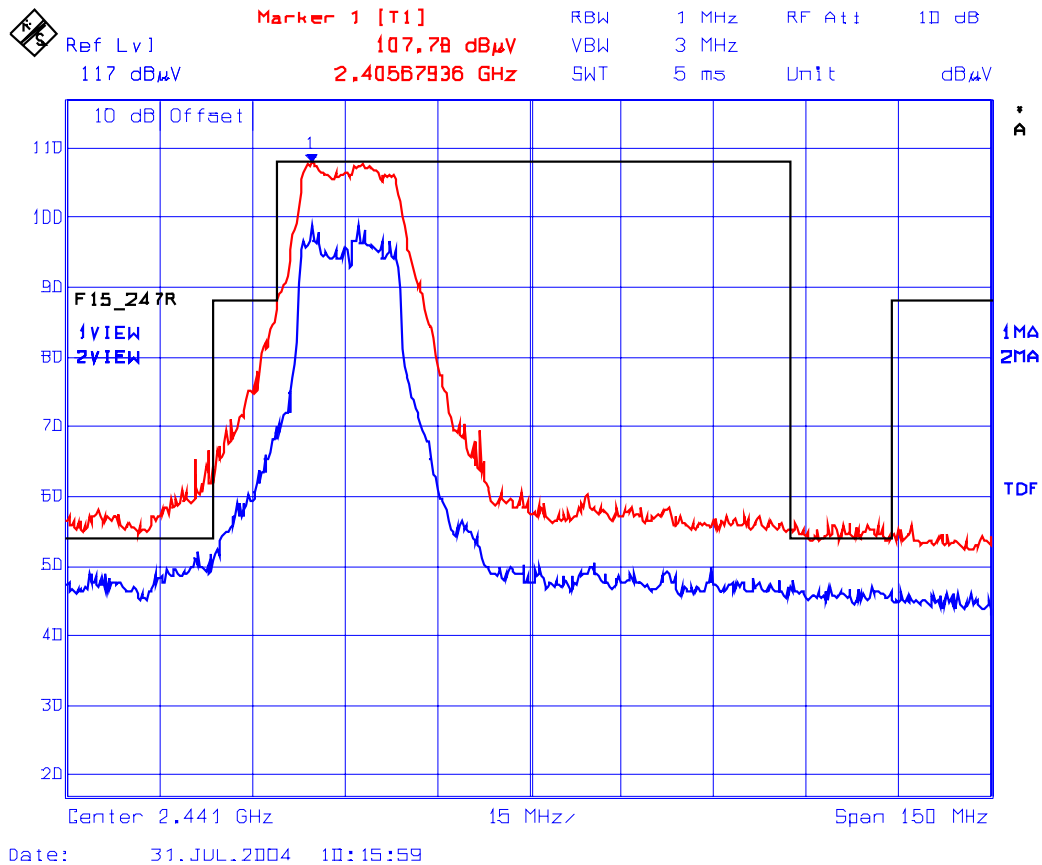

Plot 71: Upper Band-Edge, Horizontal Polarization
Power Setting: 13 dBm, Frequency: 2462 MHz, Modulation: IEEE 802.11g - 9 Mbps
Delta Trace 1 & Trace 2: 9.83 dB
Trace 1 : RBW = 1 MHz, VBW = 3 MHz
Trace 2 : RBW = 100 kHz, VBW = 1 MHz

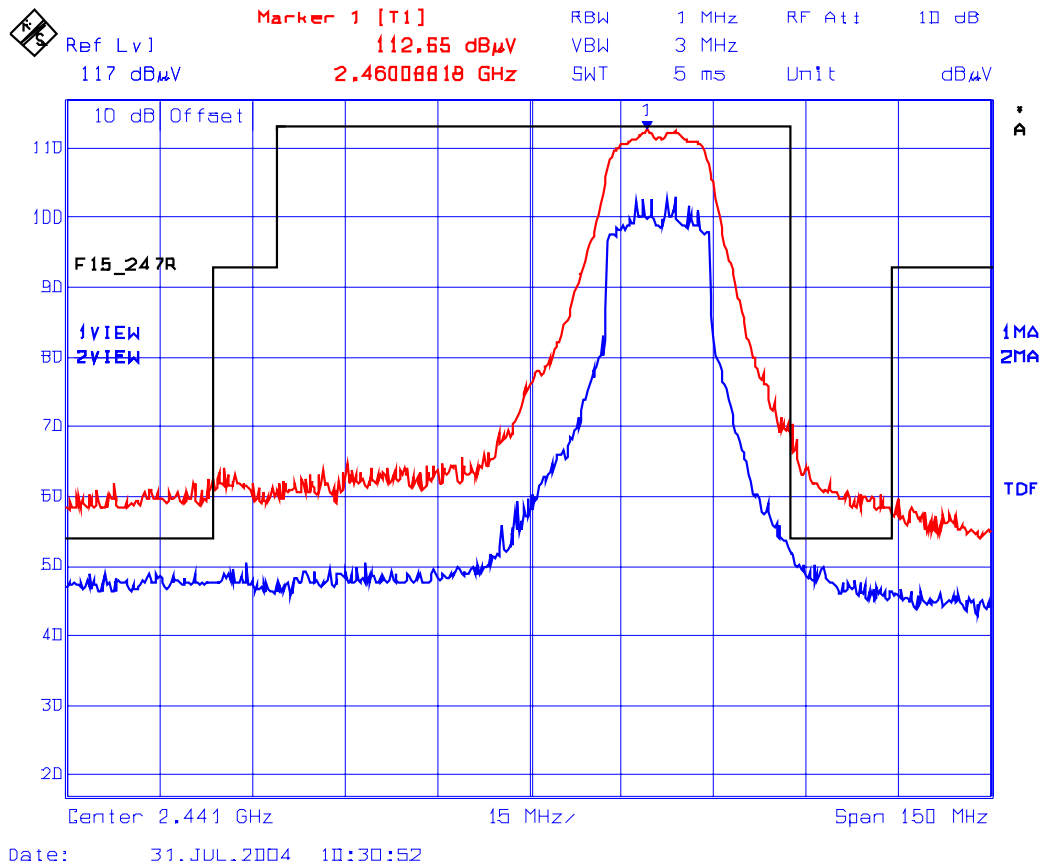

Plot 72: Upper Band-Edge, Vertical Polarization
 Power Setting: 13 dBm, Frequency: 2462 MHz, Modulation: IEEE 802.11g - 9 Mbps
 Delta Trace 1 & Trace 2: 9.18 dB
 Trace 1 : RBW= 1 MHz, VBW= 3 MHz
 Trace 2 : RBW= 100 kHz, VBW= 1 MHz

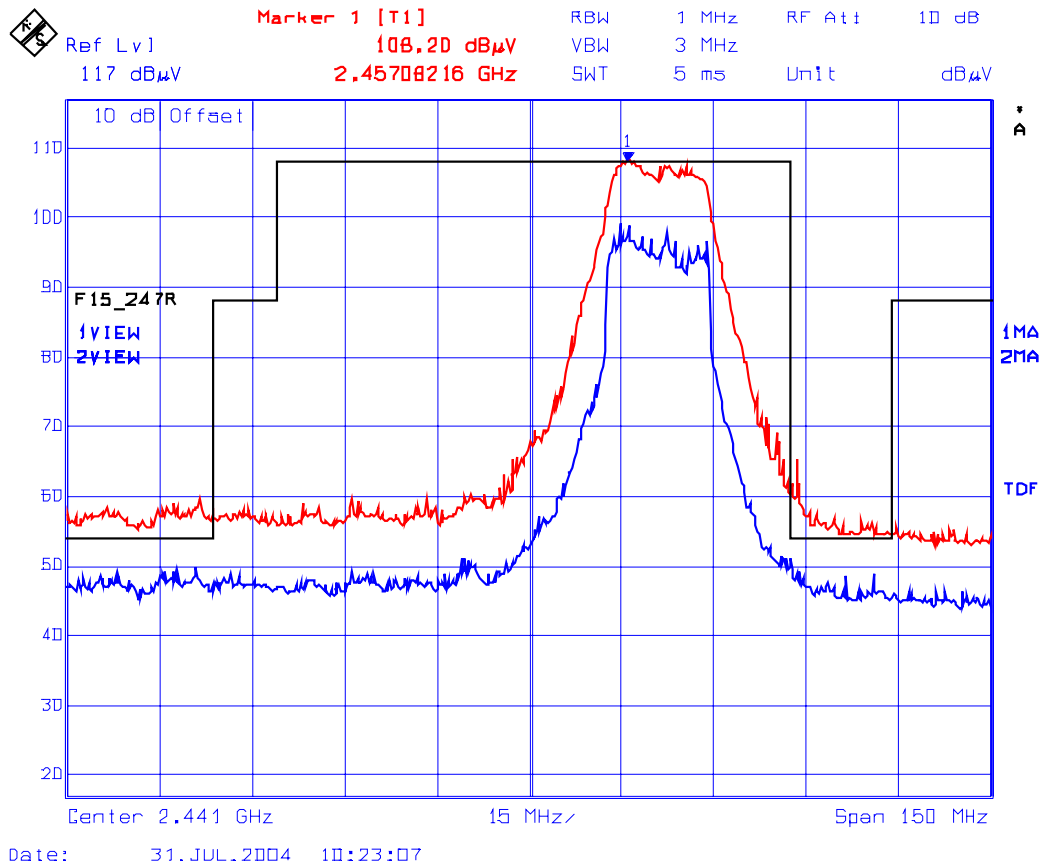

Plot 73: Lower Band-Edge, Horizontal Polarization
Power Setting: 10 dBm, Frequency: 2412 MHz, Modulation: IEEE 802.11g - 54 Mbps
Delta Trace 1 & Trace 2: 9.13 dB
Trace 1 : RBW = 1 MHz, VBW = 3 MHz
Trace 2 : RBW = 100 kHz, VBW = 1 MHz

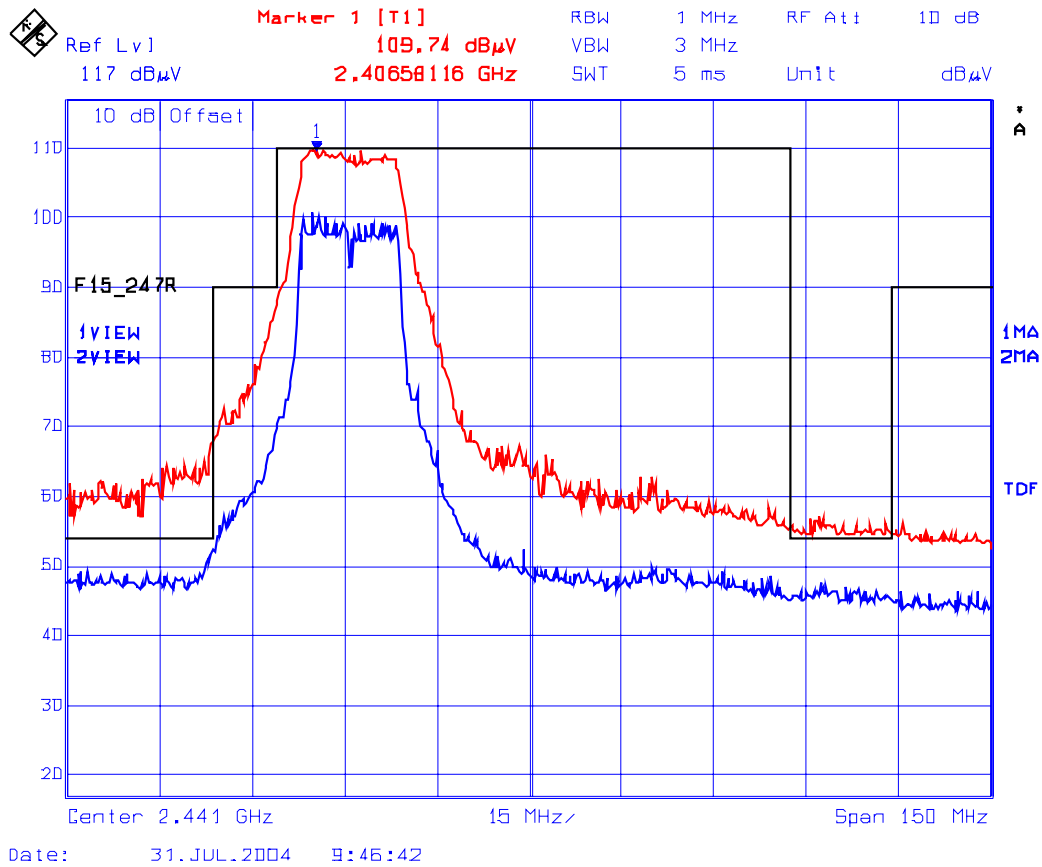

Plot 74: Lower Band-Edge, Vertical Polarization
Power Setting: 10 dBm, Frequency: 2412 MHz, Modulation: IEEE 802.11g - 54 Mbps
Delta Trace 1 & Trace 2: 8.35 dB
Trace 1 : RBW = 1 MHz, VBW = 3 MHz
Trace 2 : RBW = 100 kHz, VBW = 1 MHz

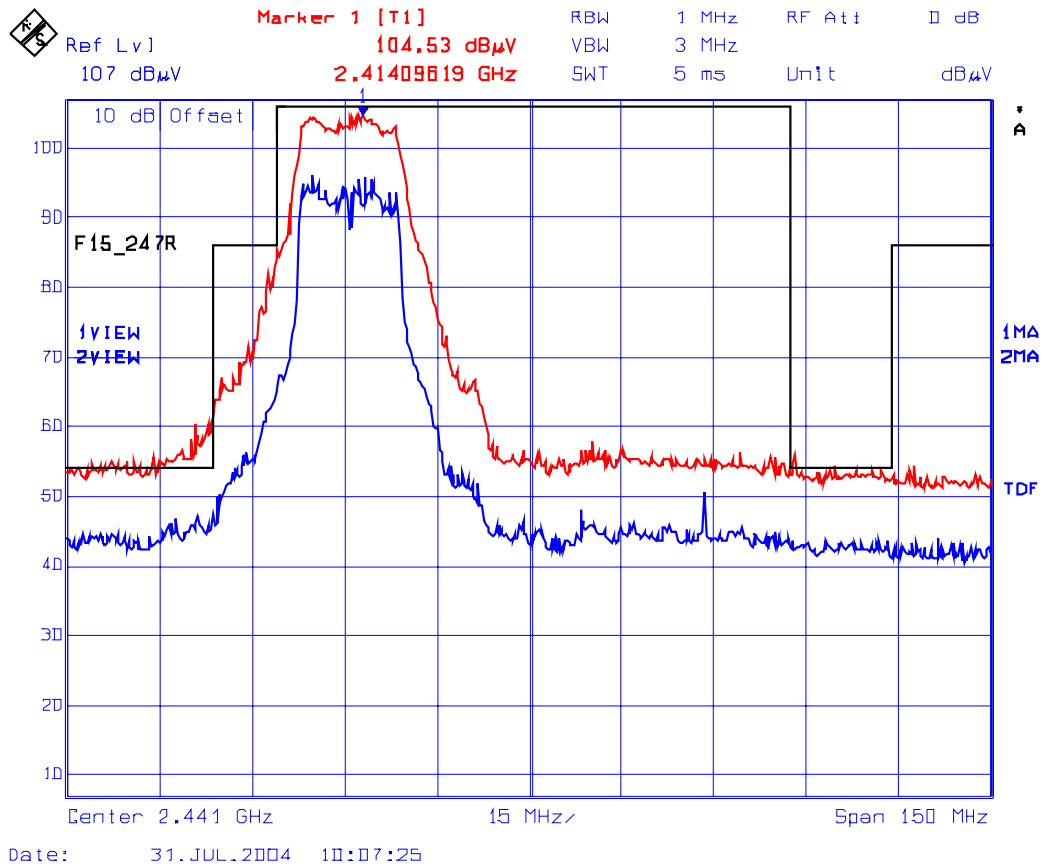

Plot 75: Upper Band-Edge, Horizontal Polarization
Power Setting: 10 dBm, Frequency: 2462 MHz, Modulation: IEEE 802.11g - 54 Mbps
Delta Trace 1 & Trace 2: 9.24 dB
Trace 1 : RBW = 1 MHz, VBW = 3 MHz
Trace 2 : RBW = 100 kHz, VBW = 1 MHz

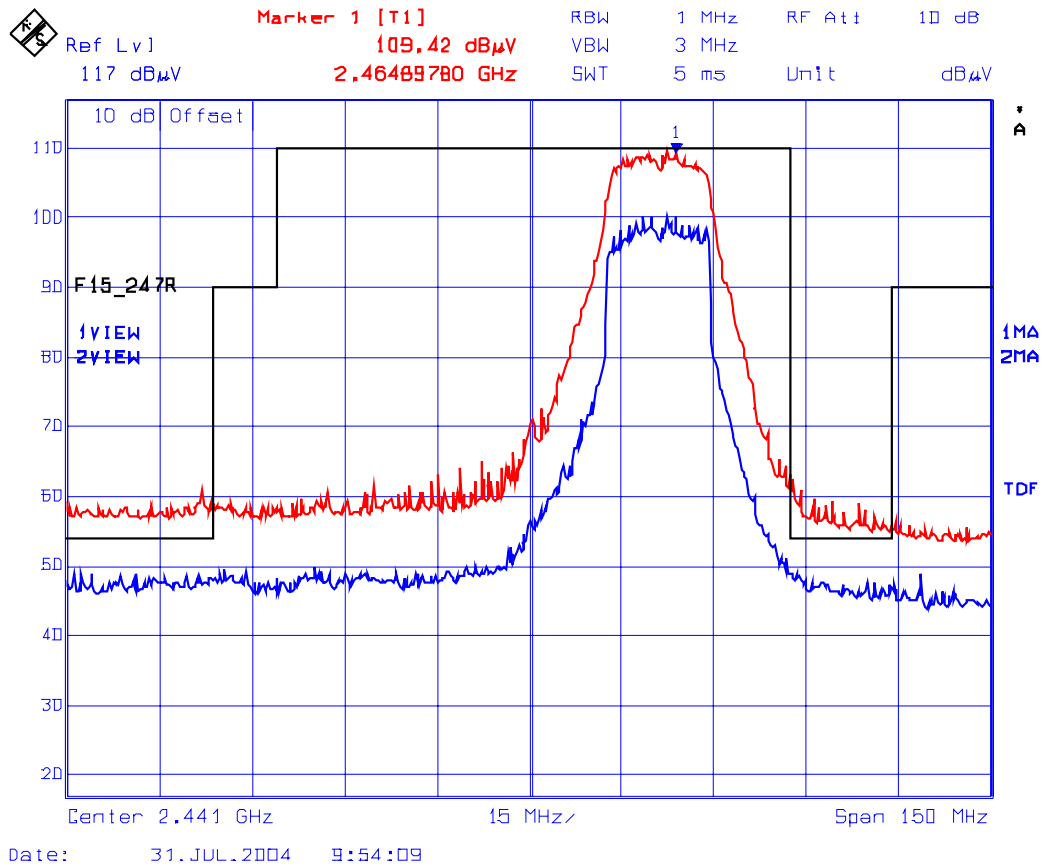

Plot 76: Upper Band-Edge, Vertical Polarization
Power Setting: 10 dBm, Frequency: 2462 MHz, Modulation: IEEE 802.11g - 54 Mbps
Delta Trace 1 & Trace 2: 8.79 dB
Trace 1 : RBW = 1 MHz, VBW = 3 MHz
Trace 2 : RBW = 100 kHz, VBW = 1 MHz

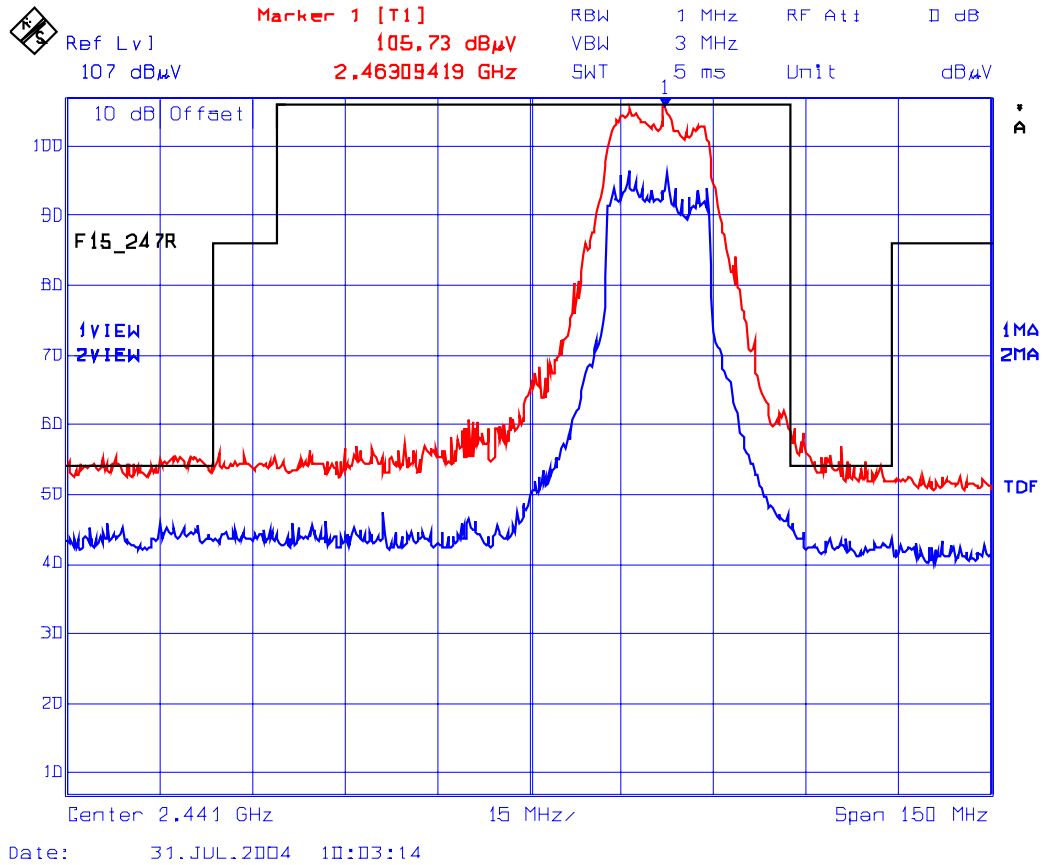

7.6.5.2. Transmitter Spurious Emissions (Radiated at 3 Meters)

Remarks:

- 1) Tests were performed with both modulations IEEE 802.11b and IEEE 802.11g (OFDM).
- 2) The emissions were scanned from 10 MHz to 25 GHz and all emissions less 20 dB below the limits were recorded.

7.6.5.3. External Antenna

Note: The following measurements represent the tests results for both test configurations: modulation IEEE 802.11b and IEEE 802.11g (OFDM).

7.6.5.3.1.1. Lowest Frequency (2412 MHz)

Frequency (MHz)	RF Peak Level (dBµV/m)	RF AVG Level (dBµV/m)	Antenna Plane (H/V)	Limit 15.209 (dBµV/m)	Limit 15.247 (dBµV/m)	Margin (dB)	Pass/Fail
All emissions were more than 20 dB below the permissible limits.							

7.6.5.3.1.2. Middle Frequency (2437 MHz)

Frequency (MHz)	RF Peak Level (dBµV/m)	RF AVG Level (dBµV/m)	Antenna Plane (H/V)	Limit 15.209 (dBµV/m)	Limit 15.247 (dBµV/m)	Margin (dB)	Pass/Fail
All emissions were more than 20 dB below the permissible limits.							

7.6.5.3.1.3. Highest Frequency (2462 MHz)

Frequency (MHz)	RF Peak Level (dBµV/m)	RF AVG Level (dBµV/m)	Antenna Plane (H/V)	Limit 15.209 (dBµV/m)	Limit 15.247 (dBµV/m)	Margin (dB)	Pass/Fail
All emissions were more than 20 dB below the permissible limits.							

7.6.5.4. Internal Antenna

7.6.5.4.1. Lowest Frequency (2412 MHz), Modulation: IEEE 802.11b

Frequency (MHz)	RF Peak Level (dBµV/m)	RF AVG Level (dBµV/m)	Antenna Plane (H/V)	Limit 15.209 (dBµV/m)	Limit 15.247 (dBµV/m)	Margin (dB)	Pass/Fail
2412	111.69	--	V	--	--	--	--
2412	114.27	--	H	--	--	--	--
4824	62.16	49.52	V	54.0	91.7	-4.48	* Pass
4824	62.42	48.93	H	54.0	91.7	-5.07	* Pass

*Frequency in restricted frequency band.

7.6.5.4.2. Lowest Frequency (2412 MHz), Modulation: IEEE 802.11g (OFDM)

Frequency (MHz)	RF Peak Level (dBµV/m)	RF AVG Level (dBµV/m)	Antenna Plane (H/V)	Limit 15.209 (dBµV/m)	Limit 15.247 (dBµV/m)	Margin (dB)	Pass/Fail
All emissions were more than 20 dB below the permissible limits.							

7.6.5.4.3. Middle Frequency (2437 MHz), Modulation: IEEE 802.11b

Frequency (MHz)	RF Peak Level (dBµV/m)	RF AVG Level (dBµV/m)	Antenna Plane (H/V)	Limit 15.209 (dBµV/m)	Limit 15.247 (dBµV/m)	Margin (dB)	Pass/Fail
2437	110.92	--	V	--	--	--	--
2437	114.89	--	H	--	--	--	--
7311	62.97	50.75	V	54.0	90.9	-3.25	* Pass
7311	63.43	51.24	H	54.0	90.9	-2.76	* Pass

*Frequency in restricted frequency band.

7.6.5.4.4. Middle Frequency (2437 MHz), Modulation: IEEE 802.11g (OFDM)

Frequency (MHz)	RF Peak Level (dBµV/m)	RF AVG Level (dBµV/m)	Antenna Plane (H/V)	Limit 15.209 (dBµV/m)	Limit 15.247 (dBµV/m)	Margin (dB)	Pass/Fail
All emissions were more than 20 dB below the permissible limits.							

7.6.5.4.5. Highest Frequency (2462 MHz), Modulation: IEEE 802.11b

Frequency (MHz)	RF Peak Level (dB μ V/m)	RF AVG Level (dB μ V/m)	Antenna Plane (H/V)	Limit 15.209 (dB μ V/m)	Limit 15.247 (dB μ V/m)	Margin (dB)	Pass/Fail
2462	115.39	--	V	--	--	--	--
2462	115.18	--	H	--	--	--	--
7386	62.74	49.56	V	54.0	95.2	-4.44	* Pass
7386	63.41	50.84	H	54.0	95.2	-3.16	* Pass

*Frequency in restricted frequency band.

7.6.5.4.6. Highest Frequency (2462 MHz), Modulation: IEEE 802.11g

Frequency (MHz)	RF Peak Level (dB μ V/m)	RF AVG Level (dB μ V/m)	Antenna Plane (H/V)	Limit 15.209 (dB μ V/m)	Limit 15.247 (dB μ V/m)	Margin (dB)	Pass/Fail
All emissions were more than 20 dB below the permissible limits.							

EXHIBIT 8. TEST DATA [§ 15.407 – OPERATION IN 5.15-5.825 GHz]

8.1. DISCONTINUATION OF TRANSMISSION [§ 15.407(c)]

8.1.1. Limits

The device shall automatically discontinue transmission in case of either absence of information to transmit or operational failure. These provisions are not intended to preclude the transmission of control or signalling information or the use of repetitive codes used by certain digital technologies to complete frame or burst intervals. Applicants shall include in their application for equipment authorization a description of how this requirement is met.

8.1.2. Analysis

Please refer to the description of how the device is automatically discontinue transmission in case of either absence of information to transmit or operational failure in the user manual.

8.2. FREQUENCY STABILITY [§ 15.407(g)]

8.2.1. Limits

Manufacturers of U-NII devices are responsible for ensuring frequency stability such that an emission is maintained within the band of operation under all conditions of normal operation as specified in the users manual.

8.2.2. Method of Measurements

47 CFR § 2.1055.

8.2.3. Test Equipment List

Test Instruments	Manufacturer	Model No.	Serial No.	Frequency Range
Spectrum Analyzer/ EMI Receiver	Hewlett Packard	HP 8593EM	3412A00103	9 kHz – 26.5 GHz
Attenuator(s)	Bird	DC – 22 GHz
Temperature & Humidity Chamber	Tenney	T5	9723B	-40° to +60° C range

8.2.4. Test Arrangement

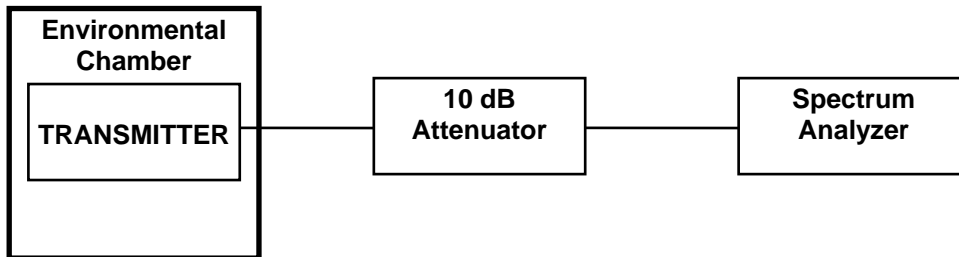

8.2.5. Test Data

Product Name:	Altitude 350-2 Access Point
Model No.:	Altitude 350-2
Temperature Ratings by Manufacturer:	Operating Temperature 0 – 50 deg. C
Center Frequency:	5260 MHz
Full Power Level:	20.6 dBm
Frequency Tolerance Limit:	Emission must be maintained within the band of operation under all conditions of normal operation as specified. The closest operating channel to the band edge is 20 MHz. Therefore, frequency drift shall not exceed 20 MHz.
Max. Frequency Tolerance Measured:	+60900 Hz
Input Voltage Rating:	6 Vdc

CENTER FREQUENCY & RF POWER OUTPUT VARIATION			
Ambient Temperature (°C)	Supply Voltage (Nominal) 6 Vdc	Supply Voltage (85% of Nominal) 5.1 Vdc	Supply Voltage (115% of Nominal) 6.9 Vdc
	Hz	Hz	Hz
-30	+36600	N/A	N/A
+20	0	-143	+86 Hz
+50	+60900	N/A	N/A

8.3. POWER LIMITS & 26 dB BANDWIDTH [§ 15.407(a)]

8.3.1. Limits

15.407(a) - Power limits:

- (1) For the band 5.15-5.25 GHz, the peak transmit power over the frequency band of operation shall not exceed the lesser of 50 mW or $4 \text{ dBm} + 10\log B$, where B is the 26-dB emission bandwidth in MHz. In addition, the peak power spectral density shall not exceed 4 dBm in any 1-MHz band. If transmitting antennas of directional gain greater than 6 dBi are used, both the peak transmit power and the peak power spectral density shall be reduced by the amount in dB that the directional gain of the antenna exceeds 6 dBi.
- (2) For the band 5.25-5.35 GHz and 5.47-5.725 GHz, the peak transmit power over the frequency band of operation shall not exceed the lesser of 250 mW or $11 \text{ dBm} + 10\log B$, where B is the 26-dB emission bandwidth in MHz. In addition, the peak power spectral density shall not exceed 11 dBm in any 1-MHz band. If transmitting antennas of directional gain greater than 6 dBi are used, both the peak transmit power and the peak power spectral density shall be reduced by the amount in dB that the directional gain of the antenna exceeds 6 dBi.
- (3) For the band 5.725-5.825 GHz, the peak transmit power over the frequency band of operation shall not exceed the lesser of 1 W or $17 \text{ dBm} + 10\log B$, where B is the 26-dB emission bandwidth in MHz. In addition, the peak power spectral density shall not exceed 17 dBm in any 1-MHz band. If transmitting antennas of directional gain greater than 6 dBi are used, both the peak transmit power and the peak power spectral density shall be reduced by the amount in dB that the directional gain of the antenna exceeds 6 dBi. However, fixed point-to-point U-NII devices operating in this band may employ transmitting antennas with directional gain up to 23 dBi without any corresponding reduction in the transmitter peak output power or peak power spectral density. For fixed, point-to-point U-NII transmitters that employ a directional antenna gain greater than 23 dBi, a 1 dB reduction in peak transmitter power and peak power spectral density for each 1 dB of antenna gain in excess of 23 dBi would be required. Fixed, point-to-point operations exclude the use of point-to-multipoint systems, omni directional applications, and multiple collocated transmitters transmitting the same information. The operator of the U-NII device, or if the equipment is professionally installed, the installer, is responsible for ensuring that systems employing high gain directional antennas are used exclusively for fixed, point-to-point operations. Note to paragraph (a)(3): The Commission strongly recommends that parties employing U-NII devices to provide critical communications services should determine if there are any nearby Government radar systems that could affect their operation.

8.3.2. Method of Measurements

@ FCC § 15.407(a):

- (4) The peak transmit power must be measured over any interval of continuous transmission using instrumentation calibrated in terms of an rms-equivalent voltage. The measurement results shall be properly adjusted for any instrument limitations, such as detector response times, limited resolution bandwidth capability when compared to the emission bandwidth, sensitivity, etc., so as to obtain a true peak measurement conforming to the definitions in this paragraph for the emission in question.
- (5) The peak power spectral density is measured as a conducted emission by direct connection of a calibrated test instrument to the equipment under test. If the device cannot be connected directly, alternative techniques acceptable to the Commission may be used. Measurements are made over a bandwidth of 1 MHz or the 26 dB emission bandwidth of the device, whichever is less. A resolution bandwidth less than the measurement bandwidth can be used, provided that the measured power is integrated to show total power over the measurement bandwidth. If the resolution bandwidth is approximately equal to the measurement bandwidth, and much less than the emission bandwidth of the equipment under test, the measured results shall be corrected to account for any difference between the resolution bandwidth of the test instrument and its actual noise bandwidth.
- (6) The ratio of the peak excursion of the modulation envelope (measured using a peak hold function) to the peak transmit power (measured as specified in this paragraph) shall not exceed 13 dB across any 1 MHz bandwidth or the emission bandwidth whichever is less.

8.3.2.1. Guidelines for Emission Bandwidth "B"

Emission Bandwidth "B" MHz can be measured using a spectrum analyzer with the following setting:

- Use a RBW = 1% of the emission bandwidth.
- Set the VBW > RBW
- Use a peak detector.
- Do not use the Max Hold function. Rather, use the view button to capture the emission.
- Measure the widest width of the emission that is 26 dB down from the peak of the emission.

8.3.2.2. Guidelines for Peak Conducted Transmit Output Power

8.3.2.2.1. Peak conducted transmit output power

1. In the following, "T" is the transmission pulse duration over which the transmitter is on and transmitting at its maximum power control level.
2. Measurements are performed with a spectrum analyzer.
3. Three methods are provided to accommodate measurement limitations of the spectrum analyzer depending on signal parameters.
4. Set resolution bandwidth (RBW) = 1 MHz.
5. Set span to encompass the entire emission bandwidth (EBW) of the signal. Use automatic setting for analyzer sweep time (except in Method #2).
6. Check the sweep time to determine which procedure to use.
 - If sweep time $\leq T$, use Method #1 -- spectral trace averaging -- and sum the power across the band. Note that the hardware operation may be modified to extend the transmission time to achieve this condition for test purposes. (Method #1 may be used only if it results in averaging over intervals during which the transmitter is

operating at its maximum power control level; intervals during which the transmitter is off or is transmitting at a reduced power level must not be included in the average.)

- If sweep time $> T$, then the choice of measurement procedure will depend on the EBW of the signal.
- If $EBW \leq$ largest available RBW on the analyzer, use Method #2--zero-span mode with trace averaging--and find the temporal peak. (Method #2 may be used only if it results in averaging over intervals during which the transmitter is operating at its maximum power control level; intervals during which the transmitter is off or is transmitting at a reduced power level must not be included in the average.)
- If $EBW >$ largest available RBW, use Method #3--video averaging with max hold--and sum power across the band.

Method #1:

- Set span to encompass the entire emission bandwidth (EBW) of the signal.
- Set RBW = 1 MHz.
- Set VBW \geq 3 MHz.
- Use sample detector mode if bin width (i.e., span/number of points in spectrum display) $<$ 0.5 RBW. Otherwise use peak detector mode
- Use a video trigger with the trigger level set to enable triggering only on full power pulses. Transmitter must operate at full control power for entire sweep of every sweep. If the device transmits continuously, with no off intervals or reduced power intervals, the trigger may be set to "free run".
- Trace average 100 traces in power averaging mode.
- Compute power by integrating the spectrum across the 26 dB EBW of the signal. The integration can be performed using the spectrum analyzer's band power measurement function with band limits set equal to the EBW band edges or by summing power levels in each 1 MHz band in linear power terms. The 1 MHz band power levels to be summed can be obtained by averaging, in linear power terms, power levels in each frequency bin across the 1 MHz.

Method #2:

- Set zero span mode. Set center frequency to the midpoint between the -26 dB points of the signal.
- Set RBW \geq EBW.
- Set VBW \geq 3 RBW. [If VBW \geq 3 RBW is not available, use highest available VBW, but VBW must be \geq RBW]
- Set sweep time = T
- Use sample detector mode.
- Use a video trigger with the trigger level set to enable triggering only on full power pulses.
- Trace average 100 traces in power averaging mode.
- Find the peak of the resulting average trace.

Method #3:

- Set span to encompass the entire emission bandwidth (EBW) of the signal.
- Set sweep trigger to “free run”.
- Set RBW = 1 MHz. Set VBW \geq 1/T
- Use linear display mode.
- Use sample detector mode if bin width (i.e., span/number of points in spectrum) < 0.5 RBW. Otherwise use peak detector mode.
- Set max hold.
- Allow max hold to run for 60 seconds.
- Compute power by integrating the spectrum across the 26 dB EBW or apply a bandwidth correction factor of $10 \log(\text{EBW}/1 \text{ MHz})$ to the spectral peak of the emission. The integration can be performed using the spectrum analyzer’s band power measurement function with band limits set equal to the EBW band edges or by summing power levels in each 1 MHz band in linear power terms. The 1 MHz band power levels to be summed can be obtained by averaging, in linear power terms, power levels in each frequency bin across the 1 MHz.

Emission bandwidth “B” MHz:

- Use a RBW = approximately 1% of the emission bandwidth.
- Set the VBW > RBW
- Use a peak detector.
- Do not use the Max Hold function. Rather, use the view button to capture the emission.
- Measure the maximum width of the emission that is 26 dB down from the peak of the emission. Compare this with the RBW setting of the analyzer. Readjust RBW and repeat measurement as needed until the RBW/EBW ratio is approximately 1%.

Peak Power Spectral Density (PPSD):

This is an antenna conducted measurement using a spectrum analyzer. Method #2 provides the most accurate implementation of the rule; however, equipment limitations may preclude its use for short pulses. Method #1 is also acceptable to show compliance; it may overestimate the PPSD, but is easier to implement than method #2, and must be used when the conditions of method #2 cannot be achieved.

Method 1:

Use peak detector mode and max hold. Set RBW= 1MHz* and VBW > 1 MHz. The PPSD is the highest level found across the emission in any 1-MHz band.

Method 2:

Use sample detector and power averaging (not video averaging) mode. Set RBW= 1 MHz*, VBW > 1 MHz. The PPSD is the highest level found across the emission in any 1-MHz band after 100 sweeps of averaging. This method is permitted only if the transmission pulse or sequence of pulses remains at maximum transmit power throughout each of the 100 sweeps of averaging and that the interval between pulses is not included in any of the sweeps (e.g., 100 sweeps should occur during one transmission, or each sweep gated to occur during a transmission).

- When the emission bandwidth is less than 1 MHz, use a measurement bandwidth equal to the emission bandwidth, in accordance with Section 15.407(a)(5).
- It is permissible to use a resolution bandwidth less than the measurement bandwidth provided the measured power is integrated to show total power over the measurement bandwidth. The integration can be performed using the spectrum analyzer’s band power measurement function with band limits set equal to the measurement band edges or by summing power levels in each band in linear power terms.

Peak Excursion Measurement:

Set the spectrum analyzer span to view the entire emission bandwidth. The largest difference between the following two traces must be ≤ 13 dB for all frequencies across the emission bandwidth. Submit a plot.

- 1st Trace: Set RBW = 1 MHz, VBW ≥ 3 MHz with peak detector and Maxhold settings.
- 2nd Trace: If Method #1 was used for the peak conducted transmit output power test, then create the 2nd trace using the settings described in Method #1.
- If Methods #2 or #3 were used for the peak conducted transmit power test, then create the 2nd trace using the setting described in Method #3.

8.3.3. Test Arrangement

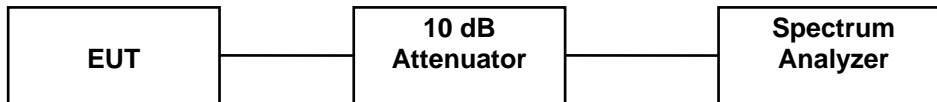

8.3.4. Test Equipment List

Test Instruments	Manufacturer	Model No.	Serial No.	Frequency Range
Spectrum Analyzer/ EMI Receiver	Advantest	R3271	15050203	100 Hz – 26.5 GHz
Spectrum Analyzer	Rohde & Schwarz	FSEK20/B4/B21	834157/005	9 kHz – 40 GHz
Microwave Amplifier	Hewlett Packard	HP 83017A		1 GHz to 26.5 GHz
Horn Antenna	EMCO	3155	9701-5061	1 GHz – 18 GHz
Horn Antenna	EMCO	3155	9911-5955	1 GHz – 18 GHz
RF Signal Generator	Hewlett Packard	HP 83752B	3610A00457	0.01 – 20 GHz
67297 RF Detector (Diode Detector)	Herotex	DZ122-553	63400	..
Storage Oscilloscope	Philips	PM3320A	ST9907959	--

8.3.5. Test Data

8.3.5.1. 26 dB Bandwidth & Calculation of Power Limits

Remark: Pre-scans were performed at different modulations and data rates to determine which test configurations yield the widest bandwidth. Modulation BPSK at 9 Mbps data rate yield the widest bandwidth. Therefore, the following 26dB bandwidth will be tested at this configuration and represents the worst-case measurements.

8.3.5.1.1. For the band 5.15-5.25 MHz

Channel Frequency (MHz)	Measured 26 dB Bandwidth [B] (MHz)	Peak Power Spectral Density in 1 MHz BW (dBm/MHz)	⁽¹⁾ Peak Power Limit @ 15.407(a) (dBm)
5180	25.83	4.0	17
5220	26.06	4.0	17
5240	25.94	4.0	17

* See plots 77 to 79 for detailed measurements.

Notes:

- (1) Lesser of 17 dBm (50 mW) or $4 \text{ dBm} + 10\log[B]$
- (2) If transmitting antennas of directional gain greater than 6 dBi are used, both the peak transmit power and the peak power spectral density shall be reduced by the amount in dB that the directional gain of the antenna exceeds 6 dBi.

Plot #77: 26 dB Bandwidth
Channel Freq.: 5180 MHz (CH36)
Modulation: IEEE 802.11a – BPSK @ 9 Mbps Data Rate

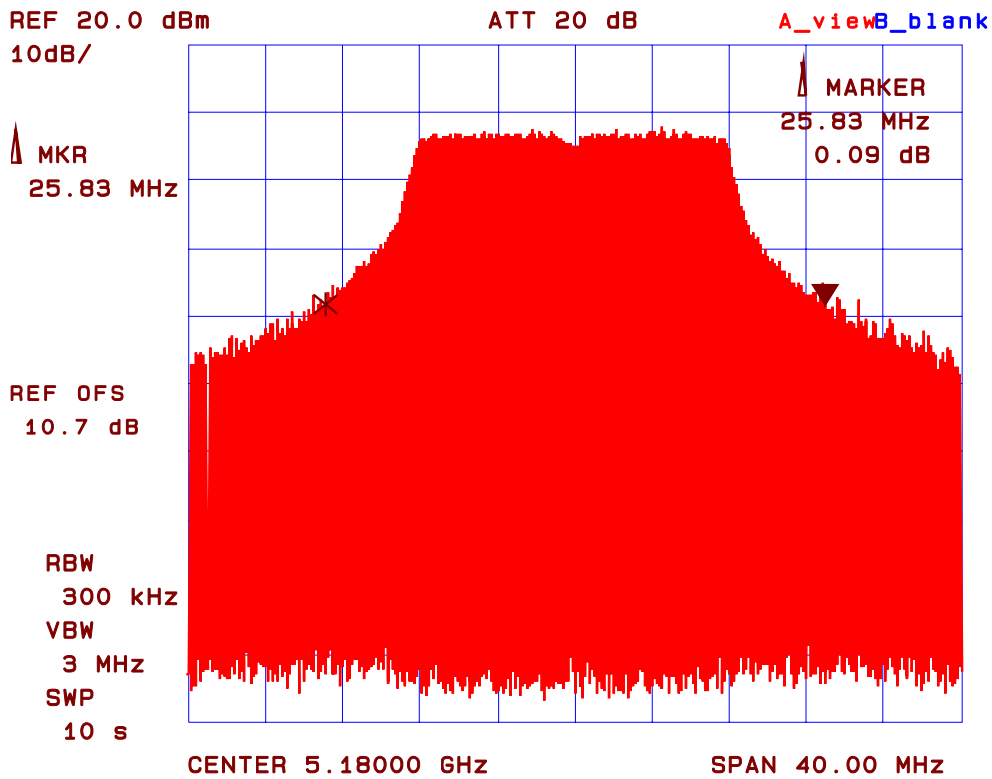

ULTRATECH GROUP OF LABS

3000 Bristol Circle, Oakville, Ontario, Canada L6H 6G4
Tel. #: 905-829-1570, Fax. #: 905-829-8050, Email: vic@ultratech-labs.com, Website: <http://www.ultratech-labs.com>

File #: CNI-027FCC15CE

June 10, 2005

All test results contained in this engineering test report are traceable to National Institute of Standards and Technology (NIST)

Plot #78: 26 dB Bandwidth
Channel Freq.: 5220 MHz (CH44)
Modulation: IEEE 802.11a – BPSK @ 9 Mbps Data Rate

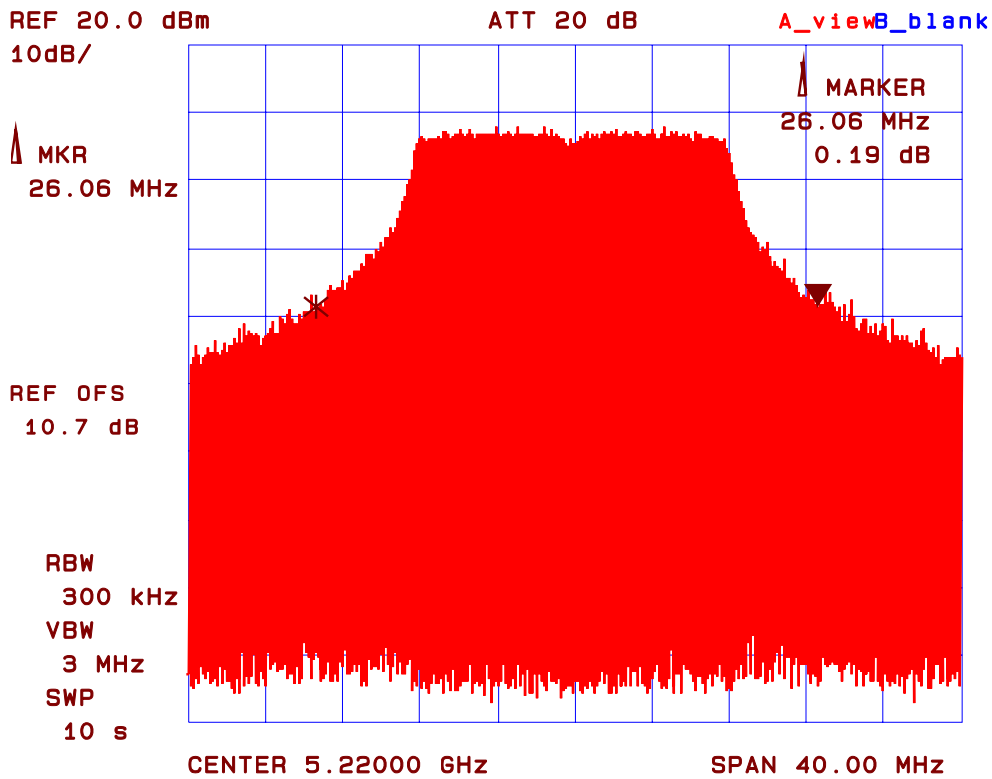

ULTRATECH GROUP OF LABS

3000 Bristol Circle, Oakville, Ontario, Canada L6H 6G4
Tel. #: 905-829-1570, Fax. #: 905-829-8050, Email: vic@ultratech-labs.com, Website: <http://www.ultratech-labs.com>

File #: CNI-027FCC15CE

June 10, 2005

All test results contained in this engineering test report are traceable to National Institute of Standards and Technology (NIST)

Plot #79: 26 dB Bandwidth
Channel Freq.: 5240 MHz (CH48)
Modulation: IEEE 802.11a – BPSK @ 9 Mbps Data Rate

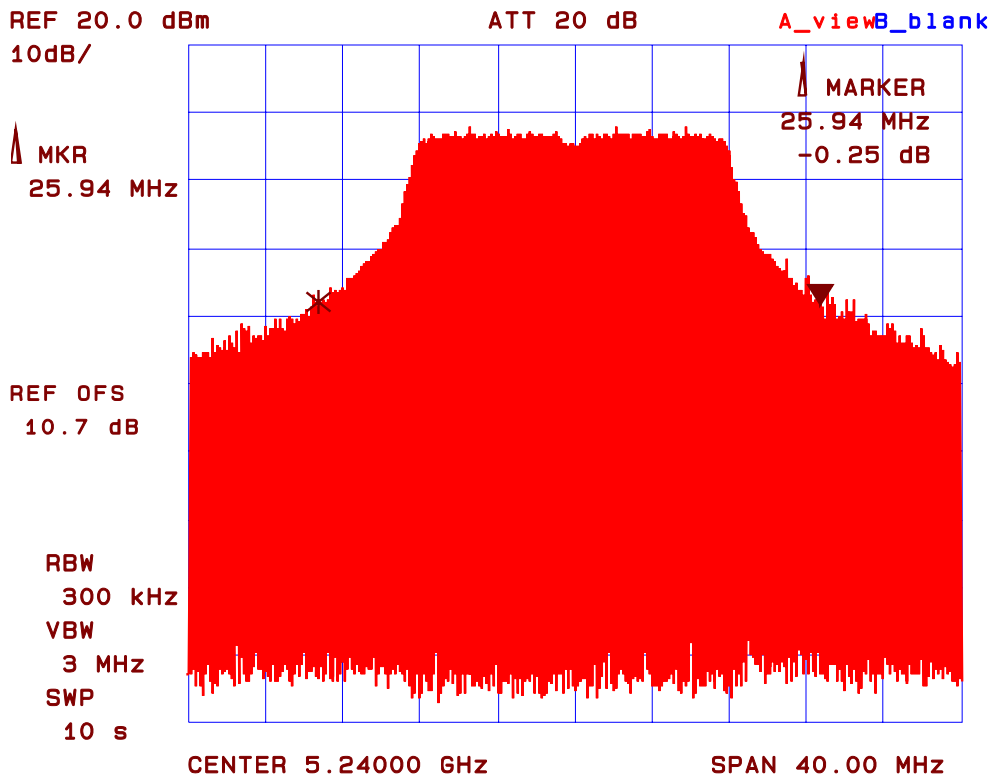

8.3.5.1.2. For the band 5.25-5.35 MHz

Channel Frequency (MHz)	Measured 26 dB Bandwidth [B] (MHz)	Peak Power Spectral Density in 1 MHz BW (dBm/MHz)	⁽¹⁾ Peak Power Limit @ 15.407(a) (dBm)
5260	27.20	11	24.0
5300	27.09	11	24.0
5320	26.17	11	24.0

* See plots 80 to 82 for detailed measurements.

Notes:

- (1) Lesser of 24.0 dBm (250 mW) or 11 dBm + 10log[B]
- (2) If transmitting antennas of directional gain greater than 6 dBi are used, both the peak transmit power and the peak power spectral density shall be reduced by the amount in dB that the directional gain of the antenna exceeds 6 dBi.

Plot #80: 26 dB Bandwidth
Channel Freq.: 5260 MHz (CH52)
Modulation: IEEE 802.11a – BPSK @ 9 Mbps Data Rate

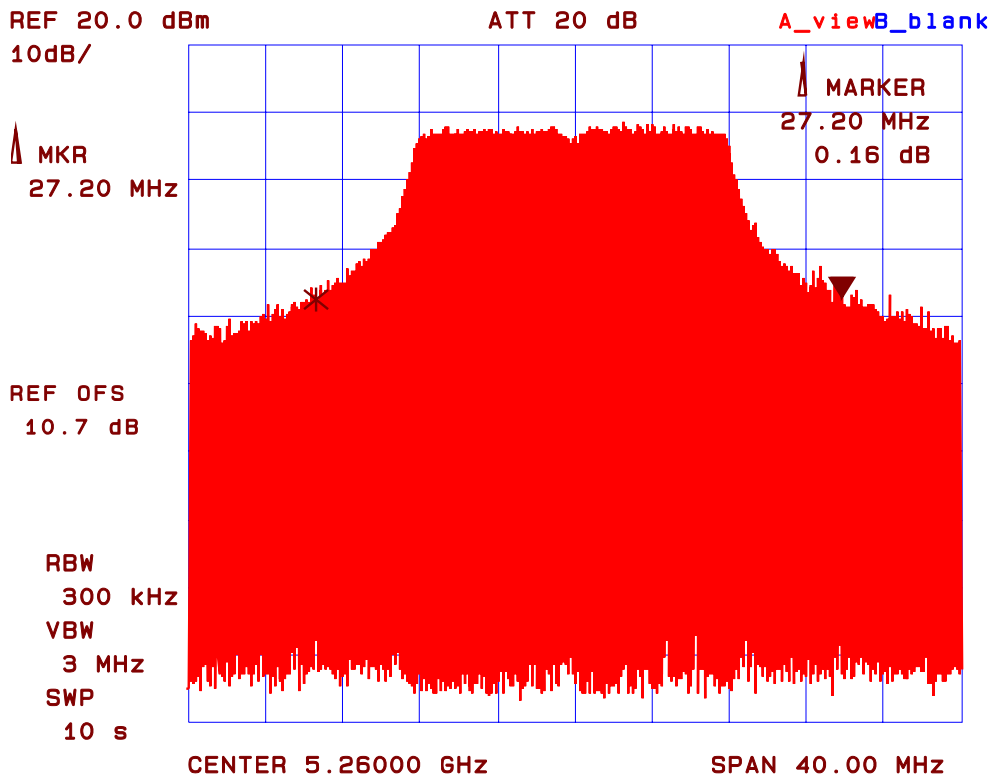

Plot #81: 26 dB Bandwidth
Channel Freq.: 5300 MHz (CH60)
Modulation: IEEE 802.11a – BPSK @ 9 Mbps Data Rate

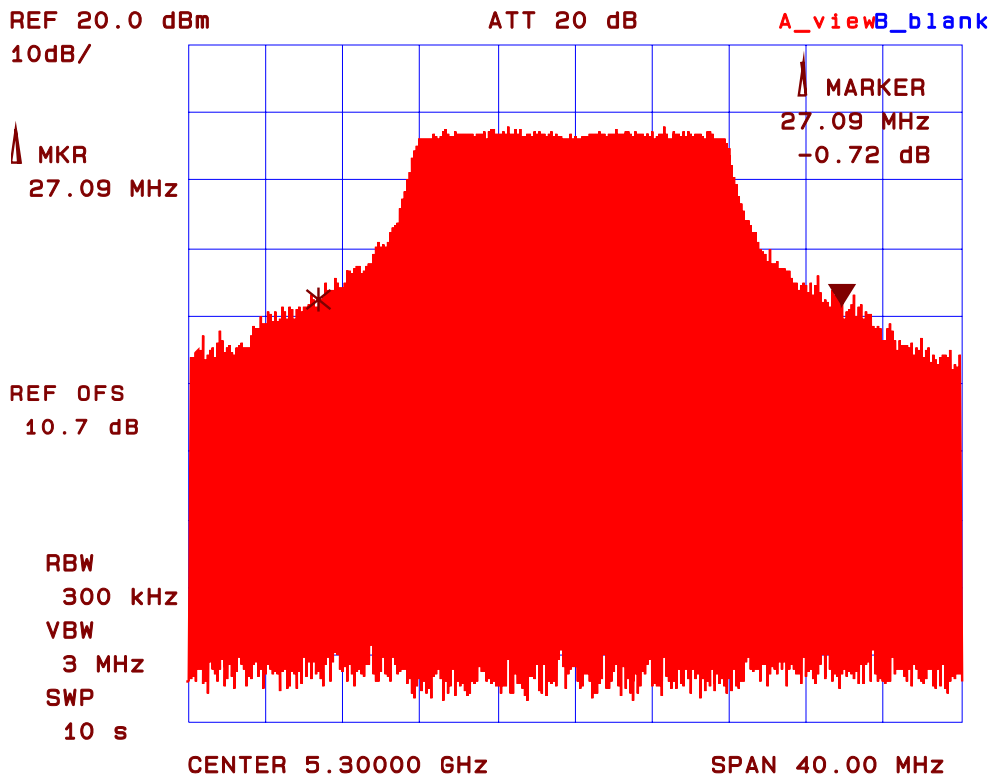

ULTRATECH GROUP OF LABS

3000 Bristol Circle, Oakville, Ontario, Canada L6H 6G4
Tel. #: 905-829-1570, Fax. #: 905-829-8050, Email: vic@ultratech-labs.com, Website: <http://www.ultratech-labs.com>

File #: CNI-027FCC15CE

June 10, 2005

All test results contained in this engineering test report are traceable to National Institute of Standards and Technology (NIST)

Plot #82: 26 dB Bandwidth
Channel Freq.: 5320 MHz (CH64)
Modulation: IEEE 802.11a – BPSK @ 9 Mbps Data Rate

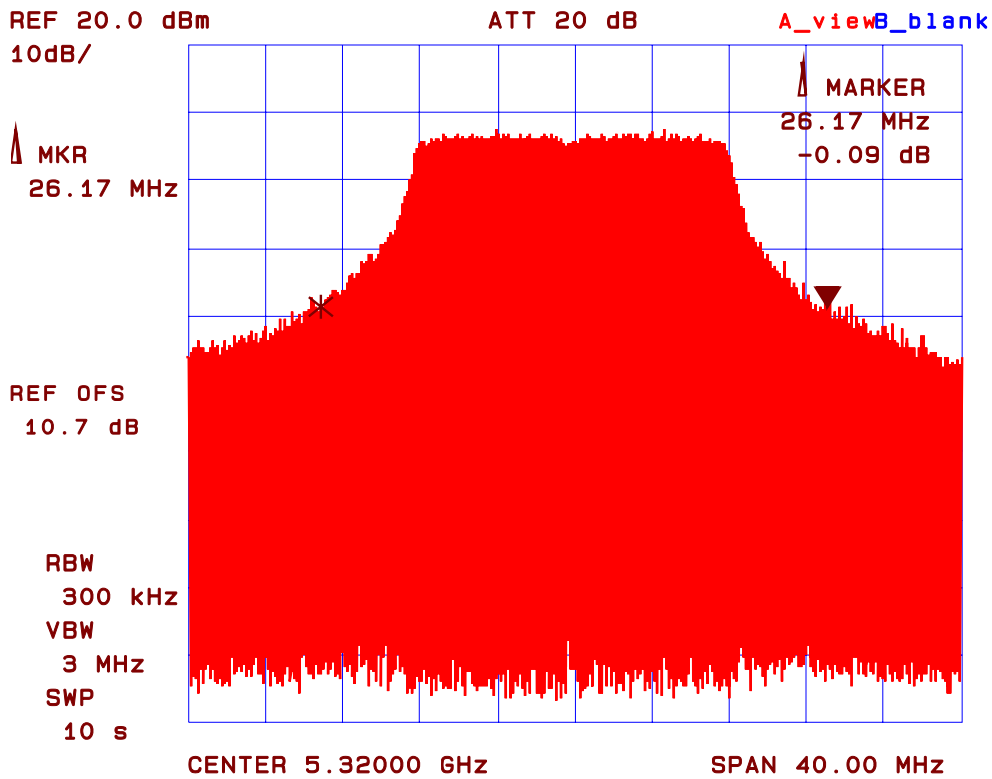

ULTRATECH GROUP OF LABS

3000 Bristol Circle, Oakville, Ontario, Canada L6H 6G4
Tel. #: 905-829-1570, Fax. #: 905-829-8050, Email: vic@ultratech-labs.com, Website: <http://www.ultratech-labs.com>

File #: CNI-027FCC15CE

June 10, 2005

All test results contained in this engineering test report are traceable to National Institute of Standards and Technology (NIST)

8.3.5.1.3. For the band 5.725-5.825 MHz

Channel Frequency (MHz)	Measured 26 dB Bandwidth [B] (MHz)	Peak Power Spectral Density in 1 MHz BW (dBm/MHz)	⁽¹⁾ Peak Power Limit @ 15.407(a) (dBm)
5745	25.37	17	30
5785	26.06	17	30
5805	27.09	17	30

* See plots 83 to 85 for detailed measurements.

Notes:

- (1) Lesser of 30 dBm (1000 mW) or 17 dBm + 10log[B]
- (2) If transmitting antennas of directional gain greater than 6 dBi are used, both the peak transmit power and the peak power spectral density shall be reduced by the amount in dB that the directional gain of the antenna exceeds 6 dBi.
- (3) For fixed point-to-point U-NII, maximum allowable antenna gain is 23 dBi without any reduction in conducted power.

Plot #83: 26 dB Bandwidth
Channel Freq.: 5745 MHz (CH149)
Modulation: IEEE 802.11a – BPSK @ 9 Mbps Data Rate

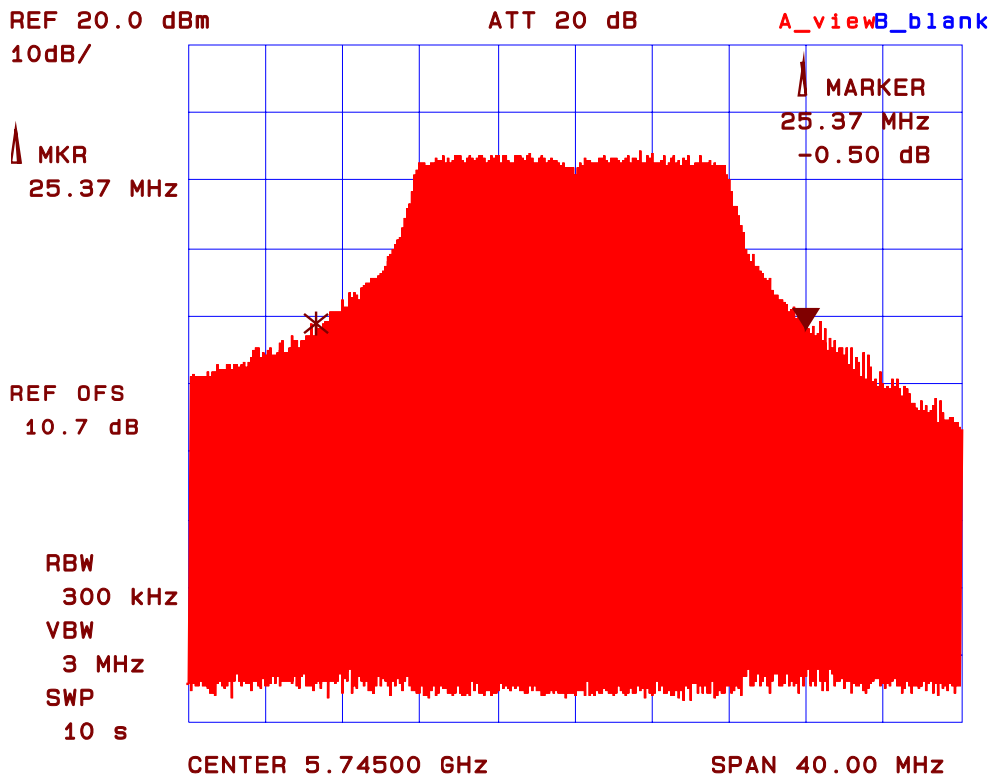

Plot #84: 26 dB Bandwidth
Channel Freq.: 5785 MHz (CH157)
Modulation: IEEE 802.11a – BPSK @ 9 Mbps Data Rate

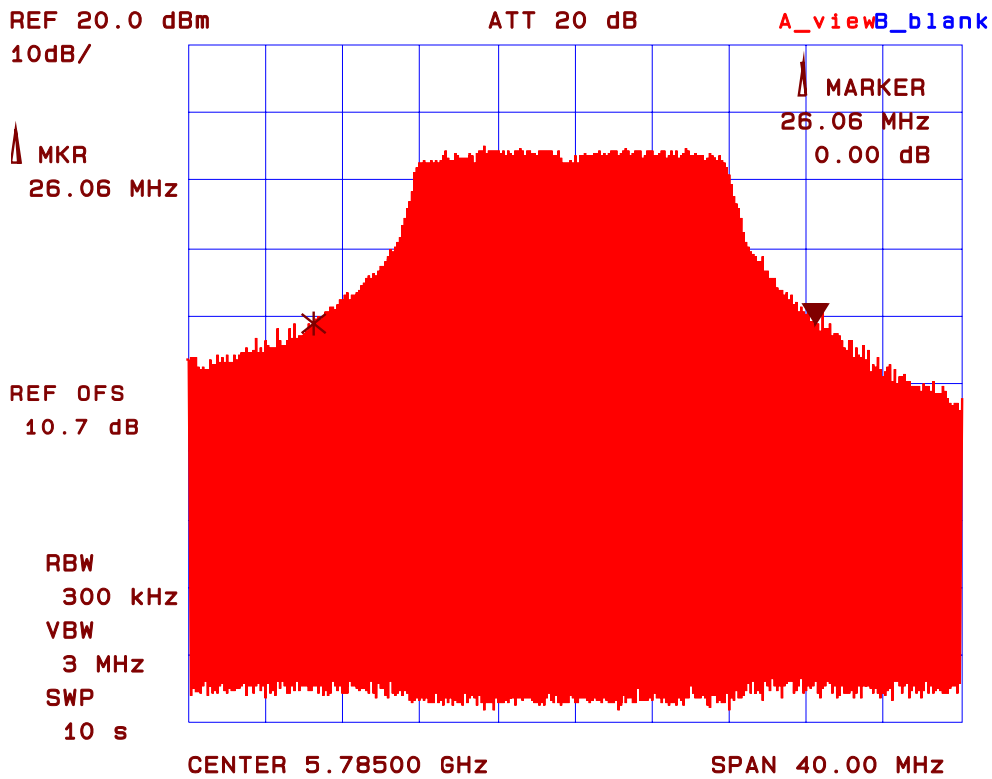

Plot #85: 26 dB Bandwidth
Channel Freq.: 5805 MHz (CH161)
Modulation: IEEE 802.11a – BPSK @ 9 Mbps Data Rate

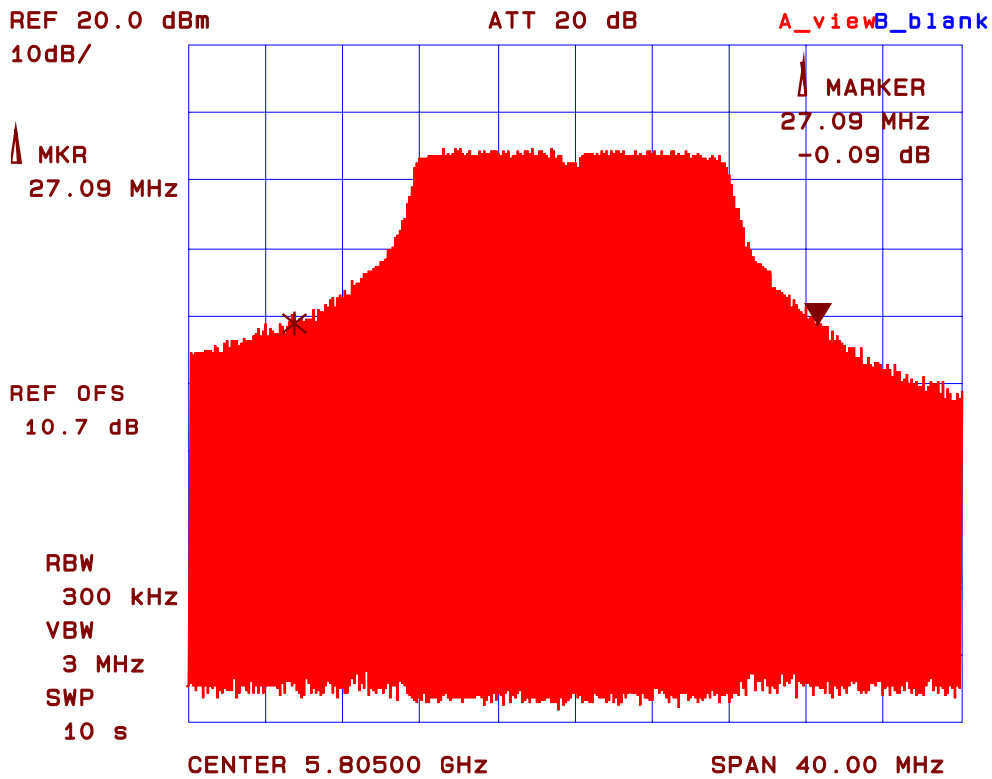

8.3.5.2. Peak Power Spectral Density (PPSD) in 1 MHz BW

Remark: Pre-scans were performed at different modulations and data rates to determine which test configurations yield the highest Peak Power Spectral Density (PPSD) in 1 MHz Bandwidth. Modulation 64QAM at 54 Mbps data rate yields the highest PPSD. Therefore, tests were performed at this configuration to represents the worst-case measurements.

8.3.5.2.1. For the band 5.15-5.25 MHz

Transmitter Channel	Frequency (MHz)	Peak Power Spectral Density in 1 MHz BW (dBm/MHz)	Limit (dBm)
Power Level: High			
Lowest	5180	2.00	4
Middle	5220	2.00	4
Highest	5240	2.00	4
Power Level: Low			
Lowest	5180	-25.93	4
Middle	5220	-25.89	4
Highest	5240	-26.05	4

* See plots 86 to 91 for detailed measurements.

Plot #86: Peak Power Spectral Density
Channel Freq.: 5180 MHz (CH36), Modulation: 64QAM at 54 Mbps data rate
Power Level: High
Measurement Condition: Power Averaging, 100 Sweeps

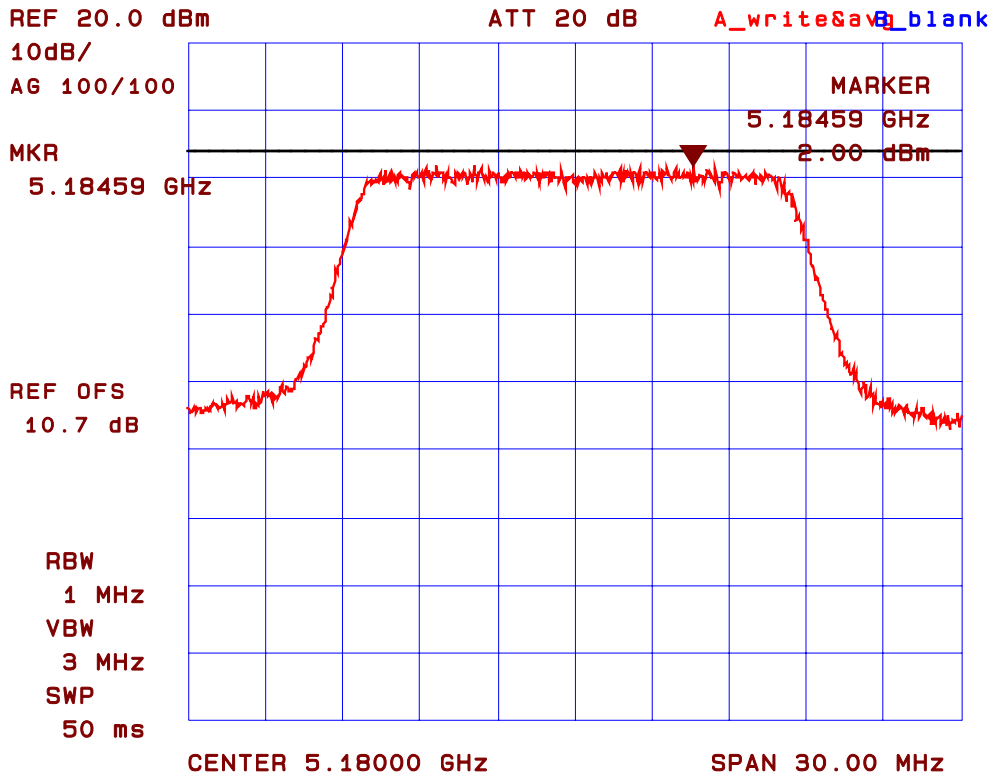

Plot #87: Peak Power Spectral Density
Channel Freq.: 5220 MHz (CH44), Modulation: 64QAM at 54 Mbps data rate
Power Level: High
Measurement Condition: Power Averaging, 100 Sweeps

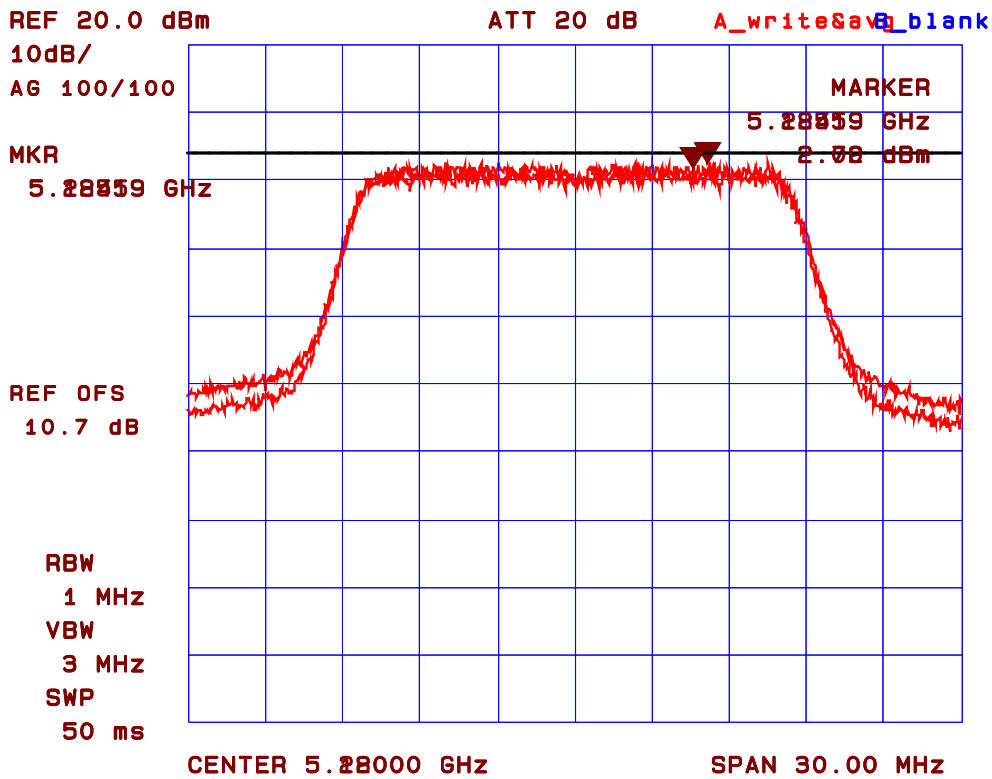

ULTRATECH GROUP OF LABS

3000 Bristol Circle, Oakville, Ontario, Canada L6H 6G4
Tel. #: 905-829-1570, Fax. #: 905-829-8050, Email: vic@ultratech-labs.com, Website: <http://www.ultratech-labs.com>

File #: CNI-027FCC15CE
June 10, 2005

All test results contained in this engineering test report are traceable to National Institute of Standards and Technology (NIST)

Plot #88: Peak Power Spectral Density
Channel Freq.: 5240 MHz (CH48), Modulation: 64QAM at 54 Mbps data rate
Power Level: High
Measurement Condition: Power Averaging, 100 Sweeps

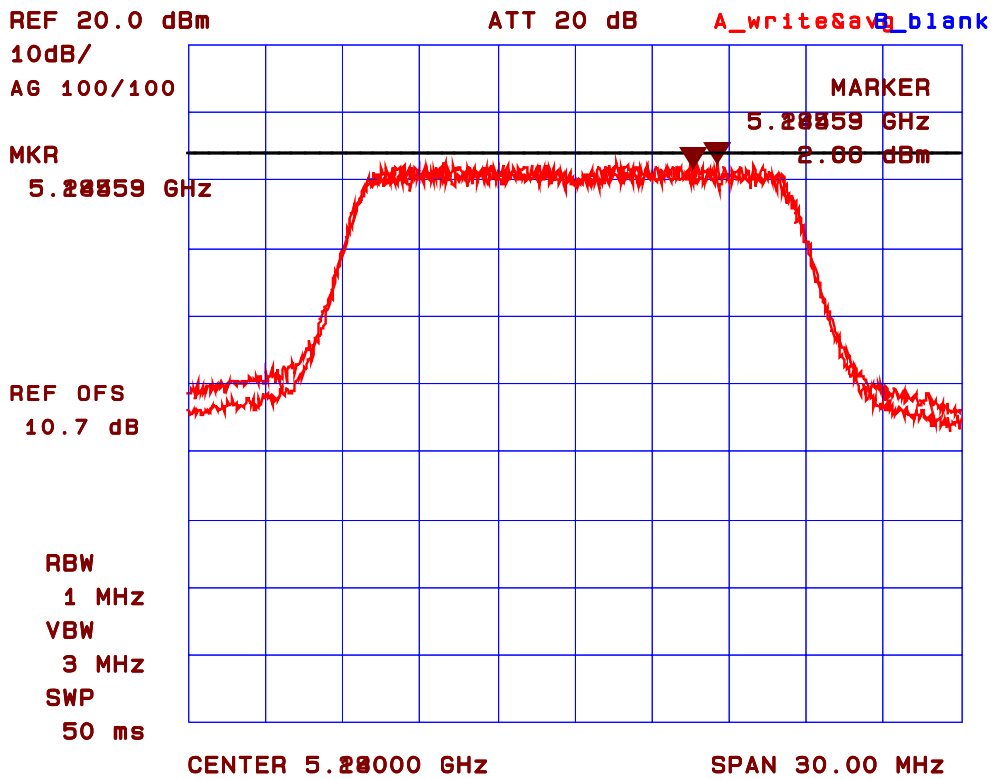

Plot #89: Peak Power Spectral Density
Channel Freq.: 5180 MHz (CH36), Modulation: 64QAM at 54 Mbps data rate
Power Level: Low
Measurement Condition: Max hold

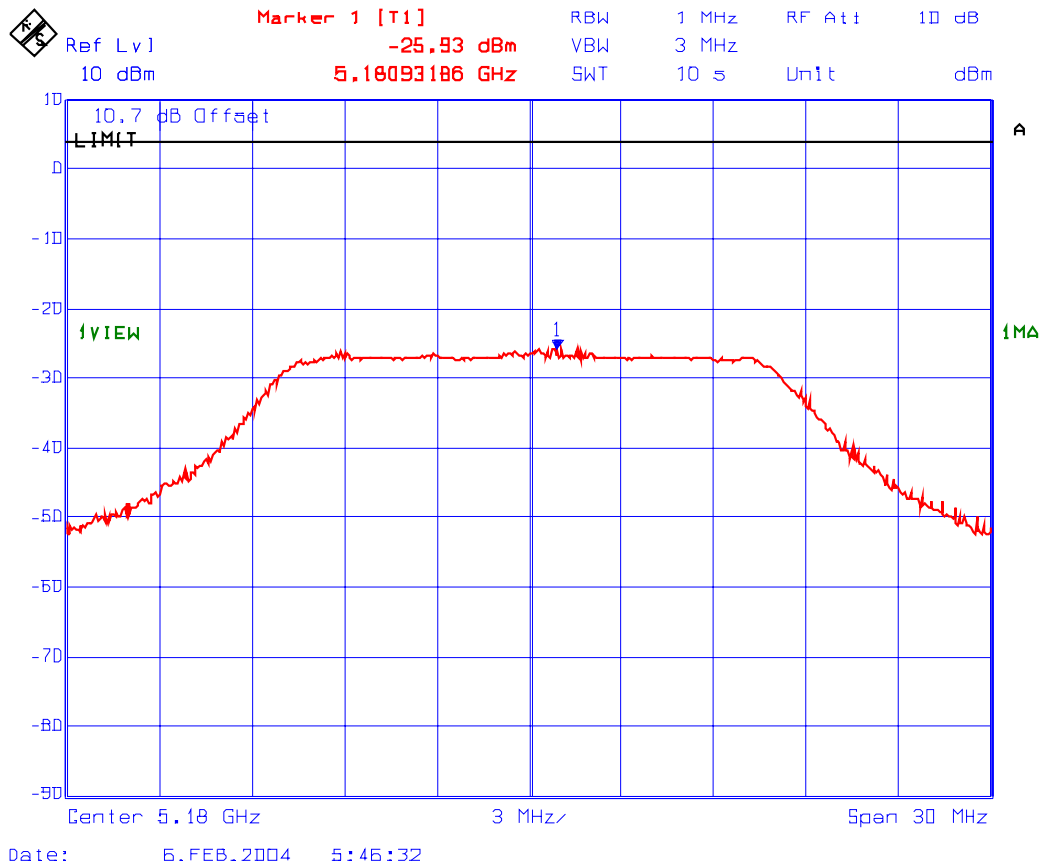

ULTRATECH GROUP OF LABS

3000 Bristol Circle, Oakville, Ontario, Canada L6H 6G4
Tel. #: 905-829-1570, Fax. #: 905-829-8050, Email: vic@ultratech-labs.com, Website: <http://www.ultratech-labs.com>

File #: CNI-027FCC15CE

June 10, 2005

All test results contained in this engineering test report are traceable to National Institute of Standards and Technology (NIST)

Plot #90: Peak Power Spectral Density
Channel Freq.: 5220 MHz (CH44), Modulation: 64QAM at 54 Mbps data rate
Power Level: Low
Measurement Condition: Max hold

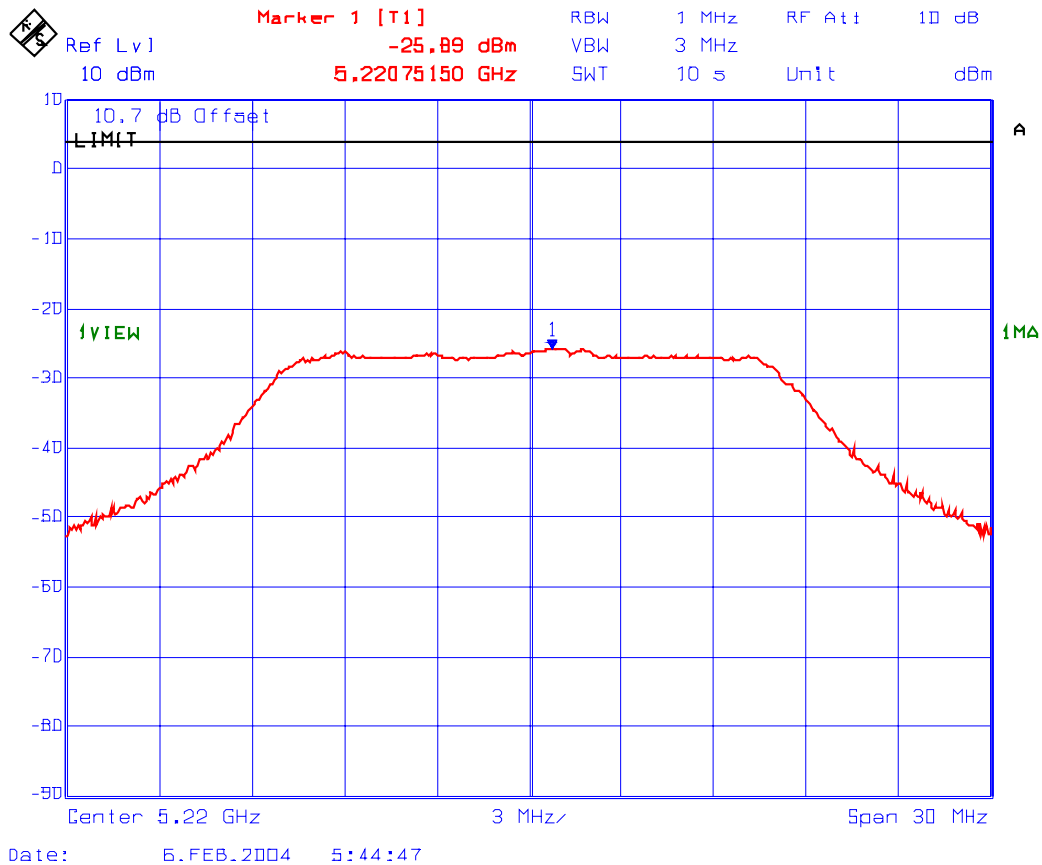

ULTRATECH GROUP OF LABS

3000 Bristol Circle, Oakville, Ontario, Canada L6H 6G4
Tel. #: 905-829-1570, Fax. #: 905-829-8050, Email: vic@ultratech-labs.com, Website: <http://www.ultratech-labs.com>

File #: CNI-027FCC15CE
June 10, 2005

All test results contained in this engineering test report are traceable to National Institute of Standards and Technology (NIST)

Plot #91: Peak Power Spectral Density
Channel Freq.: 5240 MHz (CH48), Modulation: 64QAM at 54 Mbps data rate
Power Level: Low
Measurement Conditions: Max. hold

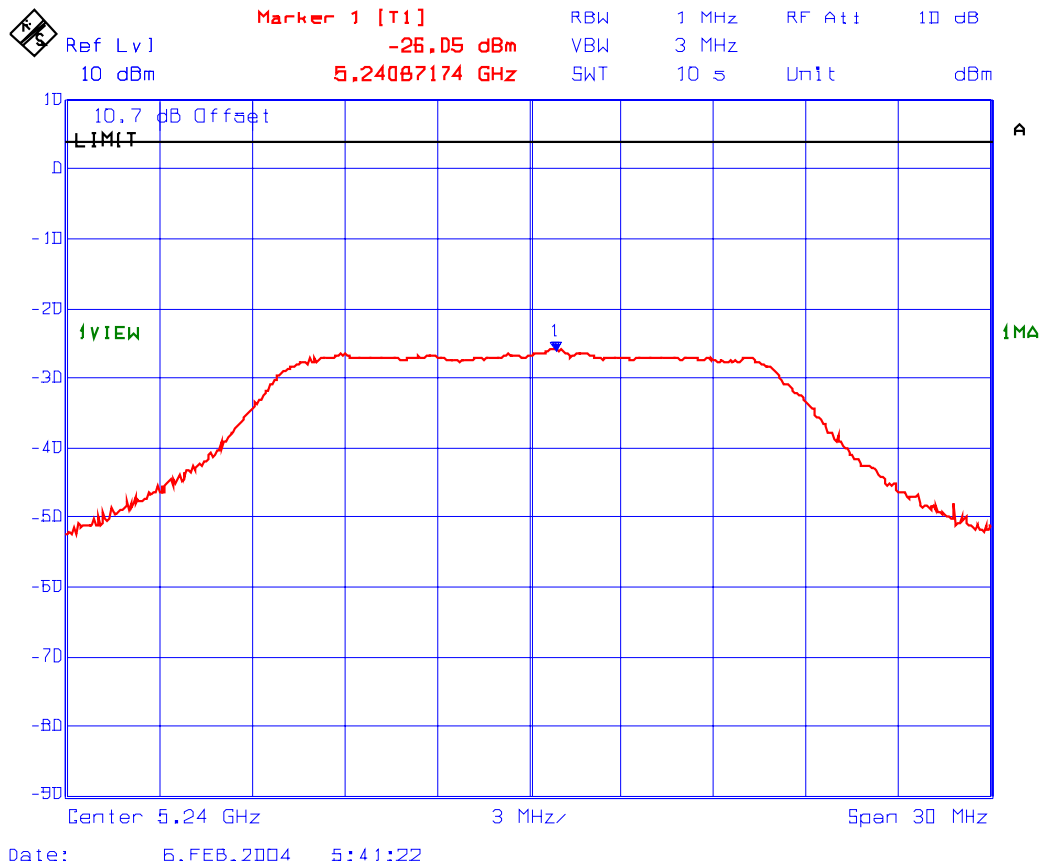

ULTRATECH GROUP OF LABS

3000 Bristol Circle, Oakville, Ontario, Canada L6H 6G4
Tel. #: 905-829-1570, Fax. #: 905-829-8050, Email: vic@ultratech-labs.com, Website: <http://www.ultratech-labs.com>

File #: CNI-027FCC15CE

June 10, 2005

All test results contained in this engineering test report are traceable to National Institute of Standards and Technology (NIST)

8.3.5.2.2. For the band 5.25-5.35 MHz

Transmitter Channel	Frequency (MHz)	Peak Power Spectral Density in 1 MHz BW (dBm/MHz)	Limit (dBm)
Power Level: High			
Lowest	5260	2.16	11
Middle	5300	1.94	11
Highest	5320	1.53	11
Power Level: Low			
Lowest	5260	-20.50	11
Middle	5300	-20.79	11
Highest	5320	-21.00	11

* See plots 92 to 97 for detailed measurements.

Plot #92: Peak Power Spectral Density
Channel Freq.: 5260 MHz (CH52), Modulation: 64QAM at 54 Mbps
Power Level: High
Measurement Condition: Power Averaging, 100 Sweeps

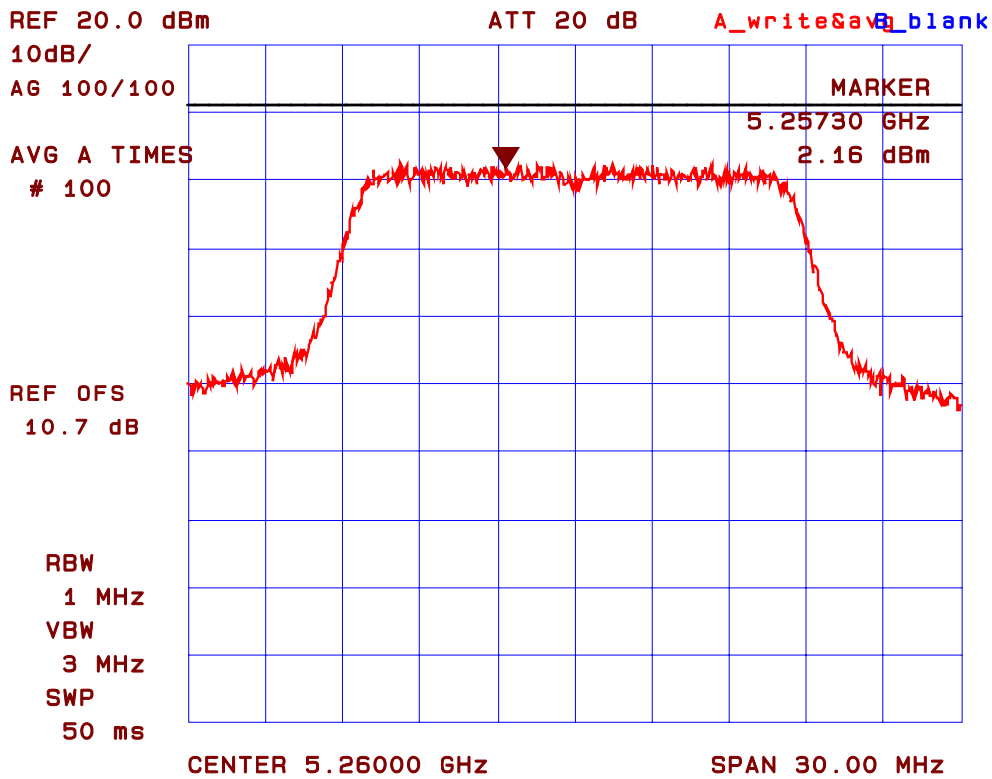

Plot #93: Peak Power Spectral Density
Channel Freq.: 5300 MHz (CH60), Modulation: 64QAM at 54 Mbps
Power Level: High
Measurement Condition: Power Averaging, 100 Sweeps

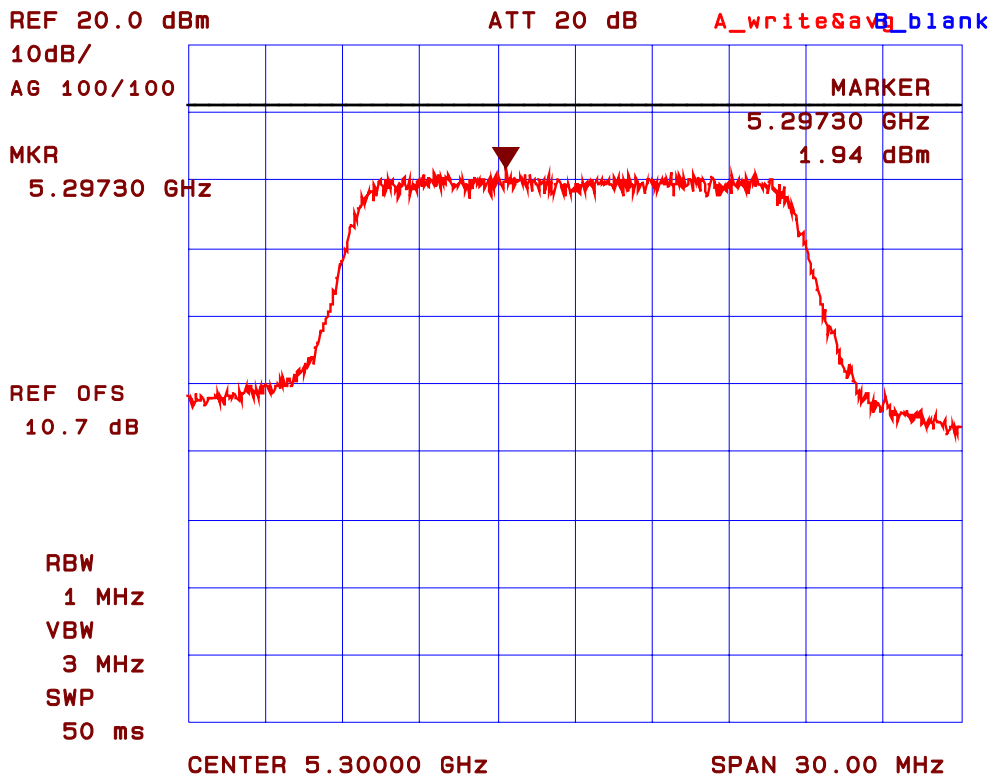

Plot #94: Peak Power Spectral Density
Channel Freq.: 5320 MHz (CH64), Modulation: 64QAM at 54 Mbps
Power Level: High
Measurement Condition: Power Averaging, 100 Sweeps

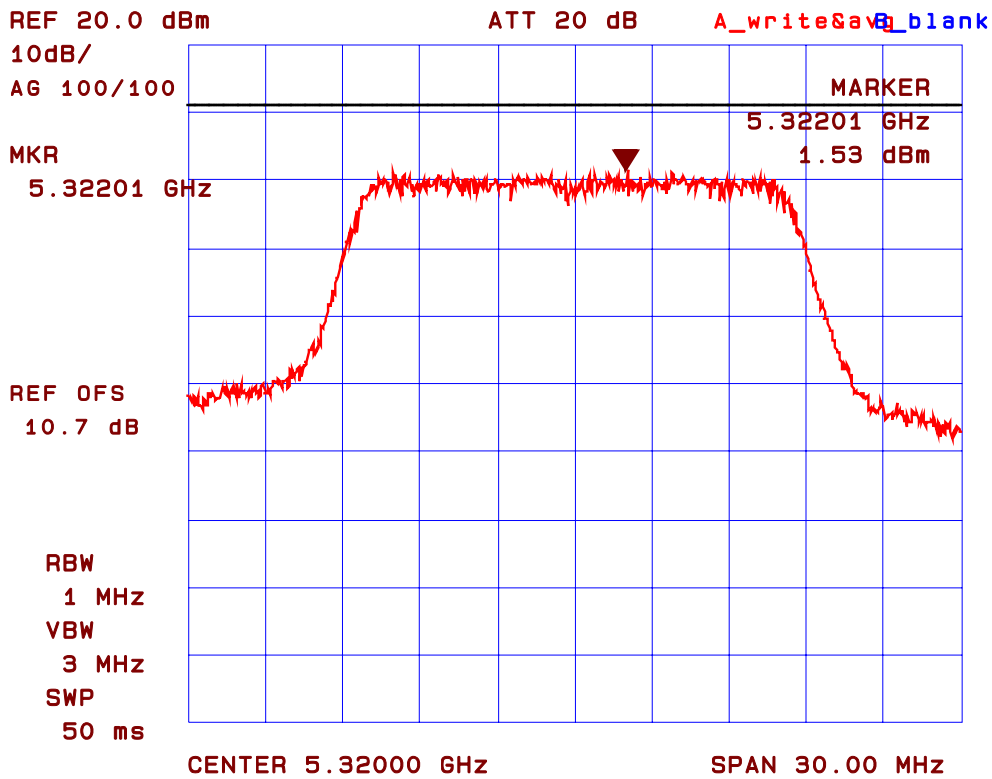

Plot #95: Peak Power Spectral Density
Channel Freq.: 5260 MHz (CH52), Modulation: 64QAM at 54 Mbps
Power Level: Low
Measurement Condition: Max. hold

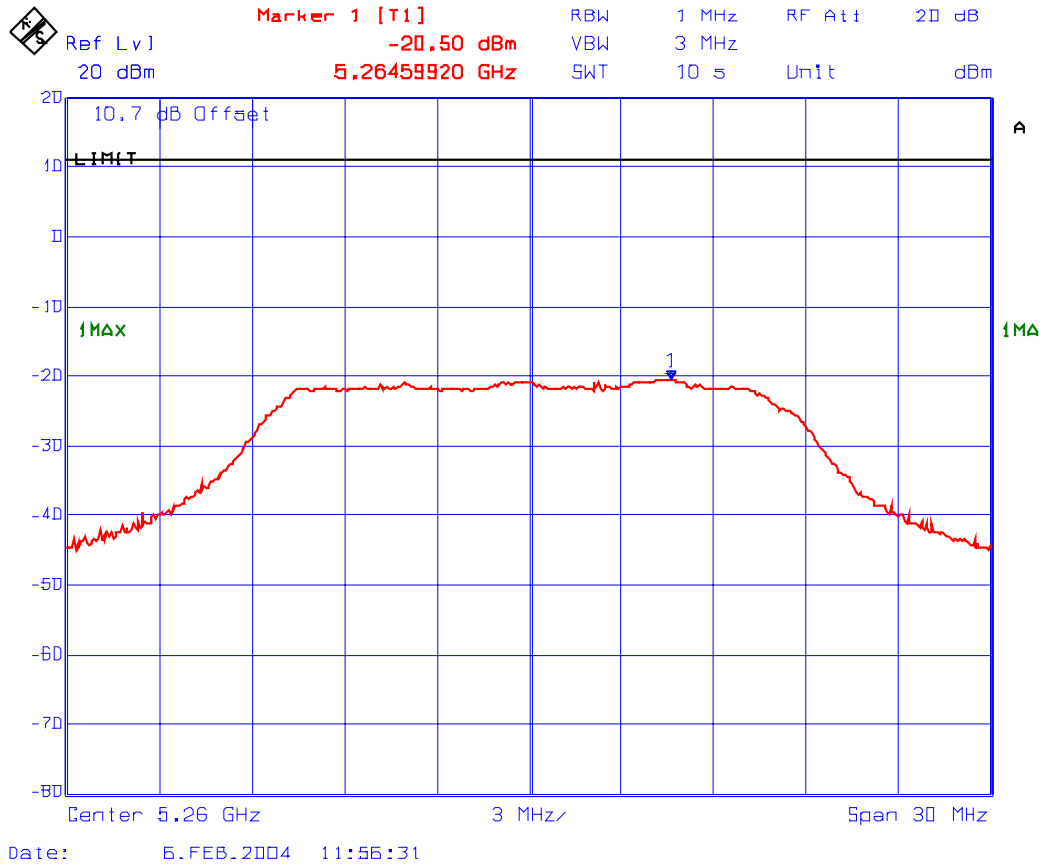

Plot #96: Peak Power Spectral Density
Channel Freq.: 5300 MHz (CH60), Modulation: 64QAM at 54 Mbps
Power Level: Low
Measurement Condition: Max. hold

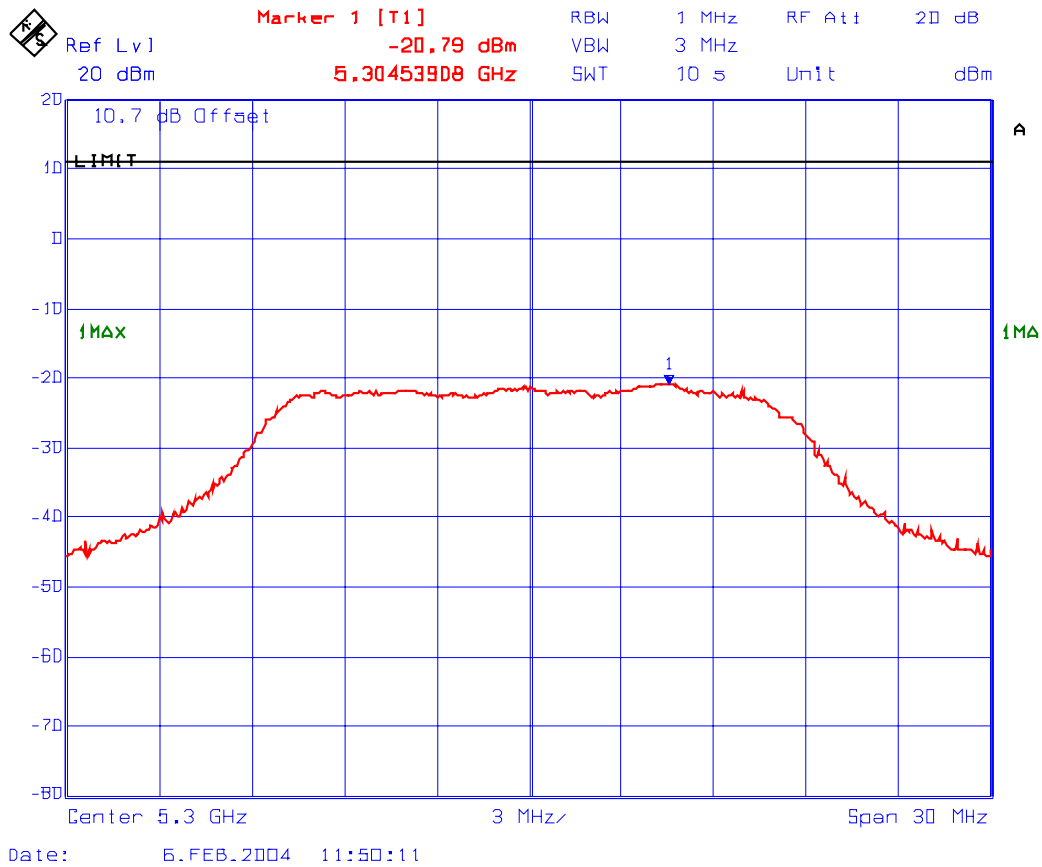

Plot #97: Peak Power Spectral Density
Channel Freq.: 5320 MHz (CH64), Modulation: 64QAM at 54 Mbps
Power Level: Low
Measurement Condition: Max. hold

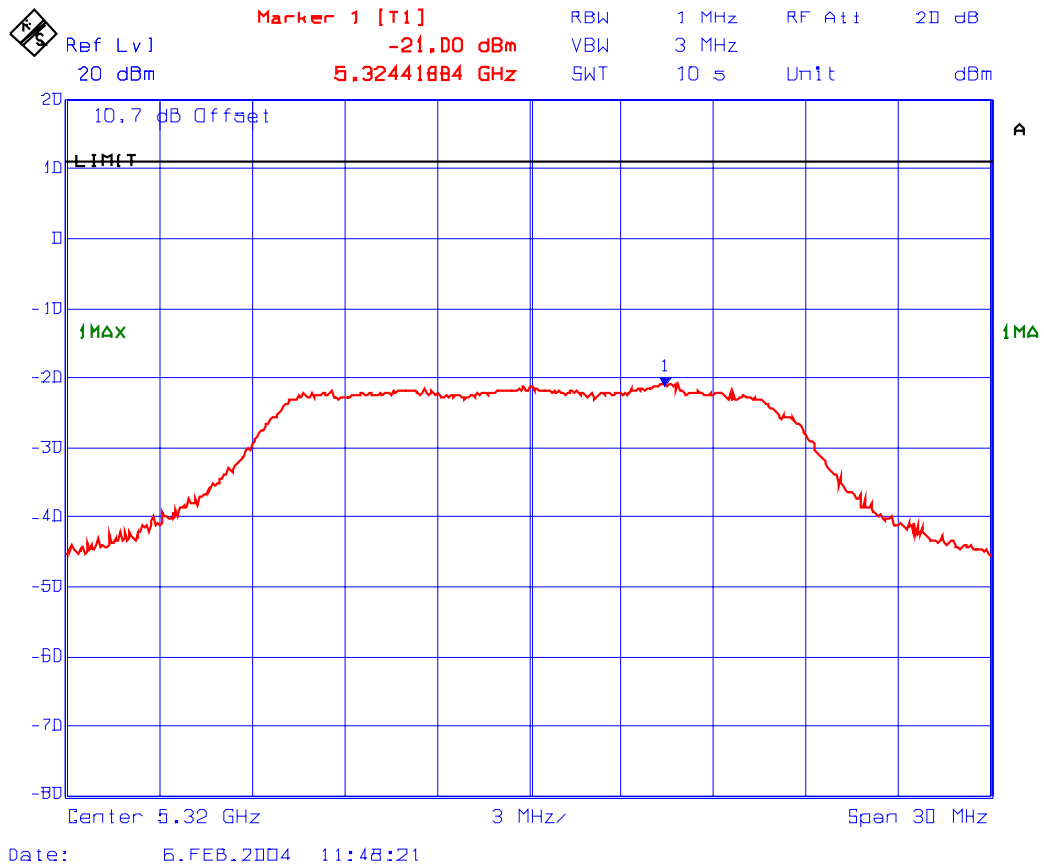

ULTRATECH GROUP OF LABS

3000 Bristol Circle, Oakville, Ontario, Canada L6H 6G4
Tel. #: 905-829-1570, Fax. #: 905-829-8050, Email: vic@ultratech-labs.com, Website: <http://www.ultratech-labs.com>

File #: CNI-027FCC15CE

June 10, 2005

All test results contained in this engineering test report are traceable to National Institute of Standards and Technology (NIST)

8.3.5.2.3. For the band 5.725-5.825 MHz

Transmitter Channel	Frequency (MHz)	Peak Power Spectral Density in 1 MHz BW (dBm/MHz)	Limit (dBm)
Power Level: High			
Lowest	5745	10.56	17
Middle	5785	9.66	17
Highest	5805	10.03	17
Power Level: Low			
Lowest	5745	-21.59	17
Middle	5785	-23.28	17
Highest	5805	-24.13	17

* See plots 98 to 103 for detailed measurements.

Plot #98: Peak Power Spectral Density
Channel Freq.: 5745 MHz (CH149), Modulation: 64QAM at 54 Mbps data rate
Power Level: High
Measurement Condition: Max. hold.

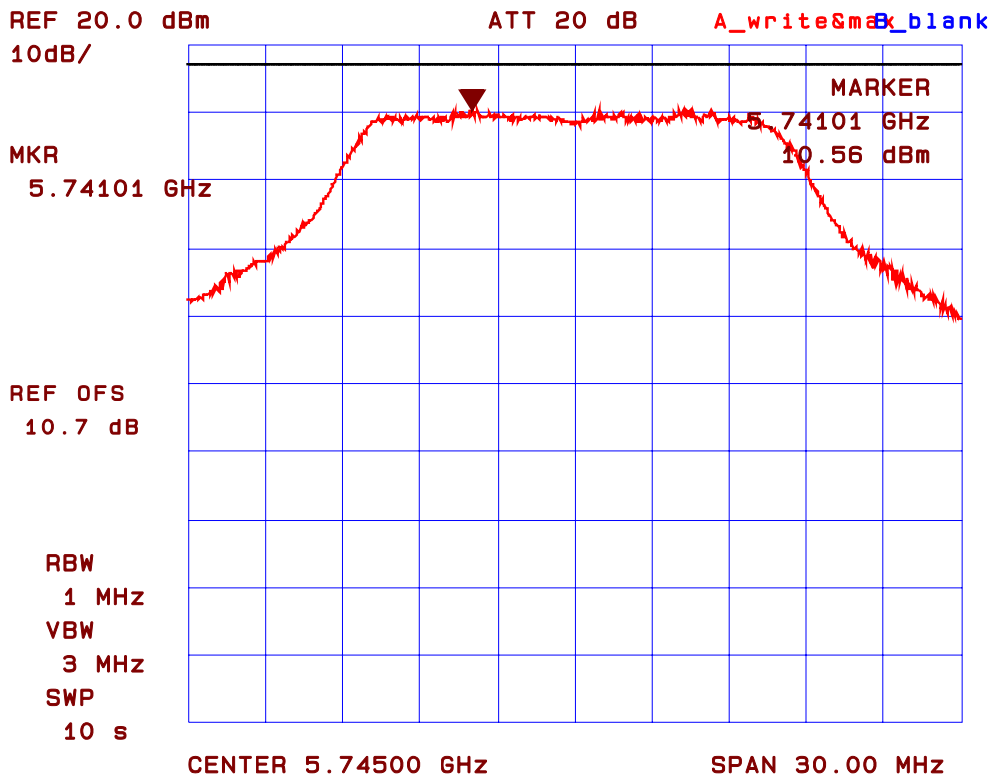

Plot #99: Peak Power Spectral Density
Channel Freq.: 5785 MHz (CH157), Modulation: 64QAM at 54 Mbps data rate
Power Level: High
Measurement Condition: Max. hold.

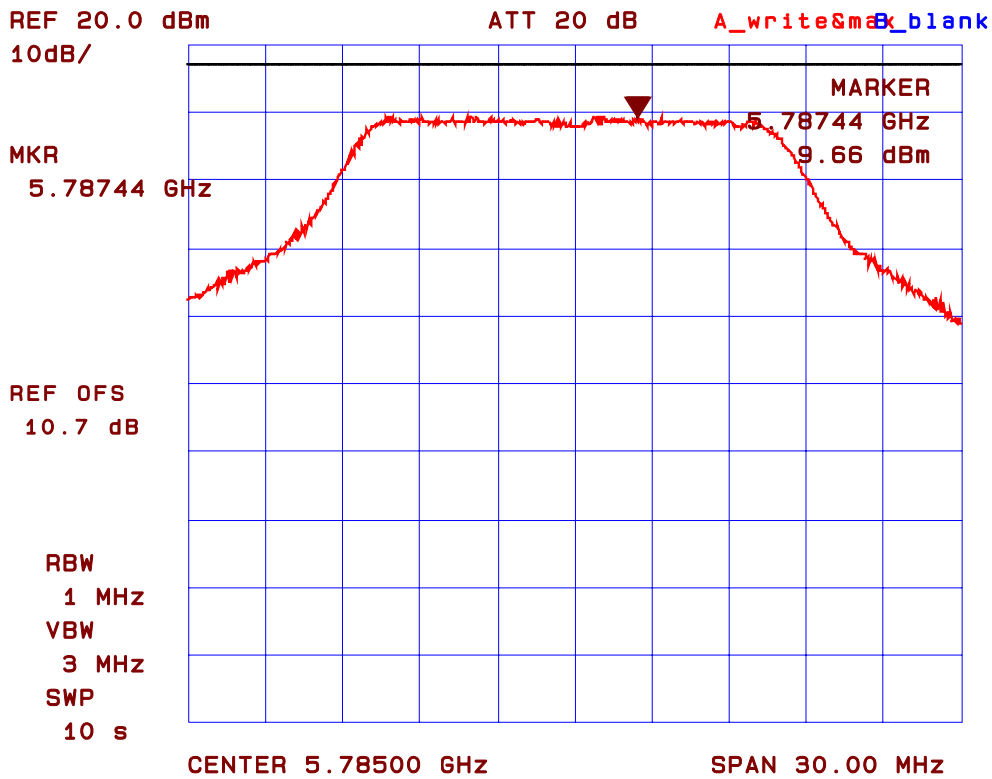

ULTRATECH GROUP OF LABS

3000 Bristol Circle, Oakville, Ontario, Canada L6H 6G4
Tel. #: 905-829-1570, Fax. #: 905-829-8050, Email: vic@ultratech-labs.com, Website: <http://www.ultratech-labs.com>

File #: CNI-027FCC15CE
June 10, 2005

All test results contained in this engineering test report are traceable to National Institute of Standards and Technology (NIST)

Plot #100: Peak Power Spectral Density
Channel Freq.: 5805 MHz (CH161), Modulation: 64QAM at 54 Mbps data rate
Power Level: High
Measurement Condition: Max. hold.

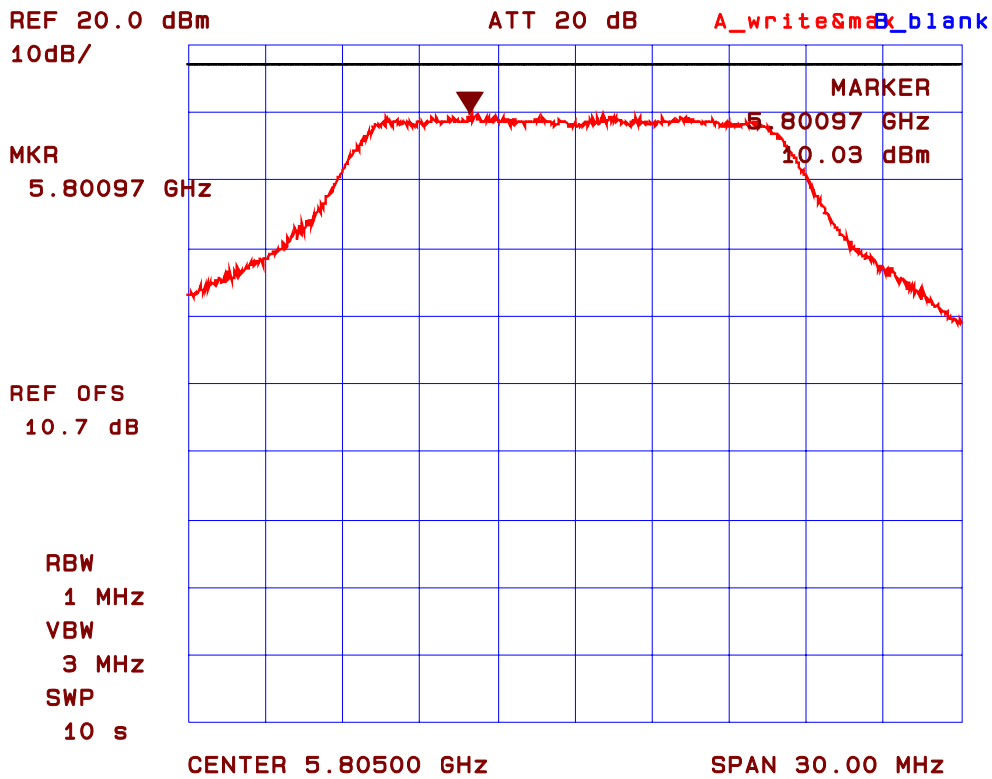

Plot #101: Peak Power Spectral Density
Channel Freq.: 5745 MHz (CH149), Modulation: 64QAM at 54 Mbps data rate
Power Level: Low
Measurement Condition: Max. hold.

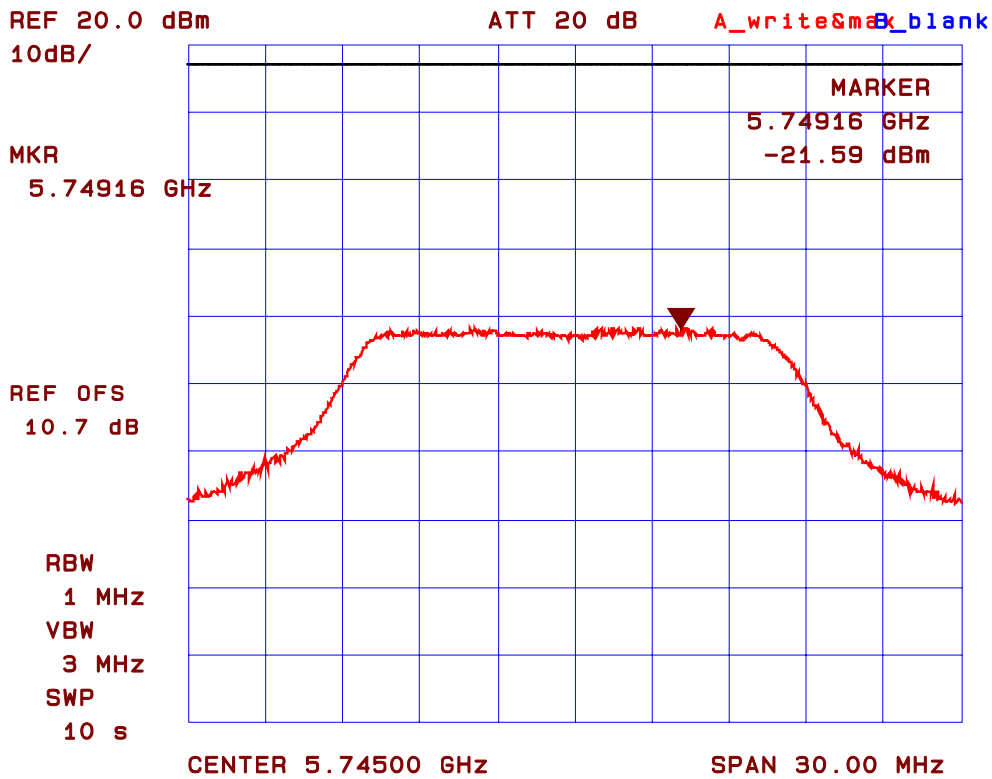

Plot #102: Peak Power Spectral Density
Channel Freq.: 5785 MHz (CH157), Modulation: 64QAM at 54 Mbps data rate
Power Level: Low
Measurement Condition: Max. hold.

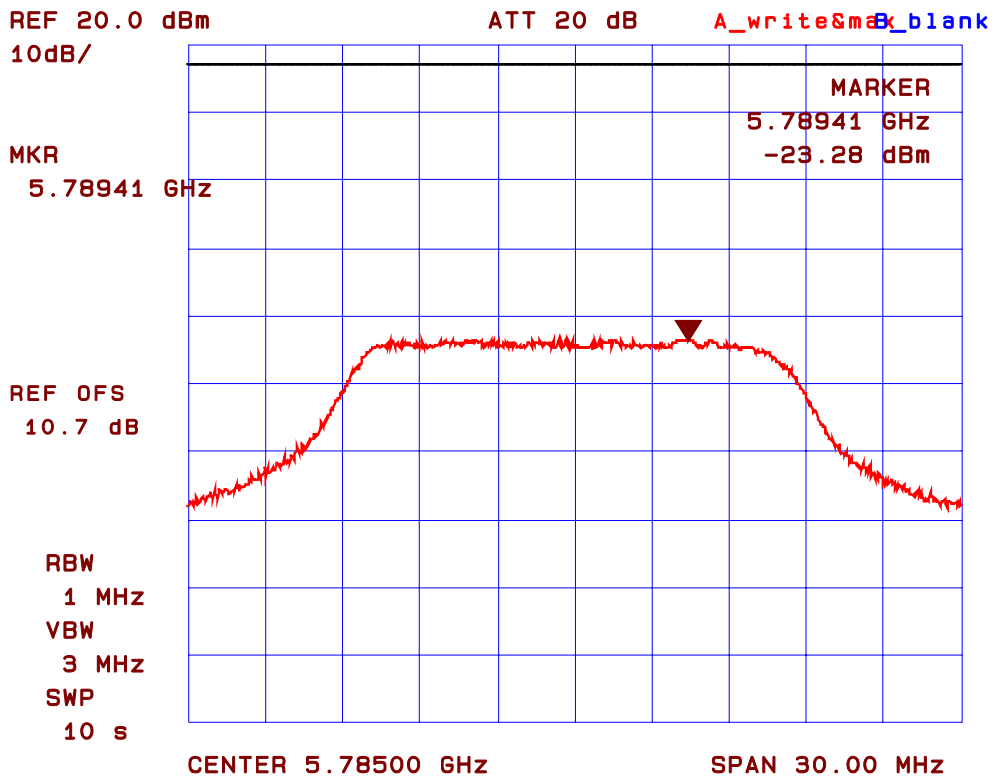

ULTRATECH GROUP OF LABS

3000 Bristol Circle, Oakville, Ontario, Canada L6H 6G4
Tel. #: 905-829-1570, Fax. #: 905-829-8050, Email: vic@ultratech-labs.com, Website: <http://www.ultratech-labs.com>

File #: CNI-027FCC15CE

June 10, 2005

All test results contained in this engineering test report are traceable to National Institute of Standards and Technology (NIST)

Plot #103: Peak Power Spectral Density
Channel Freq.: 5805 MHz (CH161), Modulation: 64QAM at 54 Mbps data rate
Power Level: Low
Measurement Condition: Max. hold.

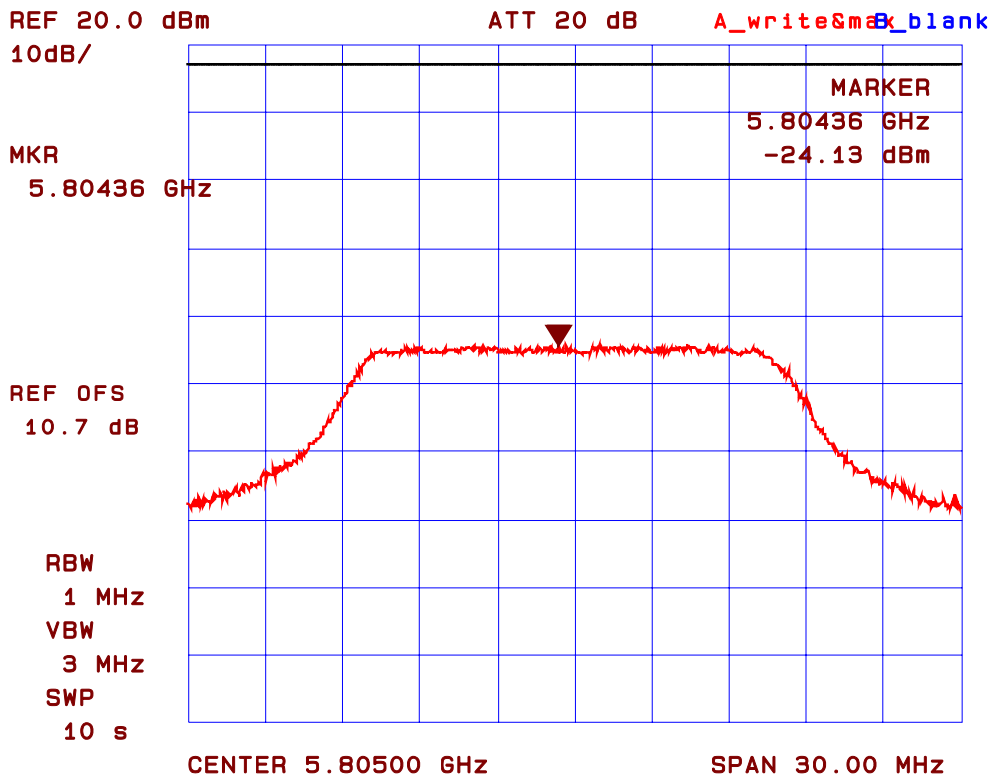

8.3.5.3. Peak Conducted Transmit Power (Full Bandwidth)

Remark: Pre-scans were performed at different modulations and data rates to determine which test configurations yield the highest Peak Conducted Transmit Power. Modulation 64QAM at 54 Mbps data rate yields the highest Peak Conducted Transmit Power. Therefore, the following Peak Conducted Transmit Power was tested in this configuration to represents the worst-case measurements.

8.3.5.3.1. External Antenna

8.3.5.3.1.1. For 5150-5250 MHz Band

Frequency (MHz)	Modulation	Measured Peak Power (dBm)	Limit (dBm)
5180	64QAM @ 54 Mbps	16.00	17
5220	64QAM @ 54 Mbps	15.63	17
5240	64QAM @ 54 Mbps	15.38	17

8.3.5.3.1.2. For 5250-5350 MHz Band

Frequency (MHz)	Modulation	Measured Peak Power (dBm)	Limit (dBm)
5260	64QAM @ 54 Mbps	16.28	24
5300	64QAM @ 54 Mbps	16.16	24
5320	64QAM @ 54 Mbps	16.81	24

8.3.5.3.1.3. For 5.725-5.825 MHz Band

Frequency (MHz)	Modulation	Measured Peak Power (dBm)	Limit (dBm)
5745	64QAM @ 54 Mbps	12.68	30
5785	64QAM @ 54 Mbps	12.94	30
5805	64QAM @ 54 Mbps	12.32	30

8.3.5.3.2. Internal Antenna

8.3.5.3.2.1. For 5150-5250 MHz band

Frequency (MHz)	Modulation	Measured Peak Power (dBm)	Limit (dBm)
5180	64QAM @ 54 Mbps	15.31	17
5220	64QAM @ 54 Mbps	15.23	17
5240	64QAM @ 54 Mbps	15.54	17

8.3.5.3.2.2. For 5250-5350 MHz Band

Frequency (MHz)	Modulation	Measured Peak Power (dBm)	Limit (dBm)
5260	64QAM @ 54 Mbps	16.31	24
5300	64QAM @ 54 Mbps	16.82	24
5320	64QAM @ 54 Mbps	16.87	24

8.3.5.3.2.3. For 5725-5825 MHz Band

Frequency (MHz)	Modulation	Measured Peak Power (dBm)	Limit (dBm)
5745	64QAM @ 54 Mbps	12.28	30
5785	64QAM @ 54 Mbps	12.99	30
5805	64QAM @ 54 Mbps	12.84	30

8.3.5.4. Peak Excursion Measurement

8.3.5.4.1. For the band 5.15-5.25 MHz

Plot #104: Peak Excursion Transmitter Conducted Emissions
Channel Freq.: 5180 MHz (CH36), Modulation: 64QAM at 54 Mbps data rate
Trace A : Peak Detector Max Hold, RBW = 1 MHz, VBW = 3 MHz
Trace B : Power Averaging 100 Sweeps

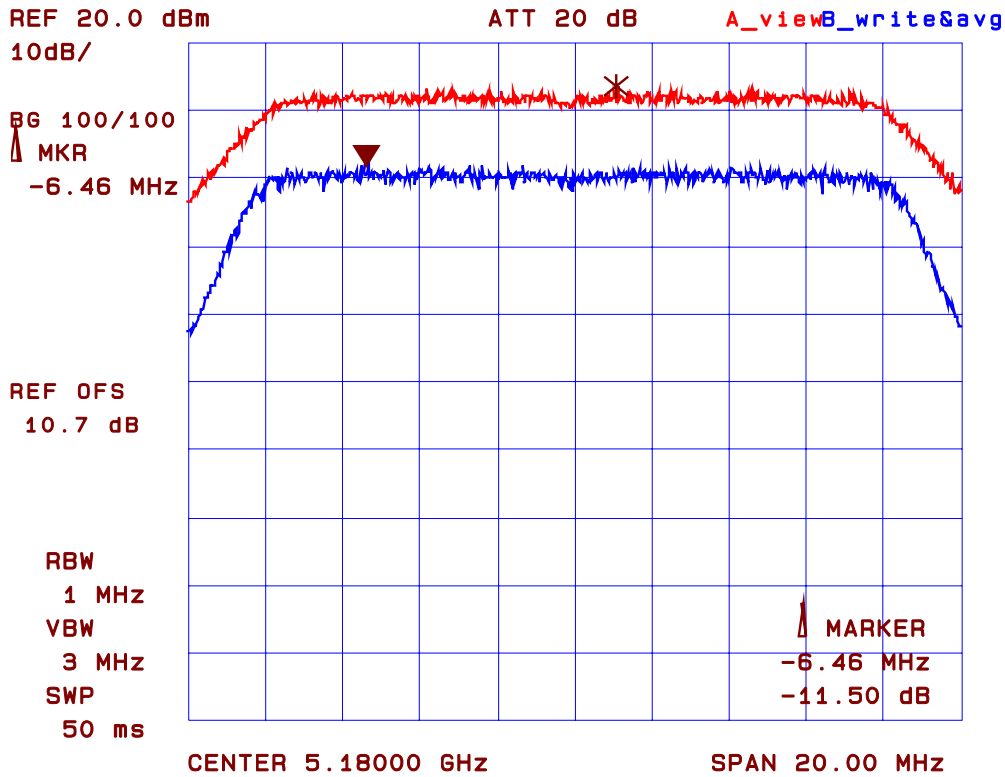

Plot #105: Peak Excursion Transmitter Conducted Emissions
Channel Freq.: 5220 MHz (CH44), Modulation: 64QAM at 54 Mbps data rate
Trace A : Peak Detector Max Hold, RBW = 1 MHz, VBW = 3 MHz
Trace B : Power Averaging 100 Sweeps

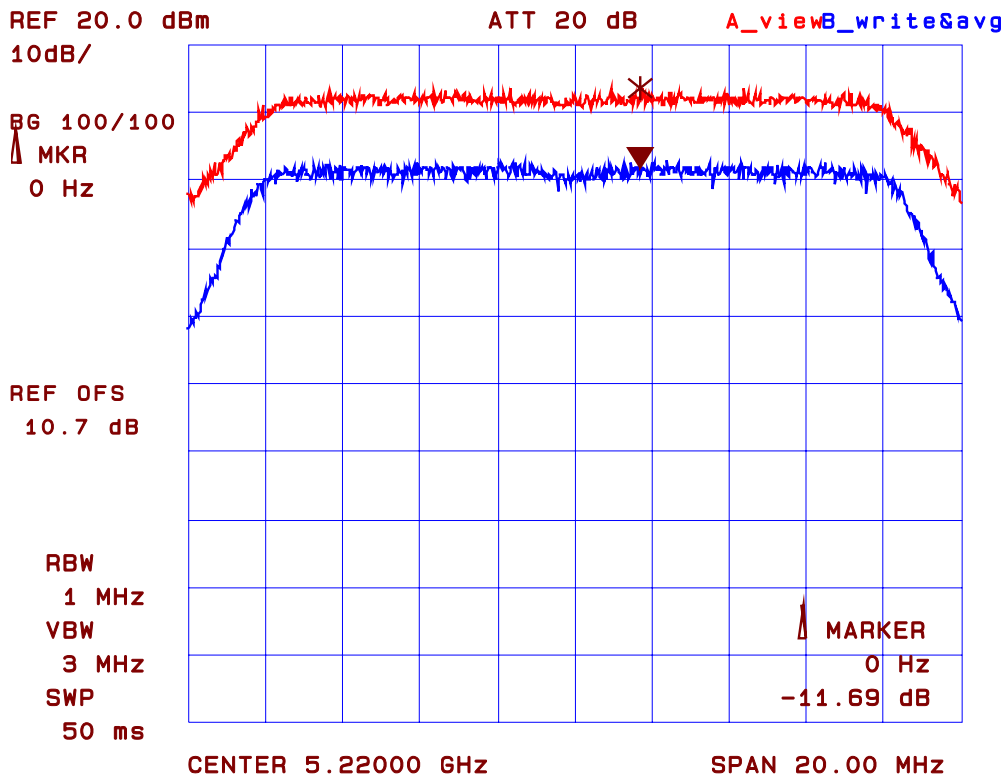

Plot #106: Peak Excursion Transmitter Conducted Emissions
Channel Freq.: 5240 MHz (CH48), Modulation: 64QAM at 54 Mbps data rate
Trace A ___: Peak Detector Max Hold, RBW = 1 MHz, VBW = 3 MHz
Trace B ___: Power Averaging 100 Sweeps

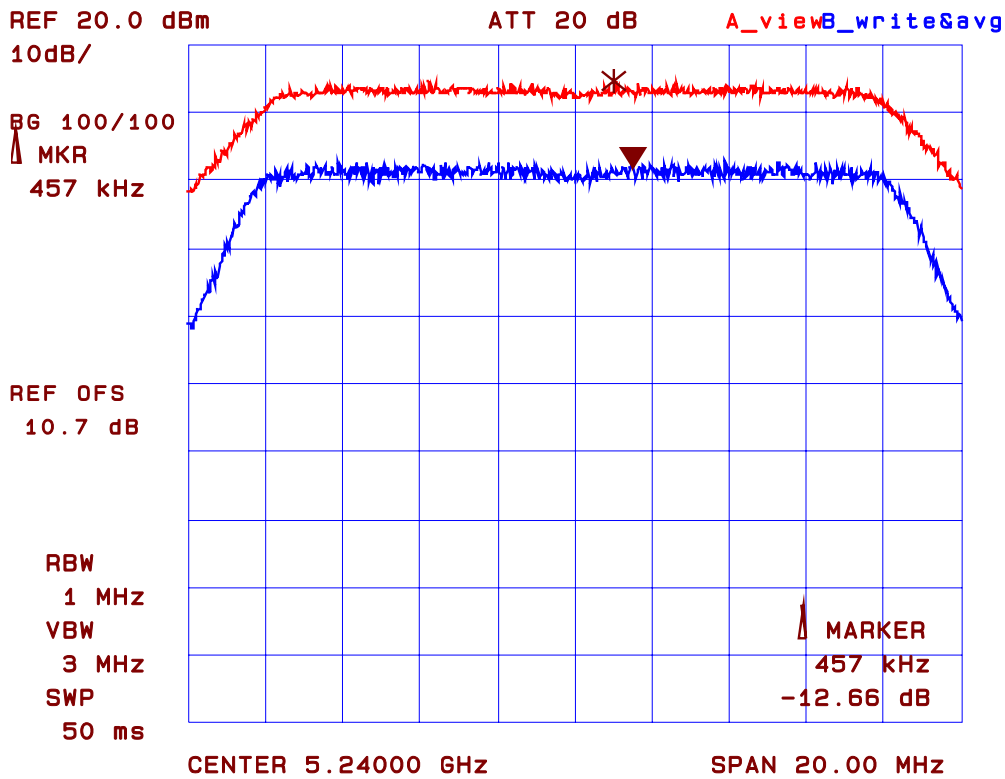

8.3.5.4.2. For the band 5.25-5.35 MHz

Plot #107: Peak Excursion Transmitter Conducted Emissions
Channel Freq.: 5260 MHz (CH52), Modulation: 64QAM at 54 Mbps data rate
Trace A ___: Peak Detector Max Hold, RBW = 1 MHz, VBW = 3 MHz
Trace B ___: Power Averaging 100 Sweeps

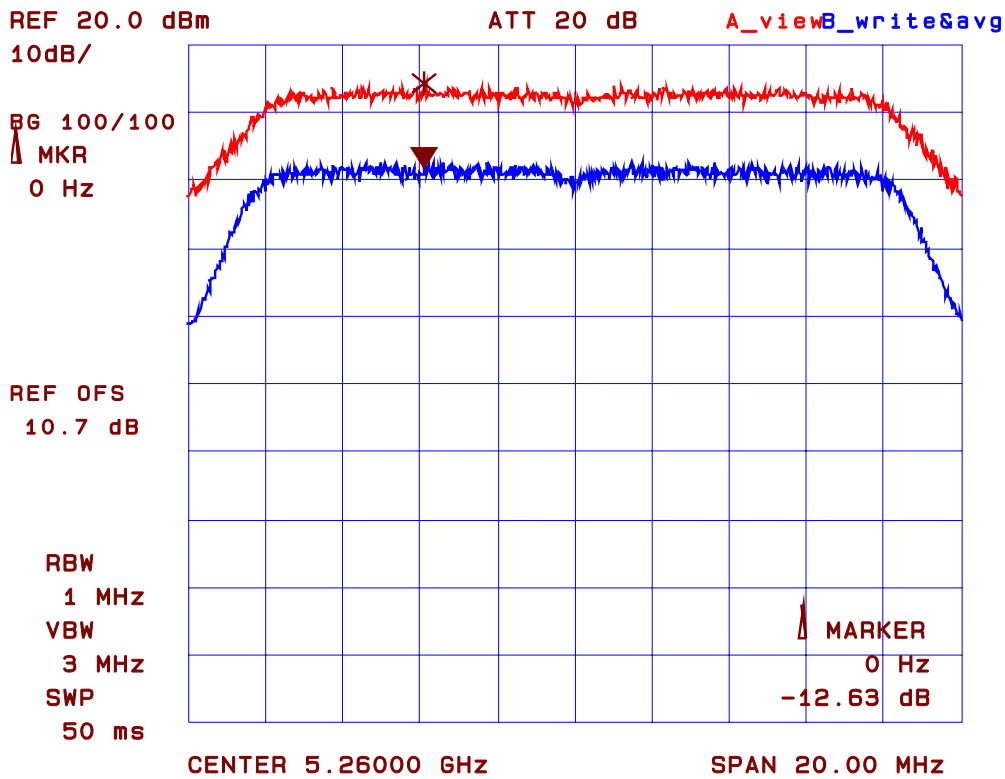

Plot #108: Peak Excursion Transmitter Conducted Emissions
Channel Freq.: 5300 MHz (CH60), Modulation: 64QAM at 54 Mbps data rate
Trace A ___: Peak Detector Max Hold, RBW = 1 MHz, VBW = 3 MHz
Trace B ___: Power Averaging 100 Sweeps

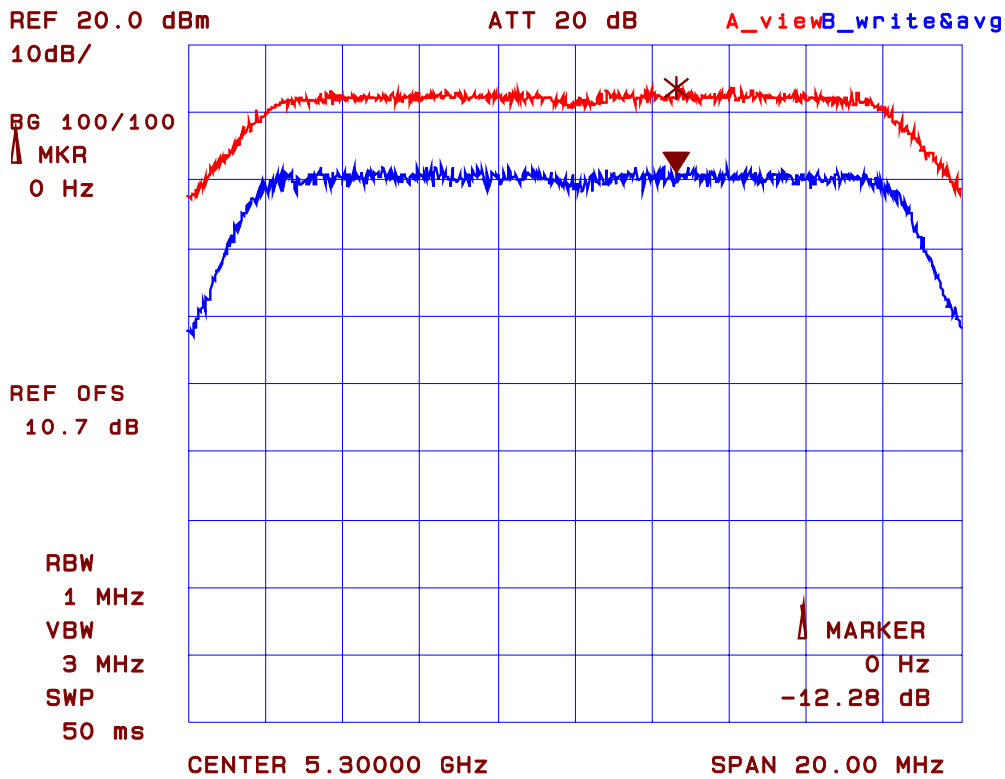

Plot #109: Peak Excursion Transmitter Conducted Emissions
Channel Freq.: 5320 MHz (CH64), Modulation: 64QAM at 54 Mbps data rate
Trace A : Peak Detector Max Hold, RBW = 1 MHz, VBW = 3 MHz
Trace B : Power Averaging 100 Sweeps

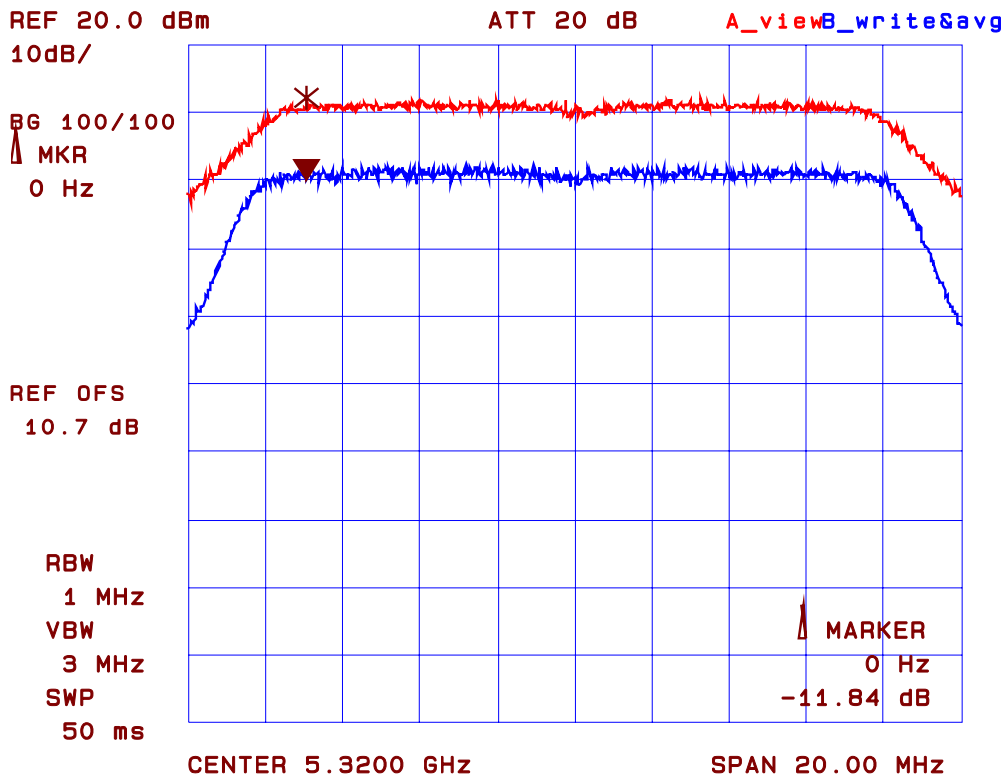

8.3.5.4.3. For the band 5.725-5.825 MHz

Plot #110: Peak Excursion Transmitter Conducted Emissions
Channel Freq.: 5745 MHz (CH149), Modulation: 64QAM at 54 Mbps data rate
Trace A ___: Peak Detector Max Hold, RBW = 1 MHz, VBW = 3 MHz
Trace B ___: Power Averaging 100 Sweeps

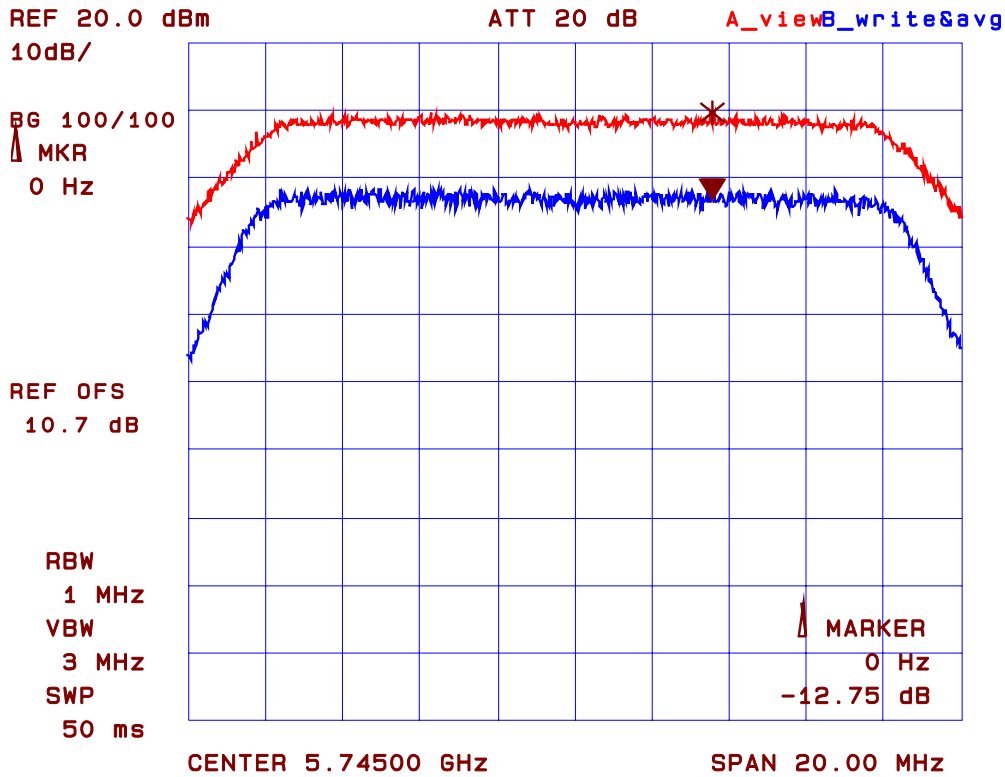

Plot #111: Peak Excursion Transmitter Conducted Emissions
Channel Freq.: 5785 MHz (CH157), Modulation: 64QAM at 54 Mbps data rate
Trace A __: Peak Detector Max Hold, RBW = 1 MHz, VBW = 3 MHz
Trace B __: Power Averaging 100 Sweeps

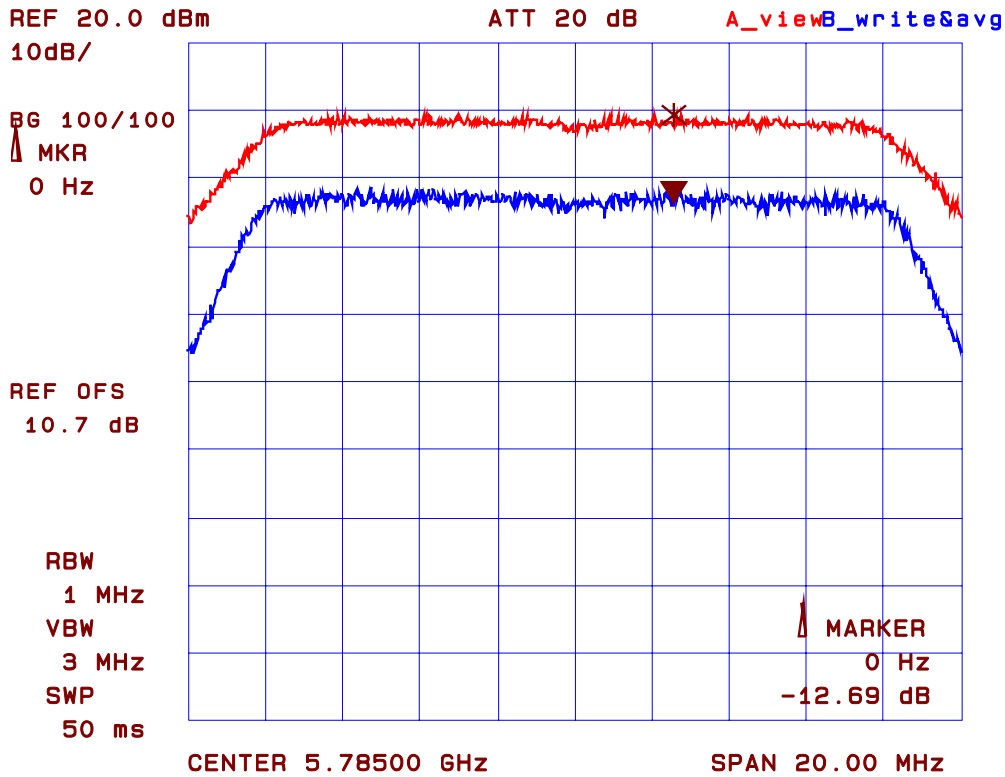

Plot #112: Peak Excursion Transmitter Conducted Emissions
Channel Freq.: 5805 MHz (CH161), Modulation: 64QAM at 54 Mbps data rate
Trace A ___: Peak Detector Max Hold, RBW = 1 MHz, VBW = 3 MHz
Trace B ___: Power Averaging 100 Sweeps

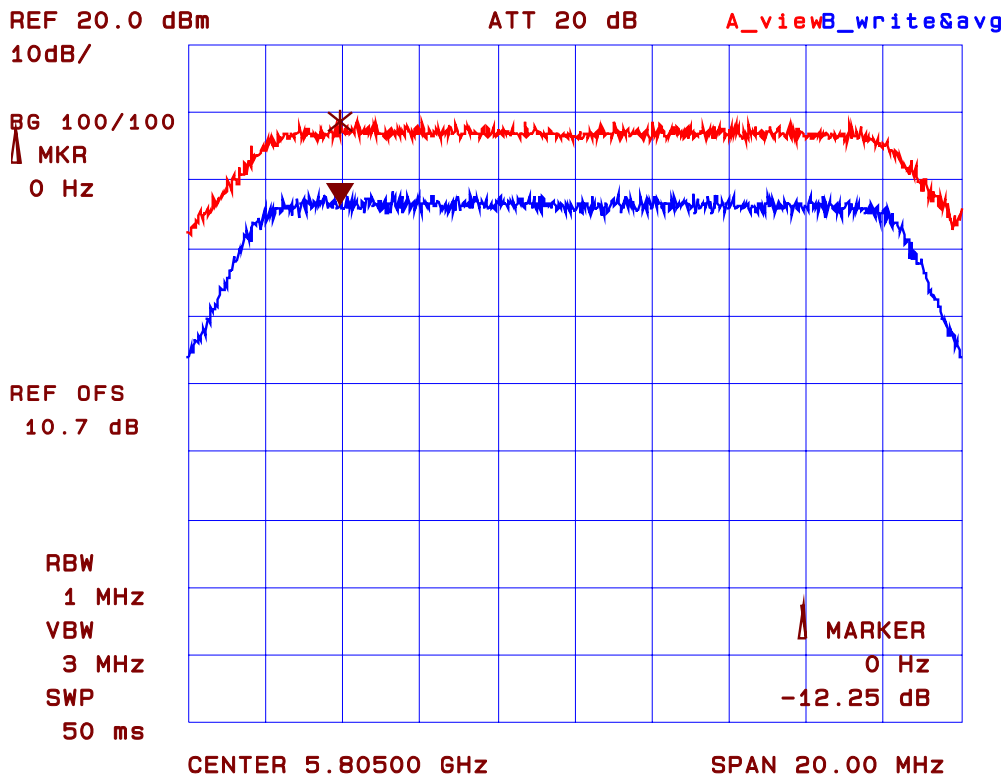

8.4. RF EXPOSURE REQUIRMENTS [§§ 15.407(f), 1.1310 & 2.1091]

8.4.1. Limits

- **FCC 15.407(f):** U-NII devices are subject to the radio frequency radiation exposure requirements specified in Sec. 1.1307(b), Sec. 2.1091 and Sec. 2.1093 of this chapter, as appropriate. All equipment shall be considered to operate in a "general population/uncontrolled" environment. Applications for equipment authorization of devices operating under this section must contain a statement confirming compliance with these requirements for both fundamental emissions and unwanted emissions. Technical information showing the basis for this statement must be submitted to the Commission upon request.
- **FCC 1.1310:-** The criteria listed in the following table shall be used to evaluate the environmental impact of human exposure to radio-frequency (RF) radiation as specified in 1.1307(b).

LIMITS FOR MAXIMUM PERMISSIBLE EXPOSURE (MPE)

Frequency Range (MHz)	Electric Field Strength (V/m)	Magnetic Field Strength (A/m)	Power Density (mW/cm ²)	Average Time (minutes)
(B) Limits for General Population/Uncontrolled Exposure				
1500-100,000	1.0	30

F = Frequency in MHz

8.4.2. Method of Measurements

In order to demonstrate compliance with MPE requirements (see Section 2.1091), the following information is typically needed:

1. Calculation that estimates the minimum separation distance (20 cm or more) between an antenna and persons required to satisfy power density limits defined for free space.

Calculation Method of RF Safety Distance:

$$S = PG/4\pi r^2 = EIRP/4\pi r^2$$

Where:

- P: power input to the antenna in mW
- EIRP: Equivalent (effective) isotropic radiated power.
- S: power density mW/cm²
- G: numeric gain of antenna relative to isotropic radiator
- r: distance to centre of radiation in cm

$$r = \sqrt{PG/4\pi S}$$

2. Antenna installation and device operating instructions for installers (professional/unskilled users), and the parties responsible for ensuring compliance with the RF exposure requirement
3. Any caution statements and/or warning labels that are necessary in order to comply with the exposure limits
4. Any other RF exposure related issues that may affect MPE compliance

8.4.3. Test Data

Frequency (MHz)	Highest Conducted Peak Power at the Antenna Terminal (dBm)	Maximum Antenna Gain (dBi)	Maximum Measured Total EIRP (dBm)	Minimum RF Safety Distance r (cm)
External Antenna				
5150 – 5825	16.81	5.0	21.8	3.5
Internal Antenna				
5150 – 5825	16.87	4.3	21.2	3.2

Note: RF EXPOSURE DISTANCE LIMITS: $r = (PG/4\pi IIS)^{1/2} = (EIRP/4\pi IIS)^{1/2}$
 Limits for General Population/Uncontrolled Exposure: **S = 1.0 mW/cm²**

Evaluation of RF Exposure Compliance Requirements	
RF Exposure Requirements	Compliance with FCC Rules
Minimum calculated separation distance between antenna and persons: 3.5 cm	Manufacturer' instruction for separation distance between antenna and persons required: 20 cm.
Antenna installation and device operating instructions for installers (professional/unskilled users), and the parties responsible for ensuring compliance with the RF exposure requirement	N/A
Caution statements and/or warning labels that are necessary in order to comply with the exposure limits	Refer to user's manual for RF Exposure information.
Any other RF exposure related issues that may affect MPE compliance	N/A

8.5. BAND-EDGE & UNDESIRE EMISSIONS (CONDUCTED) [§ 15.407(b)]

8.5.1. Limits

Undesirable emission limits: the PEAK emissions outside of the frequency bands of operation shall be attenuated in accordance with the following limits:

- (1) For transmitters operating in the 5.15-5.25 GHz band: all emissions outside of the 5.15-5.25 GHz, 5.25-5.35 GHz and band shall not exceed an EIRP of -27 dBm/MHz.
- (2) For transmitters operating in the 5.25-5.35 GHz band: all emissions outside of the 5.15-5.25 GHz, 5.25-5.35 GHz and band shall not exceed an EIRP of -27 dBm/MHz. Devices operating in the 5.25-5.35 GHz band that generate emissions in the 5.15-5.25 GHz band must meet all applicable technical requirements for operation in the 5.15-5.25 GHz band (including indoor use) or alternatively meet an out-of-band emission EIRP limit of -27 dBm/MHz in the 5.15-5.25 GHz band.
- (3) For transmitters operating in the 5.47-5.725 GHz band: all emissions outside of the 5.47-5.725 GHz band shall not exceed an EIRP of -27 dBm/MHz.
- (4) For transmitters operating in the 5.725-5.825 GHz band: all emissions within the frequency range from the band edge to 10 MHz above or below the band edge shall not exceed an EIRP of -17 dBm/MHz; for frequencies 10 MHz or greater above or below the band edge, emissions shall not exceed an EIRP of -27 dBm/MHz.
- (5) The emission measurements shall be performed using a minimum resolution bandwidth of 1 MHz. A lower resolution bandwidth may be employed near the band edge, when necessary, provided the measured energy is integrated to show the total power over 1 MHz.

8.5.2. Method of Measurements

Refer to Exhibit 10, Section 10.4 of this test report, FCC 15.407(b) & ANSI C63.4

8.5.3. Test Arrangement

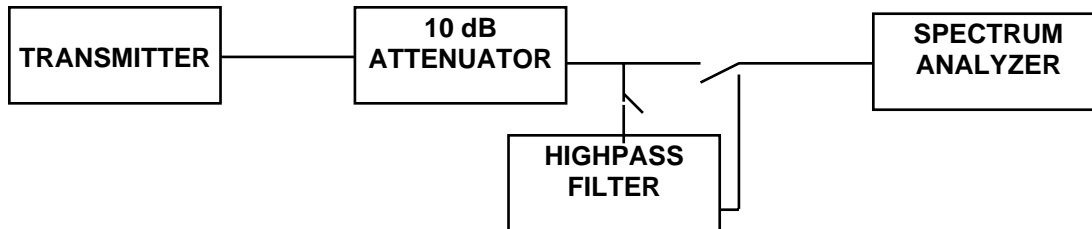

8.5.4. Test Equipment List

Test Instruments	Manufacturer	Model No.	Serial No.	Frequency Range
Spectrum Analyzer/ EMI Receiver	Advantest	R3271	15050203	100 Hz – 26.5 GHz
High Pass Filter	K & L	11SH10-8000/T18000-0/0	3	DC – 26 GHz

8.5.5. Test Data

8.5.5.1. Band-Edge Emissions

8.5.5.1.1. For 5.15-5.35 GHz Band

See the following plots (113-114) for detailed measurements:

Plot #113: Lower Band-Edge Conducted Emissions
Channel Freq.: 5180 MHz (CH36), Modulation: 64QAM at 54 Mbps

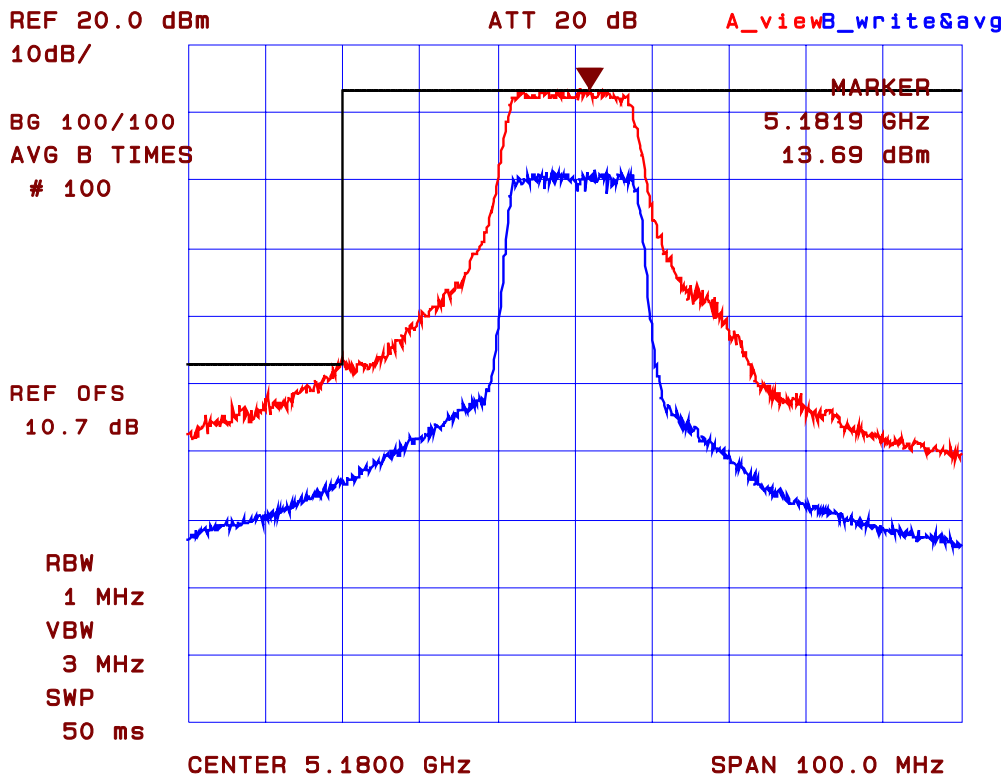

Plot #114: Upper Band-Edge Conducted Emissions
Channel Freq.: 5320 MHz (CH64), Modulation: 64QAM at 54 Mbps

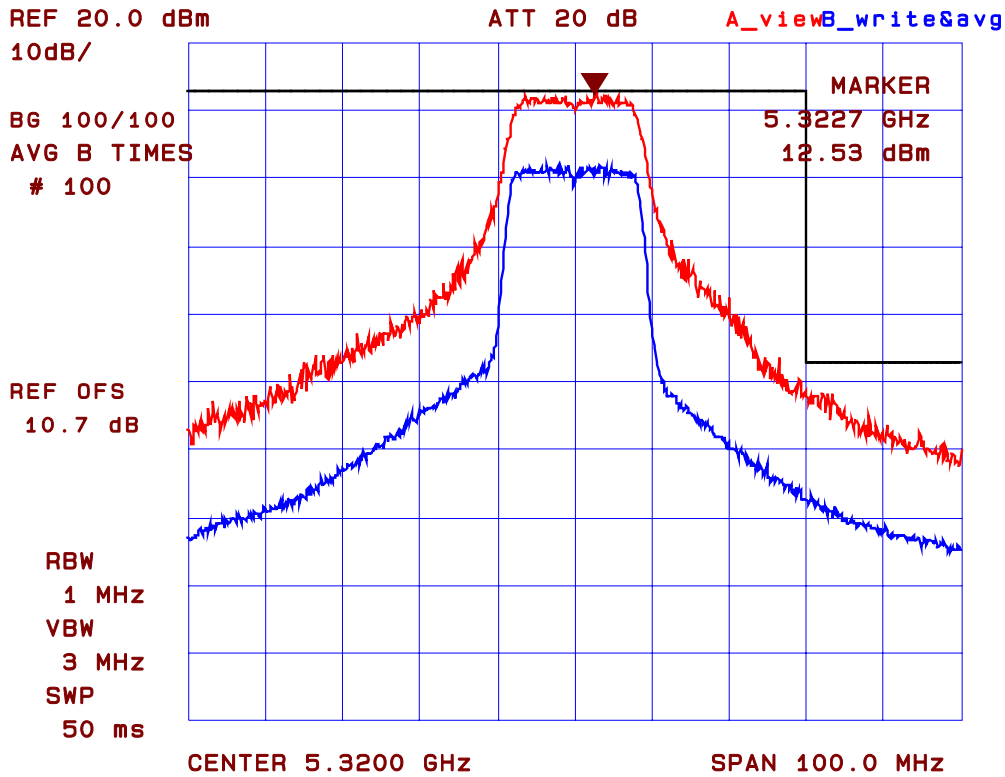

ULTRATECH GROUP OF LABS

3000 Bristol Circle, Oakville, Ontario, Canada L6H 6G4
Tel. #: 905-829-1570, Fax. #: 905-829-8050, Email: vic@ultratech-labs.com, Website: <http://www.ultratech-labs.com>

File #: CNI-027FCC15CE
June 10, 2005

All test results contained in this engineering test report are traceable to National Institute of Standards and Technology (NIST)

8.5.5.1.2. For 5.725-5.825 GHz Band

See the following plots (115-116) for detailed measurements:

Plot #115: Lower Band-Edge Conducted Emissions
Channel Freq.: 5745 MHz (CH149), Modulation: 64QAM at 54 Mbps

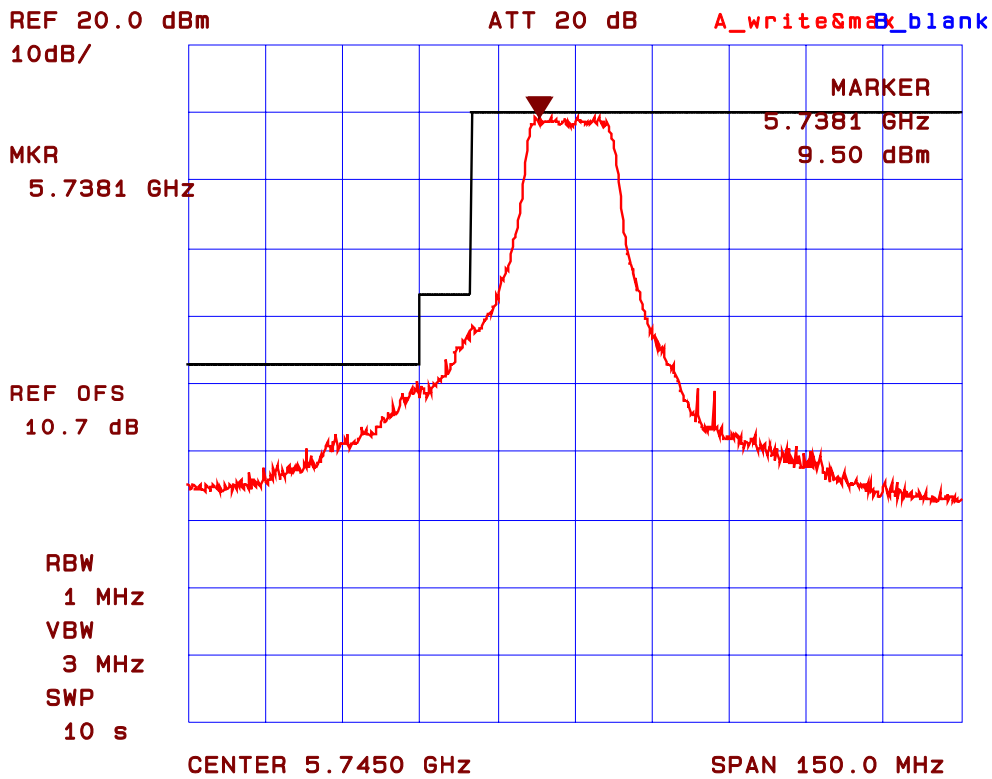

Plot #116: Upper Band-Edge Conducted Emissions
Channel Freq.: 5805 MHz (CH161), Modulation: 64QAM at 54 Mbps

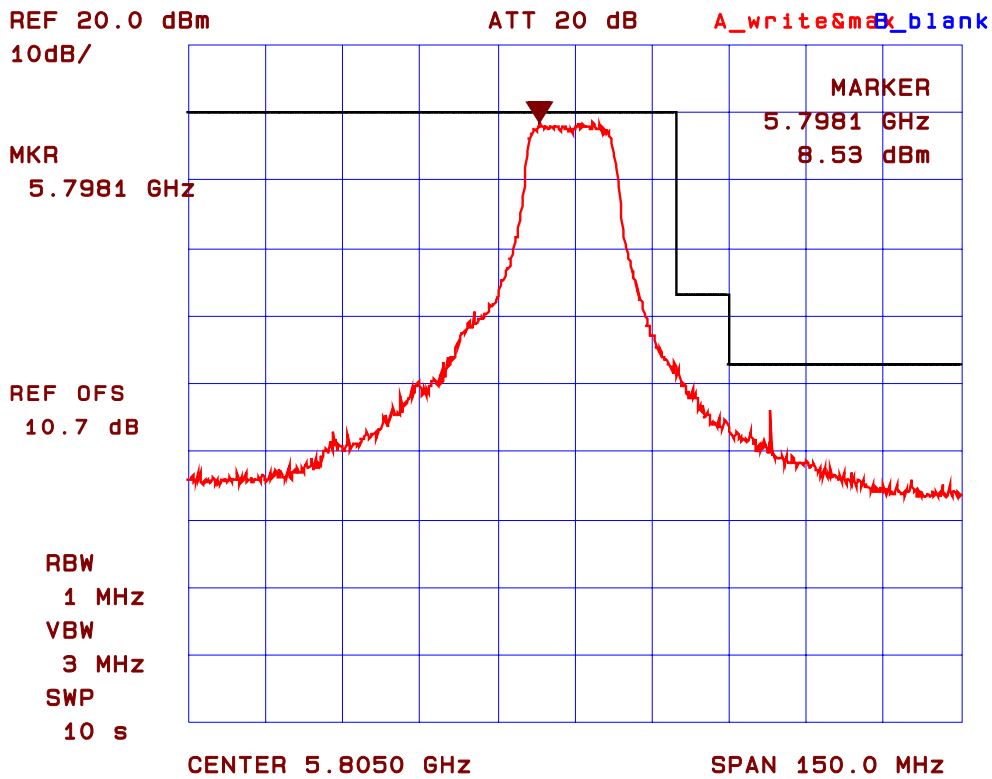

8.5.5.2. Undesired Emissions

8.5.5.2.1. For 5.15-5.25 GHz Band

See the following plots (117-128) for detailed measurements:

Plot #117: Conducted Emissions
Channel Freq.: 5180 MHz (CH36, Near Bottom of 5.15-5.25 GHz Band)
Modulation: 64QAM at 54 Mbps Data Rate

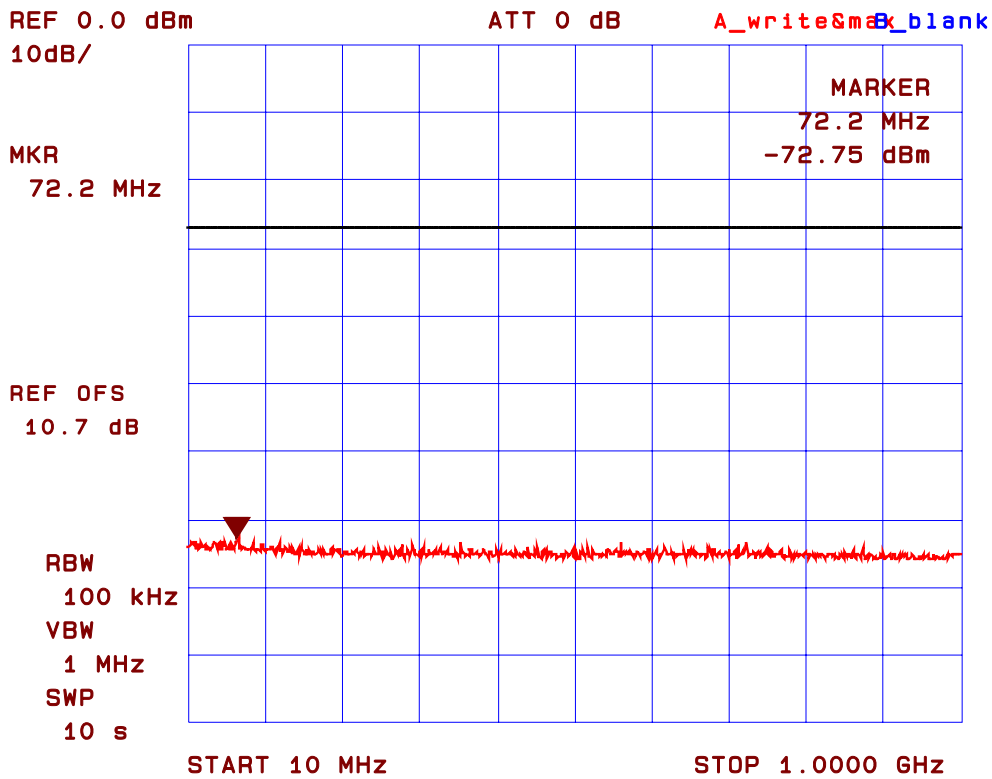

Plot #118: Conducted Emissions
Channel Freq.: 5180 MHz (CH36, Near Bottom of 5.15-5.25 GHz Band)
Modulation: 64QAM at 54 Mbps Data Rate

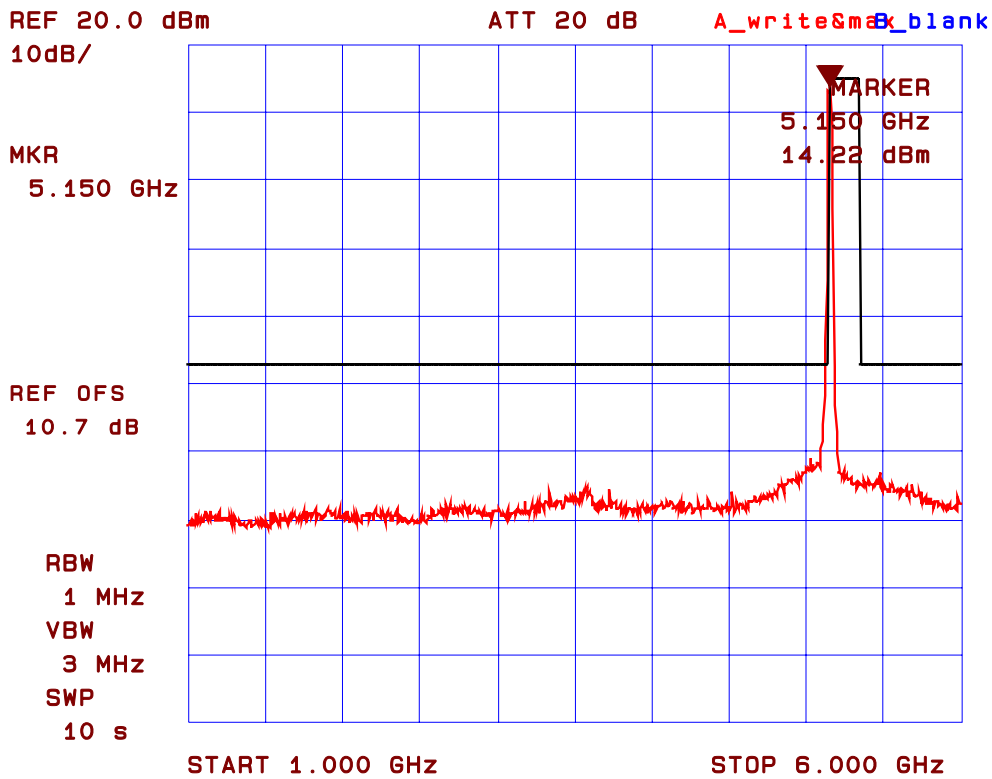

Plot #119: Conducted Emissions
Channel Freq.: 5180 MHz (CH36, Near Bottom of 5.15-5.25 GHz Band)
Modulation: 64QAM at 54 Mbps Data Rate

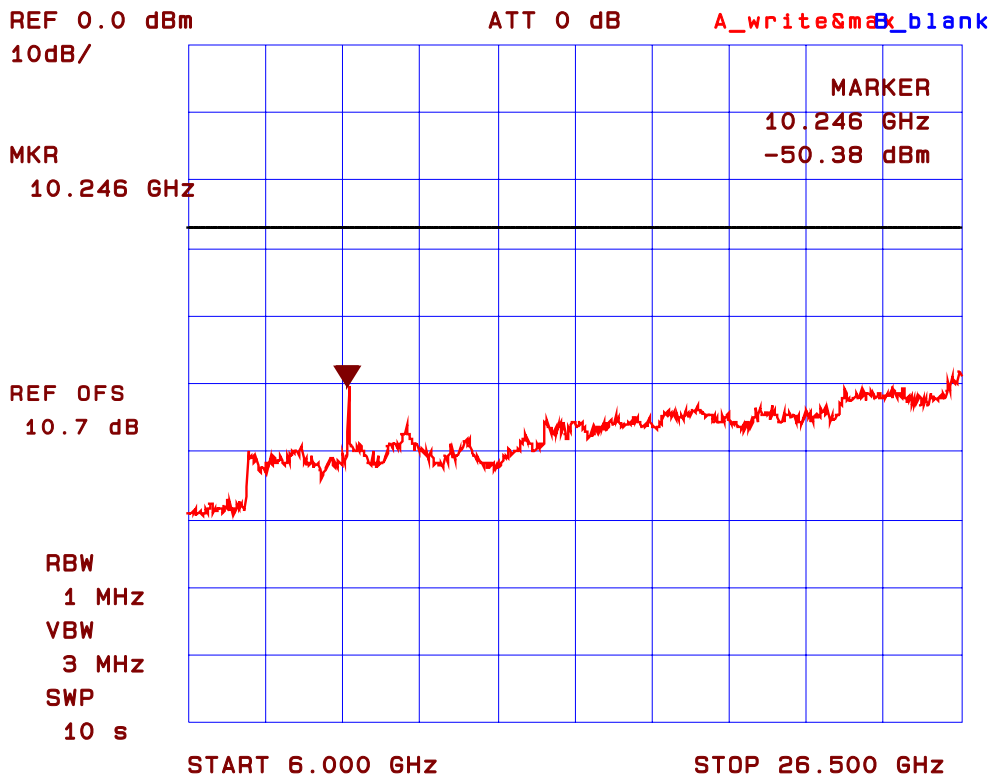

Plot #120: Conducted Emissions
Channel Freq.: 5180 MHz (CH36, Near Bottom of 5.15-5.25 GHz Band)
Modulation: 64QAM at 54 Mbps Data Rate

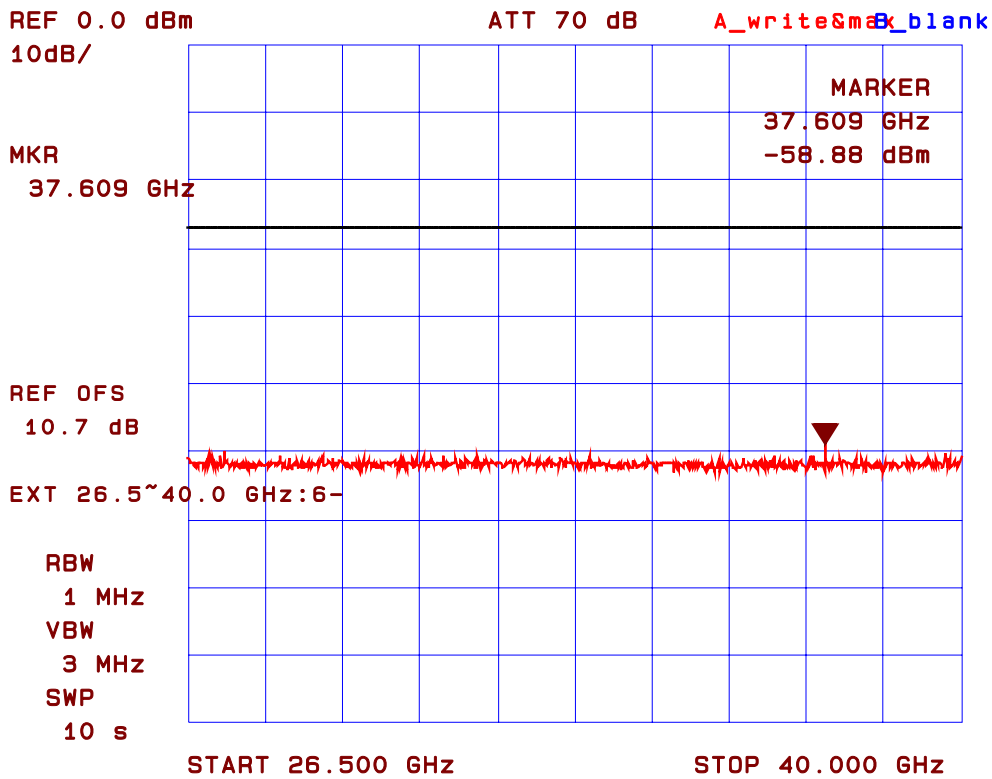

Plot #121: Conducted Emissions
Channel Freq.: 5220 MHz (CH44, Near Middle of 5.15-5.25 GHz Band)
Modulation: 64QAM at 54 Mbps Data Rate

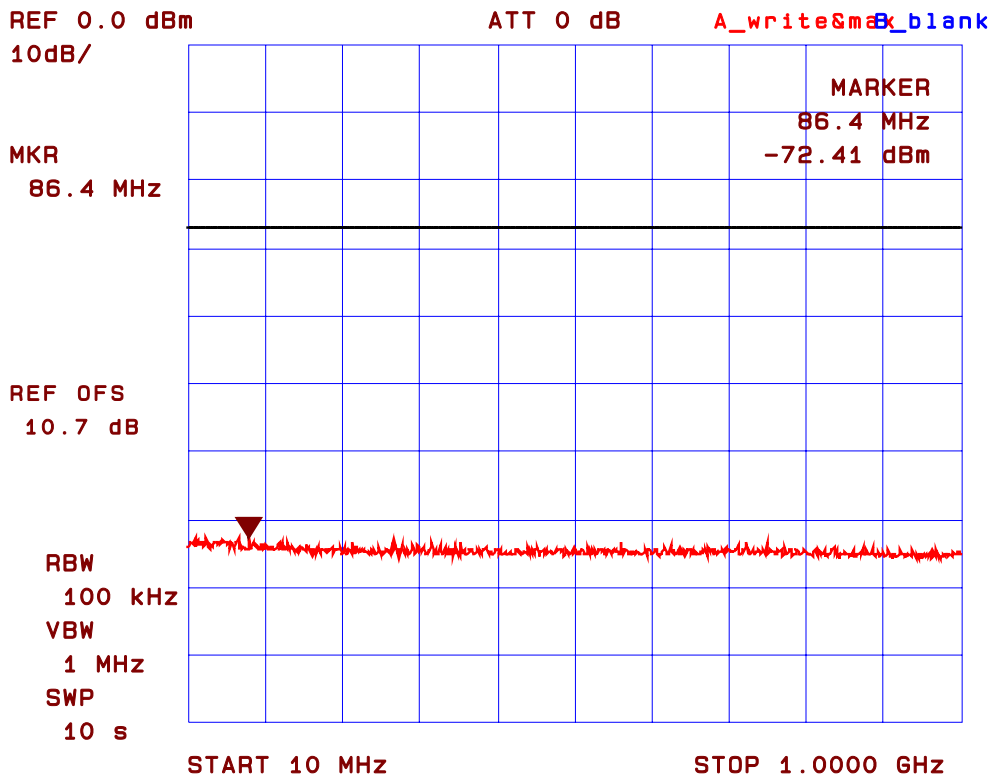

Plot #122: Conducted Emissions
Channel Freq.: 5220 MHz (CH44, Near Middle of 5.15-5.25 GHz Band)
Modulation: 64QAM at 54 Mbps Data Rate

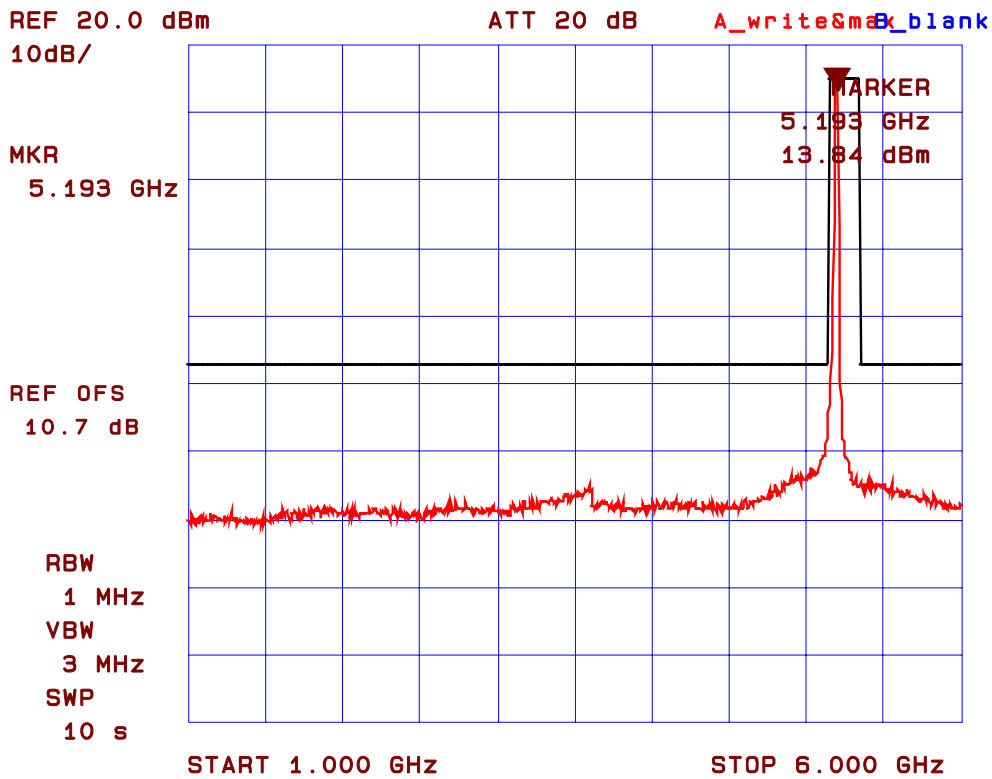

ULTRATECH GROUP OF LABS

3000 Bristol Circle, Oakville, Ontario, Canada L6H 6G4
Tel. #: 905-829-1570, Fax. #: 905-829-8050, Email: vic@ultratech-labs.com, Website: <http://www.ultratech-labs.com>

File #: CNI-027FCC15CE

June 10, 2005

All test results contained in this engineering test report are traceable to National Institute of Standards and Technology (NIST)

Plot #123: Conducted Emissions
Channel Freq.: 5220 MHz (CH44, Near Middle of 5.15-5.25 GHz Band)
Modulation: 64QAM at 54 Mbps Data Rate

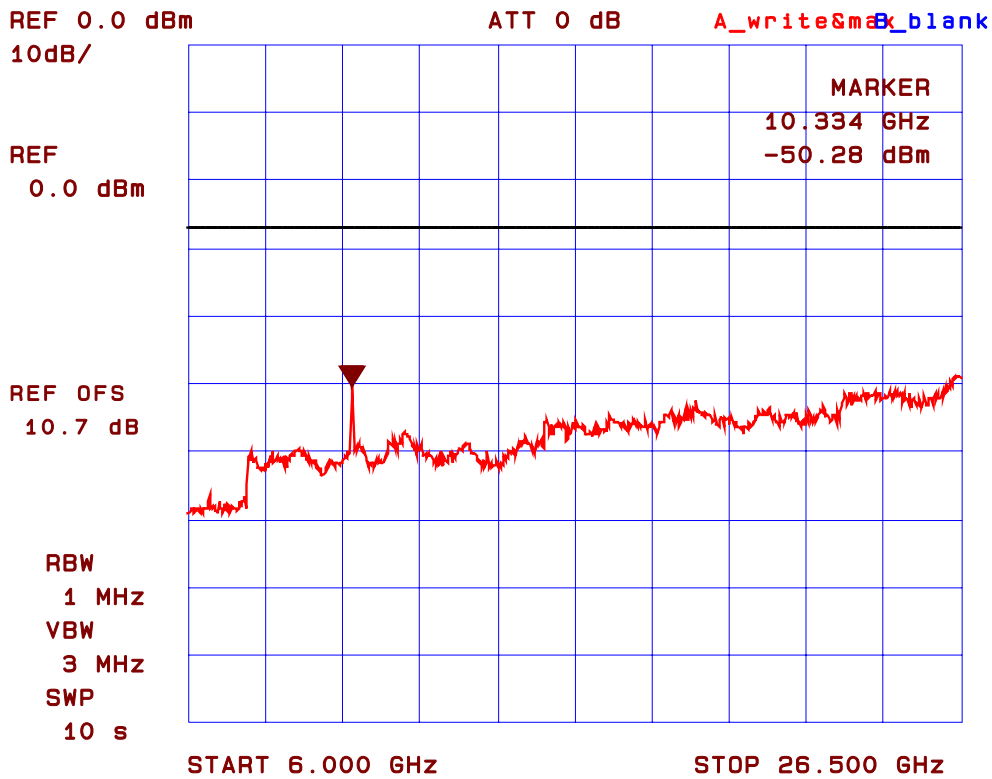

ULTRATECH GROUP OF LABS

3000 Bristol Circle, Oakville, Ontario, Canada L6H 6G4
Tel. #: 905-829-1570, Fax. #: 905-829-8050, Email: vic@ultratech-labs.com, Website: <http://www.ultratech-labs.com>

File #: CNI-027FCC15CE

June 10, 2005

All test results contained in this engineering test report are traceable to National Institute of Standards and Technology (NIST)

Plot #124: Conducted Emissions
Channel Freq.: 5220 MHz (CH44, Near Middle of 5.15-5.25 GHz Band)
Modulation: 64QAM at 54 Mbps Data Rate

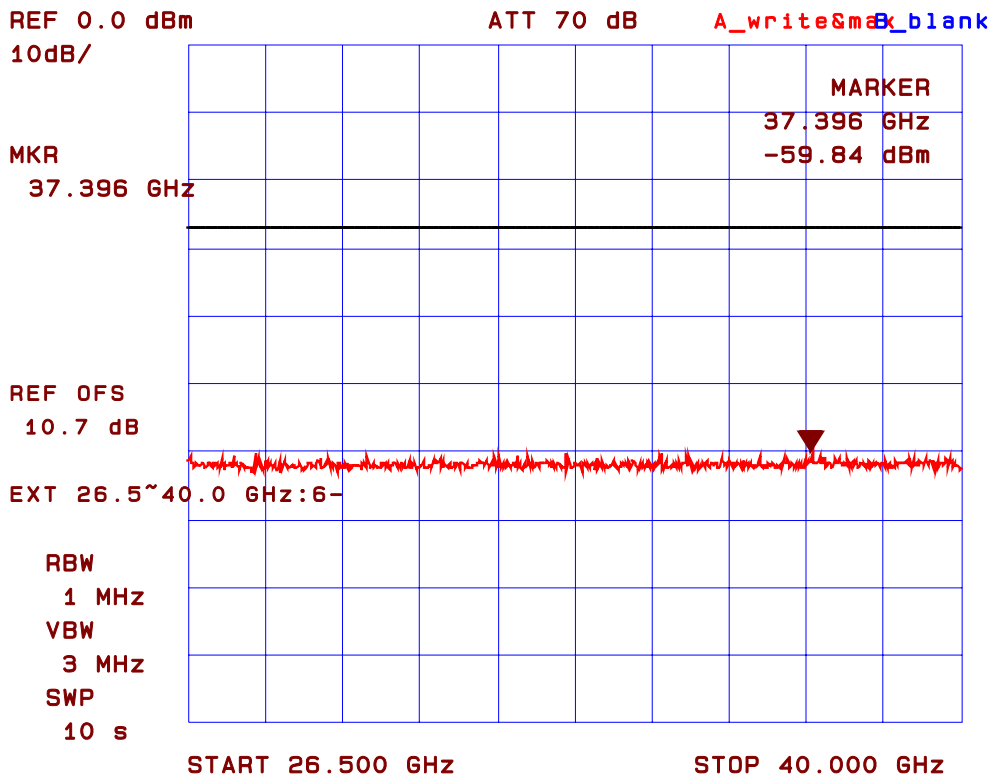

Plot #125: Conducted Emissions
Channel Freq.: 5240 MHz (CH48, Near Top of 5.15-5.25 GHz Band)
Modulation: 64QAM at 54 Mbps Data Rate

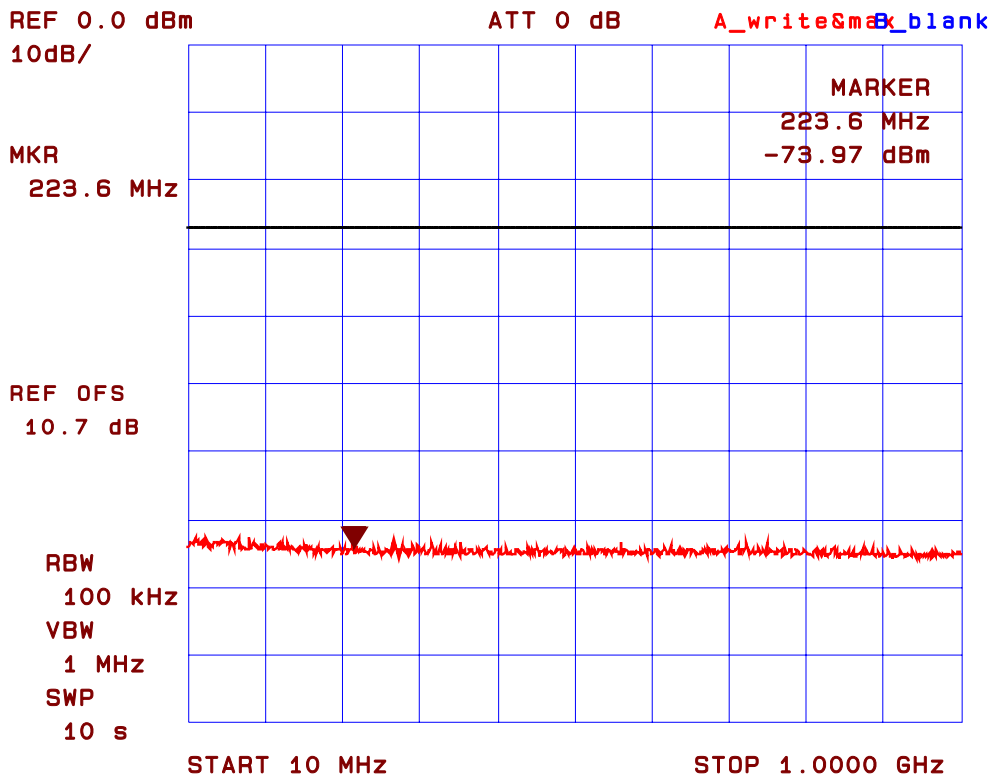

Plot #126: Conducted Emissions
Channel Freq.: 5240 MHz (CH48, Near Top of 5.15-5.25 GHz Band)
Modulation: 64QAM at 54 Mbps Data Rate

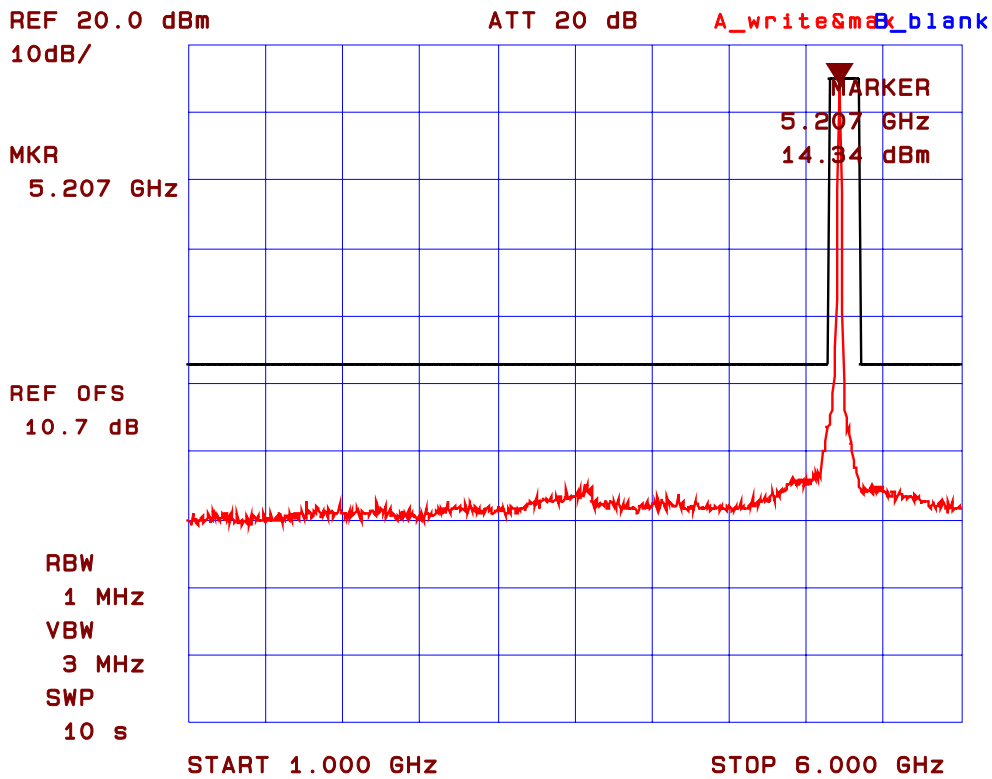

Plot #127: Conducted Emissions
Channel Freq.: 5240 MHz (CH48, Near Top of 5.15-5.25 GHz Band)
Modulation: 64QAM at 54 Mbps Data Rate

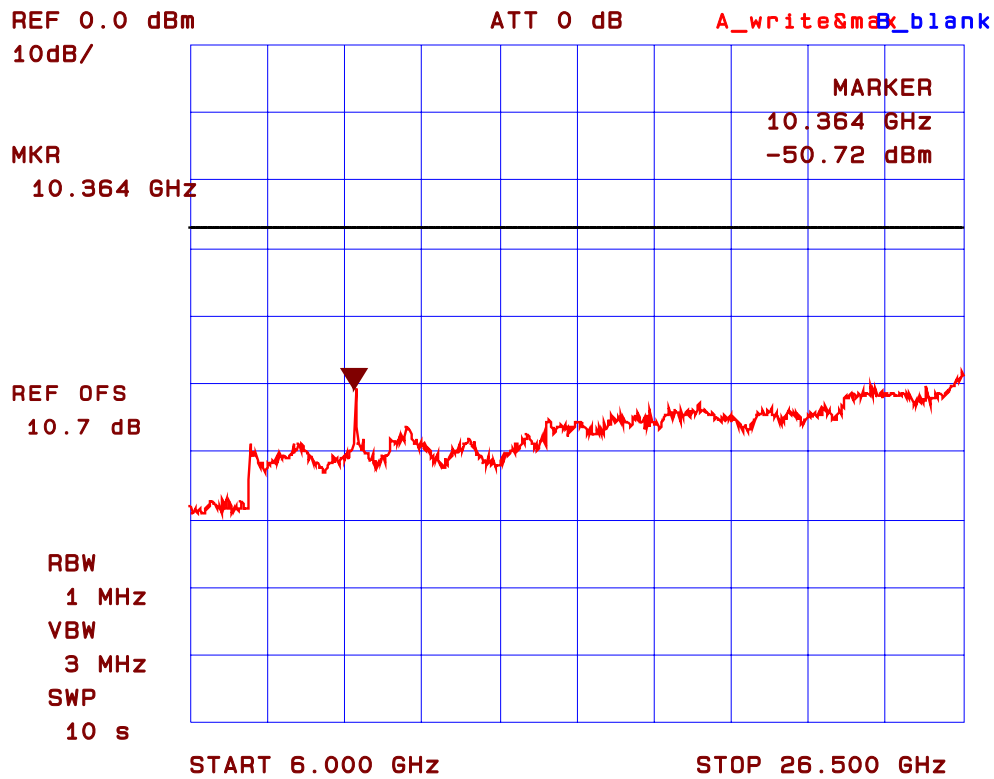

ULTRATECH GROUP OF LABS

3000 Bristol Circle, Oakville, Ontario, Canada L6H 6G4
Tel. #: 905-829-1570, Fax. #: 905-829-8050, Email: vic@ultratech-labs.com, Website: <http://www.ultratech-labs.com>

File #: CNI-027FCC15CE

June 10, 2005

All test results contained in this engineering test report are traceable to National Institute of Standards and Technology (NIST)

Plot #128: Conducted Emissions
Channel Freq.: 5240 MHz (CH48, Near Top of 5.15-5.25 GHz Band)
Modulation: 64QAM at 54 Mbps Data Rate

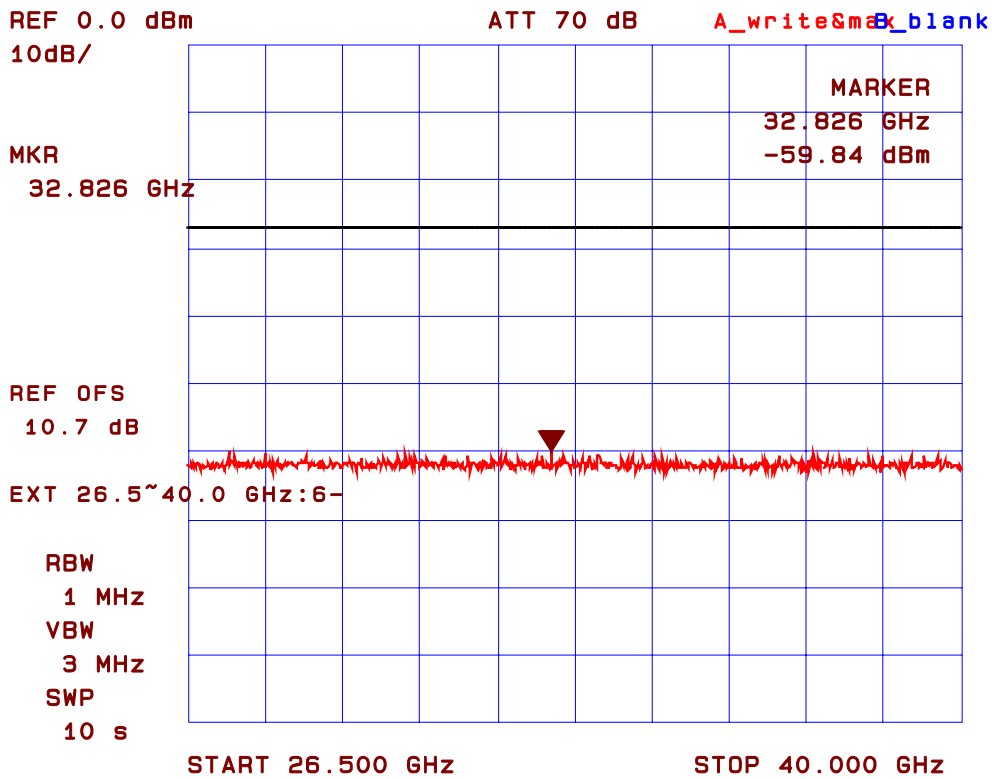

8.5.5.2.2. For 5.25-5.35 GHz Band

See the following plots (129-140) for detailed measurements:

Plot #129: Conducted Emissions
Channel Freq.: 5260 MHz (CH52, Near Bottom of 5.25-5.35 GHz Band)
Modulation: 64QAM at 54 Mbps Data Rate

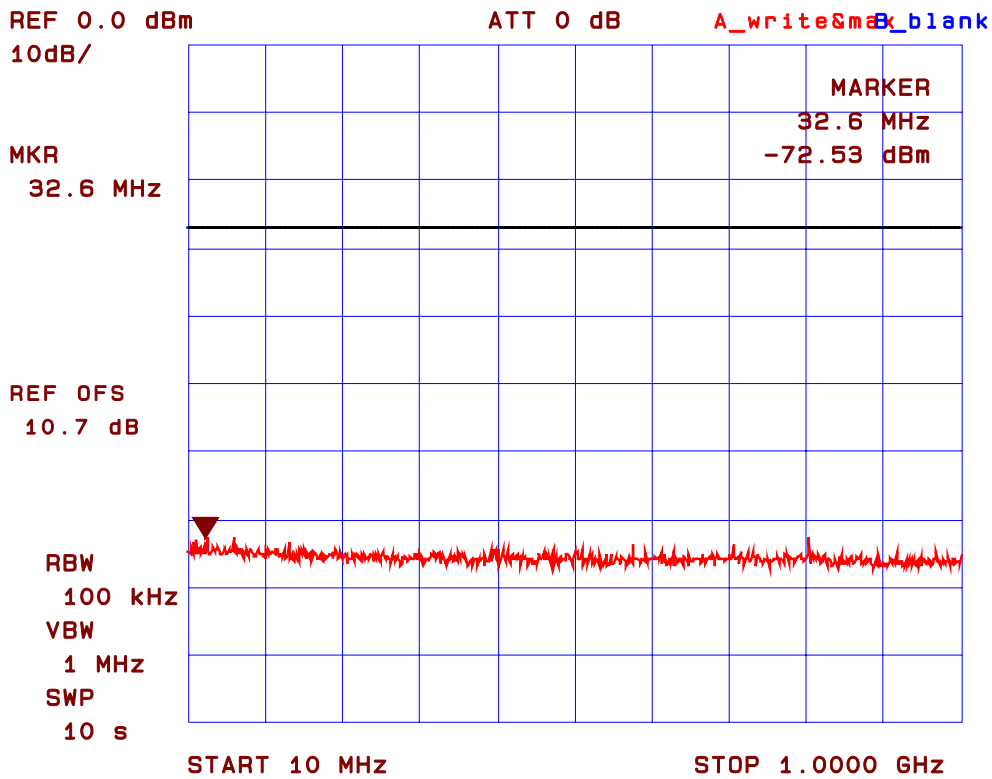

Plot #130: Conducted Emissions
Channel Freq.: 5260 MHz (CH52, Near Bottom of 5.25-5.35 GHz Band)
Modulation: 64QAM at 54 Mbps Data Rate

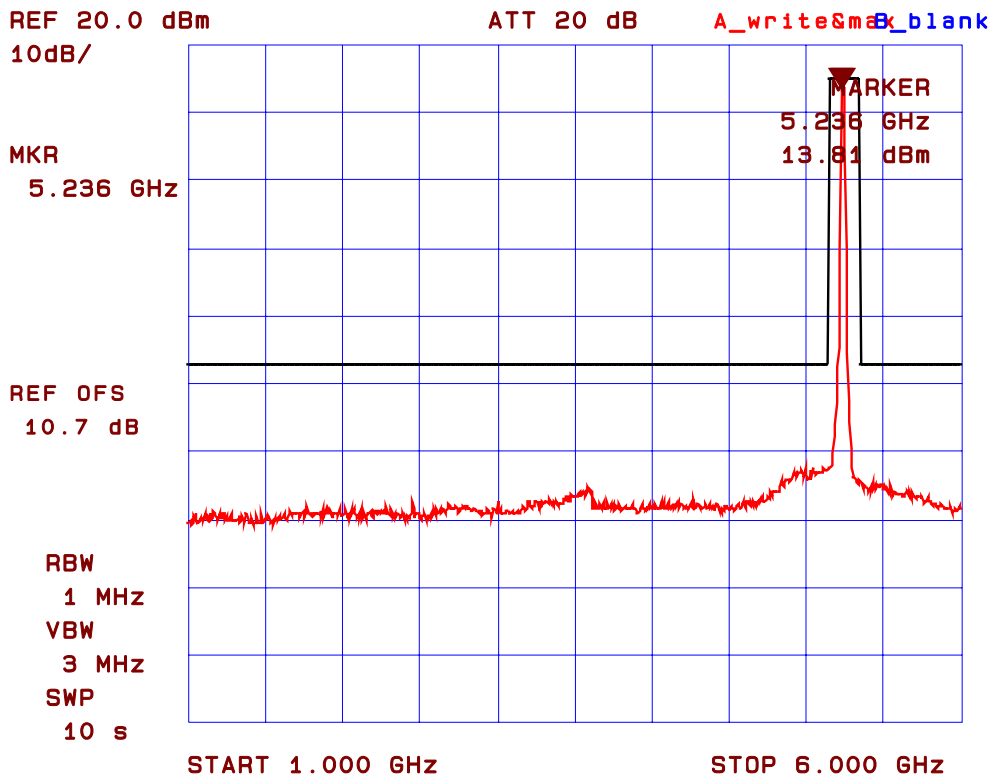

ULTRATECH GROUP OF LABS

3000 Bristol Circle, Oakville, Ontario, Canada L6H 6G4
Tel. #: 905-829-1570, Fax. #: 905-829-8050, Email: vic@ultratech-labs.com, Website: <http://www.ultratech-labs.com>

File #: CNI-027FCC15CE

June 10, 2005

All test results contained in this engineering test report are traceable to National Institute of Standards and Technology (NIST)

Plot #131: Conducted Emissions
Channel Freq.: 5260 MHz (CH52, Near Bottom of 5.25-5.35 GHz Band)
Modulation: 64QAM at 54 Mbps Data Rate

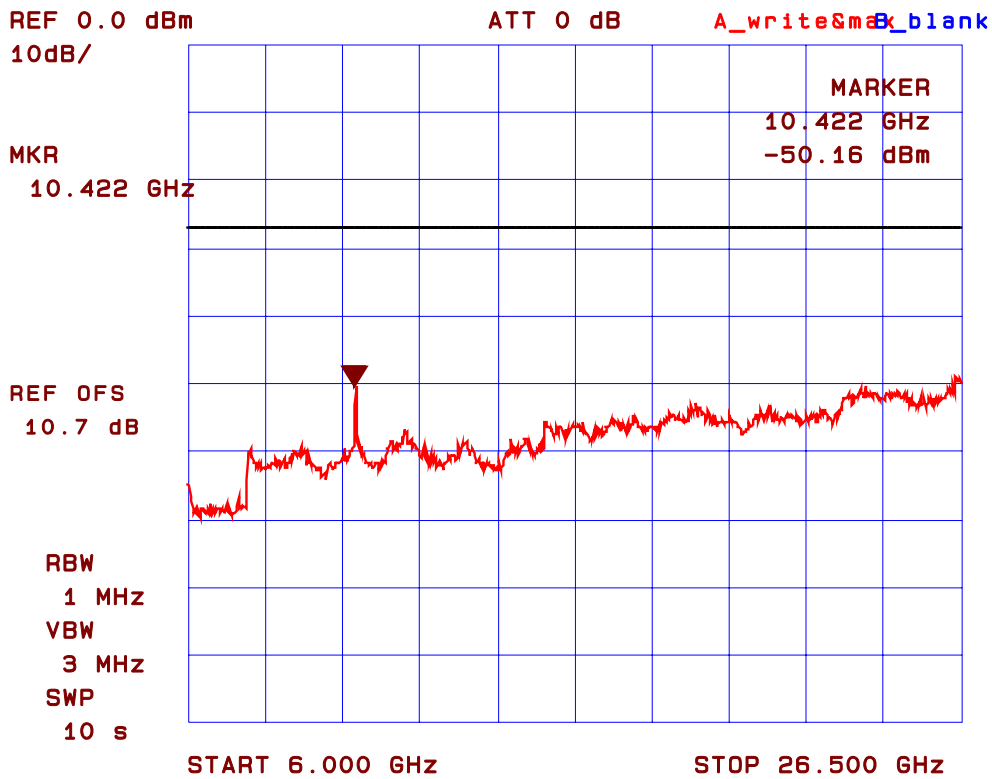

ULTRATECH GROUP OF LABS

3000 Bristol Circle, Oakville, Ontario, Canada L6H 6G4
Tel. #: 905-829-1570, Fax. #: 905-829-8050, Email: vic@ultratech-labs.com, Website: <http://www.ultratech-labs.com>

File #: CNI-027FCC15CE

June 10, 2005

All test results contained in this engineering test report are traceable to National Institute of Standards and Technology (NIST)

Plot #132: Conducted Emissions
Channel Freq.: 5260 MHz (CH52, Near Bottom of 5.25-5.35 GHz Band)
Modulation: 64QAM at 54 Mbps Data Rate

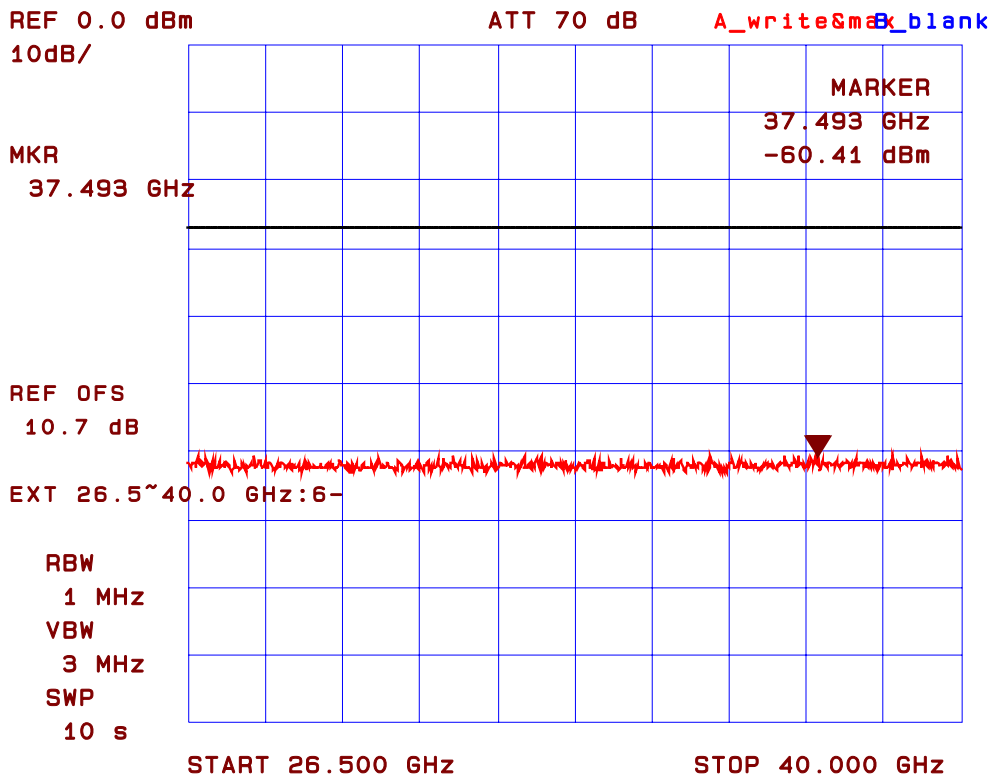

Plot #133: Conducted Emissions
Channel Freq.: 5300 MHz (CH60, Near Middle of 5.25-5.35 GHz Band)
Modulation: 64QAM at 54 Mbps Data Rate

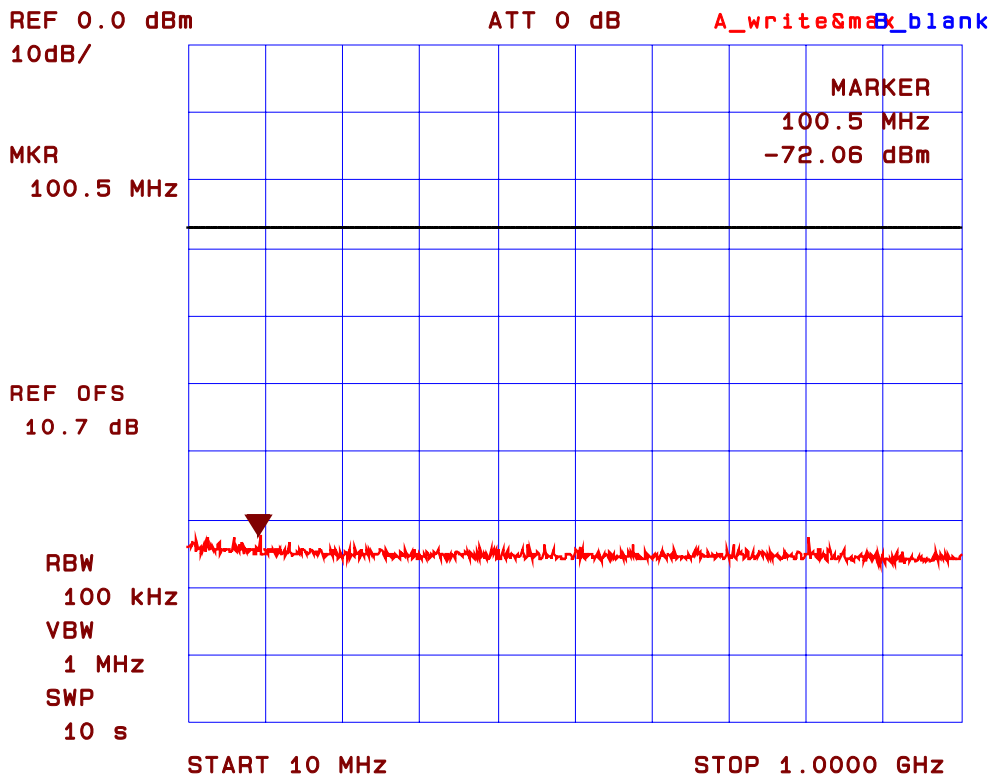

Plot #134: Conducted Emissions
Channel Freq.: 5300 MHz (CH60, Near Middle of 5.25-5.35 GHz Band)
Modulation: 64QAM at 54 Mbps Data Rate

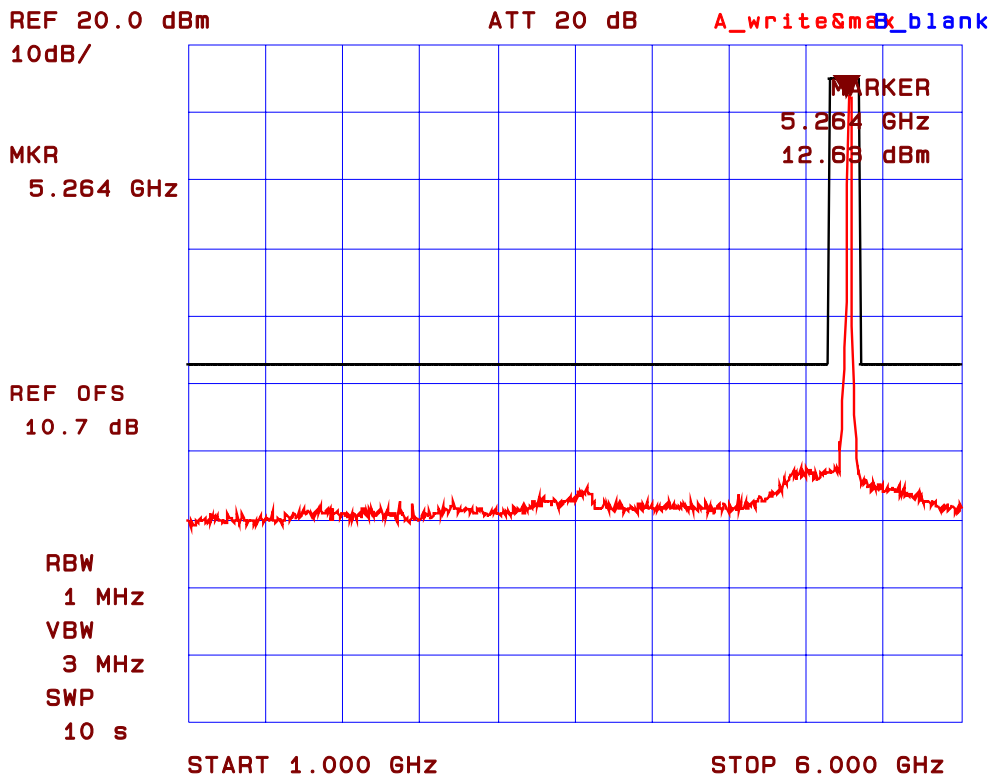

Plot #135: Conducted Emissions
Channel Freq.: 5300 MHz (CH60, Near Middle of 5.25-5.35 GHz Band)
Modulation: 64QAM at 54 Mbps Data Rate

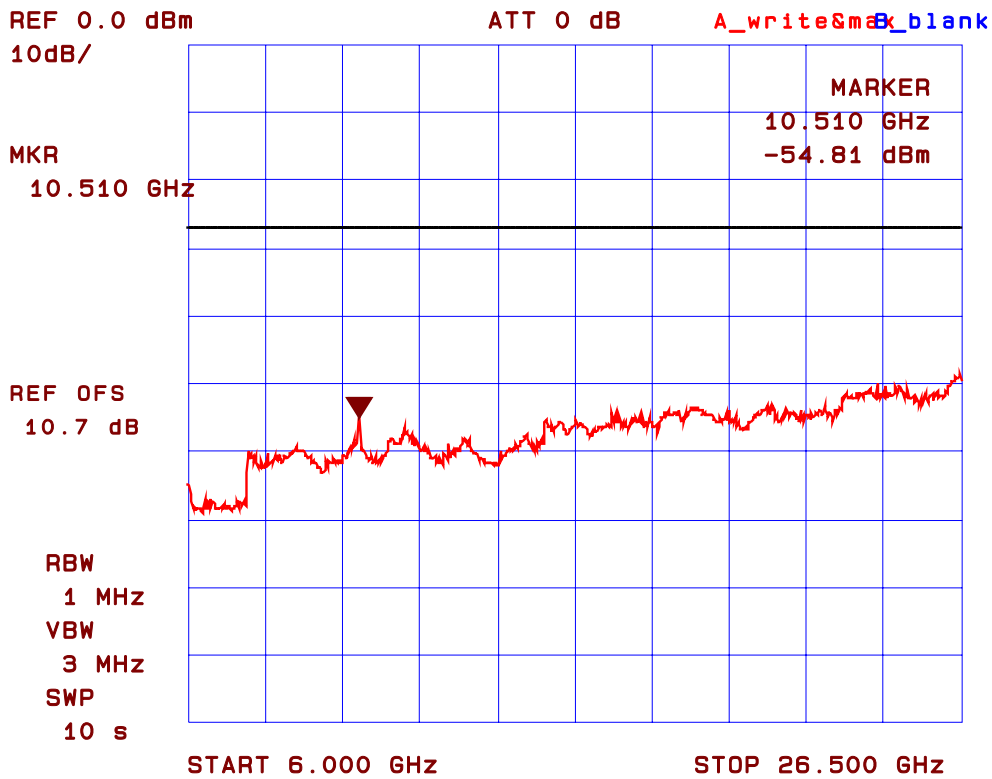

ULTRATECH GROUP OF LABS

3000 Bristol Circle, Oakville, Ontario, Canada L6H 6G4
Tel. #: 905-829-1570, Fax. #: 905-829-8050, Email: vic@ultratech-labs.com, Website: <http://www.ultratech-labs.com>

File #: CNI-027FCC15CE
June 10, 2005

All test results contained in this engineering test report are traceable to National Institute of Standards and Technology (NIST)

Plot #136: Conducted Emissions
Channel Freq.: 5300 MHz (CH60, Near Middle of 5.25-5.35 GHz Band)
Modulation: 64QAM at 54 Mbps Data Rate

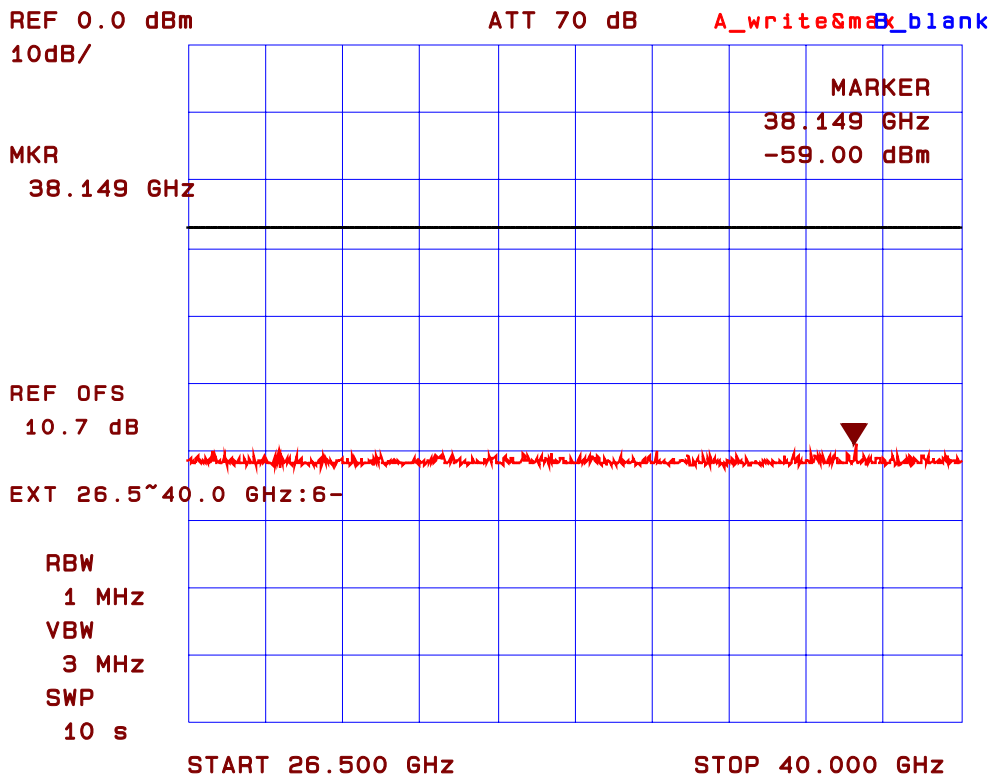

Plot #137: Conducted Emissions
Channel Freq.: 5320 MHz (CH64, Near Top of 5.25-5.35 GHz Band)
Modulation: 64QAM at 54 Mbps Data Rate

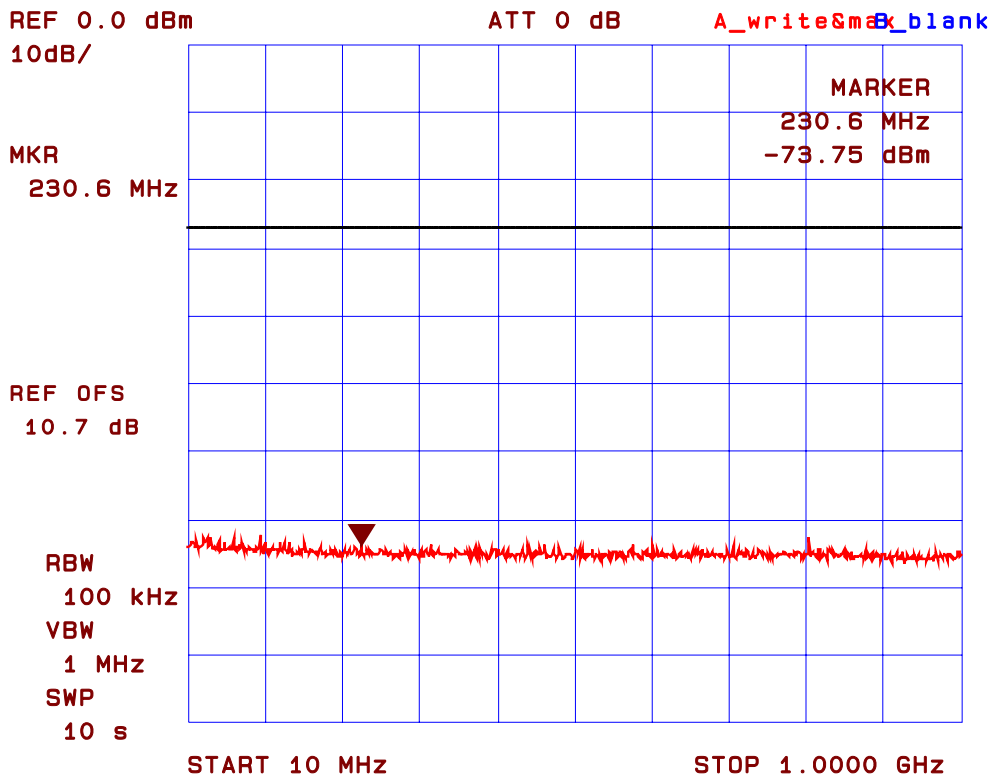

Plot #138: Conducted Emissions
Channel Freq.: 5320 MHz (CH64, Near Top of 5.25-5.35 GHz Band)
Modulation: 64QAM at 54 Mbps Data Rate

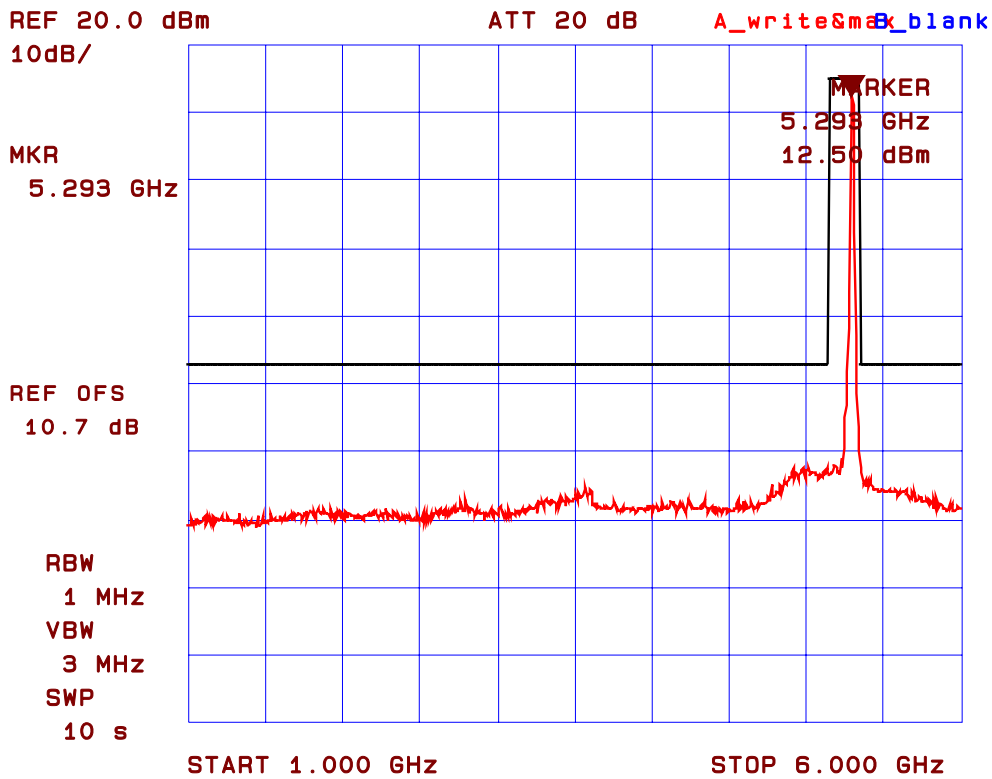

Plot #139: Conducted Emissions
Channel Freq.: 5320 MHz (CH64, Near Top of 5.25-5.35 GHz Band)
Modulation: 64QAM at 54 Mbps Data Rate

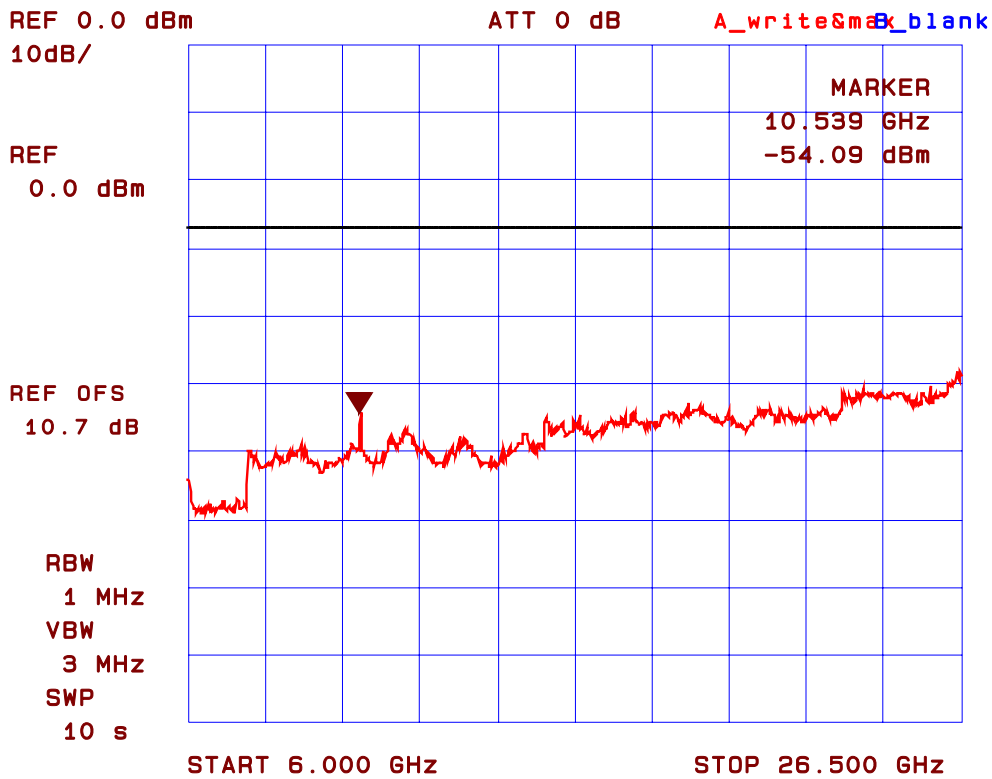

ULTRATECH GROUP OF LABS

3000 Bristol Circle, Oakville, Ontario, Canada L6H 6G4
Tel. #: 905-829-1570, Fax. #: 905-829-8050, Email: vic@ultratech-labs.com, Website: <http://www.ultratech-labs.com>

File #: CNI-027FCC15CE

June 10, 2005

All test results contained in this engineering test report are traceable to National Institute of Standards and Technology (NIST)

Plot #140: Conducted Emissions
Channel Freq.: 5320 MHz (CH64, Near Top of 5.25-5.35 GHz Band)
Modulation: 64QAM at 54 Mbps Data Rate

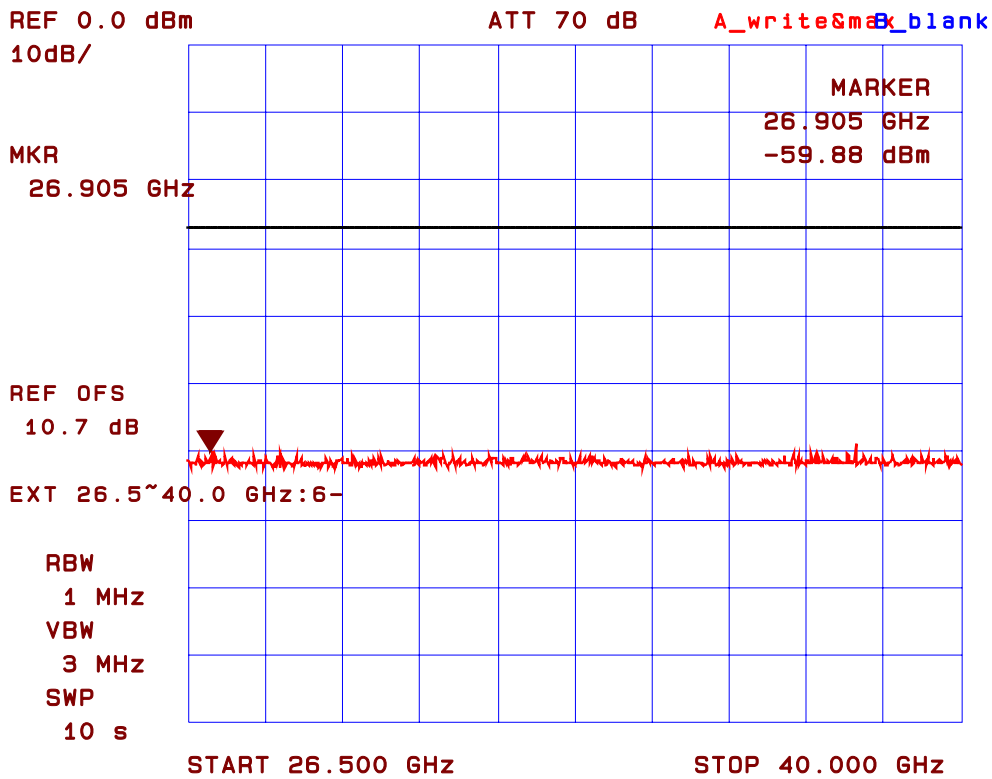

8.5.5.2.3. For 5.725-5.825 GHz Band

See the following plots (141-152) for detailed measurements:

Plot #141: Conducted Emissions
Channel Freq.: 5745 MHz (CH149, Near Bottom of 5.725-5.825 GHz Band)
Modulation: 64QAM at 54 Mbps Data Rate

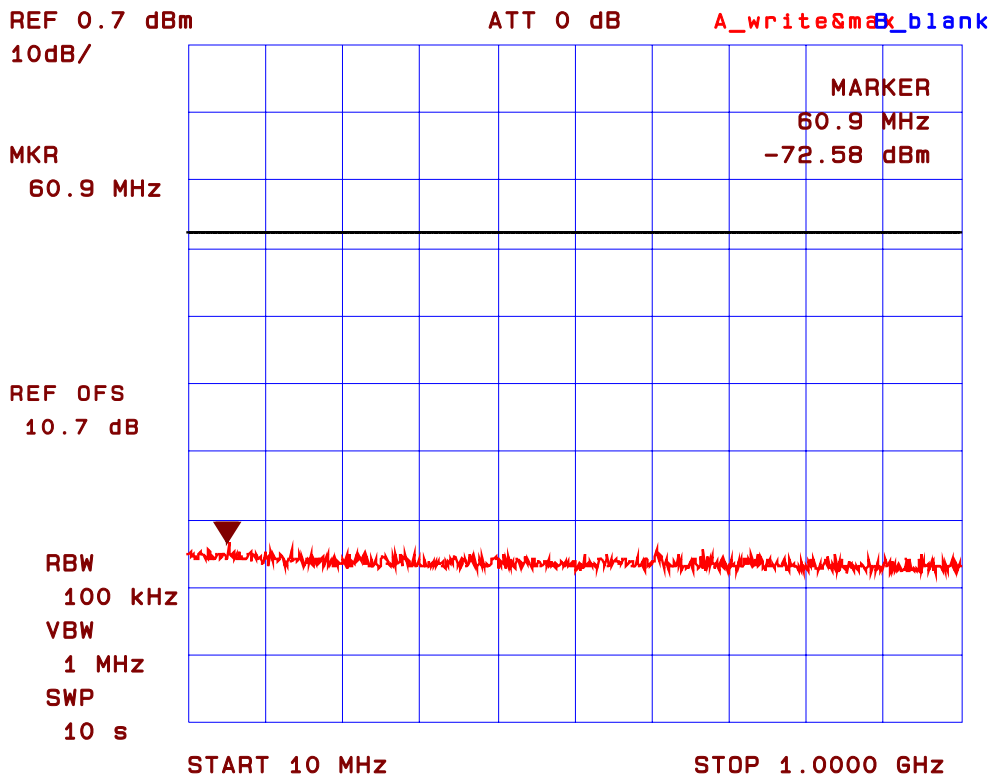

Plot #142: Conducted Emissions
Channel Freq.: 5745 MHz (CH149, Near Bottom of 5.725-5.825 GHz Band)
Modulation: 64QAM at 54 Mbps Data Rate

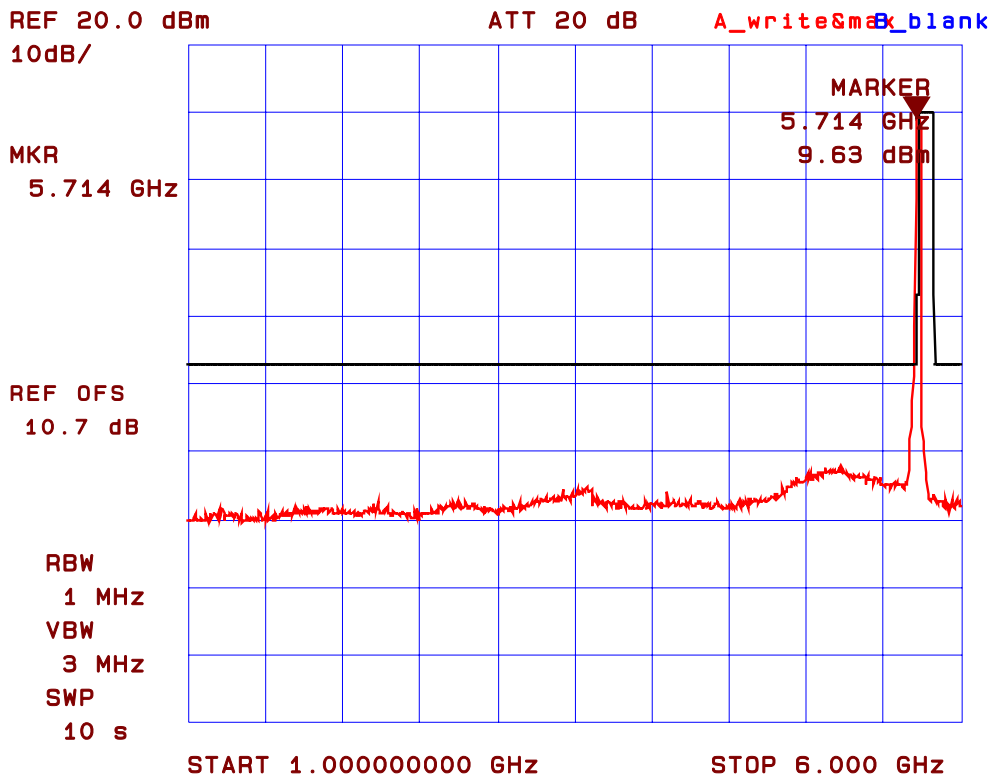

Plot #143: Conducted Emissions
Channel Freq.: 5745 MHz (CH149, Near Bottom of 5.725-5.825 GHz Band)
Modulation: 64QAM at 54 Mbps Data Rate

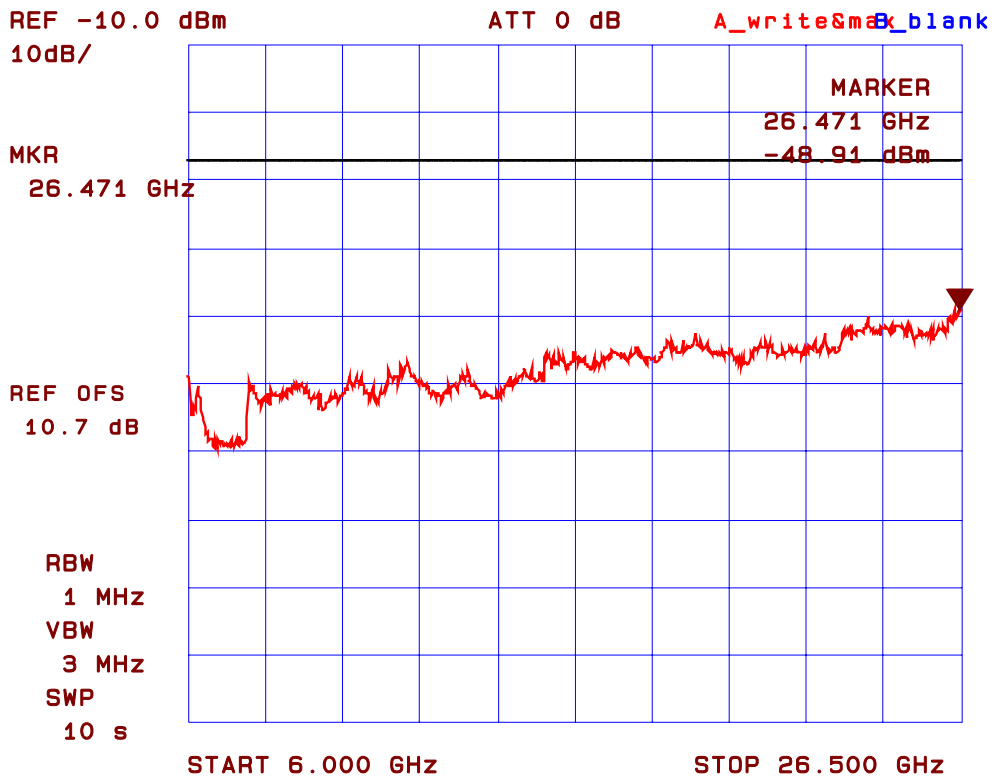

ULTRATECH GROUP OF LABS

3000 Bristol Circle, Oakville, Ontario, Canada L6H 6G4
Tel. #: 905-829-1570, Fax. #: 905-829-8050, Email: vic@ultratech-labs.com, Website: <http://www.ultratech-labs.com>

File #: CNI-027FCC15CE

June 10, 2005

All test results contained in this engineering test report are traceable to National Institute of Standards and Technology (NIST)

Plot #144: Conducted Emissions
Channel Freq.: 5745 MHz (CH149, Near Bottom of 5.725-5.825 GHz Band)
Modulation: 64QAM at 54 Mbps Data Rate

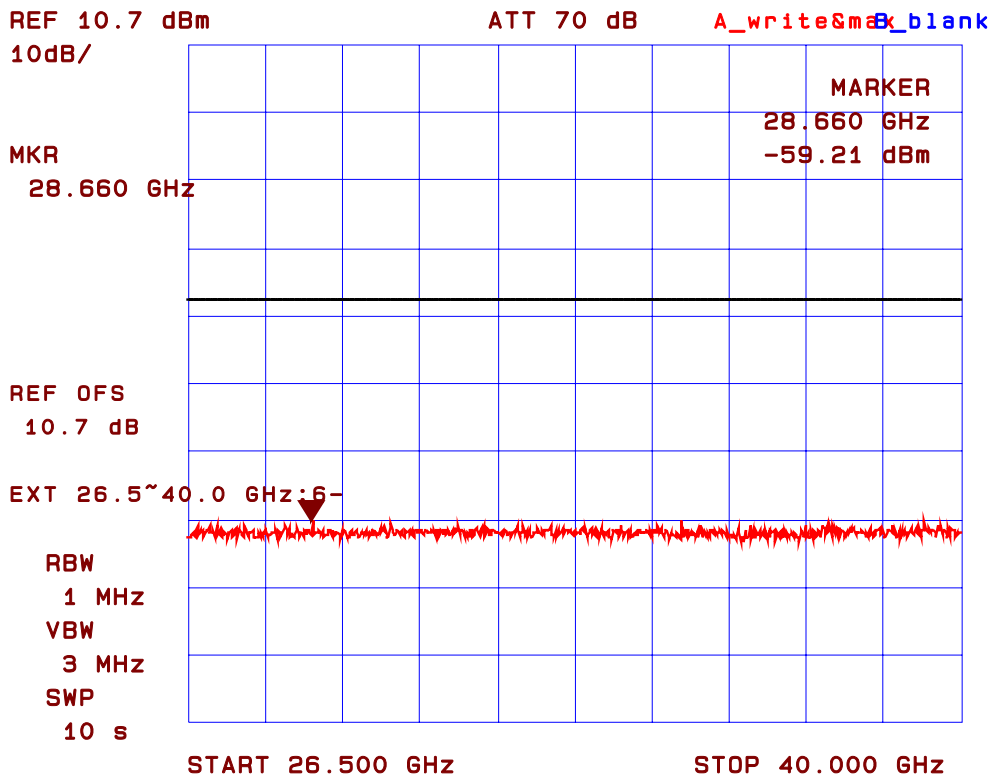

Plot #145: Conducted Emissions
Channel Freq.: 5785 MHz (CH157, Near Middle of 5.725-5.825 GHz Band)
Modulation: 64QAM at 54 Mbps Data Rate

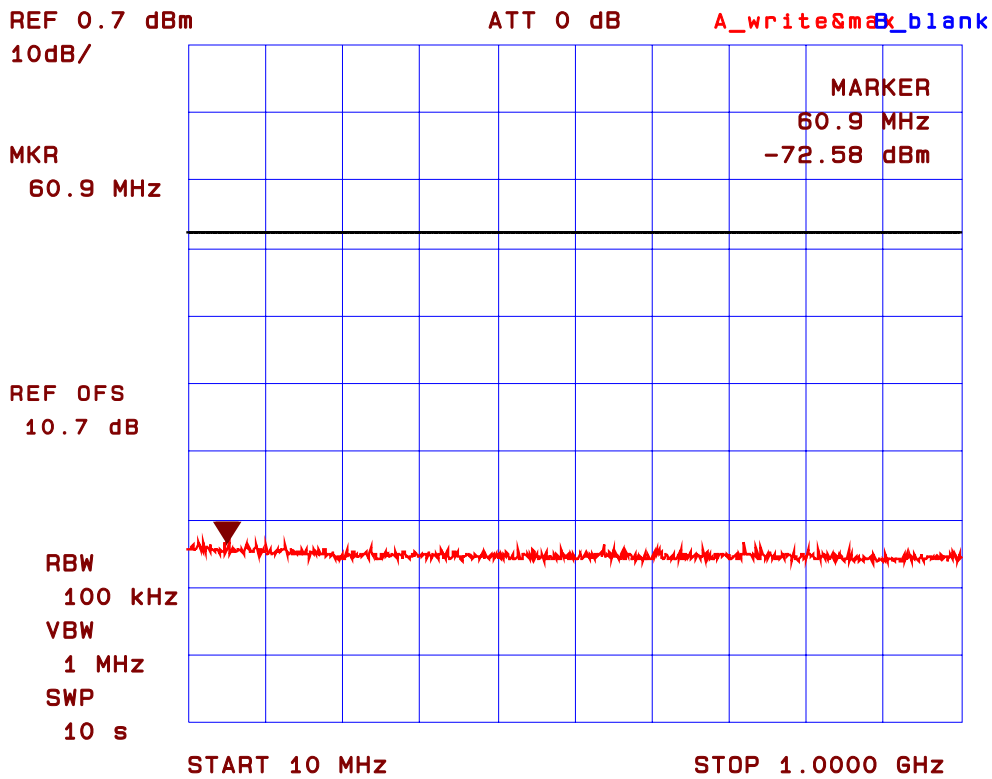

Plot #146: Conducted Emissions
Channel Freq.: 5785 MHz (CH157, Near Middle of 5.725-5.825 GHz Band)
Modulation: 64QAM at 54 Mbps Data Rate

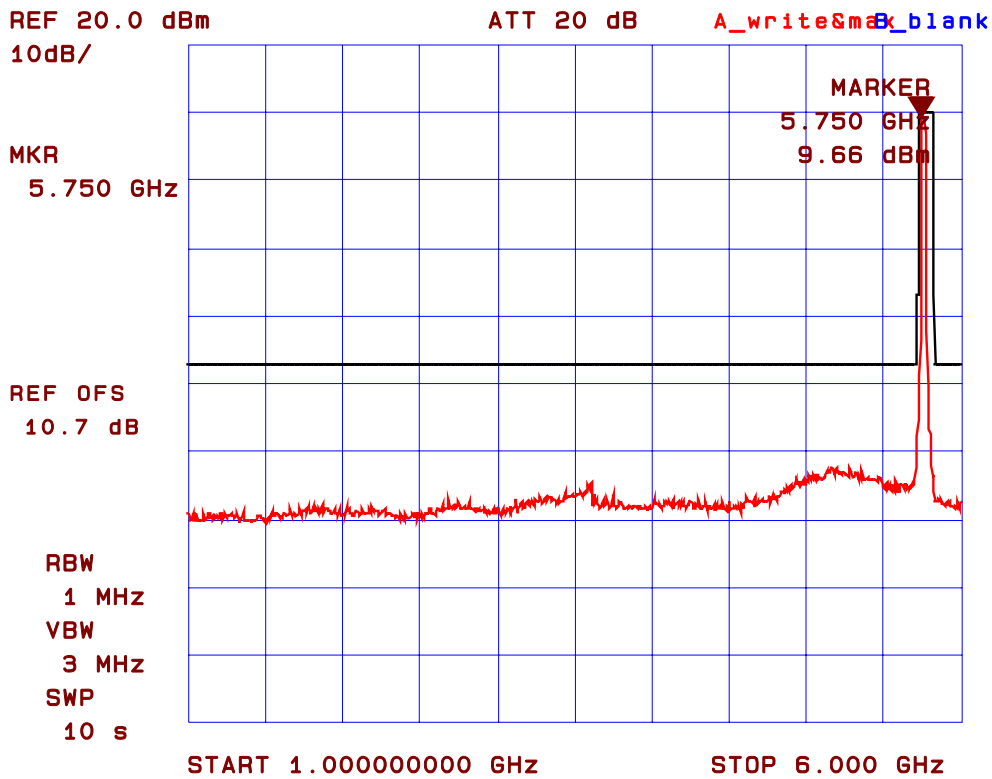

ULTRATECH GROUP OF LABS

3000 Bristol Circle, Oakville, Ontario, Canada L6H 6G4
Tel. #: 905-829-1570, Fax. #: 905-829-8050, Email: vic@ultratech-labs.com, Website: <http://www.ultratech-labs.com>

File #: CNI-027FCC15CE

June 10, 2005

All test results contained in this engineering test report are traceable to National Institute of Standards and Technology (NIST)

Plot #147: Conducted Emissions
Channel Freq.: 5785 MHz (CH157, Near Middle of 5.725-5.825 GHz Band)
Modulation: 64QAM at 54 Mbps Data Rate

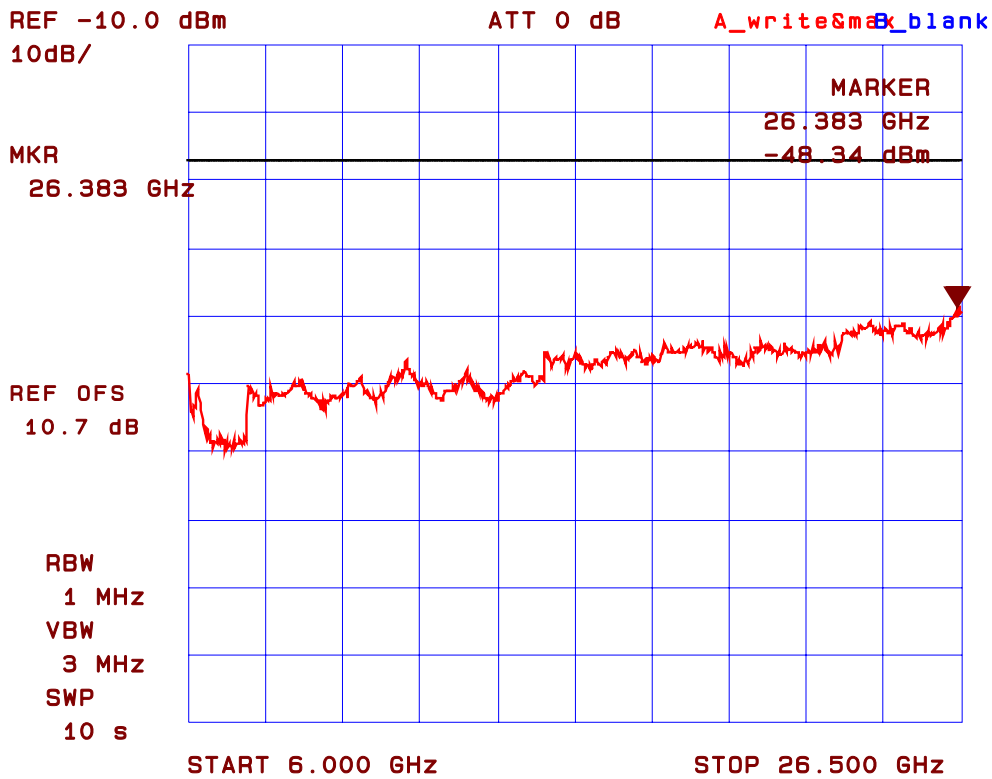

ULTRATECH GROUP OF LABS

3000 Bristol Circle, Oakville, Ontario, Canada L6H 6G4
Tel. #: 905-829-1570, Fax. #: 905-829-8050, Email: vic@ultratech-labs.com, Website: <http://www.ultratech-labs.com>

File #: CNI-027FCC15CE
June 10, 2005

All test results contained in this engineering test report are traceable to National Institute of Standards and Technology (NIST)

Plot #148: Conducted Emissions
Channel Freq.: 5785 MHz (CH157, Near Middle of 5.725-5.825 GHz Band)
Modulation: 64QAM at 54 Mbps Data Rate

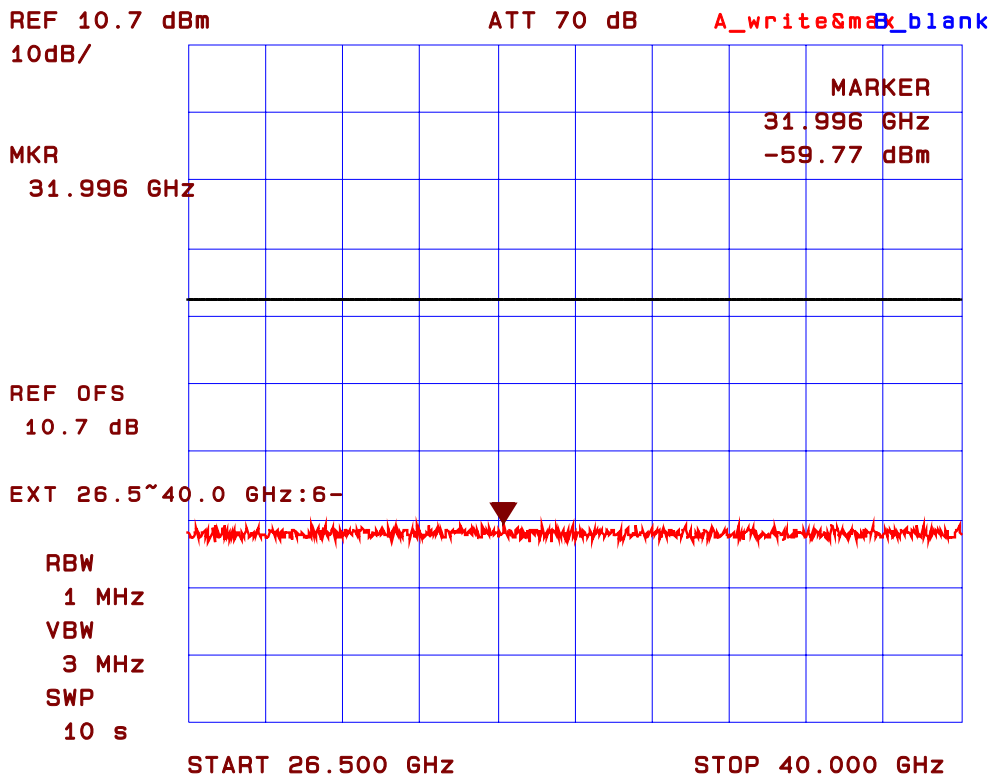

Plot #149: Conducted Emissions
Channel Freq.: 5805 MHz (CH161, Near Top of 5.725-5.825 GHz Band)
Modulation: 64QAM at 54 Mbps Data Rate

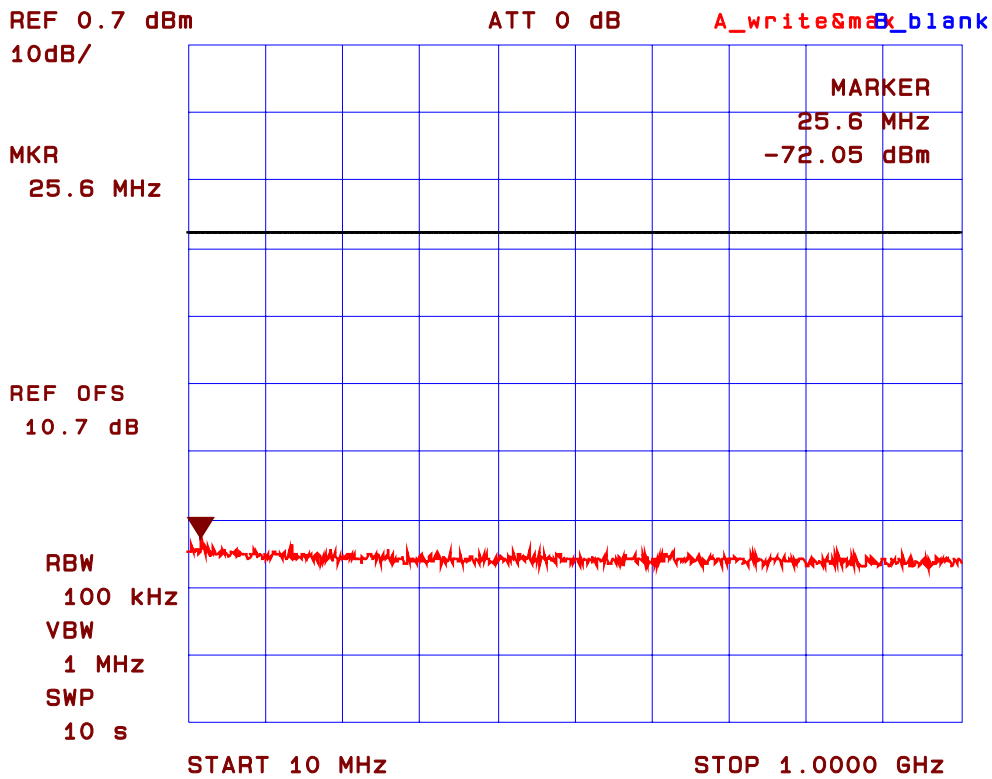

Plot #150: Conducted Emissions
Channel Freq.: 5805 MHz (CH161, Near Top of 5.725-5.825 GHz Band)
Modulation: 64QAM at 54 Mbps Data Rate

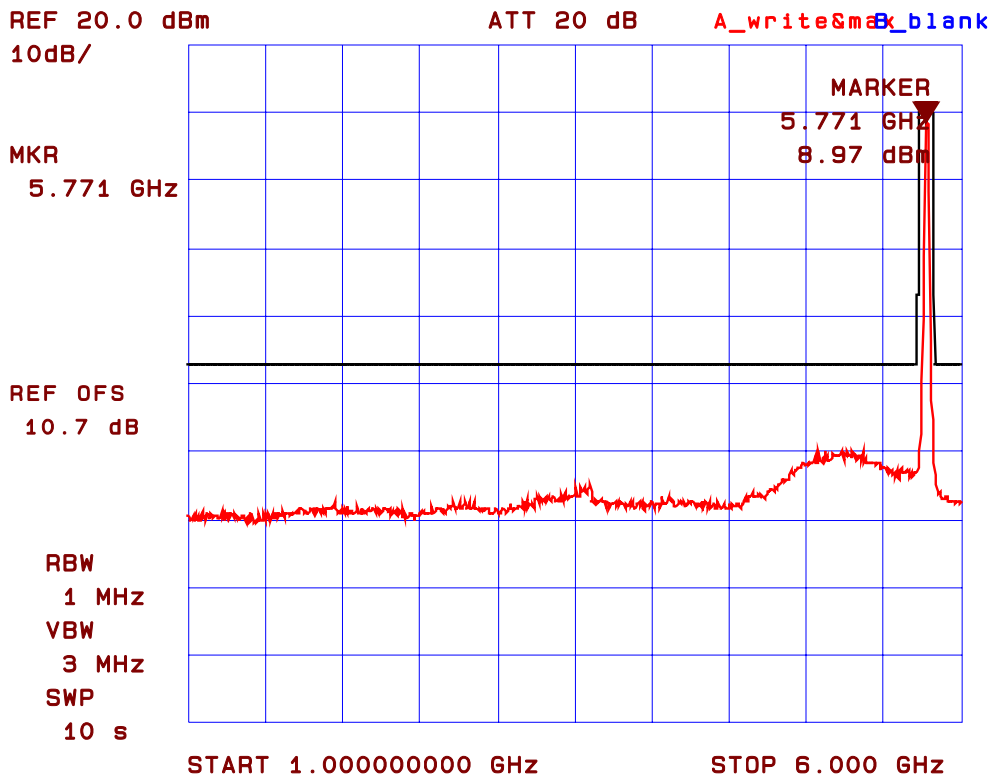

ULTRATECH GROUP OF LABS

3000 Bristol Circle, Oakville, Ontario, Canada L6H 6G4
Tel. #: 905-829-1570, Fax. #: 905-829-8050, Email: vic@ultratech-labs.com, Website: <http://www.ultratech-labs.com>

File #: CNI-027FCC15CE

June 10, 2005

All test results contained in this engineering test report are traceable to National Institute of Standards and Technology (NIST)

Plot #151: Conducted Emissions
Channel Freq.: 5805 MHz (CH161, Near Top of 5.725-5.825 GHz Band)
Modulation: 64QAM at 54 Mbps Data Rate

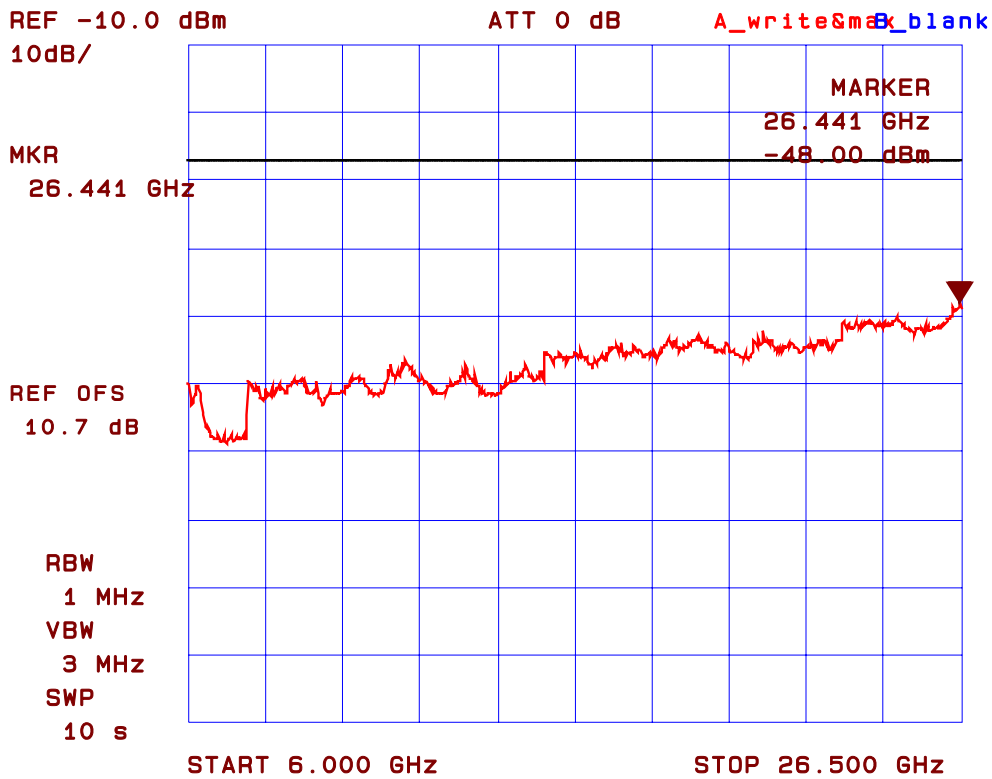

ULTRATECH GROUP OF LABS

3000 Bristol Circle, Oakville, Ontario, Canada L6H 6G4
Tel. #: 905-829-1570, Fax. #: 905-829-8050, Email: vic@ultratech-labs.com, Website: <http://www.ultratech-labs.com>

File #: CNI-027FCC15CE

June 10, 2005

All test results contained in this engineering test report are traceable to National Institute of Standards and Technology (NIST)

Plot #152: Conducted Emissions
Channel Freq.: 5805 MHz (CH161, Near Top of 5.725-5.825 GHz Band)
Modulation: 64QAM at 54 Mbps Data Rate

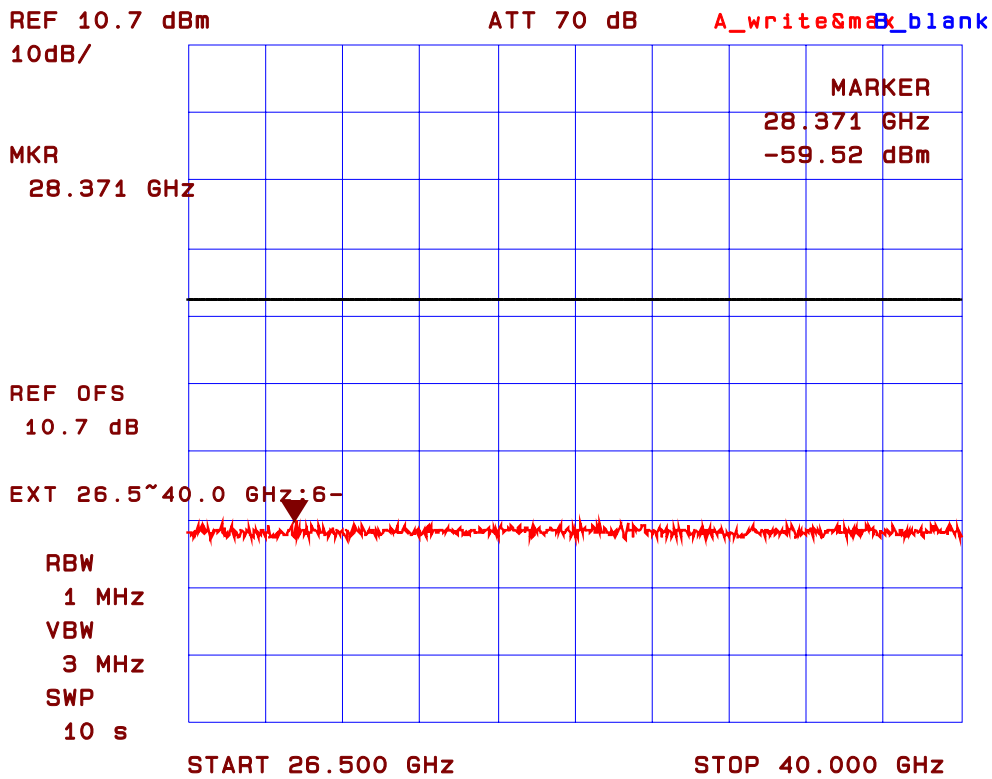

ULTRATECH GROUP OF LABS

3000 Bristol Circle, Oakville, Ontario, Canada L6H 6G4
Tel. #: 905-829-1570, Fax. #: 905-829-8050, Email: vic@ultratech-labs.com, Website: <http://www.ultratech-labs.com>

File #: CNI-027FCC15CE
June 10, 2005

All test results contained in this engineering test report are traceable to National Institute of Standards and Technology (NIST)

8.6. BAND-EDGE AND UNDESIRE EMISSIONS (RADIATED @ 3 METERS) [§ 15.407(b)]

8.6.1. Limits

Undesirable emission limits: the PEAK emissions outside of the frequency bands of operation shall be attenuated in accordance with the following limits:

- (1) For transmitters operating in the 5.15-5.25 GHz band: all emissions outside of the 5.15-5.25 GHz, 5.25-5.35 GHz and band shall not exceed an EIRP of -27 dBm/MHz.
- (2) For transmitters operating in the 5.25-5.35 GHz band: all emissions outside of the 5.15-5.25 GHz, 5.25-5.35 GHz and band shall not exceed an EIRP of -27 dBm/MHz. Devices operating in the 5.25-5.35 GHz band that generate emissions in the 5.15-5.25 GHz band must meet all applicable technical requirements for operation in the 5.15-5.25 GHz band (including indoor use) or alternatively meet an out-of-band emission EIRP limit of -27 dBm/MHz in the 5.15-5.25 GHz band.
- (3) For transmitters operating in the 5.47-5.725 GHz band: all emissions outside of the 5.47-5.725 GHz band shall not exceed an EIRP of -27 dBm/MHz.
- (4) For transmitters operating in the 5.725-5.825 GHz band: all emissions within the frequency range from the band edge to 10 MHz above or below the band edge shall not exceed an EIRP of -17 dBm/MHz; for frequencies 10 MHz or greater above or below the band edge, emissions shall not exceed an EIRP of -27 dBm/MHz.
- (5) The emission measurements shall be performed using a minimum resolution bandwidth of 1 MHz. A lower resolution bandwidth may be employed near the band edge, when necessary, provided the measured energy is integrated to show the total power over 1 MHz.
- (6) Unwanted emissions below 1 GHz must comply with the general field strength limits set forth in Sec. 15.209.
- (7) The provisions of Sec. 15.205 apply to intentional radiators operating under this section. (7) When measuring the emission limits, the nominal carrier frequency shall be adjusted as close to the upper and lower frequency block edges as the design of the equipment permits.

Remarks:

FCC 47 CFR § 5.205(a) - Restricted Frequency Bands

MHz	MHz	MHz	GHz
0.090 - 0.110	162.0125 - 167.17	2310 - 2390	9.3 - 9.5
0.49 - 0.51	167.72 - 173.2	2483.5 - 2500	10.6 - 12.7
2.1735 - 2.1905	240 - 285	2655 - 2900	13.25 - 13.4
8.362 - 8.366	322 - 335.4	3260 - 3267	14.47 - 14.5
13.36 - 13.41	399.9 - 410	3332 - 3339	14.35 - 16.2
25.5 - 25.67	608 - 614	3345.8 - 3358	17.7 - 21.4
37.5 - 38.25	960 - 1240	3600 - 4400	22.01 - 23.12
73 - 75.4	1300 - 1427	4500 - 5250	23.6 - 24.0
108 - 121.94	1435 - 1626.5	5350 - 5460	31.2 - 31.8
123 - 138	1660 - 1710	7250 - 7750	36.43 - 36.5
149.9 - 150.05	1718.8 - 1722.2	8025 - 8500	Above 38.6
156.7 - 156.9	2200 - 2300	9000 - 9200	

FCC 47 CFR § 15.209(a)
-- Field Strength Limits within Restricted Frequency Bands --

FREQUENCY (MHz)	FIELD STRENGTH LIMITS (microvolts/m)	DISTANCE (Meters)
0.009 - 0.490	2,400 / F (KHz)	300
0.490 - 1.705	24,000 / F (KHz)	30
1.705 - 30.0	30	30
30 – 88	100	3
88 – 216	150	3
216 – 960	200	3
Above 960	500	3

8.6.2. Method of Measurements

Refer to Exhibit 10, Section 10.4 of this test report and ANSI 63.4 for detailed radiated emissions measurement procedures.

The following measurement procedures were also applied:

- Applies to harmonics/spurious that fall in the restricted bands listed in Section 15.205. the maximum permitted average field strength is listed in Section 15.209. A Pre-Amp and highpass filter are used for this measurement.
- For measurement below 1 GHz, set RBW = 100 KHz, VBW ≥ 100 KHz, SWEEP=AUTO.
- For measurement above 1 GHz, set RBW = 1 MHz, VBW = 1 MHz (Peak), SWEEP=AUTO.

8.6.3. Test Arrangement

Please refer to Test Arrangement in Section 3.6 for details of test setup for emission measurements.

8.6.4. Test Equipment List

Test Instruments	Manufacturer	Model No.	Serial No.	Frequency Range
Spectrum Analyzer	Rohde & Schwarz	FSEK20/B4/B21	834157/005	9 kHz – 40 GHz
Microwave Amplifier	Hewlett Packard	HP 83017A		1 GHz to 26.5 GHz
Biconilog Antenna	EMCO	3143	1029	20 MHz to 2 GHz
Horn Antenna	EMCO	3155	9701-5061	1 GHz – 18 GHz
Horn Antenna	EMCO	3160-09	..	18 GHz – 26.5 GHz
Horn Antenna	EMCO	3160-10	..	26.5 GHz – 40 GHz
Mixer	Tektronix	118-0098-00	..	18 GHz – 26.5 GHz
Mixer	Tektronix	119-0098-00	..	26.5 GHz – 40 GHz

8.6.5. Test Data

Theory of Conversion From EIRP Limits to E-Field Limits:

FCC specifies the limit of an EIRP of -17 dBm/MHz; for frequencies 10 MHz or greater above or below the band edge, and an EIRP of -27 dBm/MHz. For other emissions outside 5.725 GHz - 10 MHz and 5.825 GHz + 10 MHz. In addition, the FCC E-Field Limits @ 15.209 in dBuV/m are applied for spurious and harmonic emissions which fall in the restricted band specified in FCC 15.205. In order to uniform our measurements, all EIRP limits (dBm/MHz) converted into E-Field Limits [dB(uV/m)/MHz] as follows:

$$P = (Ed)^2/30G$$
$$EIRP = PG = (Ed)^2/30$$
$$E = (30 * EIRP)^{0.5}/d$$

Where:

- P: Conducted power at the antenna in Watts
- G: Transmitter's isotropic gain in numeric
- EIRP: Equivalent isotropic radiated power in Watts
- E: Electric Field in uV/m
- D: Distance in meters (3 meters)

$$10^6 * E_{V/m} / 10^6 = [30 * EIRP_W * 10^3 / 10^3]^{0.5} / d$$
$$20 * \log[10^6 * E_{V/m} / 10^6] = 20 * \log\{[30 * EIRP_W * 10^3 / 10^3]^{0.5} / d\}$$
$$20 * \log[E_{uV/m}] - 20 * \log[10^6] = 10 * \log[EIRP_{mW}] + 10 * \log[30] + 10 * \log[10^{-3}] - 20 * \log(d)$$
$$E_{dBuV/m} = EIRP_{dBm} + 14.77 - 30 - 9.54 + 120$$

$$E_{dBuV/m} = EIRP_{dBm} + 95.25 \text{ dB}$$

The FCC Equivalent E-Field Limits are:

- 17 dB/MHz \leftrightarrow 78.24 dB(uV/m)/MHz
- 27 dBm/MHz \leftrightarrow 68.24 dB(uV/m)/MHz

8.6.5.1. Band-Edge Emissions (Radiated)

8.6.5.1.1. External Antenna

8.6.5.1.1.1. For 5.15-5.35 GHz Band

Conform. See the following plots (153-156) for detailed measurements:

Plot #153: Lower Band-Edge Radiated Emissions @ 3 Meters
Channel Freq.: 5180 MHz (CH36), Modulation: 64QAM at 54 Mbps Data Rate
Antenna Polarization: Horizontal
Trace A : Peak Detector Max Hold
Trace B : Power Averaging 100 Sweeps

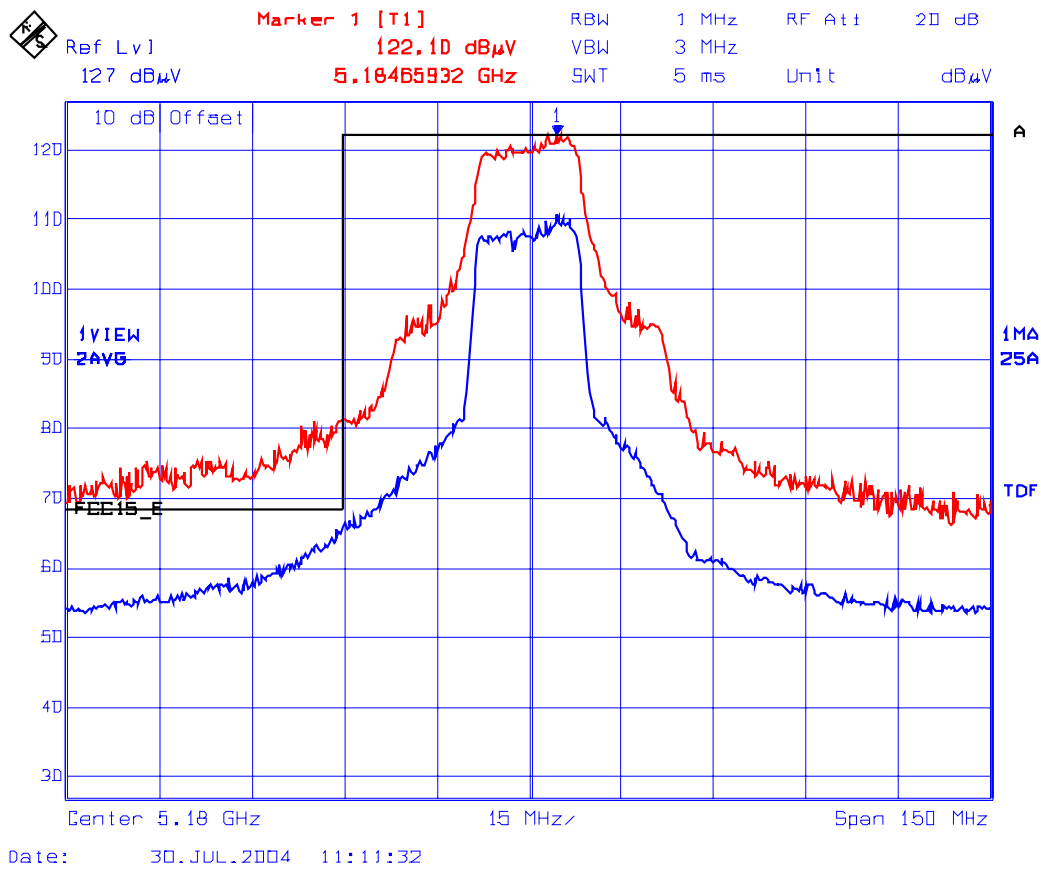

Plot #154: Lower Band-Edge Radiated Emissions @ 3 Meters
Channel Freq.: 5180 MHz (CH36), Modulation: 64QAM at 54 Mbps Data Rate
Antenna Polarization: Vertical
Trace A : Peak Detector Max Hold
Trace B : Power Averaging 100 Sweeps

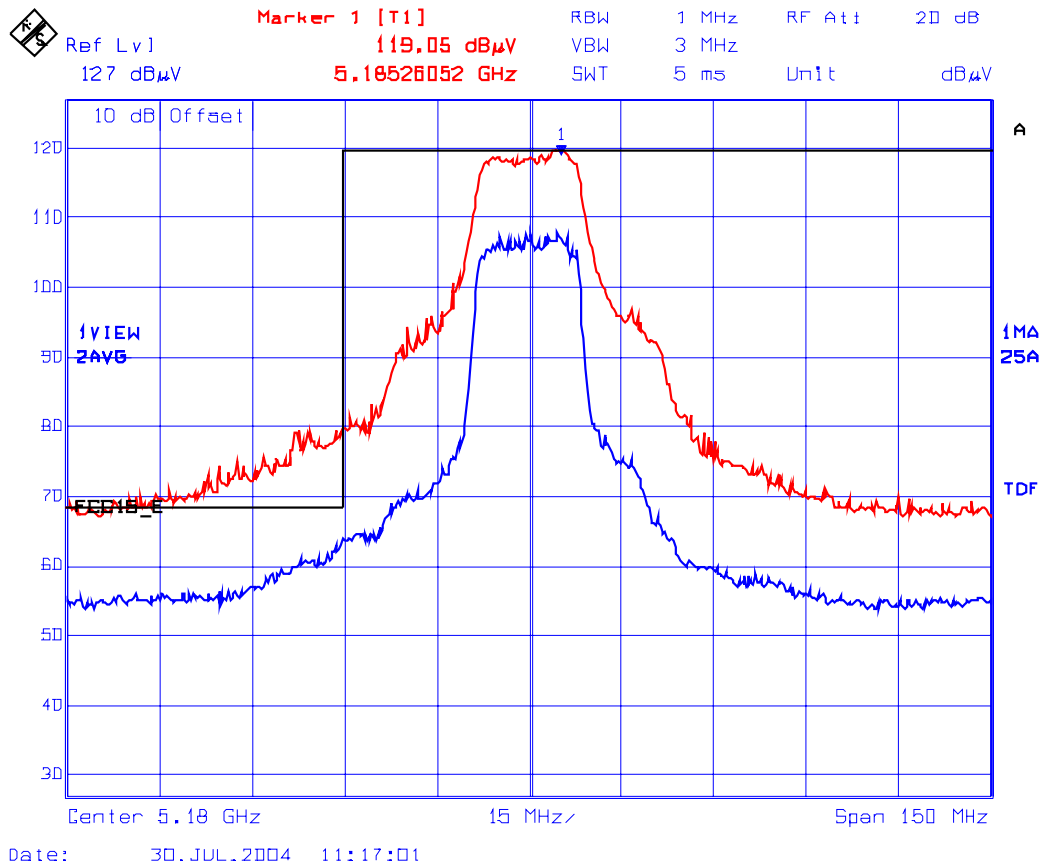

Plot #155: Upper Band-Edge Radiated Emissions @ 3 Meters
Channel Freq.: 5320 MHz (CH64), Modulation: 64QAM at 54 Mbps Data Rate
Antenna Polarization: Horizontal
Trace A ___: Peak Detector Max Hold
Trace B ___: Power Averaging 100 Sweeps

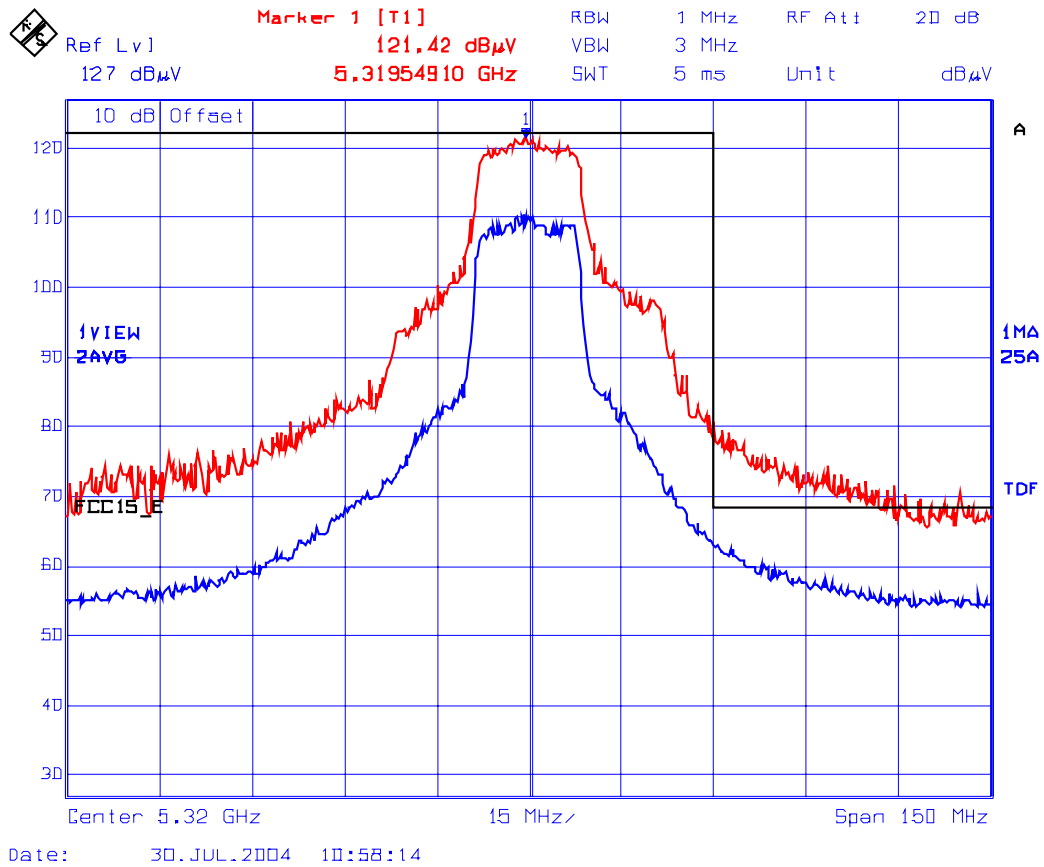

ULTRATECH GROUP OF LABS

3000 Bristol Circle, Oakville, Ontario, Canada L6H 6G4
Tel. #: 905-829-1570, Fax. #: 905-829-8050, Email: vic@ultratech-labs.com, Website: <http://www.ultratech-labs.com>

File #: CNI-027FCC15CE

June 10, 2005

All test results contained in this engineering test report are traceable to National Institute of Standards and Technology (NIST)

Plot #156: Upper Band-Edge Radiated Emissions @ 3 Meters
Channel Freq.: 5320 MHz (CH64), Modulation: 64QAM at 54 Mbps Data Rate
Antenna Polarization: Vertical
Trace A ___: Peak Detector Max Hold
Trace B ___: Power Averaging 100 Sweeps

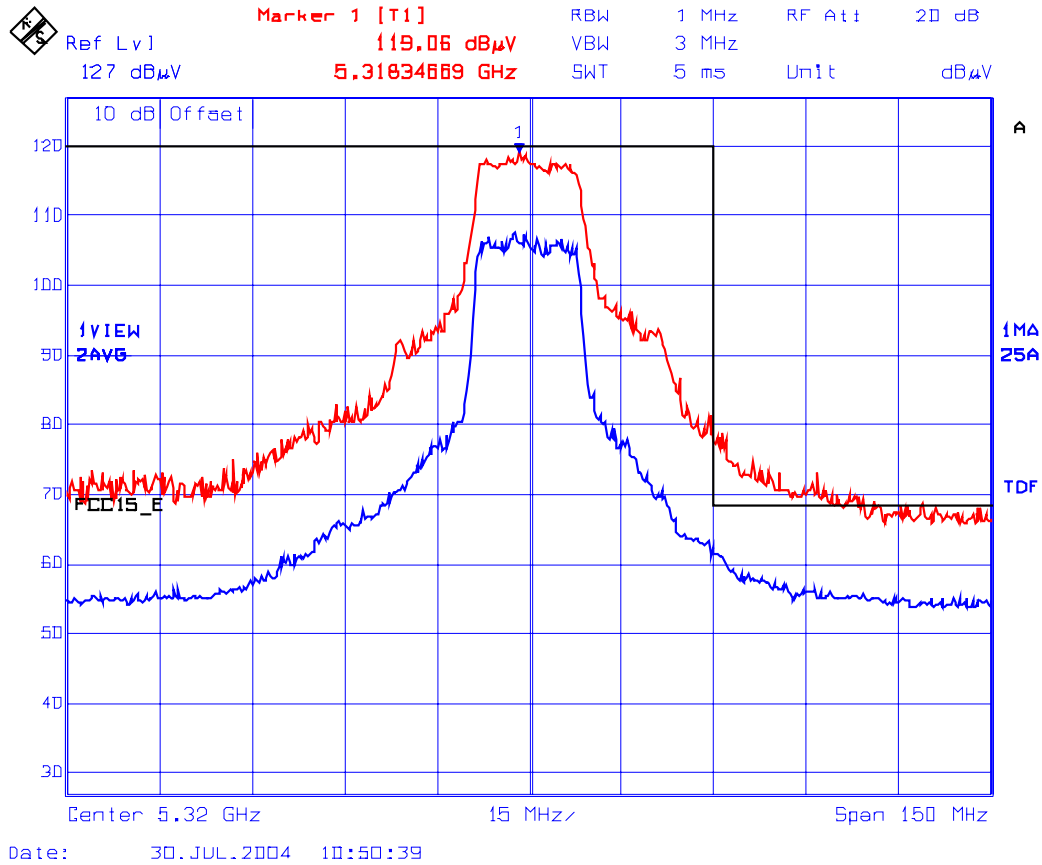

8.6.5.1.1.2. For 5.725-5.825 GHz Band

Conform. See the following plots (157-160) for detailed measurements:

Plot #157: Lower Band-Edge Radiated Emissions @ 3 Meters
Channel Freq.: 5745 MHz (CH149), Modulation: 64QAM at 54 Mbps Data Rate
Antenna Polarization: Horizontal
Trace A ___: Peak Detector Max Hold
Trace B ___: Power Averaging 100 Sweeps

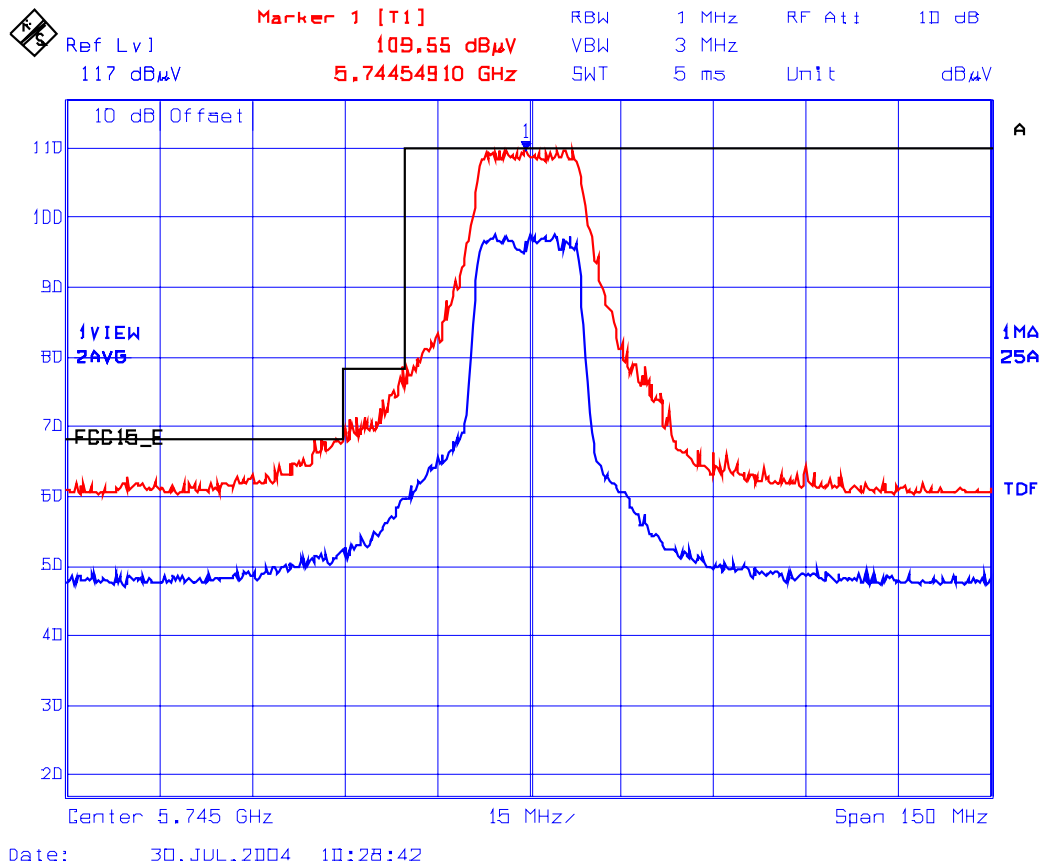

Plot #159: Upper Band-Edge Radiated Emissions @ 3 Meters
Channel Freq.: 5805 MHz (CH161), Modulation: 64QAM at 54 Mbps Data Rate
Antenna Polarization: Horizontal
Trace A : Peak Detector Max Hold
Trace B : Power Averaging 100 Sweeps

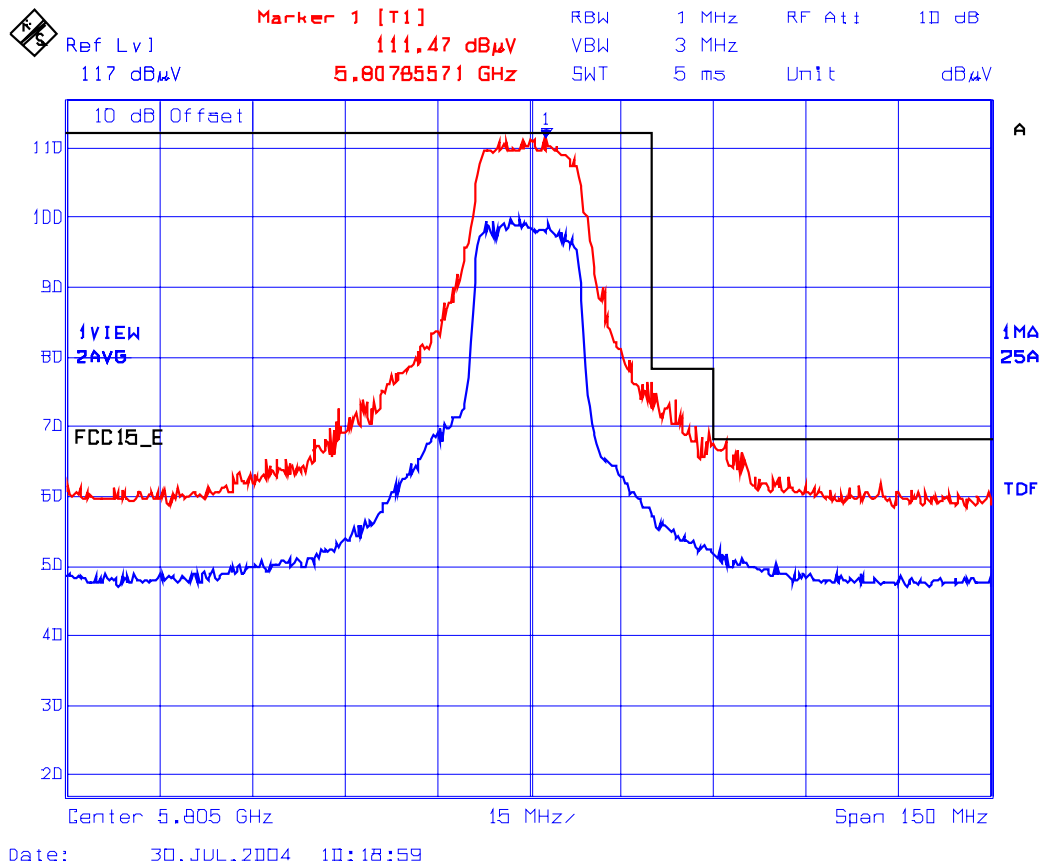

Plot #160: Upper Band-Edge Radiated Emissions @ 3 Meters
Channel Freq.: 5805 MHz (CH161), Modulation: 64QAM at 54 Mbps Data Rate
Antenna Polarization: Vertical
Trace A ___: Peak Detector Max Hold
Trace B ___: Power Averaging 100 Sweeps

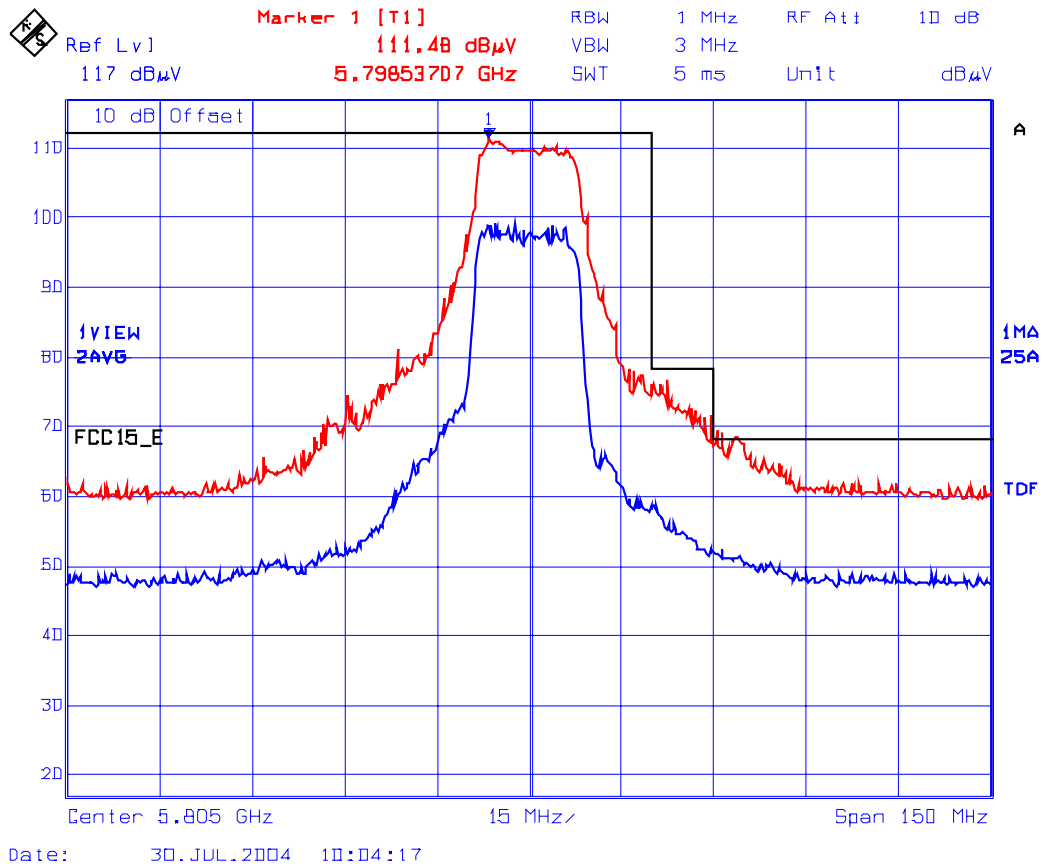

ULTRATECH GROUP OF LABS

3000 Bristol Circle, Oakville, Ontario, Canada L6H 6G4
Tel. #: 905-829-1570, Fax. #: 905-829-8050, Email: vic@ultratech-labs.com, Website: <http://www.ultratech-labs.com>

File #: CNI-027FCC15CE
June 10, 2005

All test results contained in this engineering test report are traceable to National Institute of Standards and Technology (NIST)

8.6.5.1.2. Internal Antenna

8.6.5.1.2.1. For 5.15-5.35 GHz

Conform. See the following plots (161-164) for detailed measurements.

Plot #161: Lower Band-Edge Radiated Emissions @ 3 Meters
Channel Freq.: 5180 MHz (CH36), Modulation: 64QAM at 54 Mbps Data Rate
Antenna Polarization: Horizontal
Trace A ___: Peak Detector Max Hold
Trace B ___: Power Averaging 100 Sweeps

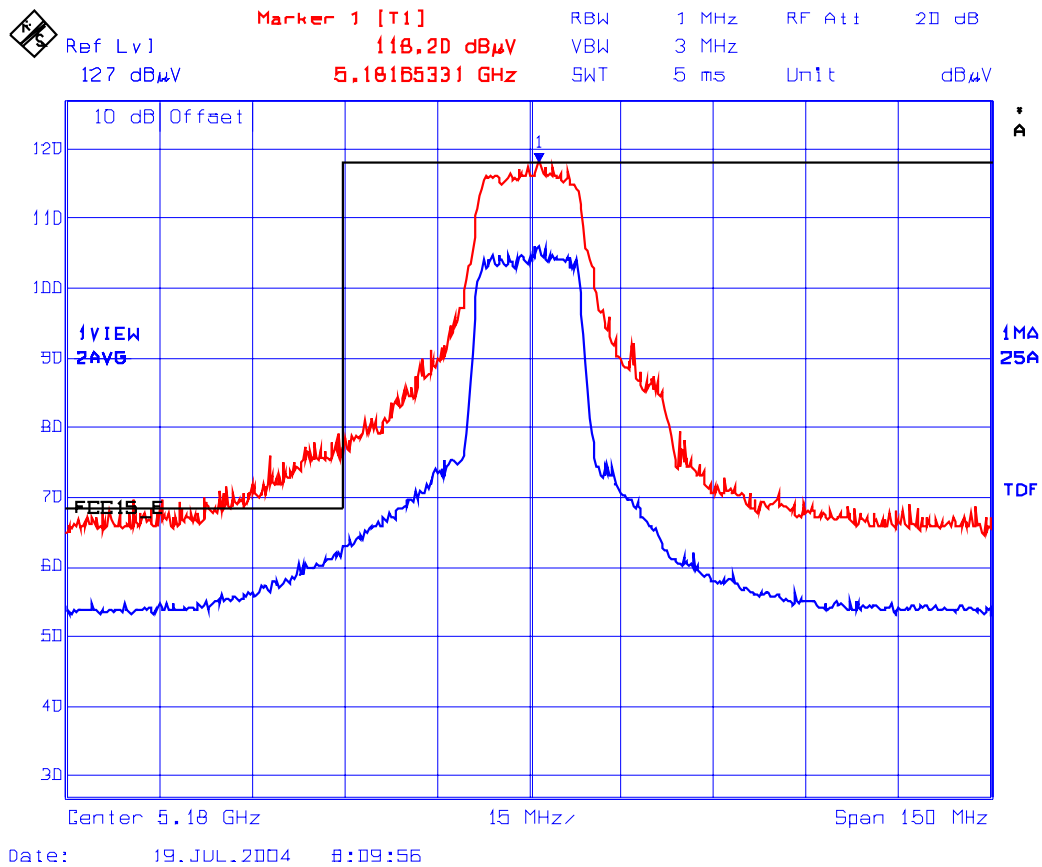

Plot #162: Lower Band-Edge Radiated Emissions @ 3 Meters
Channel Freq.: 5180 MHz (CH36), Modulation: 64QAM at 54 Mbps Data Rate
Antenna Polarization: Vertical
Trace A : Peak Detector Max Hold
Trace B : Power Averaging 100 Sweeps

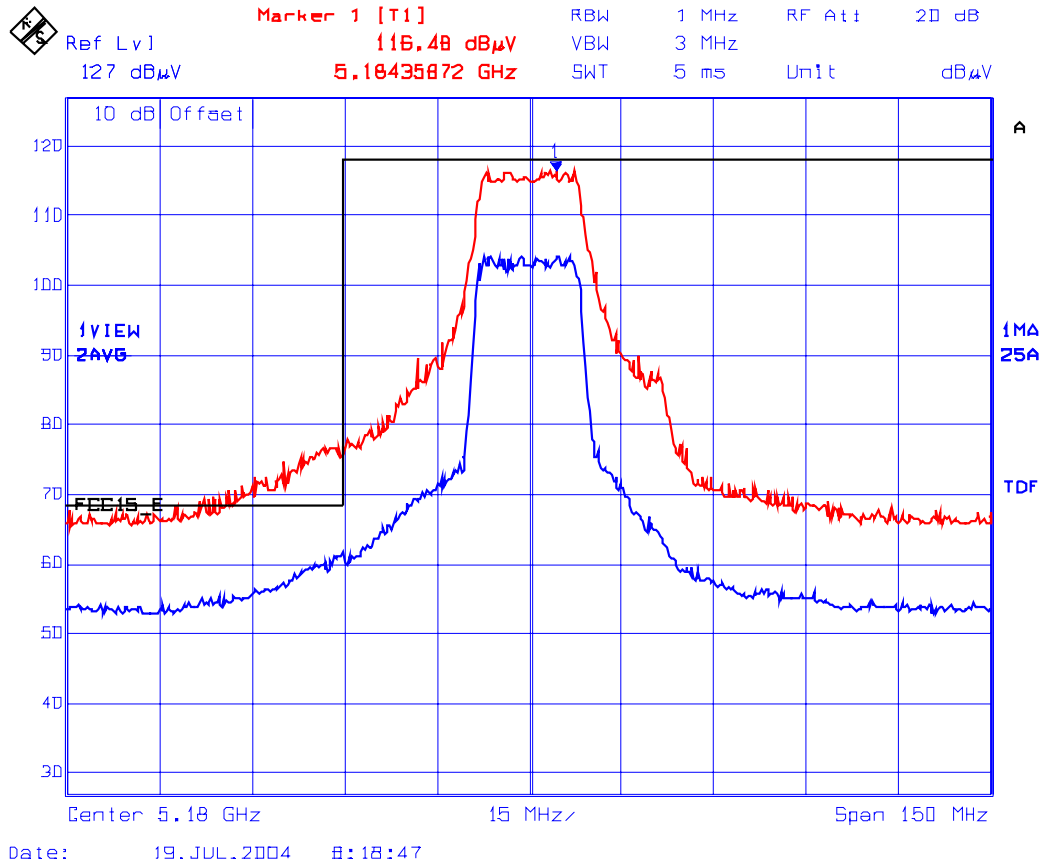

Plot #163: Upper Band-Edge Radiated Emissions @ 3 Meters
Channel Freq.: 5320 MHz (CH64), Modulation: 64QAM at 54 Mbps Data Rate
Antenna Polarization: Horizontal
Trace A : Peak Detector Max Hold
Trace B : Power Averaging 100 Sweeps

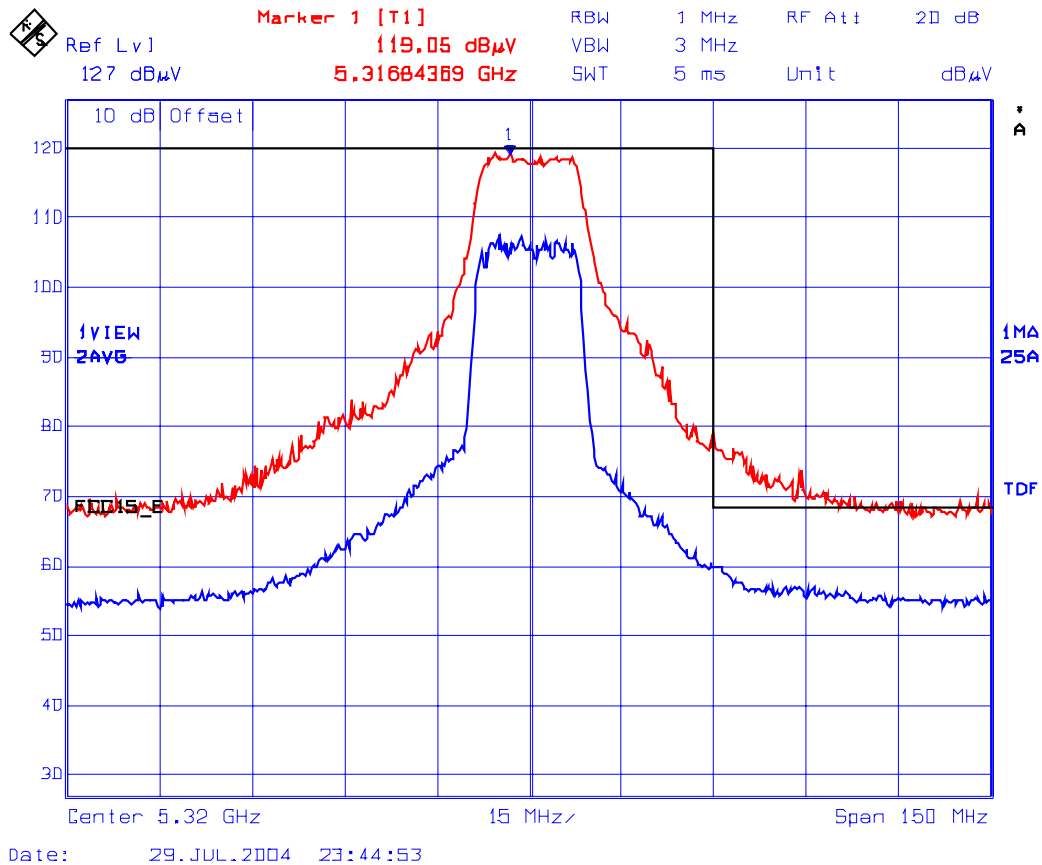

Plot #164: Upper Band-Edge Radiated Emissions @ 3 Meters
Channel Freq.: 5320 MHz (CH64), Modulation: 64QAM at 54 Mbps Data Rate
Antenna Polarization: Vertical
Trace A : Peak Detector Max Hold
Trace B : Power Averaging 100 Sweeps

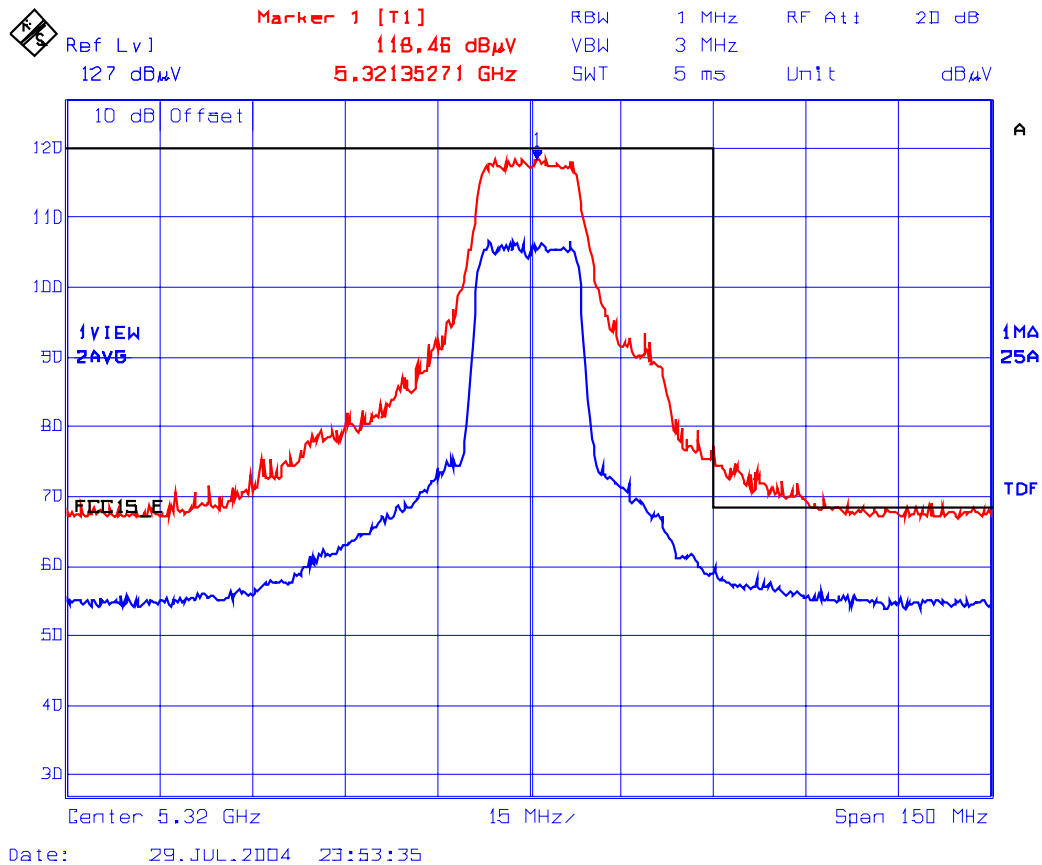

8.6.5.1.2.2. For 5.725-5.825 GHz Band

Conform. See the following plots (165-168) for detailed measurements.

Plot #165: Lower Band-Edge Radiated Emissions @ 3 Meters
Channel Freq.: 5745 MHz (CH149), Modulation: 64QAM at 54 Mbps Data Rate
Antenna Polarization: Horizontal
Trace A ___: Peak Detector Max Hold
Trace B ___: Power Averaging 100 Sweeps

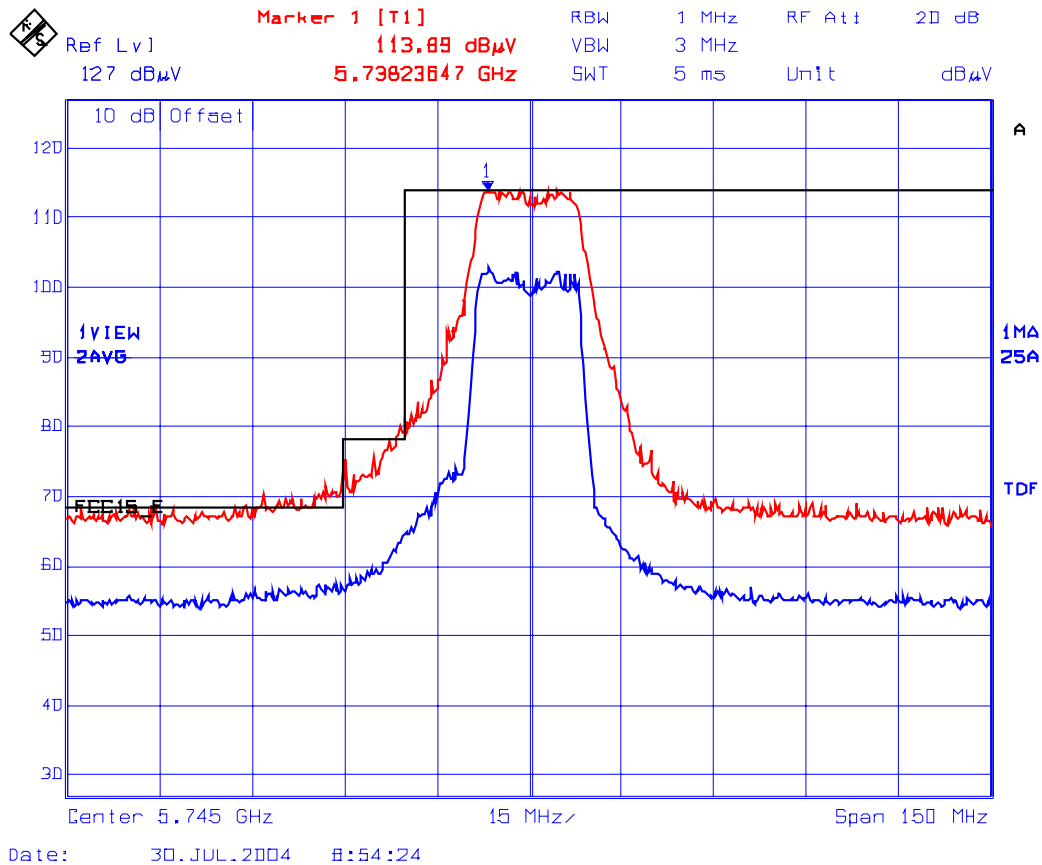

Plot #166: Lower Band-Edge Radiated Emissions @ 3 Meters
Channel Freq.: 5745 MHz (CH149), Modulation: 64QAM at 54 Mbps Data Rate
Antenna Polarization: Vertical
Trace A : Peak Detector Max Hold
Trace B : Power Averaging 100 Sweeps

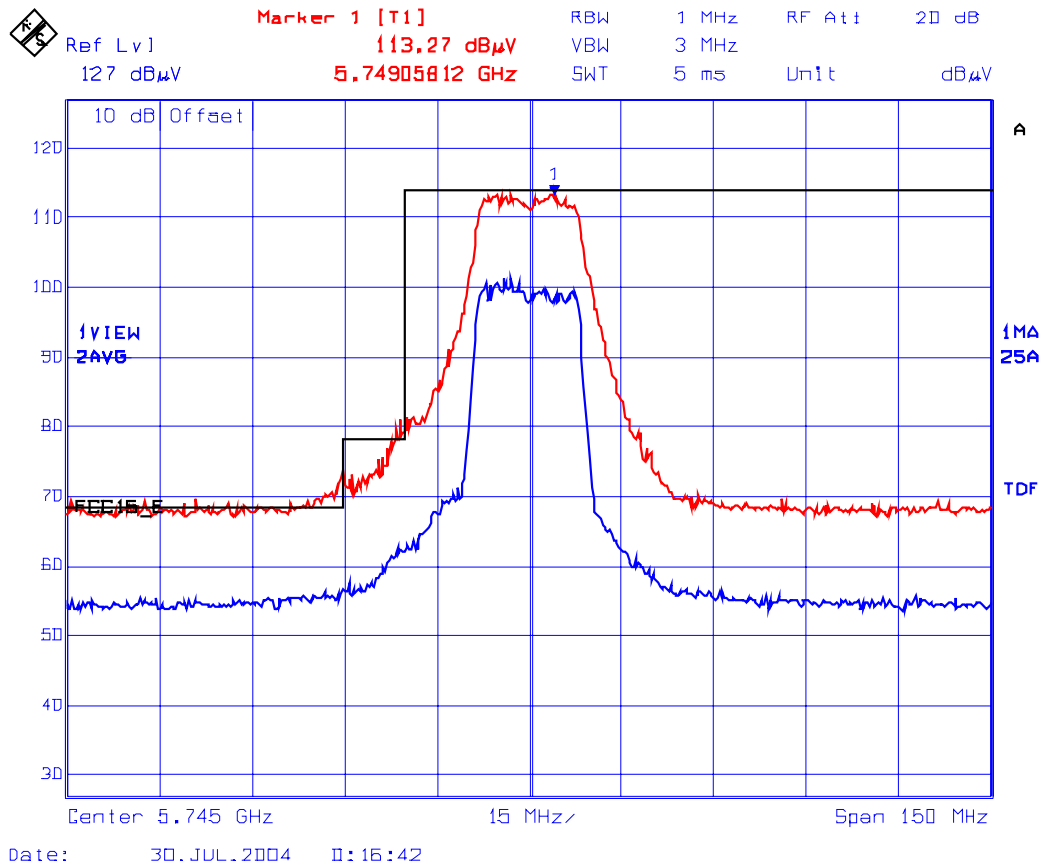

ULTRATECH GROUP OF LABS

3000 Bristol Circle, Oakville, Ontario, Canada L6H 6G4
Tel. #: 905-829-1570, Fax. #: 905-829-8050, Email: vic@ultratech-labs.com, Website: <http://www.ultratech-labs.com>

File #: CNI-027FCC15CE
June 10, 2005

All test results contained in this engineering test report are traceable to National Institute of Standards and Technology (NIST)

Plot #167: Upper Band-Edge Radiated Emissions @ 3 Meters
Channel Freq.: 5805 MHz (CH161), Modulation: 64QAM at 54 Mbps Data Rate
Antenna Polarization: Horizontal
Trace A ___: Peak Detector Max Hold
Trace B ___: Power Averaging 100 Sweeps

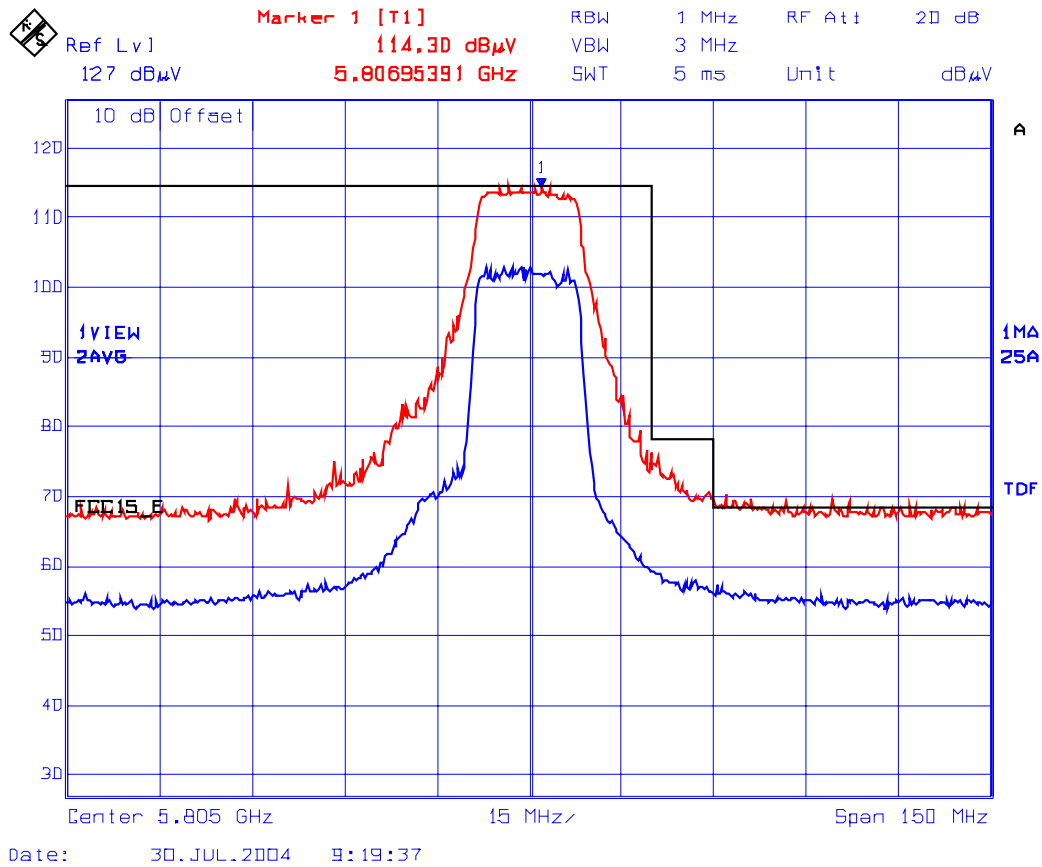

ULTRATECH GROUP OF LABS

3000 Bristol Circle, Oakville, Ontario, Canada L6H 6G4
Tel. #: 905-829-1570, Fax. #: 905-829-8050, Email: vic@ultratech-labs.com, Website: <http://www.ultratech-labs.com>

File #: CNI-027FCC15CE
June 10, 2005

All test results contained in this engineering test report are traceable to National Institute of Standards and Technology (NIST)

Plot #168: Upper Band-Edge Radiated Emissions @ 3 Meters
Channel Freq.: 5805 MHz (CH161), Modulation: 64QAM at 54 Mbps Data Rate
Antenna Polarization: Vertical
Trace A : Peak Detector Max Hold
Trace B : Power Averaging 100 Sweeps

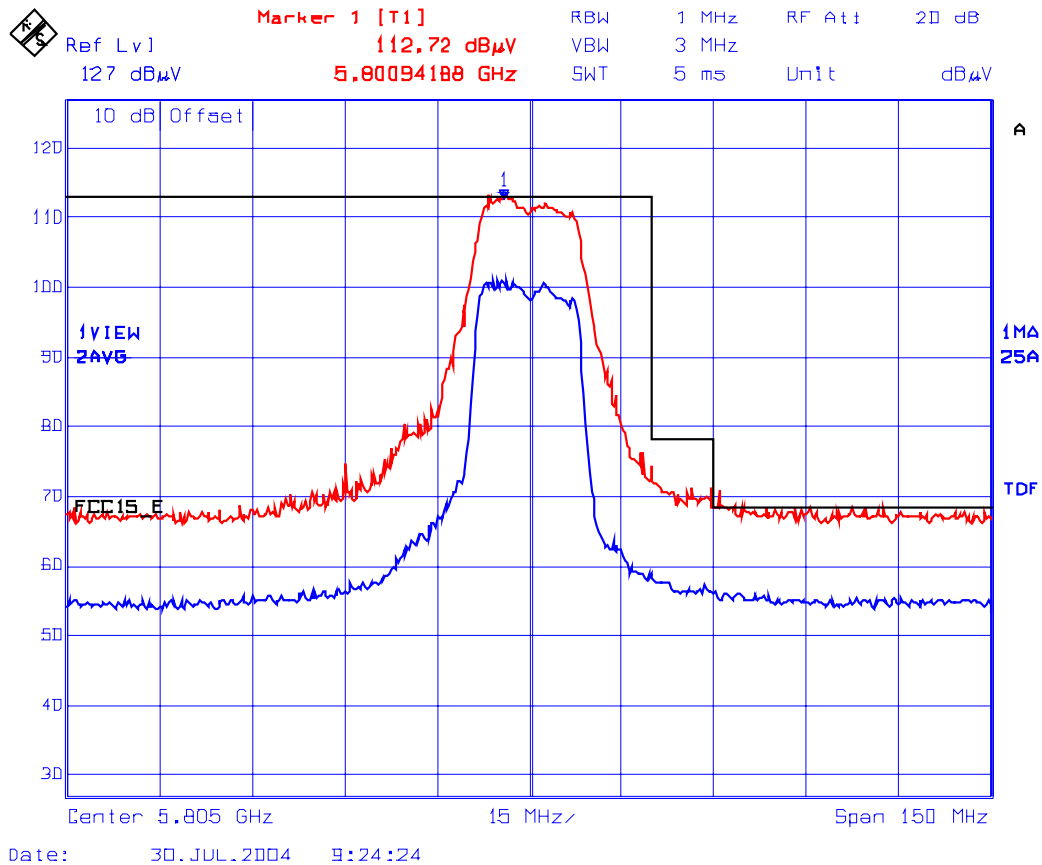

8.6.5.2. Undesired Emissions

Remarks:

- 1) Radiated emissions pre-scans show no differences in RF interferences with different modulations. Therefore, the transmitter operates with 64QAM modulation at highest data rate of 54 Mbps were tested to represent the worst case of radiated emissions, since it output the highest power.
- 2) The emissions were scanned from 10 MHz to 40 GHz and all emissions less 20 dB below the limits were recorded.

8.6.5.2.1. External Antenna

8.6.5.2.1.1. For 5.15-5.35 GHz Band

▪ **Lower Frequency (5180 MHz)**

Frequency (MHz)	RF Peak Level (dBµV/m)	RF AVG Level (dBµV/m)	Antenna Plane (H/V)	Limit 15.209 (dBµV/m)	Limit 15.407 (dBµV/m)	Margin (dB)	Pass/Fail
10360.0	60.84	48.39	V	54.0	68.2	-19.8	Pass
15540.0	60.81	46.42	V	54.0	68.2	-7.6	Pass*
15540.0	56.83	41.97	H	54.0	68.2	-12.0	Pass*

*Frequency in restricted frequency band.

▪ **Middle Frequency (5260 MHz)**

Frequency (MHz)	RF Peak Level (dBµV/m)	RF AVG Level (dBµV/m)	Antenna Plane (H/V)	Limit 15.209 (dBµV/m)	Limit 15.407 (dBµV/m)	Margin (dB)	Pass/Fail
10520.0	64.93	52.27	V	54.0	68.2	-15.9	Pass
10.520.0	64.09	51.01	H	54.0	68.2	-17.1	Pass
15780.0	62.18	47.63	V	54.0	68.2	-6.3	Pass*
15780.0	57.49	43.29	H	54.0	68.2	-10.7	Pass*

*Frequency in restricted frequency band.

▪ **Highest Frequency (5320 MHz)**

Frequency (MHz)	RF Peak Level (dBµV/m)	RF AVG Level (dBµV/m)	Antenna Plane (H/V)	Limit 15.209 (dBµV/m)	Limit 15.407 (dBµV/m)	Margin (dB)	Pass/Fail
10640	66.18	52.84	V	54.0	68.2	-1.2	Pass*
10640	61.65	48.44	H	54.0	68.2	-5.6	Pass*
15960	61.17	45.76	V	54.0	68.2	-8.2	Pass*
15960	59.10	44.63	H	54.0	68.2	-9.4	Pass*

*Frequency in restricted frequency band.

8.6.5.2.1.2. For 5.725-5.825 GHz Band

▪ **Lower Frequency (5745 MHz)**

Frequency (MHz)	RF Peak Level (dB μ V/m)	RF AVG Level (dB μ V/m)	Antenna Plane (H/V)	Limit 15.209 (dB μ V/m)	Limit 15.407 (dB μ V/m)	Margin (dB)	Pass/Fail
11490	60.99	46.23	V	54.0	68.2	-7.8	Pass*
11490	56.47	43.25	H	54.0	68.2	-10.8	Pass*

*Frequency in restricted frequency band.

▪ **Middle Frequency (5785 MHz)**

Frequency (MHz)	RF Peak Level (dB μ V/m)	RF AVG Level (dB μ V/m)	Antenna Plane (H/V)	Limit 15.209 (dB μ V/m)	Limit 15.407 (dB μ V/m)	Margin (dB)	Pass/Fail
11570	60.21	46.66	V	54.0	68.2	-7.3	Pass*
11570	56.13	43.78	H	54.0	68.2	-10.2	Pass*

*Frequency in restricted frequency band.

▪ **Highest Frequency (5805 MHz)**

Frequency (MHz)	RF Peak Level (dB μ V/m)	RF AVG Level (dB μ V/m)	Antenna Plane (H/V)	Limit 15.209 (dB μ V/m)	Limit 15.407 (dB μ V/m)	Margin (dB)	Pass/Fail
11610	60.42	46.89	V	54.0	68.2	-7.1	Pass*
11610	60.20	46.44	H	54.0	68.2	-7.6	Pass*
17415	62.78	49.71	V	54.0	68.2	-18.5	Pass

*Frequency in restricted frequency band.

8.6.5.2.2. Internal Antenna

8.6.5.2.2.1. For 5.15-5.35 GHz Band

▪ **Lower Frequency (5180 MHz)**

Frequency (MHz)	RF Peak Level (dB μ V/m)	RF AVG Level (dB μ V/m)	Antenna Plane (H/V)	Limit 15.209 (dB μ V/m)	Limit 15.407 (dB μ V/m)	Margin (dB)	Pass/Fail
10360.0	69.34	56.22	V	54.0	68.2	-11.9	Pass
10360.0	66.51	54.39	H	54.0	68.2	-13.8	Pass
15540.0	61.01	46.82	V	54.0	68.2	-7.2	Pass*
15540.0	60.70	44.86	H	54.0	68.2	-9.1	Pass*

*Frequency in restricted frequency band.

▪ **Middle Frequency (5260 MHz)**

Frequency (MHz)	RF Peak Level (dB μ V/m)	RF AVG Level (dB μ V/m)	Antenna Plane (H/V)	Limit 15.209 (dB μ V/m)	Limit 15.407 (dB μ V/m)	Margin (dB)	Pass/Fail
10520	65.89	53.17	V	54.0	68.2	-15.03	Pass
10520	68.12	55.55	H	54.0	68.2	-12.6	Pass
15780	61.58	48.02	V	54.0	68.2	-5.9	Pass*
15780	62.42	45.38	H	54.0	68.2	-8.6	Pass*

*Frequency in restricted frequency band.

▪ **Highest Frequency (5320 MHz)**

Frequency (MHz)	RF Peak Level (dB μ V/m)	RF AVG Level (dB μ V/m)	Antenna Plane (H/V)	Limit 15.209 (dB μ V/m)	Limit 15.407 (dB μ V/m)	Margin (dB)	Pass/Fail
10640	64.00	51.55	V	54.0	68.2	-2.5	Pass*
10640	58.67	42.87	H	54.0	68.2	-11.1	Pass*
15960	62.90	46.21	V	54.0	68.2	-7.8	Pass*
15960	61.80	45.63	H	54.0	68.2	-8.4	Pass*

*Frequency in restricted frequency band.

8.6.5.2.2.2. For 5.725-5.825 GHz Band

▪ **Lower Frequency (5745 MHz)**

Frequency (MHz)	RF Peak Level (dB μ V/m)	RF AVG Level (dB μ V/m)	Antenna Plane (H/V)	Limit 15.209 (dB μ V/m)	Limit 15.407 (dB μ V/m)	Margin (dB)	Pass/Fail
11490	54.95	40.63	V	54.0	68.2	-13.4	Pass*
11490	58.06	42.84	H	54.0	68.2	-11.2	Pass*

*Frequency in restricted frequency band.

▪ **Middle Frequency (5785 MHz)**

Frequency (MHz)	RF Peak Level (dB μ V/m)	RF AVG Level (dB μ V/m)	Antenna Plane (H/V)	Limit 15.209 (dB μ V/m)	Limit 15.407 (dB μ V/m)	Margin (dB)	Pass/Fail
11570	55.81	42.16	V	54.0	68.2	-11.8	Pass*
11570	56.23	42.02	H	54.0	68.2	-11.9	Pass*

*Frequency in restricted frequency band.

▪ **Highest Frequency (5805 MHz)**

Frequency (MHz)	RF Peak Level (dB μ V/m)	RF AVG Level (dB μ V/m)	Antenna Plane (H/V)	Limit 15.209 (dB μ V/m)	Limit 15.407 (dB μ V/m)	Margin (dB)	Pass/Fail
11610	56.13	42.37	V	54.0	68.2	-11.6	Pass*
11610	58.26	43.50	H	54.0	68.2	-10.5	Pass*

*Frequency in restricted frequency band.

EXHIBIT 9. MEASUREMENT UNCERTAINTY

The measurement uncertainties stated were calculated in accordance with the requirements of NIST Technical Note 1297 and NIS 81 (1994)

9.1. LINE CONDUCTED EMISSION MEASUREMENT UNCERTAINTY

CONTRIBUTION (Line Conducted)	PROBABILITY DISTRIBUTION	UNCERTAINTY (dB)	
		9-150 kHz	0.15-30 MHz
EMI Receiver specification	Rectangular	± 1.5	± 1.5
LISN coupling specification	Rectangular	± 1.5	± 1.5
Cable and Input Transient Limiter calibration	Normal (k=2)	± 0.3	± 0.5
Mismatch: Receiver VRC $\Gamma_1 = 0.03$ LISN VRC $\Gamma_R = 0.8(9 \text{ kHz}) 0.2 (30 \text{ MHz})$ Uncertainty limits $20\text{Log}(1+\Gamma_1\Gamma_R)$	U-Shaped	± 0.2	± 0.3
System repeatability	Std. deviation	± 0.2	± 0.05
Repeatability of EUT	--	--	--
Combined standard uncertainty	Normal	± 1.25	± 1.30
Expanded uncertainty U	Normal (k=2)	± 2.50	± 2.60

Sample Calculation for Measurement Accuracy in 150 kHz to 30 MHz Band:

$$u_c(y) = \sqrt{\sum_{i=1}^m u_i^2(y)} = \pm \sqrt{(1.5^2 + 1.5^2)/3 + (0.5/2)^2 + (0.05/2)^2 + 0.35^2} = \pm 1.30 \text{ dB}$$

$$U = 2u_c(y) = \pm 2.6 \text{ dB}$$

9.2. RADIATED EMISSION MEASUREMENT UNCERTAINTY

CONTRIBUTION (Radiated Emissions)	PROBABILITY DISTRIBUTION	UNCERTAINTY (+ dB)	
		3 m	10 m
Antenna Factor Calibration	Normal (k=2)	<u>+1.0</u>	<u>+1.0</u>
Cable Loss Calibration	Normal (k=2)	<u>+0.3</u>	<u>+0.5</u>
EMI Receiver specification	Rectangular	<u>+1.5</u>	<u>+1.5</u>
Antenna Directivity	Rectangular	<u>+0.5</u>	<u>+0.5</u>
Antenna factor variation with height	Rectangular	<u>+2.0</u>	<u>+0.5</u>
Antenna phase center variation	Rectangular	0.0	<u>+0.2</u>
Antenna factor frequency interpolation	Rectangular	<u>+0.25</u>	<u>+0.25</u>
Measurement distance variation	Rectangular	<u>+0.6</u>	<u>+0.4</u>
Site imperfections	Rectangular	<u>+2.0</u>	<u>+2.0</u>
Mismatch: Receiver VRC $\Gamma_1 = 0.2$ Antenna VRC $\Gamma_R = 0.67(Bi) 0.3 (Lp)$ Uncertainty limits $20\text{Log}(1+\Gamma_1\Gamma_R)$	U-Shaped	+1.1 -1.25	<u>+0.5</u>
System repeatability	Std. Deviation	<u>+0.5</u>	<u>+0.5</u>
Repeatability of EUT		-	-
Combined standard uncertainty	Normal	+2.19 / -2.21	+1.74 / -1.72
Expanded uncertainty U	Normal (k=2)	+4.38 / -4.42	+3.48 / -3.44

Calculation for maximum uncertainty when 3m biconical antenna including a factor of k = 2 is used:

$$U = 2u_c(y) = 2x(+2.19) = +4.38 \text{ dB} \quad \text{And} \quad U = 2u_c(y) = 2x(-2.21) = -4.42 \text{ dB}$$

EXHIBIT 10. MEASUREMENT METHODS

10.1. GENERAL TEST CONDITIONS

The following test conditions shall be applied throughout the tests covered in this report.

10.1.1. Normal temperature and humidity

- Normal temperature: +15°C to +35°C
- Relative Humidity: +20% to 75%

The actual values during tests shall be recorded in the test report.

10.1.2. Normal power source

10.1.2.1. Mains Voltage

The nominal test voltage of the equipment to be connected to mains shall be the nominal mains voltage which is the declared voltage or any of the declared voltages for which the equipment was designed.

The frequency of test power source corresponding to the AC mains shall be between 59 Hz and 61 Hz.

10.1.2.2. Battery Power Source

For operation from battery power sources, the nominal test voltage shall be as declared by the equipment manufacturer. This shall be recorded in the test report.

10.1.3. Operating Condition of Equipment under Test

- All tests were carried out while the equipment operated at the following frequencies:
 - The lowest operating frequency,
 - The middle operating frequency and
 - The highest operating frequency
- Modulation were applied using the Test Data sequence
- The transmitter was operated at the highest output power, or in the case the equipment able to operate at more than one power level, at the lowest and highest output powers

10.2. METHOD OF MEASUREMENTS - AC MAINS CONDUCTED EMISSIONS

- AC Mains conducted emissions measurements were performed in accordance with the standard against appropriate limits for each detector function.
- The test was performed in the shielded room, 16'(L) by 16'(W) by 12'(H).
- The test was performed over the frequency range from 150 kHz to 30 MHz to determine the line-to-ground radio noise voltage which was conducted from the EUT power-input terminals that were directly connected to a public power network.
- The EUT normally received power from another device that connects to the public utility ac power lines, measurements would be made on that device with the EUT in operation to ensure that the device continues to comply with the appropriate limits while providing the EUT with power.
- If the EUT operates only from internal or dedicated batteries, with no provisions for connection to the public utility ac power lines, AC Mains conducted measurements are not required.
- Table-top devices were placed on a platform of nominal size 1 m by 1.5m raised 80 cm above the conducting ground plane.
- The EUT current-carrying power lead, except the ground (safety) lead, was individually connected through a LISN to the power source. All unused 50-Ohm connectors of the LISN was terminated in 50-ohm when not connected to the measuring instruments.
- The line cord of the EUT connected to one LISN which was connected to the measuring instrument. Those power cords for the units of devices not under measurement were connected to a separate multiple ac outlet. Drawings and photographs of typically conducted emission test setups were shown in the Test Report. Each current-carrying conductor of the EUT shall be individually tested.
- The EUT was normally operated with a ground (safety) connection, the EUT was connected to the ground at the LISN through a conductor provided in the lead from the ac power mains to the LISN.
- The excess length of the power cord was folded back and forth in an 8-shape on a wooden strip with a vertical prong located on the top of the LISN case.
- The EUT was set-up in its typical configuration and operated in its various modes as described in 3.2 of the test report.
- A preliminary scan was made by using spectrum analyzer system with the detector function set to PEAK mode (9 KHz RBW, VBW > RBW), frequency span 150 kHz to 30 MHz.
- The maximum conducted emission for a given mode of operation was found by using the following step-by-step procedure:
 - Step 1. Monitor the frequency range of interest at a fixed EUT azimuth.
 - Step 2. Manipulate the system cables and peripheral devices to produce highest amplitude signal relative to the limit. Note the amplitude and frequency of the suspect signal.
 - Step 3. The effects of various modes of operation is examined. This is done by varying equipment operation modes as step 2 is being performed.
 - Step 4. After completing step 1 through 3, record EUT and peripheral device configuration, mode of operation, cable configuration, signal levels and frequencies for final test.
- Each highest signal level at the maximized test configuration was zoomed in a small frequency span on the spectrum analyzer's display (the manipulation of cables and peripheral devices and EUT operation modes might have to be repeated to obtain the highest signal level with the spectrum analyzer set to PEAK detector mode 10 KHz RBW and VBW > RBW). The spectrum analyzer was then set to CISPR QUASI-PEAK detector mode (9 KHz RBW, 1 MHz VBW) and AVERAGE detector mode (10 kHz RBW, 1 Hz VBW). The final highest RF signal levels and frequencies were record.

- **Broad-band ac Powerline conducted emissions:**- If the EUT exhibits ac Powerline conducted emissions that exceed the limit with the instrument set to the quasi-peak mode, then measurements should be made in the average mode. If the amplitude measured in the quasi-peak mode is at least 6 dB higher than the amplitude measured in the average mode, the level measured in quasi peak mode may be reduced by 13 dB before comparing it to the limit.

10.3. PEAK CONDUCTED POWER & PEAK EIRP

10.3.1. Measurements of Transmitter Parameters (Duty Cycle & Peak Power)

- The following shall be applied to the combination(s) of the radio device and its intended antenna(e).
- If the RF level is user adjustable, all measurements shall be made with the highest power level available to the user for that combination.
- The following method of measurement shall apply to both conducted and radiated measurements.
- The radiated measurements are performed at the Ultratech Calibrated Open Field Test Site.
- The measurement shall be performed using normal operation of the equipment with modulation.

Test procedure shall be as follows:

Step 1: Duty Cycle (x) and Peak Power (y) parameters measurements

- Connect the transmitter output to a diode detector through an attenuator
- Connect the diode detector to the vertical channel of an oscilloscope.
- The observed duty cycle of the transmitter, $x = \text{Tx on} / (\text{Tx on} + \text{Tx off})$ with $0 < x < 1$, is measure and recorded in the test report. For the purpose of testing, the equipment shall be operated with a duty cycle that is equal or more than 0.1.
- Observe and record the y parameter of the DC level on the oscilloscope.

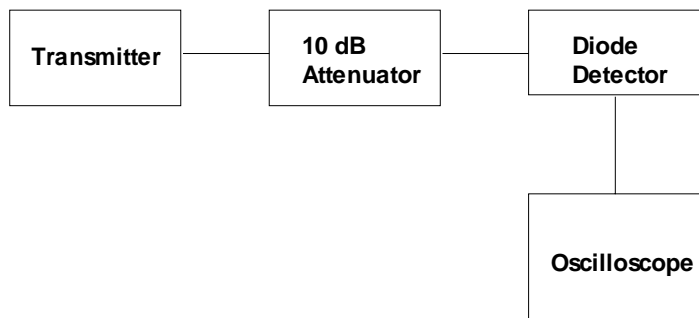

Step 2: Peak Power Measurements

- Replace the transmitter by a RF signal generator
- Set the signal generator frequency be the same as the transmitter frequency
- Adjust the rf output level of the RF signal generator until the DC level on the oscilloscope is same as that (y) recorded in step 1.
- Measure the RF signal generator output level using a power meter
- Calculate the total peak power (Pp) by adding the signal generator level with the attenuator value and the cable loss.

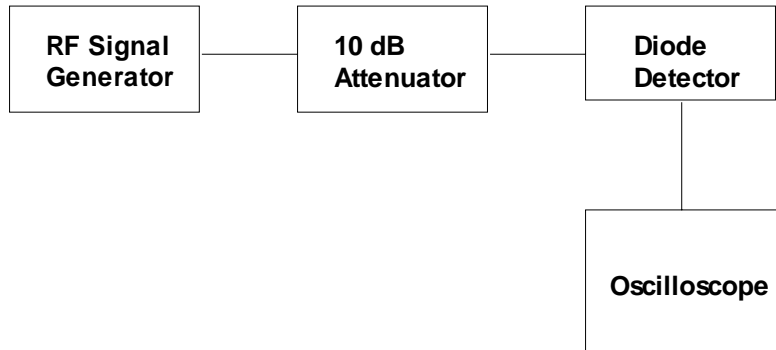

Step 3: Total Peak EIRP Substitution Method. See Figure 2

- (a) The setting of the spectrum analyzer shall be:

Center Frequency:	equal to the signal source
Resolution BW:	100 kHz for FSS, 1 MHz for DIGITAL MODULATION
Video BW:	same
Detector Mode:	positive
Average:	off
Span:	3 x the signal bandwidth

- (b) Connect the transmitter output to the spectrum analyzer and measure the peak power in 1 MHz bandwidth for reference.
- (c) Calculate the difference (Kp) between the total peak power and 1 MHz BW peak power. This value will be used to add onto the 1MHz BW peak EIRP to obtain the TOTAL peak EIRP.
- (d) Test was performed at listed 3m open area test site (listed with FCC, IC, ITI, NVLAP, ACA & VCCI).
- (e) The transmitter under test was placed at the specified height on a non-conducting turntable (80 cm height)
- (f) The horn test antenna was used and tuned to the transmitter carrier frequency.
- (g) The spectrum analyzer was tuned to transmitter carrier frequency. The test antenna was lowered or raised from 1 to 4 meters until the maximum signal level was detected.
- (h) The transmitter was rotated through 360° about a vertical axis until a higher maximum signal was received.
- (i) The test antenna was lowered or raised again from 1 to 4 meters until a maximum was obtained. This level was recorded.
- (j) The substitution horn antenna and the signal generator replaced the transmitter and antenna under test in the same position, and the substitution horn antenna was placed in vertical polarization. The test horn antenna was lowered or raised as necessary to ensure that the maximum signal is still received.

- (k) The input signal to the substitution antenna was adjusted in level until an equal or a known related level to that detected from the transmitter was obtained in the test receiver. The maximum carrier radiated power is equal to the power supply by the generator.
- (l) The substitution antenna gain and cable loss were added to the signal generator level for the corrected 1MHz BW peak EIRP level. The total peak EIRP can be calculated by adding its value with the Kp
- (m) Repeat steps (c) to (j) with the substitution antenna oriented in horizontal polarization. Measured in step (c).
- (n) Actual gain of the EUT's antenna is the difference of the measured ERP and measured RF power at the RF port. Correct the antenna gain if necessary.

Figure 2

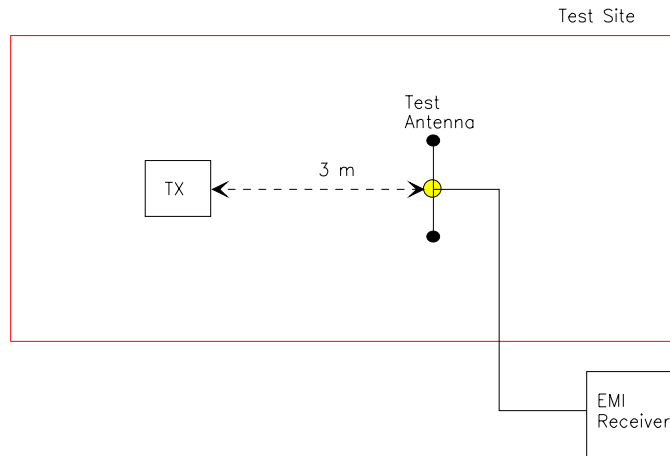
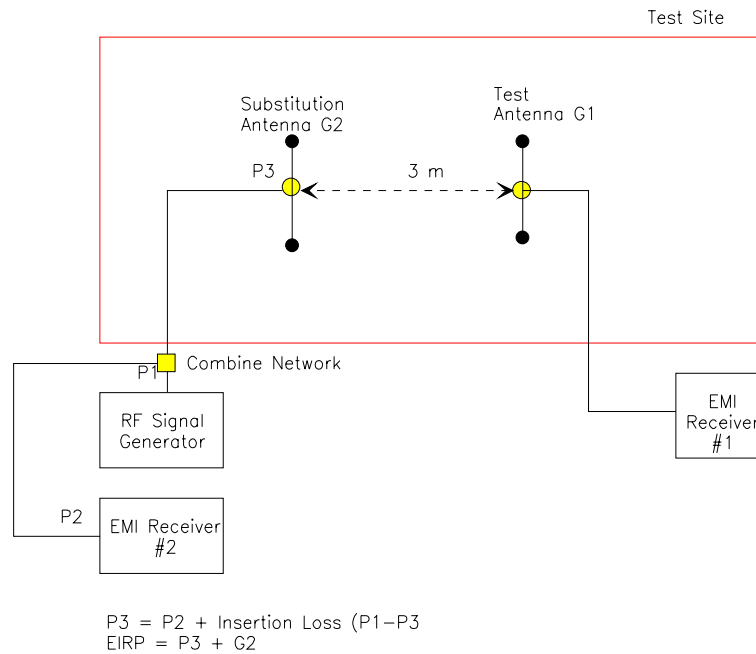

Figure 3



10.4. SPURIOUS EMISSIONS (CONDUCTED & RADIATED)

For both conducted and radiated measurements, the spurious emissions were scanned from the lowest frequency generated by the EUT or 10 MHz whichever is lower to 10th harmonic of the highest frequency generated by the EUT.

10.4.1. Band-edge and Spurious Emissions (Conducted)

Band-edge Compliance of RF Conducted Emissions:

Use the following spectrum analyzer settings:

- The radio was connected to the measuring equipment via a suitable attenuator.
- Span = wide enough to capture the peak level of the emission operating on the channel closest to the band-edge, as well as any modulation products which fall outside of the authorized band of operation.
- RBW = 1 % of the span
- VBW = RBW
- Sweep = auto
- Detector function = peak
- Trace = max hold
- Allow the trace to stabilize
- Set the marker on the emission at the band-edge, or on the highest modulation product outside of the band, if this level is greater than that at the band-edge
- Enable the marker-delta function, then use the marker-to-peak function to move the marker to the peak of the in-band emission.
- The marker-delta value now displayed must comply with the limit specified
- Submit this plot

Spurious RF Conducted Emissions:

Use the following spectrum analyzer settings:

- The radio was connected to the measuring equipment via a suitable attenuator.
- Span = wide enough to capture the peak level of the in-band-emission and all spurious emissions (e.g. harmonics) from the lowest frequency generated in the EUT up through the 10th harmonic. Typically, several plots are required to cover this entire span.
- RBW = 100 kHz
- VBW = RBW
- Sweep = auto
- Detector function = peak
- Trace = max hold
- Allow the trace to stabilize
- Set the marker on the any spurious emission recorded. The level displayed must comply with the limit specified in this Section.
- Submit this plot

10.4.2. Spurious Emissions (Radiated)

- The radiated emission measurements were performed at the UltraTech’s 3 Meter Open Field Test Site (OFTS) situated in the Town of Oakville, province of Ontario. The Attenuation Characteristics of OFTS have been filed to FCC, Industry Canada, ACA/Austel, NVLap and ITI.
- Radiated emissions measurements were made using the following test instruments:
 1. Calibrated EMCO BiconiLog antenna in the frequency range from 30 MHz to 2000 MHz.
 2. Calibrated Emco Horn antennas in the frequency range above 1000 MHz (1GHz - 40 GHz).
 3. The test is required for any spurious emission or modulation product that falls in a Restricted Band, as defined in Section 15.205. It must be performed with the highest gain of each type of antenna proposed for use with the EUT. Use the following spectrum analyzer settings:
 - RBW = 100 kHz for $f < 1\text{GHz}$ and $\text{RBW} = 1\text{ MHz}$ for $f \geq 1\text{ GHz}$
 - VBW = RBW
 - Sweep = auto
 - Detector function = peak
 - Trace = max hold
 - Follows the guidelines in ANSI C63.4-1992 with respect to maximizing the emission by rotating the EUT, measuring the emission while the EUT is situated in three orthogonal planes (if appropriate), adjusting the measurement antenna height and polarization, etc.. A pre-amp and highpass filter are required for this test, in order to provide the measuring system with sufficient sensitivity.
 - Allow the trace to stabilize.
 - The peak reading of the emission, after being corrected by the antenna correction factor, cable loss, pre-amp gain, etc.... is the peak field strength which comply with the limit specified in Section 15.35(b)

Calculation of Field Strength:

The field strength is calculated by adding the calibrated antenna factor and cable factor, and subtracting the Amplifier gain (if any) from the measured reading. The basic equation with a sample calculation is as follows:

$$\text{FS} = \text{RA} + \text{AF} + \text{CF} - \text{AG}$$

- Where
- FS = Field Strength
 - RA = Receiver/Analyzer Reading
 - AF = Antenna Factor
 - CF = Cable Attenuation Factor
 - AG = Amplifier Gain

Example: If a receiver reading of 60.0 dBuV is obtained, the antenna factor of 7.0 dB/m and cable factor of 1.0 dB are added, and the amplifier gain of 30 dB is subtracted. The actual field strength will be:

$$\text{Field Level} = 60 + 7.0 + 1.0 - 30 = 38.0 \text{ dBuV/m.}$$
$$\text{Field Level} = 10^{(38/20)} = 79.43 \text{ uV/m.}$$

- Submit this test data
- Now set the VBW to 10Hz, while maintaining all of the other instrument settings. This peak level, once corrected, must comply with the limit specified in Section 15.209. If the dwell time of the each channel is less than 100ms, then the reading obtained may be further adjusted by a “duty cycle correction factor”, derived from $10\log(\text{dwell time}/100\text{mS})$ in an effort to demonstrate compliance with the 15.209.
- Submit test data

Maximizing The Radiated Emissions:

- The frequencies of emissions was first detected. Then the amplitude of the emissions was measured at the specified measurement distance using required antenna height, polarization, and detector characteristics.
- During this process, cables and peripheral devices were manipulated within the range of likely configuration.
- For each mode of operation required to be tested, the frequency spectrum was monitored. Variations in antenna heights (from 1 meter to 4 meters above the ground plane), antenna polarization (horizontal plane and vertical plane), cable placement and peripheral placement were explored to produce the highest amplitude signal relative to the limit.

The maximum radiated emission for a given mode of operation was found by using the following step-by-step procedure:

- Step1: Monitor the frequency range of interest at a fixed antenna height and EUT azimuth.
- Step2: Manipulate the system cables to produce highest amplitude signal relative to the limit. Note the amplitude and frequency of the suspect signal.
- Step3: Rotate the EUT 360 degrees to maximize the suspected highest amplitude signal. If the signal or another at a different frequency is observed to exceed the previously noted highest amplitude signal by 1 dB or more, go back to the azimuth and repeat Step 2. Otherwise, orient the EUT azimuth to repeat the highest amplitude observation and proceed.
- Step4: Move the antenna over its full allowable range of travel (1 to 4 meters) to maximize the suspected highest amplitude signal. If the signal or another at a different frequency is observed to exceed the previously noted highest amplitude signal by 1 dB or more, return to Step 2 with the highest amplitude observation and proceed.
- Step5: Change the polarization of the antenna and repeat Step 2 through 4. Compare the resulting suspected highest amplitude signal with that found for the other polarization. Select and note the higher of the two signals. This signal is termed the highest observed signal with respect to the limit for this EUT operational mode.
- Step6: The effects of various modes of operation is examined. This is done by varying the equipment modes as steps 2 through 5 are being performed.
- Step7: After completing steps 1 through 6, record the final highest emission level, frequency, antenna polarization and detector mode of the measuring instrument.

10.5. ALTERNATIVE TEST PROCEDURES

If the antenna conducted tests cannot be performed on this device, radiated tests show compliance with the peak output power limit specified in Section 15.247(b) and the spurious RF conducted emission limit specified in Section 15.247(c) are acceptable. As stated previously, a pre-amp, and, in the later case, a high pass filter, are required for the following measurements:

10.5.1. Peak Power Measurements

Calculate the transmitter's peak power using the following equation:

$$E = 30PG/d$$
$$P = (Ed)^2/30G$$

Where:

- E: measured maximum fundamental field strength in V/m. Utilizing a RBW, the 20 dB bandwidth of the emission $VBW > RBW$, peak detector function. Follow the procedures in C63.4-1992 with respect to maximizing the emission
- G is numeric gain of the transmitting antenna with reference to an isotropic radiator
- D is the distance in meters from which the field strength was measured
- P is the distance in meters from which the field strength was measured

10.5.2. Spurious RF conducted emissions

To demonstrate compliance with the spurious RF conducted emission requirement of Section 15.247©, use the following spectrum analyzer settings:

- Span = wide enough to fully capture the emission being measured
- RBW = 100 kHz
- Sweep = auto
- Detector function = peak
- Trace = max hold
- Measure the field strength of both the fundamental and all spurious emissions with these settings.
- Follow the procedures C62-4:1994 with respect to maximizing the emissions. The measured field strength of all spurious emissions must be below the measured field strength of the fundamental emission by the amount specified in Section 15.247©. Note that if the emission falls in a Restricted Band, as defined in Section 15.205, the procedure for measuring spurious radiated emissions listed above must be followed

10.6. TRANSMITTED POWER DENSITY OF A DIGITAL MODULATION SYSTEM

- The radio was connected to the measuring equipment via a suitable attenuator.
- Locate and zoom in on emission peak(s) within the passband
- The spectrum analyzer were used and set as follows:
 - Resolution BW: 3 kHz
 - Video BW: same or greater
 - Detector Mode: Normal
 - Averaging: Off
 - Span: 3 MHz
 - Amplitude: Adjust for middle of the instrument's range
 - Sweep Time: 1000 seconds
- Locate and zoom in on emission peak(s) within the passband. Set RBW = 3 KHz, VBW \geq RBW, Sweep = SPAN/3 KHz. For example, a span of 1.5 MHz, the sweep should be $1.6 \times 10^6 / 3.0 \times 10^3 = 500$ seconds. The measured peak level must be no greater than +8 dBm.
- For devices with spectrum line spacing greater than 3 KHz no change is required.
- For devices with spectrum line spacing equal to or less than 3 KHz, the resolution bandwidth must be reduced below 3 KHz until the individual lines in the spectrum are resolved. The measurement data must then be normalized to 3 KHz by summing the power of all the individual spectral lines within 3 KHz band (in linear power units) to determine compliance.
- If the spectrum line spacing cannot be resolved on the available spectrum analyzer, the noise density function on most modern conventional spectrum analyzer will directly measure the noise power density normalized to 1 Hz noise power bandwidth. Add 30 dB for correction to 3 KHz.
- Should all the above fail or any controversy develop regarding accuracy of measurement, the Laboratory will use HP 89440A Vector Signal Analyzer for final measurement unless a clear showing can be made for a further alternate.