



## FCC PART 90 TEST REPORT

### FCC Part 90

**Report Reference No.**.....: **TRE1212005901 R/C: 82236**

**FCC ID**.....: **RIQAW68XDB**

Compiled by

( position+printed name+signature)..: File administrators Tim Zhang

*Tim Zhang*

Supervised by

( position+printed name+signature)..: Test Engineer Eric Zhang

*Eric Zhang*

Approved by

( position+printed name+signature)..: Manager Wenliang Li

*Wenliang Li*

Date of issue.....: Dec 24, 2012

**Testing Laboratory Name** .....: **Shenzhen Huatongwei International Inspection Co., Ltd**

Address .....: Keji Nan No.12 Road, Hi-tech Park, Shenzhen, China

**Applicant's name**.....: **Access Device Integrated Communications Corp.**

Address .....: No.193,Sec.1,Chungching Road,Taya,Taichung City 42862, Taiwan(R.O.C.)

**Test specification:**

Standard .....: **FCC Part 90: PRIVATE LAND MOBILE RADIO SERVICES**

TRF Originator .....: Shenzhen Huatongwei International Inspection CO., Ltd

Master TRF .....: Dated 2006-06

**Shenzhen Huatongwei International Inspection Co., Ltd. All rights reserved.**

This publication may be reproduced in whole or in part for non-commercial purposes as long as the Shenzhen Huatongwei International Inspection Co., Ltd is acknowledged as copyright owner and source of the material. Shenzhen Huatongwei International Inspection Co., Ltd takes no responsibility for and will not assume liability for damages resulting from the reader's interpretation of the reproduced material due to its placement and context.

**Test item description** .....: Dual Band Two-Way Radio

Trade Mark .....: /

Manufacturer .....: **Access Device Integrated Communications Corp.**

Model/Type reference.....: AW-68

Listed Models .....: AW-69,AW-68V,LT-9800,LT-9808

Ratings .....: DC 7.4V

Modulation .....: FM

Channel Separation.....: 12.5KHz

Rated Power .....: UHF: 4 Watts(36.02dBm)/1 Watts(30.00dBm)

VHF: 5 Watts(36.98dBm)/1 Watts(30.00dBm)

Operation Frequency Range .....: From 136 MHz to 174 MHz and 400MHz to 480MHz

Result.....: **Positive**

# TEST REPORT

<b>Test Report No. :</b>	<b>TRE1212005901</b>	Dec 24, 2012
		Date of issue

Equipment under Test : Dual Band Two-Way Radio

Model /Type : AW-68

Listed Models : AW-69,AW-68V,LT-9800,LT-9808

**Applicant** : **Access Device Integrated Communications Corp.**

Address : No.193,Sec.1,Chungching Road,Taya,Taichung City  
42862,Taiwan(R.O.C.)

**Manufacturer** : **Access Device Integrated Communications Corp.**

Address : No.193,Sec.1,Chungching Road,Taya,Taichung City  
42862,Taiwan(R.O.C.)

<b>Test Result</b> according to the standards on page 4:	<b>Positive</b>
--	-----------------

The test report merely corresponds to the test sample.  
It is not permitted to copy extracts of these test result without the written permission of the test laboratory.

# Contents

<b>1.</b>	<b><u>TEST STANDARDS</u></b>	<b>4</b>
<b>2.</b>	<b><u>SUMMARY</u></b>	<b>5</b>
2.1.	General Remarks	5
2.2.	Product Description	5
2.3.	Equipment under Test	5
2.4.	Short description of the Equipment under Test (EUT)	6
2.5.	EUT Configuration	6
2.6.	EUT operation mode	6
2.7.	EUT configuration	6
2.8.	Related Submittal(s) / Grant (s)	6
2.9.	Modifications	6
2.10.	Note	6
<b>3.</b>	<b><u>TEST ENVIRONMENT</u></b>	<b>7</b>
3.1.	Address of the test laboratory	7
3.2.	Test Facility	7
3.3.	Environmental conditions	8
3.4.	Configuration of Tested System	8
3.5.	Discription of Tested Modes	8
3.6.	Statement of the measurement uncertainty	8
3.7.	Test Description	9
3.8.	Equipments Used during the Test	9
<b>4.</b>	<b><u>TEST CONDITIONS AND RESULTS</u></b>	<b>12</b>
4.1.	Conducted Emissions Test (For Volunteer)	12
4.2.	Occupied Bandwidth and Emission Mask Test	17
4.3.	Transmitter Radiated Spurious Emssion	29
4.4.	Spurious Emssion on Antenna Port	34
4.5.	Modulation Charcateristics	48
4.6.	Frequency Stability Test	51
4.7.	Maximum Transmitter Power	53
4.8.	Transmitter Frequency Behavior	60
4.9.	Receiver Radiated Spurious Emssion (For Volunteer)	62
4.10.	Receiver Conducted Spurious Emssion (For Volunteer)	72
<b>5.</b>	<b><u>TEST SETUP PHOTOS OF THE EUT</u></b>	<b>79</b>
<b>6.</b>	<b><u>EXTERNAL AND INTERNAL PHOTOS OF THE EUT</u></b>	<b>83</b>

## **1. TEST STANDARDS**

The tests were performed according to following standards:

**FCC Rules Part 90: PRIVATE LAND MOBILE RADIO SERVICES.**

**TIA/EIA 603 D June 2010: Land Mobile FM or PM Communications Equipment Measurement and Performance Standards.**

**47 CFR FCC Part 15 Subpart B - Unintentional Radiators**

**FCC Part 2: FREQUENCY ALLOCATIONS AND RADIO TREATY MATTERS; GENERAL RULES AND REGULATIONS**

## 2. SUMMARY

### 2.1. General Remarks

Date of receipt of test sample	:	Dec 17, 2012
Testing commenced on	:	Dec 17, 2012
Testing concluded on	:	Dec 24, 2012

### 2.2. Product Description

The Access Device Integrated Communications Corp.'s Model: AW-68 or the "EUT" as referred to in this report; more general information as follows, for more details, refer to the user's manual of the EUT.

Name of EUT	Dual Band Two-Way Radio	
Model Number	AW-68, AW-69,AW-68V,LT-9800,LT-9808	
FCC ID	RIQAW68XDB	
Rated Output Power	UHF: 4 Watts(36.02dBm)/1 Watts(30.00dBm) VHF: 5 Watts(36.98dBm)/1 Watts(30.00dBm)	
Modulation Type	FM for Analog Voice	
	Analog	11K0F3E for 12.5KHz Channel Separation
Channel Separation	Analog Voice	12.5KHz
Antenna Type	External	
Frequency Range	From 136 MHz to 174 MHz/From 400MHz to 480MHz	
Maximum Transmitter Power	Analog	5.395W for VHF Band
		4.613W for UHF Band

### 2.3. Equipment under Test

#### Power supply system utilised

Power supply voltage	:	<input type="radio"/> 120V / 60 Hz	<input type="radio"/> 115V / 60Hz
		<input type="radio"/> 12 V DC	<input type="radio"/> 24 V DC
		<input checked="" type="radio"/> Other (specified in blank below)	

DC 7.4V from battery

#### Test frequency list

Modulation Type	Band	Test Channel	Test Frequency
Analog/FM	VHF	Low	136.5000 MHz
		Middle	155.5000 MHz
		High	173.5000 MHz
	UHF	Low	400.5000 MHz
		Middle	440.5000 MHz
		High	479.5000 MHz

## 2.4. Short description of the Equipment under Test (EUT)

136-174 MHz 400-480 MHz frequency band Dual Band Two-Way Radio.

For more details, refer to the user's manual of the EUT.

Serial number: Prototype

## 2.5. EUT Configuration

The EUT configuration for testing is installed on RF field strength measurement to meet the Commission's requirement and operating in a manner which intends to maximize its emission characteristics in a continuous normal application.

## 2.6. EUT operation mode

The EUT has been tested under typical operating condition and The Transmitter was operated in the normal operating mode. The TX frequency was fixed which was for the purpose of the measurements.

## 2.7. EUT configuration

The following peripheral devices and interface cables were connected during the measurement:

● - supplied by the manufacturer

○ - supplied by the lab

<input type="radio"/>	Power Cable	Length (m) :	/
		Shield :	/
		Detachable :	/
<input type="radio"/>	Multimeter	Manufacturer :	/
		Model No. :	/

## 2.8. Related Submittal(s) / Grant (s)

This submittal(s) (test report) is intended for FCC ID: **RIQAW68XDB** filing to comply with FCC Part 90 Rules

## 2.9. Modifications

No modifications were implemented to meet testing criteria.

## 2.10. Note

The EUT is Dual Band Two-Way Radio, The functions of the EUT listed as below:

	Test Standards	Reference Report
Radio	FCC Part 90	TRE1212005901
EMF	OET 65	TRE1212005902

### **3. TEST ENVIRONMENT**

#### **3.1. Address of the test laboratory**

Shenzhen Huatongwei International Inspection Co., Ltd  
Keji Nan No.12 Road, Hi-tech Park, Shenzhen, China  
Phone: 86-755-26715686 Fax: 86-755-26748089

The sites are constructed in conformance with the requirements of ANSI C63.7, ANSI C63.4 (2009) and CISPR Publication 22.

#### **3.2. Test Facility**

The test facility is recognized, certified, or accredited by the following organizations:

##### **CNAS-Lab Code: L1225**

Shenzhen Huatongwei International Inspection Co., Ltd has been assessed and proved to be in compliance with CNAS-CL01 Accreditation Criteria for Testing and Calibration Laboratories (identical to ISO/IEC 17025: 2005 General Requirements) for the Competence of Testing and Calibration Laboratories, Date of Registration: August 02, 2007. Valid time is until Feb 28, 2015.

##### **A2LA-Lab Cert. No. 2243.01**

Shenzhen Huatongwei International Inspection Co., Ltd, EMC Laboratory has been accredited by A2LA for technical competence in the field of electrical testing, and proved to be in compliance with ISO/IEC 17025: 2005 General Requirements for the Competence of Testing and Calibration Laboratories and any additional program requirements in the identified field of testing. Valid time is until Sept 30, 2013.

##### **FCC-Registration No.: 662850**

Shenzhen Huatongwei International Inspection Co., Ltd, EMC Laboratory has been registered and fully described in a report filed with the FCC (Federal Communications Commission). The acceptance letter from the FCC is maintained in our files. Registration 662850, Renewal date June 01, 2015.

##### **IC-Registration No.: 5377**

The 3m Alternate Test Site of Shenzhen Huatongwei International Inspection Co., Ltd has been registered by Certification and Engineering Bureau of Industry Canada for the performance of radiated measurements with Registration No. 5377 on Jan 25, 2011. Valid time is until Jan 24, 2014

##### **ACA**

Shenzhen Huatongwei International Inspection Co., Ltd, EMC Laboratory can also perform testing for the Australian C-Tick mark as a result of our A2LA accreditation.

##### **NEMKO-Aut. No.: ELA125**

Shenzhen Huatongwei International Inspection Co., Ltd has been assessed the quality assurance system, the testing facilities, qualifications and testing practices of the relevant parts of the organization. The quality assurance system of the Laboratory has been validated against ISO/IEC 17025:2005 or equivalent. The laboratory also fulfils the conditions described in Nemko Document NLA-10; the Authorization is valid through July 07, 2013.

##### **VCCI**

The 3m Semi-anechoic chamber (12.2m×7.95m×6.7m) and Shielded Room (8m×4m×3m) of Shenzhen Huatongwei International Inspection Co., Ltd has been registered in accordance with the Regulations for Voluntary Control Measures with Registration No.: R-2484. Date of Registration: December 20, 2009. Valid time is until December 19, 2013.

Main Ports Conducted Interference Measurement of Shenzhen Huatongwei International Inspection Co., Ltd has been registered in accordance with the Regulations for Voluntary Control Measures with Registration No.: C-2726. Date of Registration: December 20, 2009. Valid time is until December 19, 2013.

### DNV

Shenzhen Huatongwei International Inspection Co Ltd has been found to comply with the requirements of DNV towards subcontractor of EMC and safety testing services in conjunction with the EMC and Low voltage Directives and in the voluntary field. The acceptance is based on a formal quality Audit and follow-ups according to relevant parts of ISO/IEC Guide 17025(2005), in accordance with the requirements of the DNV Laboratory Quality Manual towards subcontractors. Valid time is until Aug 24, 2013..

### 3.3. Environmental conditions

During the measurement the environmental conditions were within the listed ranges:

Temperature:	15-35 ° C
Humidity:	30-60 %
Atmospheric pressure:	950-1050mbar

### 3.4. Configuration of Tested System

Fig. 2-1 Configuration of Tested System

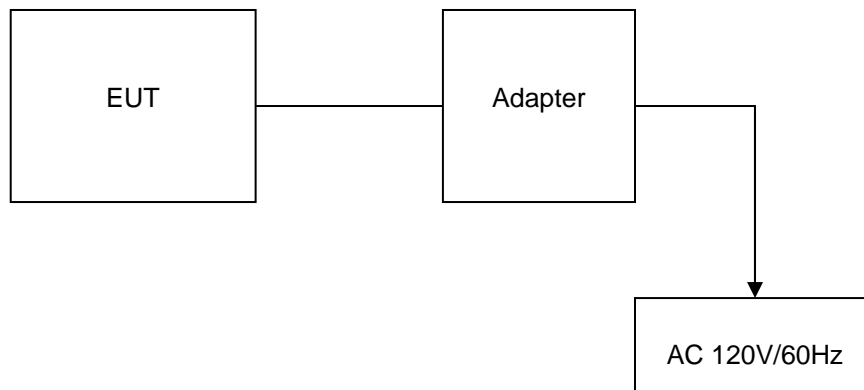

Table 2-1 Equipment Used in Tested System

**Adapter:**

Model: NLA050120W1U  
 Input:100-240V~, 0.2A 50/60Hz  
 Output: DC 12V 0.5A  
 Power Cable: 120cm  
 ◇ Shielded      ◆ Unshielded

### 3.5. Discription of Tested Modes

The EUT has been tested under normal operating condition. Five channels (the high, the middle and the low) are chosen for testing at each channel separation (12.5 KHz).

### 3.6. Statement of the measurement uncertainty

The data and results referenced in this document are true and accurate. The reader is cautioned that there may be errors within the calibration limits of the equipment and facilities. The measurement uncertainty was calculated for all measurements listed in this test report acc. to CISPR 16 - 4 „Specification for radio disturbance and immunity measuring apparatus and methods – Part 4: Uncertainty in EMC Measurements“ and is documented in the Shenzhen Huatongwei International Inspection Co., Ltd quality system acc. to DIN EN ISO/IEC 17025. Furthermore, component and process variability of devices similar to that tested may result in additional deviation. The manufacturer has the sole responsibility of continued compliance of the device.



Hereafter the best measurement capability for Shenzhen Huatongwei laboratory is reported:

Test Items	Measurement Uncertainty	Notes
Frequency stability	25 Hz	(1)
Transmitter power conducted	0.57 dB	(1)
Transmitter power Radiated	2.20 dB	(1)
Conducted spurious emission 9KHz-12.75 GHz	1.60 dB	(1)
Conducted Emission 9KHz-30MHz	3.39 dB	(1)
Radiated Emission 30~1000MHz	4.24 dB	(1)
Radiated Emissio 1~18GHz	5.16 dB	(1)
Radiated Emissio 18-40GHz	5.54 dB	(1)
Occupied Bandwidth	-----	(1)
Emission Mask	-----	(1)
Modulation Characteristic	-----	(1)
Transmitter Frequency Behavior	-----	(1)

(1) This uncertainty represents an expanded uncertainty expressed at approximately the 95% confidence level using a coverage factor of k=1.96.

### 3.7. Test Description

FCC Rules	Description of Test	Test Result
§ 15.107	Conducted Emission	Complies
§ 15.109	Receiver Radiated Spurious Emssion	Complies
§ 15.109	Receiver Conducted Spurious Emssion	Complies
§ 90.205	Maximum Transmitter Power	Complies
§ 90.207	Modulation Characteristic	Complies
§ 90.209	Occupied Bandwidth	Complies
§ 90.210	Emission Mask	Complies
§ 90.213	Frequency Stability	Complies
§ 90.214	Transmitter Frequency Behavior	Complies
§ 90.210	Transmitter Radiated Spurious Emssion	Complies
§ 90.210	Spurious Emssion On Antenna Port	Complies
§ 2.1093	Radiofrequency radiation exposure evaluation	Complies

### 3.8. Equipments Used during the Test

AC Power Conducted Emission				
Name of Equipment	Manufacturer	Model	Serial Number	Calibration Due
Artificial Mains	Rohde&Schwarz	ESH2-Z5	100028	10/27/2013
EMI Test Receiver	Rohde&Schwarz	ESCS 30	100038	10/27/2013
Pulse Limiter	Rohde&Schwarz	ESHSZ2	100044	10/27/2013
EMI Test Software	Rohde&Schwarz	ES-K1 V1.71	N/A	10/27/2013
RF COMMUNICATION TEST SET	HP	8920A	3813A10206	10/27/2013

Modulation Characteristic				
Name of Equipment	Manufacturer	Model	Serial Number	Calibration Due
RF COMMUNICATION TEST SET	HP	8920A	3813A10206	10/27/2013

Transient Frequency Behavior				
Name of Equipment	Manufacturer	Model	Serial Number	Calibration Due
Signal Generator	Rohde&Schwarz	SMT03	100059	10/27/2013
Storage Oscilloscope	Tektronix	TDS3054B	B033027	10/27/2013
RF COMMUNICATION TEST SET	HP	8920A	3813A10206	10/27/2013

Transmitter Radiated Spurious Emssion & Receiver Radiated Spurious Emssion				
Name of Equipment	Manufacturer	Model	Serial Number	Calibration Due
Ultra-Broadband Antenna	Rohde&Schwarz	HL562	100015	10/27/2013
EMI Test Receiver	Rohde&Schwarz	ESI 26	100009	10/27/2013
RF Test Panel	Rohde&Schwarz	TS / RSP	335015/ 0017	N/A
HORN ANTENNA	Rohde&Schwarz	HF906	100039	10/27/2013
Turntable	ETS	2088	2149	N/A
Antenna Mast	ETS	2075	2346	N/A
EMI Test Software	Rohde&Schwarz	ES-K1 V1.71	N/A	10/27/2013
RF COMMUNICATION TEST SET	HP	8920A	3813A10206	10/27/2013
Ultra-Broadband Antenna	ShwarzBeck	VULB9163	538	10/27/2013
Ultra-Broadband Antenna	ShwarzBeck	VULB9163	539	10/27/2013
HORN ANTENNA	ShwarzBeck	9120D	1012	10/27/2013
HORN ANTENNA	ShwarzBeck	9120D	1011	10/27/2013
TURNTABLE	MATURO	TT2.0	----	10/27/2013
ANTENNA MAST	MATURO	TAM-4.0-P	----	10/27/2013

Frequency Stability				
Name of Equipment	Manufacturer	Model	Serial Number	Calibration Due
Communication Test Set	HP	HP8920B	US35010135	10/27/2013
Signal Generator	Rohde&Schwarz	SMT03	100059	10/27/2013
Climate Chamber	ESPEC	EL-10KA	05107008	10/27/2013

Maximum Transmitter Power & Spurious Emission On Antenna Port & Occupied Bandwidth & Emission Mask				
Name of Equipment	Manufacturer	Model	Serial Number	Calibration Due
Receiver	Rohde&Schwarz	ESI 26	100009	10/27/2013
Attenuator	R&S	ESH3-22	100449	10/27/2013
RF COMMUNICATION TEST SET	HP	8920A	3813A10206	10/27/2013
High-Pass Filter	Anritsu	MP526B	6220875256	10/27/2013
High-Pass Filter	Anritsu	MP526D	6220878392	10/27/2013
Spectrum Analyzer	Aglient	E4407B	MY44210775	10/27/2013
Spectrum Analyzer	Rohde&Schwarz	FSP40	1164.4391.40	10/27/2013

The calibration interval was one year.

## 4. TEST CONDITIONS AND RESULTS

### 4.1. Conducted Emissions Test (For Volunteer)

#### TEST APPLICABLE

The EUT was tested according to ANSI C63.4 - 2009. The frequency spectrum from 0.15 MHz to 30 MHz was investigated. The LISN used was 50 ohm / 50 u Henry as specified by section 5.1 of ANSI C63.4 - 2009. Cables and peripherals were moved to find the maximum emission levels for each frequency.

#### TEST CONFIGURATION

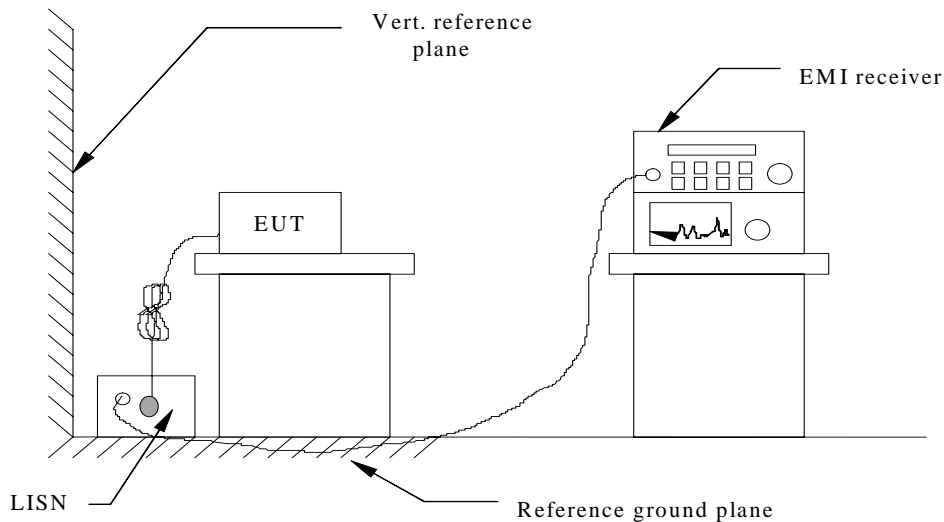

#### TEST PROCEDURE

- 1 The equipment was set up as per the test configuration to simulate typical actual usage per the user's manual. The EUT is a tabletop system; a wooden table with a height of 0.8 meters is used and is placed on the ground plane as per ANSI C63.4-2009.
- 2 Support equipment, if needed, was placed as per ANSI C63.4-2009.
- 3 All I/O cables were positioned to simulate typical actual usage as per ANSI C63.4-2009.
- 4 If a EUT received DC power from the adapter, the adapter received AC120V/60Hz power through a Line Impedance Stabilization Network (LISN) which supplied power source and was grounded to the ground plane.
- 5 All support equipments received AC power from a second LISN, if any.
- 6 The EUT test program was started. Emissions were measured on each current carrying line of the EUT using a spectrum Analyzer / Receiver connected to the LISN powering the EUT. The LISN has two monitoring points: Line 1 (Hot Side) and Line 2 (Neutral Side). Two scans were taken: one with Line 1 connected to Analyzer / Receiver and Line 2 connected to a 50 ohm load; the second scan had Line 1 connected to a 50 ohm load and Line 2 connected to the Analyzer / Receiver.
- 7 Analyzer / Receiver scanned from 150 KHz to 30MHz for emissions in each of the test modes.
- 8 During the above scans, the emissions were maximized by cable manipulation.

#### Conducted Power Line Emission Limit

For unintentional device, according to § 15.107(a) Line Conducted Emission Limits is as following :

Frequency (MHz)	Maximum RF Line Voltage (dBµV)			
	CLASS A		CLASS B	
	Q.P.	Ave.	Q.P.	Ave.
0.15 - 0.50	79	66	66-56*	56-46*
0.50 - 5.00	73	60	56	46
5.00 - 30.0	73	60	60	50

\* Decreasing linearly with the logarithm of the frequency

**TEST RESULTS**

**For VHF Band @ 12.5 KHz RX Mode**

**SCAN TABLE: "Voltage (9K-30M) FIN"**

Short Description: 150K-30M Voltage

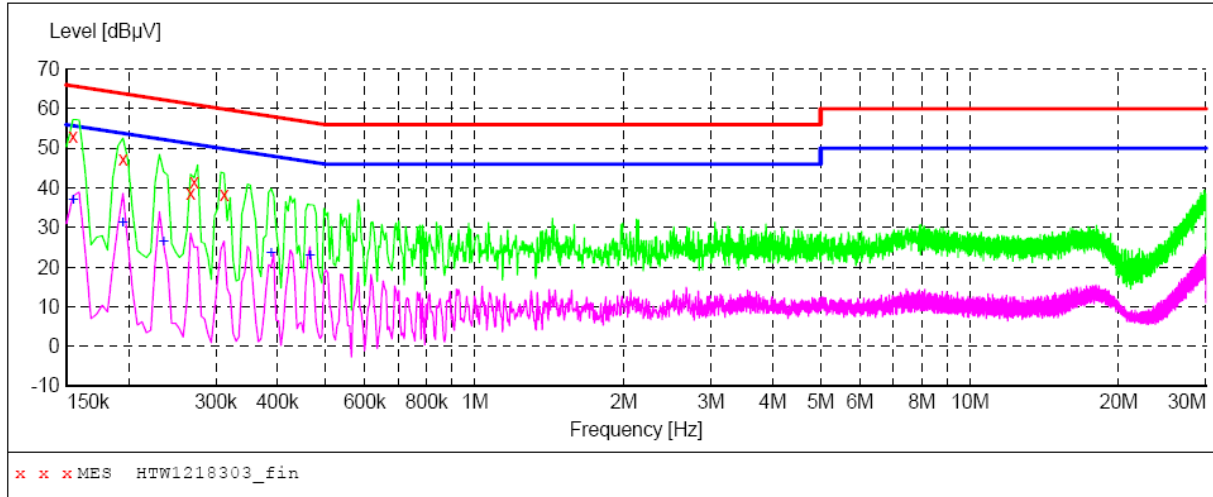

**MEASUREMENT RESULT: "HTW1218303\_fin"**

12/18/2012 9:21AM

Frequency MHz	Level dBµV	Transd dB	Limit dBµV	Margin dB	Detector	Line	PE
0.154500	53.00	10.2	66	12.8	QP	N	GND
0.195000	47.40	10.2	64	16.4	QP	N	GND
0.267000	38.70	10.2	61	22.5	QP	N	GND
0.271500	41.40	10.2	61	19.7	QP	N	GND
0.312000	38.50	10.2	60	21.4	QP	N	GND

**MEASUREMENT RESULT: "HTW1218303\_fin2"**

12/18/2012 9:21AM

Frequency MHz	Level dBµV	Transd dB	Limit dBµV	Margin dB	Detector	Line	PE
0.154500	37.10	10.2	56	18.7	AV	N	GND
0.195000	31.50	10.2	54	22.3	AV	N	GND
0.235500	26.40	10.2	52	25.9	AV	N	GND
0.388500	23.50	10.2	48	24.6	AV	N	GND
0.465000	23.00	10.2	47	23.6	AV	N	GND

**SCAN TABLE: "Voltage (9K-30M) FIN"**  
 Short Description: 150K-30M Voltage

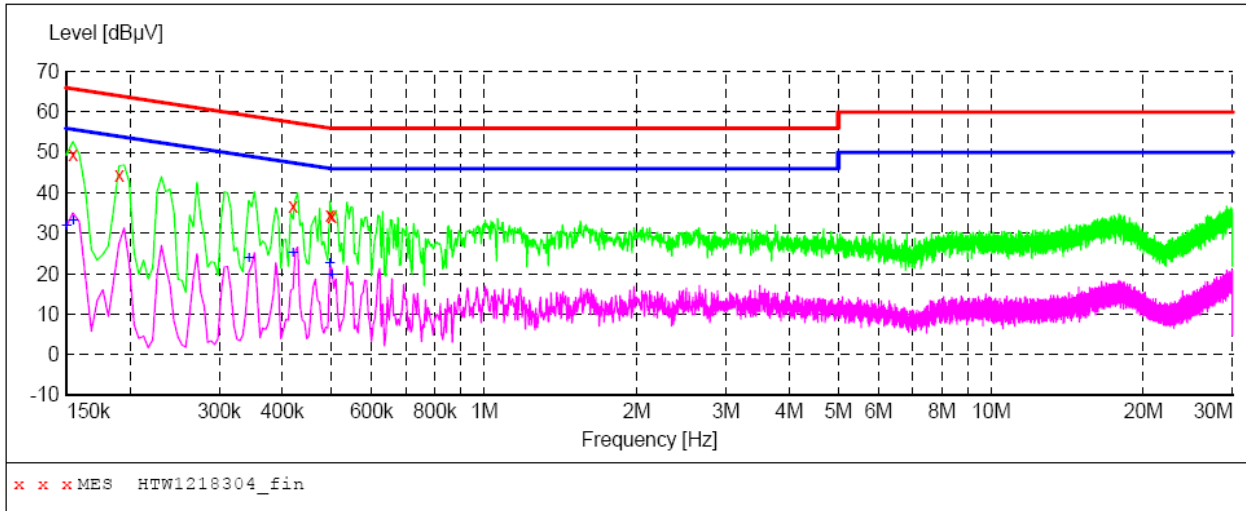

**MEASUREMENT RESULT: "HTW1218304\_fin"**

12/18/2012 9:24AM

Frequency MHz	Level dBµV	Transd dB	Limit dBµV	Margin dB	Detector	Line	PE
0.154500	49.70	10.2	66	16.1	QP	L1	GND
0.190500	44.50	10.2	64	19.5	QP	L1	GND
0.420000	36.80	10.2	57	20.6	QP	L1	GND
0.496500	34.50	10.2	56	21.6	QP	L1	GND
0.501000	34.20	10.2	56	21.8	QP	L1	GND

**MEASUREMENT RESULT: "HTW1218304\_fin2"**

12/18/2012 9:24AM

Frequency MHz	Level dBµV	Transd dB	Limit dBµV	Margin dB	Detector	Line	PE
0.150000	31.80	10.2	56	24.2	AV	L1	GND
0.154500	33.40	10.2	56	22.4	AV	L1	GND
0.343500	24.10	10.2	49	25.0	AV	L1	GND
0.420000	25.20	10.2	47	22.2	AV	L1	GND
0.496500	22.60	10.2	46	23.5	AV	L1	GND
0.501000	19.80	10.2	46	26.2	AV	L1	GND

For UHF Band @ 12.5 KHz RX Mode

SCAN TABLE: "Voltage (9K-30M) FIN"  
 Short Description: 150K-30M Voltage

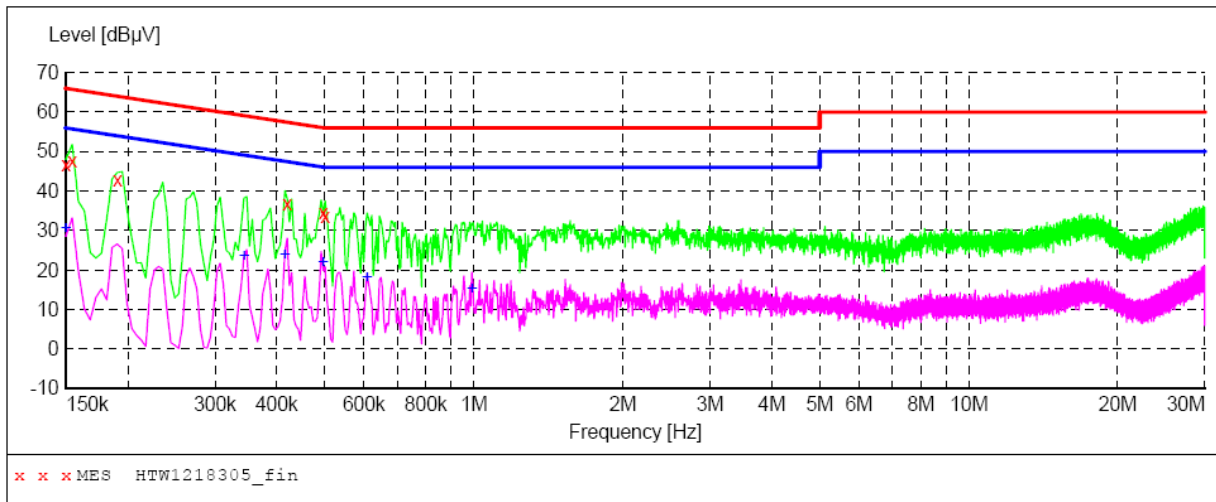

MEASUREMENT RESULT: "HTW1218305\_fin"

12/18/2012 9:27AM

Frequency MHz	Level dBµV	Transd dB	Limit dBµV	Margin dB	Detector	Line	PE
0.150000	46.80	10.2	66	19.2	QP	L1	GND
0.154500	47.50	10.2	66	18.3	QP	L1	GND
0.190500	42.70	10.2	64	21.3	QP	L1	GND
0.420000	36.60	10.2	57	20.8	QP	L1	GND
0.496500	34.40	10.2	56	21.7	QP	L1	GND
0.501000	33.60	10.2	56	22.4	QP	L1	GND

MEASUREMENT RESULT: "HTW1218305\_fin2"

12/18/2012 9:27AM

Frequency MHz	Level dBµV	Transd dB	Limit dBµV	Margin dB	Detector	Line	PE
0.150000	30.70	10.2	56	25.3	AV	L1	GND
0.343500	23.70	10.2	49	25.4	AV	L1	GND
0.415500	24.00	10.2	48	23.5	AV	L1	GND
0.496500	22.10	10.2	46	24.0	AV	L1	GND
0.609000	18.20	10.2	46	27.8	AV	L1	GND
0.991500	15.40	10.3	46	30.6	AV	L1	GND

**SCAN TABLE: "Voltage (9K-30M) FIN"**  
 Short Description: 150K-30M Voltage

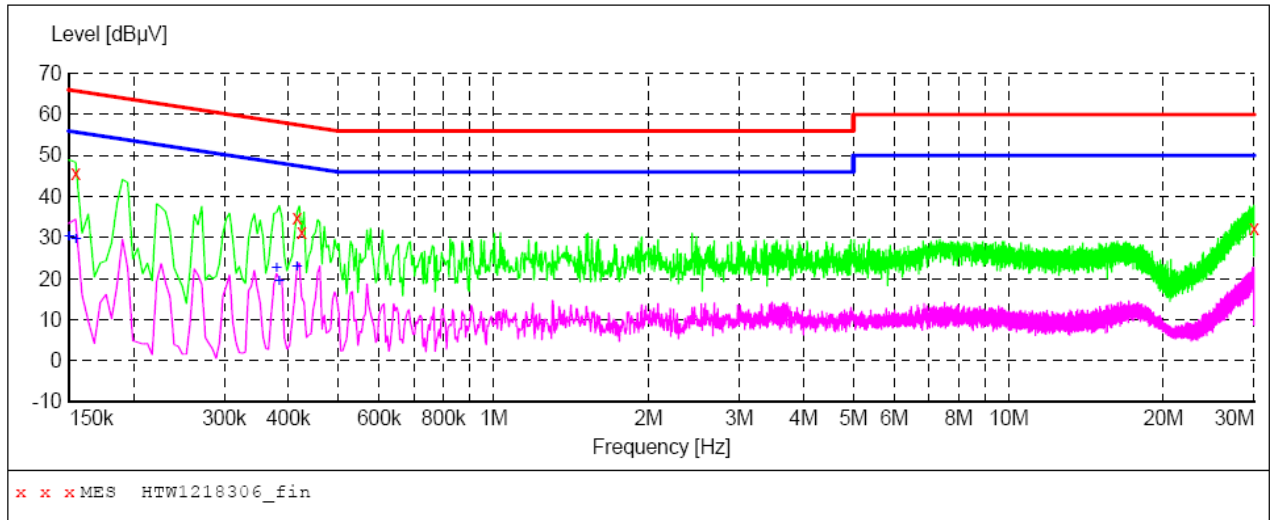

**MEASUREMENT RESULT: "HTW1218306\_fin"**

12/18/2012 9:30AM

Frequency MHz	Level dBµV	Transd dB	Limit dBµV	Margin dB	Detector	Line	PE
0.154500	45.70	10.2	66	20.1	QP	N	GND
0.415500	34.70	10.2	58	22.8	QP	N	GND
0.424500	31.20	10.2	57	26.2	QP	N	GND
29.980500	32.30	11.3	60	27.7	QP	N	GND

**MEASUREMENT RESULT: "HTW1218306\_fin2"**

12/18/2012 9:30AM

Frequency MHz	Level dBµV	Transd dB	Limit dBµV	Margin dB	Detector	Line	PE
0.150000	30.40	10.2	56	25.6	AV	N	GND
0.154500	29.70	10.2	56	26.1	AV	N	GND
0.379500	22.80	10.2	48	25.5	AV	N	GND
0.384000	19.40	10.2	48	28.8	AV	N	GND
0.415500	23.00	10.2	48	24.5	AV	N	GND



## 4.2. Occupied Bandwidth and Emission Mask Test

### TEST APPLICABLE

- (a). Occupied Bandwidth: The EUT was connected to the audio signal generator and the spectrum analyzer via the main RF connector, and through an appropriate attenuator. The EUT was controlled to transmit its maximum power. Then the bandwidth of 99% power can be measured by the spectrum analyzer.
- (b). Emission Mask B: For transmitters that are equipped with an audio low-pass filter pursuant to §90.211(a), the power of any emission must be below the unmodulated carrier power (P) as follows:
- (1) On any frequency removed from the assigned frequency by more than 50 percent, but not more than 100 percent of the authorized bandwidth: At least 25 dB.
  - (2) On any frequency removed from the assigned frequency by more than 100 percent, but not more than 250 percent of the authorized bandwidth: At least 35 dB.
  - (3) On any frequency removed from the assigned frequency by more than 250 percent of the authorized bandwidth: At least  $43 + 10 \log (P)$  dB.
- (c). Emission Mask D, 12.5 kHz channel bandwidth equipment: For transmitters designed to operate with a 12.5 kHz channel bandwidth, any emission must be attenuated below the power (P) of the highest emission contained within the authorized bandwidth as follows:
- (1) On any frequency from the center of the authorized bandwidth  $f_0$  to 5.625 kHz removed from  $f_0$ : Zero dB.
  - (2) On any frequency removed from the center of the authorized bandwidth by a displacement frequency ( $f_d$  in kHz) of more than 5.625 kHz but no more than 12.5 kHz: At least  $7.27(f_d - 2.88 \text{ kHz})$  dB.
  - (3) On any frequency removed from the center of the authorized bandwidth by a displacement frequency ( $f_d$  in kHz) of more than 12.5 kHz: At least  $50 + 10 \log (P)$  dB or 70 dB, whichever is the lesser attenuation.

### TEST CONFIGURATION

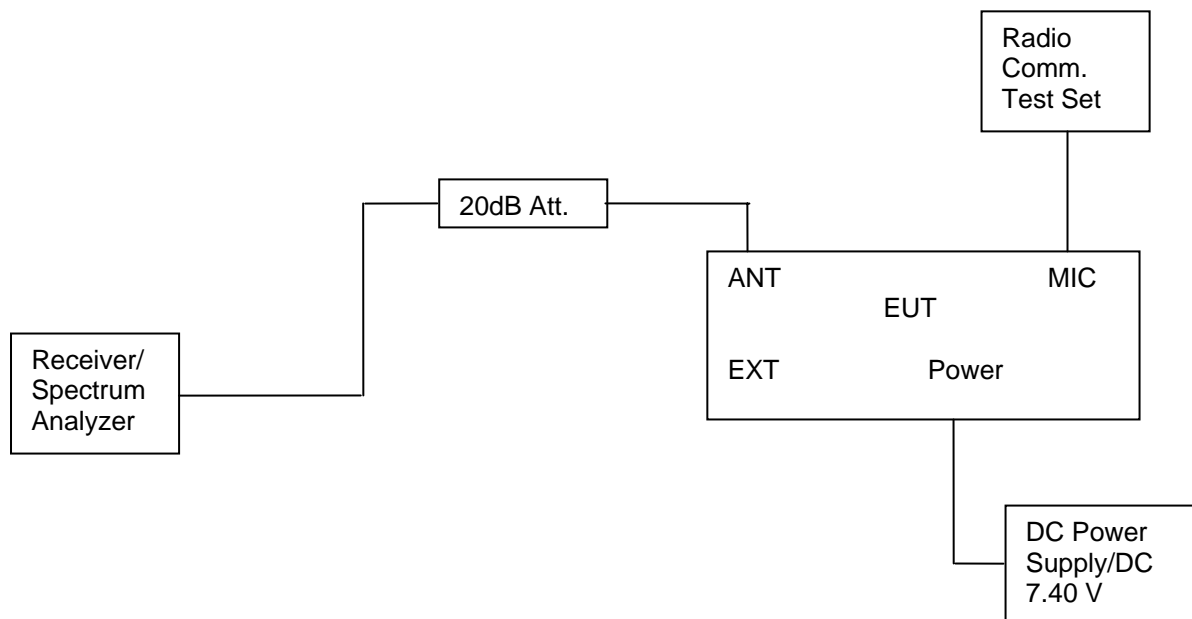

### TEST PROCEDURE

- 1 The EUT was placed on a turn table which is 0.8m above ground plane.
- 2 The EUT was modulated by 2.5 KHz Sine wave audio signal; the level of the audio signal employed is 16 dB greater than that necessary to produce 50% of rated system deviation. Rated system deviation is 2.5 kHz (12.5 kHz channel spacing) and 5 kHz (25 kHz channel spacing).
- 3 Set EUT as normal operation.
- 4 Set SPA Center Frequency = fundamental frequency, RBW=300Hz, VBW= 3 KHz, span =50 KHz.
- 5 Set SPA Max hold. Mark peak, Set 99% Occupied Bandwidth and 26dB Occupied Bandwidth.
- 6 Set SPA Center Frequency=fundamental frequency, set =100Hz, VBW=1 KHz, span=50 KHz for 12.5 channel spacing.

**TEST RESULTS**

**4.2.1 Occupied Bandwidth**

Band	Channel Separation	Test Channel	Test Frequency	99% Occupied Bandwidth	26dB Occupied Band width
VHF	12.5KHz	Low	136.5000 MHz	5.60 KHz	10.40 KHz
		Middle	155.5000 MHz	5.70 KHz	10.50 KHz
		High	173.5000 MHz	5.90 KHz	10.50 KHz
UHF	12.5KHz	Low	400.5000 MHz	5.90 KHz	10.50 KHz
		Middle	440.5000 MHz	5.80 KHz	10.50 KHz
		High	479.5000 MHz	5.90 KHz	10.50 KHz
Limit		11.25KHz for 12.5KHz Channel Separation			
Test Results		Compliance			

**Plots of 99% and 26dB Bandwidth Measurement**

Modulation Type	Channel Separation	Freq.(MHz)	99% Bandwidth (KHz)	26dB Bandwidth (KHz)	FCC Limit (KHz)	Results
FM	12.5 KHz	136.5000	5.60	10.40	11.25	Compliance

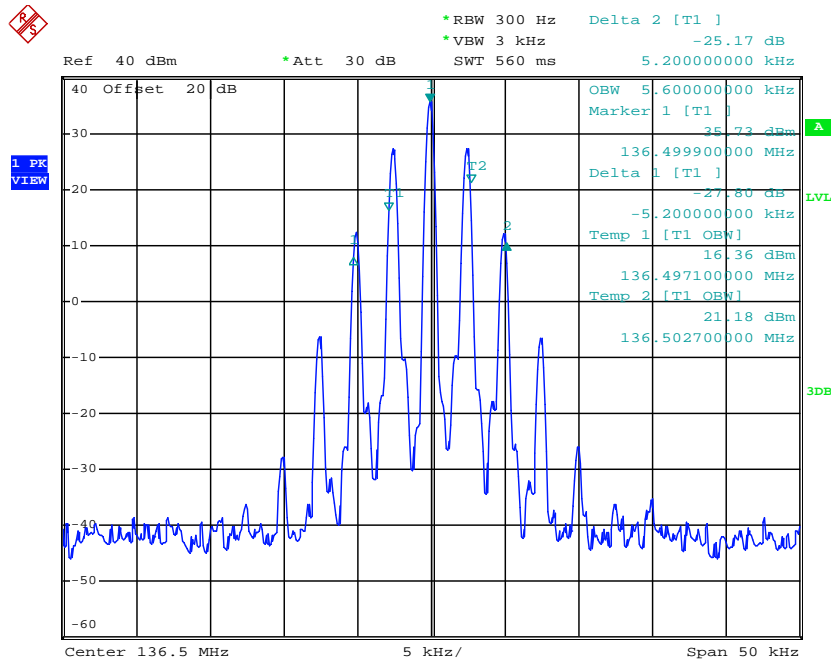

Date: 20.DEC.2012 13:59:05

Modulation Type	Channel Separation	Freq.(MHz)	99% Bandwidth (KHz)	26dB Bandwidth (KHz)	FCC Limit (KHz)	Results
FM	12.5 KHz	155.5000	5.70	10.50	11.25	Compliance

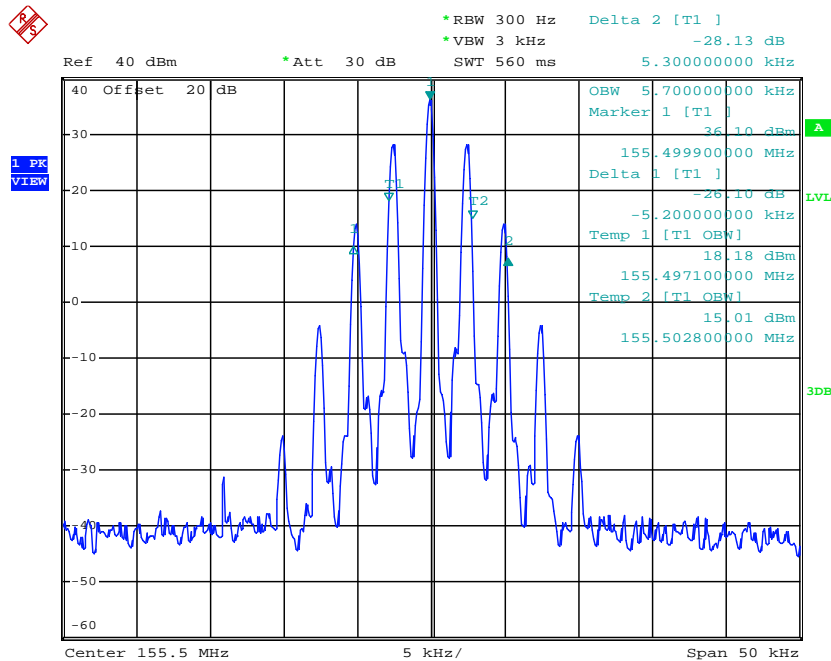

Date: 20.DEC.2012 13:53:03

Modulation Type	Channel Separation	Freq.(MHz)	99% Bandwidth (KHz)	26dB Bandwidth (KHz)	FCC Limit (KHz)	Results
FM	12.5 KHz	173.5000	5.90	10.50	11.25	Compliance

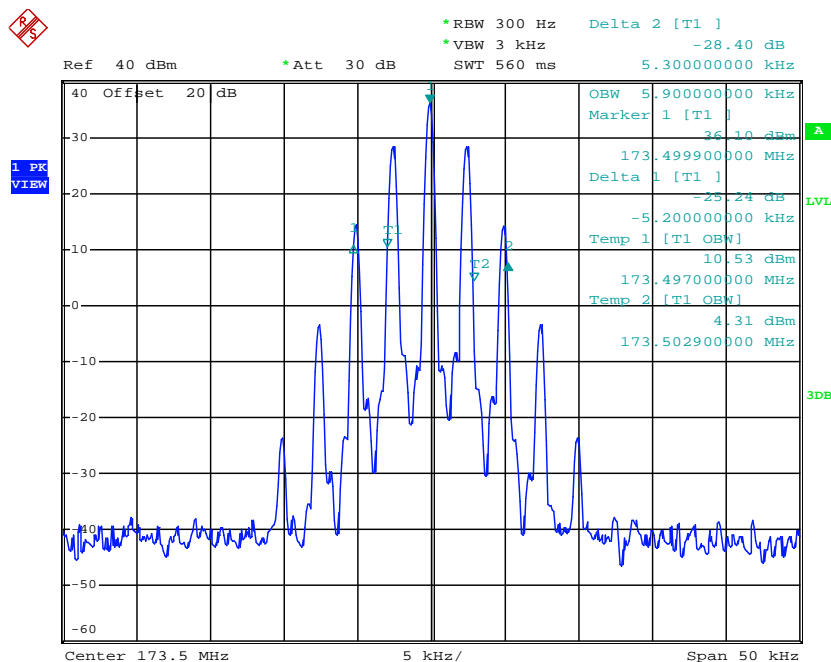

Date: 20.DEC.2012 13:55:09

Modulation Type	Channel Separation	Freq.(MHz)	99% Bandwidth (KHz)	26dB Bandwidth (KHz)	FCC Limit (KHz)	Results
FM	12.5 KHz	400.5000	5.90	10.50	11.25	Compliance

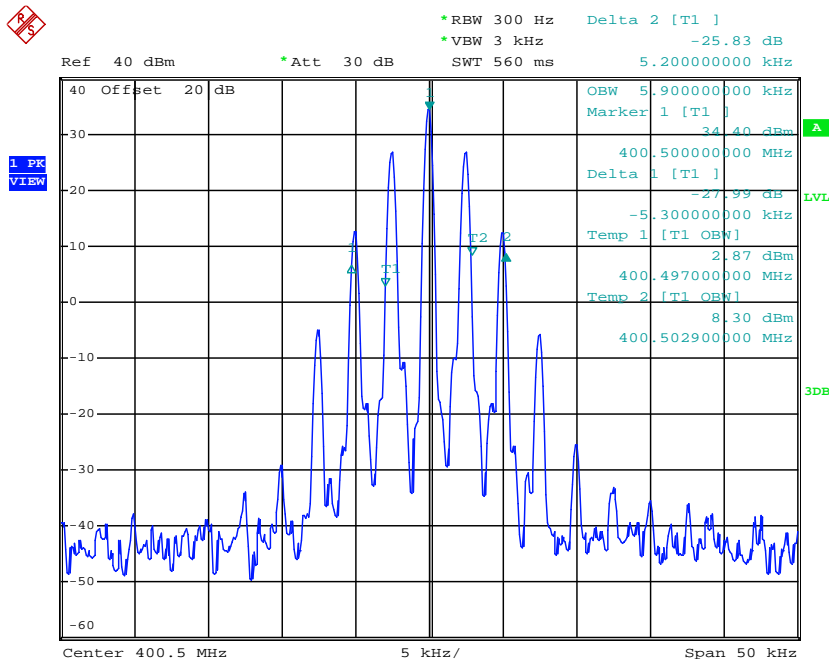

Date: 20.DEC.2012 13:58:24

Modulation Type	Channel Separation	Freq.(MHz)	99% Bandwidth (KHz)	26dB Bandwidth (KHz)	FCC Limit (KHz)	Results
FM	12.5 KHz	440.5000	5.80	10.50	11.25	Compliance

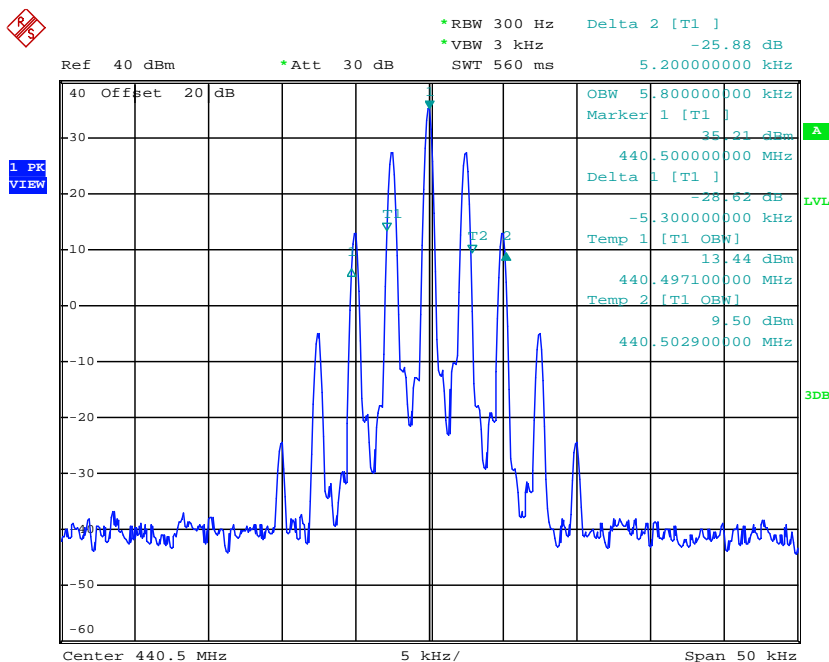

Date: 20.DEC.2012 13:52:08

Modulation Type	Channel Separation	Freq.(MHz)	99% Bandwidth (KHz)	26dB Bandwidth (KHz)	FCC Limit (KHz)	Results
FM	12.5 KHz	479.5000	5.90	10.50	11.25	Compliance

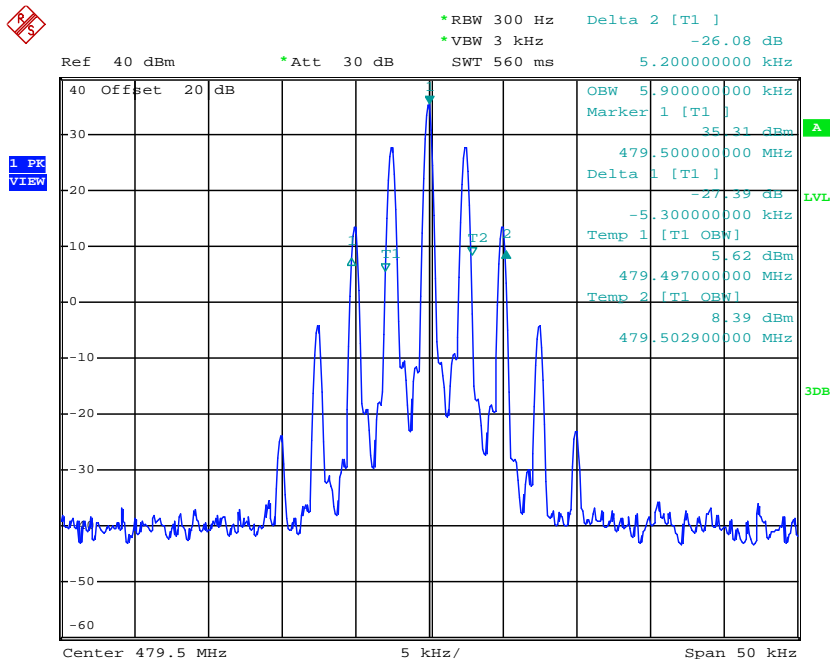

Date: 20.DEC.2012 13:54:26

**4.2.2 Emission Mask**

Modulation Type	Channel Separation	Test Channel	Test Frequency	FCC Applicable Mask	RBW
FM	12.5KHz	Low	136.5000 MHz	D	100 Hz
		Middle	155.5000 MHz	D	100 Hz
		High	173.5000 MHz	D	100 Hz
	12.5KHz	Low	400.5000 MHz	D	100 Hz
		Middle	440.5000 MHz	D	100 Hz
		High	479.5000 MHz	D	100 Hz
Test Results		Compliance			

**Plots of Emission Mask Measurement**

Referred as the attached plot hereinafter

Note: The Blue curve represents unmodulated signal.

The Black curve represents modulated signal.

Modulation Type	Channel Separation	Freq.(MHz)	FCC Applicable Mask	RBW	Audio Freq. (KHz)	Results
FM	12.5 KHz	136.5000	D	100	2.5	Compliance



Ref 40 dBm      \*Att 30 dB      SWT 6 s      Marker 1 [T1 ]      36.92 dBm  
136.499900000 MHz

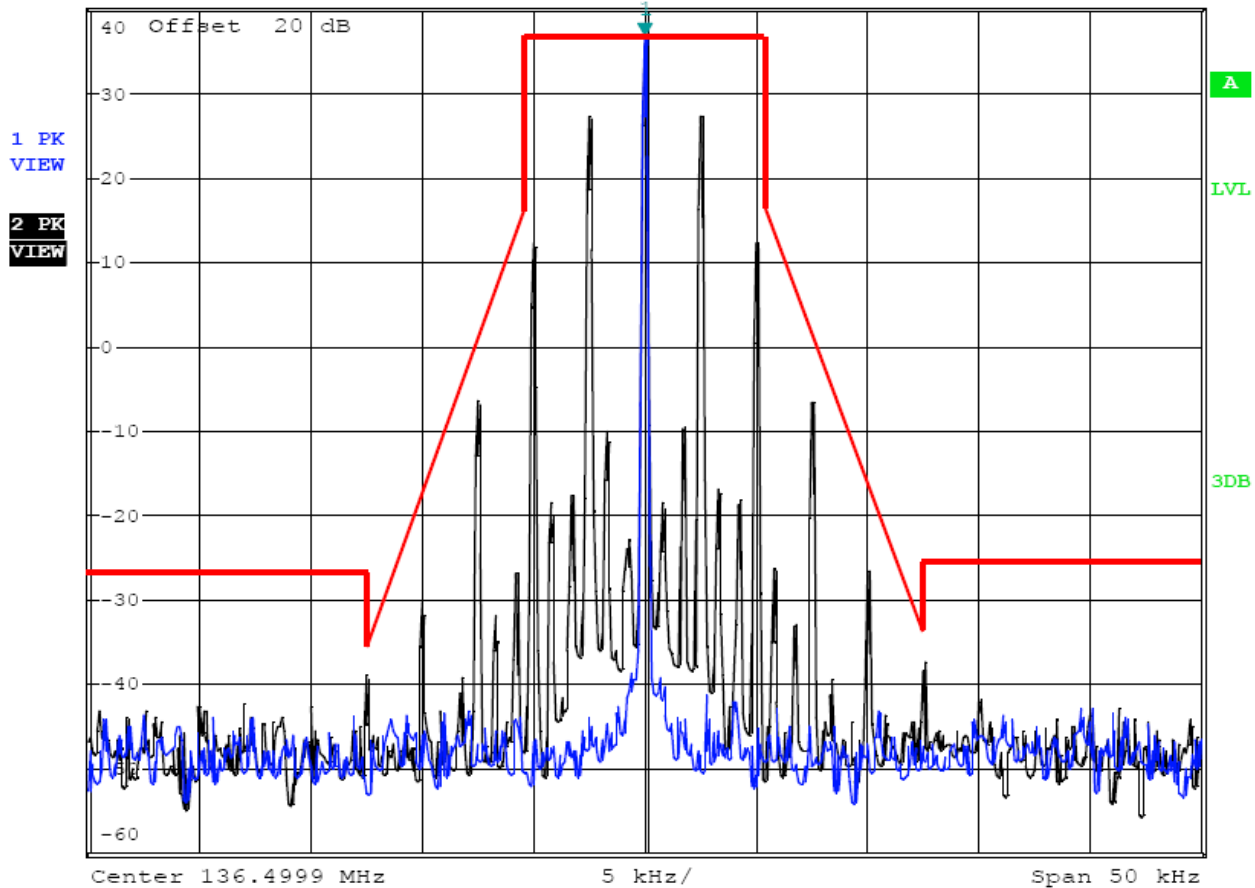

Date: 19.DEC.2012 16:17:19

12.5 kHz Channel Spacing, 136.5000 MHz, 2500 Hz Audio Modulation Only

Modulation Type	Channel Separation	Freq.(MHz)	FCC Applicable Mask	RBW	Audio Freq. (KHz)	Results
FM	12.5 KHz	155.5000	D	100Hz	2.5	Compliance

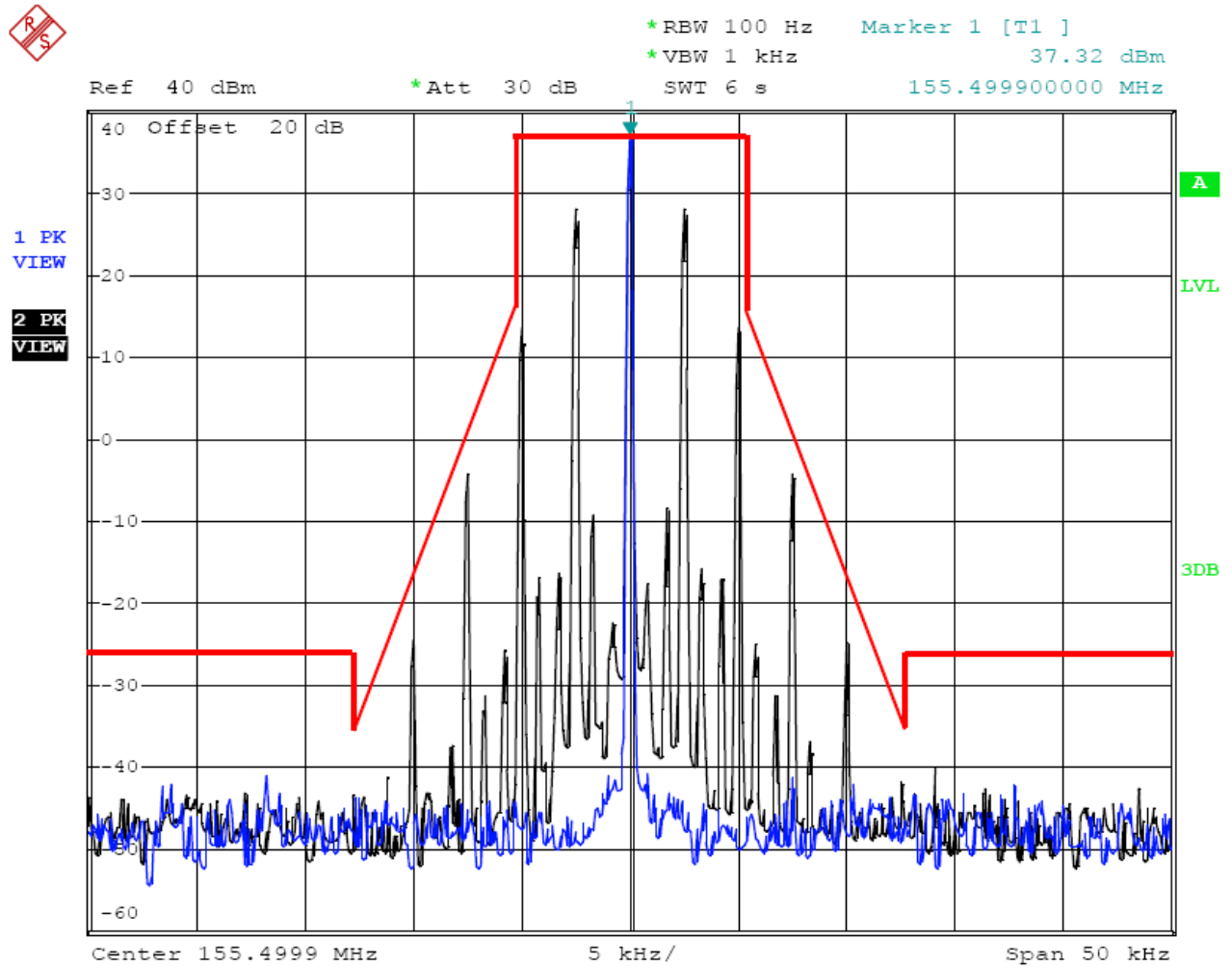

Date: 19.DEC.2012 16:31:14

12.5 kHz Channel Spacing, 155.5000 MHz, 2500 Hz Audio Modulation Only



Modulation Type	Channel Separation	Freq.(MHz)	FCC Applicable Mask	RBW	Audio Freq. (KHz)	Results
FM	12.5 KHz	173.5000	D	100Hz	2.5	Compliance

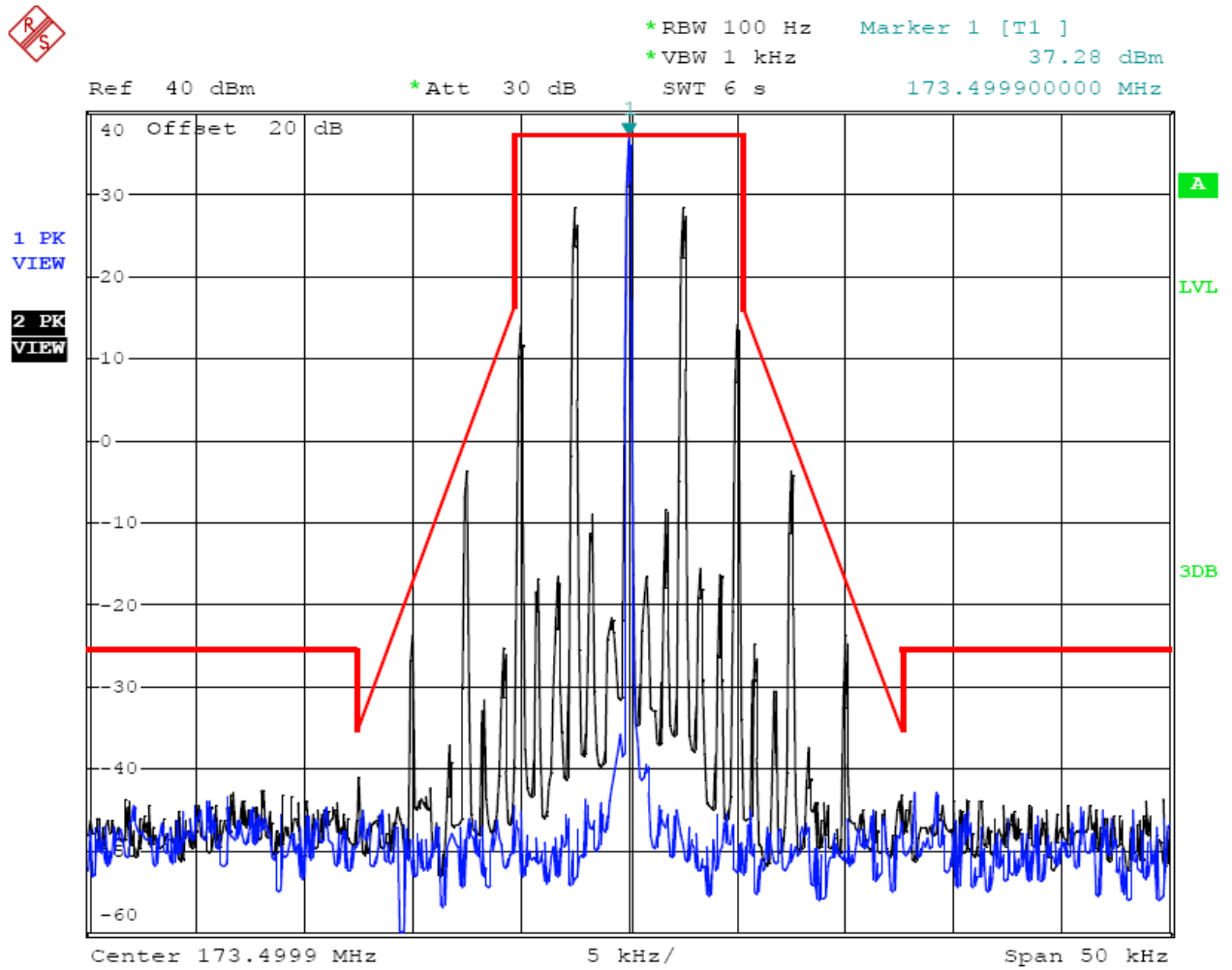

Date: 19.DEC.2012 16:23:41

12.5 kHz Channel Spacing, 173.5000 MHz, 2500 Hz Audio Modulation Only

Modulation Type	Channel Separation	Freq.(MHz)	FCC Applicable Mask	RBW	Audio Freq. (KHz)	Results
FM	12.5 KHz	400.5000	D	100Hz	2.5	Compliance



Ref 40 dBm      \*Att 30 dB      SWT 6 s      400.50000000 MHz  
\*RBW 100 Hz      Marker 1 [T1]      35.86 dBm  
\*VBW 1 kHz

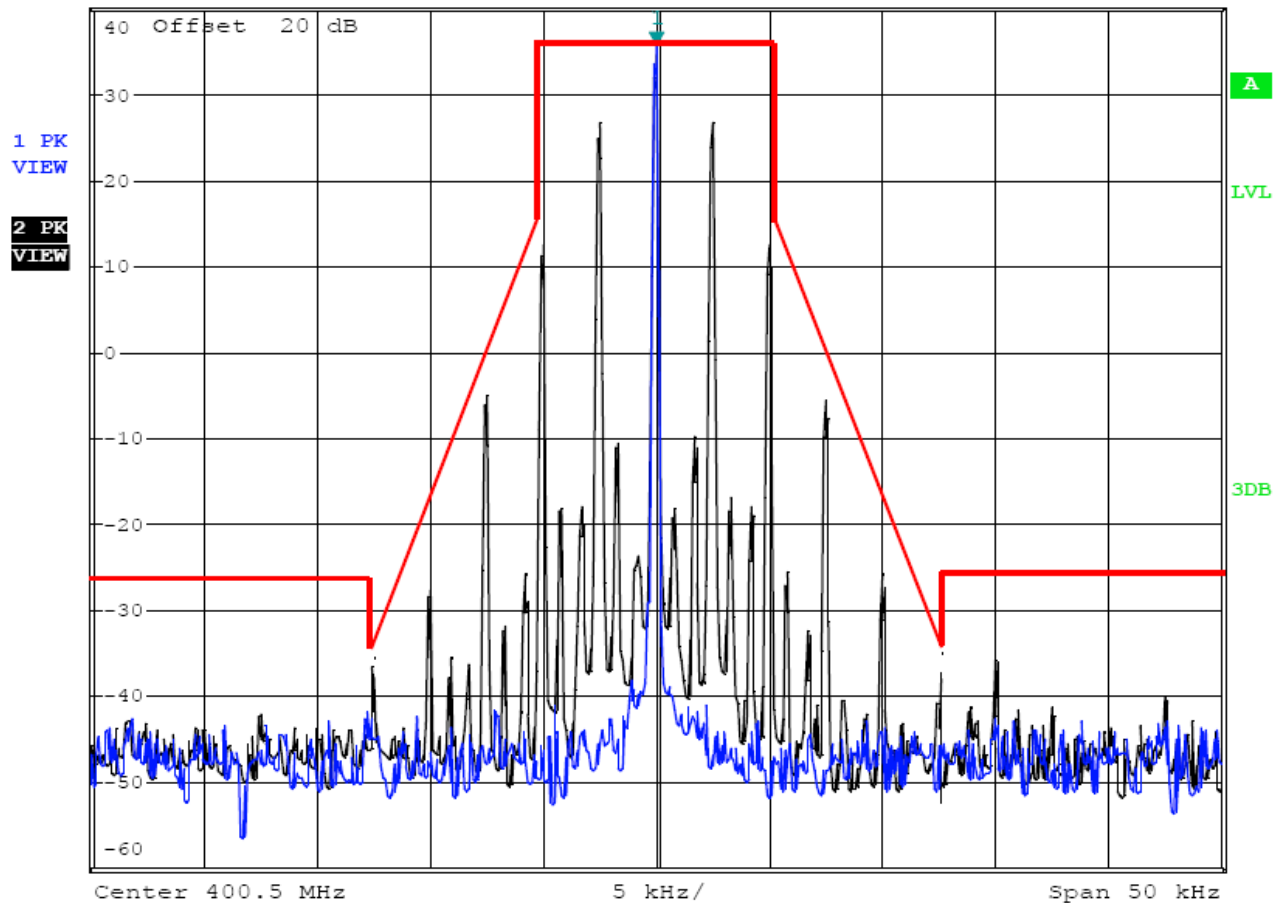

Date: 19.DEC.2012 16:18:44

12.5 kHz Channel Spacing, 400.5000 MHz, 2500 Hz Audio Modulation Only

Modulation Type	Channel Separation	Freq.(MHz)	FCC Applicable Mask	RBW	Audio Freq. (KHz)	Results
FM	12.5 KHz	440.5000	D	100Hz	2.5	Compliance

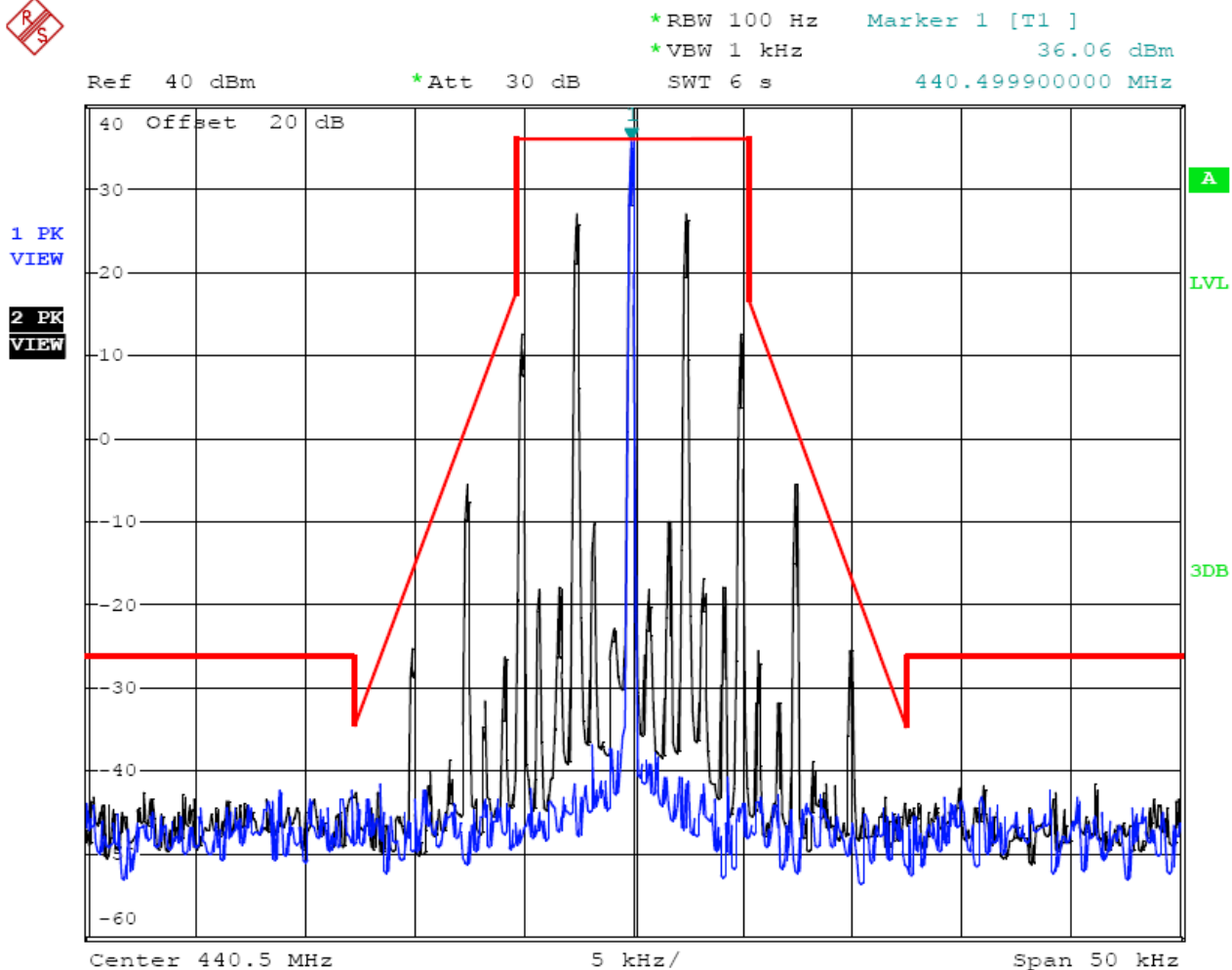

Date: 19.DEC.2012 16:41:11

12.5 kHz Channel Spacing, 440.5000 MHz, 2500 Hz Audio Modulation Only

Modulation Type	Channel Separation	Freq.(MHz)	FCC Applicable Mask	RBW	Audio Freq. (KHz)	Results
FM	12.5 KHz	479.5000	D	100Hz	2.5	Compliance



Ref 40 dBm      \*Att 30 dB      SWT 6 s      479.50000000 MHz  
\*RBW 100 Hz      Marker 1 [T1]      36.37 dBm  
\*VBW 1 kHz

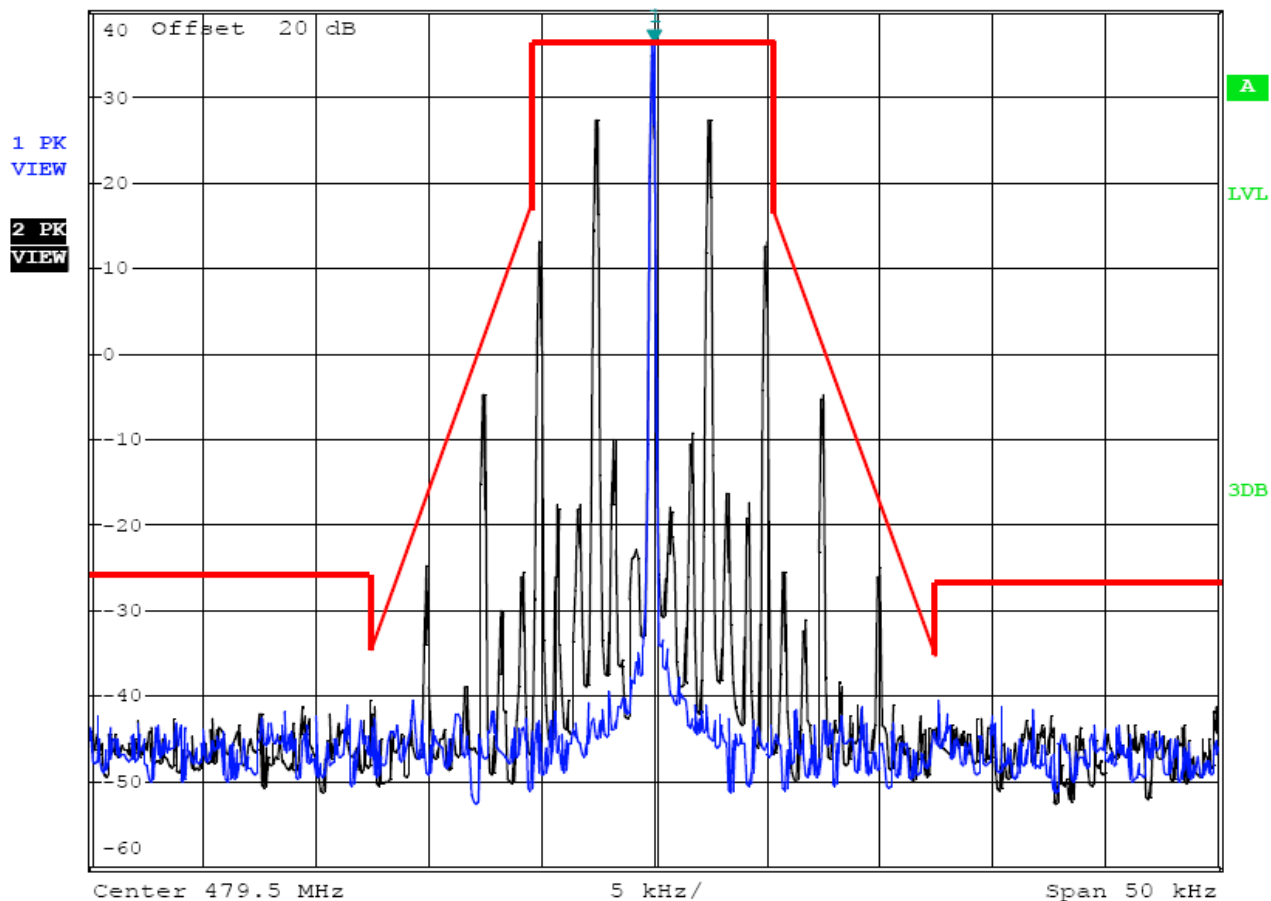

Date: 19.DEC.2012 16:27:27

12.5 kHz Channel Spacing, 479.5000 MHz, 2500 Hz Audio Modulation Only

### 4.3. Transmitter Radiated Spurious Emission

#### TEST APPLICABLE

According to the TIA/EIA 603 test method, and according to Section 90.210, the power of each unwanted emission shall be less than Transmitted Power as specified below for transmitters designed to operate with 12.5 KHz channel bandwidth:

- 1 On any frequency removed from the center of the authorized bandwidth  $f_0$  to 5.625 KHz removed from  $f_0$ : Zero dB
  - 2 On any frequency removed from the center of the authorized bandwidth by a displacement frequency ( $f_d$  in KHz)  $f_0$  of more than 5.625 KHz but no more than 12.5 KHz: At least 7.27dB
  - 3 On any frequency removed from the center of the authorized bandwidth by a displacement frequency ( $f_d$  in KHz)  $f_0$  of more than 12.5 KHz: At least  $50+10 \log (P)$  dB or 70 dB, which ever is lesser attenuation.
- For transmitters designed to transmit with 25 KHz channel separation and equipped with an audio low-pass filter, the power of any emission must be attenuated below the unmodulated carrier power (P) as following:

- 1 On any frequency removed from the assigned frequency by more than 50 percent, but no more than 100 percent of the authorized bandwidth: At least 25 dB.
- 2 On any frequency removed from the assigned frequency by more than 100 percent, but no more than 250 percent of the authorized bandwidth: At least 35 dB.
- 3 On any frequency removed from the assigned frequency by more than 250 percent of the authorized bandwidth: At least  $43+10\log (P)$  dB.

#### TEST CONFIGURATION

Below 1GHz

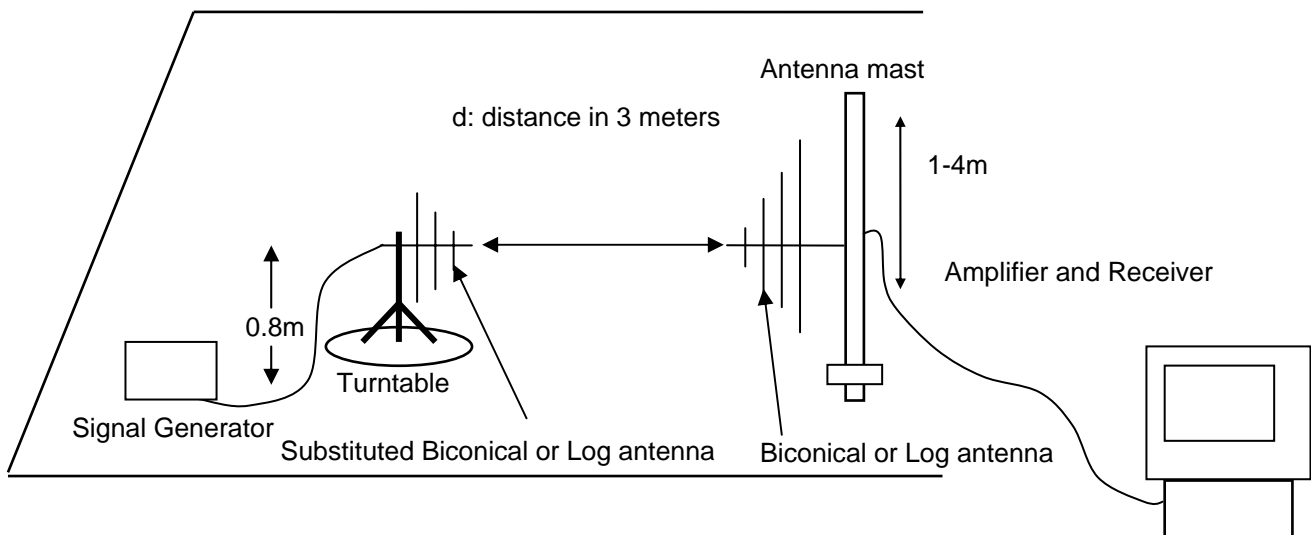
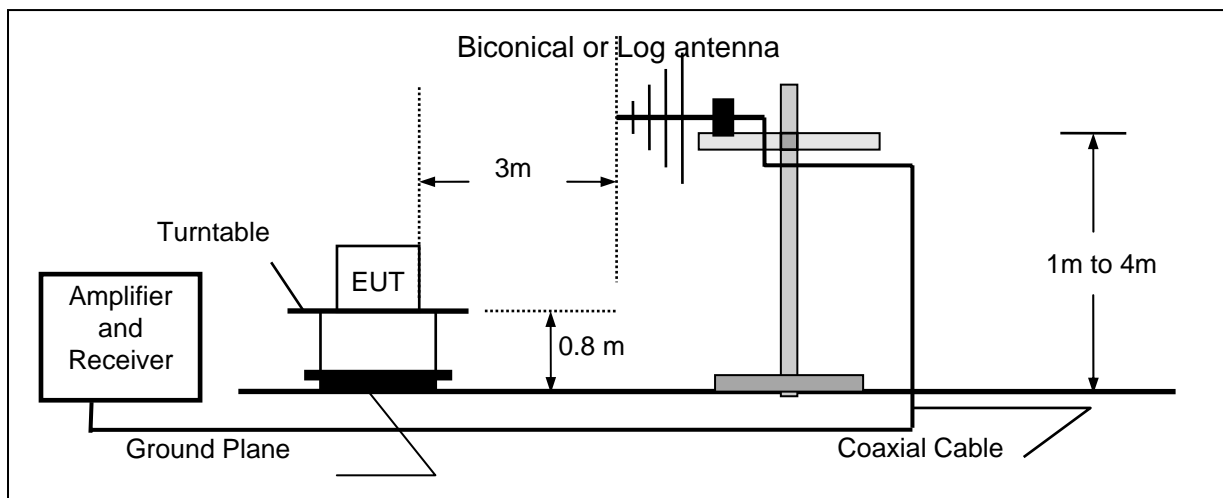

## Above 1GHz

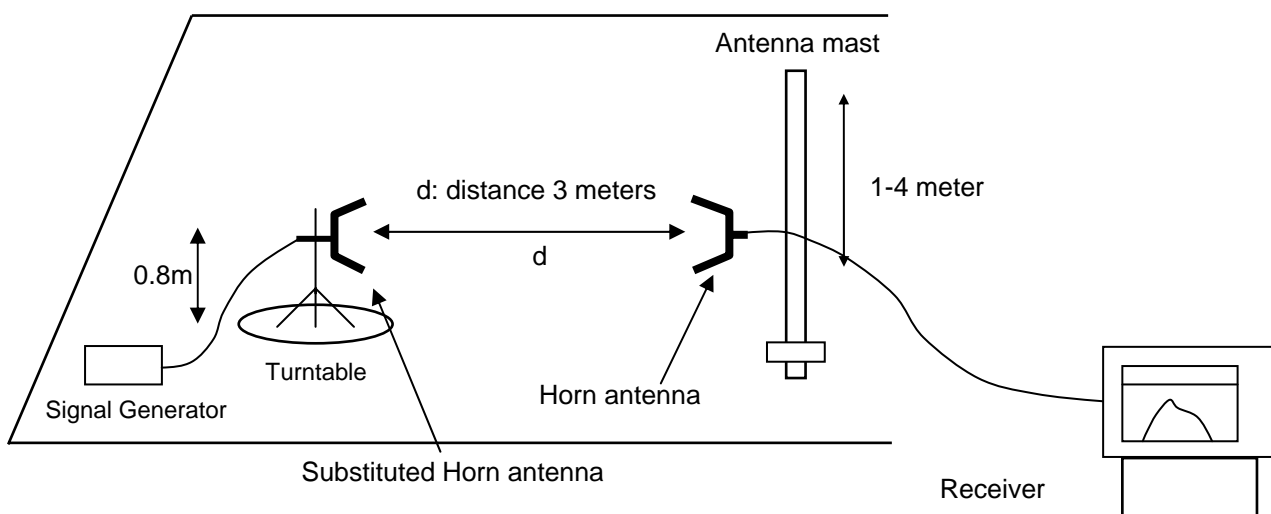
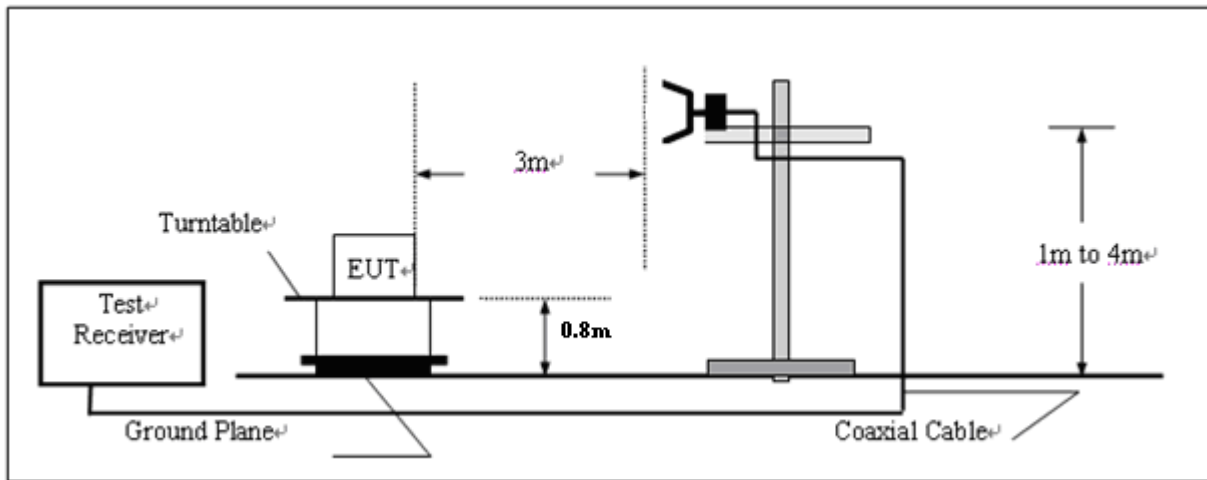
**TEST PROCEDURE**

- 1 Set the EMI Receiver (for measuring E-Field) and Receiver (for measuring EIRP) as follows:  
Center Frequency: equal to the signal source  
Resolution BW: 100 KHz  
Video BW: VBW > RBW  
Detector Mode: positive  
Average: off  
Span: 3 x the signal bandwidth
- 2 Load an appropriate correction factors file in EMI Receiver for correcting the field strength reading level  
Total Correction Factor recorded in the EMI Receiver = Cable Loss + Antenna Factor + Amplifier Gain  
 $E \text{ (dBuV/m)} = \text{Reading (dBuV)} + \text{Total Correction Factor (dB)}$
- 3 The transmitter under test was placed at the specified height on a non-conducting turntable (80 cm height)
- 4 Substitute the EUT by a signal generator and one of the following transmitting antenna (substitution antenna):  
DIPOLE antenna for frequency from 30-1000 MHz or  
HORN antenna for frequency above 1 GHz}.
- 5 Mount the transmitting antenna at 1.0 meter high from the ground plane.
- 6 Use one of the following antenna as a receiving antenna:  
DIPOLE antenna for frequency from 30-1000 MHz or  
HORN antenna for frequency above 1 GHz}.
- 7 If the DIPOLE antenna is used, tune its elements to the frequency as specified in the calibration manual.
- 8 Adjust both transmitting and receiving antenna in a VERTICAL polarization.
- 9 Tune the EMI Receivers to the test frequency.
- 10 Lower or raise the test antenna from 1 to 4 meters until the maximum signal level was detected.

- 11 The transmitter was rotated through 360o about a vertical axis until a higher maximum signal was received.
- 12 Lower or raise the test antenna from 1 to 4 meters until the maximum signal level was detected.
- 13 Adjust input signal to the substitution antenna until an equal or a known related level to that detected from the transmitter was obtained in the test receiver.
- 14 Record the power level read from the Average Power Meter and calculate the ERP/EIRP as follows:  

$$P = P_1 - L_1 = (P_2 + L_2) - L_1 = P_3 + A + L_2 - L_1$$

$$\text{EIRP} = P + G_1 = P_3 + L_2 - L_1 + A + G_1$$

$$\text{ERP} = \text{EIRP} - 2.15 \text{ dB}$$

$$\text{Total Correction factor in EMI Receiver} = L_2 - L_1 + G_1$$
- Where:  
 P: Actual RF Power fed into the substitution antenna port after corrected.  
 P<sub>1</sub>: Power output from the signal generator  
 P<sub>2</sub>: Power measured at attenuator A input  
 P<sub>3</sub>: Power reading on the Average Power Meter  
 EIRP: EIRP after correction  
 ERP: ERP after correction
- 15 Adjust both transmitting and receiving antenna in a Horizontal polarization, then repeat step (11) to (14).
- 16 Repeat step (4) to (16) for different test frequency
- 17 Repeat steps (3) to (12) with the substitution antenna oriented in horizontal polarization.
- 18 Actual gain of the EUT's antenna is the difference of the measured EIRP and measured RF power at the RF port. Correct the antenna gain if necessary.

## TEST RESULTS

The Transmitter Radiated Spurious Emssion was performed to the Rated high power (5Watt) and Rated low power (1Watt) the datum that reported below is the worst case (Rated high power) of the two rated power conditions.

### **Modulation Type: FM**

FCC Part 22.359, 74.462, 80.211 and 90.210 and RSS Gen, RSS 119 Issue 11 (12.5 kHz bandwidth only): On any frequency removed from the center of the authorized bandwidth by a displacement frequency (f d in kHz) of more than 12.5 kHz at least:

Low:  $50 + 10 \log (\text{Pwatts}) = 50 + 10 \log (5.395) = 57.32 \text{ dB}$

High:  $50 + 10 \log (\text{Pwatts}) = 50 + 10 \log (3.999) = 56.02 \text{ dB}$

Note: In general, the worse case attenuation requirement shown above was applied.

Calculation: Limit (dBm) = EL-50-10log10 (TP)

Notes: EL is the emission level of the Output Power expressed in dBm,

In this application, the EL is 37.32 dBm.

Limit (dBm) = 37.32-50-10log10 (57.32) = -20 dBm

Note: 1. In general, the worse case attenuation requirement shown above was applied.

2. The measurement frequency range from 30 MHz to 4 GHz.

3. \*\*\* means that the emission level is too low to be measured or at least 20 dB down than the limit.

Modulation		FM		Channel Separation		12.5KHz		
Test Channel		Low Channel		Test Frequency		136.5000 MHz		
Frequency (MHz)	E-Field Level (dBuV/m)	EMI Detector (Peak/QP)	Antenna Polarization	Antenna Height (cm)	Table Angle (Degree)	ERP measured by Substitution Method (dBm)	Limit (dBm)	Margin (dB)
273.00	59.27	Peak	H	200	254	-38.73	-20	18.73
682.50	49.62	Peak	H	102	187	-43.95	-20	23.95
1228.50	46.62	Peak	H	100	265	-46.41	-20	26.41
...	...		H					
273.00	58.92	Peak	V	150	189	-38.08	-20	18.08
682.50	48.41	Peak	V	106	07	-43.85	-20	23.85
1228.50	45.62	Peak	V	120	310	-46.63	-20	26.63
...	...		V					

Modulation		FM		Channel Separation		12.5KHz		
Test Channel		Middle Channel		Test Frequency		155.5000 MHz		
Frequency (MHz)	E-Field Level (dBuV/m)	EMI Detector (Peak/QP)	Antenna Polarization	Antenna Height (cm)	Table Angle (Degree)	ERP measured by Substitution Method (dBm)	Limit (dBm)	Margin (dB)
311.00	59.55	Peak	H	100	312	-38.25	-20	18.25
466.50	52.12	Peak	H	125	85	-40.58	-20	20.58
1710.50	44.48	Peak	H	120	165	-48.96	-20	28.96
...	...		H					
311.00	59.19	Peak	V	100	45	-38.62	-20	18.62
466.50	50.63	Peak	V	100	123	-41.85	-20	21.85
1710.50	42.55	Peak	V	120	163	-49.63	-20	29.63
...	...		V					

Modulation		FM		Channel Separation		12.5KHz		
Test Channel		High Channel		Test Frequency		173.5000 MHz		
Frequency (MHz)	E-Field Level (dBuV/m)	EMI Detector (Peak/QP)	Antenna Polarization	Antenna Height (cm)	Table Angle (Degree)	ERP measured by Substitution Method (dBm)	Limit (dBm)	Margin (dB)
347.00	60.22	Peak	H	220	256	-37.85	-20	17.85
694.00	48.56	Peak	H	150	360	-43.62	-20	23.62
1561.50	43.45	Peak	H	210	112	-49.41	-20	29.41
...	...		H					
347.00	59.95	Peak	V	100	258	-38.25	-20	18.25
694.00	48.65	Peak	V	125	125	-44.52	-20	24.52
1561.50	43.48	Peak	V	150	352	-48.63	-20	28.63
...	...		V					



Modulation		FM		Channel Separation		12.5KHz		
Test Channel		Low Channel		Test Frequency		400.5000 MHz		
Frequency (MHz)	E-Field Level (dBuV/m)	EMI Detector (Peak/QP)	Antenna Polarization	Antenna Height (cm)	Table Angle (Degree)	ERP measured by Substitution Method (dBm)	Limit (dBm)	Margin (dB)
801.00	52.62	Peak	H	120	263	-43.51	-20	23.51
1201.50	48.14	Peak	H	200	212	-45.21	-20	25.21
1602.00	46.64	Peak	H	210	36	-46.48	-20	26.48
...	...		H					
801.00	54.02	Peak	V	110	321	-43.98	-20	23.98
1201.50	53.22	Peak	V	130	21	-42.52	-20	22.52
1602.00	45.53	Peak	V	150	105	-47.52	-20	27.52
...	...		V					

Modulation		FM		Channel Separation		12.5KHz		
Test Channel		Middle Channel		Test Frequency		440.5000 MHz		
Frequency (MHz)	E-Field Level (dBuV/m)	EMI Detector (Peak/QP)	Antenna Polarization	Antenna Height (cm)	Table Angle (Degree)	ERP measured by Substitution Method (dBm)	Limit (dBm)	Margin (dB)
881.00	52.80	Peak	H	250	145	-45.20	-20	25.20
1321.50	55.68	Peak	H	230	135	-42.34	-20	22.34
1762.00	45.24	Peak	H	110	265	-47.88	-20	27.88
...	...		H					
881.00	54.28	Peak	V	140	325	-43.72	-20	23.72
1321.50	50.38	Peak	V	145	254	-40.28	-20	20.28
1762.00	45.87	Peak	V	120	125	-46.14	-20	26.14
...	...		V					

Modulation		FM		Channel Separation		12.5KHz		
Test Channel		High Channel		Test Frequency		479.5000 MHz		
Frequency (MHz)	E-Field Level (dBuV/m)	EMI Detector (Peak/QP)	Antenna Polarization	Antenna Height (cm)	Table Angle (Degree)	ERP measured by Substitution Method (dBm)	Limit (dBm)	Margin (dB)
959.00	55.30	Peak	H	212	100	-42.52	-20	22.52
1438.50	53.10	Peak	H	112	120	-40.62	-20	20.62
1918.00	47.20	Peak	H	121	126	-45.45	-20	25.45
...	...		H					
959.00	54.09	Peak	V	161	147	-43.63	-20	23.63
1438.50	52.96	Peak	V	111	200	-40.41	-20	20.41
1918.00	45.47	Peak	V	120	155	-47.55	-20	27.55
...	...		V					

#### 4.4. Spurious Emission on Antenna Port

##### TEST APPLICABLE

The same as Section 4.3

##### TEST PROCEDURE

The RF output of the EUT was connected to a spectrum analyzer through appropriate attenuation. The resolution bandwidth of the spectrum analyzer was set to 100 kHz. Sufficient scans were taken to show any out of band emission up to 10th. Harmonic for the lower and the highest frequency range. Set RBW 100 kHz, VBW 300 kHz in the frequency band 30MHz to 1GHz, while set RBW=1MHz. VBW=3MHz from the 1GHz to 10<sup>th</sup> Harmonic.

The audio input was set to 0 to get the unmodulated carrier, the resulting picture is print out for each channel separation.

##### TEST CONFIGURATION

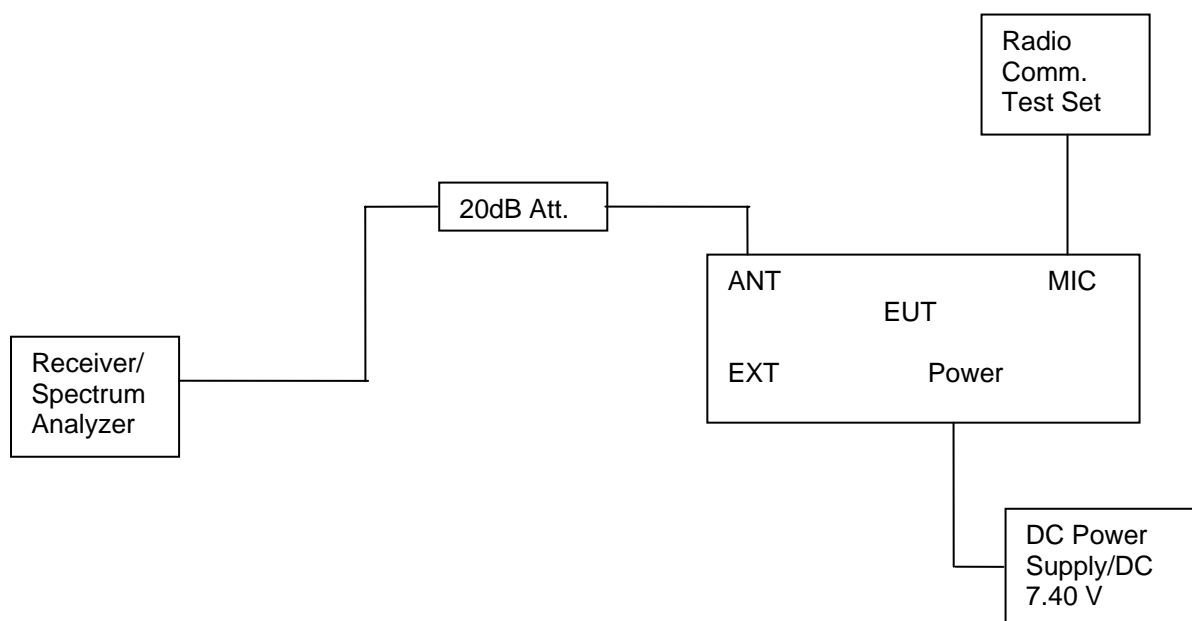

##### TEST RESULTS

###### Modulation Type: FM

FCC Part 22.359, 74.462, 80.211 and 90.210 and RSS Gen, RSS 119 Issue 11 (12.5 kHz bandwidth only): On any frequency removed from the center of the authorized bandwidth by a displacement frequency (f d in kHz) of more than 12.5 kHz at least:

Low:  $50 + 10 \log (P_{\text{watts}}) = 50 + 10 \log (5.395) = 57.32 \text{ dB}$

High:  $50 + 10 \log (P_{\text{watts}}) = 50 + 10 \log (3.999) = 56.02 \text{ dB}$

Note: In general, the worse case attenuation requirement shown above was applied.

Calculation: Limit (dBm) = EL-50-10log<sub>10</sub> (TP)

Notes: EL is the emission level of the Output Power expressed in dBm,  
In this application, the EL is 37.32 dBm.

Limit (dBm) = 37.32-50-10log<sub>10</sub> (57.32) = -20 dBm

Note: 1. In general, the worse case attenuation requirement shown above was applied.

2. The measurement frequency range from 30MHz to 6 GHz.

**For Rated High Power (5Watt)**

Modulation Type	Channel Separation	Test Channel	Test Frequency (MHz)	Maximum Conducted Spurious Emissions Below 1GHz		Maximum Conducted Spurious Emissions Above 1GHz	
				Frequency (MHz)	Datum (dBm)	Frequency (MHz)	Datum (dBm)
FM	12.5KHz	Low	136.5000	272.50	-27.68	3200.00	-35.62
		Middle	155.5000	311.30	-24.62	3170.00	-35.77
		High	173.5000	346.22	-22.77	3110.00	-35.34
Limit		-20dBm for 12.5KHz Channel Separation					
Test Results		Compliance					

**For Rated High Power (4Watt)**

Modulation Type	Channel Separation	Test Channel	Test Frequency (MHz)	Maximum Conducted Spurious Emissions Below 1GHz		Maximum Conducted Spurious Emissions Above 1GHz	
				Frequency (MHz)	Datum (dBm)	Frequency (MHz)	Datum (dBm)
FM	12.5KHz	Low	400.5000	802.12	-28.84	3190.00	-34.98
		Middle	440.5000	881.66	-31.23	1320.00	-25.91
		High	479.5000	959.26	-25.09	1440.00	-25.84
Limit		-20dBm for 12.5KHz Channel Separation					
Test Results		Compliance					

**For Rated Low Power (1Watt)**

Modulation Type	Channel Separation	Test Channel	Test Frequency (MHz)	Maximum Conducted Spurious Emissions Below 1GHz		Maximum Conducted Spurious Emissions Above 1GHz	
				Frequency (MHz)	Datum (dBm)	Frequency (MHz)	Datum (dBm)
FM	12.5KHz	Low	136.5000	286.08	-28.82	3150.00	-35.16
		Middle	155.5000	311.30	-30.79	3160.00	-35.34
		High	173.5000	346.22	-31.21	3160.00	-35.79
		Low	400.5000	802.12	-28.67	3230.00	-35.10
		Middle	440.5000	881.66	-31.46	1320.00	-40.28
		High	479.5000	959.26	-29.84	1440.00	-39.70
Limit		-20dBm for 12.5KHz Channel Separation					
Test Results		Compliance					

**Plots of Spurious Emission on Antenna Port Measurement****For Rated High Power**

Modulation Type	Channel SpARATION	Test Channel	Test Frequency (MHz)	Maximum Conducted Spurious Emissions Below 1GHz		Maximum Conducted Spurious Emissions Above 1GHz		FCC Limit
				Frequency (MHz)	Datum (dBm)	Frequency (MHz)	Datum (dBm)	
FM	12.5KHz	Low	136.5000	272.50	-27.68	3200.00	-35.62	-20dBm
Test Results				Compliance				

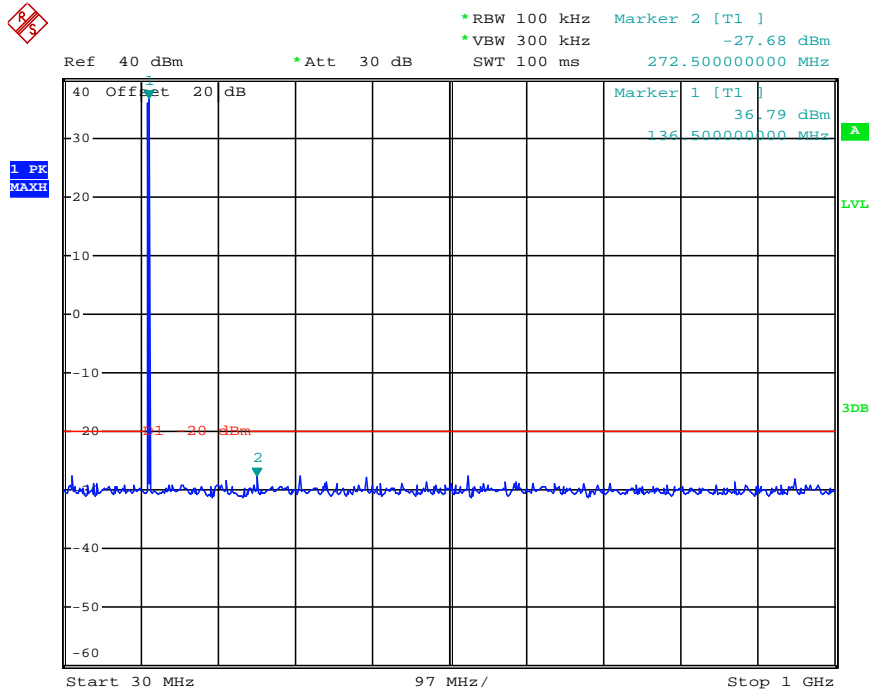

Date: 12.DEC.2012 09:58:48

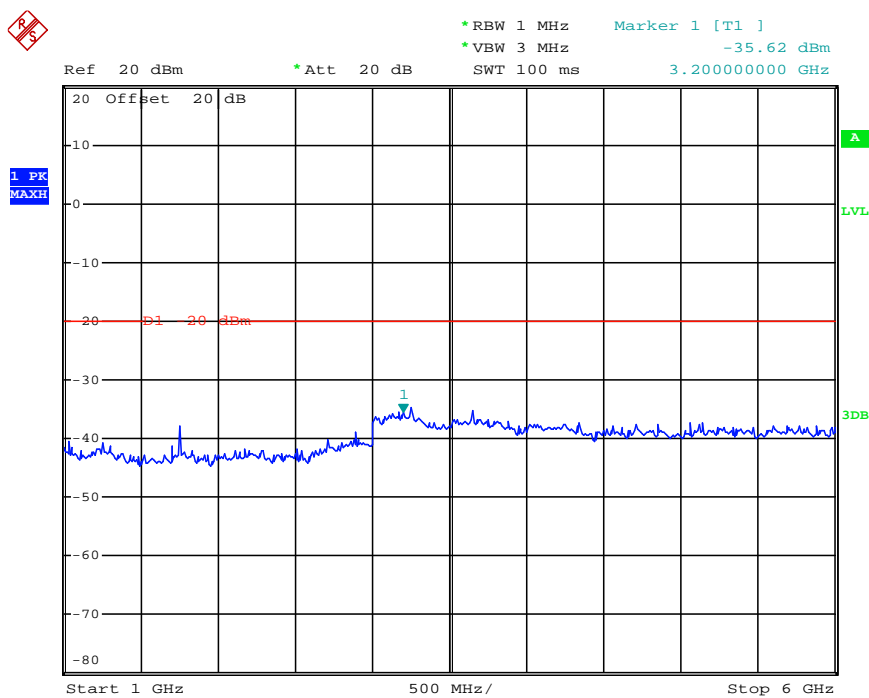

Date: 12.DEC.2012 10:13:56

Modulation Type	Channel SpARATION	Test Channel	Test Frequency (MHz)	Maximum Conducted Spurious Emissions Below 1GHz		Maximum Conducted Spurious Emissions Above 1GHz		FCC Limit
				Frequency (MHz)	Datum (dBm)	Frequency (MHz)	Datum (dBm)	
FM	12.5KHz	Middle	155.5000	311.30	-24.62	3170.00	-35.77	-20dBm
Test Results				Compliance				

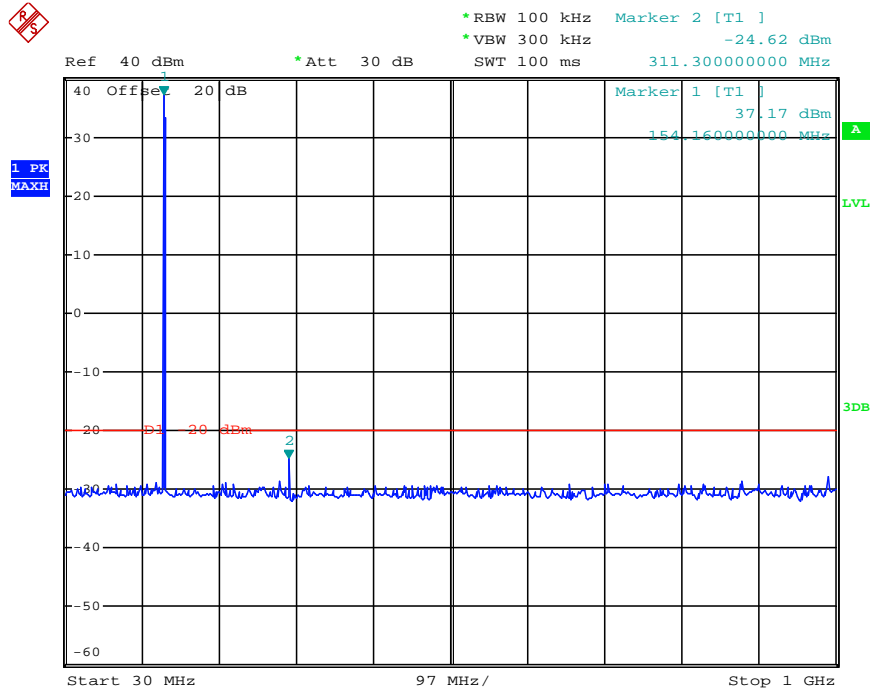

Date: 12.DEC.2012 10:32:07

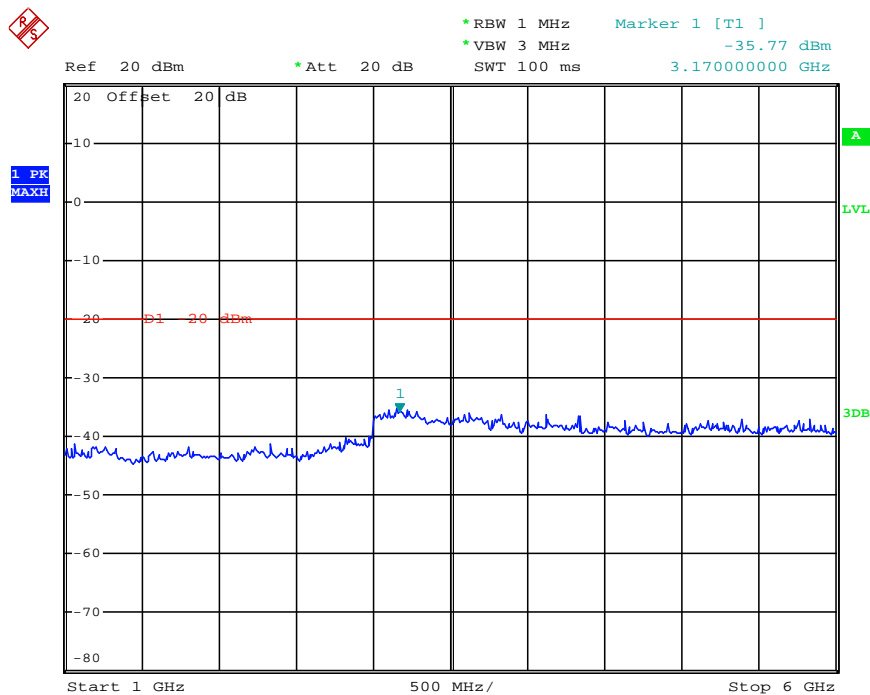

Date: 12.DEC.2012 10:29:41

Modulation Type	Channel SpARATION	Test Channel	Test Frequency (MHz)	Maximum Conducted Spurious Emissions Below 1GHz		Maximum Conducted Spurious Emissions Above 1GHz		FCC Limit
				Frequency (MHz)	Datum (dBm)	Frequency (MHz)	Datum (dBm)	
FM	12.5KHz	High	173.5000	346.22	-22.77	3110.00	-35.34	-20dBm
Test Results				Compliance				

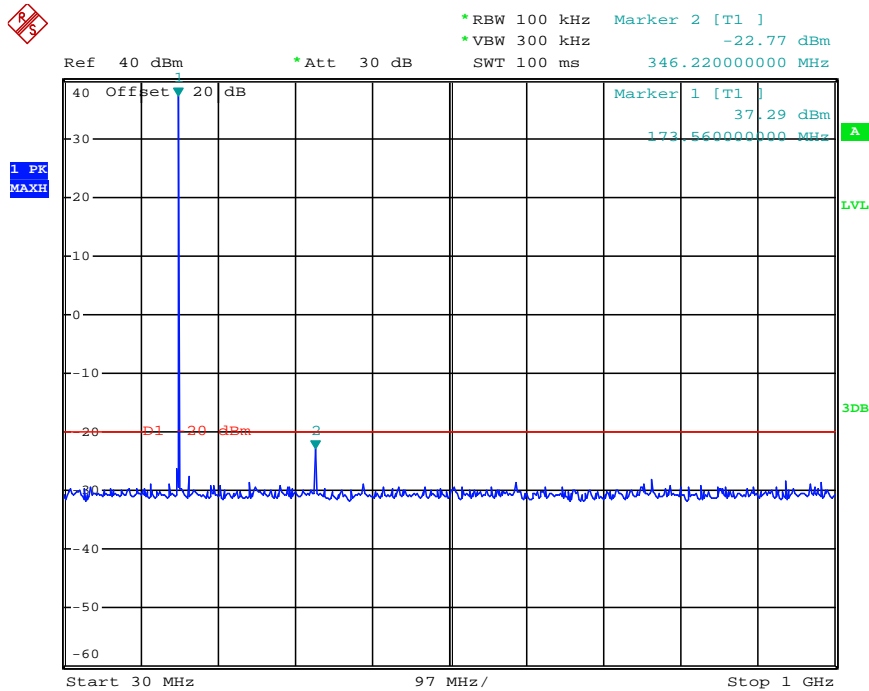

Date: 12.DEC.2012 10:22:42

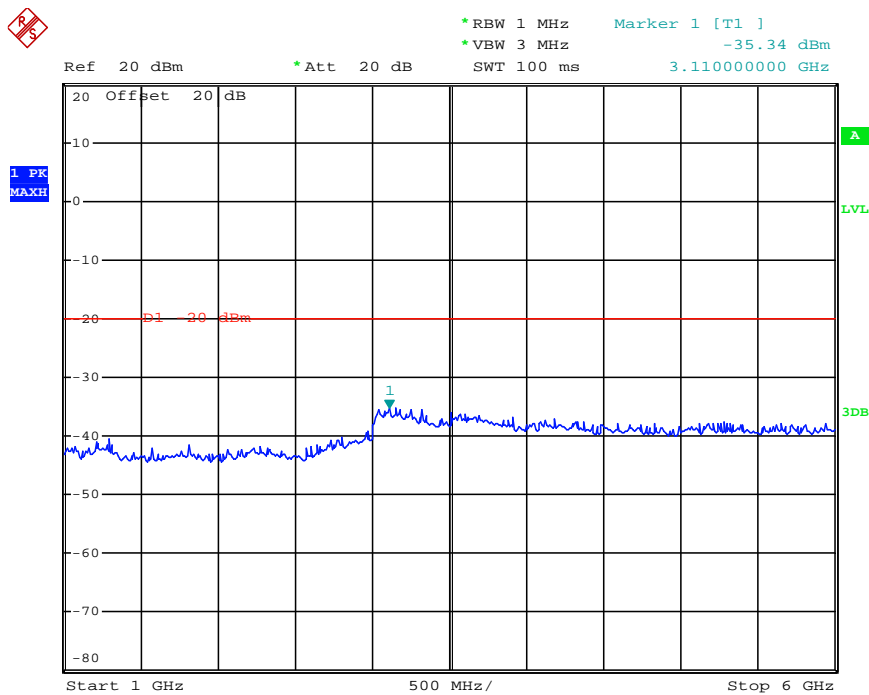

Date: 12.DEC.2012 10:26:27

Modulation Type	Channel SpARATION	Test Channel	Test Frequency (MHz)	Maximum Conducted Spurious Emissions Below 1GHz		Maximum Conducted Spurious Emissions Above 1GHz		FCC Limit
				Frequency (MHz)	Datum (dBm)	Frequency (MHz)	Datum (dBm)	
FM	12.5KHz	Low	400.5000	802.12	-28.84	3190.00	-34.98	-20dBm
Test Results				Compliance				

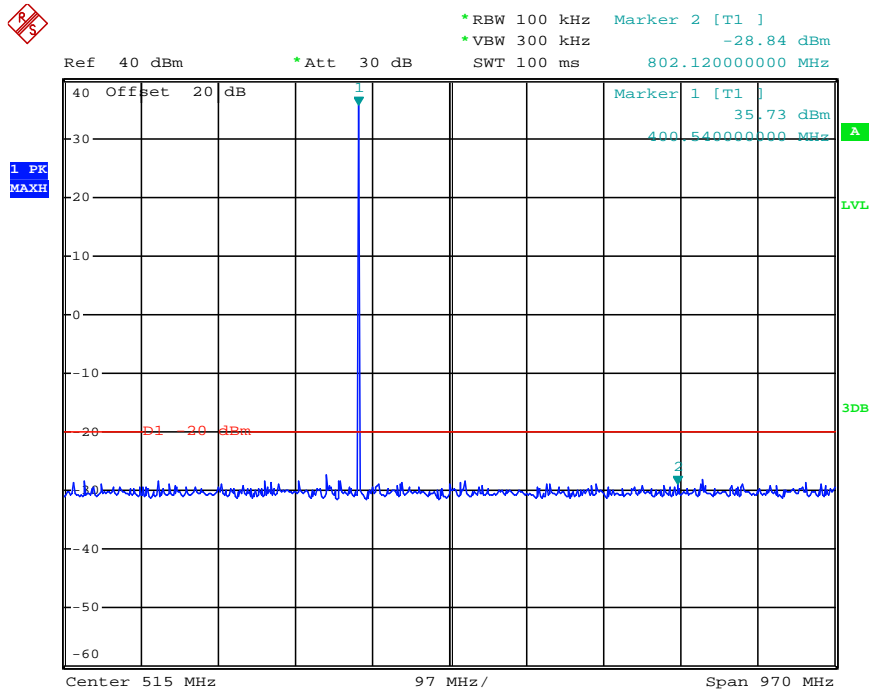

Date: 12.DEC.2012 10:09:11

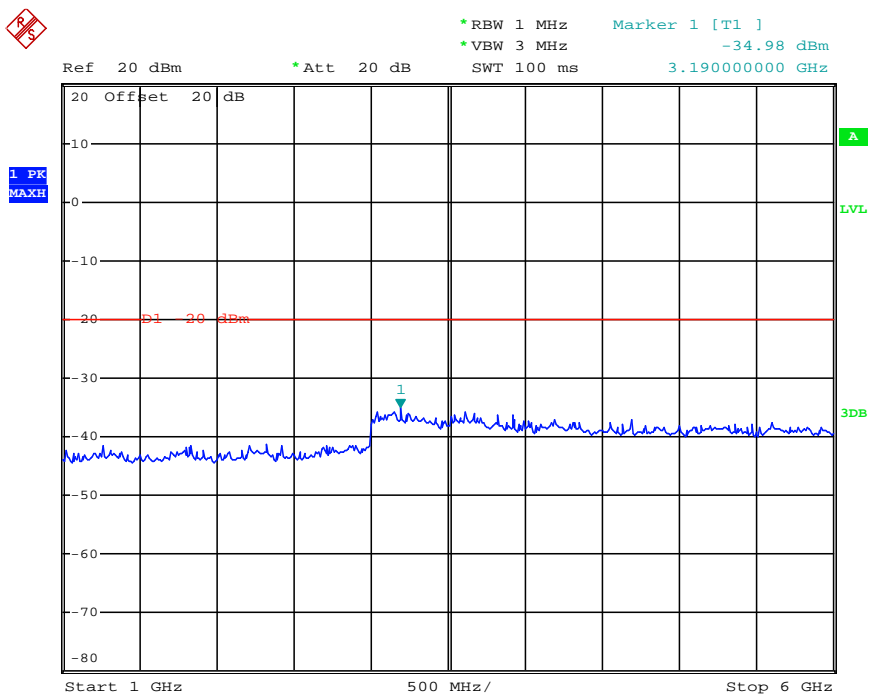

Date: 12.DEC.2012 10:13:31

Modulation Type	Channel SpARATION	Test Channel	Test Frequency (MHz)	Maximum Conducted Spurious Emissions Below 1GHz		Maximum Conducted Spurious Emissions Above 1GHz		FCC Limit
				Frequency (MHz)	Datum (dBm)	Frequency (MHz)	Datum (dBm)	
FM	12.5KHz	Middle	440.5000	881.66	-31.23	1320.00	-25.91	-20dBm
Test Results				Compliance				

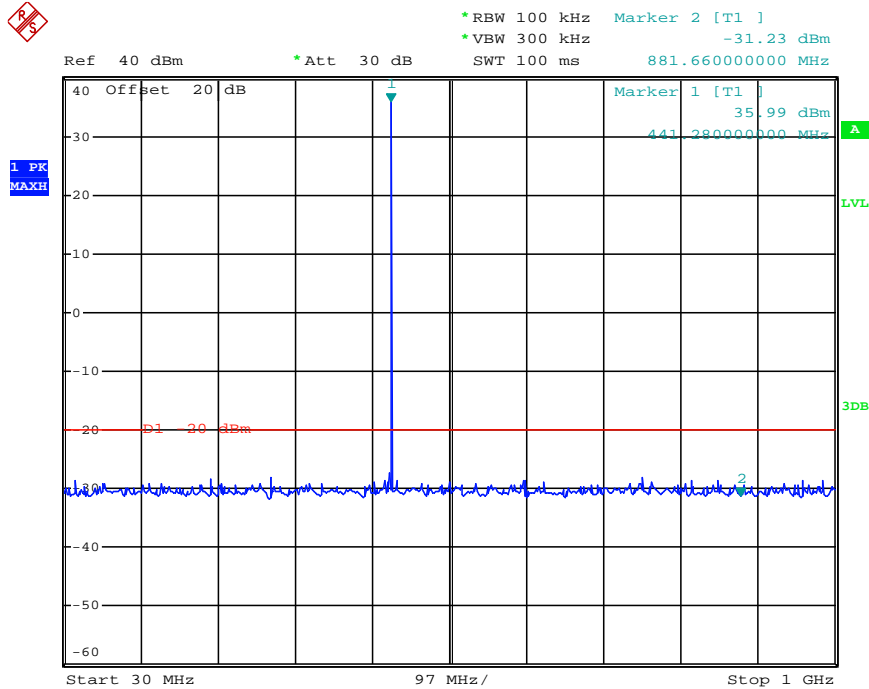

Date: 12.DEC.2012 10:33:37

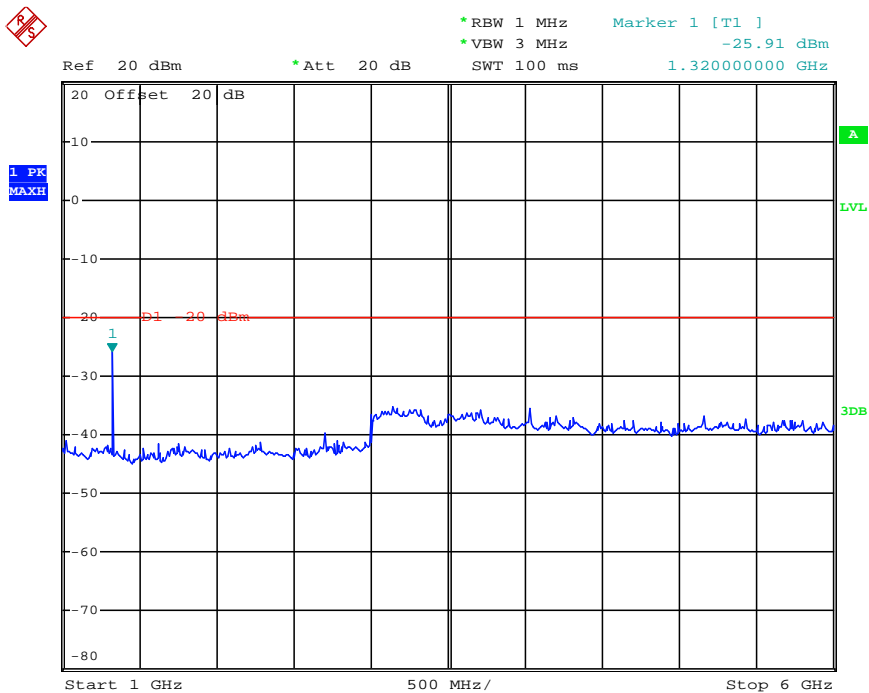

Date: 12.DEC.2012 10:28:08



Modulation Type	Channel SpARATION	Test Channel	Test Frequency (MHz)	Maximum Conducted Spurious Emissions Below 1GHz		Maximum Conducted Spurious Emissions Above 1GHz		FCC Limit
				Frequency (MHz)	Datum (dBm)	Frequency (MHz)	Datum (dBm)	
FM	12.5KHz	High	479.5000	959.26	-25.09	1440.00	-25.84	-20dBm
Test Results				Compliance				

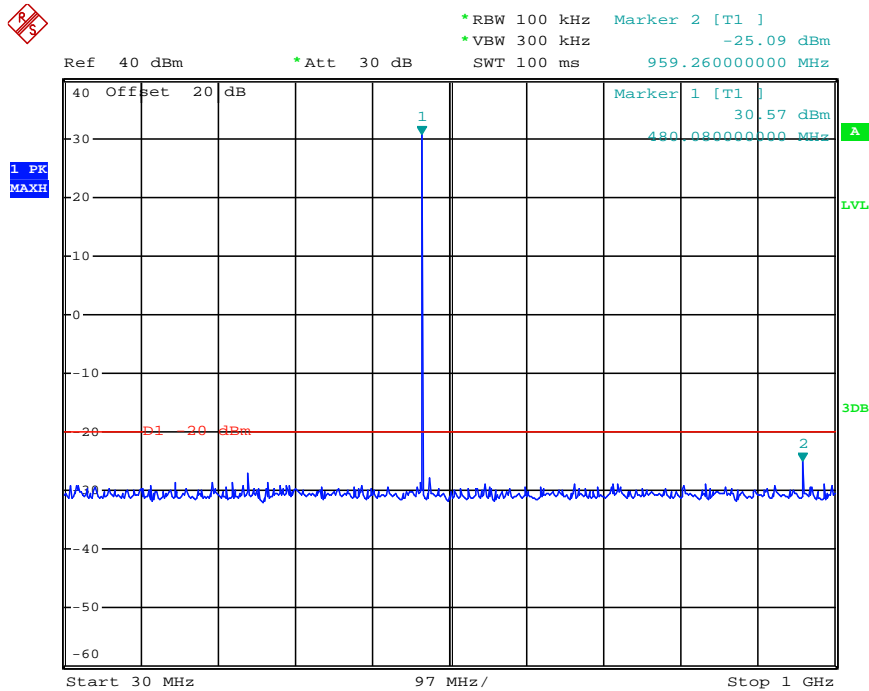

Date: 12.DEC.2012 10:23:50

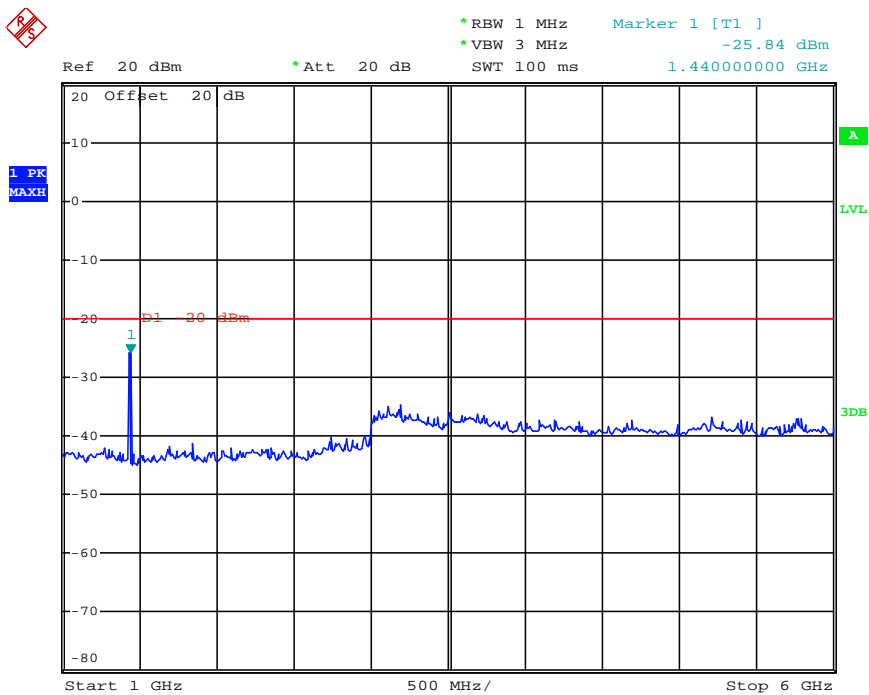

Date: 12.DEC.2012 10:25:50

For Rated Low Power (1Watt)

Modulation Type	Channel Separation	Test Channel	Test Frequency (MHz)	Maximum Conducted Spurious Emissions Below 1GHz		Maximum Conducted Spurious Emissions Above 1GHz		FCC Limit
				Frequency (MHz)	Datum (dBm)	Frequency (MHz)	Datum (dBm)	
FM	12.5KHz	Low	136.5000	286.08	-28.82	3150.00	-35.16	-20dBm
Test Results				Compliance				

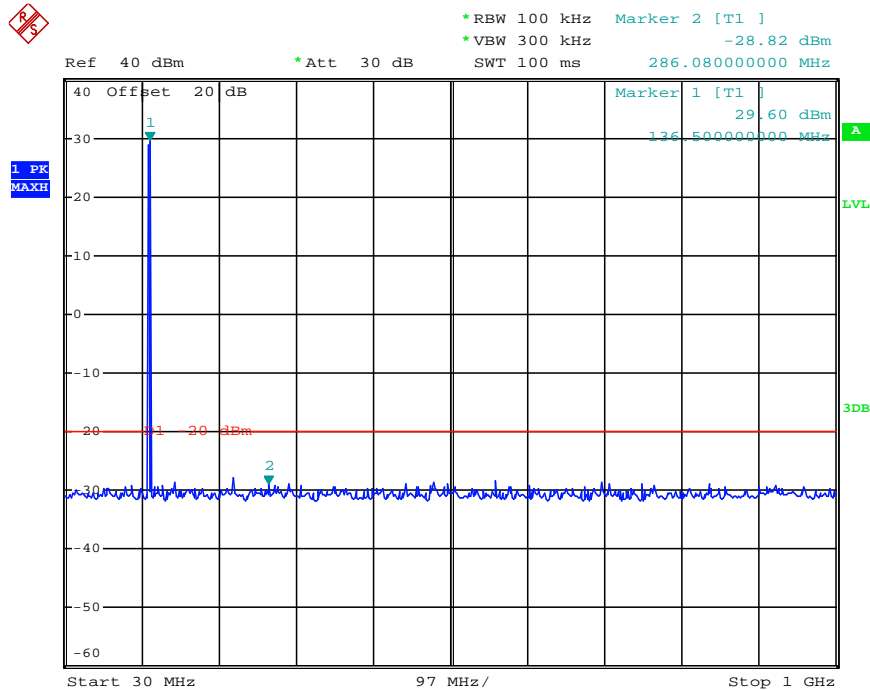

Date: 12.DEC.2012 09:59:24

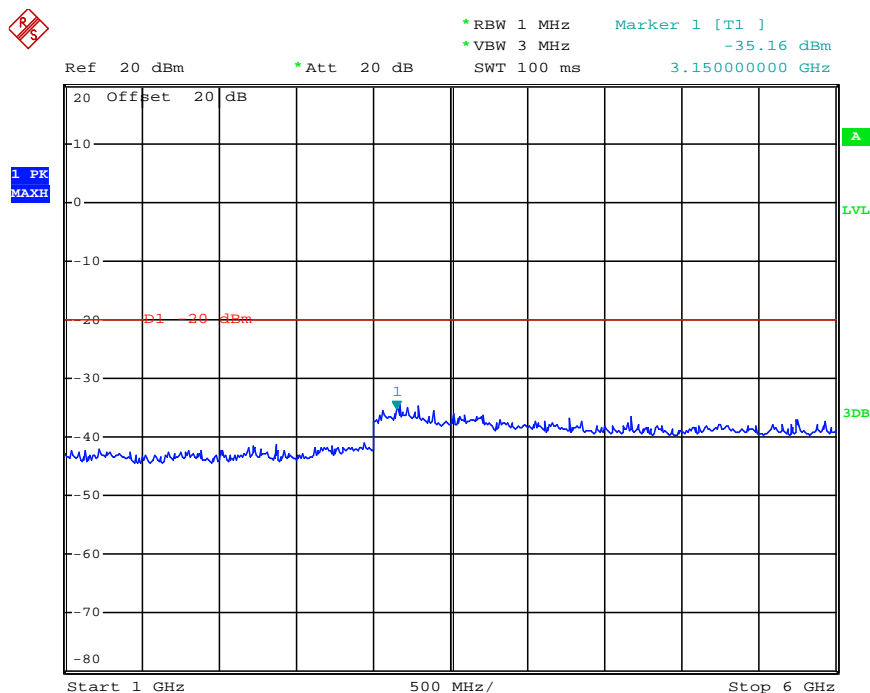

Date: 12.DEC.2012 10:14:31

Modulation Type	Channel SpARATION	Test Channel	Test Frequency (MHz)	Maximum Conducted Spurious Emissions Below 1GHz		Maximum Conducted Spurious Emissions Above 1GHz		FCC Limit
				Frequency (MHz)	Datum (dBm)	Frequency (MHz)	Datum (dBm)	
FM	12.5KHz	Middle	155.5000	311.30	-30.79	3160.00	-35.34	-20dBm
Test Results				Compliance				

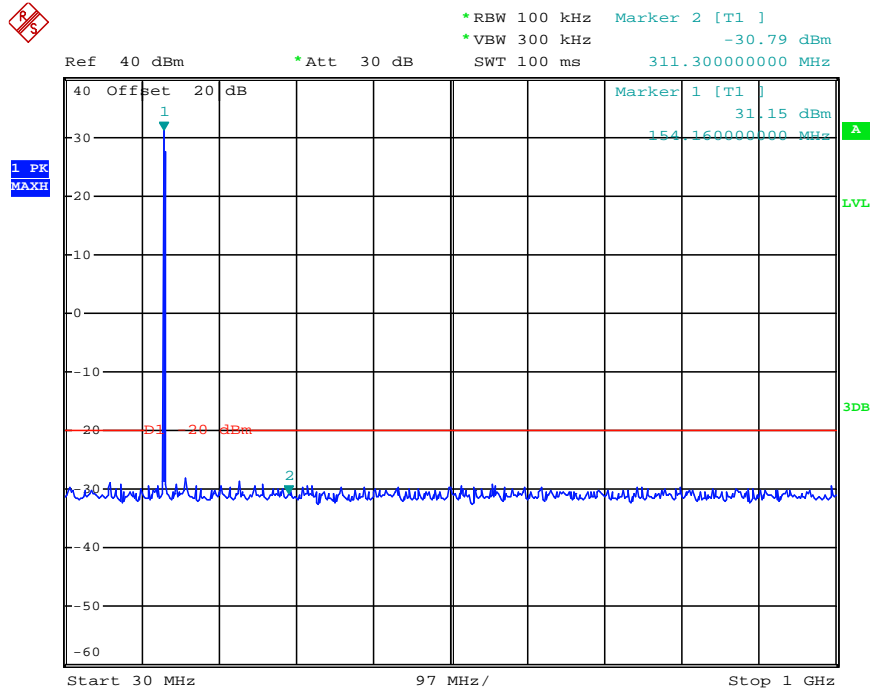

Date: 12.DEC.2012 10:32:24

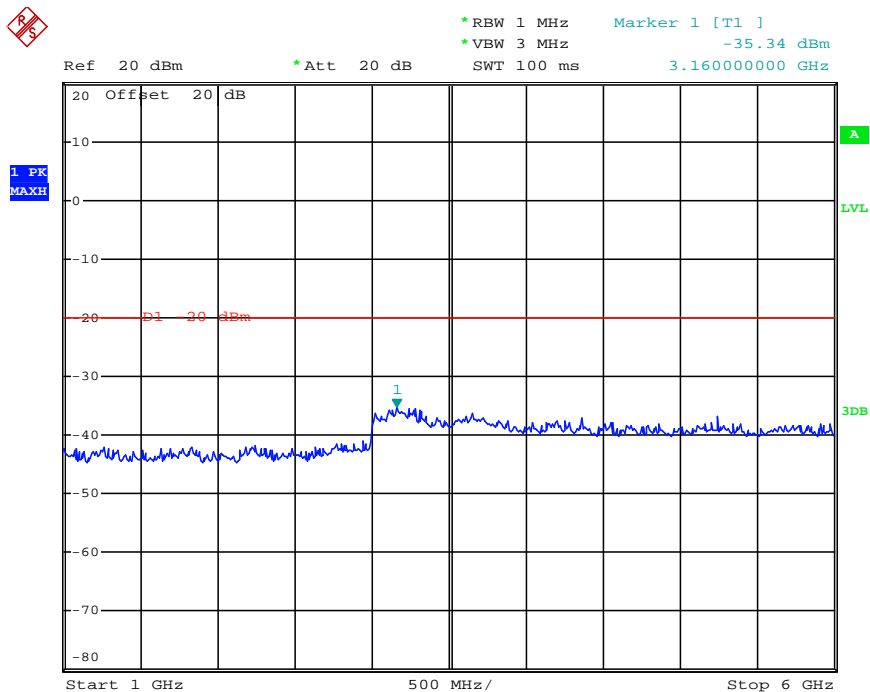

Date: 12.DEC.2012 10:30:29

Modulation Type	Channel SpARATION	Test Channel	Test Frequency (MHz)	Maximum Conducted Spurious Emissions Below 1GHz		Maximum Conducted Spurious Emissions Above 1GHz		FCC Limit
				Frequency (MHz)	Datum (dBm)	Frequency (MHz)	Datum (dBm)	
FM	12.5KHz	High	173.5000	346.22	-31.21	3160.00	-35.79	-20dBm
Test Results				Compliance				

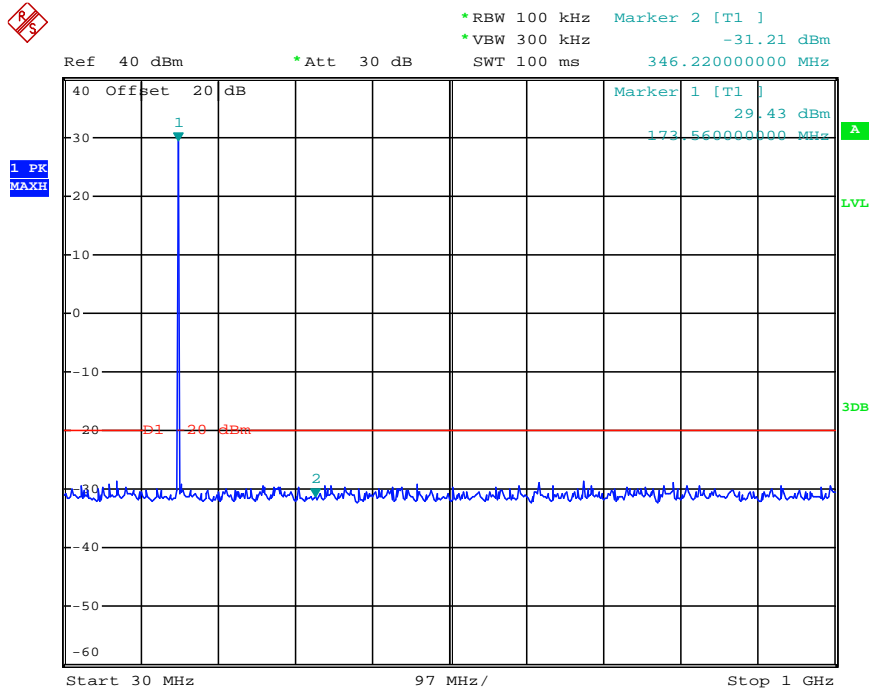

Date: 12.DEC.2012 10:23:00

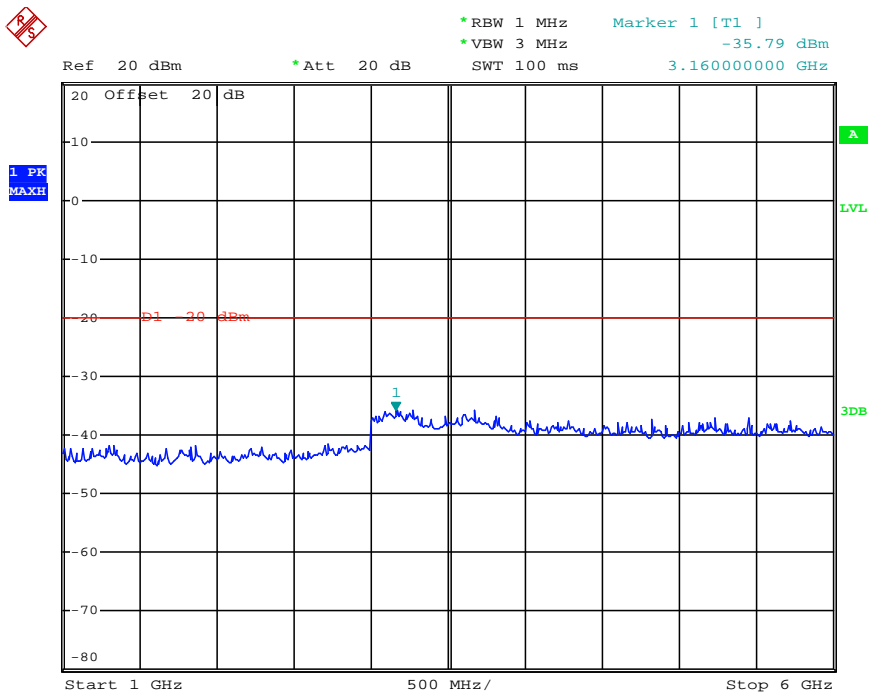

Date: 12.DEC.2012 10:26:43

Modulation Type	Channel SpARATION	Test Channel	Test Frequency (MHz)	Maximum Conducted Spurious Emissions Below 1GHz		Maximum Conducted Spurious Emissions Above 1GHz		FCC Limit
				Frequency (MHz)	Datum (dBm)	Frequency (MHz)	Datum (dBm)	
FM	12.5KHz	Low	400.5000	802.12	-28.67	3230.00	-35.10	-20dBm
Test Results				Compliance				

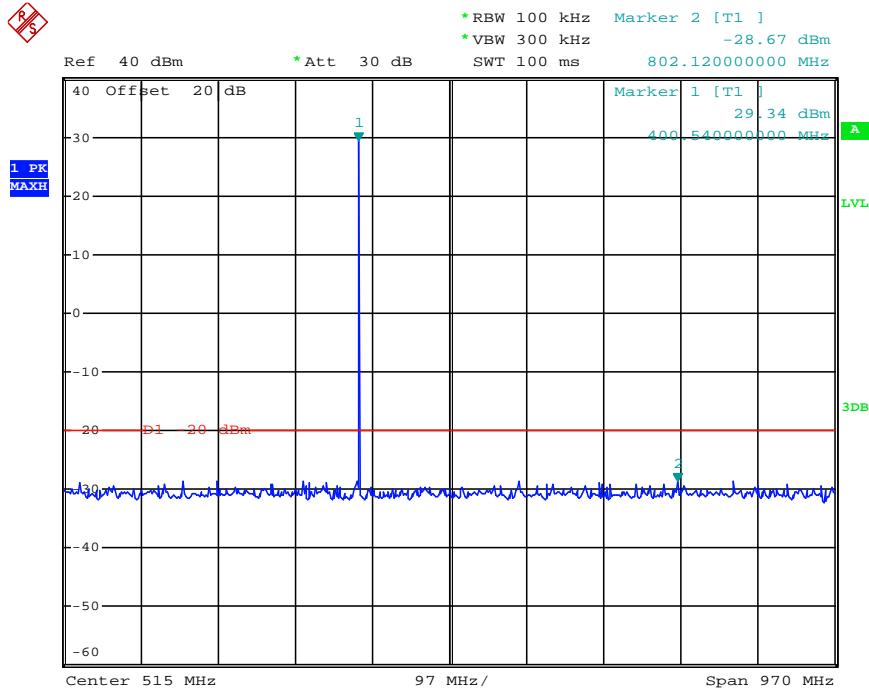

Date: 12.DEC.2012 10:09:46

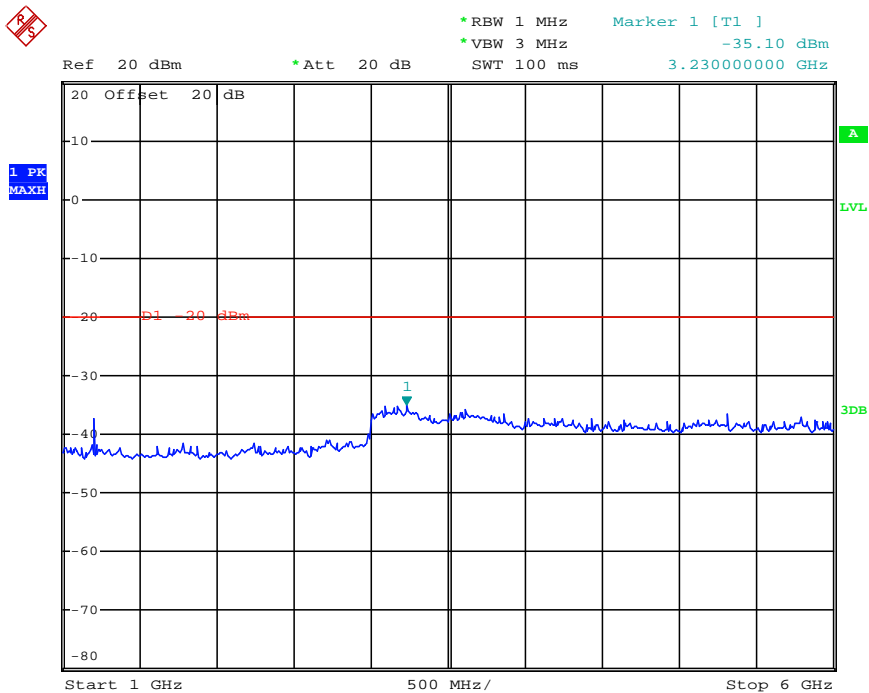

Date: 12.DEC.2012 10:12:26

Modulation Type	Channel Sparation	Test Channel	Test Frequency (MHz)	Maximum Conducted Spurious Emissions Below 1GHz		Maximum Conducted Spurious Emissions Above 1GHz		FCC Limit
				Frequency (MHz)	Datum (dBm)	Frequency (MHz)	Datum (dBm)	
FM	12.5KHz	Middle	440.5000	881.66	-31.46	1320.00	-40.28	-20dBm
Test Results				Compliance				

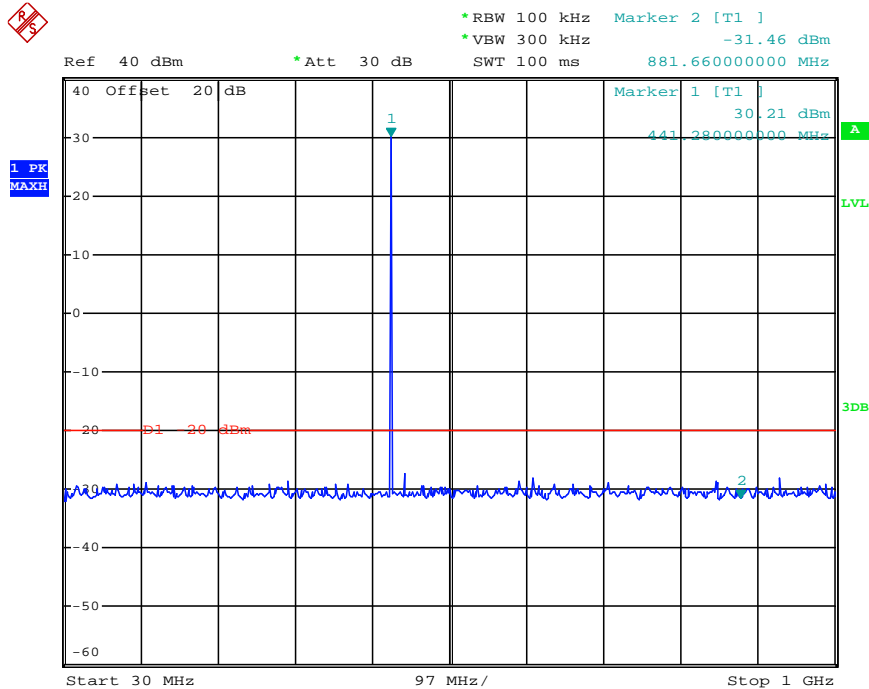

Date: 12.DEC.2012 10:34:16

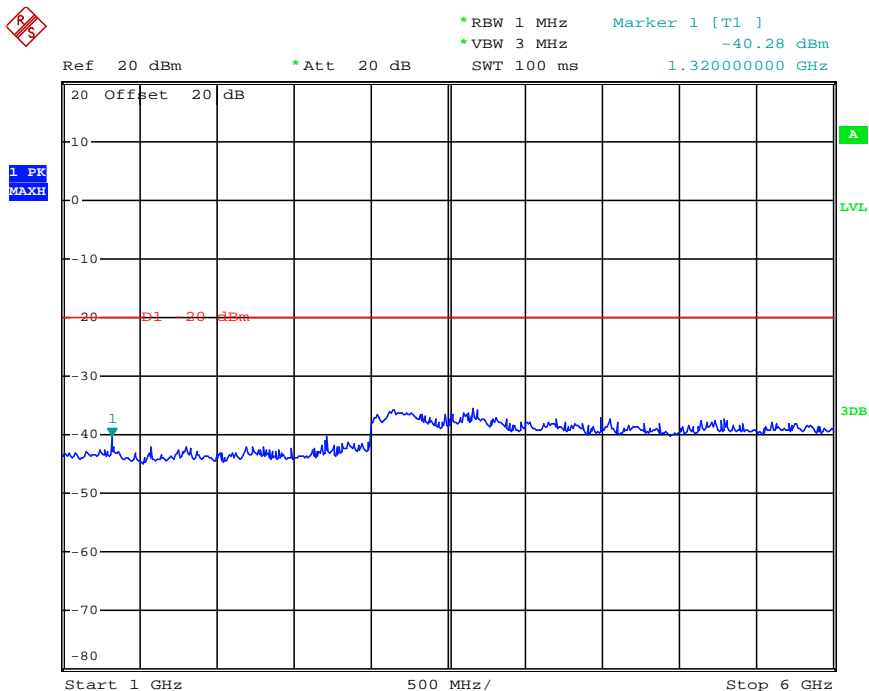

Date: 12.DEC.2012 10:28:26

Modulation Type	Channel SpARATION	Test Channel	Test Frequency (MHz)	Maximum Conducted Spurious Emissions Below 1GHz		Maximum Conducted Spurious Emissions Above 1GHz		FCC Limit
				Frequency (MHz)	Datum (dBm)	Frequency (MHz)	Datum (dBm)	
FM	12.5KHz	High	479.5000	959.26	-29.84	1440.00	-39.70	-20dBm
Test Results				Compliance				

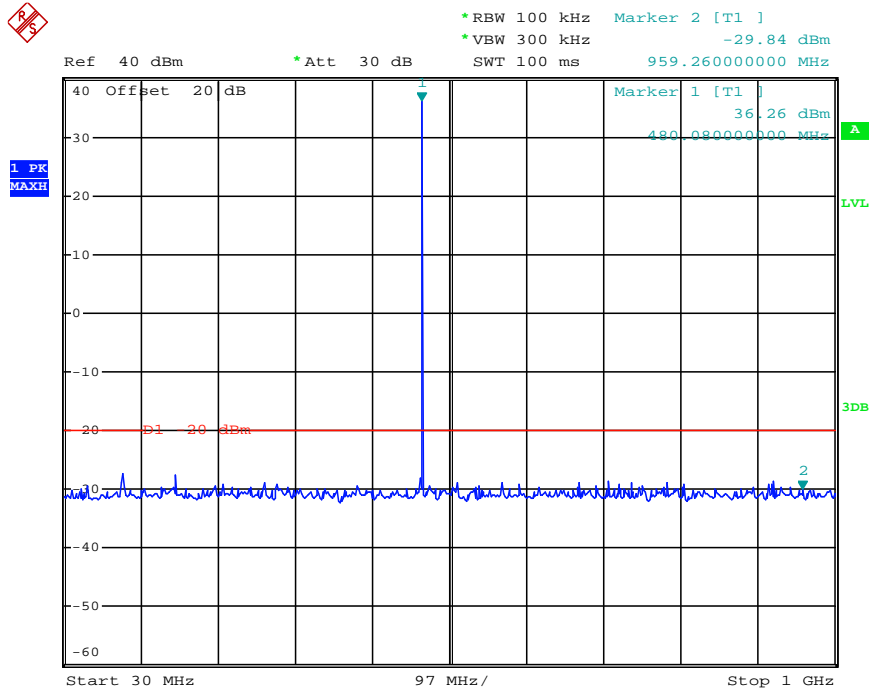

Date: 12.DEC.2012 10:24:15

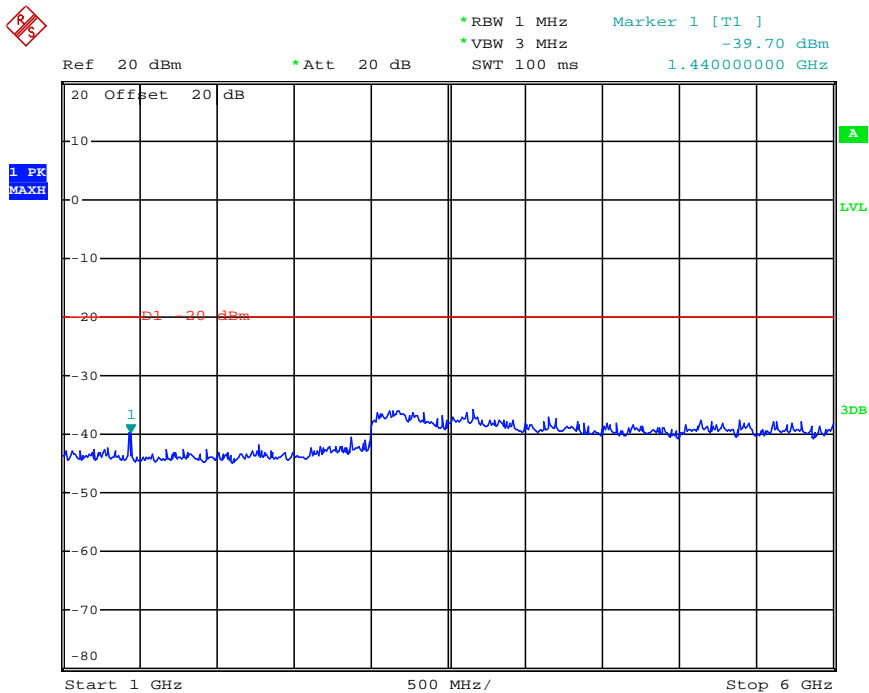

Date: 12.DEC.2012 10:26:04

### 4.5. Modulation Charcateristics

#### TEST APPLICABLE

According to CFR47 section 2.1047(a), for Voice Modulation Communication Equipment, the frequency response of the audio modulation circuit over a range of 100 to 5000Hz shall be measured.

#### TEST PROCEDURE

##### Modulation Limit

- 1 Configure the EUT as shown in figure 1, adjust the audio input for 60% of rated system deviation at 1 KHz using this level as a reference (0dB) and vary the input level from -20 to +20dB. Record the frequency deviation obtained as a function of the input level.
- 2 Repeat step 1 with input frequency changing to 300, 1004, 1500 and 2500Hz in sequence.

##### Audio Frequency Response

- 1 Configure the EUT as shown in figure 1.
- 2 Adjust the audio input for 20% of rated system deviation at 1 KHz using this level as a reference (0dB).
- 3 Vary the Audio frequency from 100 Hz to 3 KHz and record the frequency deviation.
- 4 Audio Frequency Response =  $20 \log_{10} (\text{Deviation of test frequency} / \text{Deviation of 1 KHz reference})$ .

#### TEST CONFIGURATION

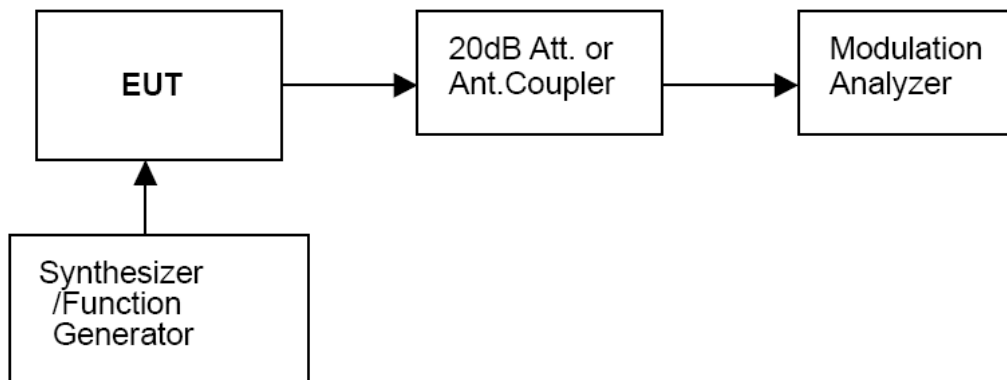

#### TEST RESULTS

##### Modulation Type: FM

##### 12.5 KHz Channel Separation

Modulation Level(dB)	Peak Freq. Deviation At 300 Hz(KHz)	Peak Freq. Deviation At 1004 H(KHz)	Peak Freq. Deviation At 1500 Hz(KHz)	Peak Freq. Deviation At 2500 Hz(KHz)
-20	0.12	0.16	0.27	0.45
-15	0.15	0.38	0.45	0.66
-10	0.16	0.55	0.76	1.17
-5	0.22	0.86	1.22	2.08
0	0.45	1.59	2.16	2.25
+5	0.78	2.26	2.25	2.25
+10	1.25	2.25	2.24	2.23
+15	2.21	2.25	2.24	2.23
+20	2.23	2.25	2.24	2.23



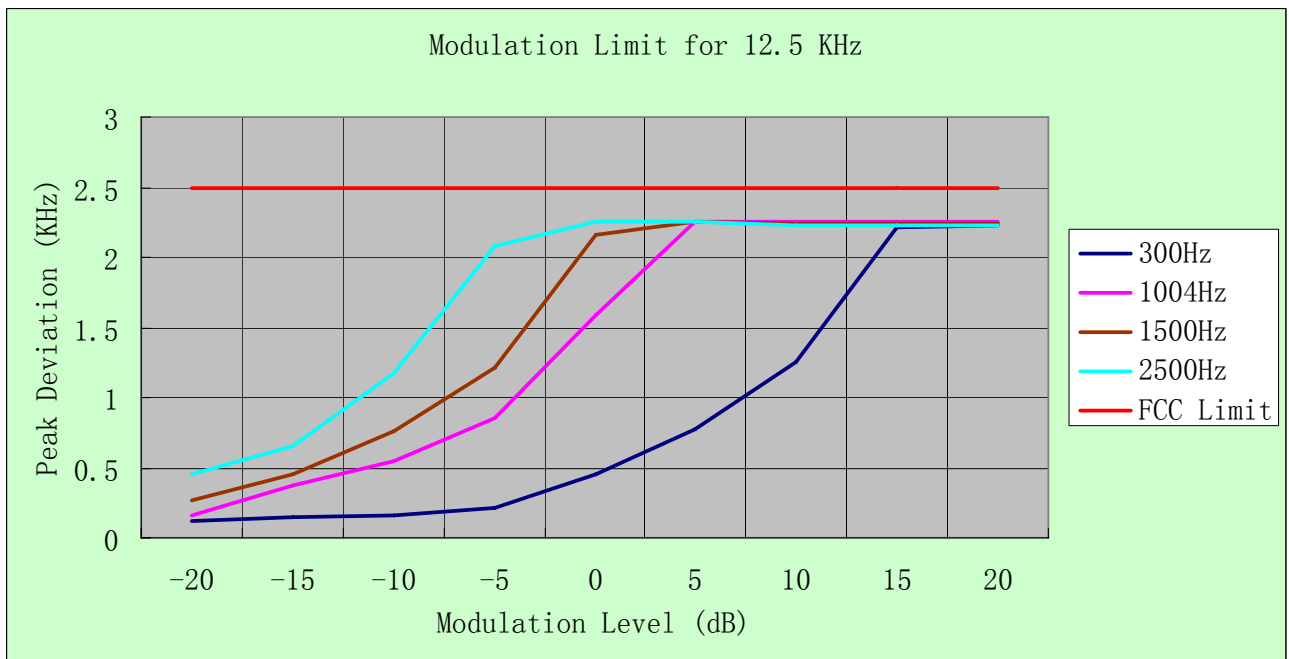

**b). Audio Frequency Response:**

**Rule Part No.: Part 2.1407(a) (b)**

**Method of Measurement:**

The audio frequency response was measured in accordance with TIA/EIA Specification 603 with no exception. A curve or equivalent data showing the frequency response of the audio modulating circuit over a range of 300-3000Hz shall be submitted and Audio Post Limiter Low Pass Filter Response from 3.0 KHz to 50KHz. However, the audio frequency response should test from 100Hz to 5.0 KHz according to FCC Part 90.

**Modulation Type: FM**

The audio frequency response curve is show below.and

**Test Audio Level (1 KHz and 20% maximum deviation) is 2.70mv for 12.5 KHz channel separation.**

**Note:**

- 1 Not applicable to new standard. However, tests are conducted under FCC's recommendation.
- 2 The Audio Frequency Response is identical for 12.5 KHz channel separation

**12.5 KHz Channel Separation**

Frequency (KHz)	Frequency Deviation (KHz)	1KHz Reference Deviation (KHz)	Audio Frequency Response (dB)
0.1	0.06	0.51	-18.59
0.2	0.06	0.51	-18.59
0.3	0.14	0.51	-11.23
0.4	0.19	0.51	-8.58
0.5	0.21	0.51	-7.71
0.6	0.28	0.51	-5.21
0.7	0.36	0.51	-3.03
0.8	0.37	0.51	-2.79
0.9	0.46	0.51	-0.90
1.0	0.50	0.51	-0.17
1.2	0.56	0.51	0.81
1.4	0.65	0.51	2.11
1.6	0.74	0.51	3.23
1.8	0.82	0.51	4.12
2.0	0.92	0.51	5.12
2.2	1.06	0.51	6.35
2.4	1.11	0.51	6.76
2.6	1.20	0.51	7.43
2.7	1.22	0.51	7.58
2.8	1.21	0.51	7.50
3.0	1.27	0.51	7.92
3.5	0.05	0.51	-20.17
4.0	0.04	0.51	-22.11
4.5	0.03	0.51	-24.61
5.0	0.03	0.51	-24.61

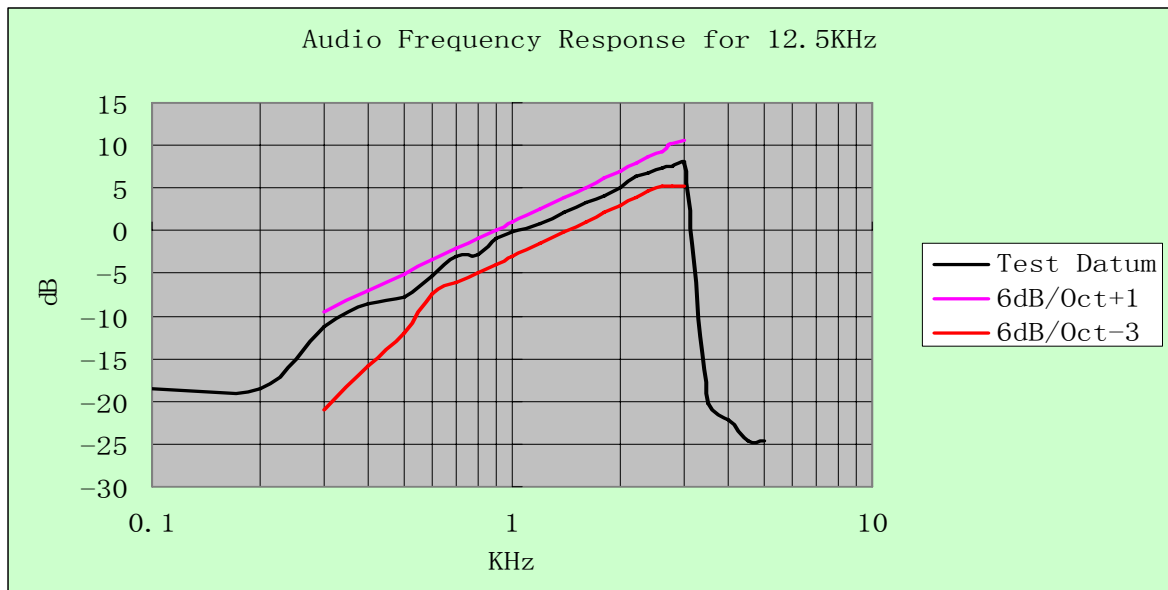

### 4.6. Frequency Stability Test

#### TEST APPLICABLE

- 1 According to FCC Part 2 Section 2.1055 (a)(1), the frequency stability shall be measured with variation of ambient temperature from -30°C to +50°C centigrade.
- 2 According to FCC Part 2 Section 2.1055 (a) (2), for battery powered equipment, the frequency stability shall be measured with reducing primary supply voltage to the battery operating end point, which is specified by the manufacture.
- 3 Vary primary supply voltage from 85 to 115 percent of the nominal value for other than hand carried battery equipment and the end voltage point was 6.67V.
- 4 According to §90.213, the frequency stability limit is 2.5 ppm for 12.5KHz channel separation

#### TEST PROCEDURE

The EUT was set in the climate chamber and connected to an external DC power supply. The RF output was directly connected to Spectrum Analyzer ESI 26. The coupling loss of the additional cables was recorded and taken in account for all the measurements. After temperature stabilization (approx. 20 min for each stage), the frequency for the lower, the middle and the highest frequency range was recorded. For Frequency stability Vs. Voltage the EUT was connected to a DC power supply and the voltage was adjusted in the required ranges. The result was recorded.

#### TEST CONFIGURATION

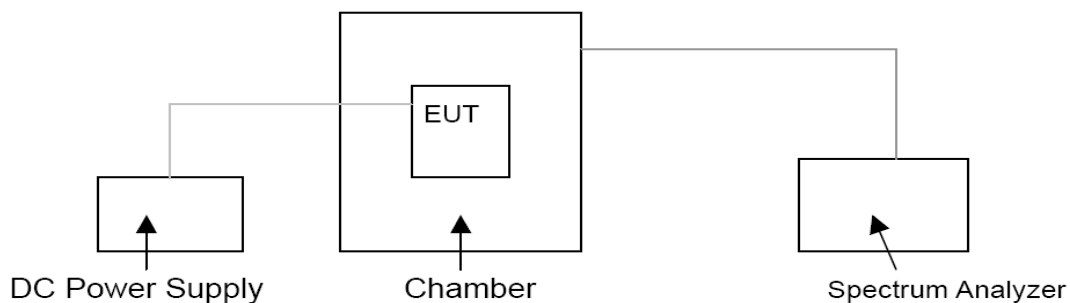

#### TEST LIMITS

According to 90.213, Transmitters used must have minimum frequency stability as specified in the following table.

Frequency Range (MHz)	Channel Bandwidth (KHz)	Frequency Tolerance (ppm)		
		Fixed and Base Stations	Mobile Stations	
			> 2 W	≤ 2 W
150-174 MHz	6.25	1.0	2.0	2.0
	12.5	2.5	5.0	5.0
	25	5.0	5.0	50.0*
421-512 MHz	6.25	0.5	1.0	1.0
	12.5	1.5	2.5	2.5
	25	2.5	5.0	5.0

- Stations operating in the 154.45 to 154.49 MHz or the 173.2 to 173.4 MHz bands must have a frequency stability of 5 ppm.
- Paging transmitters operating on paging-only frequencies must operate with frequency stability of 5 ppm in the 150-174 MHz band and 2.5 ppm in the 421-512 MHz band.

**TEST RESULTS**

Modulation Type	Channel Separation	Test conditions		Frequency error (ppm)		
		Voltage(V)	Temp(°C)	136.5MHz	155.5 MHz	173.5 MHz
Analog/FM	12.5KHz	7.40	-30	0.75	0.78	0.72
			-20	0.78	0.75	0.66
			-10	0.66	0.66	0.68
			0	0.65	0.62	0.55
			10	0.64	0.52	0.54
			20	0.65	0.52	0.55
			30	0.62	0.66	0.52
			40	0.74	0.62	0.66
			50	0.75	0.74	0.60
		6.67 (End point)	20	0.62	0.70	0.62
		6.29 (85% Rated)	20	0.52	0.62	0.52
8.51 (115% Rated)	20	0.56	0.56	0.60		
Limit			5.0 ppm			
Conclusion			Complies			

Modulation Type	Channel Separation	Test conditions		Frequency error (ppm)		
		Voltage(V)	Temp(°C)	400.5 MHz	440.5 MHz	479.5 MHz
Analog/FM	12.5KHz	7.40	-30	0.75	0.75	0.77
			-20	0.74	0.75	0.62
			-10	0.74	0.62	0.66
			0	0.65	0.62	0.65
			10	0.68	0.66	0.60
			20	0.56	0.66	0.60
			30	0.68	0.62	0.61
			40	0.64	0.62	0.73
			50	0.60	0.65	0.60
		6.67 (End point)	20	0.50	0.66	0.72
		6.29 (85% Rated)	20	0.66	0.60	0.73
8.51 (115% Rated)	20	0.71	0.68	0.60		
Limit			2.5 ppm			
Conclusion			Complies			

### 4.7. Maximum Transmitter Power

#### TEST APPLICABLE

Per FCC «2.1046 and «90.205: Maximum ERP is dependent upon the station’s antenna HAAT and required service area.

#### TEST PROCEDURE

Measurements shall be made to establish the radio frequency power delivered by the transmitter the standard output termination. The power output shall be monitored and recorded and no adjustment shall be made to the transmitter after the test has begun, except as noted bellow:

If the power output is adjustable, measurements shall be made for the highest and lowest power levels.

The EUT connect to the Receiver through 20 dB attenuator.

Measurement with Spectrum Analyzer FSP40 conducted, external power supply with 12.00 V stabilized supply voltage.

#### TEST CONFIGURATION

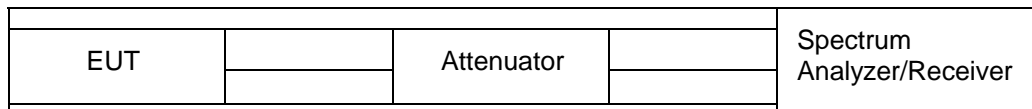

The EUT was directly connected to a RF Communication  
Test set by a 20 dB attenuator

#### TEST RESULTS

Modulation Type	Band	Test Channel	Test Frequency	Maximum Transmitter Power at Rated High Power Level(dBm)	Maximum Transmitter Power at Rated Low Power Level(dBm)
Analog/FM	VHF	Low	136.5000 MHz	36.49	29.57
		Middle	155.5000 MHz	37.10	31.29
		High	173.5000 MHz	37.32	29.91
	UHF	Low	400.5000 MHz	36.12	29.91
		Middle	440.5000 MHz	36.02	30.37
		High	479.5000 MHz	36.64	30.82
Limit		The limit is dependent upon the station’s antenna HAAT and required service area.			
Test Results		Complicance			

#### Plots of Maximum Transmitter Power Measurement

Modulation Type	Channel Separation	Freq.(MHz)	Rated Power (Watt)	Measurement (dBm)	FCC Limit	Results
FM	12.5 KHz	136.5000	5	36.49	Varies	Complicance

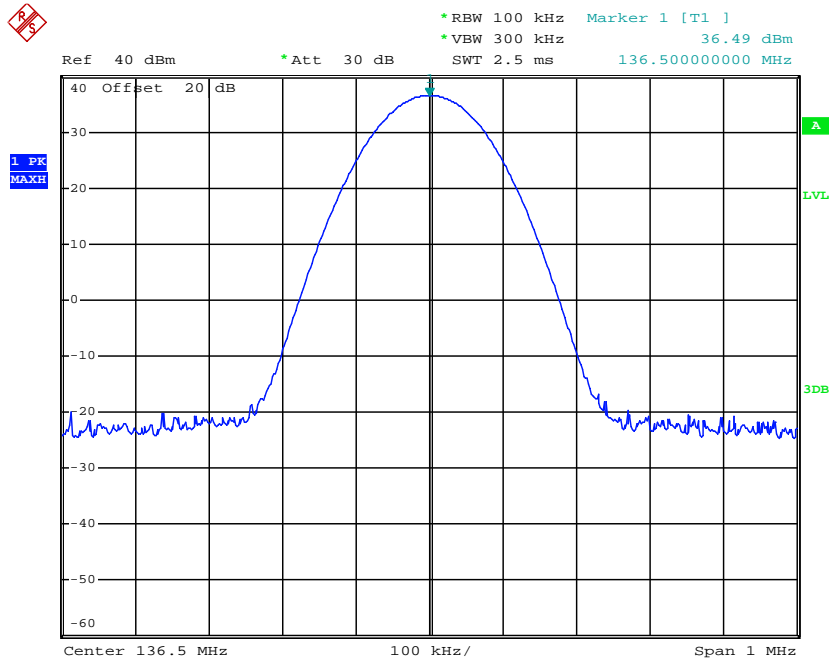

Date: 19.DEC.2012 16:12:06

Modulation Type	Channel Separation	Freq.(MHz)	Rated Power (Watt)	Measurement (dBm)	FCC Limit	Results
FM	12.5 KHz	155.5000	5	37.10	Varies	Complicance

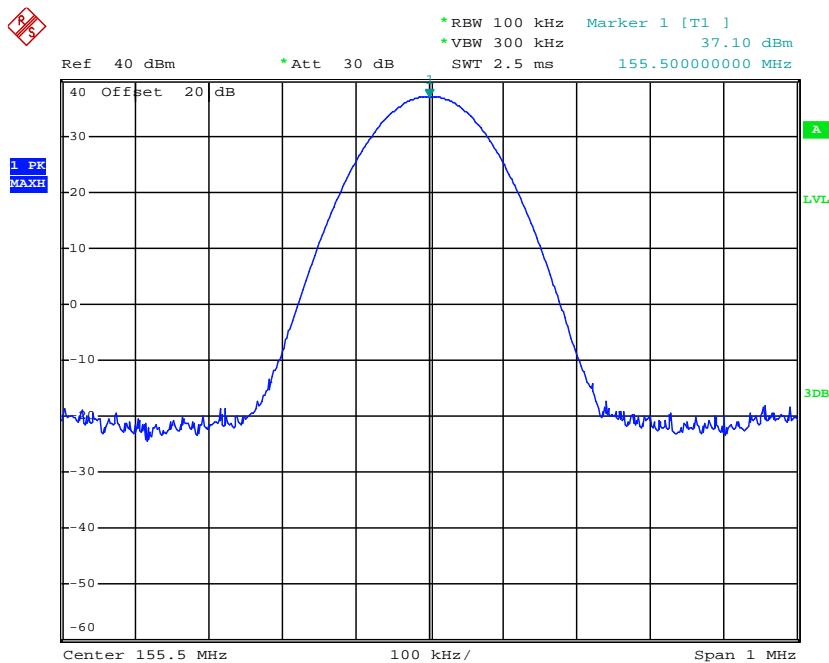

Date: 19.DEC.2012 16:10:52

Modulation Type	Channel Separation	Freq.(MHz)	Rated Power (Watt)	Measurement (dBm)	FCC Limit	Results
FM	12.5 KHz	173.5000	5	37.32	Varies	Complicance

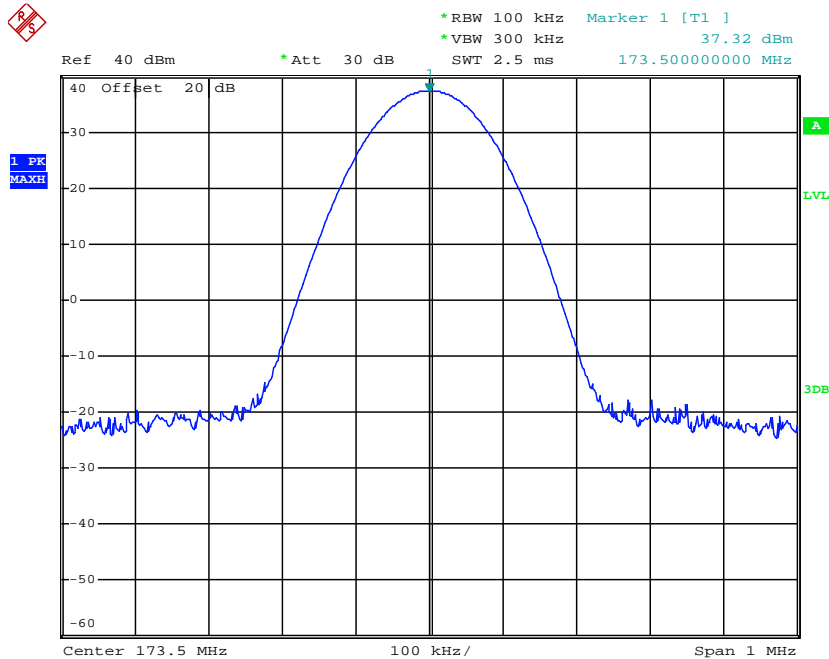

Date: 19.DEC.2012 16:08:02

Modulation Type	Channel Separation	Freq.(MHz)	Rated Power (Watt)	Measurement (dBm)	FCC Limit	Results
FM	12.5 KHz	400.5000	4	36.12	Varies	Complicance

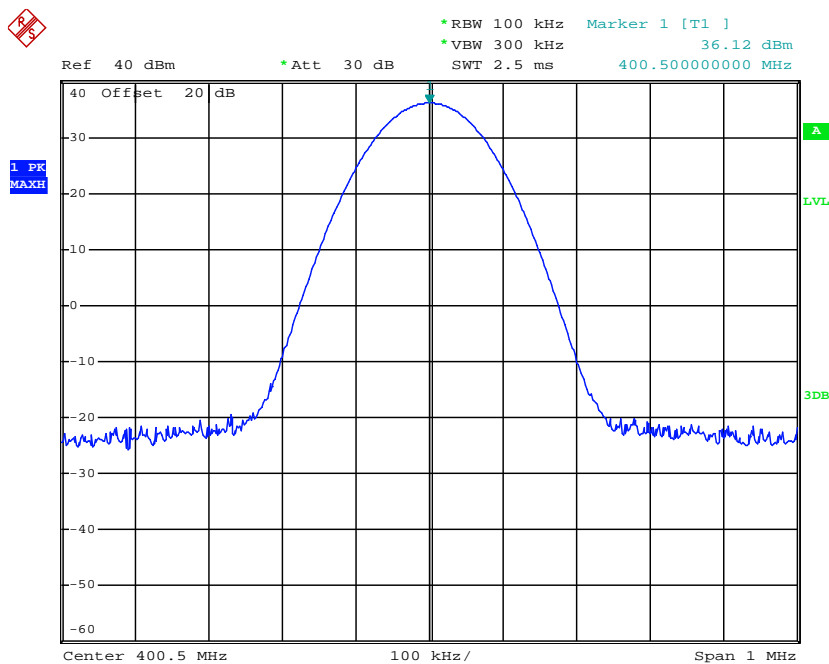

Date: 18.DEC.2012 09:16:09

Modulation Type	Channel Separation	Freq.(MHz)	Rated Power (Watt)	Measurement (dBm)	FCC Limit	Results
FM	12.5 KHz	440.5000	4	36.02	Varies	Complicance

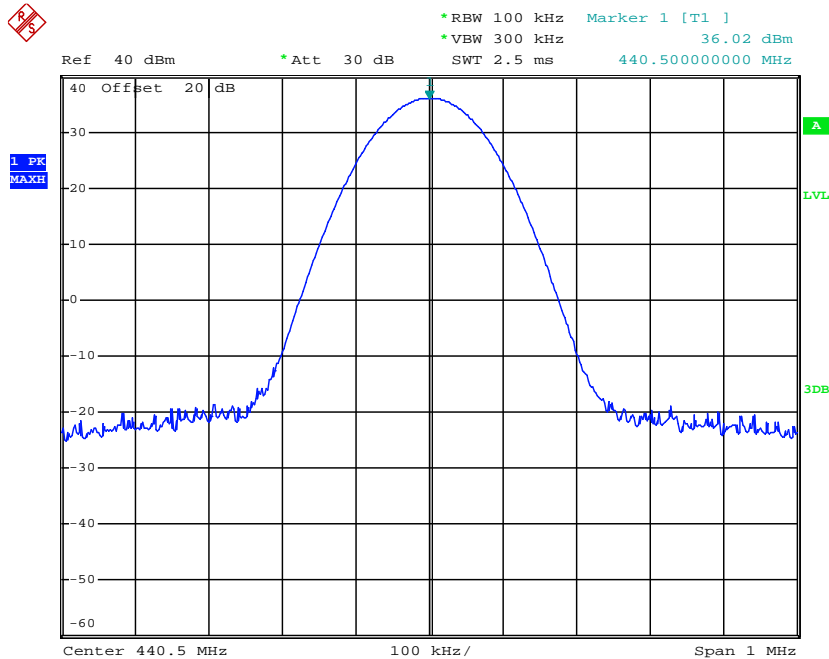

Date: 19.DEC.2012 16:09:46

Modulation Type	Channel Separation	Freq.(MHz)	Rated Power (Watt)	Measurement (dBm)	FCC Limit	Results
FM	12.5 KHz	479.5000	4	36.64	Varies	Complicance

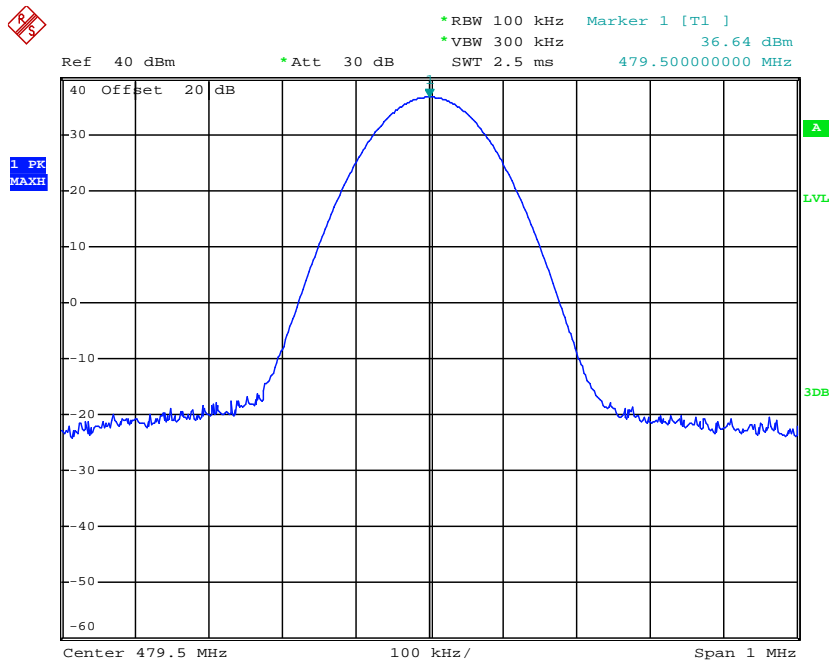

Date: 19.DEC.2012 16:07:09



Modulation Type	Channel Separation	Freq.(MHz)	Rated Power (Watt)	Measurement (dBm)	FCC Limit	Results
FM	12.5 KHz	136.5000	1	29.57	Varies	Complicance

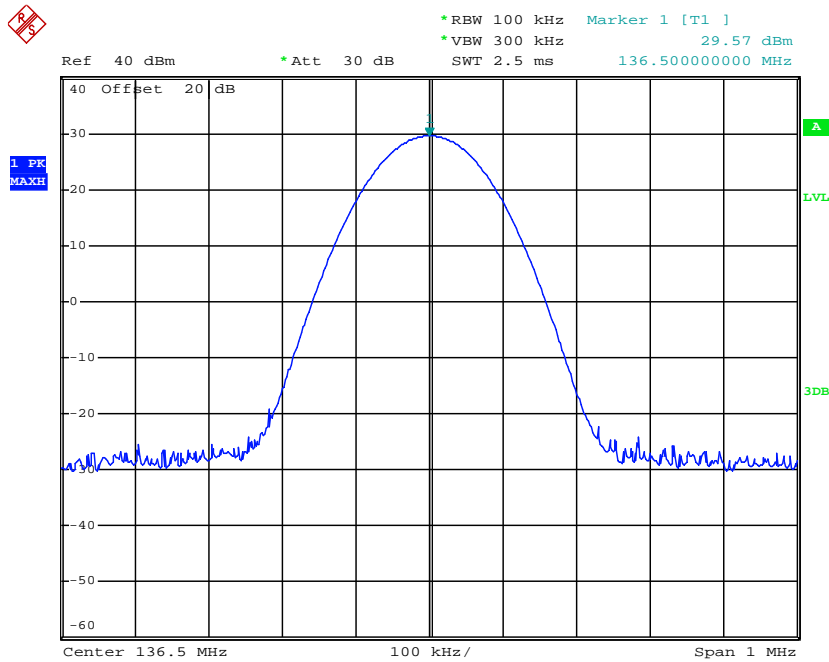

Date: 19.DEC.2012 16:12:19

Modulation Type	Channel Separation	Freq.(MHz)	Rated Power (Watt)	Measurement (dBm)	FCC Limit	Results
FM	12.5 KHz	155.5000	1	31.29	Varies	Complicance

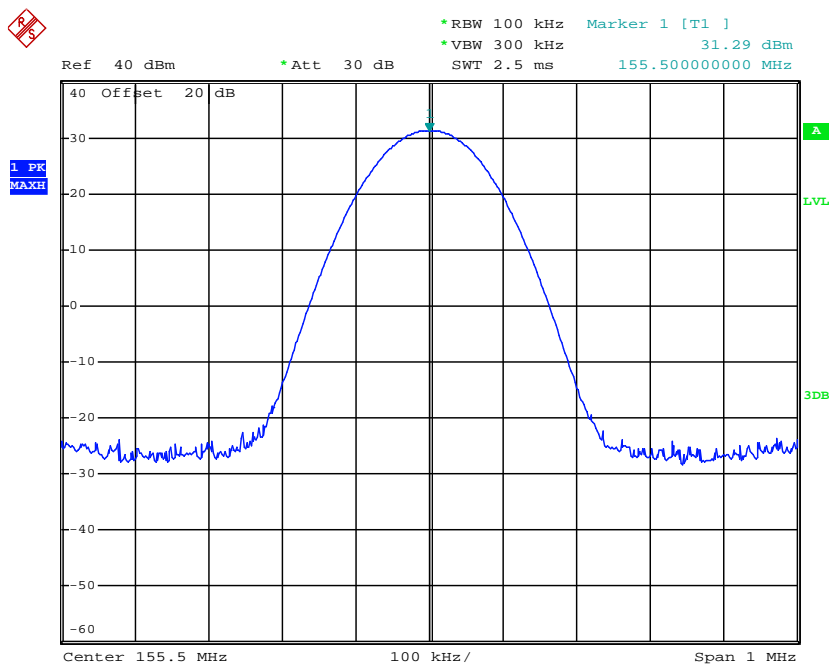

Date: 19.DEC.2012 16:11:15

Modulation Type	Channel Separation	Freq.(MHz)	Rated Power (Watt)	Measurement (dBm)	FCC Limit	Results
FM	12.5 KHz	173.5000	1	29.91	Varies	Complicance

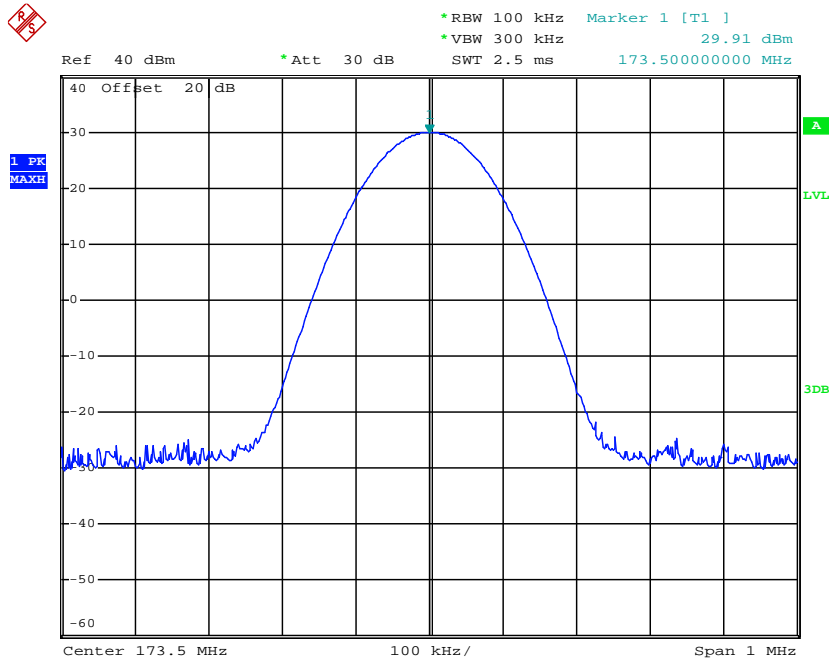

Date: 19.DEC.2012 16:08:15

Modulation Type	Channel Separation	Freq.(MHz)	Rated Power (Watt)	Measurement (dBm)	FCC Limit	Results
FM	12.5 KHz	400.5000	1	29.91	Varies	Complicance

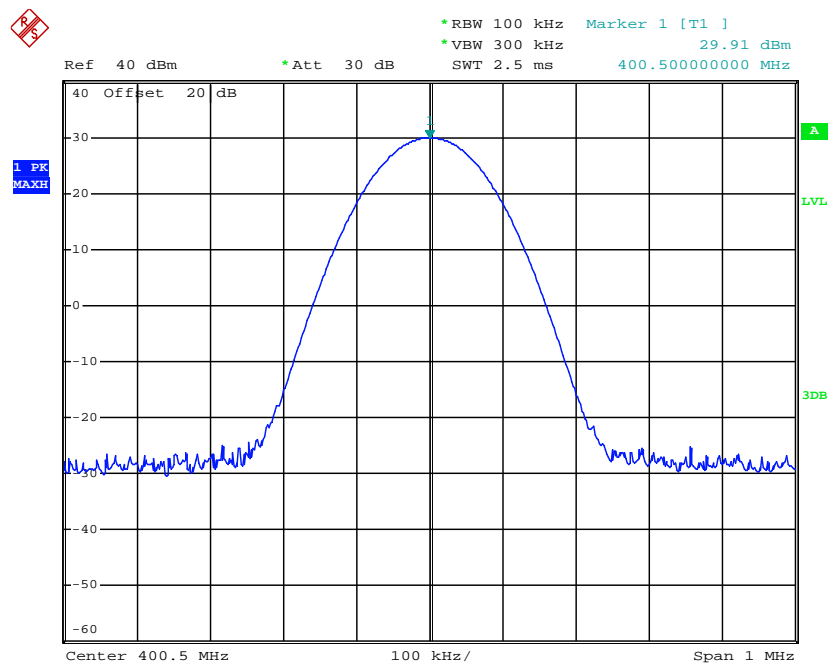

Date: 18.DEC.2012 09:16:51

Modulation Type	Channel Separation	Freq.(MHz)	Rated Power (Watt)	Measurement (dBm)	FCC Limit	Results
FM	12.5 KHz	440.5000	1	30.37	Varies	Complicance

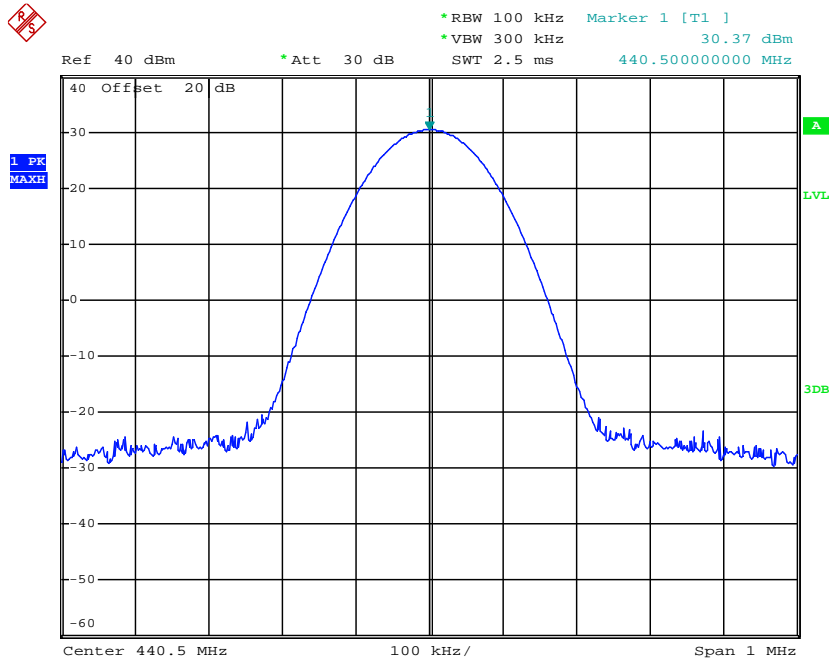

Date: 19.DEC.2012 16:10:25

Modulation Type	Channel Separation	Freq.(MHz)	Rated Power (Watt)	Measurement (dBm)	FCC Limit	Results
FM	12.5 KHz	479.5000	1	30.82	Varies	Complicance

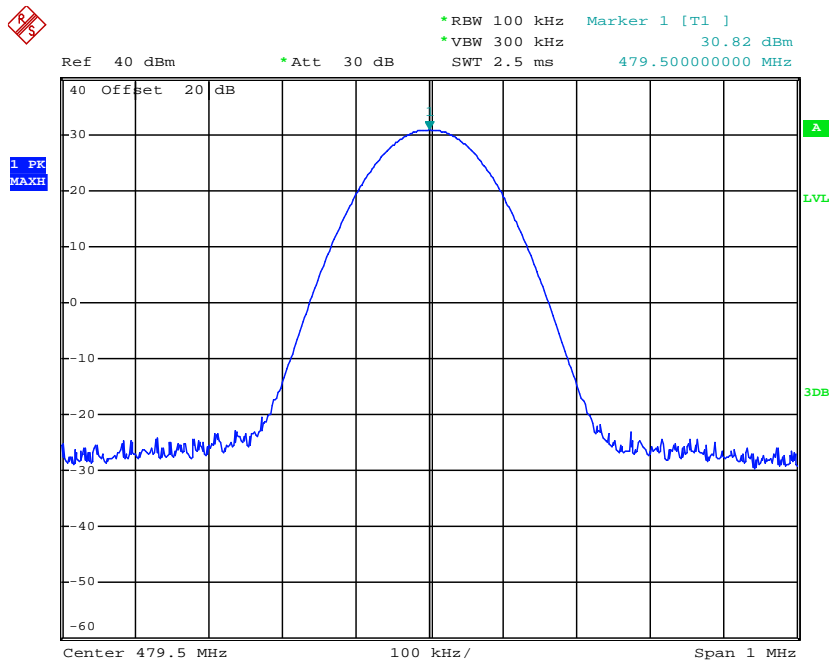

Date: 19.DEC.2012 16:07:31

### 4.8. Transmitter Frequency Behavior

#### TEST APPLICABLE

Section 90.214

Transient frequencies must be within the maximum frequency difference limits during the time intervals indicated:

Time intervals <sup>1, 2</sup>	Maximum frequency difference <sup>3</sup>	All equipment	
		150 to 174 MHz	421 to 512MHz
Transient Frequency Behavior for Equipment Designed to Operate on 25 KHz Channels			
$t_1$ <sup>4</sup> .....	± 25.0 KHz	5.0 ms	10.0 ms
$t_2$ .....	± 12.5 KHz	20.0 ms	25.0 ms
$t_3$ <sup>4</sup> .....	± 25.0 KHz	5.0 ms	10.0 ms
Transient Frequency Behavior for Equipment Designed to Operate on 12.5 KHz Channels			
$t_1$ <sup>4</sup> .....	± 12.5 KHz	5.0 ms	10.0 ms
$t_2$ .....	± 6.25 KHz	20.0 ms	25.0 ms
$t_3$ <sup>4</sup> .....	± 12.5 KHz	5.0 ms	10.0 ms
Transient Frequency Behavior for Equipment Designed to Operate on 6.25 KHz Channels			
$t_1$ <sup>4</sup> .....	±6.25 KHz	5.0 ms	10.0 ms
$t_2$ .....	±3.125 KHz	20.0 ms	25.0 ms
$t_3$ <sup>4</sup> .....	±6.25 KHz	5.0 ms	10.0 ms

- $t_{on}$  is the instant when a 1 KHz test signal is completely suppressed, including any capture time due to phasing.  
 $t_1$  is the time period immediately following  $t_{on}$ .  
 $t_2$  is the time period immediately following  $t_1$ .  
 $t_3$  is the time period from the instant when the transmitter is turned off until  $t_{off}$ .  
 $t_{off}$  is the instant when the 1 KHz test signal starts to rise.
- During the time from the end of  $t_2$  to the beginning of  $t_3$ , the frequency difference must not exceed the limits specified in § 90.213.
- Difference between the actual transmitter frequency and the assigned transmitter frequency.
- If the transmitter carrier output power rating is 6 watts or less, the frequency difference during this time period may exceed the maximum frequency difference for this time period.

#### TEST PROCEDURE

TIA/EIA-603 2.2.19

#### TEST CONFIGURATION

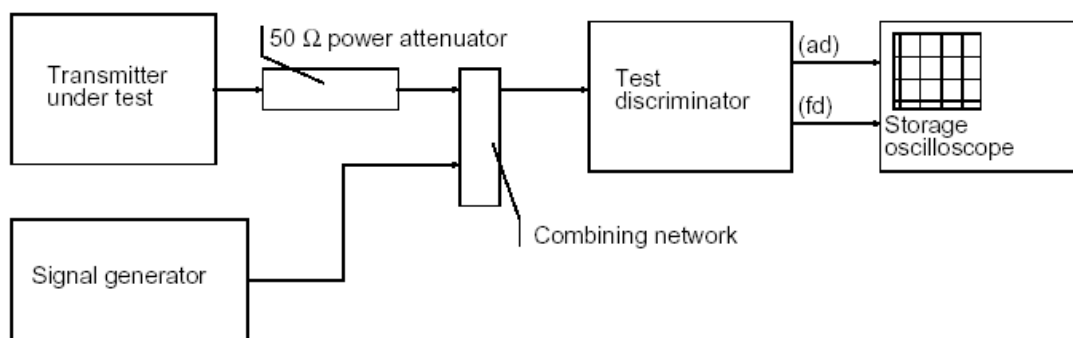

#### TEST RESULTS

Please refer to the following plots.

Modulation Type: FM

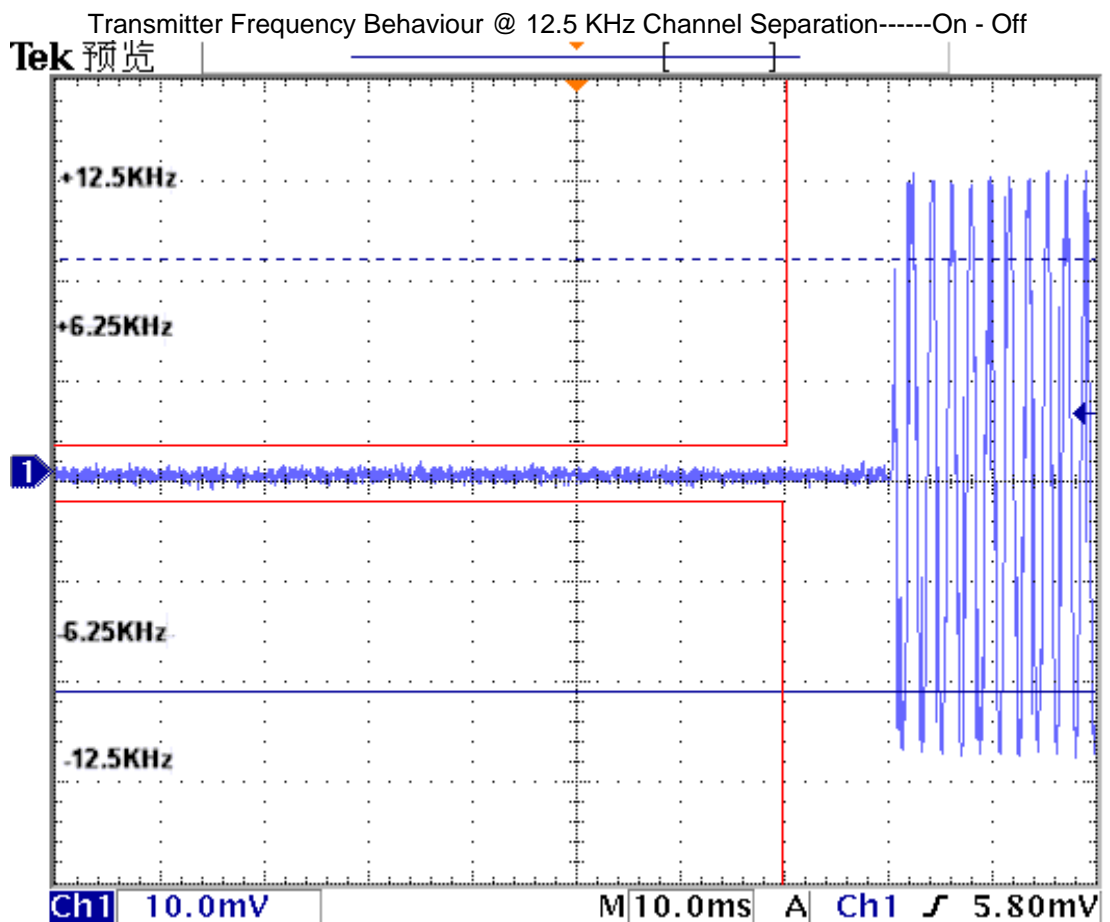
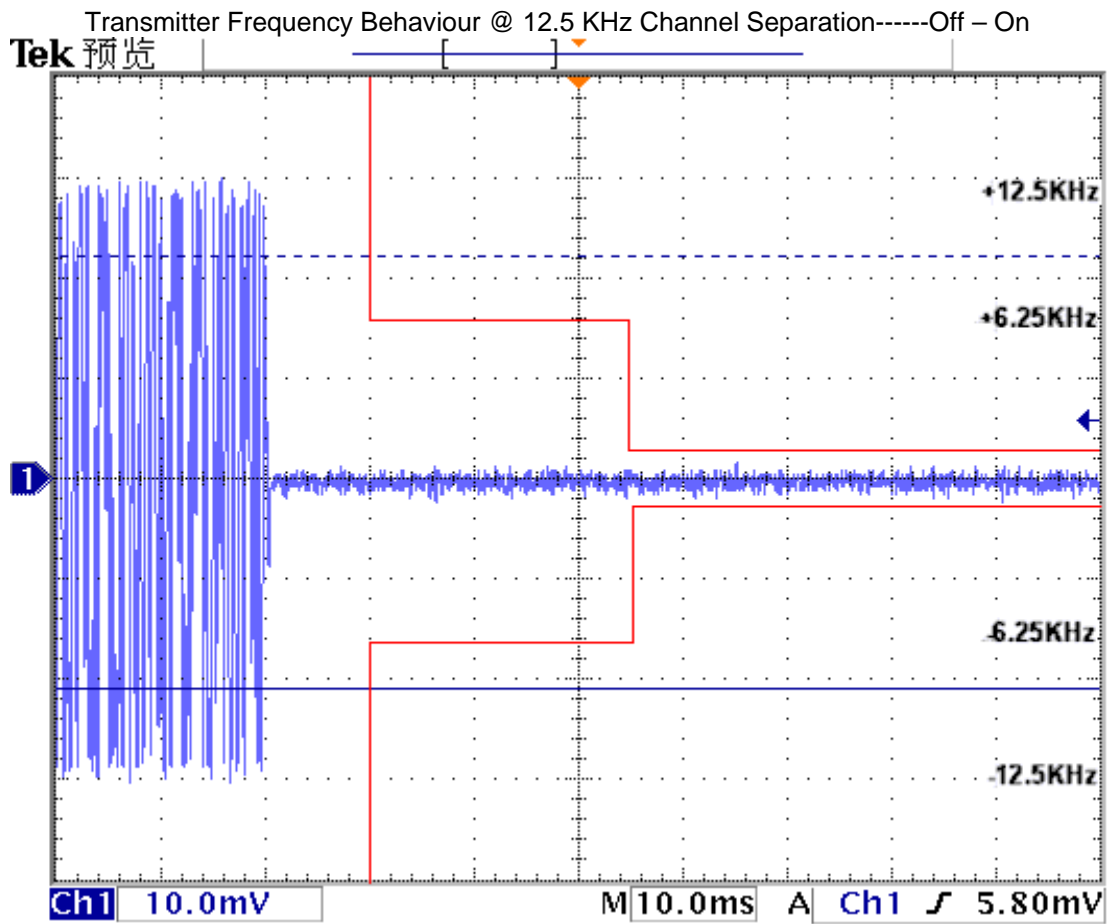

### 4.9. Receiver Radiated Spurious Emission (For Volunteer)

#### TEST APPLICABLE

The field strength is calculated by adding the Antenna Factor and Cable Factor and subtracting the Amplifier Gain and Duty Cycle Correction Factor (if any) from the measured reading. The basic equation with a sample calculation is as follows:

$$FS = RA + AF + CL - AG$$

Where FS = Field Strength	CL = Cable Attenuation Factor (Cable Loss)
RA = Reading Amplitude	AG = Amplifier Gain
AF = Antenna Factor	

#### TEST CONFIGURATION

(A) Radiated Emission Test Set-Up, Frequency below 1000MHz

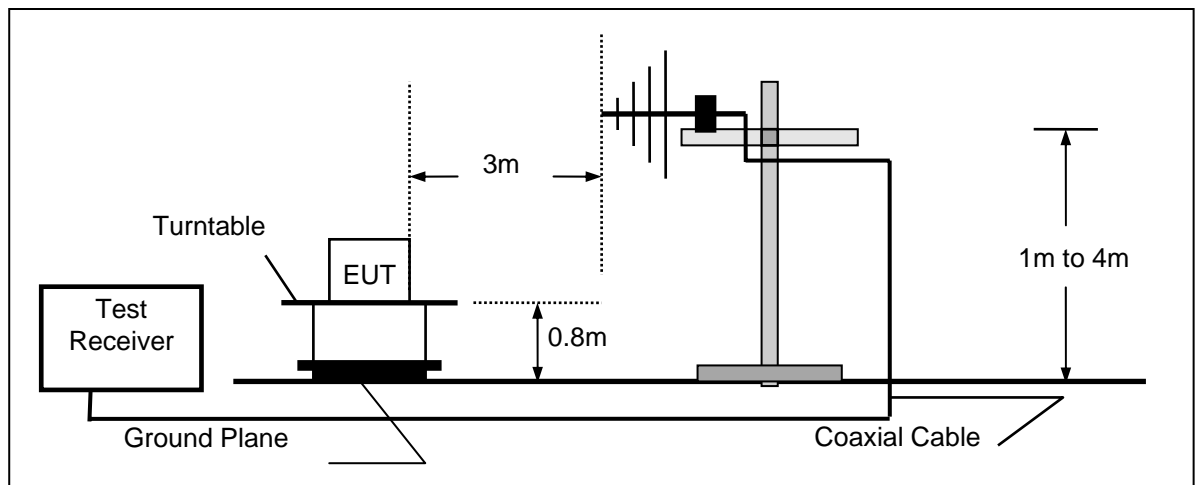

(B) Radiated Emission Test Set-Up, Frequency above 1000MHz

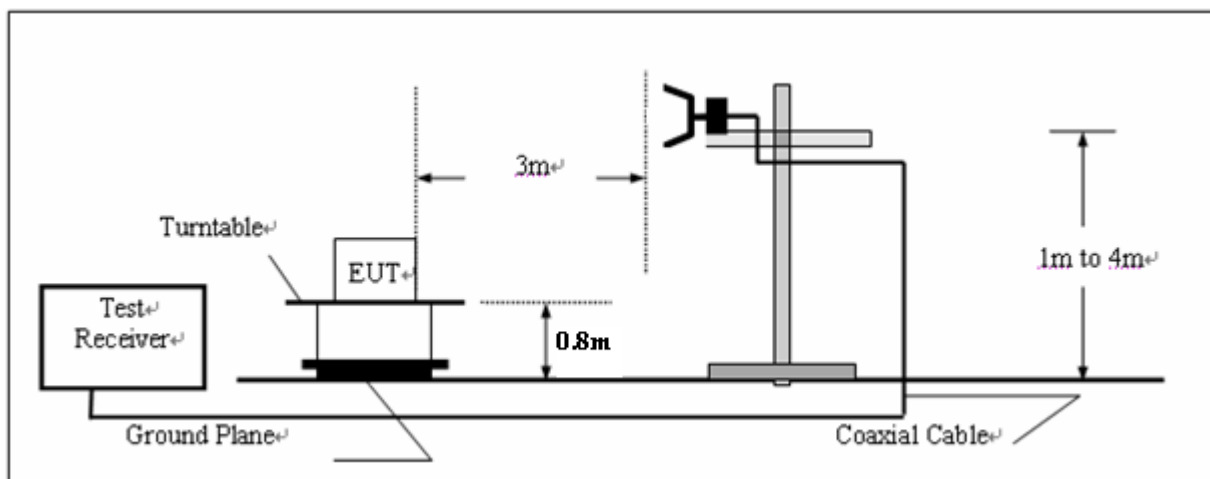

#### TEST PROCEDURE

- 1 The EUT was placed on a turn table which is 0.8m above ground plane.
- 2 Maximum procedure was performed by raising the receiving antenna from 1m to 4m and rotating the turn table from 0° to 360° to acquire the highest emissions from EUT
- 3 And also, each emission was to be maximized by changing the polarization of receiving antenna both horizontal and vertical.
- 4 Repeat above procedures until all frequency measurements have been completed.

**RECEIVER RADIATED SPOUIOUS LIMIT**

For unintentional device, according to § 15.109(a) and RSS-Gen, except for Class A digital devices, the field strength of radiated emissions from unintentional radiators at a distance of 3 meters shall not exceed the following values:

<b>Frequency (MHz)</b>	<b>Distance (Meters)</b>	<b>Radiated (dB<math>\mu</math>V/m)</b>	<b>Radiated (<math>\mu</math>V/m)</b>
30-88	3	40.0	100
88-216	3	43.5	150
216-960	3	46.0	200
Above 960	3	54.0	500

**TEST RESULTS**

The Radiated Measurement are performed to the five channels (the top channel, the middle channel and the bottom channel), the datum recorded below is the worst case for each channel separation;and the EUT shall be scanned from 30 MHz to the 5th harmonic of the highest oscillator frequency in the digital devices or 1 GHz whichever is higher.

Modulation Type	Channel Separation	Test Frequency (MHz)	Polar.	Maximum Radiated Emissions		FCC Limit (dBuV/m)
				Frequency (MHz)	Datum (dBuV/m)	
FM	12.5 KHz	155.5000	H	871.96	33.00	46.00
			V	39.70	25.50	40.00
Test Results			Compliance			

**SWEEP TABLE: "test (30M-1G)"**

Short Description: Field Strength  
 Start Stop Detector Meas. IF Transducer  
 Frequency Frequency Time Bandw.  
 30.0 MHz 1.0 GHz MaxPeak Coupled 100 kHz HL562 201106

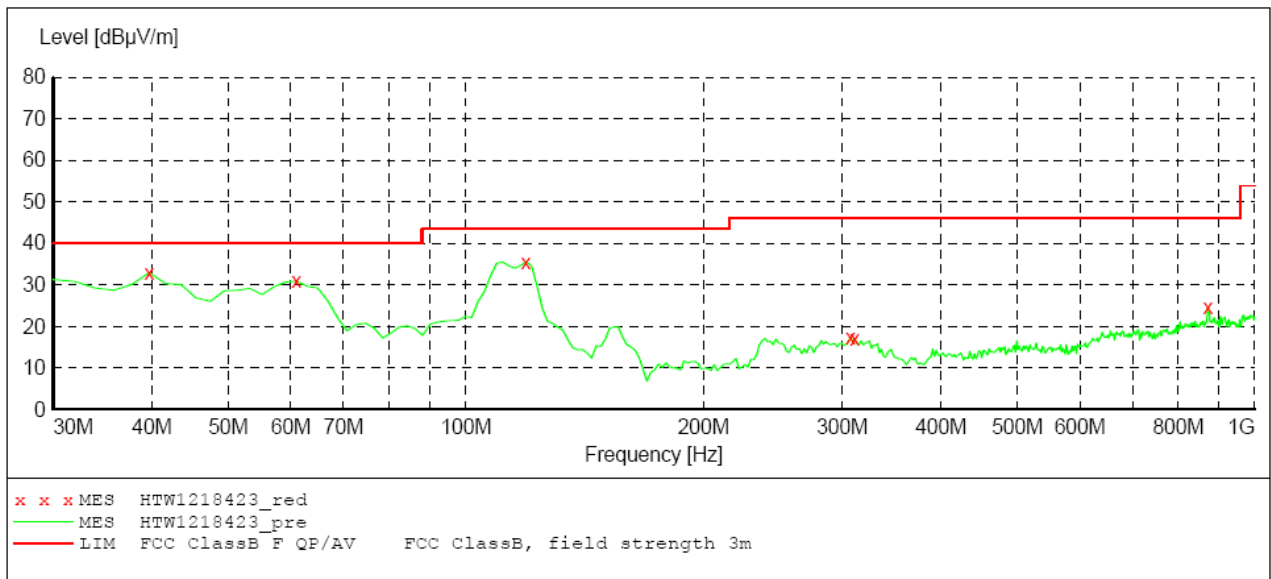

**MEASUREMENT RESULT: "HTW1218423\_red"**

12/18/2012 8:48PM

Frequency MHz	Level dBuV/m	Transd dB	Limit dBuV/m	Margin dB	Det.	Height cm	Azimuth deg	Polarization
39.700000	33.00	-16.4	40.0	7.0	PK	100.0	335.00	VERTICAL
61.040000	30.90	-24.9	40.0	9.1	PK	100.0	335.00	VERTICAL
119.240000	35.50	-19.3	43.5	8.0	PK	100.0	65.00	VERTICAL
307.420000	17.30	-16.7	46.0	28.7	PK	100.0	107.00	VERTICAL
311.300000	17.10	-16.5	46.0	28.9	PK	100.0	107.00	VERTICAL
871.960000	24.70	-6.9	46.0	21.3	PK	100.0	169.00	VERTICAL



**SWEEP TABLE: "test (30M-1G)"**

Short Description: Field Strength  
 Start Stop Detector Meas. IF Transducer  
 Frequency Frequency Time Bandw.  
 30.0 MHz 1.0 GHz MaxPeak Coupled 100 kHz HL562 201106

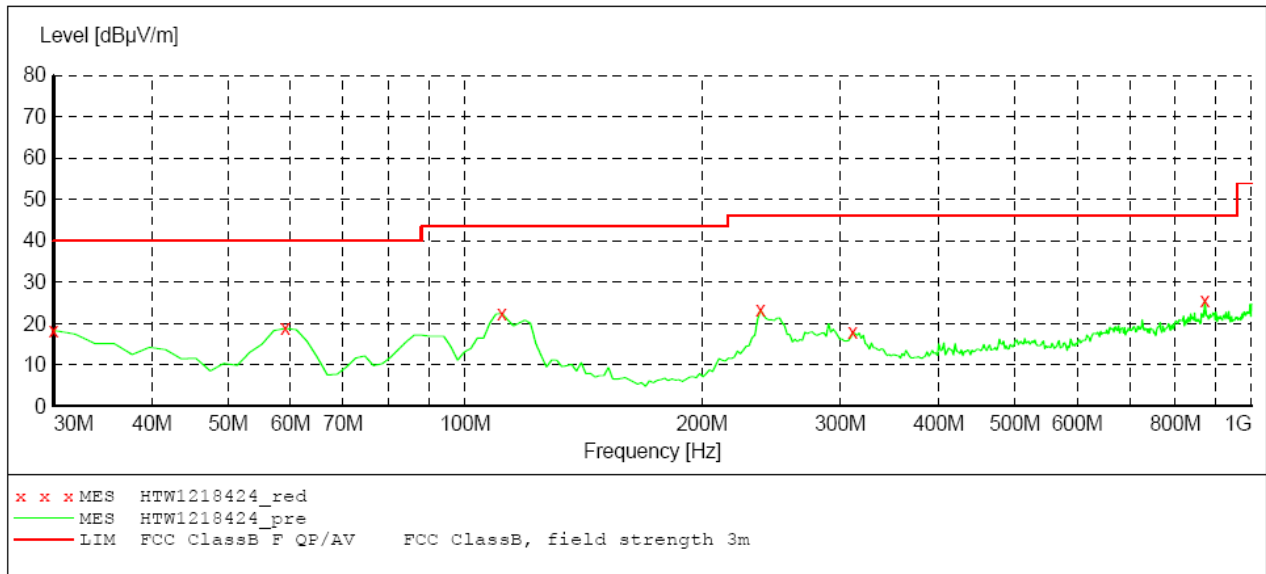

**MEASUREMENT RESULT: "HTW1218424\_red"**

12/18/2012 8:50PM

Frequency MHz	Level dBµV/m	Transd dB	Limit dBµV/m	Margin dB	Det.	Height cm	Azimuth deg	Polarization
30.000000	18.30	-11.1	40.0	21.7	PK	100.0	306.00	HORIZONTAL
59.100000	18.80	-25.0	40.0	21.2	PK	300.0	309.00	HORIZONTAL
111.480000	22.50	-19.5	43.5	21.0	PK	300.0	1.00	HORIZONTAL
237.580000	23.30	-19.1	46.0	22.7	PK	100.0	270.00	HORIZONTAL
311.300000	17.90	-16.5	46.0	28.1	PK	100.0	164.00	HORIZONTAL
871.960000	25.50	-6.9	46.0	20.5	PK	100.0	282.00	HORIZONTAL

Modulation Type	Channel Separation	Test Frequency (MHz)	Polar.	Maximum Radiated Emissions		FCC Limit (dBuV/m)
				Frequency (MHz)	Datum (dBuV/m)	
FM	12.5 KHz	155.5000	H	5909.81	41.50	54.00
			V	5979.95	41.30	54.00
Test Results			Compliance			

**SWEEP TABLE: "test (1G-18G) P"**

Short Description: EN 55022 Field Strength  
 Start Stop Detector Meas. IF Transducer  
 Frequency Frequency Time Bandw.  
 1.0 GHz 18.0 GHz MaxPeak 500.0 ms 1 MHz HF906

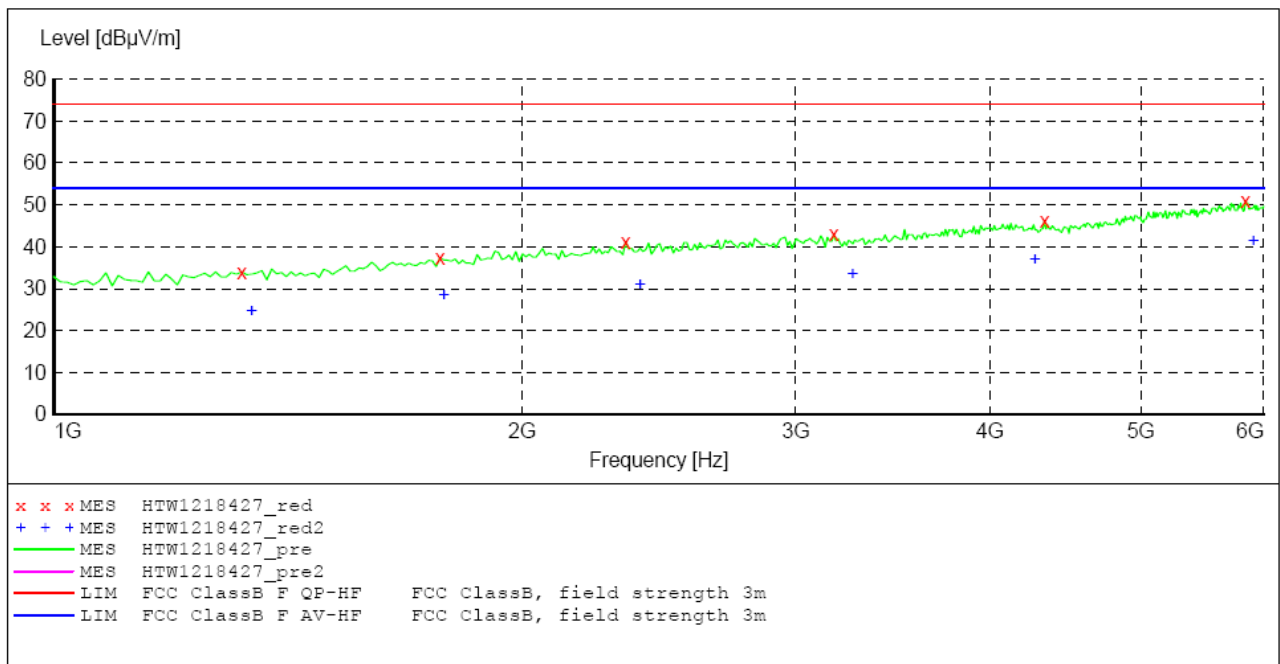

**MEASUREMENT RESULT: "HTW1218427\_red"**

12/18/2012 9:04PM

Frequency MHz	Level dBuV/m	Transd dB	Limit dBuV/m	Margin dB	Det.	Height cm	Azimuth deg	Polarization
1320.641283	34.00	-10.8	74.0	40.0	PK	100.0	272.00	HORIZONTAL
1771.543086	37.40	-8.1	74.0	36.6	PK	100.0	213.00	HORIZONTAL
2332.665331	41.20	-5.2	74.0	32.8	PK	100.0	153.00	HORIZONTAL
3174.348697	42.90	-3.0	74.0	31.1	PK	100.0	50.00	HORIZONTAL
4336.673347	46.10	-0.6	74.0	27.9	PK	100.0	344.00	HORIZONTAL
5839.679359	50.80	2.5	74.0	23.2	PK	100.0	219.00	HORIZONTAL

**MEASUREMENT RESULT: "HTW1218427\_red2"**

12/18/2012 9:04PM

Frequency MHz	Level dBuV/m	Transd dB	Limit dBuV/m	Margin dB	Det.	Height cm	Azimuth deg	Polarization
1340.681363	24.90	-10.7	54.0	29.1	AV	100.0	255.00	HORIZONTAL
1781.563126	28.60	-8.0	54.0	25.4	AV	100.0	177.00	HORIZONTAL
2382.765531	31.20	-5.0	54.0	22.8	AV	100.0	111.00	HORIZONTAL
3264.529058	33.70	-2.9	54.0	20.3	AV	100.0	219.00	HORIZONTAL
4276.553106	36.90	-0.6	54.0	17.1	AV	100.0	79.00	HORIZONTAL
5909.819639	41.50	2.6	54.0	12.5	AV	100.0	19.00	HORIZONTAL

**SWEEP TABLE: "test (1G-18G) P"**

Short Description: EN 55022 Field Strength  
 Start Stop Detector Meas. IF Transducer  
 Frequency Frequency Time Bandw.  
 1.0 GHz 18.0 GHz MaxPeak 500.0 ms 1 MHz HF906

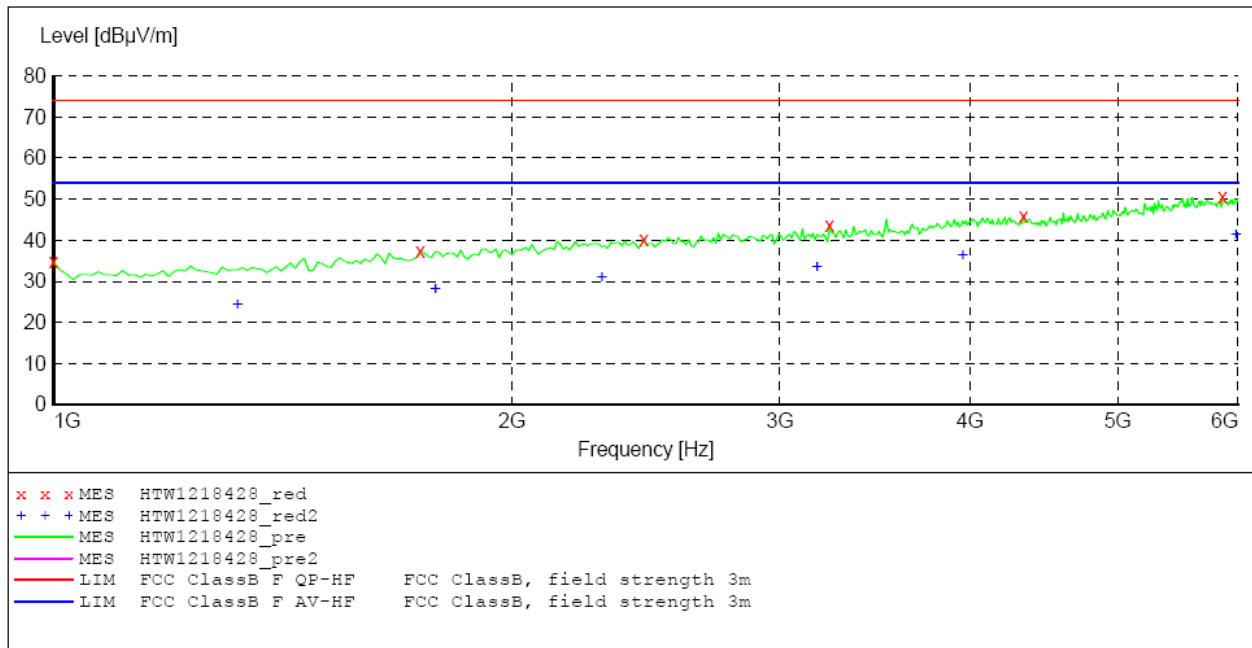

**MEASUREMENT RESULT: "HTW1218428\_red"**

12/18/2012 9:06PM

Frequency MHz	Level dBµV/m	Transd dB	Limit dBµV/m	Margin dB	Det.	Height cm	Azimuth deg	Polarization
1000.000000	34.70	-12.3	74.0	39.3	PK	100.0	288.00	HORIZONTAL
1741.482966	37.50	-8.3	74.0	36.5	PK	100.0	294.00	HORIZONTAL
2442.885772	40.20	-4.8	74.0	33.8	PK	100.0	155.00	HORIZONTAL
3234.468938	43.80	-2.9	74.0	30.2	PK	100.0	196.00	HORIZONTAL
4336.673347	46.00	-0.6	74.0	28.0	PK	100.0	131.00	HORIZONTAL
5859.719439	50.60	2.5	74.0	23.4	PK	100.0	54.00	HORIZONTAL

**MEASUREMENT RESULT: "HTW1218428\_red2"**

12/18/2012 9:06PM

Frequency MHz	Level dBµV/m	Transd dB	Limit dBµV/m	Margin dB	Det.	Height cm	Azimuth deg	Polarization
1320.641283	24.50	-10.8	54.0	29.5	AV	100.0	24.00	HORIZONTAL
1781.563126	28.20	-8.0	54.0	25.8	AV	100.0	149.00	HORIZONTAL
2292.585170	31.00	-5.4	54.0	23.0	AV	100.0	196.00	HORIZONTAL
3174.348697	33.70	-3.0	54.0	20.3	AV	100.0	330.00	HORIZONTAL
3955.911824	36.50	-0.5	54.0	17.5	AV	100.0	7.00	HORIZONTAL
5979.959920	41.30	2.6	54.0	12.7	AV	100.0	0.00	HORIZONTAL

Modulation Type	Channel Separation	Test Frequency (MHz)	Polar.	Maximum Radiated Emissions		FCC Limit (dBuV/m)
				Frequency (MHz)	Datum (dBuV/m)	
FM	12.5 KHz	440.5000	H	871.96	25.60	46.00
			V	39.70	33.00	40.00
Test Results			Compliance			

**SWEEP TABLE: "test (30M-1G)"**

Short Description: Field Strength  
 Start Stop Detector Meas. IF Transducer  
 Frequency Frequency Time Bandw.  
 30.0 MHz 1.0 GHz MaxPeak Coupled 100 kHz HL562 201106

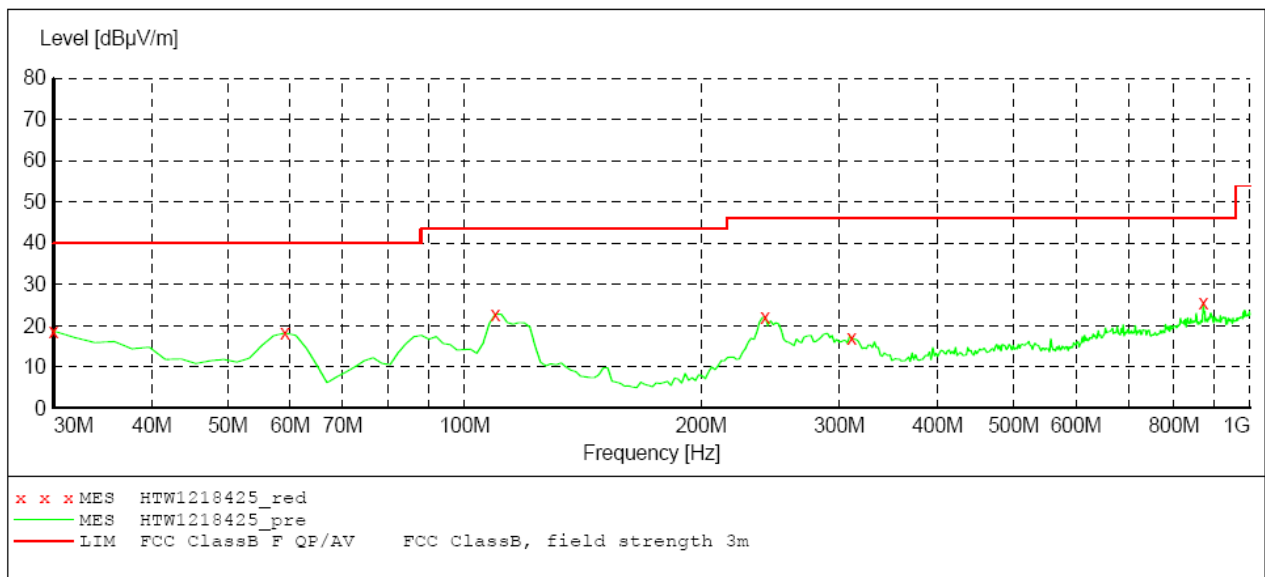

**MEASUREMENT RESULT: "HTW1218425\_red"**

12/18/2012 8:53PM

Frequency MHz	Level dBuV/m	Transd dB	Limit dBuV/m	Margin dB	Det.	Height cm	Azimuth deg	Polarization
30.000000	18.70	-11.1	40.0	21.3	PK	100.0	318.00	HORIZONTAL
59.100000	18.20	-25.0	40.0	21.8	PK	300.0	319.00	HORIZONTAL
109.540000	22.80	-19.5	43.5	20.7	PK	300.0	358.00	HORIZONTAL
241.460000	22.20	-18.9	46.0	23.8	PK	100.0	258.00	HORIZONTAL
311.300000	16.90	-16.5	46.0	29.1	PK	100.0	199.00	HORIZONTAL
871.960000	25.60	-6.9	46.0	20.4	PK	300.0	342.00	HORIZONTAL

**SWEEP TABLE: "test (30M-1G)"**

Short Description:		Field Strength			
Start	Stop	Detector	Meas. Time	IF Bandw.	Transducer
Frequency	Frequency				
30.0 MHz	1.0 GHz	MaxPeak	Coupled	100 kHz	HL562 201106

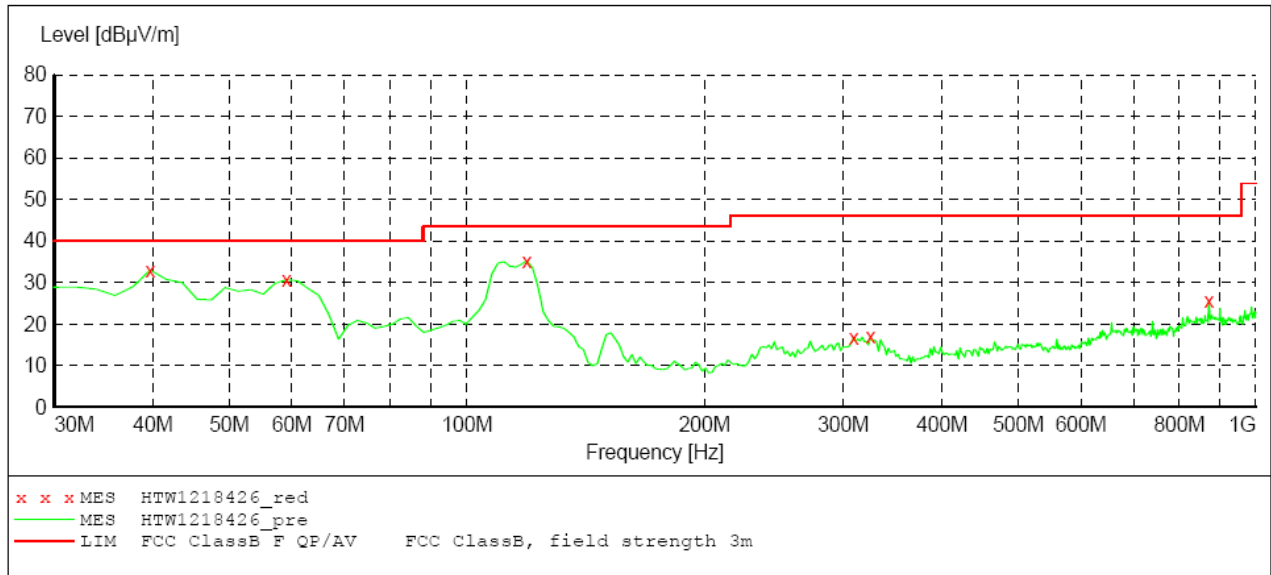

**MEASUREMENT RESULT: "HTW1218426\_red"**

12/18/2012 8:54PM

Frequency MHz	Level dBµV/m	Transd dB	Limit dBµV/m	Margin dB	Det.	Height cm	Azimuth deg	Polarization
39.700000	33.00	-16.4	40.0	7.0	PK	100.0	289.00	VERTICAL
59.100000	30.70	-25.0	40.0	9.3	PK	100.0	348.00	VERTICAL
119.240000	35.20	-19.3	43.5	8.3	PK	100.0	57.00	VERTICAL
309.360000	16.80	-16.5	46.0	29.2	PK	100.0	99.00	VERTICAL
324.880000	16.90	-16.4	46.0	29.1	PK	100.0	110.00	VERTICAL
871.960000	25.70	-6.9	46.0	20.3	PK	100.0	294.00	VERTICAL

Modulation Type	Channel Separation	Test Frequency (MHz)	Polar.	Maximum Radiated Emissions		FCC Limit (dBuV/m)
				Frequency (MHz)	Datum (dBuV/m)	
FM	12.5 KHz	440.5000	H	6000.00	40.90	54.00
			V	5769.53	41.40	54.00
Test Results			Compliance			

**SWEEP TABLE: "test (1G-18G) P"**

Short Description: EN 55022 Field Strength  
 Start Stop Detector Meas. IF Transducer  
 Frequency Frequency Time Bandw.  
 1.0 GHz 18.0 GHz MaxPeak 500.0 ms 1 MHz HF906

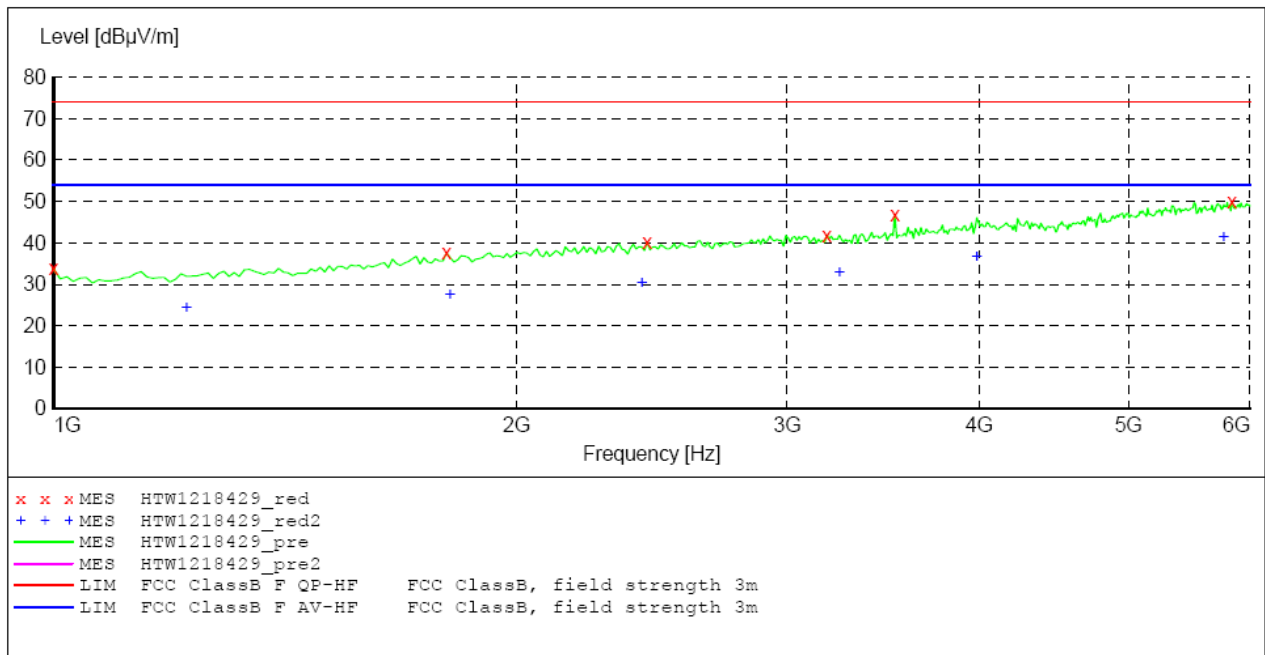

**MEASUREMENT RESULT: "HTW1218429\_red"**

12/18/2012 9:08PM

Frequency MHz	Level dBuV/m	Transd dB	Limit dBuV/m	Margin dB	Det.	Height cm	Azimuth deg	Polarization
1000.000000	33.80	-12.3	74.0	40.2	PK	100.0	257.00	VERTICAL
1801.603206	37.60	-7.9	74.0	36.4	PK	100.0	308.00	VERTICAL
2432.865731	40.10	-4.9	74.0	33.9	PK	100.0	209.00	VERTICAL
3184.368737	41.90	-3.0	74.0	32.1	PK	100.0	332.00	VERTICAL
3525.050100	46.70	-2.4	74.0	27.3	PK	100.0	301.00	VERTICAL
5839.679359	49.90	2.5	74.0	24.1	PK	100.0	228.00	VERTICAL

**MEASUREMENT RESULT: "HTW1218429\_red2"**

12/18/2012 9:09PM

Frequency MHz	Level dBuV/m	Transd dB	Limit dBuV/m	Margin dB	Det.	Height cm	Azimuth deg	Polarization
1220.440882	24.60	-11.2	54.0	29.4	AV	100.0	61.00	VERTICAL
1811.623246	27.70	-7.8	54.0	26.3	AV	100.0	167.00	VERTICAL
2412.825651	30.50	-4.9	54.0	23.5	AV	100.0	119.00	VERTICAL
3244.488978	33.00	-2.9	54.0	21.0	AV	100.0	234.00	VERTICAL
3985.971944	36.70	-0.4	54.0	17.3	AV	100.0	31.00	VERTICAL
5769.539078	41.40	2.4	54.0	12.6	AV	100.0	203.00	VERTICAL

**SWEEP TABLE: "test (1G-18G) P"**

Short Description: EN 55022 Field Strength  
 Start Stop Detector Meas. IF Transducer  
 Frequency Frequency Time Bandw.  
 1.0 GHz 18.0 GHz MaxPeak 500.0 ms 1 MHz HF906

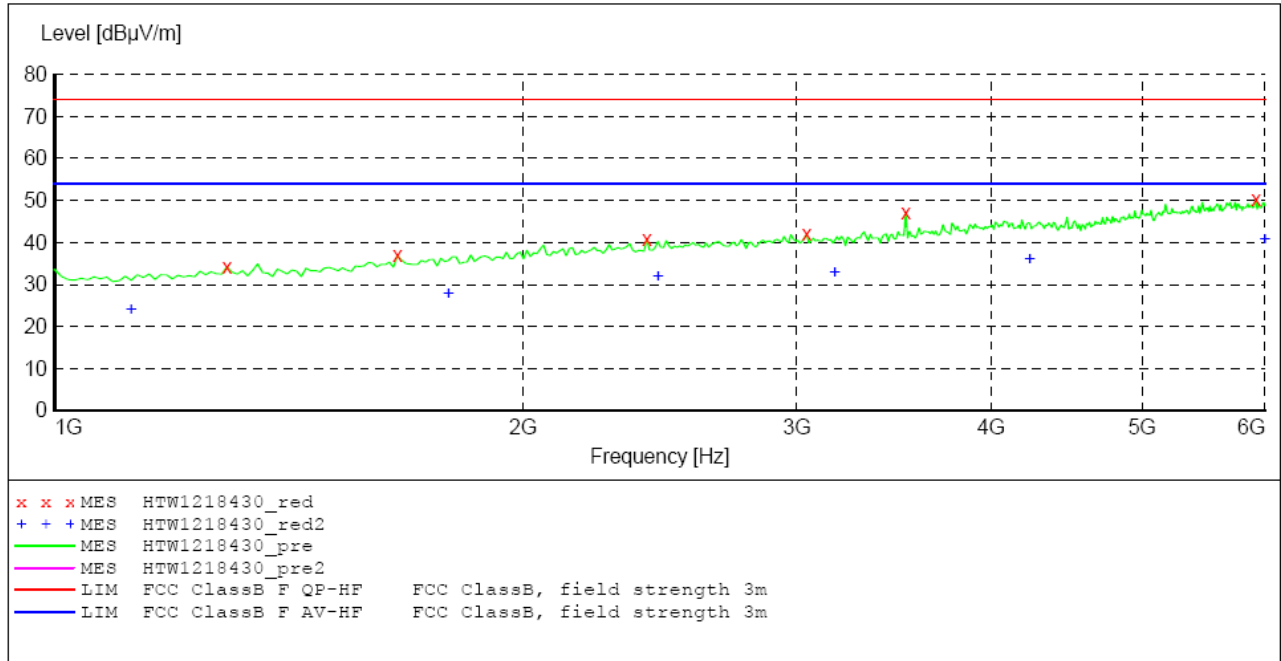

**MEASUREMENT RESULT: "HTW1218430\_red"**

12/18/2012 9:10PM

Frequency MHz	Level dBµV/m	Transd dB	Limit dBµV/m	Margin dB	Det.	Height cm	Azimuth deg	Polarization
1290.581162	34.20	-10.9	74.0	39.8	PK	100.0	350.00	VERTICAL
1661.322645	36.90	-8.8	74.0	37.1	PK	100.0	231.00	VERTICAL
2402.805611	40.70	-5.0	74.0	33.3	PK	100.0	63.00	VERTICAL
3044.088176	42.00	-3.2	74.0	32.0	PK	100.0	81.00	VERTICAL
3525.050100	47.00	-2.4	74.0	27.0	PK	100.0	33.00	VERTICAL
5919.839679	50.40	2.6	74.0	23.6	PK	100.0	344.00	VERTICAL

**MEASUREMENT RESULT: "HTW1218430\_red2"**

12/18/2012 9:10PM

Frequency MHz	Level dBµV/m	Transd dB	Limit dBµV/m	Margin dB	Det.	Height cm	Azimuth deg	Polarization
1120.240481	24.00	-11.7	54.0	30.0	AV	100.0	267.00	VERTICAL
1791.583166	27.90	-7.9	54.0	26.1	AV	100.0	225.00	VERTICAL
2442.885772	31.90	-4.8	54.0	22.1	AV	100.0	183.00	VERTICAL
3174.348697	32.80	-3.0	54.0	21.2	AV	100.0	207.00	VERTICAL
4236.472946	36.00	-0.5	54.0	18.0	AV	100.0	332.00	VERTICAL
6000.000000	40.90	2.6	54.0	13.1	AV	100.0	45.00	VERTICAL

### 4.10. Receiver Conducted Spurious Emssion (For Volunteer)

#### TEST APPLICABLE

The same as Section 4.3

#### TEST PROCEDURE

The spectrum analyzer was connected to the RF output power of the EUT, the EUT was setup in receiving mode; The RBW of the spectrum analyzer was set to 100 kHz and the VBW set to 300 KHz below the test frequency 1GHz. While the RBW of the spectrum analyzer was set to the 1MHz and VBW set to the 3MHz from 1GHz to the 10<sup>th</sup> harmonic.

#### TEST CONFIGURATION

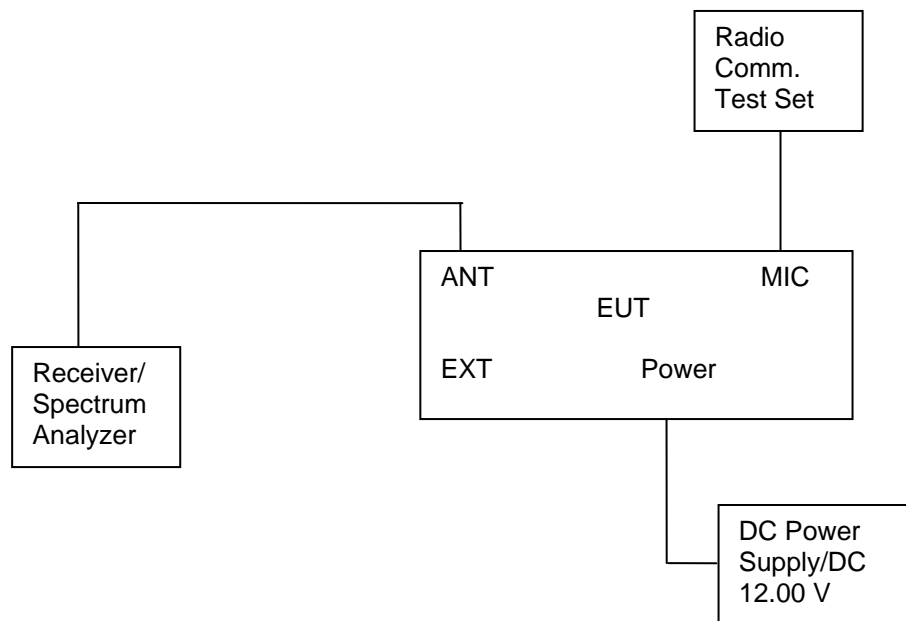

#### LIMIT

The power at the antenna terminal shall not exceed 2.0 nanowatts (-57dBm).

#### TEST RESULTS

The Receiver Conducted Spurious Emssions Measurement is performed to the five channels (the top channel, the middle channel and the bottom channel), the datums recorded below were for the five channels; and the EUT shall be scanned from 30 MHz to the 5 GHz.





Modulation Type	Channel Sparation	Test Channel	Test Frequency (MHz)	Maximum Conducted Spurious Emissions Below 1GHz		Maximum Conducted Spurious Emissions Above 1GHz		FCC Limit
				Frequency (MHz)	Datum (dBm)	Frequency (MHz)	Datum (dBm)	
FM	12.5KHz	Middle	155.5000	846.74	-82.66	3664.00	-75.54	-57dBm
Test Results				Compliance				

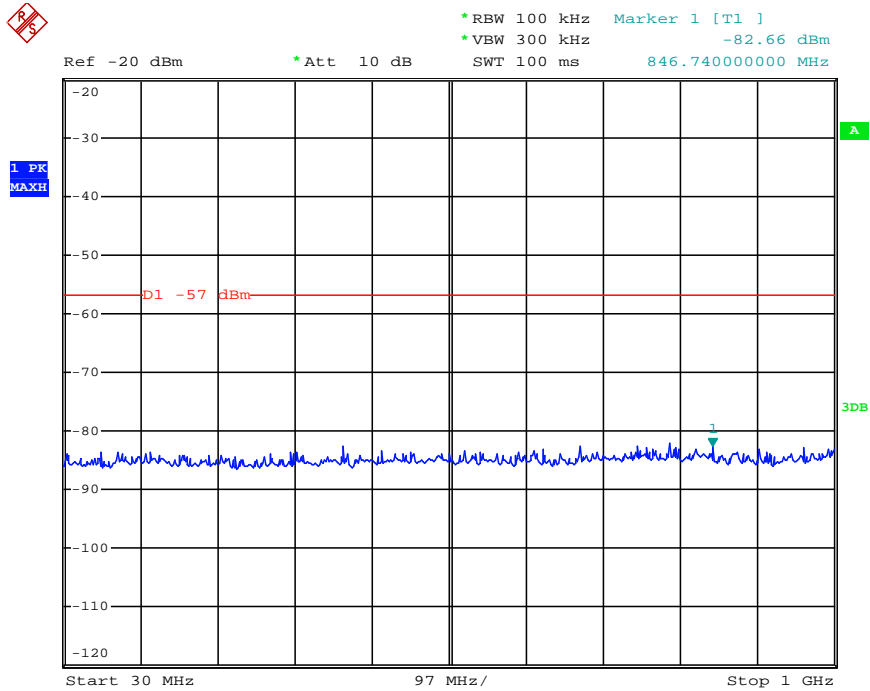

Date: 18.DEC.2012 10:02:42

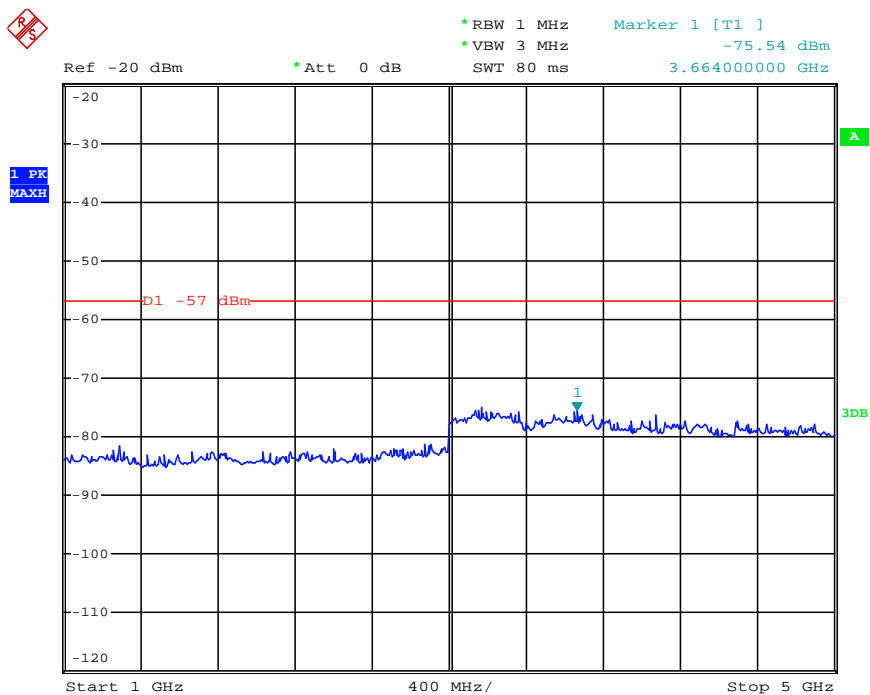

Date: 18.DEC.2012 10:03:22

Modulation Type	Channel Sparation	Test Channel	Test Frequency (MHz)	Maximum Conducted Spurious Emissions Below 1GHz		Maximum Conducted Spurious Emissions Above 1GHz		FCC Limit
				Frequency (MHz)	Datum (dBm)	Frequency (MHz)	Datum (dBm)	
FM	12.5KHz	High	173.5000	619.76	-83.51	4168.00	-74.12	-57dBm
Test Results				Compliance				

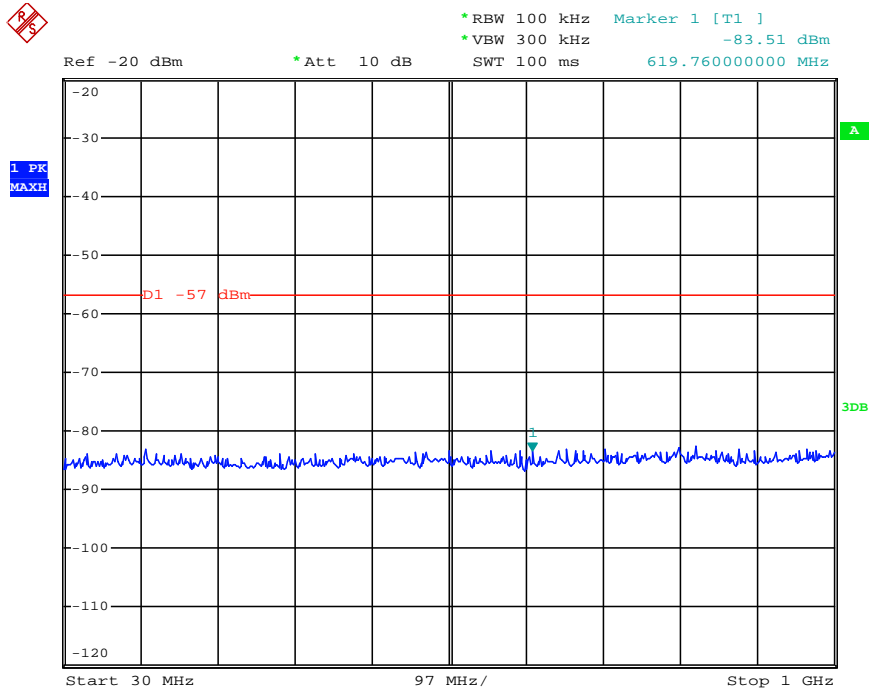

Date: 18.DEC.2012 10:06:09

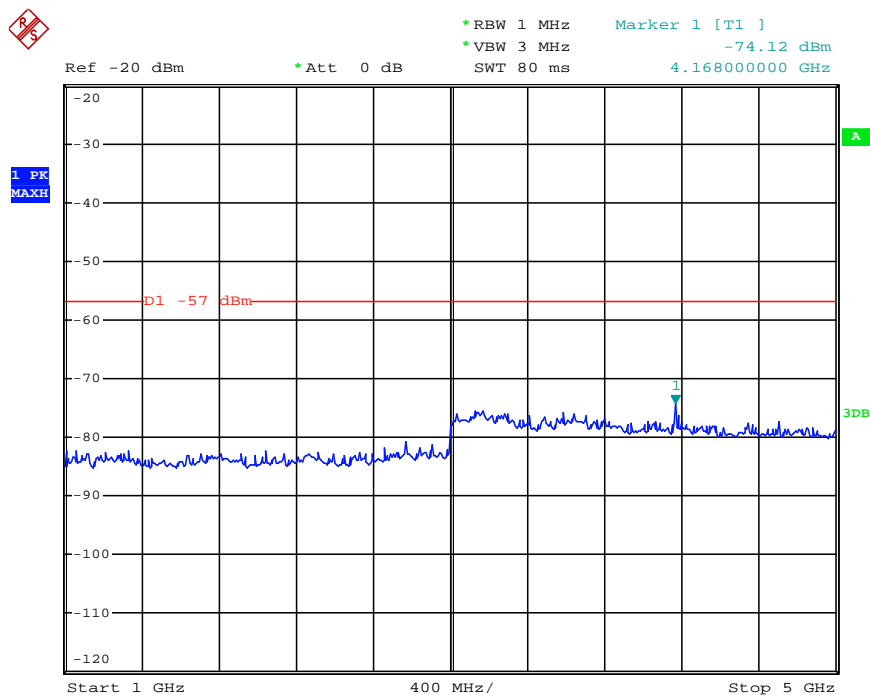

Date: 18.DEC.2012 10:07:03

Modulation Type	Channel SpARATION	Test Channel	Test Frequency (MHz)	Maximum Conducted Spurious Emissions Below 1GHz		Maximum Conducted Spurious Emissions Above 1GHz		FCC Limit
				Frequency (MHz)	Datum (dBm)	Frequency (MHz)	Datum (dBm)	
FM	12.5KHz	Low	400.5000	718.70	-83.01	3208.00	-69.38	-57dBm
Test Results				Compliance				

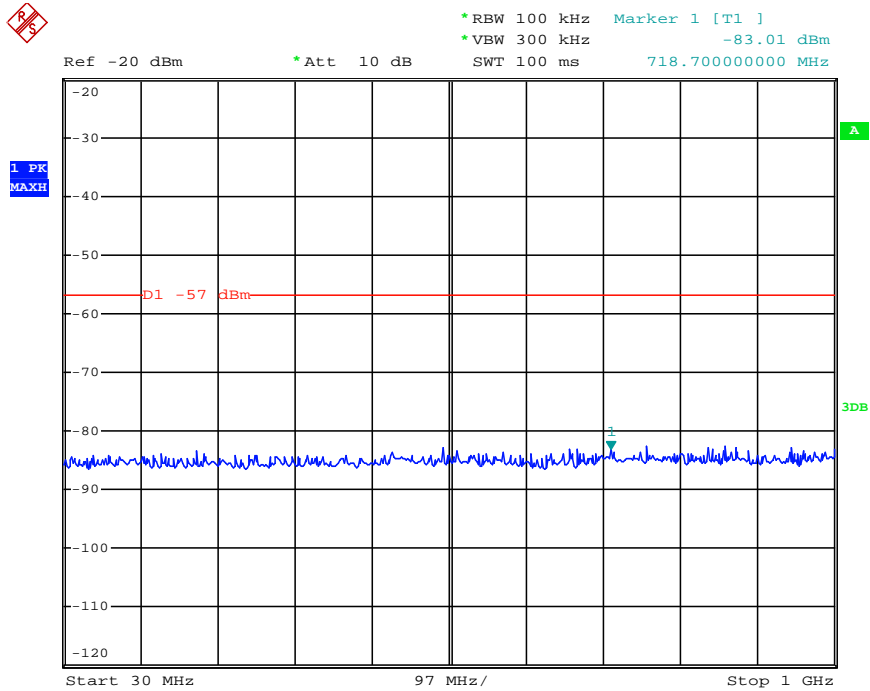

Date: 18.DEC.2012 10:05:25

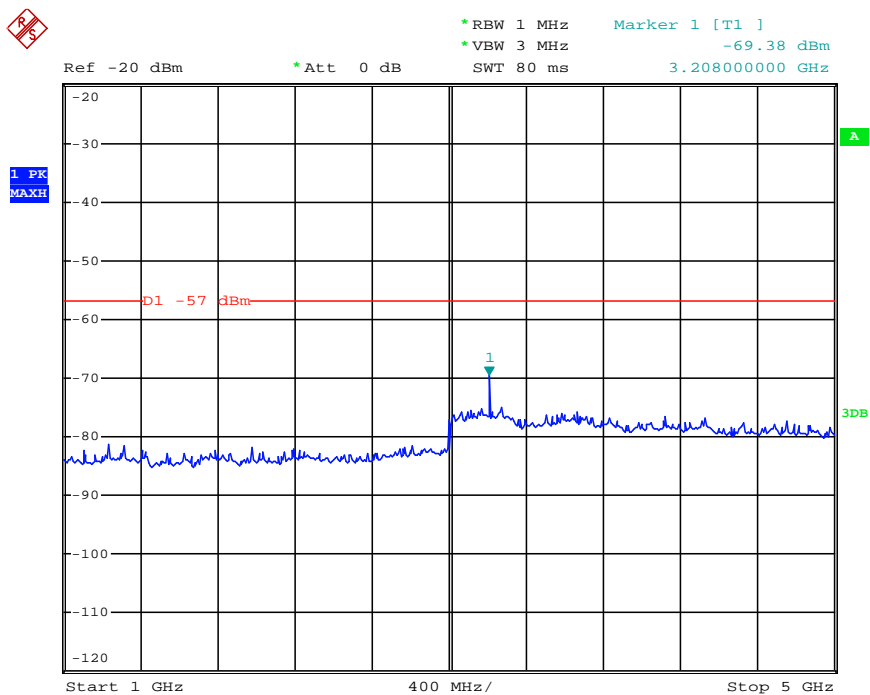

Date: 18.DEC.2012 10:04:23



Modulation Type	Channel SpARATION	Test Channel	Test Frequency (MHz)	Maximum Conducted Spurious Emissions Below 1GHz		Maximum Conducted Spurious Emissions Above 1GHz		FCC Limit
				Frequency (MHz)	Datum (dBm)	Frequency (MHz)	Datum (dBm)	
FM	12.5KHz	High	479.5000	997.18	-83.12	3192.00	-75.51	-57dBm
Test Results				Compliance				

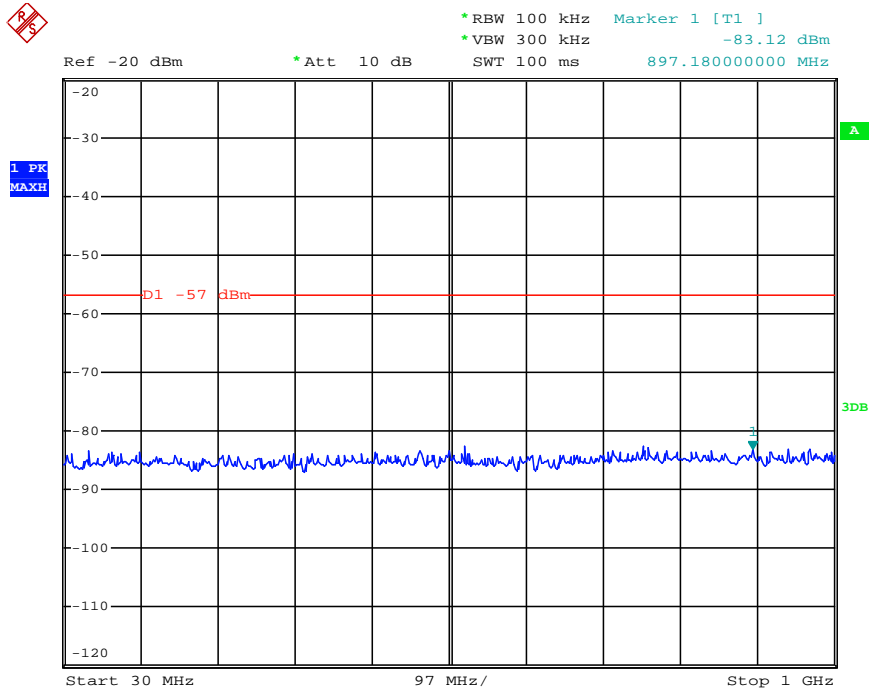

Date: 18.DEC.2012 10:06:26

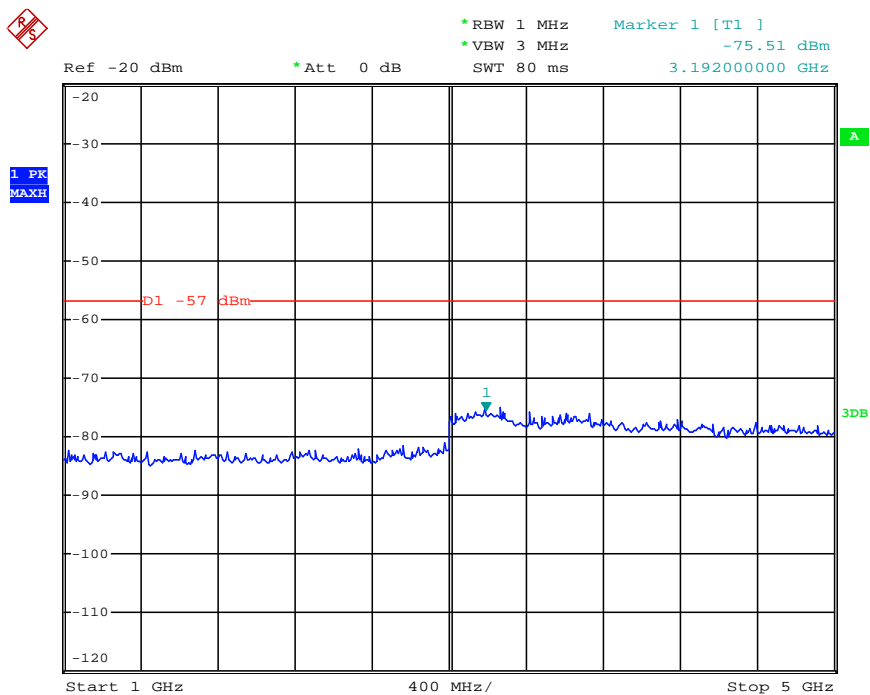

Date: 18.DEC.2012 10:07:22

## 5. Test Setup Photos of the EUT

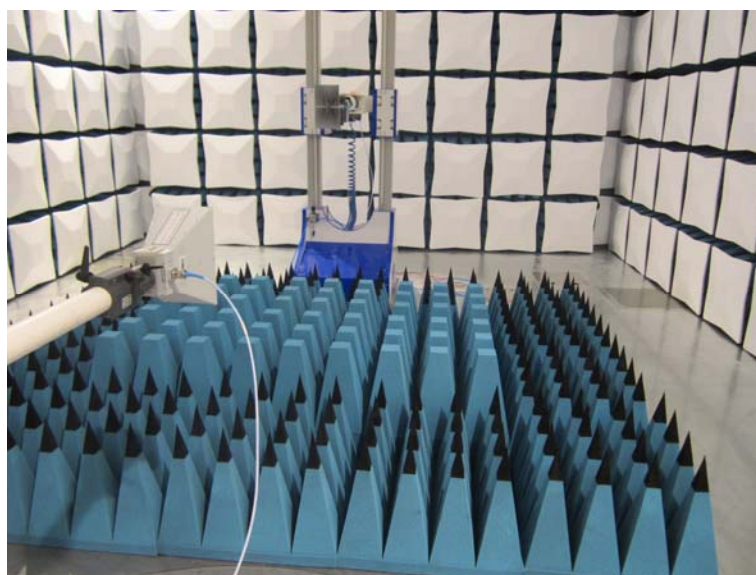

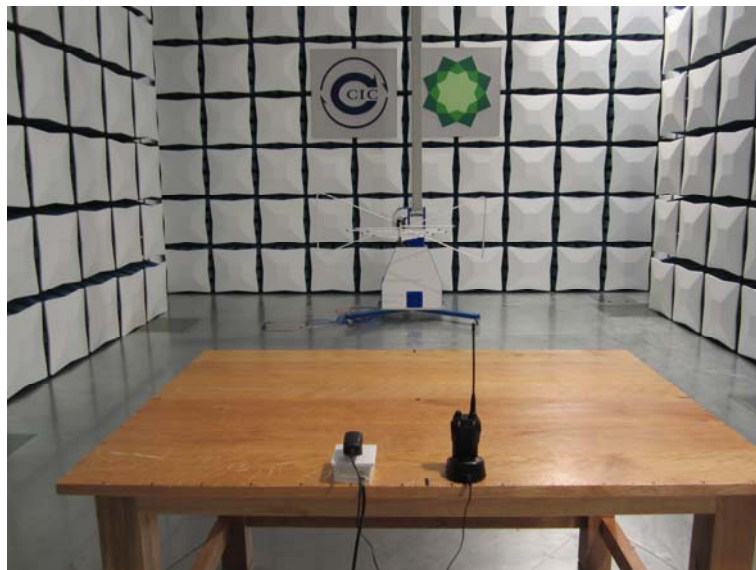



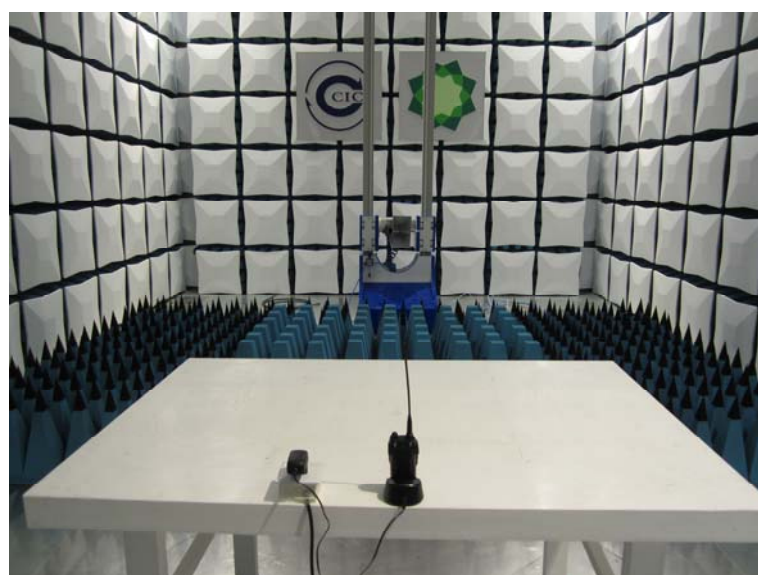

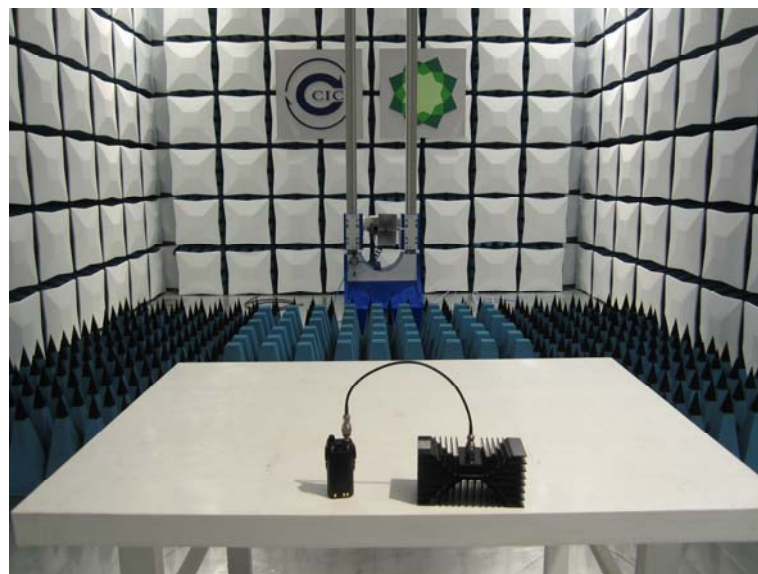
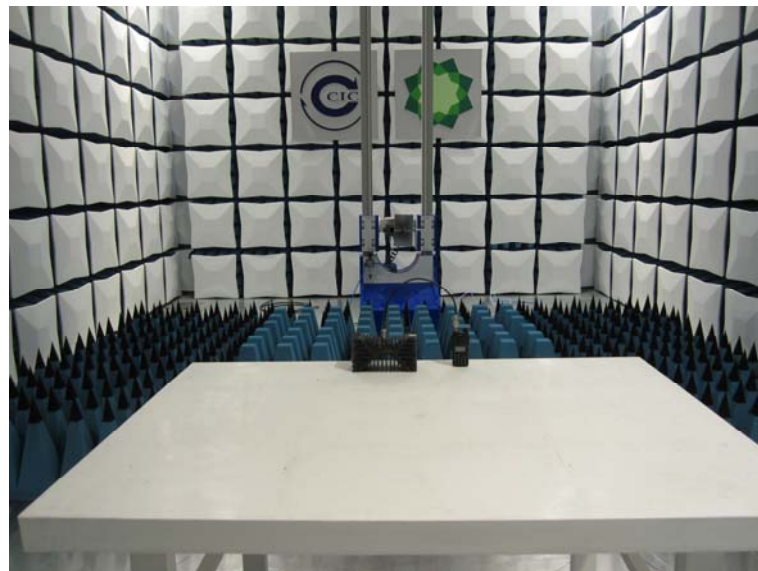

## 6. External and Internal Photos of the EUT

### External photos of the EUT







Internal photos of the EUT



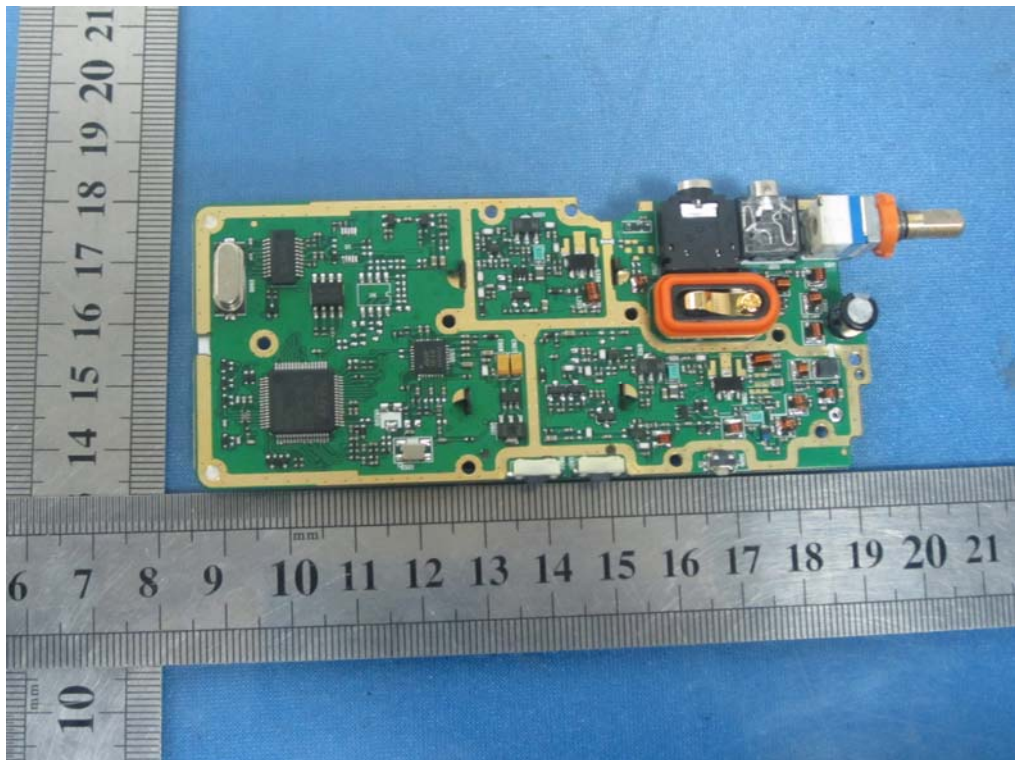

.....End of Report.....