



Test Report No.: W7L-231127W001RF01



# FCC TEST REPORT (Part 15, Subpart C)



Applicant:	Telit Communications S.p.A
Address:	Via Stazione di Prosecco 5/b, 34010 Sgonico - Trieste, Italy

Manufacturer or Supplier:	Telit Communications S.p.A
Address:	Via Stazione di Prosecco 5/b, 34010 Sgonico - Trieste, Italy
Product:	802.11 a/b/g/n/ac/ax WiFi Module+BT combo module
Brand Name:	Telit Cinterion
Model Name:	WE310K6-P / WE310K6-P M.2
FCC ID:	RI7WE310K6P
Date of tests:	Jan. 02, 2024 ~ Apr. 25, 2024

The tests have been carried out according to the requirements of the following standard:

- FCC Part 15, Subpart C, Section 15.247
- ANSI C63.10-2020

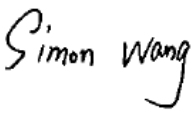
**CONCLUSION: The submitted sample was found to COMPLY with the test requirement**

Prepared by Simon Wang Engineer / Mobile Department	Approved by Luke Lu Manager / Mobile Department
 Date: Apr. 25, 2024	 Date: Apr. 25, 2024

This report is governed by, and incorporates by reference, the Conditions of Testing as posted at the date of issuance of this report at <http://www.bureauveritas.com/home/about-us/our-business/cps/about-us/terms-conditions/> and is intended for your exclusive use. Any copying or replication of this report to or for any other person or entity, or use of our name or trademark, is permitted only with our prior written permission. This report sets forth our findings solely with respect to the test samples identified herein. The results set forth in this report are not indicative or representative of the quality or characteristics of the lot from which a test sample was taken or any similar or identical product unless specifically and expressly noted. Our report includes all of the tests requested by you and the results thereof based upon the information that you provided to us. Measurement uncertainty is only provided upon request for accredited tests. Statements of conformity are based on simple acceptance criteria without taking measurement uncertainty into account, unless otherwise requested in writing. You have 60 days from date of issuance of this report to notify us of any material error or omission caused by our negligence or if you require measurement uncertainty; provided, however, that such notice shall be in writing and shall specifically address the issue you wish to raise. A failure to raise such issue within the prescribed time shall constitute your unqualified acceptance of the completeness of this report, the tests conducted and the correctness of the report contents.



# TABLE OF CONTENTS

**RELEASE CONTROL RECORD ..... 5**

**1 SUMMARY OF TEST RESULTS..... 6**

**1.1 MEASUREMENT UNCERTAINTY ..... 7**

**2 GENERAL INFORMATION ..... 8**

**2.1 GENERAL DESCRIPTION OF EUT ..... 8**

**2.2 DESCRIPTION OF TEST MODES ..... 10**

        2.2.1 CONFIGURATION OF SYSTEM UNDER TEST ..... 11

        2.2.2 TEST MODE APPLICABILITY AND TESTED CHANNEL DETAIL..... 11

**2.3 GENERAL DESCRIPTION OF APPLIED STANDARDS ..... 13**

**2.4 DESCRIPTION OF SUPPORT UNITS..... 13**

**3 TEST TYPES AND RESULTS..... 14**

**3.1 CONDUCTED EMISSION MEASUREMENT..... 14**

        3.1.1 LIMITS OF CONDUCTED EMISSION MEASUREMENT ..... 14

        3.1.2 TEST INSTRUMENTS..... 14

        3.1.3 TEST PROCEDURES ..... 14

        3.1.4 DEVIATION FROM TEST STANDARD ..... 15

        3.1.5 TEST SETUP ..... 15

        3.1.6 EUT OPERATING CONDITIONS ..... 15

        3.1.7 TEST RESULTS ..... 16

**3.2 RADIATED EMISSION AND BANDEDGE MEASUREMENT ..... 18**

        3.2.1 LIMITS OF RADIATED EMISSION AND BANDEDGE MEASUREMENT..... 18

        3.2.2 TEST INSTRUMENTS..... 19

        3.2.3 TEST PROCEDURES ..... 20

        3.2.4 DEVIATION FROM TEST STANDARD ..... 20

        3.2.5 TEST SETUP ..... 21

        3.2.6 EUT OPERATING CONDITIONS ..... 22

        3.2.7 TEST RESULTS ..... 23

**3.3 NUMBER OF HOPPING FREQUENCY USED ..... 30**

        3.3.1 LIMIT OF HOPPING FREQUENCY USED ..... 30

        3.3.2 TEST SETUP ..... 30

        3.3.3 TEST INSTRUMENTS..... 30

        3.3.4 TEST PROCEDURES ..... 31

        3.3.5 DEVIATION FROM TEST STANDARD ..... 31

        3.3.6 TEST RESULTS ..... 31

**3.4 DWELL TIME ON EACH CHANNEL ..... 32**



**BUREAU  
VERITAS**

**Test Report No.: W7L-231127W001RF01**

3.4.1	LIMIT OF DWELL TIME USED .....	32
3.4.2	TEST SETUP .....	32
3.4.3	TEST INSTRUMENTS .....	32
3.4.4	TEST PROCEDURES .....	32
3.4.5	DEVIATION FROM TEST STANDARD .....	33
3.4.6	TEST RESULTS .....	33
<b>3.5</b>	<b>CHANNEL BANDWIDTH .....</b>	<b>34</b>
3.5.1	LIMITS OF CHANNEL BANDWIDTH .....	34
3.5.2	TEST SETUP .....	34
3.5.3	TEST INSTRUMENTS .....	34
3.5.4	TEST PROCEDURE .....	34
3.5.5	DEVIATION FROM TEST STANDARD .....	34
3.5.6	EUT OPERATING CONDITION .....	35
3.5.7	TEST RESULTS .....	35
<b>3.6</b>	<b>HOPPING CHANNEL SEPARATION .....</b>	<b>36</b>
3.6.1	LIMIT OF HOPPING CHANNEL SEPARATION .....	36
3.6.2	TEST SETUP .....	36
3.6.3	TEST INSTRUMENTS .....	36
3.6.4	TEST PROCEDURES .....	36
3.6.5	DEVIATION FROM TEST STANDARD .....	36
3.6.6	TEST RESULTS .....	37
<b>3.7</b>	<b>MAXIMUM OUTPUT POWER .....</b>	<b>37</b>
3.7.1	LIMITS OF MAXIMUM OUTPUT POWER MEASUREMENT .....	37
3.7.2	TEST SETUP .....	37
3.7.3	TEST INSTRUMENTS .....	37
3.7.4	TEST PROCEDURES .....	37
3.7.5	DEVIATION FROM TEST STANDARD .....	38
3.7.6	EUT OPERATING CONDITION .....	38
3.7.7	TEST RESULTS .....	39
3.7.7.1	MAXIMUM PEAK OUTPUT POWER .....	39
3.7.7.2	AVERAGE OUTPUT POWER (FOR REFERENCE) .....	40
<b>3.8</b>	<b>OUT OF BAND MEASUREMENT .....</b>	<b>41</b>
3.8.1	LIMITS OF OUT OF BAND MEASUREMENT .....	41
3.8.2	TEST INSTRUMENTS .....	41
3.8.3	TEST PROCEDURE .....	41
3.8.4	DEVIATION FROM TEST STANDARD .....	41



**BUREAU  
VERITAS**

**Test Report No.: W7L-231127W001RF01**

3.8.5	EUT OPERATING CONDITION .....	41
3.8.6	TEST RESULTS .....	41
<b>4</b>	<b>PHOTOGRAPHS OF THE TEST CONFIGURATION.....</b>	<b>42</b>
<b>5</b>	<b>MODIFICATIONS RECORDERS FOR ENGINEERING CHANGES TO THE EUT BY THE LAB</b>	<b>43</b>
<b>6</b>	<b>APPENDIX .....</b>	<b>44</b>



Test Report No.: W7L-231127W001RF01

## RELEASE CONTROL RECORD

ISSUE NO.	REASON FOR CHANGE	DATE ISSUED
W7L-231127W001RF01	Original release	Apr. 25, 2024



BUREAU  
VERITAS

Test Report No.: W7L-231127W001RF01

## 1 SUMMARY OF TEST RESULTS

The EUT has been tested according to the following specifications:

APPLIED STANDARD: FCC Part 15, Subpart C		
STANDARD	TEST TYPE AND LIMIT	RESULT
15.207	AC Power Conducted Emission	Compliance
15.247(a)(1) (iii)	Number of Hopping Frequency Used	Compliance
15.247(a)(1) (iii)	Dwell Time on Each Channel	Compliance
15.247(a)(1)	1. Hopping Channel Separation 2. Spectrum Bandwidth of a Frequency Hopping Sequence Spread Spectrum System	Compliance
15.247(b)	Maximum Peak Output Power	Compliance
15.247(d)& 15.209	Transmitter Radiated Emissions	Compliance
15.247(d)	Out of band Measurement	Compliance
15.203	Antenna Requirement	Compliance

### NOTE:

1. If the Frequency Hopping System operating in 2400-2483.5MHz band and the output power less than 125mW. The hopping channel carrier frequencies separated by a minimum of 25kHz or two-thirds of the 20dB bandwidth of hopping channel whichever is greater.
2. The system shall hop to channel frequencies that are selected at the system hopping rate from a pseudo randomly ordered list of hopping frequencies. Each frequency must be used equally on the average by each transmitter. The system receivers shall have input bandwidths that match the hopping channel bandwidths of their corresponding transmitters and shall shift frequencies in synchronization with the transmitted signals.

### Test Lab Information Reference:

BV 7Layers Communications Technology (Shenzhen) Co., Ltd

#### Lab Address:

Room B37, Warehouse A5, No.3 Chiwan 4th Road, Zhaoshang Street, Nanshan District Shenzhen, Guangdong, People's Republic of China

Accredited Test Lab Cert 3939.01



Test Report No.: W7L-231127W001RF01

## 1.1 MEASUREMENT UNCERTAINTY

Where relevant, the following measurement uncertainty levels have been estimated for tests performed on the EUT as specified in CISPR 16-4-2:

MEASUREMENT	UNCERTAINTY
AC Power Conducted emissions	±2.70dB
Radiated emissions (9KHz~30MHz)	±2.68dB
Radiated emissions (30MHz~1GHz)	±4.98dB
Radiated emissions (1GHz ~6GHz)	±4.70dB
Radiated emissions (6GHz ~18GHz)	±4.60dB
Radiated emissions (18GHz ~40GHz)	±4.12dB
Conducted emissions	±4.01dB
Occupied Channel Bandwidth	±43.58KHz
Conducted Output power	±2.06dB
Power Spectral Density	±0.85 dB

This uncertainty represents an expanded uncertainty expressed at approximately the 95% confidence level using a coverage factor of k=2.



## 2 GENERAL INFORMATION

### 2.1 GENERAL DESCRIPTION OF EUT

<b>PRODUCT</b>	802.11 a/b/g/n/ac/ax WiFi Module+BT combo module
<b>BRAND NAME</b>	Telit Cinterion
<b>MODEL NAME</b>	WE310K6-P / WE310K6-P M.2
<b>NOMINAL VOLTAGE</b>	3.3Vdc
<b>MODULATION TECHNOLOGY</b>	FHSS
<b>MODULATION TYPE</b>	GFSK, 8DPSK, $\pi/4$ DQPSK
<b>OPERATING FREQUENCY</b>	2402MHz~2480MHz
<b>NUMBER OF CHANNEL</b>	79
<b>MAX. OUTPUT POWER</b>	6.22mW (Max. Measured)
<b>ANTENNA TYPE</b>	Dipole Antenna with 2.5dBi gain
<b>HW VERSION</b>	1.0
<b>SW VERSION</b>	V0.29.29.0
<b>I/O PORTS</b>	Refer to user's manual
<b>CABLE SUPPLIED</b>	N/A

**NOTE:**

1. For a more detailed features description, please refer to the manufacturer's specifications or the user's manual.
2. For the test results, the EUT had been tested with all conditions. But only the worst case was shown in test report.
3. Antenna gain and EUT conducted cable loss are provided by the customer, and the laboratory will record the results based on these items that involve these two parameters.
4. WE310K6-P and WE310K6-P M.2 have been tested and the results of them is similar. So the report only show the data for the worst model (WE310K6-P).

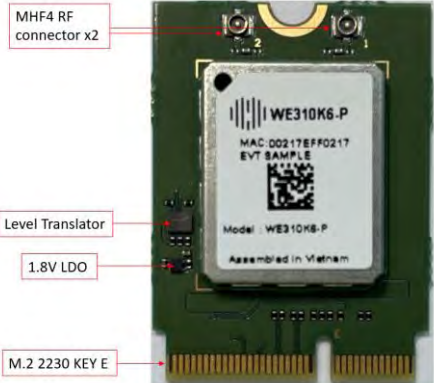
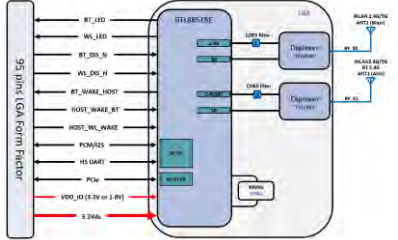
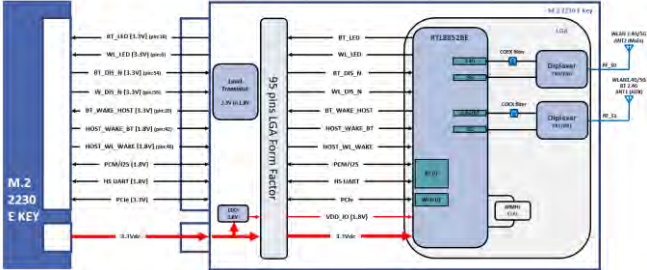

5. The differences between WE310K6-P and WE310K6-P M.2 are as follows:

WE310K6-P	WE310K6-P M.2
	
	

The Main difference is whether the LGA module is mounted on the M.2 interface adapter board.

WE310K6-P: LGA module.

WE310K6-P M.2: LGA module + M.2 2230 E KEY interface adapter board.



Test Report No.: W7L-231127W001RF01

## 2.2 DESCRIPTION OF TEST MODES

79 channels are provided to this EUT:

CHANNEL	FREQ. (MHz)	CHANNEL	FREQ. (MHz)	CHANNEL	FREQ. (MHz)	CHANNEL	FREQ. (MHz)
0	2402	20	2422	40	2442	60	2462
1	2403	21	2423	41	2443	61	2463
2	2404	22	2424	42	2444	62	2464
3	2405	23	2425	43	2445	63	2465
4	2406	24	2426	44	2446	64	2466
5	2407	25	2427	45	2447	65	2467
6	2408	26	2428	46	2448	66	2468
7	2409	27	2429	47	2449	67	2469
8	2410	28	2430	48	2450	68	2470
9	2411	29	2431	49	2451	69	2471
10	2412	30	2432	50	2452	70	2472
11	2413	31	2433	51	2453	71	2473
12	2414	32	2434	52	2454	72	2474
13	2415	33	2435	53	2455	73	2475
14	2416	34	2436	54	2456	74	2476
15	2417	35	2437	55	2457	75	2477
16	2418	36	2438	56	2458	76	2478
17	2419	37	2439	57	2459	77	2479
18	2420	38	2440	58	2460	78	2480
19	2421	39	2441	59	2461		



## 2.2.1 CONFIGURATION OF SYSTEM UNDER TEST

Please see section 4 photograph of the test configuration for reference.

## 2.2.2 TEST MODE APPLICABILITY AND TESTED CHANNEL DETAIL

Pre-Scan has been conducted to determine the worst-case mode from all possible combinations between available modulations, data rates, XYZ axis and antenna ports.

The worst case was found when positioned on X axis for radiated emission.

Following channel(s) was (were) selected for the final test as listed below:

EUT CONFIGURE MODE	APPLICABLE TO				DESCRIPTION
	RE<1G	RE≥1G	PLC	APCM	
-	√	√	√	√	-

Where **RE<1G**: Radiated Emission below 1GHz  
**PLC**: Power Line Conducted Emission

**RE≥1G**: Radiated Emission above 1GHz  
**APCM**: Antenna Port Conducted Measurement

### RADIATED EMISSION TEST (BELOW 1 GHz):

- Pre-Scan has been conducted to determine the worst-case mode from all possible combinations between available modulations, XYZ axis, antenna ports (if EUT with antenna diversity architecture) and packet type.
- The following channel(s) was (were) selected for the final test as listed below.

EUT CONFIGURE MODE	AVAILABLE CHANNEL	TESTED CHANNEL	MODULATION TECHNOLOGY	MODULATION TYPE	PACKET TYPE
-	0 to 78	78	FHSS	GFSK	1DH5

### RADIATED EMISSION TEST (ABOVE 1 GHz):

- Pre-Scan has been conducted to determine the worst-case mode from all possible combinations between available modulations, XYZ axis, antenna ports (if EUT with antenna diversity architecture) and packet type.
- The following channel(s) was (were) selected for the final test as listed below.

EUT CONFIGURE MODE	AVAILABLE CHANNEL	TESTED CHANNEL	MODULATION TECHNOLOGY	MODULATION TYPE	PACKET TYPE
-	0 to 78	0, 39, 78	FHSS	GFSK	1DH5



BUREAU  
VERITAS

Test Report No.: W7L-231127W001RF01

**POWER LINE CONDUCTED EMISSION TEST:**

- Pre-Scan has been conducted to determine the worst-case mode from all possible combinations between available modulations, antenna ports (if EUT with antenna diversity architecture) and packet type.
- The following channel(s) was (were) selected for the final test as listed below.

EUT CONFIGURE MODE	AVAILABLE CHANNEL	TESTED CHANNEL	MODULATION TECHNOLOGY	MODULATION TYPE	PACKET TYPE
-	0 to 78	39	FHSS	GFSK	1DH5

**ANTENNA PORT CONDUCTED MEASUREMENT:**

- This item includes all test value of each mode, but only includes spectrum plot of worst value of each mode.
- Pre-Scan has been conducted to determine the worst-case mode from all possible combinations between available modulations, antenna ports (if EUT with antenna diversity architecture), and packet types.
- The following channel(s) was (were) selected for the final test as listed below.

AVAILABLE CHANNEL	TESTED CHANNEL	MODULATION TECHNOLOGY	MODULATION TYPE	PACKET TYPE
0 to 78	0, 39, 78	FHSS	GFSK	DH1/DH3/DH5
0 to 78	0, 39, 78	FHSS	$\pi/4$ DQPSK	2DH1/2DH3/2DH5
0 to 78	0, 39, 78	FHSS	8DPSK	3DH1/3DH3/3DH5

**TEST CONDITION:**

APPLICABLE TO	ENVIRONMENTAL CONDITIONS	TEST VOLTAGE (SYSTEM)	TESTED BY
RE<1G	23deg. C, 70%RH	DC 3.3V	Jace Hu
RE≥1G	23deg. C, 70%RH	DC 3.3V	Jace Hu
PLC	25deg. C, 52%RH	DC 3.3V	Carl Xie
APCM	25deg. C, 60%RH	DC 3.3V	James Fu



Test Report No.: W7L-231127W001RF01

### 2.3 GENERAL DESCRIPTION OF APPLIED STANDARDS

The EUT is a RF Product. According to the specifications of the manufacturer, it must comply with the requirements of the following standards:

**FCC Part 15, Subpart C. Section 15.247**  
**ANSI C63.10-2020**

- NOTE:**
1. All test items have been performed and recorded as per the above standards.
  2. The EUT is also considered as a kind of computer peripheral, because the connection to computer is necessary for typical use. It has been verified to comply with the requirements of FCC Part 15, Subpart B, Class B (Certification). The test report has been issued separately.

### 2.4 DESCRIPTION OF SUPPORT UNITS

The EUT has been tested as an independent unit together with other necessary accessories or support units. The following support units or accessories were used to form a representative test configuration during the tests.

NO.	PRODUCT	BRAND	MODEL NO.	SERIAL NO.	FCC ID
1	Desktop	Lenovo	M73 SFF	PC04GRQV	N/A
2	Desktop	Lenovo	M73 SFF	PC06CS27	N/A
3	Laptop	Lenovo	Thinkpad L440	R90FTFKN	N/A

NO.	SIGNAL CABLE DESCRIPTION OF THE ABOVE SUPPORT UNITS
1	AC Line: Unshielded, Detachable 1.5m
2	AC Line: Unshielded, Detachable 1.5m
3	AC Line: Unshielded, Detachable 1.5m



### 3 TEST TYPES AND RESULTS

#### 3.1 CONDUCTED EMISSION MEASUREMENT

##### 3.1.1 LIMITS OF CONDUCTED EMISSION MEASUREMENT

FREQUENCY OF EMISSION (MHz)	CONDUCTED LIMIT (dBµV)	
0.15 ~ 0.5 0.5 ~ 5 5 ~ 30	Quasi-peak	Average
	66 to 56	56 to 46
	56	46
	60	50

- NOTE:**
1. The lower limit shall apply at the transition frequencies.
  2. The limit decreases in line with the logarithm of the frequency in the range of 0.15 to 0.50MHz.
  3. All emanations from a class A/B digital device or system, including any network of conductors and apparatus connected thereto, shall not exceed the level of field strengths specified above.

##### 3.1.2 TEST INSTRUMENTS

Equipment	Manufacturer	Model No.	Serial No.	Last Cal.	Next Cal.
EMI Test Receiver	Rohde&Schwarz	ESR3	101900	Feb. 15,23	Feb. 14,24
EMI Test Receiver	Rohde&Schwarz	ESR3	101900	Feb. 14,24	Feb. 13,25
EMC32 test software	Rohde&Schwarz	EMC32	NA	NA	NA
LISN network	Rohde&Schwarz	ENV216	101922	Mar. 11,23	Mar. 10,24
LISN network	Rohde&Schwarz	ENV216	101922	Mar. 10,24	Mar. 09,25

- NOTE:**
1. The test was performed in CE shielded room.
  2. The calibration interval of the above test instruments is 12 months and the calibrations are traceable to CEPREI/CHINA, GRGT/CHINA and NIM/CHINA.

##### 3.1.3 TEST PROCEDURES

- a. The EUT was placed 0.4 meters from the conducting wall of the shielded room with EUT being connected to the power mains through a line impedance stabilization network (LISN). Other support units were connected to the power mains through another LISN. The two LISNs provide 50 ohm/ 50uH of coupling impedance for the measuring instrument.
- b. Both lines of the power mains connected to the EUT were checked for maximum conducted interference.

c. The frequency range from 150kHz to 30MHz was searched. Emission levels under (Limit - 20dB) was not recorded.

**NOTE:** All modes of operation were investigated and the worst-case emissions are reported.

### 3.1.4 DEVIATION FROM TEST STANDARD

No deviation.

### 3.1.5 TEST SETUP

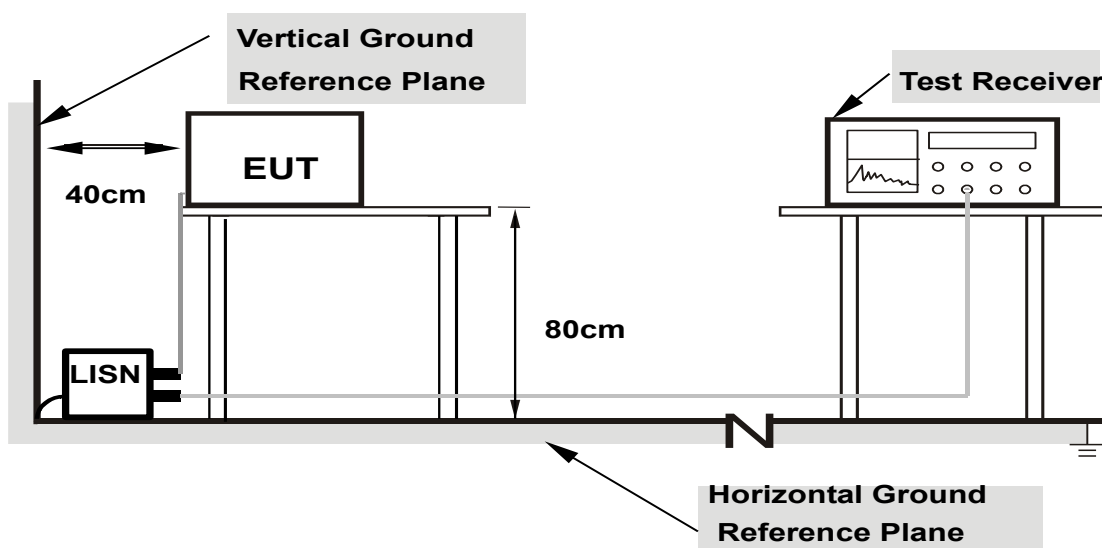

**Note: 1.Support units were connected to second LISN.**

**2.Both of LISNs (AMN) are 80 cm from EUT and at least 80 from other units and other metal planes**

For the actual test configuration, please refer to the attached file (Test Setup Photo).

### 3.1.6 EUT OPERATING CONDITIONS

- a. Turned on the power and connected of all equipment.
- b. EUT was operated according to the type used was description in manufacturer's specifications or the User's Manual.



Test Report No.: W7L-231127W001RF01

### 3.1.7 TEST RESULTS

#### CONDUCTED WORST-CASE DATA:

Frequency Range	150KHz ~ 30MHz	Detector Function & Resolution Bandwidth	Quasi-Peak (QP) / Average (AV), 9 kHz
Input Power	120Vac, 60Hz	Environmental Conditions	26deg. C, 51%RH
Tested By	Carl xie		

Frequency (MHz)	QuasiPeak (dBuV)	CAverage (dBuV)	Limit (dBuV)	Margin (dB)	Line	Filter	Corr. (dB)
0.166000	---	6.37	55.16	48.79	L1	ON	9.8
0.166000	23.94	---	65.16	41.22	L1	ON	9.8
1.500000	---	2.17	46.00	43.83	L1	ON	9.8
1.500000	3.60	---	56.00	52.40	L1	ON	9.8
2.712000	---	3.00	46.00	43.00	L1	ON	9.9
2.712000	4.51	---	56.00	51.49	L1	ON	9.9
4.328000	---	3.86	46.00	42.14	L1	ON	9.8
4.328000	5.44	---	56.00	50.56	L1	ON	9.8
15.876000	---	13.66	50.00	36.34	L1	ON	10.9
15.876000	16.53	---	60.00	43.47	L1	ON	10.9
19.408000	---	16.33	50.00	33.67	L1	ON	11.3
19.408000	17.34	---	60.00	42.66	L1	ON	11.3

- REMARKS:**
1. Q.P. and AV. are abbreviations of quasi-peak and average individually.
  2. "-": The Quasi-peak reading value also meets average limit and measurement with the average detector is unnecessary.
  3. The emission levels of other frequencies were very low against the limit.
  4. Margin value = Limit value - Emission level
  5. Correction factor = Insertion loss + Cable loss
  6. Emission Level = Correction Factor + Reading Value.

Full Spectrum

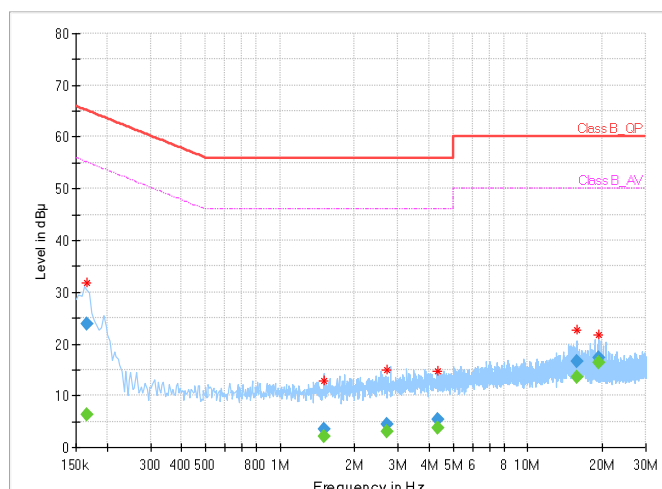





BUREAU  
VERITAS

Test Report No.: W7L-231127W001RF01

Frequency Range	150KHz ~ 30MHz	Detector Function & Resolution Bandwidth	Quasi-Peak (QP) / Average (AV), 9 kHz
Input Power	120Vac, 60Hz	Environmental Conditions	26deg. C, 51%RH
Tested By	Carl xie		

Frequency (MHz)	QuasiPeak (dBuV)	CAverage (dBuV)	Limit (dBuV)	Margin (dB)	Line	Filter	Corr. (dB)
0.162000	---	6.59	55.36	48.77	N	ON	9.7
0.162000	24.37	---	65.36	40.99	N	ON	9.7
1.716000	---	2.23	46.00	43.77	N	ON	9.8
1.716000	3.64	---	56.00	52.36	N	ON	9.8
3.600000	---	3.45	46.00	42.55	N	ON	9.7
3.600000	5.07	---	56.00	50.93	N	ON	9.7
4.864000	---	3.98	46.00	42.02	N	ON	9.7
4.864000	5.55	---	56.00	50.45	N	ON	9.7
13.564000	---	7.04	50.00	42.96	N	ON	10.7
13.564000	12.00	---	60.00	48.00	N	ON	10.7
19.164000	---	11.64	50.00	38.36	N	ON	11.3
19.164000	14.51	---	60.00	45.49	N	ON	11.3

- REMARKS:**
1. Q.P. and AV. are abbreviations of quasi-peak and average individually.
  2. "-": The Quasi-peak reading value also meets average limit and measurement with the average detector is unnecessary.
  3. The emission levels of other frequencies were very low against the limit.
  4. Margin value = Limit value - Emission level
  5. Correction factor = Insertion loss + Cable loss
  6. Emission Level = Correction Factor + Reading Value.

Full Spectrum

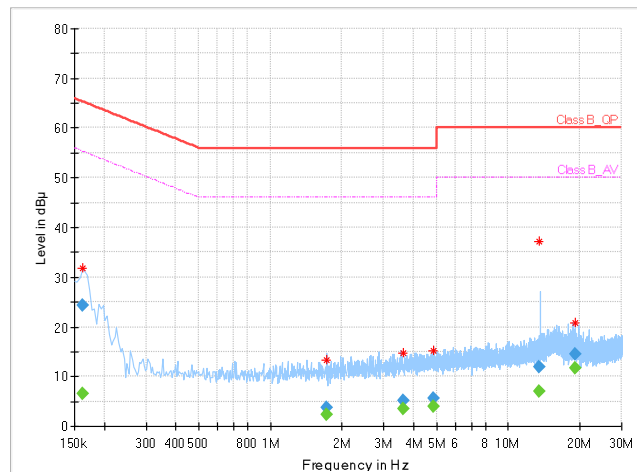



### 3.2 RADIATED EMISSION AND BANDEGE MEASUREMENT

#### 3.2.1 LIMITS OF RADIATED EMISSION AND BANDEGE MEASUREMENT

Radiated emissions which fall in the restricted bands, as defined in Section 15.205(a), must also comply with the radiated emission limits specified in Section 15.209(a). Other emissions shall be at least 20dB below the highest level of the desired power.

FREQUENCIES (MHz)	FIELD STRENGTH (microvolts/meter)	MEASUREMENT DISTANCE (meters)
0.009 ~ 0.490	2400/F(kHz)	300
0.490 ~ 1.705	24000/F(kHz)	30
1.705 ~ 30.0	30	30
30 ~ 88	100	3
88 ~ 216	150	3
216 ~ 960	200	3
Above 960	500	3

**NOTE:**

1. The lower limit shall apply at the transition frequencies.
2. Emission level (dBuV/m) = 20 log Emission level (uV/m).
3. As shown in 15.35(b), for frequencies above 1000MHz, the field strength limits are based on average detector, however, the peak field strength of any emission shall not exceed the maximum permitted average limits, specified above by more than 20dB under any condition of modulation.



Test Report No.: W7L-231127W001RF01

### 3.2.2 TEST INSTRUMENTS

Equipment	Manufacturer	Model No.	Serial No.	Last Cal.	Next Cal.
3m Semi-anechoic Chamber	ETS-LINDGREN	9m*6m*6m	Euroshieldpn-CT0001143-1216	Nov. 14,23	Nov. 13,26
Bilog Antenna	ETS-LINDGREN	3143B	00161965	Feb. 19,23	Feb. 18,24
Bilog Antenna	ETS-LINDGREN	3143B	00161965	Feb. 18,24	Feb. 17,25
Horn Antenna	ETS-LINDGREN	3117	00168692	Feb. 19,23	Feb. 18,24
Horn Antenna	ETS-LINDGREN	3117	00168692	Feb. 18,24	Feb. 17,25
Horn Antenna (18GHz-40GHz)	N/A	QWH-SL-18-40-K-SG/QMS-00361	15433	Sep.04, 23	Sep.03, 24
Test Software	E3	V 9.160323	N/A	N/A	N/A
Test Software	JS1120-3	3.2.06	N/A	N/A	N/A
10dB Attenuator	JFW/USA	50HF-010-SMA	N/A	May. 06,23	May. 05,24
MXE EMI Receiver	KEYSIGHT	N9038A-544	MY54450026	Mar. 28,23	Mar. 27,24
MXE EMI Receiver	KEYSIGHT	N9038A-544	MY54450026	Mar. 27,24	Mar. 26,25
Signal Pre-Amplifier	EMSI	EMC 9135	980249	May. 06,23	May. 05,24
Signal Pre-Amplifier	EMSI	EMC 012645B	980257	May.10,23	May.09,24
Signal Pre-Amplifier	EMSI	EMC 184045B	980259	Feb. 18,23	Feb. 17,24
Signal Pre-Amplifier	EMSI	EMC 184045B	980259	Feb. 17,24	Feb. 16,25
DC Source	Kikusui/JP	PMX18-5A	0000001	Aug. 12,23	Aug. 11,24
Power Meter	Anritsu	ML2495A	1506002	Feb. 15,23	Feb. 14,24
Power Meter	Anritsu	ML2495A	1506002	Feb. 14,24	Feb. 13,25
Power Sensor	Anritsu	MA2411B	1339352	Feb. 15,23	Feb. 14,24
Power Sensor	Anritsu	MA2411B	1339352	Feb. 14,24	Feb. 13,25
Loop Antenna	Schwarzbeck	FMZB 1519B	00173	Sep.03,23	Sep.02,24

- NOTE:**
1. The calibration interval of the above test instruments is 12 months or 36 months and the calibrations are traceable to CEPREI/CHINA, GRGT/CHINA and NIM/CHINA.
  2. The test was performed in 3m Chamber.
  3. The FCC Site Registration No. is 525120; The Designation No. is CN1171.



Test Report No.: W7L-231127W001RF01

### 3.2.3 TEST PROCEDURES

- a. The EUT was placed on the top of a rotating table 0.8 meters (for below 1GHz) / 1.5 meters (for above 1GHz) above the ground at 3 meter chamber room for test. The table was rotated 360 degrees to determine the position of the highest radiation.
- b. The EUT was set 3 meters away from the interference-receiving antenna, which was mounted on the top of a variable-height antenna tower.
- c. The antenna is a broadband antenna, and its height is varied from one meter to four meters above the ground to determine the maximum value of the field strength. Both horizontal and vertical polarizations of the antenna are set to make the measurement.
- d. For each suspected emission, the EUT was arranged to its worst case and then the antenna was tuned to heights from 1 meter to 4 meters and the rotatable table was turned from 0 degrees to 360 degrees to find the maximum reading.
- e. The test-receiver system was set to Peak Detect Function and Specified Bandwidth with Maximum Hold Mode.
- f. During the test, each emission was maximized by: having the EUT continuously working, investigated all operating modes, rotated about all 3 axis (X, Y & Z) and considered typical configuration to obtain worst position, manipulating interconnecting cables, For battery operated equipment, the equipment tests shall be perform using fresh batteries. The turntable was rotated to maximize the emission level.

#### NOTE:

1. The resolution bandwidth and video bandwidth of test receiver/spectrum analyzer is 120kHz for Quasi-peak detection at frequency below 1GHz.
2. The resolution bandwidth of test receiver/spectrum analyzer is 1 MHz and video bandwidth is 3MHz for Peak detection at frequency above 1GHz.
3. The resolution bandwidth of test receiver/spectrum analyzer is 1MHz and the video bandwidth is 10Hz for Average detection (AV) at frequency above 1GHz.
4. If the dwell time per channel of the hopping signal is less than 100 ms, then the reading obtained with the 10 Hz VBW may be further adjusted by a "duty cycle correction factor", derived from  $20\log(\text{dwell time}/100 \text{ ms})$ , in an effort to demonstrate compliance with the 15.209 limit.
5. All modes of operation were investigated and the worst-case emissions are reported.

### 3.2.4 DEVIATION FROM TEST STANDARD

No deviation.

### 3.2.5 TEST SETUP

#### <Frequency Range 9KHz~30MHz >

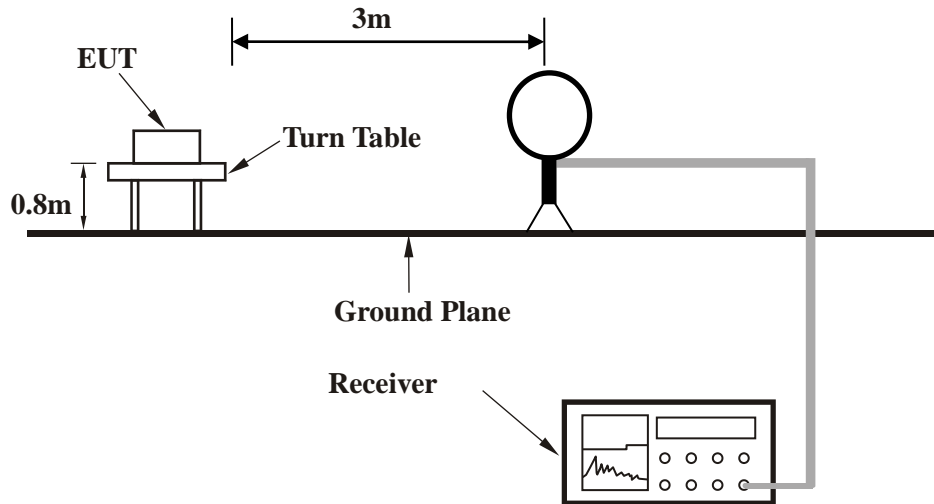

#### < Frequency Range 30MHz~1GHz >

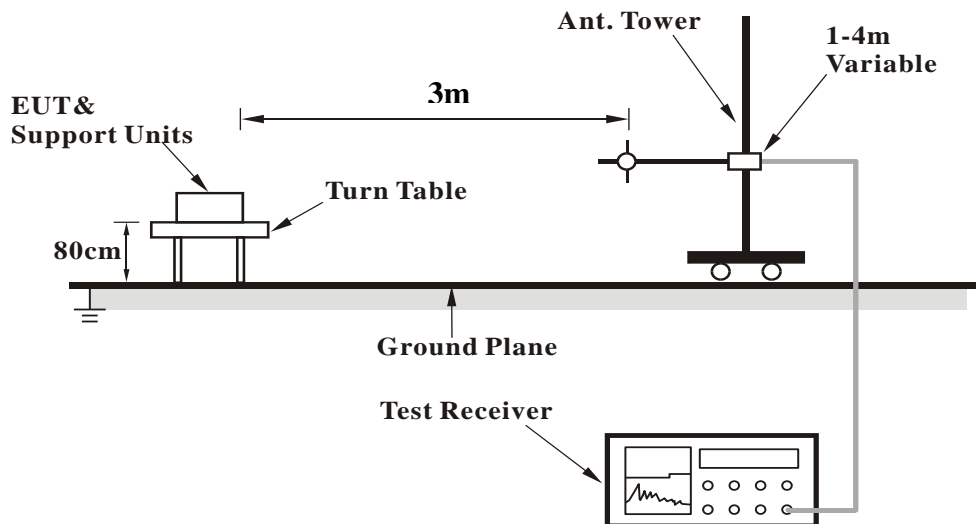

<Frequency Range above 1GHz>

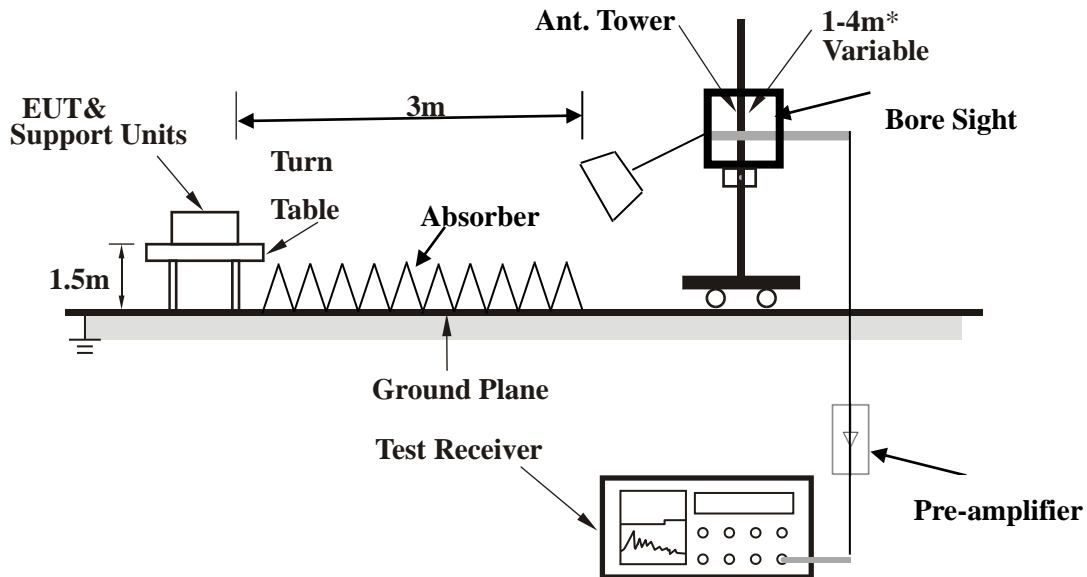

**Note:** Above 1G is a directional antenna

Depends on the EUT height and the antenna 3dB beamwidth both, refer to section 7.3 of CISPR 16-2-3.

For the actual test configuration, please refer to the attached file (Test Setup Photo).

### 3.2.6 EUT OPERATING CONDITIONS

- Set the EUT under full load condition and placed them on a testing table.
- Set the transmitter part of EUT under transmission condition continuously at specific channel frequency.
- The necessary accessories enable the EUT in full functions.



**BUREAU  
VERITAS**

Test Report No.: W7L-231127W001RF01

### 3.2.7 TEST RESULTS

**NOTE** : The 9K~30MHz amplitude of spurious emissions attenuated more than 20 dB below the permissible value is not required in the report.

#### BELOW 1GHz WORST-CASE DATA:

30 MHz – 1GHz data:

BT\_GFSK

<b>CHANNEL</b>	Channel 78	<b>DETECTOR FUNCTION</b>	Quasi-Peak (QP)
<b>FREQUENCY RANGE</b>	30MHz ~ 1GHz		

ANTENNA POLARITY & TEST DISTANCE: HORIZONTAL AT 3 M										
FREQ. (MHz)	EMISSION LEVEL (dBuV/m)	READ LEVEL (dBuV)	LIMIT (dBuV/m)	MARGIN (dB)	ANTENNA FACTOR (dB /m)	CABLE LOSS (dB)	PREAMP FACTOR (dB)	ANTENNA HEIGHT (cm)	TABLE ANGLE (Degree)	REMARK
71.710	27.27	50.93	40.00	-12.73	7.03	6.39	37.08	100	360	Peak
160.950	30.54	48.01	43.50	-12.96	12.53	6.78	36.78	100	360	Peak
299.660	34.64	49.63	46.00	-11.36	14.30	7.32	36.61	100	360	Peak
445.160	38.92	50.46	46.00	-7.08	17.66	7.74	36.94	100	360	Peak
562.530	37.26	46.57	46.00	-8.74	19.70	8.12	37.13	100	360	Peak
811.820	38.06	43.36	46.00	-7.94	23.74	8.62	37.66	100	360	Peak

#### REMARKS:

1. Emission Level(dBuV/m) = Read Level(dBuV) + Correction Factor(dB/m)
2. Correction Factor(dB/m) = Antenna Factor(dB/m) + Cable Factor(dB) – Pre-Amplifier Factor(dB)
3. The other emission levels were very low against the limit.
4. Margin value = Emission Level – Limit value

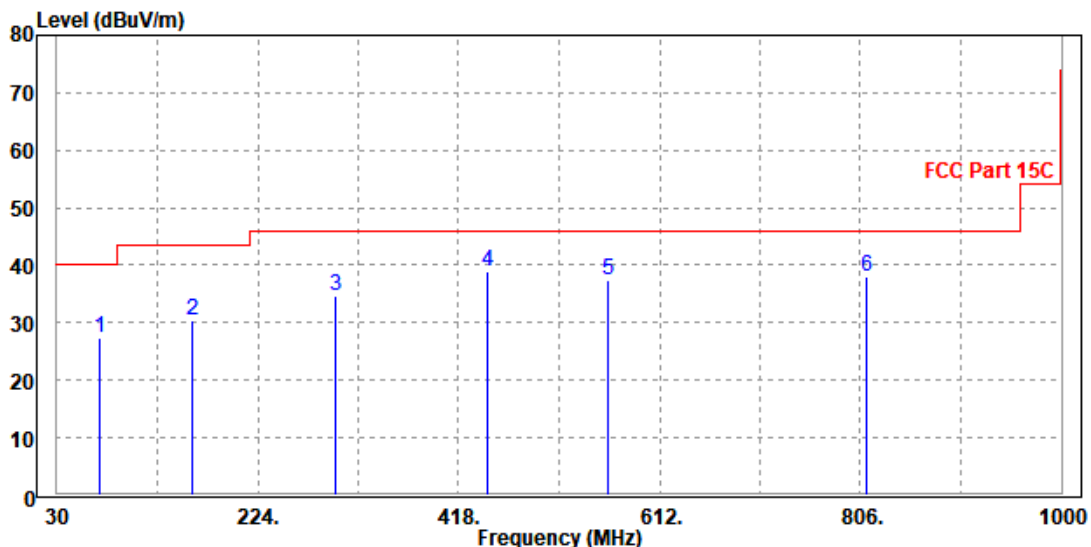



Test Report No.: W7L-231127W001RF01

<b>CHANNEL</b>	Channel 78	<b>DETECTOR FUNCTION</b>	Quasi-Peak (QP)
<b>FREQUENCY RANGE</b>	30MHz ~ 1GHz		

ANTENNA POLARITY & TEST DISTANCE: VERTICAL AT 3 M										
FREQ. (MHz)	EMISSION LEVEL (dBuV/m)	READ LEVEL (dBuV)	LIMIT (dBuV/m)	MARGIN (dB)	ANTENNA FACTOR (dB /m)	CABLE LOSS (dB)	PREAMP FACTOR (dB)	ANTENNA HEIGHT (cm)	TABLE ANGLE (Degree)	REMARK
71.710	26.90	50.19	40.00	-13.10	7.40	6.39	37.08	100	360	Peak
160.950	31.39	46.68	43.50	-12.11	14.71	6.78	36.78	100	360	Peak
298.690	37.09	51.80	46.00	-8.91	14.58	7.32	36.61	100	360	Peak
435.460	39.62	50.57	46.00	-6.38	18.27	7.70	36.92	100	360	Peak
562.530	37.15	46.03	46.00	-8.85	20.13	8.12	37.13	100	360	Peak
687.660	36.81	42.84	46.00	-9.19	22.87	8.36	37.26	100	360	Peak

**REMARKS:**

1. Emission Level(dBuV/m) = Read Level(dBuV) + Correction Factor(dB/m)
2. Correction Factor(dB/m) = Antenna Factor(dB/m) + Cable Factor(dB) – Pre-Amplifier Factor(dB)
3. The other emission levels were very low against the limit.
4. Margin value = Emission Level – Limit value

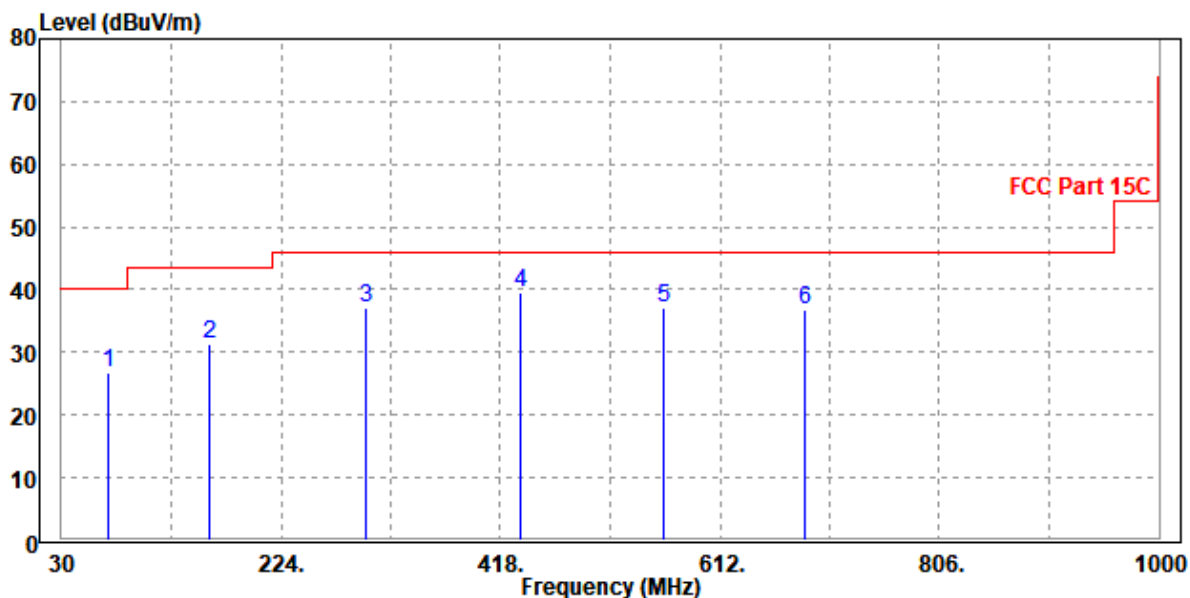





Test Report No.: W7L-231127W001RF01

**ABOVE 1GHz WORST-CASE DATA:**

**Note:** 1. For radiated emissions testing the full testing range of different modes have been scanned, only the worst case harmonic data is reported in the sheet.

2. All other emissions were greater than 20dB below the limit is not recorded

1GHz – 25GHz: (Scan with GFSK,  $\pi/4$ -DQPSK, 8DPSK mode, the worst case is  $\pi/4$ -DQPSK Mode)

**GFSK**

<b>CHANNEL</b>	TX Channel 0	<b>DETECTOR FUNCTION</b>	Peak (PK)
<b>FREQUENCY RANGE</b>	1GHz ~ 25GHz		Average (AV)

**ANTENNA POLARITY & TEST DISTANCE: HORIZONTAL AT 3 M**

FREQ. (MHz)	EMISSION LEVEL (dBuV/m)	READ LEVEL (dBuV)	LIMIT (dBuV/m)	MARGIN (dB)	ANTENNA FACTOR (dB /m)	CABLE LOSS (dB)	PREAMP FACTOR (dB)	ANTENNA HEIGHT (cm)	TABLE ANGLE (Degree)	REMARK
2390	52.28	58.97	74.00	-21.72	31.78	7.74	46.21	120	165	Peak
2390	44.49	51.18	54.00	-9.51	31.78	7.74	46.21	120	165	Average
2402	93.32	99.98	/	/	31.80	7.75	46.21	120	165	Peak
2402	93.23	99.89	/	/	31.80	7.75	46.21	120	165	Average
2483.5	52.13	58.47	74.00	-21.87	31.97	7.88	46.19	120	165	Peak
2483.5	44.74	51.08	54.00	-9.26	31.97	7.88	46.19	120	165	Average

**ANTENNA POLARITY & TEST DISTANCE: VERTICAL AT 3 M**

FREQ. (MHz)	EMISSION LEVEL (dBuV/m)	READ LEVEL (dBuV)	LIMIT (dBuV/m)	MARGIN (dB)	ANTENNA FACTOR (dB /m)	CABLE LOSS (dB)	PREAMP FACTOR (dB)	ANTENNA HEIGHT (cm)	TABLE ANGLE (Degree)	REMARK
2390	51.46	58.03	74.00	-22.54	31.90	7.74	46.21	119	305	Peak
2390	44.53	51.10	54.00	-9.47	31.90	7.74	46.21	119	305	Average
2402	101.33	107.87	/	/	31.92	7.75	46.21	119	305	Peak
2402	101.27	107.81	/	/	31.92	7.75	46.21	119	305	Average
2483.5	52.45	58.69	74.00	-21.55	32.07	7.88	46.19	119	305	Peak
2483.5	44.82	51.06	54.00	-9.18	32.07	7.88	46.19	119	305	Average

**REMARKS:**

- Emission Level = Read Level+ Antenna Factor + Cable Loss- Preamp Factor  
Margin value = Emission level – Limit value.
- 2402MHz: Fundamental frequency.



Test Report No.: W7L-231127W001RF01

<b>CHANNEL</b>	TX Channel 39	<b>DETECTOR FUNCTION</b>	Peak (PK)
<b>FREQUENCY RANGE</b>	1GHz ~ 25GHz		Average (AV)

**ANTENNA POLARITY & TEST DISTANCE: HORIZONTAL AT 3 M**

FREQ. (MHz)	EMISSION LEVEL (dBuV/m)	READ LEVEL (dBuV)	LIMIT (dBuV/m)	MARGIN (dB)	ANTENNA FACTOR (dB /m)	CABLE LOSS (dB)	PREAMP FACTOR (dB)	ANTENNA HEIGHT (cm)	TABLE ANGLE (Degree)	REMARK
2390	51.62	58.31	74.00	-22.38	31.78	7.74	46.21	101	170	Peak
2390	44.45	51.14	54.00	-9.55	31.78	7.74	46.21	101	170	Average
2441	92.19	98.70	/	/	31.88	7.81	46.20	101	170	Peak
2441	92.09	98.60	/	/	31.88	7.81	46.20	101	170	Average
2483.5	52.56	58.90	74.00	-21.44	31.97	7.88	46.19	101	170	Peak
2483.5	44.37	50.71	54.00	-9.63	31.97	7.88	46.19	101	170	Average

**ANTENNA POLARITY & TEST DISTANCE: VERTICAL AT 3 M**

FREQ. (MHz)	EMISSION LEVEL (dBuV/m)	READ LEVEL (dBuV)	LIMIT (dBuV/m)	MARGIN (dB)	ANTENNA FACTOR (dB /m)	CABLE LOSS (dB)	PREAMP FACTOR (dB)	ANTENNA HEIGHT (cm)	TABLE ANGLE (Degree)	REMARK
2390	51.60	58.17	74.00	-22.40	31.90	7.74	46.21	105	305	Peak
2390	44.30	50.87	54.00	-9.70	31.90	7.74	46.21	105	305	Average
2441	103.27	109.67	/	/	31.99	7.81	46.20	105	305	Peak
2441	103.25	109.65	/	/	31.99	7.81	46.20	105	305	Average
2483.5	52.04	58.28	74.00	-21.96	32.07	7.88	46.19	105	305	Peak
2483.5	44.79	51.03	54.00	-9.21	32.07	7.88	46.19	105	305	Average

**REMARKS:**

- Emission Level = Read Level+ Antenna Factor + Cable Loss- Preamp Factor  
Margin value = Emission level – Limit value.
- 2441MHz: Fundamental frequency.



Test Report No.: W7L-231127W001RF01

<b>CHANNEL</b>	TX Channel 78	<b>DETECTOR FUNCTION</b>	Peak (PK)
<b>FREQUENCY RANGE</b>	1GHz ~ 25GHz		Average (AV)

ANTENNA POLARITY & TEST DISTANCE: HORIZONTAL AT 3 M										
FREQ. (MHz)	EMISSION LEVEL (dBuV/m)	READ LEVEL (dBuV)	LIMIT (dBuV/m)	MARGIN (dB)	ANTENNA FACTOR (dB /m)	CABLE LOSS (dB)	PREAMP FACTOR (dB)	ANTENNA HEIGHT (cm)	TABLE ANGLE (Degree)	REMARK
2390	51.77	58.46	74.00	-22.23	31.78	7.74	46.21	147	170	Peak
2390	44.27	50.96	54.00	-9.73	31.78	7.74	46.21	147	170	Average
2480	92.67	99.03	/	/	31.96	7.87	46.19	147	170	Peak
2480	92.55	98.91	/	/	31.96	7.87	46.19	147	170	Average
2483.5	52.37	58.71	74.00	-21.63	31.97	7.88	46.19	147	170	Peak
2483.5	44.79	51.13	54.00	-9.21	31.97	7.88	46.19	147	170	Average
ANTENNA POLARITY & TEST DISTANCE: VERTICAL AT 3 M										
FREQ. (MHz)	EMISSION LEVEL (dBuV/m)	READ LEVEL (dBuV)	LIMIT (dBuV/m)	MARGIN (dB)	ANTENNA FACTOR (dB /m)	CABLE LOSS (dB)	PREAMP FACTOR (dB)	ANTENNA HEIGHT (cm)	TABLE ANGLE (Degree)	REMARK
2390	51.77	58.34	74.00	-22.23	31.90	7.74	46.21	100	310	Peak
2390	44.16	50.73	54.00	-9.84	31.90	7.74	46.21	100	310	Average
2480	103.07	109.33	/	/	32.06	7.87	46.19	100	310	Peak
2480	103.00	109.26	/	/	32.06	7.87	46.19	100	310	Average
2483.5	52.18	58.42	74.00	-21.82	32.07	7.88	46.19	100	310	Peak
2483.5	45.69	51.93	54.00	-8.31	32.07	7.88	46.19	100	310	Average

**REMARKS:**

- Emission Level = Read Level+ Antenna Factor + Cable Loss- Preamp Factor  
Margin value = Emission level – Limit value.
- 2480MHz: Fundamental frequency.



BUREAU  
VERITAS

Test Report No.: W7L-231127W001RF01

Worst case harmonic:

GFSK

CHANNEL	TX Channel 78	DETECTOR FUNCTION	Peak (PK)
FREQUENCY RANGE	1GHz ~ 25GHz		Average (AV)

ANTENNA POLARITY & TEST DISTANCE: HORIZONTAL AT 3 M

	Freq	Level	Read Level	Limit Line	Over Limit	Factor	Remark	Pol/Phase
	MHz	dBuV/m	dBuV	dBuV/m	dB	dB/m		
1	4961.000	45.90	47.29	74.00	-28.10	-1.39	Peak	Horizontal
2	PP 7440.000	47.53	44.68	74.00	-26.47	2.85	Peak	Horizontal

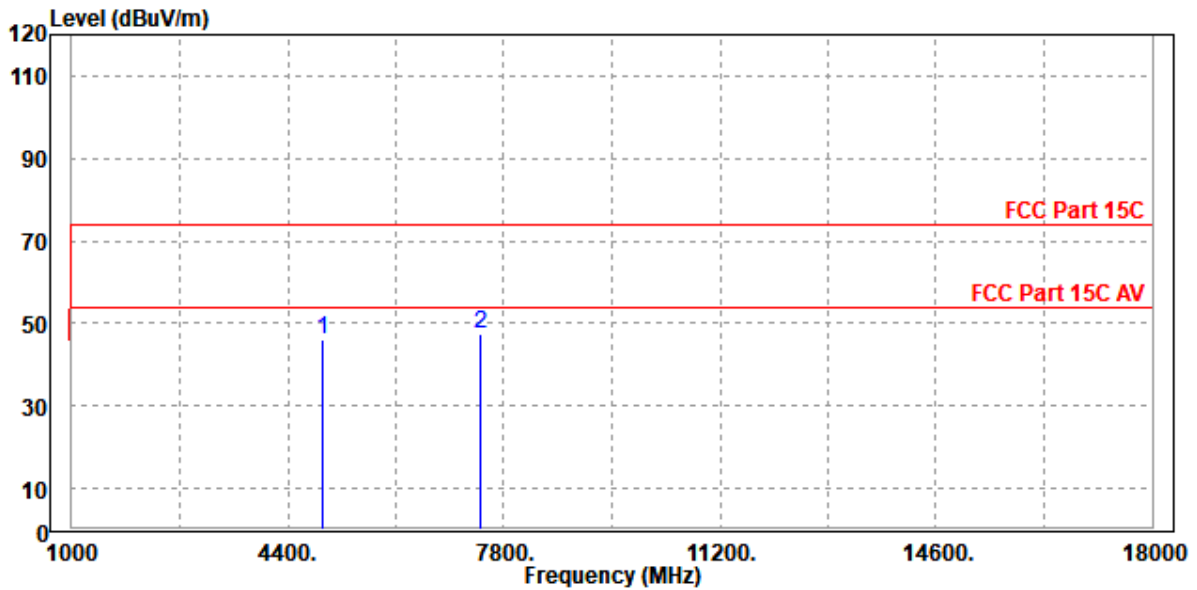



Test Report No.: W7L-231127W001RF01

**ANTENNA POLARITY & TEST DISTANCE: VERTICAL AT 3 M**

	Freq	Level	Read Level	Limit Line	Over Limit	Factor	Remark	Pol/Phase
	MHz	dBuV/m	dBuV	dBuV/m	dB	dB/m		
1	4960.000	46.20	47.52	74.00	-27.80	-1.32	Peak	Vertical
2	PP 7443.000	47.00	44.05	74.00	-27.00	2.95	Peak	Vertical

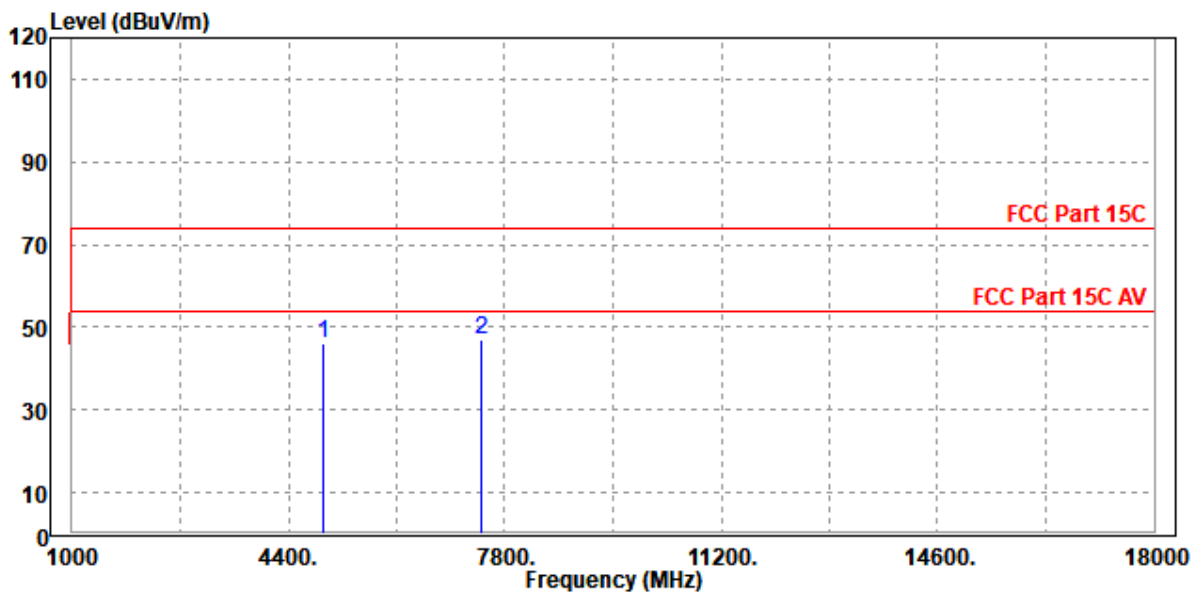

**REMARKS:**

1. Emission Level = Read Level+ Antenna Factor + Cable Loss- Preamp Factor  
Margin value = Emission level – Limit value.
2. 2480MHz: Fundamental frequency.
3. For frequency above 18GHz, the emission was tested 20db below the limit so the data not recorded in the sheet.



### 3.3 NUMBER OF HOPPING FREQUENCY USED

#### 3.3.1 LIMIT OF HOPPING FREQUENCY USED

At least 15 channels frequencies, and should be equally spaced.

#### 3.3.2 TEST SETUP

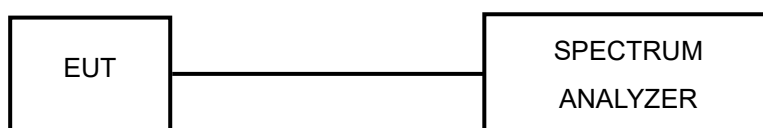

#### 3.3.3 TEST INSTRUMENTS

Equipment	Manufacturer	Model No.	Serial No.	Last Cal.	Next Cal.
Power Meter	ANRITSU	ML2495A	1506002	Feb. 15,23	Feb. 14,24
Power Meter	ANRITSU	ML2495A	1506002	Feb. 14,24	Feb. 13,25
EXA Signal Analyzer	KEYSIGHT	N9010A-526	MY54510523	Feb. 15,23	Feb. 14,24
EXA Signal Analyzer	KEYSIGHT	N9010A-526	MY54510523	Feb. 14,24	Feb. 13,25
EXA Signal Analyzer	KEYSIGHT	N9010A-544	MY54510355	May.10,23	May.09,24
Power Sensor	ANRITSU	MA2411B	1339352	Feb. 15,23	Feb. 14,24
Power Sensor	ANRITSU	MA2411B	1339352	Feb. 14,24	Feb. 13,25

**NOTE:**

1. The calibration interval of the above test instruments is 12 months and the calibrations are traceable to CEPREI/CHINA, GRGT/CHINA and NIM/CHINA.
2. The test was performed in RF Oven room.



Test Report No.: W7L-231127W001RF01

### 3.3.4 TEST PROCEDURES

- a. Check the calibration of the measuring instrument (SA) using either an internal calibrator or a known signal from an external generator.
- b. Turn on the EUT and connect its antenna terminal to measurement via a low loss cable. Then set it to any one measured frequency within its operating range and make sure the instrument is operated in its linear range.
- c. Set the SA on MaxHold Mode, and then keep the EUT in hopping mode. Record all the signals from each channel until each one has been recorded.
- d. Set the SA on View mode and then plot the result on SA screen.
- e. Repeat above procedures until all frequencies measured were completed.

### 3.3.5 DEVIATION FROM TEST STANDARD

No deviation.

### 3.3.6 TEST RESULTS

There are 79 hopping frequencies in the hopping mode. Please refer to next two pages for the test result. On the plots, it shows that the hopping frequencies are equally spaced.

Please Refer to Appendix Of this test report.



### 3.4 DWELL TIME ON EACH CHANNEL

#### 3.4.1 LIMIT OF DWELL TIME USED

The average time of occupancy on any channel shall not be greater than 0.4 seconds within a period of 0.4 seconds multiplied by the number of hopping channels employed.

#### 3.4.2 TEST SETUP

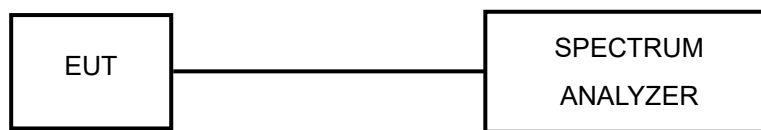

#### 3.4.3 TEST INSTRUMENTS

Refer to section 3.3.3 to get information of above instrument.

#### 3.4.4 TEST PROCEDURES

- a. Check the calibration of the measuring instrument (SA) using either an internal calibrator or a known signal from an external generator.
- b. Turn on the EUT and connect its antenna terminal to measurement via a low loss cable. Then set it to any one measured frequency within its operating range and make sure the instrument is operated in its linear range.
- c. Adjust the center frequency of SA on any frequency be measured and set SA to zero span mode. And then, set RBW and VBW of spectrum analyzer to proper value.
- d. Measure the time duration of one transmission on the measured frequency. And then plot the result with time difference of this time duration.
- e. Repeat above procedures until all different time-slot modes have been completed.





Test Report No.: W7L-231127W001RF01

### 3.4.5 DEVIATION FROM TEST STANDARD

No deviation.

### 3.4.6 TEST RESULTS

Please Refer to Appendix Of this test report

### 3.5 CHANNEL BANDWIDTH

#### 3.5.1 LIMITS OF CHANNEL BANDWIDTH

For frequency hopping system operating in the 2400-2483.5MHz, If the 20dB bandwidth of hopping channel is greater than 25kHz, two-thirds 20dB bandwidth of hopping channel shall be a minimum limit for the hopping channel separation.

#### 3.5.2 TEST SETUP

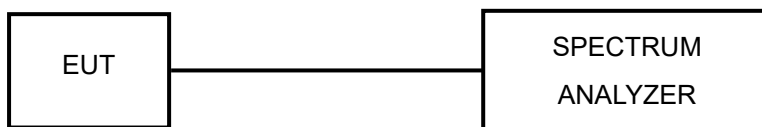

#### 3.5.3 TEST INSTRUMENTS

Refer to section 3.3.3 to get information of above instrument.

#### 3.5.4 TEST PROCEDURE

- a. Check the calibration of the measuring instrument using either an internal calibrator or a known signal from an external generator.
- b. Turn on the EUT and connect it to measurement instrument. Then set it to any one convenient frequency within its operating range. Set a reference level on the measuring instrument equal to the highest peak value.
- c. Measure the frequency difference of two frequencies that were attenuated 20dB from the reference level. Record the frequency difference as the emission bandwidth.
- d. Repeat above procedures until all frequencies measured were complete.

#### 3.5.5 DEVIATION FROM TEST STANDARD

No deviation.



Test Report No.: W7L-231127W001RF01

### 3.5.6 EUT OPERATING CONDITION

The software provided by client to enable the EUT under transmission condition continuously at lowest, middle and highest channel frequencies individually.

### 3.5.7 TEST RESULTS

Please Refer to Appendix Of this test report.

### 3.6 HOPPING CHANNEL SEPARATION

#### 3.6.1 LIMIT OF HOPPING CHANNEL SEPARATION

At least 25kHz or two-third of 20dB hopping channel bandwidth (whichever is greater).

#### 3.6.2 TEST SETUP

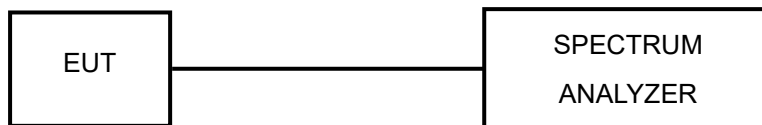

#### 3.6.3 TEST INSTRUMENTS

Refer to section 3.3.3 to get information of above instrument.

#### 3.6.4 TEST PROCEDURES

1. Check the calibration of the measuring instrument using either an internal calibrator or a known signal from an external generator.
2. Turn on the EUT and connect it to measurement instrument. Then set it to any one convenient frequency within its operating range.
3. By using the MaxHold function record the separation of two adjacent channels.
4. Measure the frequency difference of these two adjacent channels by SA MARK function. And then plot the result on SA screen.
5. Repeat above procedures until all frequencies measured were complete.

#### 3.6.5 DEVIATION FROM TEST STANDARD

No deviation.

### 3.6.6 TEST RESULTS

Please Refer to Appendix Of this test report.

## 3.7 MAXIMUM OUTPUT POWER

### 3.7.1 LIMITS OF MAXIMUM OUTPUT POWER MEASUREMENT

The Maximum Output Power Measurement is 125mW.

### 3.7.2 TEST SETUP

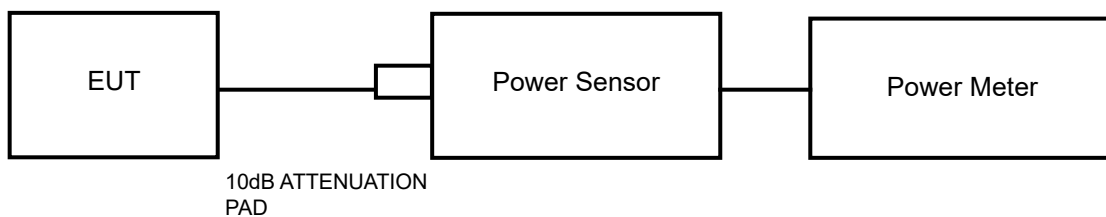

### 3.7.3 TEST INSTRUMENTS

Refer to section 3.3.3 to get information of above instrument.

### 3.7.4 TEST PROCEDURES

A peak power sensor was used on the output port of the EUT. A power meter was used to read the response of the peak power sensor. Record the power level.



Test Report No.: W7L-231127W001RF01

### 3.7.5 DEVIATION FROM TEST STANDARD

No deviation.

### 3.7.6 EUT OPERATING CONDITION

The software provided by client to enable the EUT under transmission condition continuously at lowest, middle and highest channel frequencies individually.



Test Report No.: W7L-231127W001RF01

### 3.7.7 TEST RESULTS

#### 3.7.7.1 MAXIMUM PEAK OUTPUT POWER

Please Refer to Appendix Of this test report.



Test Report No.: W7L-231127W001RF01

### 3.7.7.2 AVERAGE OUTPUT POWER (FOR REFERENCE)

The average power sensor was used on the output port of the EUT. A power meter was used to read the response of the power sensor. Record the power level.

Please Refer to Appendix Of this test report.





### 3.8 OUT OF BAND MEASUREMENT

#### 3.8.1 LIMITS OF OUT OF BAND MEASUREMENT

Below -20dB of the highest emission level of operating band (in 100KHz RBW).

#### 3.8.2 TEST INSTRUMENTS

Refer to section 3.3.3 to get information of above instrument.

#### 3.8.3 TEST PROCEDURE

The transmitter output was connected to the spectrum analyzer via a low loss cable. Spectrum Analyzer was set RBW to 100 kHz and VBW to 300 kHz with suitable frequency span including 100 MHz bandwidth from band edge. Detector = PEAK and Trace mode = Max Hold. The band edges was measured and recorded.

#### 3.8.4 DEVIATION FROM TEST STANDARD

No deviation.

#### 3.8.5 EUT OPERATING CONDITION

The software provided by client to enable the EUT under transmission condition continuously at lowest, middle and highest channel frequencies individually.

#### 3.8.6 TEST RESULTS

The spectrum plots are attached on the following images. D1 line indicates the highest level. D2 line indicates the 20dB offset below D1. It shows compliance to the requirement.

Please Refer to Appendix Of this test report.



**BUREAU  
VERITAS**

**Test Report No.: W7L-231127W001RF01**

## **4 PHOTOGRAPHS OF THE TEST CONFIGURATION**

Please refer to the attached file (Test Setup Photo).



**BUREAU  
VERITAS**

Test Report No.: W7L-231127W001RF01

## **5 MODIFICATIONS RECORDERS FOR ENGINEERING CHANGES TO THE EUT BY THE LAB**

No any modifications are made to the EUT by the lab during the test.



BUREAU  
VERITAS

Test Report No.: W7L-231127W001RF01

## 6 APPENDIX

### 20DB EMISSION BANDWIDTH

#### TEST RESULT

TestMode	Antenna	Frequency[MHz]	20db EBW[MHz]	FL[MHz]	FH[MHz]	Limit[MHz]	Verdict
DH5	Ant1	2402	0.963	2401.562	2402.525	---	---
		2441	0.963	2440.562	2441.525	---	---
		2480	0.966	2479.559	2480.525	---	---
2DH5	Ant1	2402	1.371	2401.346	2402.717	---	---
		2441	1.374	2440.346	2441.720	---	---
		2480	1.368	2479.352	2480.720	---	---
3DH5	Ant1	2402	1.353	2401.352	2402.705	---	---
		2441	1.356	2440.352	2441.708	---	---
		2480	1.356	2479.352	2480.708	---	---

## TEST GRAPHS

DH5\_Ant1\_2402



DH5\_Ant1\_2441



DH5\_Ant1\_2480



BUREAU VERITAS

# Test Report No.: W7L-231127W001RF01



2DH5\_Ant1\_2402



2DH5\_Ant1\_2441



BUREAU VERITAS

# Test Report No.: W7L-231127W001RF01



2DH5\_Ant1\_2480



3DH5\_Ant1\_2402



BUREAU VERITAS

# Test Report No.: W7L-231127W001RF01



3DH5\_Ant1\_2441



3DH5\_Ant1\_2480

BV 7Layers Communications Technology (Shenzhen) Co., Ltd

Room B37, Warehouse A5, No.3 Chiwan 4th Road, Zhaoshang Street, Nanshan District Shenzhen, Guangdong, People's Republic of China

Tel: +86 755 8869 6566  
Fax: +86 755 8869 6577  
Email: [customerservice.sw@bureauveritas.com](mailto:customerservice.sw@bureauveritas.com)





BUREAU VERITAS

# Test Report No.: W7L-231127W001RF01



BV 7Layers Communications Technology (Shenzhen) Co., Ltd

Room B37, Warehouse A5, No.3 Chiwan 4th Road, Zhaoshang Street, Nanshan District Shenzhen, Guangdong, People's Republic of China

Tel: +86 755 8869 6566  
Fax: +86 755 8869 6577  
Email: [customerservice.sw@bureauveritas.com](mailto:customerservice.sw@bureauveritas.com)



Test Report No.: W7L-231127W001RF01

## OCCUPIED CHANNEL BANDWIDTH TEST RESULT

TestMode	Antenna	Frequency[MHz]	OCB [MHz]	FL[MHz]	FH[MHz]	Limit[MHz]	Verdict
DH5	Ant1	2402	0.89377	2401.5864	2402.4802	---	---
		2441	0.89177	2440.5881	2441.4798	---	---
		2480	0.89049	2479.5878	2480.4783	---	---
2DH5	Ant1	2402	1.1981	2401.4307	2402.6288	---	---
		2441	1.1950	2440.4329	2441.6279	---	---
		2480	1.2018	2479.4287	2480.6305	---	---
3DH5	Ant1	2402	1.2066	2401.4243	2402.6309	---	---
		2441	1.2011	2440.4284	2441.6295	---	---
		2480	1.2074	2479.4243	2480.6317	---	---

### TEST GRAPHS

DH5\_Ant1\_2402



DH5\_Ant1\_2441



DH5\_Ant1\_2480



BUREAU VERITAS

### Test Report No.: W7L-231127W001RF01

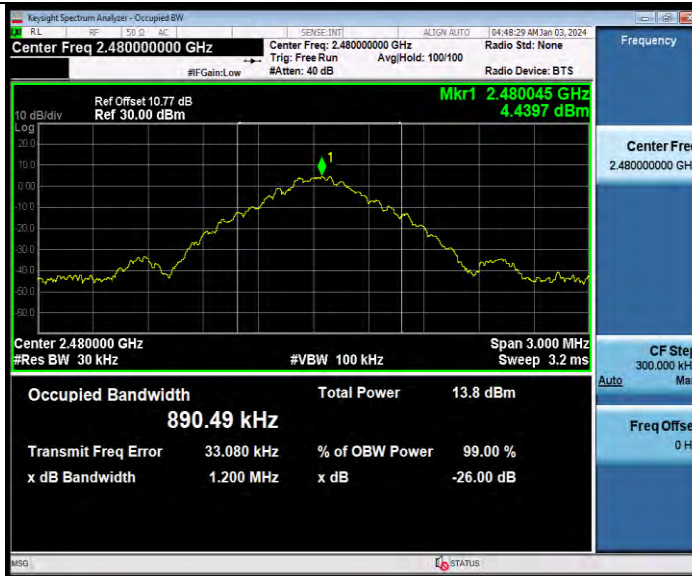

2DH5\_Ant1\_2402

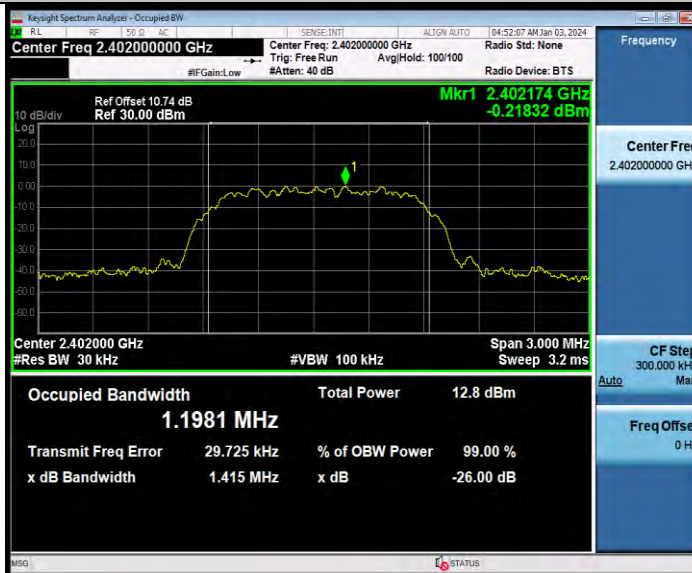

2DH5\_Ant1\_2441



BUREAU VERITAS

### Test Report No.: W7L-231127W001RF01



2DH5\_Ant1\_2480



3DH5\_Ant1\_2402



BUREAU VERITAS

Test Report No.: W7L-231127W001RF01

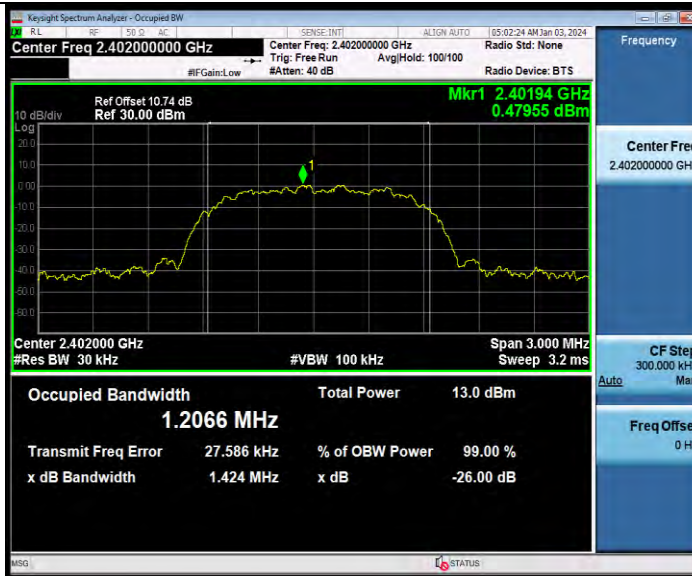

3DH5\_Ant1\_2441



3DH5\_Ant1\_2480



BUREAU  
VERITAS

Test Report No.: W7L-231127W001RF01



## MAXIMUM CONDUCTED OUTPUT POWER TEST RESULT

TestMode	Antenna	Frequency [MHz]	Average power [dBm]	Peak Power [dBm]	Peak power [mw]	Conducted Limit [dBm]	EIRP [dBm]	EIRP [mw]	EIRP Limit [dBm]	Verdict	Power Setting
DH5	Ant1	2402	4.88	5.11	3.24	≤20.97	7.61	5.77	≤36.00	PASS	Default
		2441	4.68	4.82	3.03	≤20.97	7.32	5.40	≤36.00	PASS	Default
		2480	4.69	4.91	3.10	≤20.97	7.41	5.51	≤36.00	PASS	Default
2DH5	Ant1	2402	4.82	7.38	5.47	≤20.97	9.88	9.73	≤36.00	PASS	Default
		2441	4.64	7.28	5.35	≤20.97	9.78	9.51	≤36.00	PASS	Default
		2480	4.62	7.19	5.24	≤20.97	9.69	9.31	≤36.00	PASS	Default
3DH5	Ant1	2402	4.8	7.94	6.22	≤20.97	10.44	11.07	≤36.00	PASS	Default
		2441	4.61	7.87	6.12	≤20.97	10.37	10.89	≤36.00	PASS	Default
		2480	4.61	7.78	6.00	≤20.97	10.28	10.67	≤36.00	PASS	Default

Note: EIRP=Peak Power+Gain

## CARRIER FREQUENCY SEPARATION TEST RESULT

TestMode	Antenna	Frequency[MHz]	Result[MHz]	Limit[MHz]	Verdict
DH5	Ant1	Hop	0.986	≥0.966	PASS
2DH5	Ant1	Hop	1.01	≥0.916	PASS
3DH5	Ant1	Hop	0.97	≥0.904	PASS



## TEST GRAPHS

DH5\_Ant1\_Hop



2DH5\_Ant1\_Hop



3DH5\_Ant1\_Hop



BUREAU  
VERITAS

# Test Report No.: W7L-231127W001RF01

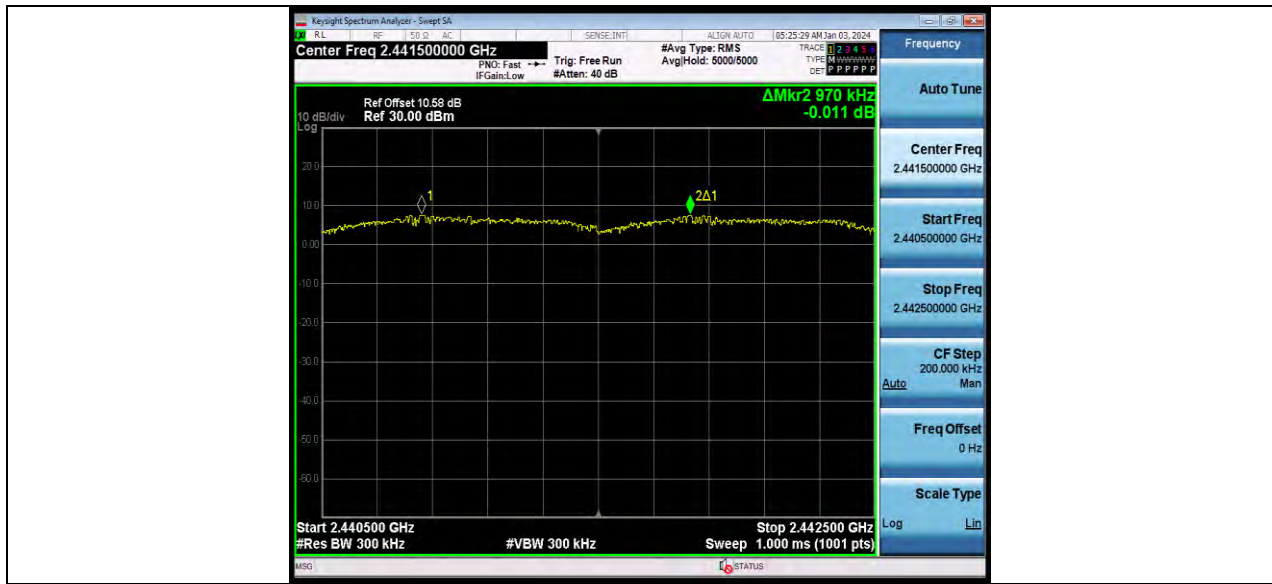

BV 7Layers Communications Technology  
(Shenzhen) Co., Ltd

Room B37, Warehouse A5, No.3 Chiwan 4th Road,  
Zhaoshang Street, Nanshan District Shenzhen,  
Guangdong, People's Republic of China

Tel: +86 755 8869 6566  
Fax: +86 755 8869 6577  
Email: [customerservice.sw@bureauveritas.com](mailto:customerservice.sw@bureauveritas.com)



Test Report No.: W7L-231127W001RF01

## TIME OF OCCUPANCY TEST RESULT

TestMode	Antenna	Frequency[MHz]	BurstWidth [ms]	TotalHops [Num]	Result[s]	Limit[s]	Verdict
DH5	Ant1	Hop	2.885	106.67	0.308	≤0.4	PASS
2DH1	Ant1	Hop	0.390	320	0.125	≤0.4	PASS
2DH3	Ant1	Hop	1.642	160	0.263	≤0.4	PASS
2DH5	Ant1	Hop	2.891	106.67	0.308	≤0.4	PASS
3DH1	Ant1	Hop	0.389	320	0.124	≤0.4	PASS
3DH3	Ant1	Hop	1.640	160	0.262	≤0.4	PASS
3DH5	Ant1	Hop	2.892	106.67	0.308	≤0.4	PASS

### TEST GRAPHS

DH5\_Ant1\_Hop

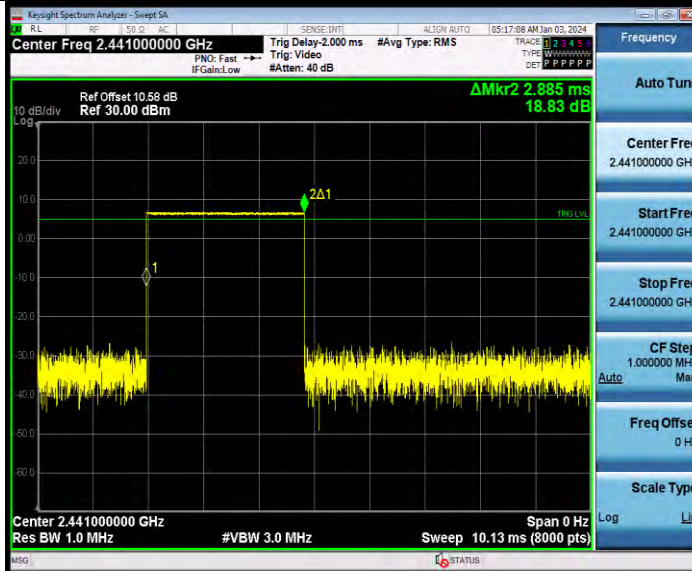

2DH1\_Ant1\_Hop

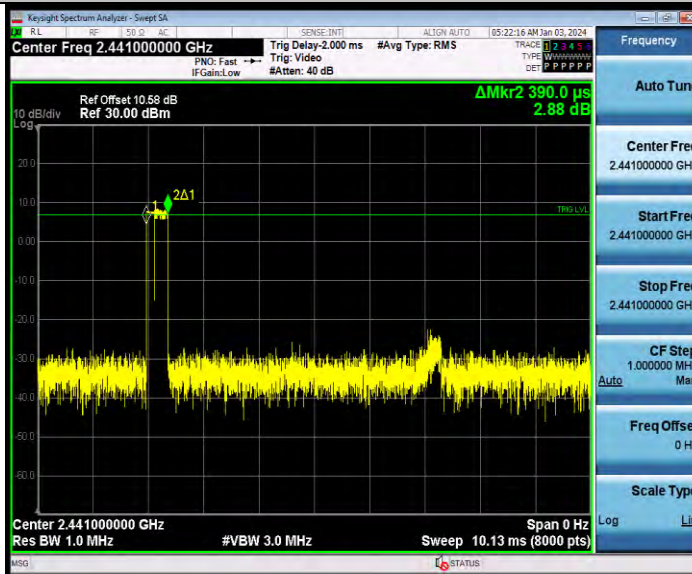

2DH3\_Ant1\_Hop



BUREAU  
VERITAS

# Test Report No.: W7L-231127W001RF01

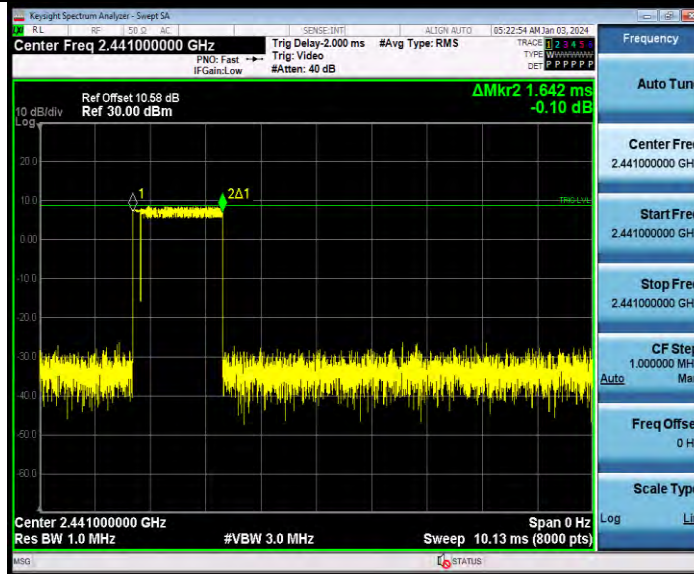

2DH5\_Ant1\_Hop

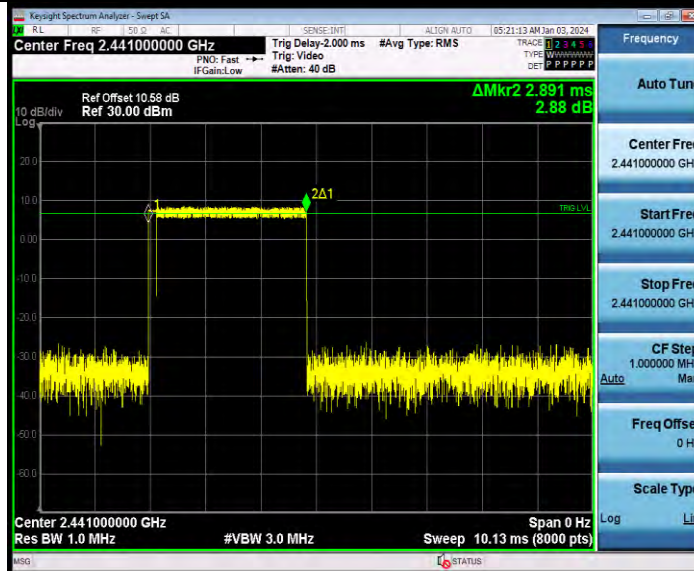

3DH1\_Ant1\_Hop

BV 7Layers Communications Technology  
(Shenzhen) Co., Ltd

Room B37, Warehouse A5, No.3 Chiwan 4th Road,  
Zhaoshang Street, Nanshan District Shenzhen,  
Guangdong, People's Republic of China

Tel: +86 755 8869 6566  
Fax: +86 755 8869 6577  
Email: [customerservice.sw@bureauveritas.com](mailto:customerservice.sw@bureauveritas.com)



BUREAU VERITAS

# Test Report No.: W7L-231127W001RF01

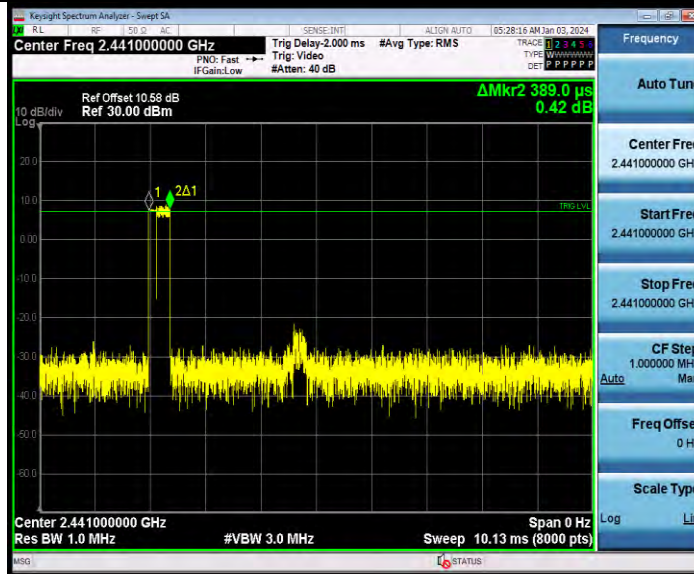

3DH3\_Ant1\_Hop

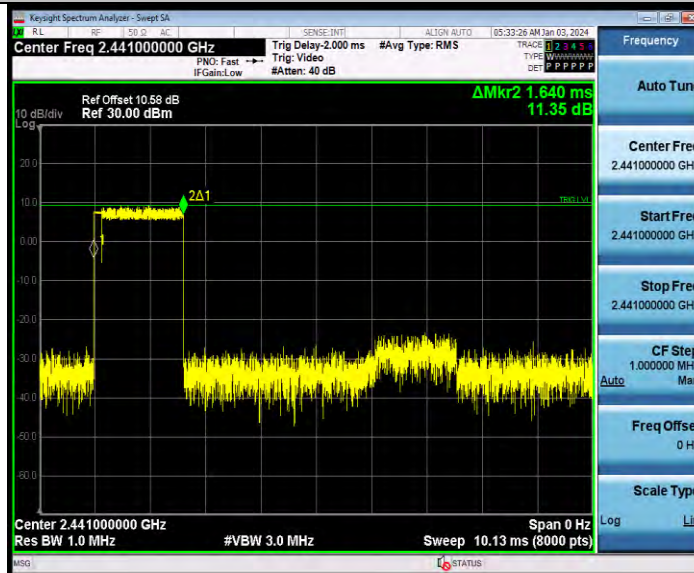

3DH5\_Ant1\_Hop

BV 7Layers Communications Technology (Shenzhen) Co., Ltd

Room B37, Warehouse A5, No.3 Chiwan 4th Road, Zhaoshang Street, Nanshan District Shenzhen, Guangdong, People's Republic of China

Tel: +86 755 8869 6566  
 Fax: +86 755 8869 6577  
 Email: [customerservice.sw@bureauveritas.com](mailto:customerservice.sw@bureauveritas.com)



BUREAU  
VERITAS

Test Report No.: W7L-231127W001RF01

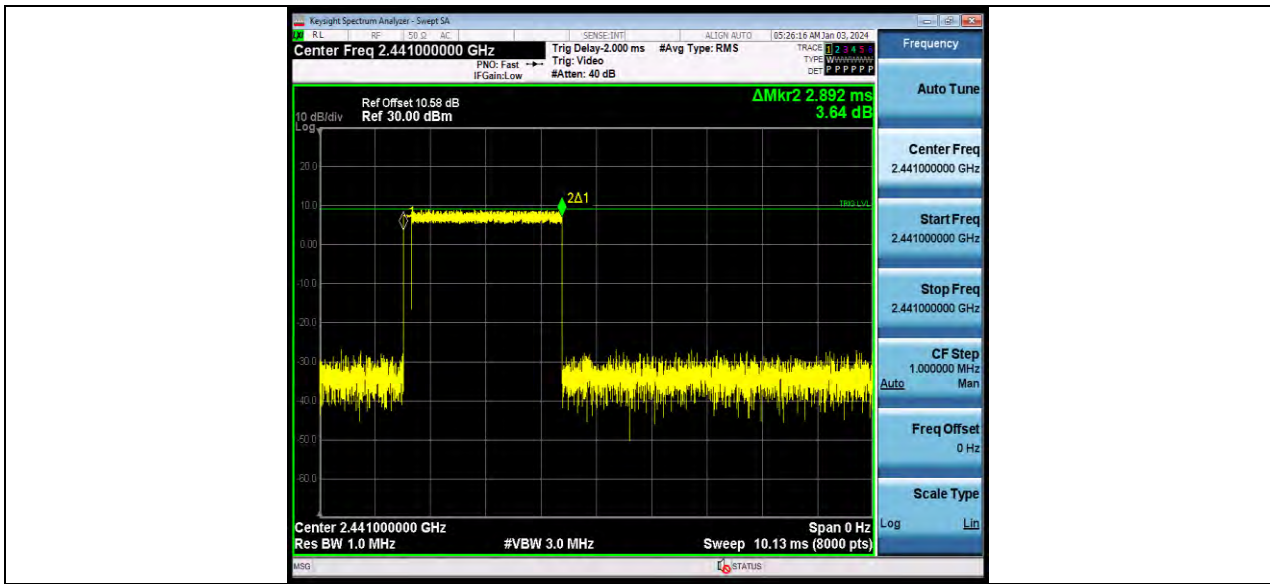

BV 7Layers Communications Technology  
(Shenzhen) Co., Ltd

Room B37, Warehouse A5, No.3 Chiwan 4th Road,  
Zhaoshang Street, Nanshan District Shenzhen,  
Guangdong, People's Republic of China

Tel: +86 755 8869 6566  
Fax: +86 755 8869 6577  
Email: [customerservice.sw@bureauveritas.com](mailto:customerservice.sw@bureauveritas.com)



BUREAU  
VERITAS

Test Report No.: W7L-231127W001RF01

## NUMBER OF HOPPING CHANNELS

### TEST RESULT

TestMode	Antenna	Frequency[MHz]	Result[Num]	Limit[Num]	Verdict
DH5	Ant1	Hop	79	$\geq 15$	PASS
2DH5	Ant1	Hop	79	$\geq 15$	PASS
3DH5	Ant1	Hop	79	$\geq 15$	PASS



## TEST GRAPHS

DH5\_Ant1\_Hop

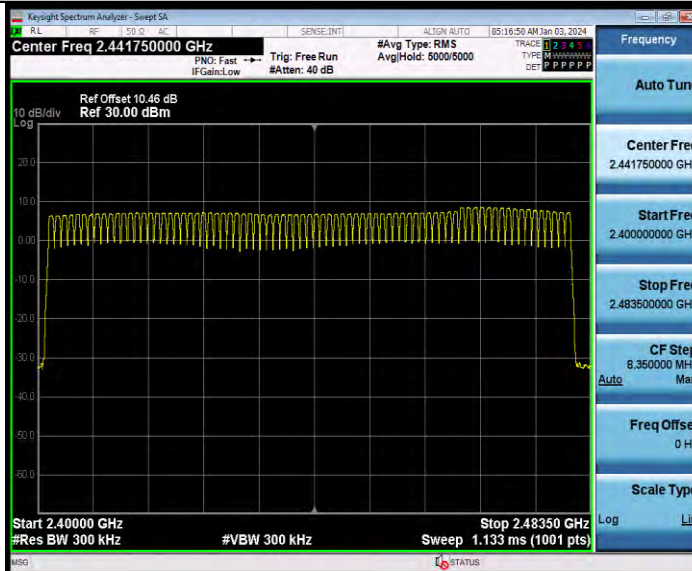

2DH5\_Ant1\_Hop

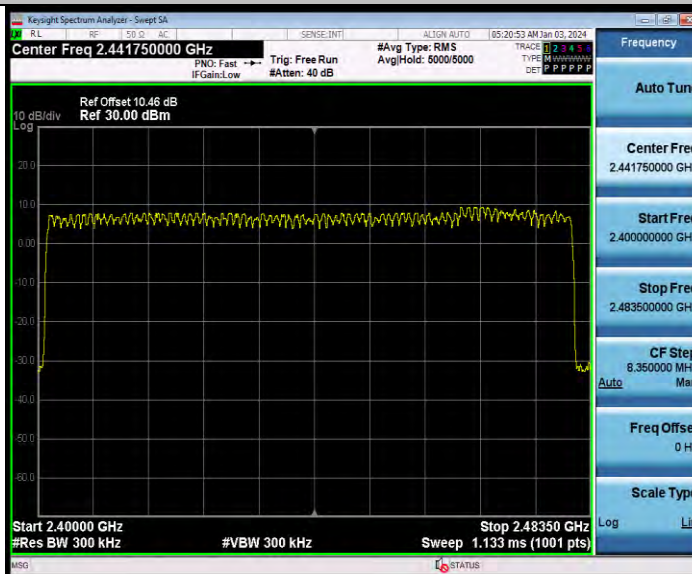

3DH5\_Ant1\_Hop



BUREAU  
VERITAS

# Test Report No.: W7L-231127W001RF01

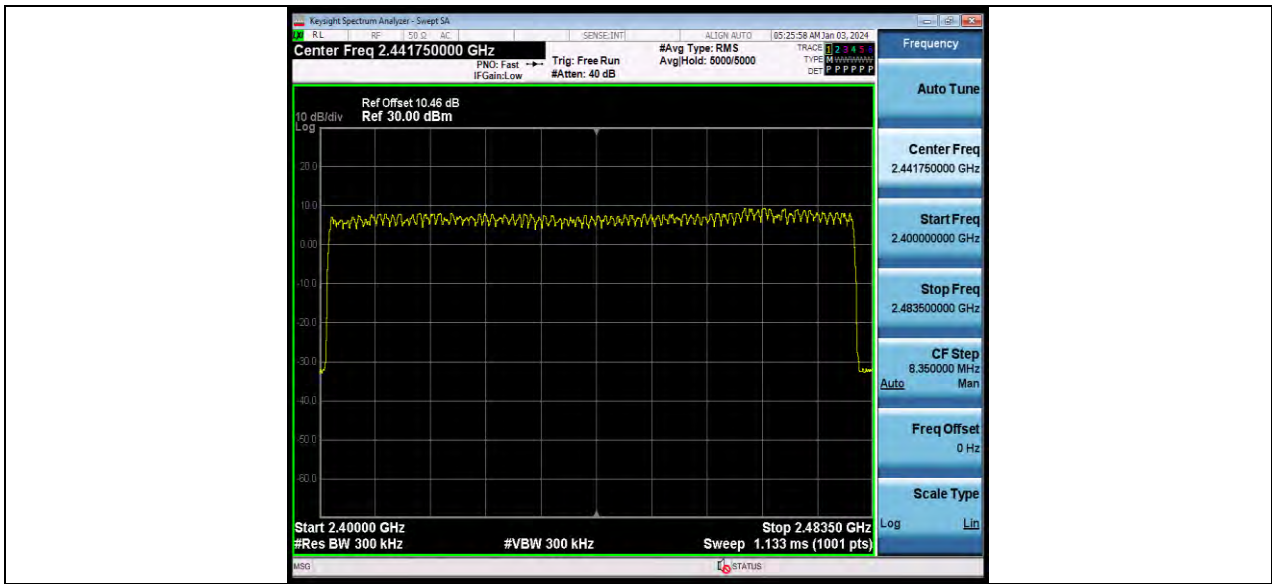

BV 7Layers Communications Technology  
(Shenzhen) Co., Ltd

Room B37, Warehouse A5, No.3 Chiwan 4th Road,  
Zhaoshang Street, Nanshan District Shenzhen,  
Guangdong, People's Republic of China

Tel: +86 755 8869 6566  
Fax: +86 755 8869 6577  
Email: [customerservice.sw@bureauveritas.com](mailto:customerservice.sw@bureauveritas.com)



BUREAU  
VERITAS

Test Report No.: W7L-231127W001RF01

## BAND EDGE MEASUREMENTS

### TEST RESULT

TestMode	Antenna	ChName	Frequency[MHz]	RefLevel [dBm]	Result [dBm]	Limit [dBm]	Verdict
DH5	Ant1	Low	2402	6.06	-44.69	≤-13.94	PASS
		High	2480	6.80	-44.23	≤-13.2	PASS
		Low	Hop_2402	5.11	-45.46	≤-14.89	PASS
		High	Hop_2480	7.39	-44.99	≤-12.61	PASS
2DH5	Ant1	Low	2402	4.61	-44.44	≤-15.39	PASS
		High	2480	5.62	-43.35	≤-14.38	PASS
		Low	Hop_2402	1.81	-45	≤-18.2	PASS
		High	Hop_2480	5.85	-44.76	≤-14.15	PASS
3DH5	Ant1	Low	2402	4.48	-45.23	≤-15.52	PASS
		High	2480	5.76	-44.76	≤-14.24	PASS
		Low	Hop_2402	1.58	-45.88	≤-18.42	PASS
		High	Hop_2480	4.53	-44.45	≤-15.47	PASS

TEST GRAPHS

DH5\_Ant1\_Low\_2402

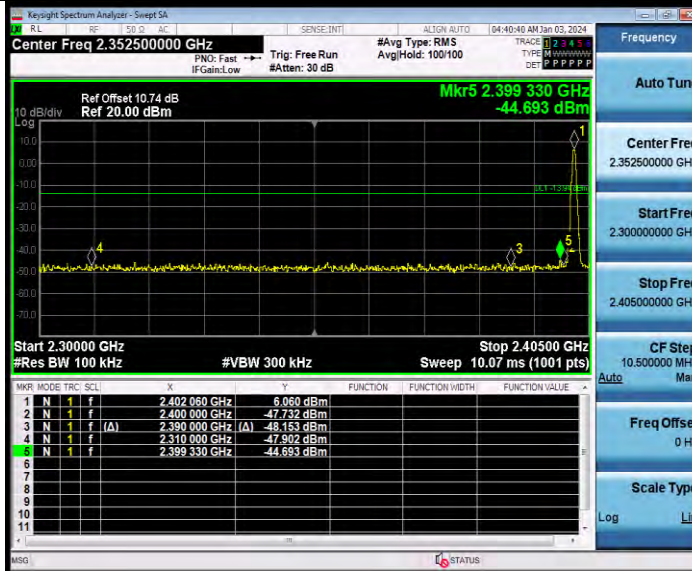

DH5\_Ant1\_High\_2480

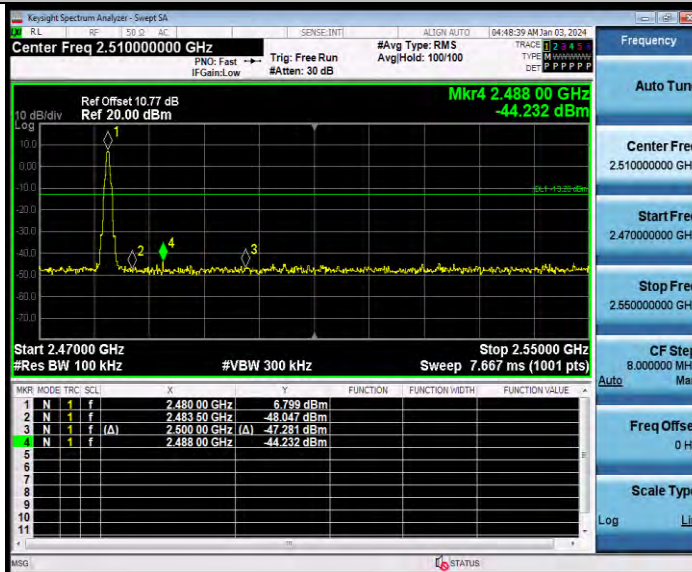

DH5\_Ant1\_Low\_Hop\_2402



BUREAU VERITAS

# Test Report No.: W7L-231127W001RF01

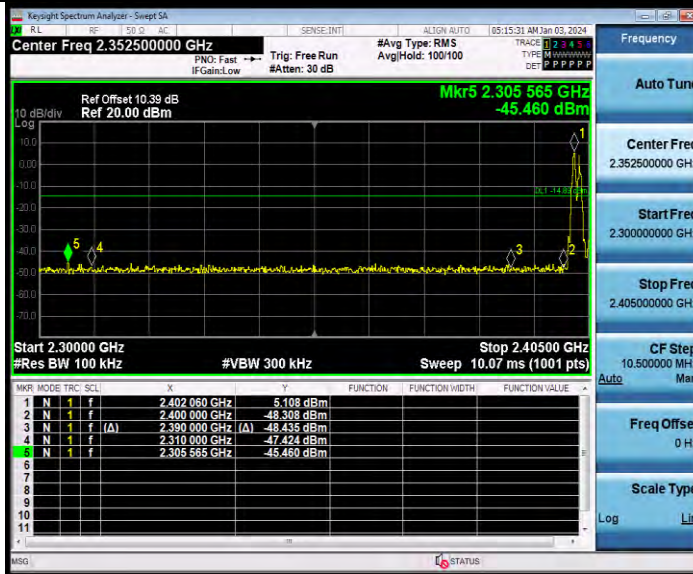

DH5\_Ant1\_High\_Hop\_2480

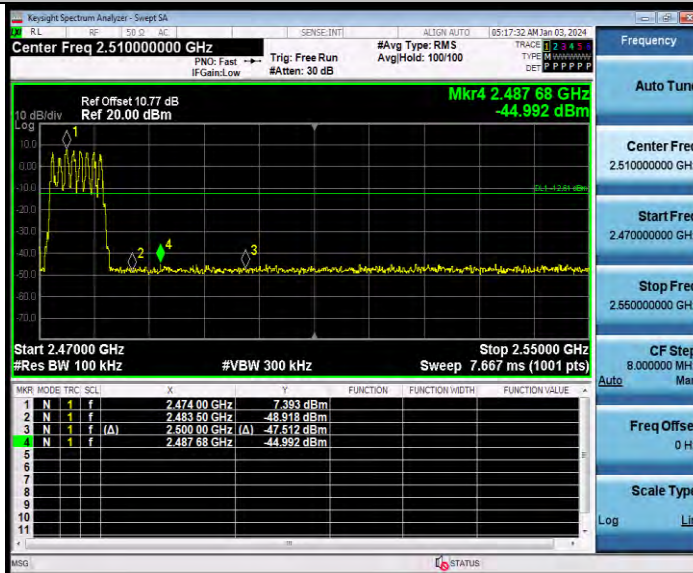

2DH5\_Ant1\_Low\_2402

BV 7Layers Communications Technology (Shenzhen) Co., Ltd

Room B37, Warehouse A5, No.3 Chiwan 4th Road, Zhaoshang Street, Nanshan District Shenzhen, Guangdong, People's Republic of China

Tel: +86 755 8869 6566  
Fax: +86 755 8869 6577  
Email: [customerservice.sw@bureauveritas.com](mailto:customerservice.sw@bureauveritas.com)



BUREAU VERITAS

# Test Report No.: W7L-231127W001RF01

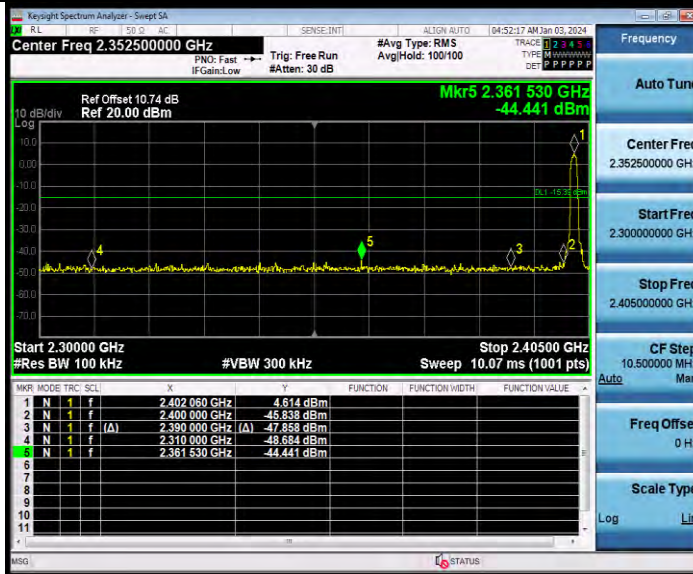

2DH5\_Ant1\_High\_2480

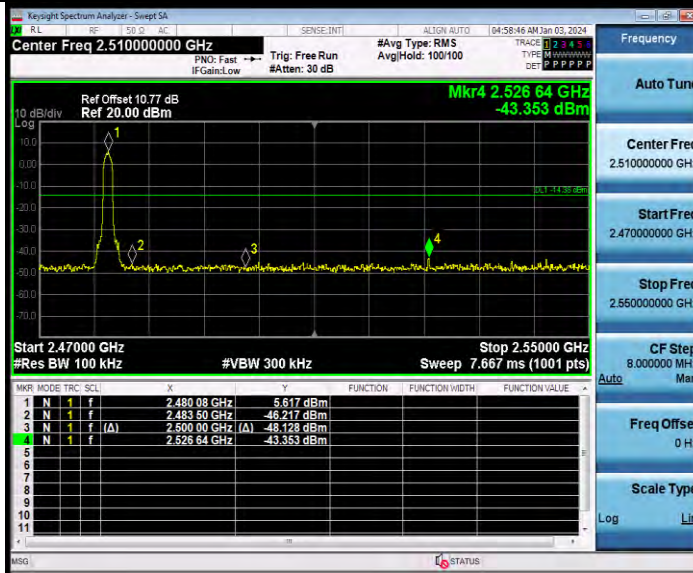

2DH5\_Ant1\_Low\_Hop\_2402

BV 7Layers Communications Technology (Shenzhen) Co., Ltd

Room B37, Warehouse A5, No.3 Chiwan 4th Road, Zhaoshang Street, Nanshan District Shenzhen, Guangdong, People's Republic of China

Tel: +86 755 8869 6566  
Fax: +86 755 8869 6577  
Email: [customerservice.sw@bureauveritas.com](mailto:customerservice.sw@bureauveritas.com)



BUREAU VERITAS

# Test Report No.: W7L-231127W001RF01

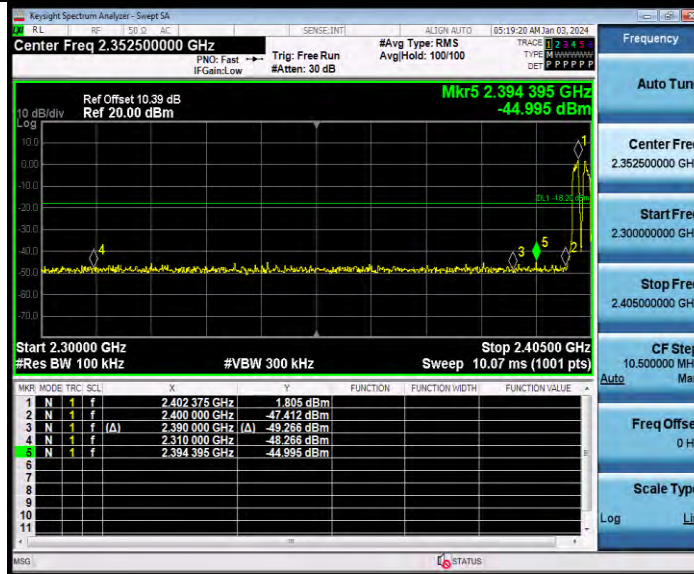

2DH5\_Ant1\_High\_Hop\_2480

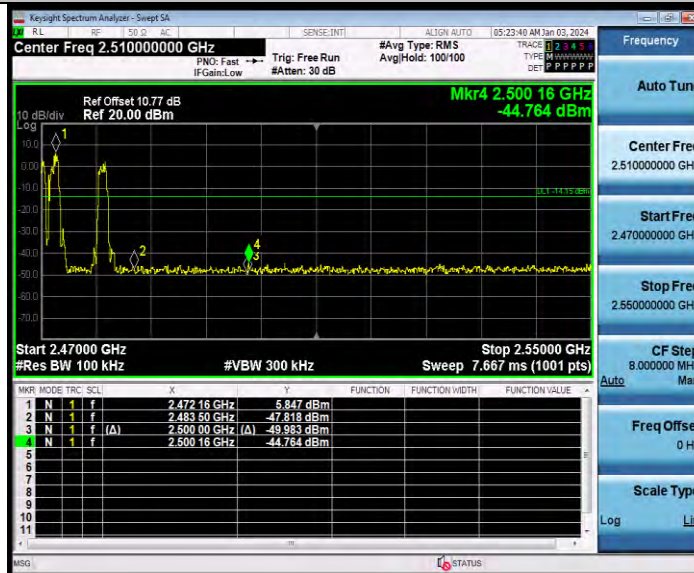

3DH5\_Ant1\_Low\_2402

BV 7Layers Communications Technology (Shenzhen) Co., Ltd

Room B37, Warehouse A5, No.3 Chiwan 4th Road, Zhaoshang Street, Nanshan District Shenzhen, Guangdong, People's Republic of China

Tel: +86 755 8869 6566  
Fax: +86 755 8869 6577  
Email: [customerservice.sw@bureauveritas.com](mailto:customerservice.sw@bureauveritas.com)



BUREAU VERITAS

# Test Report No.: W7L-231127W001RF01

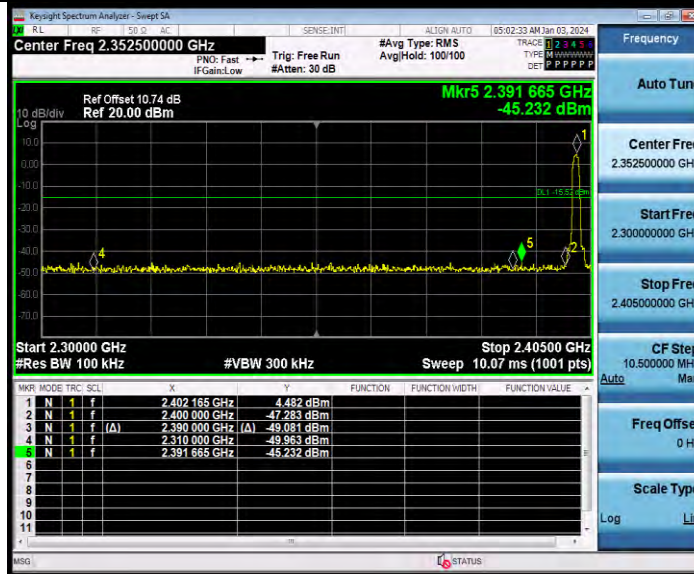

3DH5\_Ant1\_High\_2480

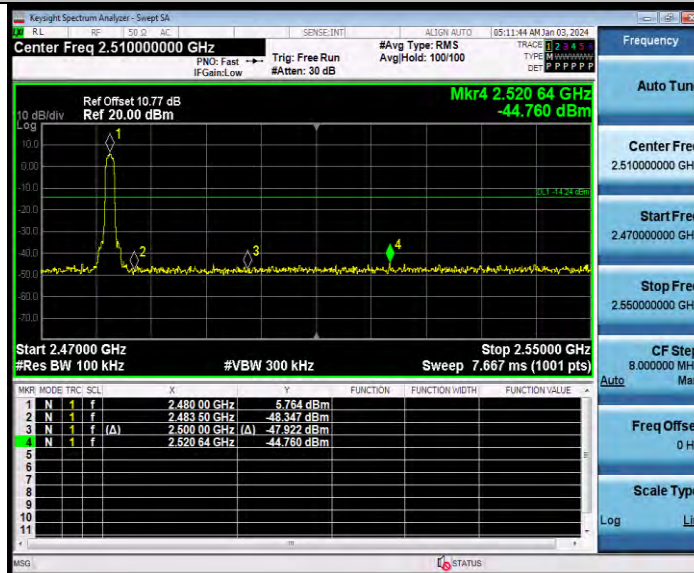

3DH5\_Ant1\_Low\_Hop\_2402

BV 7Layers Communications Technology (Shenzhen) Co., Ltd

Room B37, Warehouse A5, No.3 Chiwan 4th Road, Zhaoshang Street, Nanshan District Shenzhen, Guangdong, People's Republic of China

Tel: +86 755 8869 6566  
Fax: +86 755 8869 6577  
Email: [customerservice.sw@bureauveritas.com](mailto:customerservice.sw@bureauveritas.com)





BUREAU VERITAS

# Test Report No.: W7L-231127W001RF01

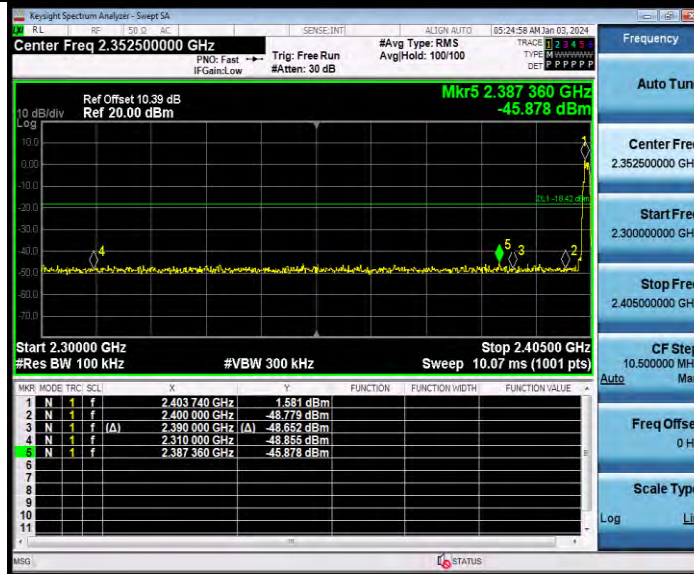

## 3DH5\_Ant1\_High\_Hop\_2480

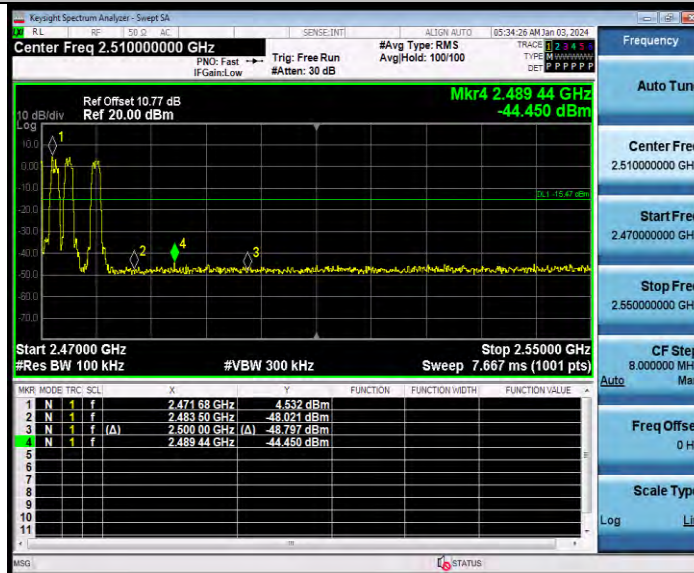

BV 7Layers Communications Technology (Shenzhen) Co., Ltd

Room B37, Warehouse A5, No.3 Chiwan 4th Road, Zhaoshang Street, Nanshan District Shenzhen, Guangdong, People's Republic of China

Tel: +86 755 8869 6566  
Fax: +86 755 8869 6577  
Email: [customerservice.sw@bureauveritas.com](mailto:customerservice.sw@bureauveritas.com)

## CONDUCTED SPURIOUS EMISSION

### TEST RESULT

TestMode	Antenna	Frequency[MHz]	FreqRange [MHz]	RefLevel [dBm]	Result [dBm]	Limit [dBm]	Verdict
DH5	Ant1	2402	Reference	5.61	5.61	---	PASS
			30~1000	5.61	-54.02	≤-14.39	PASS
			1000~26500	5.61	-30.12	≤-14.39	PASS
		2441	Reference	5.67	5.67	---	PASS
			30~1000	5.67	-53.37	≤-14.33	PASS
			1000~26500	5.67	-30.45	≤-14.33	PASS
		2480	Reference	6.47	6.47	---	PASS
			30~1000	6.47	-54.53	≤-13.53	PASS
			1000~26500	6.47	-26.91	≤-13.53	PASS
2DH5	Ant1	2402	Reference	3.68	3.68	---	PASS
			30~1000	3.68	-53.77	≤-16.32	PASS
			1000~26500	3.68	-29.18	≤-16.32	PASS
		2441	Reference	3.71	3.71	---	PASS
			30~1000	3.71	-53.66	≤-16.29	PASS
			1000~26500	3.71	-27.26	≤-16.29	PASS
		2480	Reference	4.44	4.44	---	PASS
			30~1000	4.44	-53.27	≤-15.56	PASS
			1000~26500	4.44	-35.52	≤-15.56	PASS
3DH5	Ant1	2402	Reference	3.76	3.76	---	PASS
			30~1000	3.76	-53.87	≤-16.24	PASS
			1000~26500	3.76	-34.28	≤-16.24	PASS
		2441	Reference	4.43	4.43	---	PASS
			30~1000	4.43	-54.05	≤-15.57	PASS
			1000~26500	4.43	-28.98	≤-15.57	PASS
		2480	Reference	4.98	4.98	---	PASS
			30~1000	4.98	-54.17	≤-15.02	PASS
			1000~26500	4.98	-35.13	≤-15.02	PASS

## TEST GRAPHS

DH5\_Ant1\_2402\_0~Reference



DH5\_Ant1\_2402\_30~1000



DH5\_Ant1\_2402\_1000~26500



BUREAU VERITAS

# Test Report No.: W7L-231127W001RF01

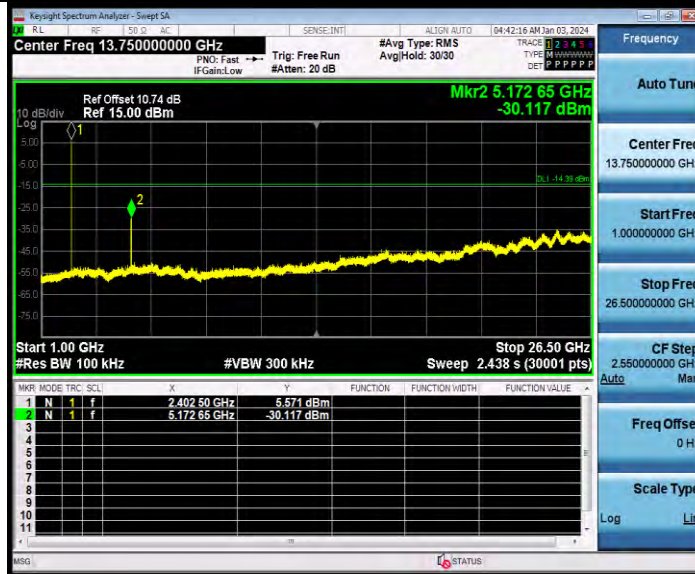

DH5\_Ant1\_2441\_0~Reference



DH5\_Ant1\_2441\_30~1000

BV 7Layers Communications Technology (Shenzhen) Co., Ltd

Room B37, Warehouse A5, No.3 Chiwan 4th Road, Zhaoshang Street, Nanshan District Shenzhen, Guangdong, People's Republic of China

Tel: +86 755 8869 6566  
Fax: +86 755 8869 6577  
Email: [customerservice.sw@bureauveritas.com](mailto:customerservice.sw@bureauveritas.com)



BUREAU VERITAS

### Test Report No.: W7L-231127W001RF01

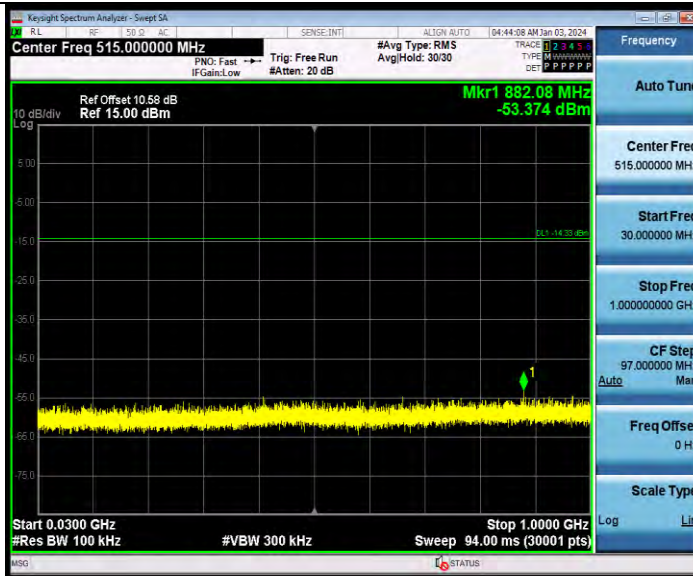

DH5\_Ant1\_2441\_1000~26500



DH5\_Ant1\_2480\_0~Reference

BV 7Layers Communications Technology (Shenzhen) Co., Ltd

Room B37, Warehouse A5, No.3 Chiwan 4th Road, Zhaoshang Street, Nanshan District Shenzhen, Guangdong, People's Republic of China

Tel: +86 755 8869 6566  
 Fax: +86 755 8869 6577  
 Email: [customerservice.sw@bureauveritas.com](mailto:customerservice.sw@bureauveritas.com)



BUREAU VERITAS

Test Report No.: W7L-231127W001RF01



DH5\_Ant1\_2480\_30~1000



DH5\_Ant1\_2480\_1000~26500

BV 7Layers Communications Technology (Shenzhen) Co., Ltd

Room B37, Warehouse A5, No.3 Chiwan 4th Road, Zhaoshang Street, Nanshan District Shenzhen, Guangdong, People's Republic of China

Tel: +86 755 8869 6566  
Fax: +86 755 8869 6577  
Email: [customerservice.sw@bureauveritas.com](mailto:customerservice.sw@bureauveritas.com)



BUREAU VERITAS

# Test Report No.: W7L-231127W001RF01

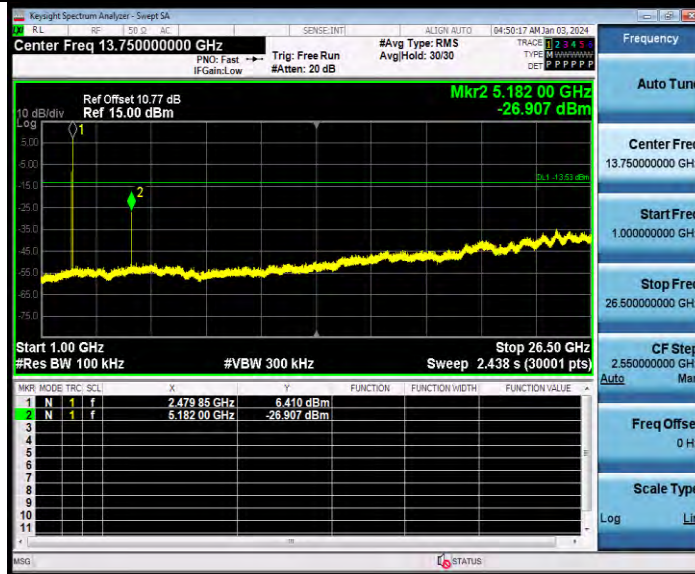

2DH5\_Ant1\_2402\_0~Reference



2DH5\_Ant1\_2402\_30~1000

BV 7Layers Communications Technology (Shenzhen) Co., Ltd

Room B37, Warehouse A5, No.3 Chiwan 4th Road, Zhaoshang Street, Nanshan District Shenzhen, Guangdong, People's Republic of China

Tel: +86 755 8869 6566  
Fax: +86 755 8869 6577  
Email: [customerservice.sw@bureauveritas.com](mailto:customerservice.sw@bureauveritas.com)



BUREAU VERITAS

Test Report No.: W7L-231127W001RF01



2DH5\_Ant1\_2402\_1000~26500

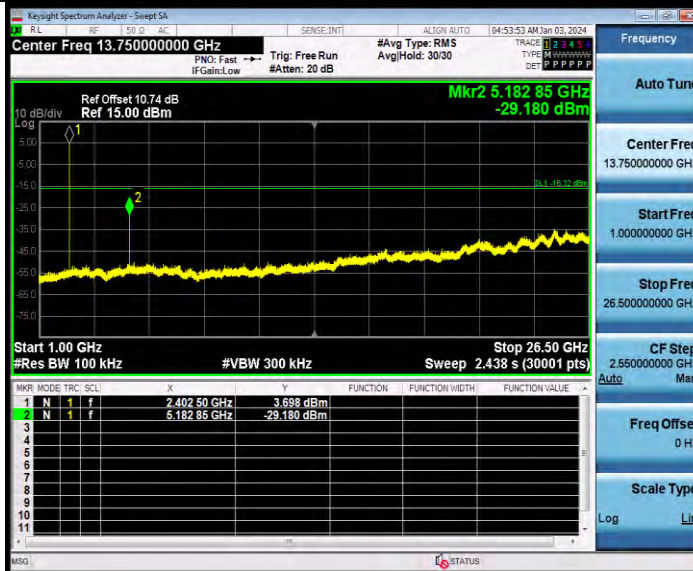

2DH5\_Ant1\_2441\_0~Reference

BV 7Layers Communications Technology (Shenzhen) Co., Ltd

Room B37, Warehouse A5, No.3 Chiwan 4th Road, Zhaoshang Street, Nanshan District Shenzhen, Guangdong, People's Republic of China

Tel: +86 755 8869 6566  
Fax: +86 755 8869 6577  
Email: [customerservice.sw@bureauveritas.com](mailto:customerservice.sw@bureauveritas.com)





BUREAU  
VERITAS

Test Report No.: W7L-231127W001RF01



2DH5\_Ant1\_2441\_30~1000

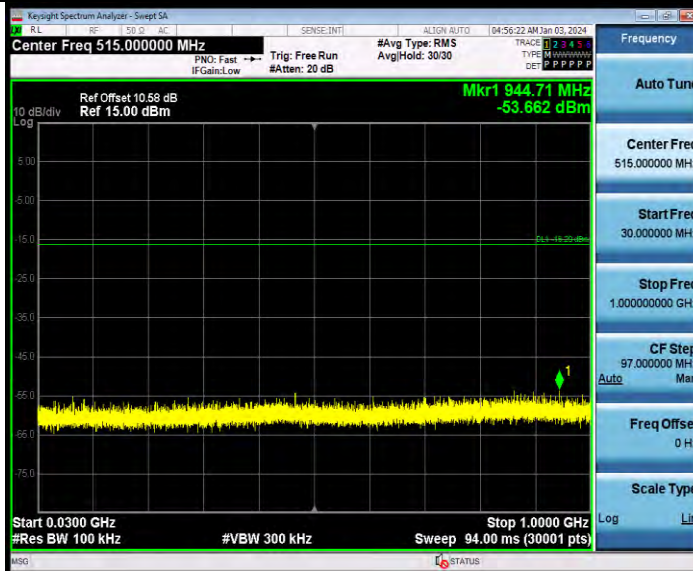

2DH5\_Ant1\_2441\_1000~26500



BUREAU VERITAS

# Test Report No.: W7L-231127W001RF01

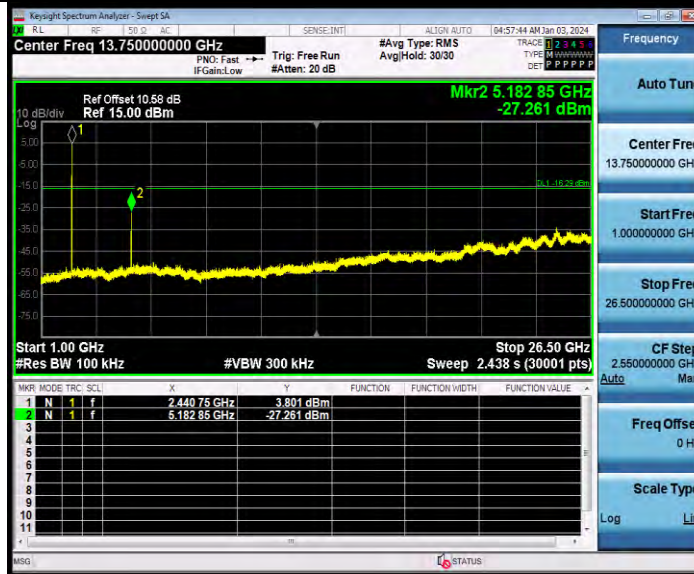

2DH5\_Ant1\_2480\_0~Reference



2DH5\_Ant1\_2480\_30~1000

BV 7Layers Communications Technology (Shenzhen) Co., Ltd

Room B37, Warehouse A5, No.3 Chiwan 4th Road, Zhaoshang Street, Nanshan District Shenzhen, Guangdong, People's Republic of China

Tel: +86 755 8869 6566  
Fax: +86 755 8869 6577  
Email: [customerservice.sw@bureauveritas.com](mailto:customerservice.sw@bureauveritas.com)



BUREAU VERITAS

### Test Report No.: W7L-231127W001RF01



2DH5\_Ant1\_2480\_1000~26500



3DH5\_Ant1\_2402\_0~Reference

BV 7Layers Communications Technology (Shenzhen) Co., Ltd

Room B37, Warehouse A5, No.3 Chiwan 4th Road, Zhaoshang Street, Nanshan District Shenzhen, Guangdong, People's Republic of China

Tel: +86 755 8869 6566  
Fax: +86 755 8869 6577  
Email: [customerservice.sw@bureauveritas.com](mailto:customerservice.sw@bureauveritas.com)



BUREAU VERITAS

Test Report No.: W7L-231127W001RF01



3DH5\_Ant1\_2402\_30~1000



3DH5\_Ant1\_2402\_1000~26500

BV 7Layers Communications Technology (Shenzhen) Co., Ltd

Room B37, Warehouse A5, No.3 Chiwan 4th Road, Zhaoshang Street, Nanshan District Shenzhen, Guangdong, People's Republic of China

Tel: +86 755 8869 6566  
Fax: +86 755 8869 6577  
Email: [customerservice.sw@bureauveritas.com](mailto:customerservice.sw@bureauveritas.com)



BUREAU VERITAS

# Test Report No.: W7L-231127W001RF01

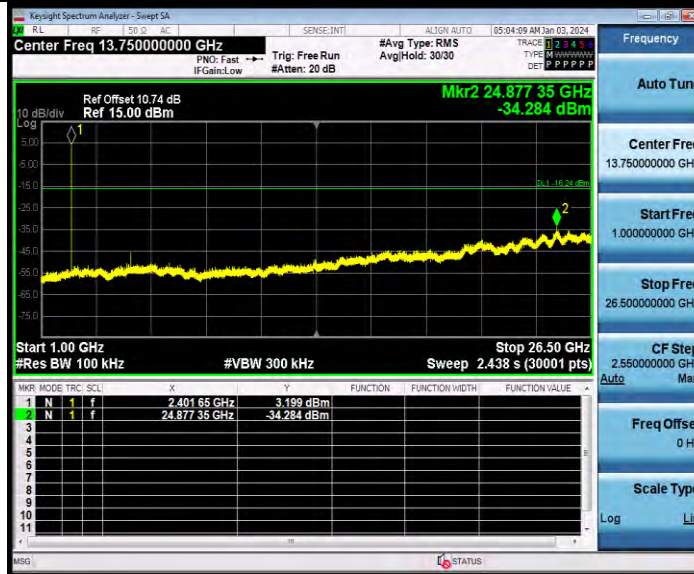

3DH5\_Ant1\_2441\_0~Reference



3DH5\_Ant1\_2441\_30~1000

BV 7Layers Communications Technology (Shenzhen) Co., Ltd

Room B37, Warehouse A5, No.3 Chiwan 4th Road, Zhaoshang Street, Nanshan District Shenzhen, Guangdong, People's Republic of China

Tel: +86 755 8869 6566  
Fax: +86 755 8869 6577  
Email: [customerservice.sw@bureauveritas.com](mailto:customerservice.sw@bureauveritas.com)



BUREAU VERITAS

### Test Report No.: W7L-231127W001RF01

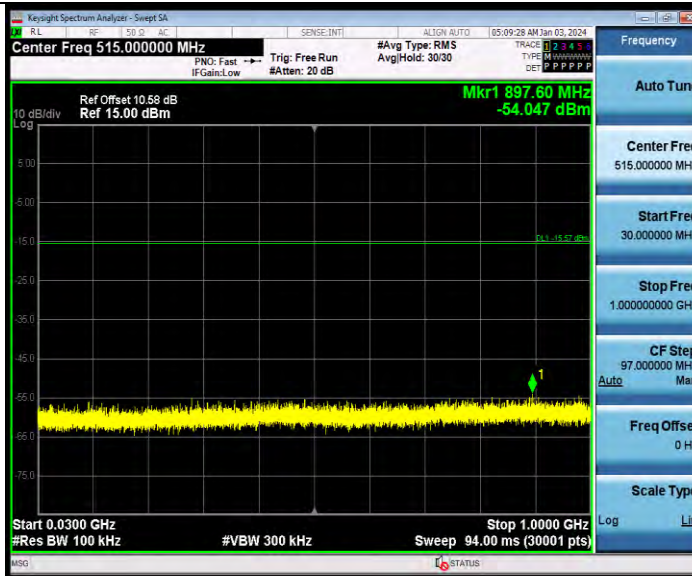

3DH5\_Ant1\_2441\_1000~26500

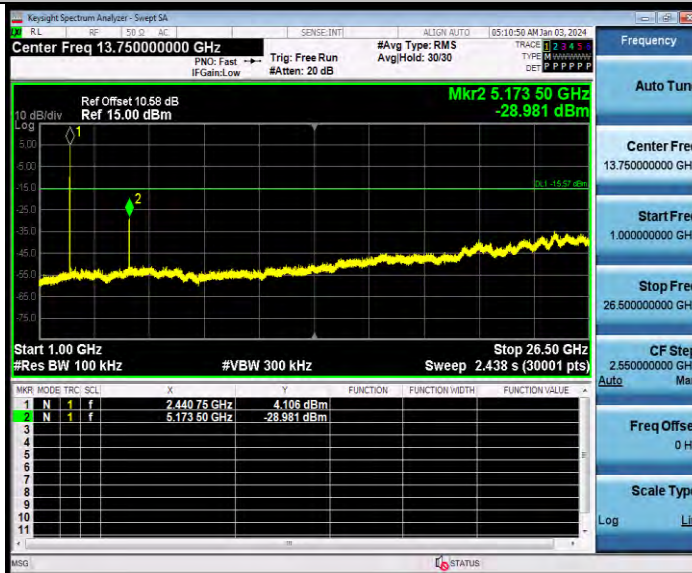

3DH5\_Ant1\_2480\_0~Reference

BV 7Layers Communications Technology (Shenzhen) Co., Ltd

Room B37, Warehouse A5, No.3 Chiwan 4th Road, Zhaoshang Street, Nanshan District Shenzhen, Guangdong, People's Republic of China

Tel: +86 755 8869 6566  
Fax: +86 755 8869 6577  
Email: [customerservice.sw@bureauveritas.com](mailto:customerservice.sw@bureauveritas.com)



BUREAU VERITAS

# Test Report No.: W7L-231127W001RF01



3DH5\_Ant1\_2480\_30~1000



3DH5\_Ant1\_2480\_1000~26500

BV 7Layers Communications Technology (Shenzhen) Co., Ltd

Room B37, Warehouse A5, No.3 Chiwan 4th Road, Zhaoshang Street, Nanshan District Shenzhen, Guangdong, People's Republic of China

Tel: +86 755 8869 6566  
Fax: +86 755 8869 6577  
Email: [customerservice.sw@bureauveritas.com](mailto:customerservice.sw@bureauveritas.com)



BUREAU VERITAS

### Test Report No.: W7L-231127W001RF01



BV 7Layers Communications Technology (Shenzhen) Co., Ltd

Room B37, Warehouse A5, No.3 Chiwan 4th Road, Zhaoshang Street, Nanshan District Shenzhen, Guangdong, People's Republic of China

Tel: +86 755 8869 6566  
Fax: +86 755 8869 6577  
Email: [customerservice.sw@bureauveritas.com](mailto:customerservice.sw@bureauveritas.com)





BUREAU  
VERITAS

Test Report No.: W7L-231127W001RF01

## DUTY CYCLE

### TEST RESULT

TestMode	Antenna	Frequency[M Hz]	ON Time [ms]	Period [ms]	Duty Cycle [%]	Duty Cycle Factor[dB]
DH5	Ant1	2402	0.00	0.00	100	NaN
		2441	0.00	0.00	100	NaN
		2480	0.00	0.00	100	NaN
2DH5	Ant1	2402	100.00	100.00	100.00	0.00
		2441	100.00	100.00	100.00	0.00
		2480	100.00	100.00	100.00	0.00
3DH5	Ant1	2402	100.00	100.00	100.00	0.00
		2441	100.00	100.00	100.00	0.00
		2480	100.00	100.00	100.00	0.00

## TEST GRAPHS

DH5\_Ant1\_2402

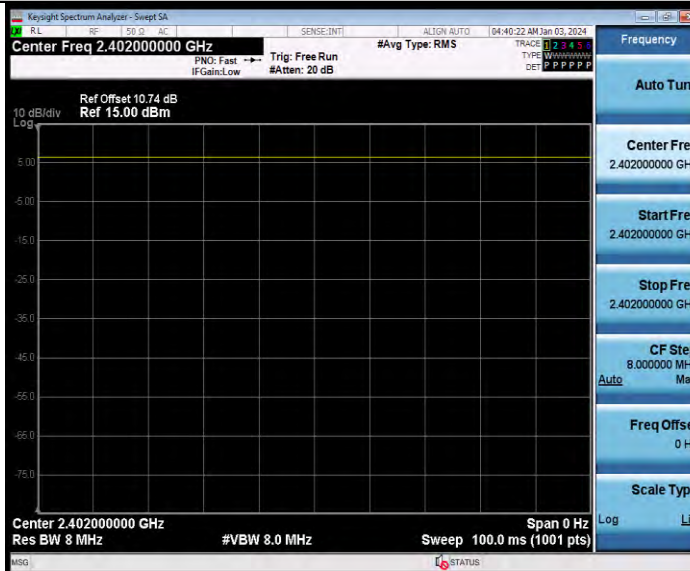

DH5\_Ant1\_2441

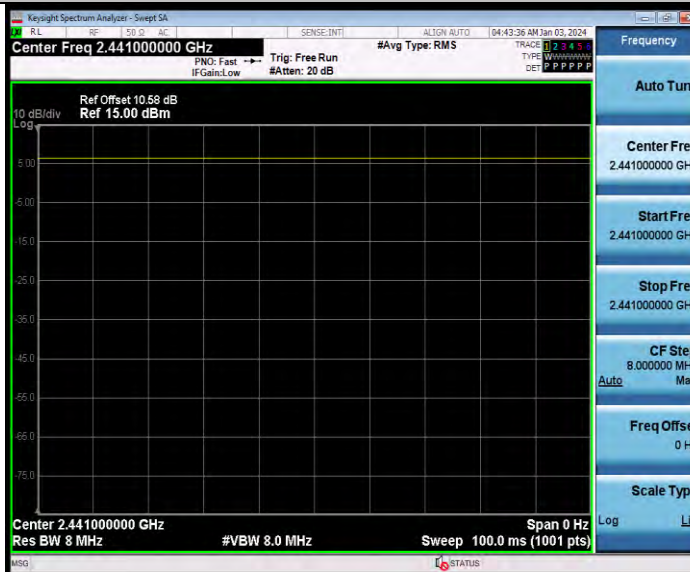

DH5\_Ant1\_2480



BUREAU VERITAS

Test Report No.: W7L-231127W001RF01

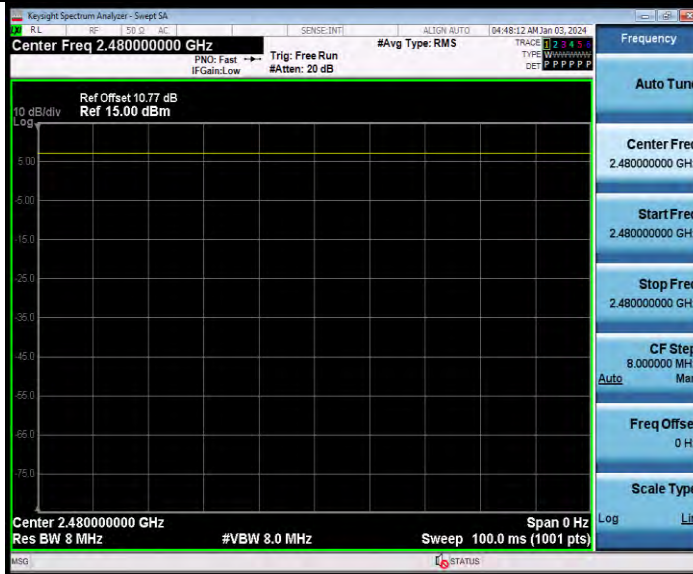

2DH5\_Ant1\_2402

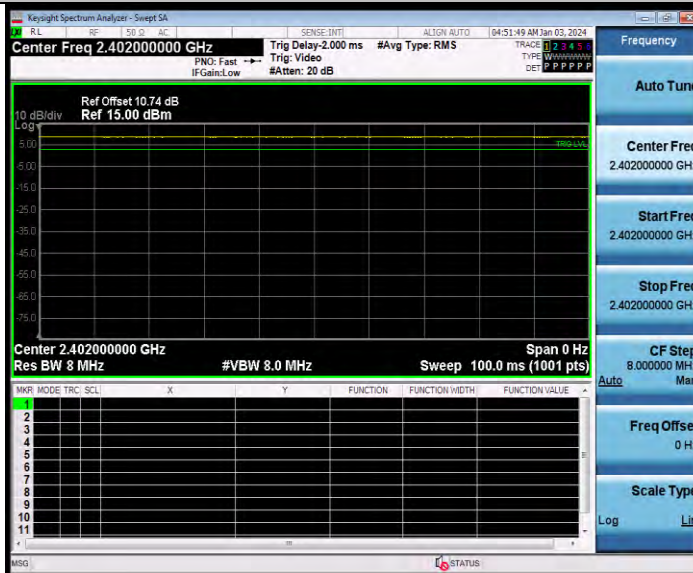

2DH5\_Ant1\_2441



BUREAU VERITAS

# Test Report No.: W7L-231127W001RF01

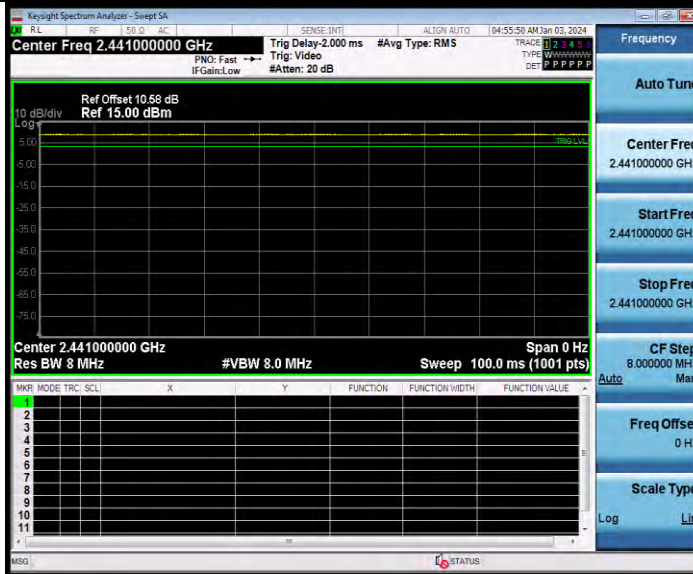

2DH5\_Ant1\_2480

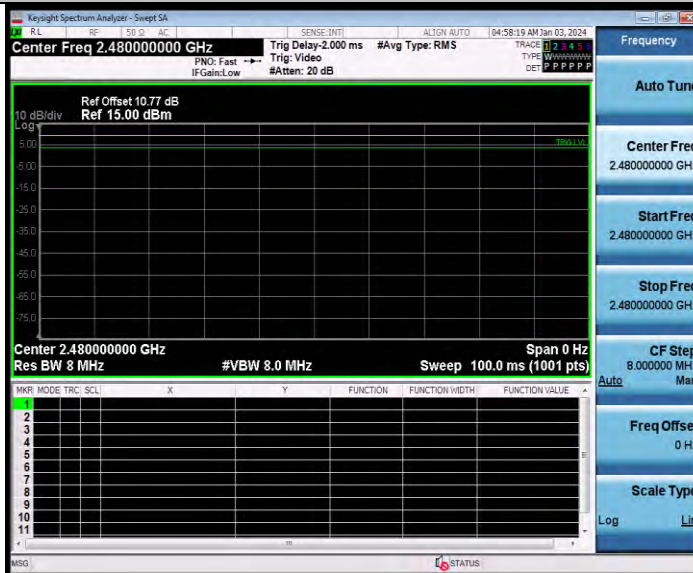

3DH5\_Ant1\_2402

BV 7Layers Communications Technology (Shenzhen) Co., Ltd

Room B37, Warehouse A5, No.3 Chiwan 4th Road, Zhaoshang Street, Nanshan District Shenzhen, Guangdong, People's Republic of China

Tel: +86 755 8869 6566  
Fax: +86 755 8869 6577  
Email: [customerservice.sw@bureauveritas.com](mailto:customerservice.sw@bureauveritas.com)



BUREAU VERITAS

# Test Report No.: W7L-231127W001RF01

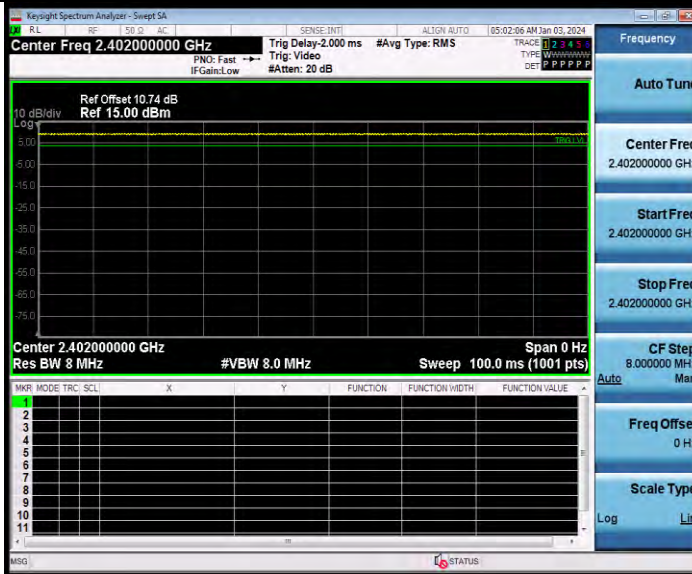

3DH5\_Ant1\_2441

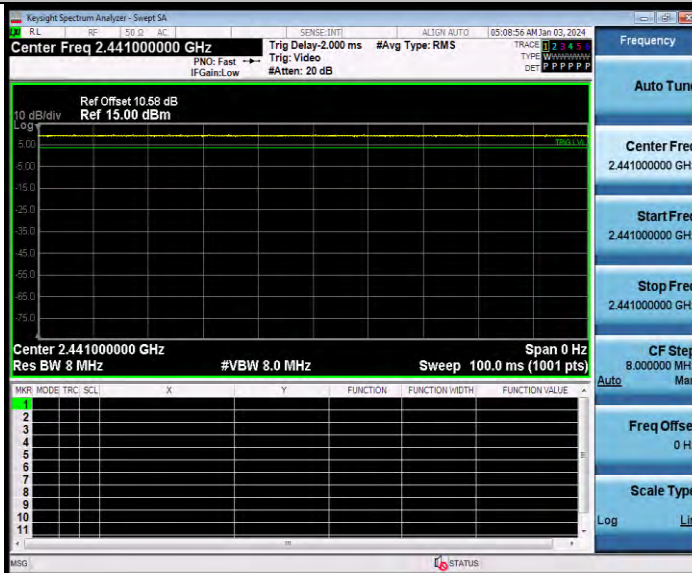

3DH5\_Ant1\_2480



BUREAU VERITAS

Test Report No.: W7L-231127W001RF01

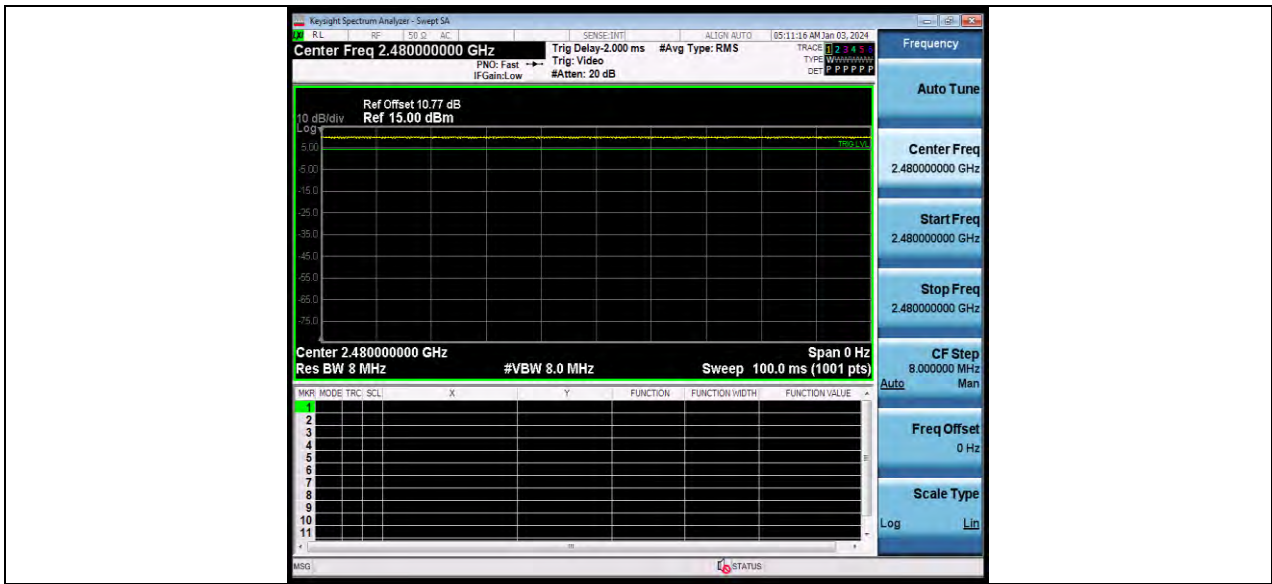

--END--