

ISED CABid: ES1909

Test report No:
 NIE: 68013RRF.001A1

Test report

REFERENCE STANDARD:

USA FCC Part 22 & Part 24 & Part 27 & Part 90
 CANADA IC RSS-130 & RSS-132 & RSS-133 &
 RSS-139

(*) Identification of item tested	Data radio module
(*) Trademark	Telit
(*) Model and /or type reference tested	NE310L2-WW
Other identification of the product	HW version: 1.0 SW version: M0P.100001 IMEI TAC: 35936483 FCC ID: RI7NE310L2WW IC: 5131A-NE310L2WW
(*) Features	LTE FDD Bands: 1, 2, 3, 4, 5, 8, 12, 13, 18, 19, 20, 25, 26, 28, 66, 85, Quad Band 2G
Applicant	Telit Communications S.p.A. Via Stazione di Prosecco 5/B 34010, Sgonico – Trieste, ITALY
Test method requested. standard	USA FCC Part 22 10-1-20 Edition. USA FCC Part 24 10-1-20 Edition. USA FCC Part 27 10-1-20 Edition. USA FCC Part 90 10-1-20 Edition. CANADA RSS-130 Issue 2, Feb. 2019. CANADA RSS-132 Issue 3, Jan. 2013. CANADA RSS-133 Issue 6, Amendment 1 Jan. 2018. CANADA RSS-139 Issue 3, Jul. 2015. ANSI C63.26-2015. KDB 971168 D01 Power Meas License Digital Systems v03r01, April. 2018
Approved by (name / position & signature)	Rafael López Martín EMC Consumer & RF Lab Manager
Date of issue	2021-10-08
Report template No	FDT08_23 (*) "Data provided by the client"

Index

Competences and guarantees	3
General conditions	3
Uncertainty	3
Data provided by the client.....	3
Usage of samples	4
Test sample description	6
Identification of the client.....	7
Testing period and place.....	7
Document history.....	7
Environmental conditions	7
Remarks and comments	8
Testing verdicts.....	8
Summary	9
Appendix A: Test results for FCC Part 22 & 90 / RSS-132	11
Appendix B: Test results for FCC Part 24 / RSS-133	95
Appendix C: Test results for FCC Part 27 / RSS-139 / RSS-130.....	159

Competences and guarantees

DEKRA Testing and Certification is a testing laboratory accredited by the National Accreditation Body (ENAC - Entidad Nacional de Acreditación), to perform the tests indicated in the Certificate No. 51/LE 147.

DEKRA Testing and Certification S.A.U. is an FCC-recognized accredited testing laboratory with the appropriate scope of accreditation that covers the performed tests in this report.

DEKRA Testing and Certification S.A.U. is an ISED-recognized accredited testing laboratory, CABid: ES1909, with the appropriate scope of accreditation that covers the performed tests in this report.

In order to assure the traceability to other national and international laboratories, DEKRA Testing and Certification has a calibration and maintenance program for its measurement equipment.

DEKRA Testing and Certification S.A.U. guarantees the reliability of the data presented in this report, which is the result of the measurements and the tests performed to the item under test on the date and under the conditions stated on the report and, it is based on the knowledge and technical facilities available at DEKRA Testing and Certification at the time of performance of the test.

DEKRA Testing and Certification S.A.U. is liable to the client for the maintenance of the confidentiality of all information related to the item under test and the results of the test.

The results presented in this Test Report apply only to the particular item under test established in this document.

IMPORTANT: No parts of this report may be reproduced or quoted out of context, in any form or by any means, except in full, without the previous written permission of DEKRA Testing and Certification.

General conditions

1. This report is only referred to the item that has undergone the test.
2. This report does not constitute or imply on its own an approval of the product by the Certification Bodies or competent Authorities.
3. This document is only valid if complete; no partial reproduction can be made without previous written permission of DEKRA Testing and Certification.
4. This test report cannot be used partially or in full for publicity and/or promotional purposes without previous written permission of DEKRA Testing and Certification and the Accreditation Bodies.

Uncertainty

Uncertainty (factor $k=2$) was calculated according to the DEKRA Testing and Certification internal document PODT000.

Data provided by the client

The following data has been provided by the client:

1. Information relating to the description of the sample ("Identification of the item tested", "Trademark", "Model and/or type reference tested").
2. The sample consists of a Data radio module, model NE310L2-WW.

DEKRA Testing and Certification S.A.U. declines any responsibility with respect to the information provided by the client and that may affect the validity of results.

Usage of samples

Samples undergoing test have been selected by: the client.

Sample S/01 is composed of the following elements:

Control Nº	Description	Model	Serial Nº	HW version	Date of reception
68013/002	Data radio module	NE310L2-WW	35936483	0.0	2021-06-08

Auxiliary elements used with the Sample S/01:

Control Nº	Description	Model	Serial Nº	Date of reception
66585C/030	Cradle – EVK	---	---	2021-03-09
66585C/008	LTE Antenna	T-AT305-BU	---	2021-02-24
66585C/031	USB cable	---	---	2021-03-09

1. Sample S/01 has undergone the following test(s):
The radiated tests indicated in Appendixes A, B and C.

Sample S/02 is composed of the following elements:

Control Nº	Description	Model	Serial Nº	HW version	Date of reception
68013/007	Data radio module	NE310L2-WW	35936483	0.0	2021-06-08

Auxiliary elements used with the Sample S/02:

Control Nº	Description	Model	Serial Nº	Date of reception
66585C/020	Cradle – EVK	---	---	2021-03-09
66585C/031	USB cable	---	---	2021-03-09

1. Sample S/02 has undergone the following test(s):
The conducted tests except RF output power for NBLoT, Frequency Stability for NBLoT and Conducted Spurious Emissions for NBLoT & 2G, indicated in Appendixes A, B and C.

Sample S/03 is composed of the following elements:

Control N°	Description	Model	Serial N°	HW version	Date of reception
68013/008	Data radio module	NE310L2-WW	35936483	1.0	2021-06-08

Auxiliary elements used with the Sample S/02:

Control N°	Description	Model	Serial N°	Date of reception
66585C/020	Cradle – EVK	---	---	2021-03-09
66585C/031	USB cable	---	---	2021-03-09

1. Sample S/03 has undergone the following test(s):

The conducted tests RF output power for NBloT, Frequency Stability for NBloT and Conducted Spurious Emissions for NBloT & 2G indicated in Appendixes A, B and C.

Test sample description

Ports..... :	Port name and description	Cable					
		Specified max length [m]	Attached during test	Shielded	Coupled to patient ⁽³⁾		
	[]	[]	[]		
Supplementary information to the ports..... :						
Rated power supply	Voltage and Frequency		Reference poles				
			L1	L2	L3	N	PE
	[]	AC:	[]	[]	[]	[]	[]
	[X]	DC: 3.2– 4.2VDC (typ 3.8 VDC)					
Rated Power	LTE 23 dBm, GSM858/900: 32.5 dBm GSM1800/1900: 29.5 dBm						
Clock frequencies..... :	Clock 26MHz, XTAL 32.768kHz						
Other parameters	-30°C to + 70°C						
Software version	M0P.100001						
Hardware version	1.0						
Dimensions in cm (W x H x D)	13.1 x 14.3 mm						
Mounting position	[]	Table top equipment					
	[]	Wall/Ceiling mounted equipment					
	[]	Floor standing equipment					
	[]	Hand-held equipment					
	[X]	Other: solder down on host equipment					
Modules/parts..... :	Module/parts of test item		Type	Manufacturer			
	None, the device is module itself				
Accessories (not part of the test item)	Description		Type	Manufacturer			
	Antenna only for testing purposed		T-AT305	ATEL-CAB			
Documents as provided by the applicant..... :	Description		File name	Issue date			
			

⁽³⁾ Only for Medical Equipment

Identification of the client

Telit Communications S.p.A.
Via Stazione di Prosecco 5/B
34010, Sgonico – Trieste, ITALY

Testing period and place

Test Location	DEKRA Testing and Certification S.A.U.
Date (start)	2021-06-28
Date (finish)	2021-09-15

Document history

Report number	Date	Description
68013RRF.001	2021-09-27	First release
68013RRF.001A1	2021-10-08	Second release. First modification due to typos. This modification test report cancels and replaces the test report 68013RRF.001

Environmental conditions

In the control chamber, the following limits were not exceeded during the test:

Temperature	Min. = 15 °C Max. = 35 °C
Relative humidity	Min. = 20 % Max. = 75 %
Air pressure	Min. = 860 mbar Max. = 1060 mbar

In the semianechoic chamber, the following limits were not exceeded during the test.

Temperature	Min. = 15 °C Max. = 35 °C
Relative humidity	Min. = 20 % Max. = 75 %
Air pressure	Min. = 860 mbar Max. = 1060 mbar

In the chamber for conducted measurements, the following limits were not exceeded during the test:

Temperature	Min. = 15 °C Max. = 35 °C
Relative humidity	Min. = 20 % Max. = 75 %
Air pressure	Min. = 860 mbar Max. = 1060 mbar

Remarks and comments

The tests have been performed by the technical personnel: Nicolás Salguero, Verónica García and Alfonso Gutierrez.

Used instrumentation:

Conducted Measurements

	Last Cal. date	Cal. due date
1. Temperature Chamber BINDER MK 56	2021/03	2022/03
2. DC POWER SUPPLY 30V/5A KEYSIGHT U8002A	N/A	N/A
3. Digital Multimeter FLUKE 179	2020/10	2021/10
4. Spectrum Analyzer 10Hz-40GHz ROHDE AND SCHWARZ FSV40	2020/03	2022/03
5. Signal Analyzer 20Hz-8GHz ROHDE AND SCHWARZ FSQ8	2020/10	2022/10
6. Wideband Radio Communication Tester ROHDE AND SCHWARZ CMW500	2021/02	2022/02

Radiated Measurements:

	Last Calibration	Due Calibration
1. Semianechoic Absorber Lined Chamber ETS FACT3 200STP	N/A	N/A
2. Shielded Room ETS LINDGREN S101	N/A	N/A
3. EMI Test Receiver 7 GHz ROHDE AND SCHWARZ ESR7	2020/12	2022/12
4. Preamplifier G>40dB 10MHz-6GHz, BONN ELEKTRONIK, BLNA 0160-01N	2021/03	2022/03
5. Biconical/Log Antenna 30 MHz - 6 GHz ETS LINDGREN 3142E	2020/04	2023/04
6. Spectrum Analyzer ROHDE AND SCHWARZ FSW50	2020/07	2022/07
7. Horn Antenna 1-18 GHz SCHWARZBECK MESS-ELEKTRONIK BBHA 9120 D	2019/11	2022/11
8. RF Preamplifier, 40 dB ,1-18 GHz BONN ELEKTRONIK BLMA 0118-1M	2021/06	2022/06
9. DC POWER SUPPLY 30V/5A KEYSIGHT U8002A	N/A	N/A
10. Digital Multimeter FLUKE 179	2020/10	2021/10
11. Wideband Radio Communication Tester ROHDE AND SCHWARZ CMW500	2021/02	2022/02
12. Wideband Radio Communication Tester ROHDE AND SCHWARZ CMW500	2021/01	2022/02
13. RF pre-amplifier, G>30dB, 18-40 GHz BONN ELEKTRONIK BLMA 1840-3G	2019/11	2021/11
14. Broadband Horn antenna 18-40 GHz SCHWARZBECK BBHA 9170	2020/05	2023/05

Testing verdicts

Not applicable :	N/A
Pass :	P
Fail :	F
Not measured :	N/M

Summary

FCC PART 22/IC RSS-132 PARAGRAPH		
Requirement – Test case	Verdict	Remark
Clause 22.913/RSS-132 Clause 5.4: RF output power	P	
Clause 2.1047/RSS-132 Clause 5.2: Modulation characteristics	P	
Clause 22.355/RSS-132 Clause 5.3: Frequency stability	P	
Clause 2.1049: Occupied Bandwidth	P	
Clause 22.917/RSS-132 Clause 5.5: Spurious emissions at antenna terminals	P	
Clause 22.917/RSS-132 Clause 5.5: Radiated emissions	P	
<u>Supplementary information and remarks:</u>		
None.		

FCC PART 24/IC RSS-133 PARAGRAPH		
Requirement – Test case	Verdict	Remark
Clause 24.232/RSS-133 Clause 6.4: RF output power	P	
Clause 2.1047/RSS-133 Clause 6.2: Modulation characteristics	P	
Clause 24.235/RSS-133 Clause 6.3: Frequency stability	P	
Clause 2.1049: Occupied Bandwidth	P	
Clause 24.238/RSS-133 Clause 6.5: Spurious emissions at antenna terminals	P	
Clause 24.238/RSS-133 Clause 6.5: Radiated emissions	P	
<u>Supplementary information and remarks:</u>		
None.		

FCC PART 27 / RSS-139 / RSS-130 PARAGRAPH		
Requirement – Test case	Verdict	Remark
Clause 27.50 / RSS-139 Clause 6.5. / RSS-130 Clause 4.6.: RF output power	P	
Clause 2.1047 / RSS-139 Clause 6.2. / RSS-130 Clause 4.2.: Modulation characteristics	P	
Clause 27.54 / RSS-139 Clause 6.4. / RSS-130 Clause 4.5.: Frequency stability	P	
Clause 2.1049: Occupied Bandwidth	P	
Clause 27.53 / RSS-139 Clause 6.6. / RSS-130 Clause 4.7.: Spurious emissions at antenna terminals	P	
Clause 27.53 / RSS-139 Clause 6.6. / RSS-130 Clause 4.7.: Radiated emissions	P	
<u>Supplementary information and remarks:</u>		
(1) None.		

FCC PART 90 PARAGRAPH		
Requirement – Test case	Verdict	Remark
Clause 90.635 (b): RF output power	P	
Clause 2.1047: Modulation characteristics	P	
Clause 90.213 Frequency stability	P	
Clause 2.1049: Occupied Bandwidth	P	
Clause 90.691 Spurious emissions at antenna terminals (Emission mask requirements for EA-based systems)	P	
Clause 90.691: Radiated emissions	P	
<u>Supplementary information and remarks:</u> None.		

Appendix A: Test results for FCC Part 22 & 90 / RSS-132

INDEX

TEST CONDITIONS.....	13
RF Output Power	15
Frequency Stability	28
Modulation Characteristics	33
Occupied Bandwidth.....	37
Spurious emissions at antenna terminals	57
Spurious emissions at antenna terminals at Block Edges.....	72
Radiated emissions	80

TEST CONDITIONS

Vnominal = 3.8 Vdc

Type of power supply = DC Voltage from external power supply

Type of antenna = External antenna.

Declared Gain for antenna = +2.15 dBi.

TEST FREQUENCIES:

2G Band 850 MHz:

GPRS and EDGE MODULATIONS:

Lowest Channel (128):	824.2 MHz
Middle Channel (190):	836.6 MHz
Highest Channel (251):	848.8 MHz

814-824MHz Band:

NBLoT. $\pi/2$ - BPSK AND $\pi/4$ - QPSK MODULATION (BAND 26)

Channel (Frequency. MHz)		
Lowest	Middle	Highest
26692	26740	26788
(814.2)	(819)	(823.8)

Cross-rule channel (824MHz):

NBLoT. $\pi/2$ - BPSK AND $\pi/4$ - QPSK MODULATION (BAND 26)

Channel (Frequency. MHz)
26790
(824)

824-849MHz Band:

NBLoT. $\pi/2$ - BPSK AND $\pi/4$ - QPSK MODULATION (BAND 5)

Channel (Frequency. MHz)		
Lowest	Middle	Highest
20402	20525	20648
(824.2)	(836.5)	(848.8)

NBLoT. $\pi/2$ - BPSK AND $\pi/4$ - QPSK MODULATION (BAND 26)

Channel (Frequency. MHz)		
Lowest	Middle	Highest
26792	26915	27038
(824.2)	(836.5)	(848.8)

NOTE: Band 26 is completely included in band 5, so the channels of band 5 were tested to give conformity to the assigned block.

RF Output Power

SPECIFICATION

FCC §2.1046 and §22.913. The Effective Radiated Power (E.R.P.) of mobile transmitter and auxiliary test transmitter must not exceed 7 Watts (38.45 dBm E.R.P.).

RSS-132. Clause 5.4. The equivalent isotropically radiated power (e.i.r.p.) for mobile equipment shall not exceed 11.5 watts (38.45 dBm E.R.P.).

The peak-to-average power ratio (PAPR) of the transmission shall not exceed 13 dB.

FCC §90.635. The maximum output power of the transmitter for mobile stations is 100 watts (20 dBw).

The peak-to-average power ratio (PAPR) of the transmission shall not exceed 13 dB.

METHOD

The conducted RF output power measurements were made at the RF output terminals of the EUT using the power meter of the Universal Radio Communication tester R&S CMW500. selecting maximum transmission power of the EUT and different modes of modulation.

The maximum equivalent isotropically radiated power (e.i.r.p.) is calculated by adding the declared maximum antenna gain (dBi).

The maximum effective radiated power e.r.p. is calculated from the maximum equivalent isotropically radiated power (e.i.r.p.) by subtracting 2.15 dB:

$$E.R.P. = E.I.R.P. - 2.15 \text{ dB}$$

The peak-to-average power ratio (PAPR) is measured using an attenuator, power splitter and spectrum analyser with a Complementary Cumulative Distribution Function implemented.

The EUT was controlled via the Universal Radio Communication tester R&S CMW500 selecting maximum transmission power of the EUT and different modes of modulation.

TEST SETUP

Conducted average power.



Peak-to-average power ratio (PAPR)

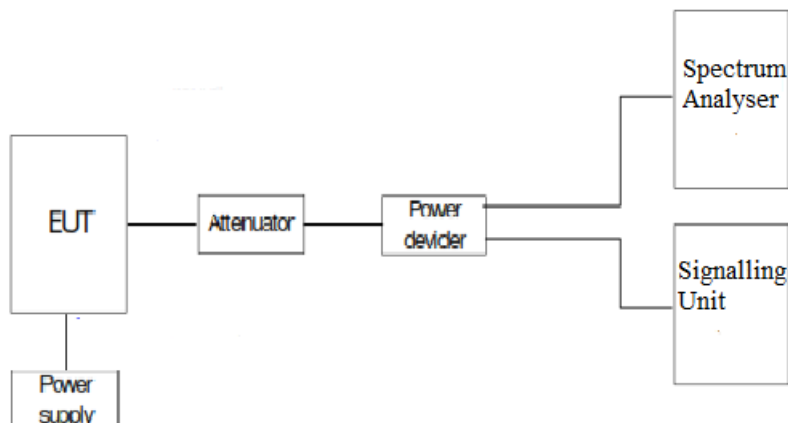

RESULTS

2G Band 850 MHz:

GPRS MODULATION:

Channel	Lowest	Middle	Highest
Maximum declared antenna gain (dBi)	2.15	2.15	2.15
Measured maximum average power (dBm) at antenna port	32.88	32.97	32.86
Maximum equivalent isotropically radiated power (E.I.R.P.) (dBm)	35.03	35.12	35.01
Maximum effective radiated power E.R.P. (dBm)	32.88	32.97	32.86
PAPR (dB)	0.29	0.29	0.27
Measurement uncertainty (dB)	<±1.58		

EDGE MODULATION:

Channel	Lowest	Middle	Highest
Maximum declared antenna gain (dBi)	2.15	2.15	2.15
Measured maximum average power (dBm) at antenna port	32.89	32.97	32.87
Maximum equivalent isotropically radiated power (E.I.R.P.) (dBm)	35.04	35.12	35.02
Maximum effective radiated power E.R.P. (dBm)	32.89	32.97	32.87
PAPR (dB)	0.26	0.29	0.27
Measurement uncertainty (dB)	<±1.58		

NBloT:

814-824 MHz Band:

Ch	Freq. (MHz)	Modulation	BW (kHz)	Num. tone	Offset Tone	Average Power (dBm)	PAPR (dB)
26692	814.2	$\pi/2$ - BPSK	3.75	1	0	23.39	(*)
				1	47	23.32	(*)
			15	1	0	23.74	(*)
				1	11	23.65	(*)
		$\pi/4$ - QPSK	3.75	1	0	23.47	(*)
				1	47	23.43	(*)
			15	1	0	23.50	(*)
				1	11	23.34	(*)
				3	0	22.57	4.99
				3	6	23.17	4.63
				6	0	21.90	5.87
				6	6	22.09	6.15
12	0	20.94	6.79				
26740	819	$\pi/2$ - BPSK	3.75	1	0	23.31	(*)
				1	47	23.28	(*)
			15	1	0	23.89	(*)
				1	11	23.83	(*)
		$\pi/4$ - QPSK	3.75	1	0	23.35	(*)
				1	47	23.40	(*)
			15	1	0	23.57	(*)
				1	11	23.53	(*)
				3	0	22.74	4.73
				3	6	23.18	4.60
				6	0	22.05	6.14
				6	6	22.01	6.18
12	0	21.04	6.81				
26788	823.8	$\pi/2$ - BPSK	3.75	1	0	23.32	(*)
				1	47	23.36	(*)
			15	1	0	23.90	(*)
				1	11	23.89	(*)
		$\pi/4$ - QPSK	3.75	1	0	23.48	(*)
				1	47	23.46	(*)
			15	1	0	23.68	(*)
				1	11	23.58	(*)
				3	0	22.87	4.69
				3	6	23.20	4.62
				6	0	22.15	6.14
				6	6	22.19	6.10
12	0	21.13	6.78				

(*): Preliminary measurements determined that 3, 6 or 12 tones of 15kHz as the worst case. The results in the next tables shows the results for this configuration.

Cross-rule channel (824MHz):

Ch	Freq. (MHz)	Modulation	BW (kHz)	Num. tone	Offset Tone	Average Power (dBm)	PAPR (dB)
26790	824	$\pi/2$ - BPSK	3.75	1	0	23.45	(*)
				1	47	23.46	(*)
			15	1	0	23.96	(*)
				1	11	23.89	(*)
		$\pi/4$ - QPSK	3.75	1	0	23.49	(*)
				1	47	23.52	(*)
			15	1	0	23.64	(*)
				1	11	23.49	(*)
				3	0	22.69	4.71
				3	6	22.71	4.59
				6	0	22.08	6.10
				6	6	22.30	6.00
		12	0	21.13	6.74		

(*): Preliminary measurements determined that 3, 6 or 12 tones of 15kHz as the worst case. The results in the next tables shows the results for this configuration.

824-849MHz Band:

Ch	Freq. (MHz)	Modulation	BW (kHz)	Num. tone	Offset Tone	Average Power (dBm)	PAPR (dB)
20402	824.2	$\pi/2$ - BPSK	3.75	1	0	23.50	(*)
				1	47	23.40	(*)
			15	1	0	23.89	(*)
				1	11	23.74	(*)
		$\pi/4$ - QPSK	3.75	1	0	23.47	(*)
				1	47	23.47	(*)
			15	1	0	23.73	(*)
				1	11	23.68	(*)
				3	0	22.69	4.57
				3	6	23.35	4.91
				6	0	22.17	6.01
				6	6	22.20	6.07
		12	0	21.16	6.83		
		20525	836.5	$\pi/2$ - BPSK	3.75	1	0
1	47					23.78	(*)
15	1				0	23.81	(*)
	1				11	23.67	(*)
$\pi/4$ - QPSK	3.75			1	0	23.98	(*)
				1	47	23.94	(*)
	15			1	0	23.46	(*)
				1	11	23.44	(*)
				3	0	22.69	4.70
				3	6	23.16	4.64
				6	0	22.11	6.20
				6	6	21.97	6.06
12	0			21.01	6.73		
20648	848.8			$\pi/2$ - BPSK	3.75	1	0
		1	47			23.50	(*)
		15	1		0	23.64	(*)
			1		11	23.63	(*)
		$\pi/4$ - QPSK	3.75	1	0	23.51	(*)
				1	47	23.57	(*)
			15	1	0	23.32	(*)
				1	11	23.26	(*)
				3	0	22.56	4.62
				3	6	22.93	4.66
				6	0	21.81	6.27
				6	6	21.97	6.17
		12	0	20.83	6.75		

(*): Preliminary measurements determined that 3, 6 or 12 tones of 15kHz as the worst case. The results in the next tables shows the results for this configuration.

814-824 MHz Band:

Channel	Measured maximum average power (dBm) at antenna port	Maximum declared antenna gain (dBi)	Maximum equivalent isotropically radiated power (E.I.R.P.) (dBm)	Maximum effective radiated power E.R.P. (dBm)
Lowest	22.80	+2.15	24.95	22.80
Middle	23.25	+2.15	25.40	23.25
Highest	22.89	+2.15	25.04	22.89
Measurement uncertainty (dB)	<±0.941			

Cross-rule channel (824MHz):

Channel	Measured maximum average power (dBm) at antenna port	Maximum declared antenna gain (dBi)	Maximum equivalent isotropically radiated power (E.I.R.P.) (dBm)	Maximum effective radiated power E.R.P. (dBm)
26790 (824)	23.86	+2.15	26.01	23.86
Measurement uncertainty (dB)	<±0.941			

824-849MHz Band:

Channel	Measured maximum average power (dBm) at antenna port	Maximum declared antenna gain (dBi)	Maximum equivalent isotropically radiated power (E.I.R.P.) (dBm)	Maximum effective radiated power E.R.P. (dBm)
Lowest	23.03	+2.15	25.18	23.03
Middle	23.34	+2.15	25.49	23.34
Highest	23.06	+2.15	25.21	23.06
Measurement uncertainty (dB)	<±0.941			

Verdict: PASS

PEAK-TO-AVERAGE POWER RATIO (PAPR).

2G Band 850 MHz. GPRS MODULATION.

Low Channel:

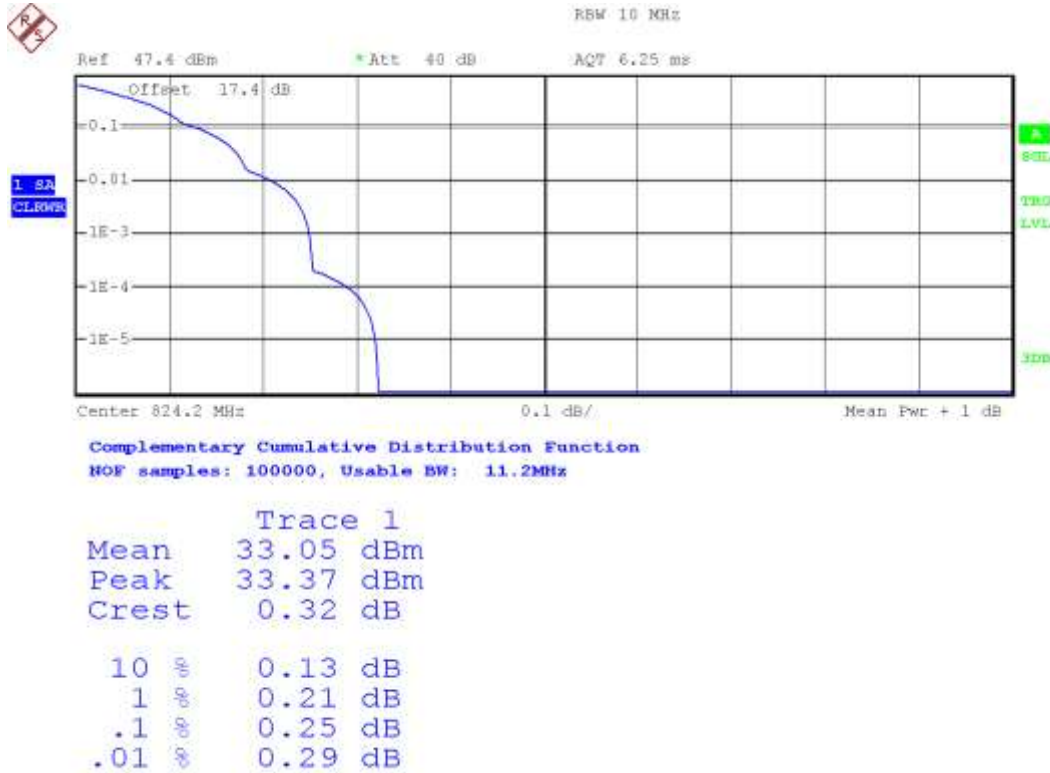

Middle Channel:

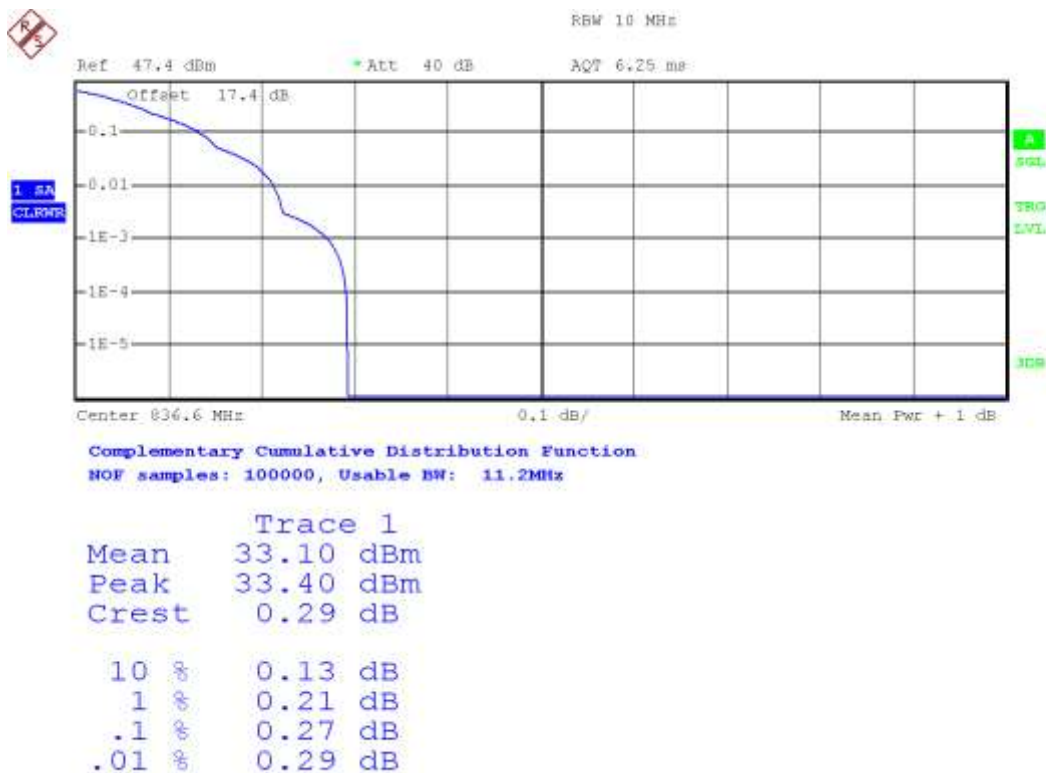

High Channel:

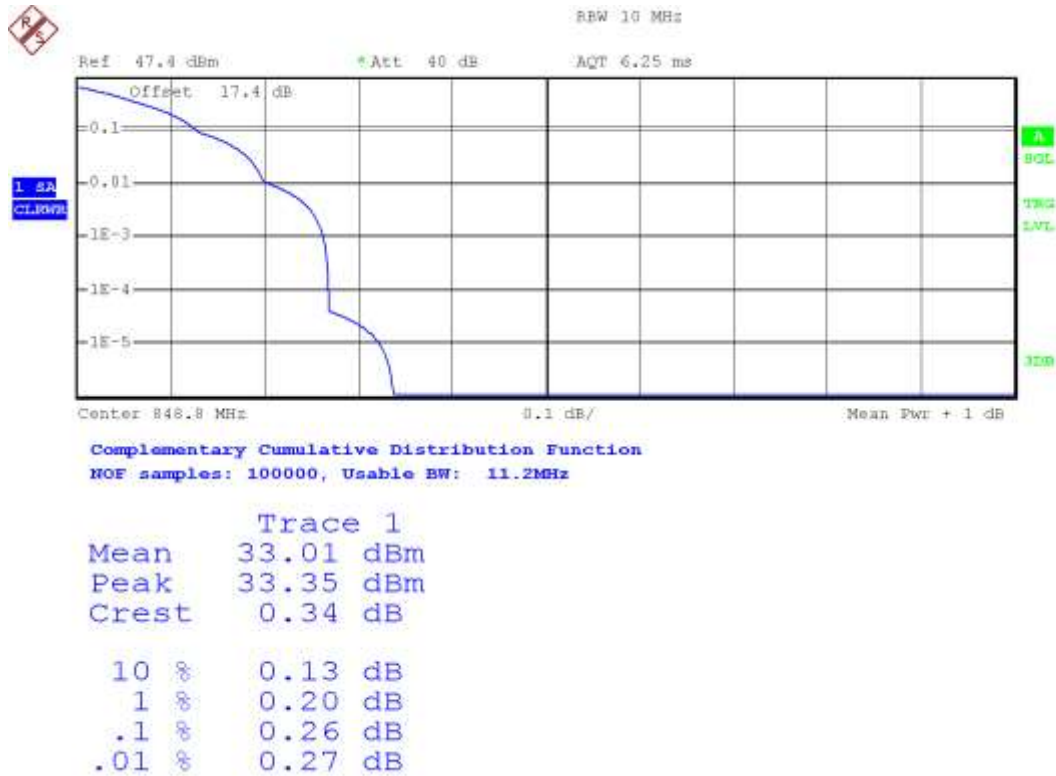

2G Band 850 MHz. EDGE MODULATION.

Low Channel:

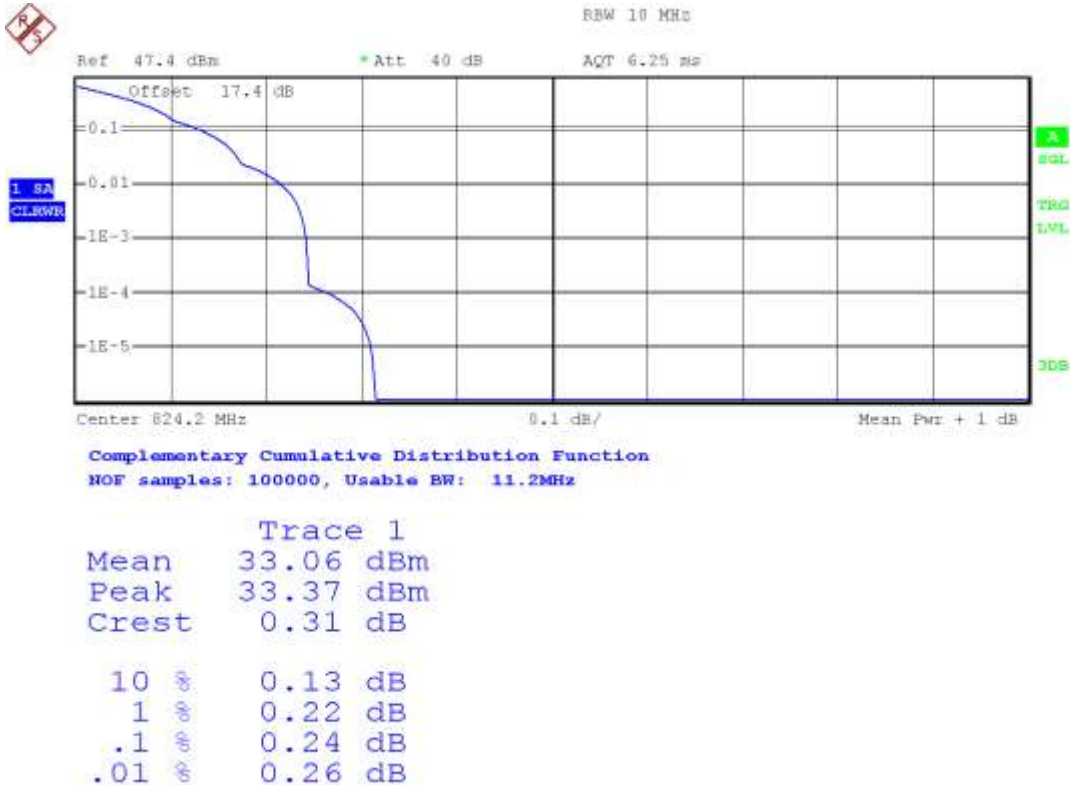

Middle Channel:

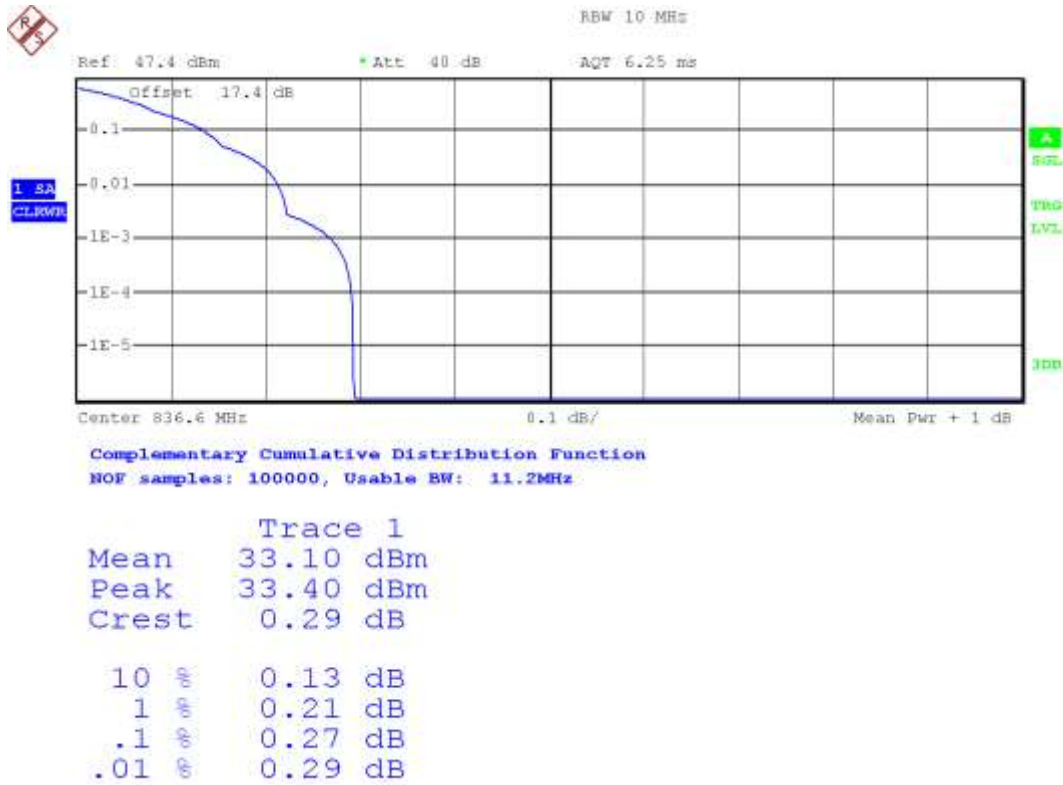

High Channel:

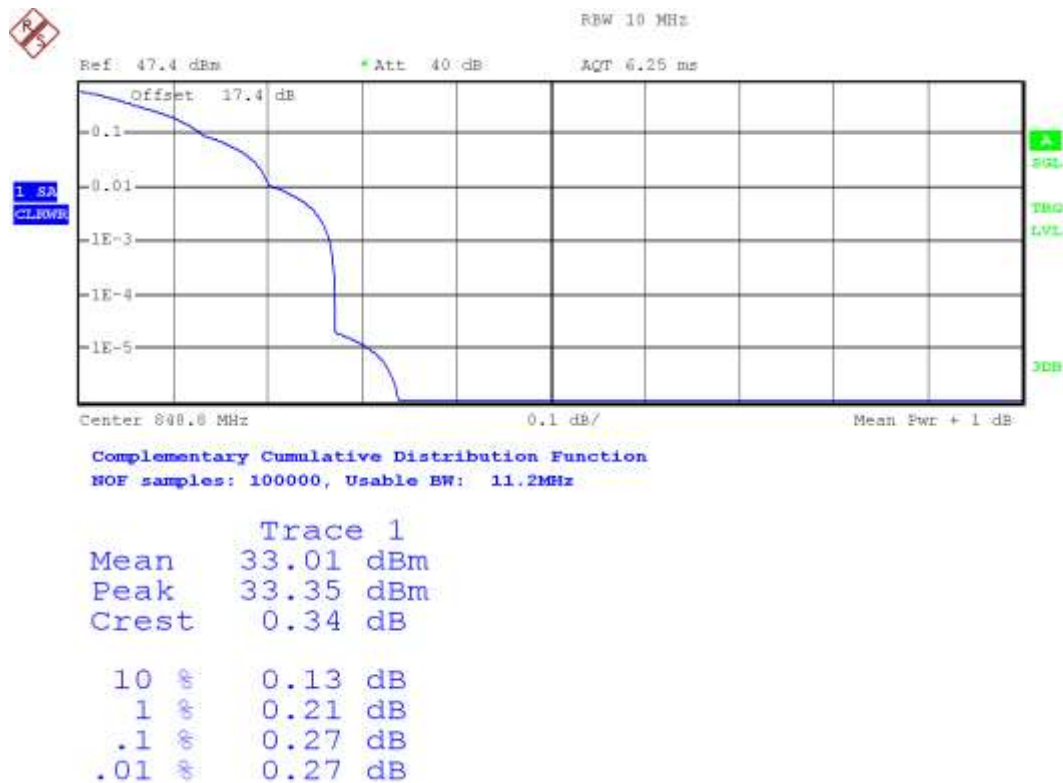

814-824 MHz Band

NB-IoT BAND 26.

Preliminary measurements determined that 12 tones of 15kHz as the worst case. The results in the next tables shows the results for this configuration.

Channel Low:



Channel Middle:

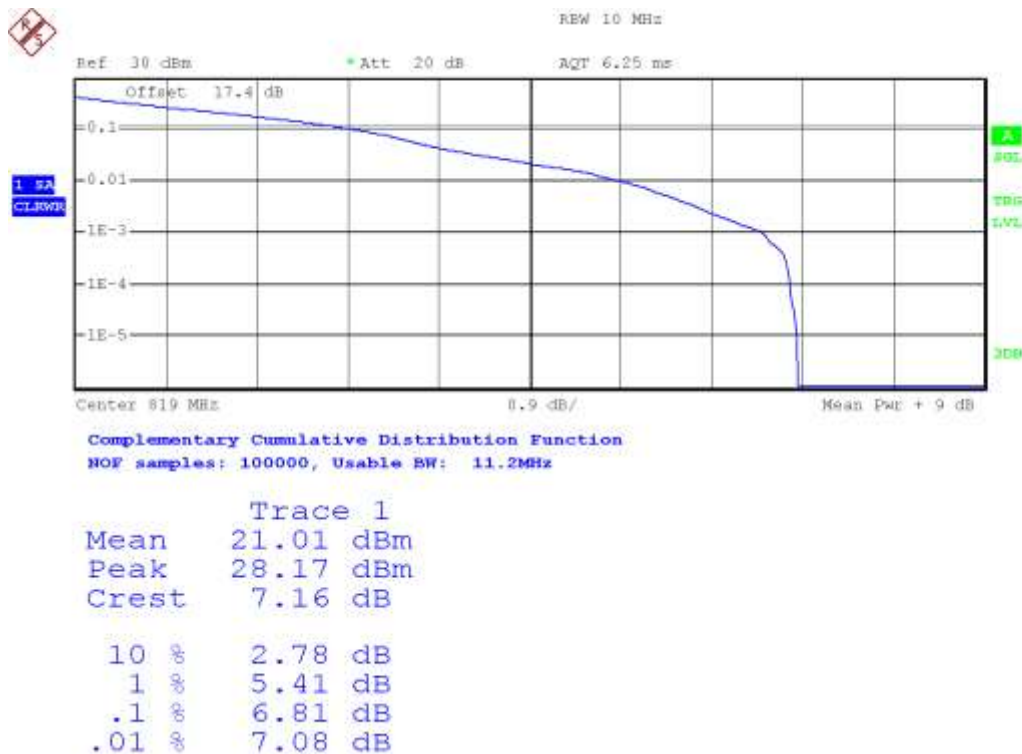

Channel High:

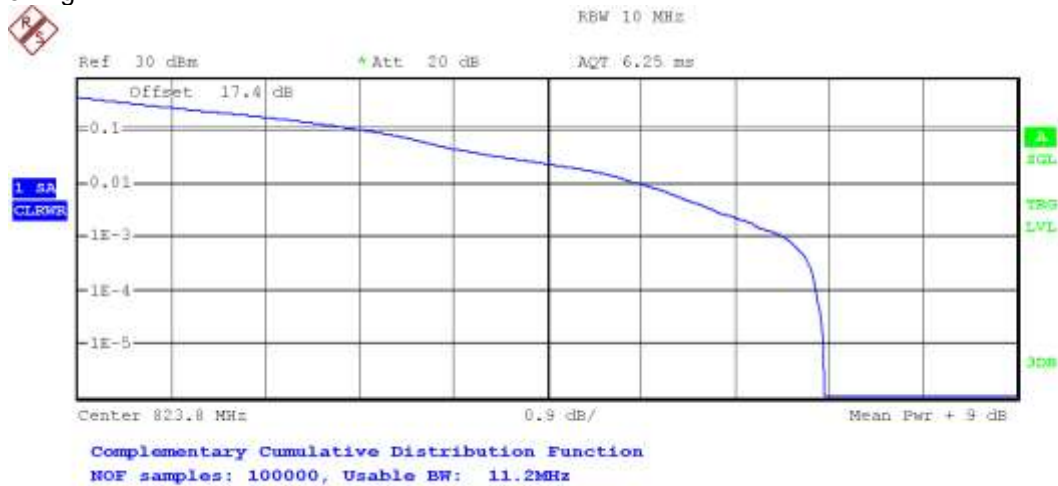

Trace 1	
Mean	21.03 dBm
Peak	28.18 dBm
Crest	7.15 dB
10 %	2.80 dB
1 %	5.41 dB
.1 %	6.78 dB
.01 %	7.08 dB

824 MHz Band

NB-IoT BAND 26.

Preliminary measurements determined that 12 tones of 15kHz as the worst case. The results in the next tables shows the results for this configuration.

Channel 824MHz:

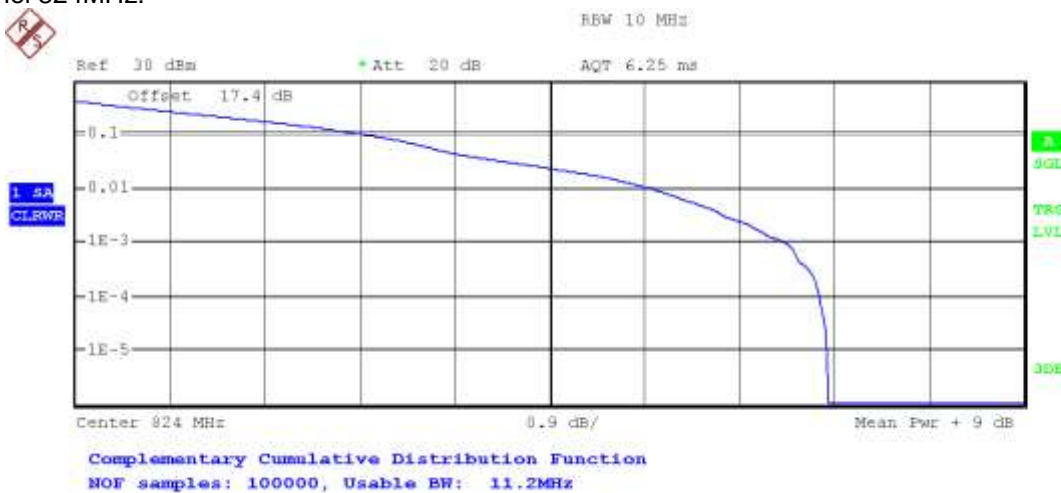

Trace 1	
Mean	21.04 dBm
Peak	28.18 dBm
Crest	7.14 dB
10 %	2.78 dB
1 %	5.48 dB
.1 %	6.74 dB
.01 %	7.07 dB

824-849 MHz Band

NB IoT BAND 5.

Preliminary measurements determined that 12 tones of 15kHz as the worst case. The results in the next tables shows the results for this configuration.

Channel Low:

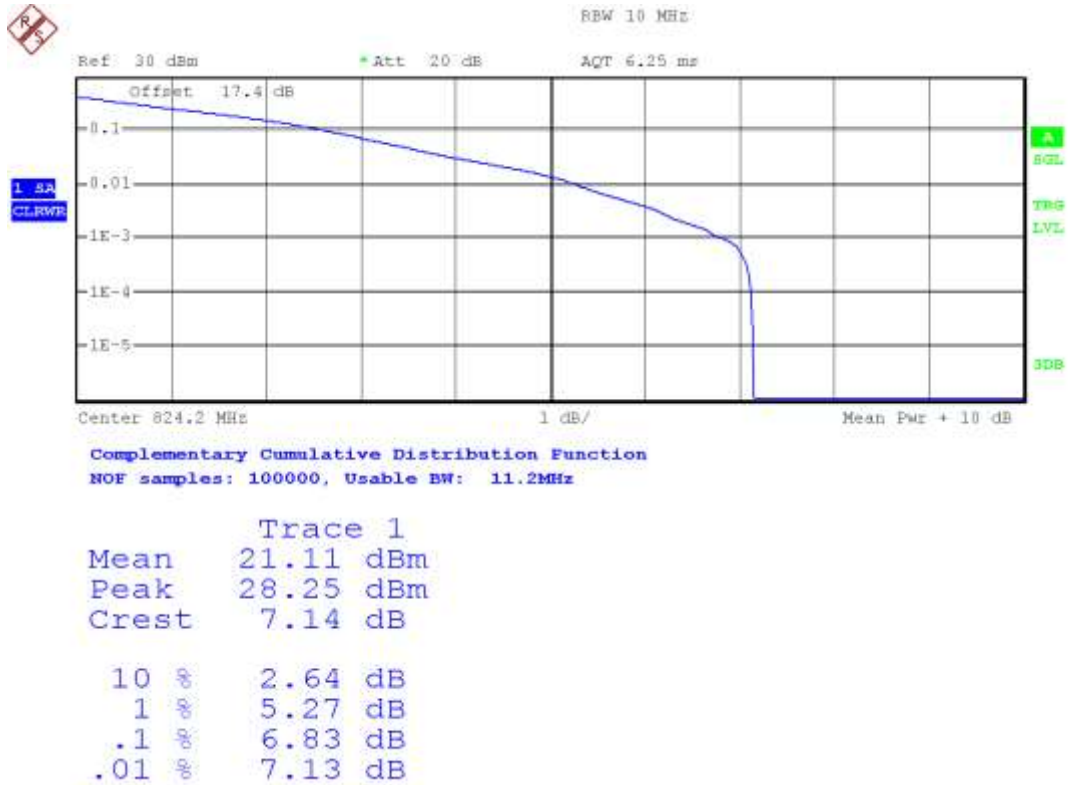

Channel Middle:

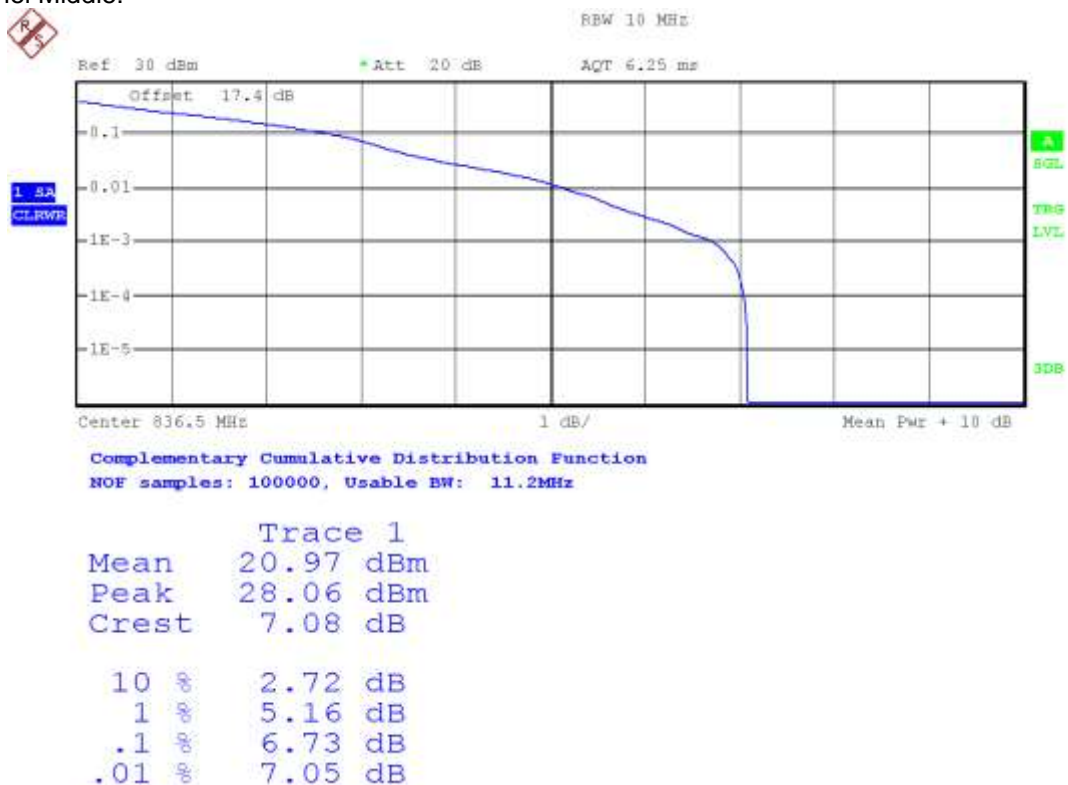

Channel High:



Trace 1	
Mean	20.86 dBm
Peak	28.08 dBm
Crest	7.22 dB
10 %	2.68 dB
1 %	5.32 dB
.1 %	6.75 dB
.01 %	7.18 dB

Frequency Stability

SPECIFICATION:

FCC §2.1055 and §22.355. ± 2.5 ppm for mobile stations operating in the range 821 to 896 MHz.

RSS-132. Clause 5.3. The carrier frequency shall not depart from the reference frequency in excess of ± 2.5 ppm for mobile stations.

METHOD:

The frequency tolerance measurements over temperature variations were made over the temperature range of -30°C to $+50^{\circ}\text{C}$. The EUT was placed inside a climatic chamber and the temperature was raised hourly in 10°C steps from -30°C up to $+50^{\circ}\text{C}$.

The supply voltage was varied between 85% and 115% of nominal voltage.

The EUT was set in "Radio Resource Control (RRC) mode" in the middle channel using the Universal Radio Communication tester R&S CMW500 and the maximum frequency error was measured using the built-in calibrated frequency meter.

The worst case LTE mode for conducted power was used for the test.

In order to check that the frequency stability is sufficient such that the fundamental emissions stay within the authorized bands of operation, a reference point is established at the applicable unwanted emissions limit using a RBW equal to the RBW required by the unwanted emissions specification of the applicable regulatory standard. These reference points measured using the lowest and highest channel of operation are identified as fL and fH respectively. The worst-case frequency offset determined in the above methods is added or subtracted from the values of fL and fH to check that the resulting frequencies remain within the band.

The reference point measurements were made at the RF output terminals of the EUT using an attenuator, power splitter and spectrum analyser. The EUT was controlled via the Universal Radio Communication tester R&S CMW500 selecting maximum transmission power of the EUT and different modes of modulation.

TEST SETUP:

1. Frequency Tolerance:

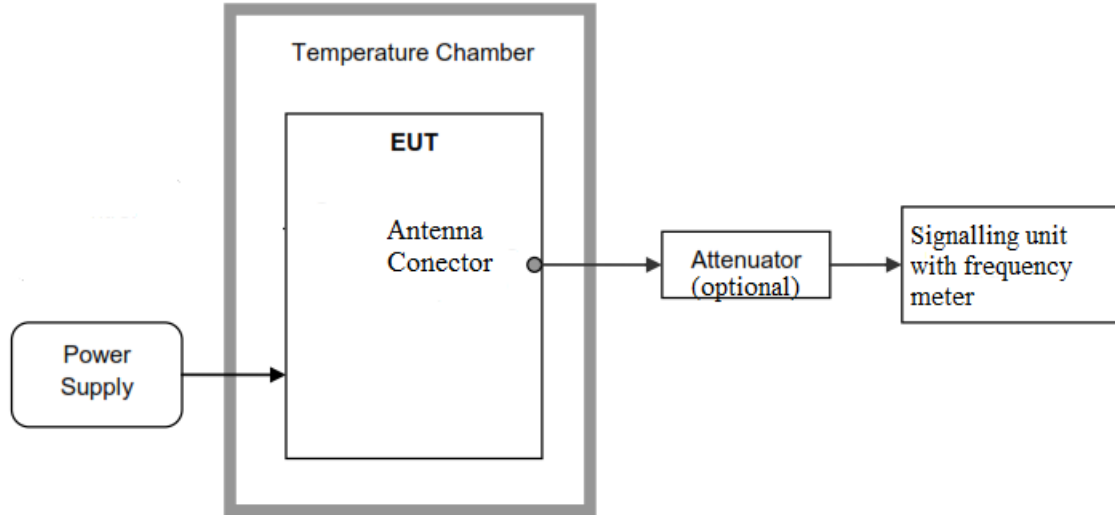

2. Reference Frequency Points f_L and f_H :

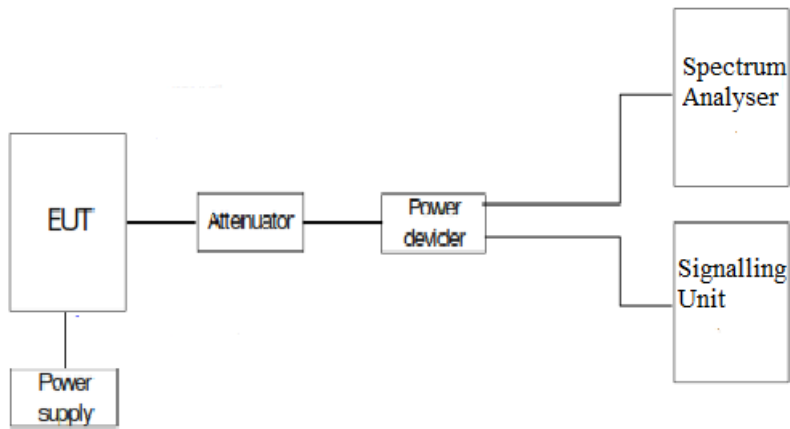

RESULTS:

Frequency stability over temperature variations.

2G Band 850 MHz. GPRS and EDGE MODULATIONS.

Nominal Frequency: 836.6 MHz

Temperature (°C)	Frequency Error (Hz)	Frequency Error (ppm)
+50	-4.94	-0.005904853
+40	1.87	0.002235238
+30	5.73	0.006849151
+20	9.52	0.011379393
+10	6.17	0.007375090
0	1.10	0.001314846
-10	6.41	0.007661965
-20	23.16	0.027683481
-30	-9.95	0.011893378

NBLoT Band 26. $\pi/4$ - QPSK modulation. 1 tone 3.75 kHz. Channel: 819 MHz.

Temperature (°C)	Frequency Error (Hz)	Frequency Error (ppm)
+50	-2.84	-0.003467643
+40	-2.1	-0.002564103
+30	-3.37	-0.004114774
+20	-5.79	-0.007069597
+10	-5.83	-0.007118437
0	9.34	0.011404151
-10	7.22	0.008815629
-20	-0.57	-0.000695971
-30	6.11	0.007460317

Measurement uncertainty (Hz)	<±100
------------------------------	-------

NBLoT Band 5. $\pi/4$ - QPSK modulation. 1 tone 3.75 kHz. Channel: 836.5 MHz.

Temperature (°C)	Frequency Error (Hz)	Frequency Error (ppm)
+50	-2.42	-0.002893007
+40	-1.12	-0.001338912
+30	2.24	0.002677824
+20	2.58	0.00308428
+10	-4.12	-0.004925284
0	7.32	0.008750747
-10	-6.74	-0.008057382
-20	4.66	0.005570831
-30	9.57	0.011440526

Measurement uncertainty (Hz)	< \pm 102
------------------------------	-------------

Frequency stability over voltage variations.

2G Band 850 MHz. GPRS and EDGE MODULATIONS.

Battery Supply voltage	Voltage (V)	Frequency Error (Hz)	Frequency Error (ppm)
Vmax	4.2	-1.32	-0.001577815
Vmin	3.2	27.63	0.033026536

NBLoT Band 26

Battery Supply voltage	Voltage (V)	Frequency Error (Hz)	Frequency Error (ppm)
Vmax	4.2	5.68	0.006935287
Vmin	3.2	7.78	0.009499389

NBLoT Band 5

Battery Supply voltage	Voltage (V)	Frequency Error (Hz)	Frequency Error (ppm)
Vmax	4.2	-7.27	-0.008690974
Vmin	3.2	-3.59	-0.004291692

Points established at the applicable unwanted emissions limit (worst case):

2G Band 850 MHz:

	GPRS MODULATION
<i>f_L</i> (MHz)	824.03099005
<i>f_H</i> (MHz)	848.96702316

NBLoT Band 26:

Not Applicable.

NBLoT Band 5

<i>f_L</i> (MHz)	824,064322550
<i>f_H</i> (MHz)	848,905679950

The reference frequency points *f_L* and *f_H* stay within the authorized blocks for all the bands above.

2G Band 850 MHz:

	GPRS MODULATION
<i>f_L</i> (MHz)	824.0310
<i>f_H</i> (MHz)	848.9670

NBLoT Band 26:

Not Applicable.

NBLoT Band 5

<i>f_L</i> (MHz)	824.0643
<i>f_H</i> (MHz)	848.9057

Verdict: PASS

Modulation Characteristics

SPECIFICATION

FCC §2.1047.

RSS-132. Clause 5.2: Equipment certified under this standard shall use digital modulation.

METHOD

For NB-IoT the EUT operates with $\pi/2$ - BPSK and $\pi/4$ - QPSK modulation modes in which the information is digitised and coded into a bit stream.

TEST SETUP

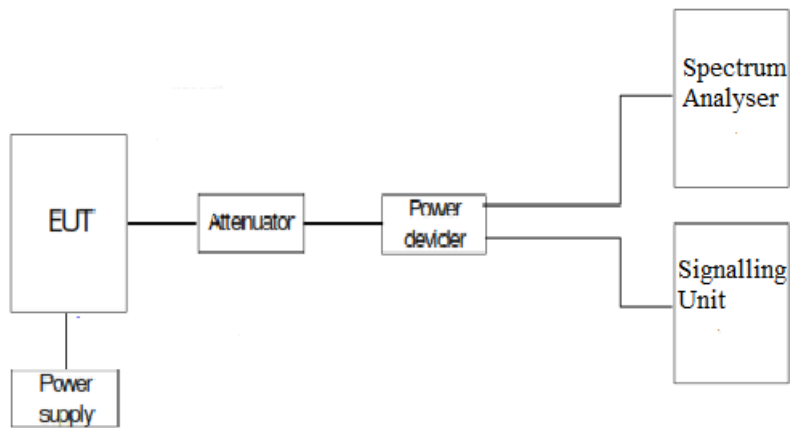

RESULTS

The following plot shows the modulation schemes in the EUT.

2G Band 850 MHz. GPRS MODULATION.

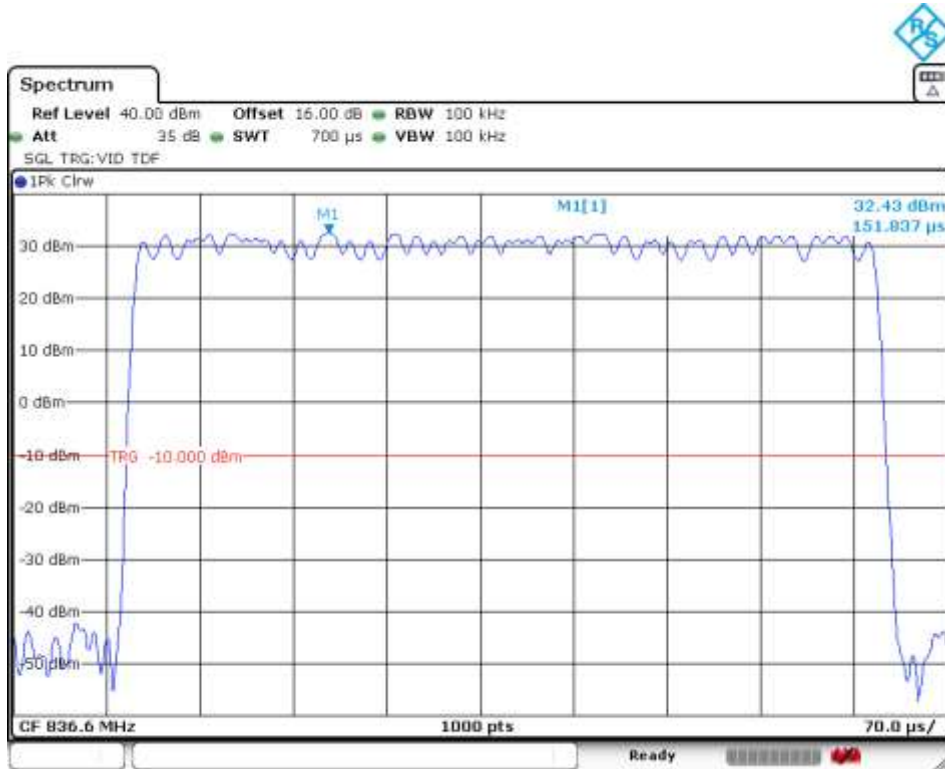

2G Band 850 MHz. EDGE MODULATION.

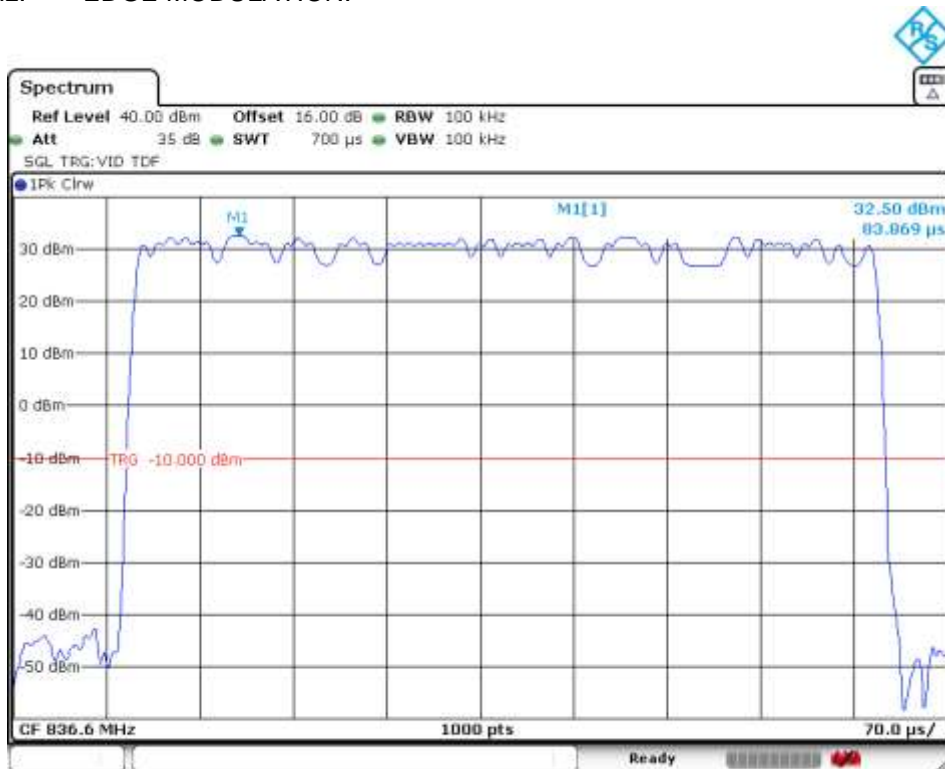

NB-IoT MODULATION (Band 26). $\pi/2$ - BPSK.

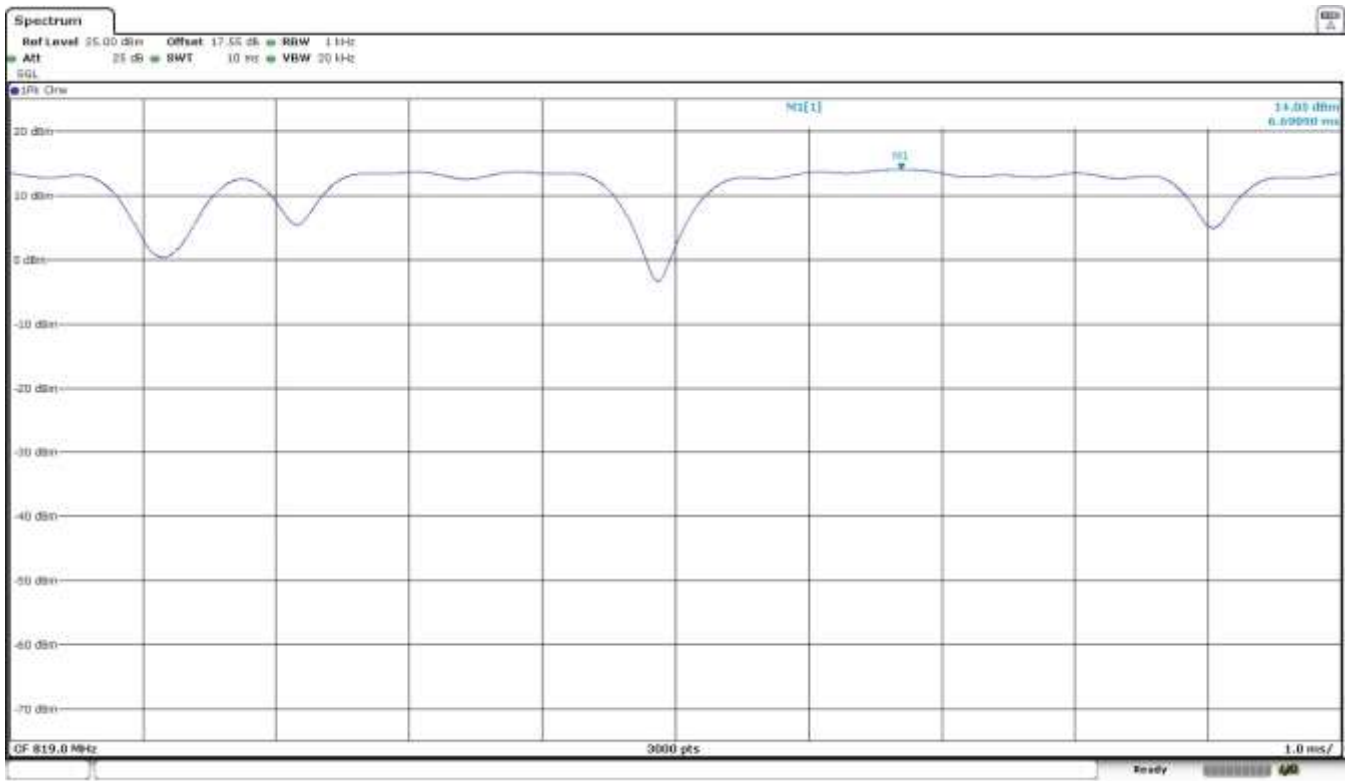

NB-IoT MODULATION (Band 26). $\pi/4$ - QPSK.

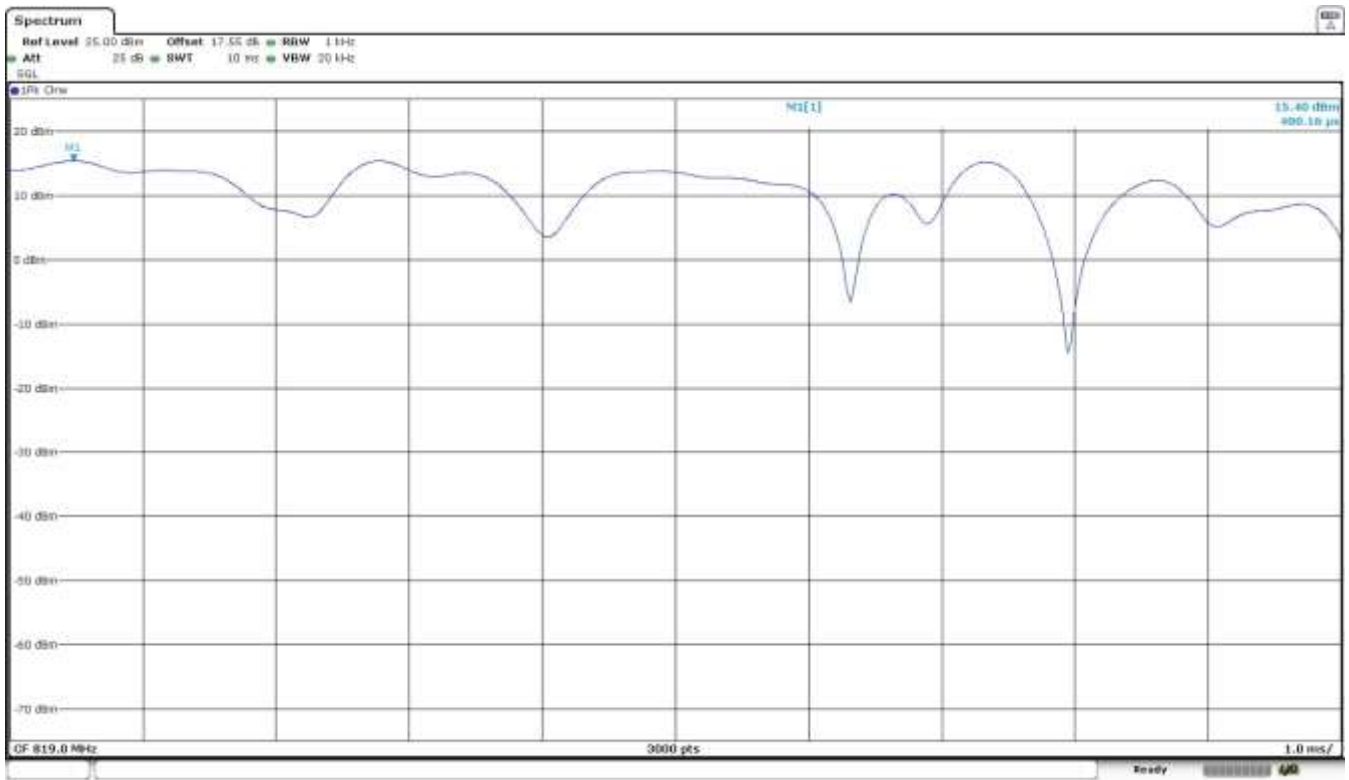

NB-IoT MODULATION (Band 5). $\pi/2$ - BPSK.

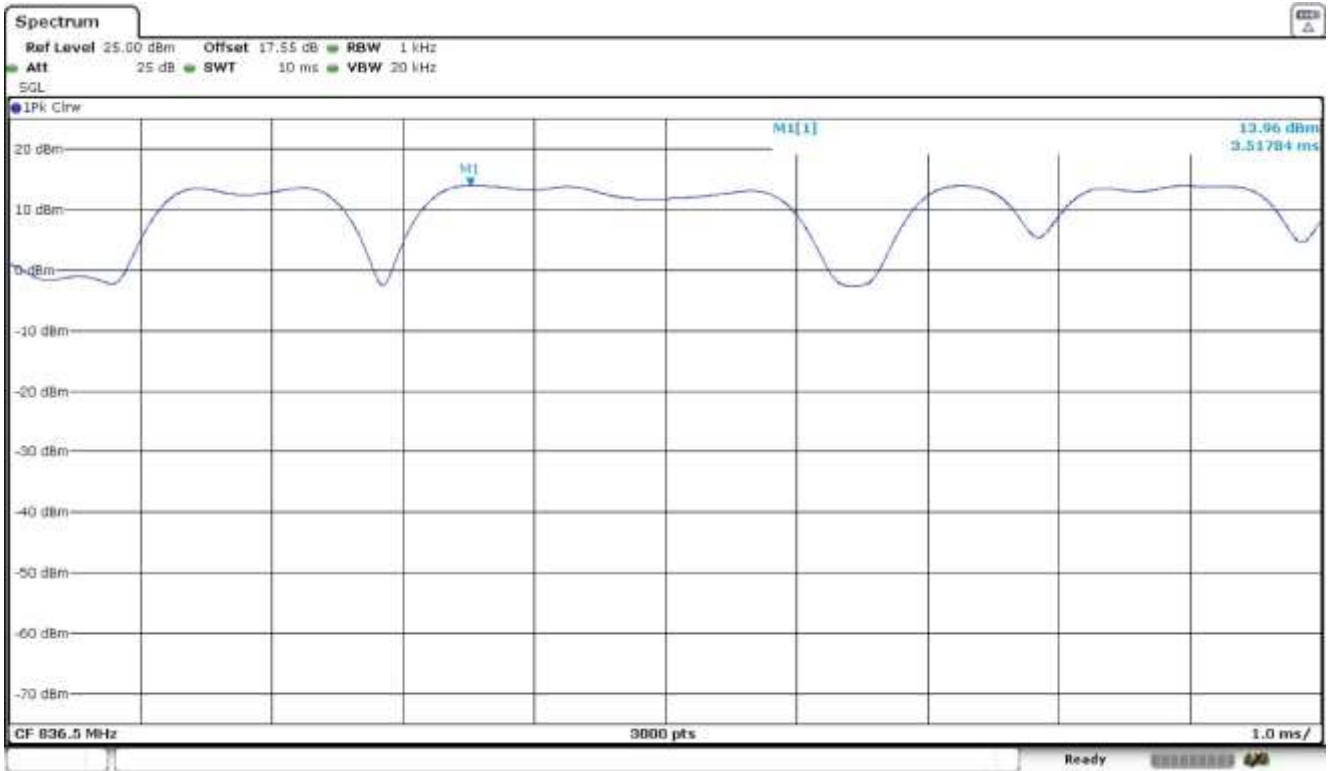

NB-IoT MODULATION (Band 5). $\pi/4$ - QPSK.

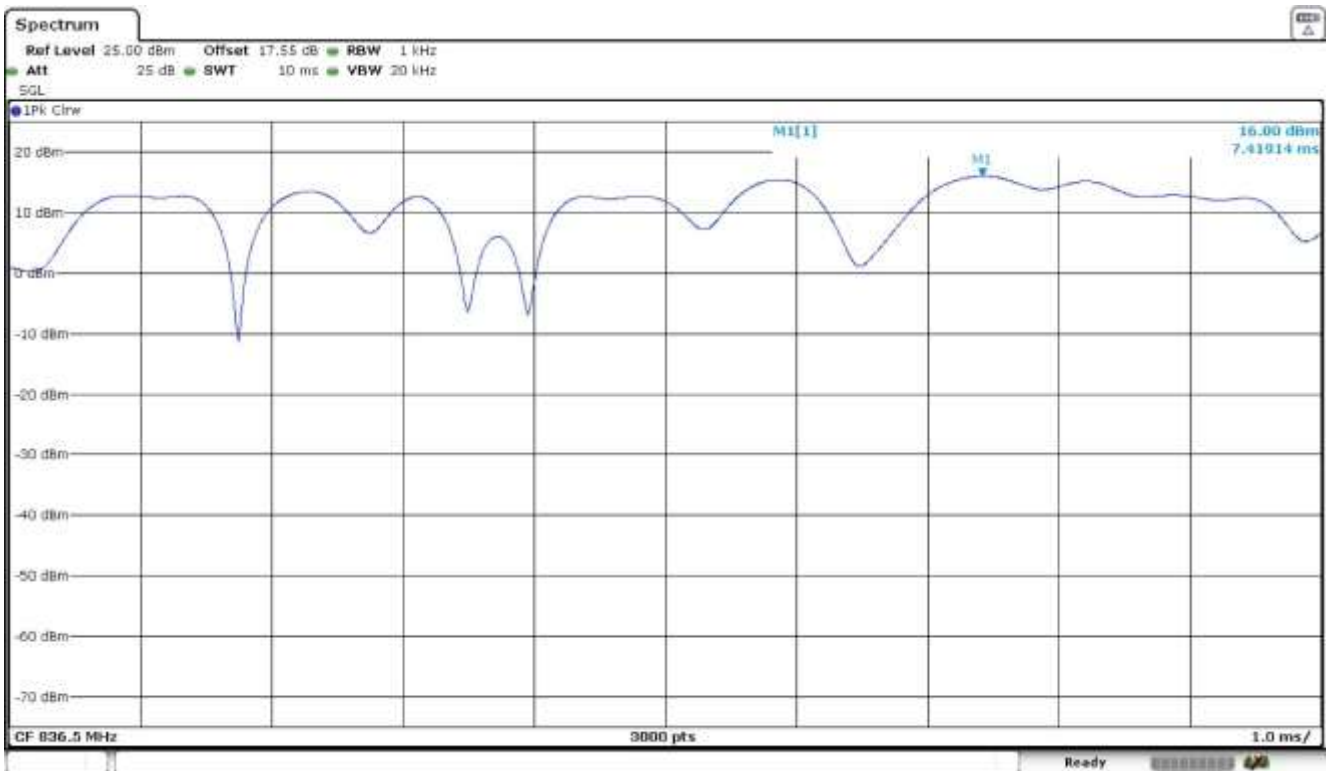

Occupied Bandwidth

SPECIFICATION

§2.1049

METHOD

The occupied bandwidth measurement was performed at the output terminals of the EUT using an attenuator, power splitter and spectrum analyser. The EUT was controlled via the Universal Radio Communication tester R&S CMW500 selecting maximum transmission power of the EUT and different modes of modulation. The 99% occupied bandwidth and the -26 dBc bandwidth were measured directly using the built-in bandwidth measuring option of spectrum analyser.

TEST SETUP

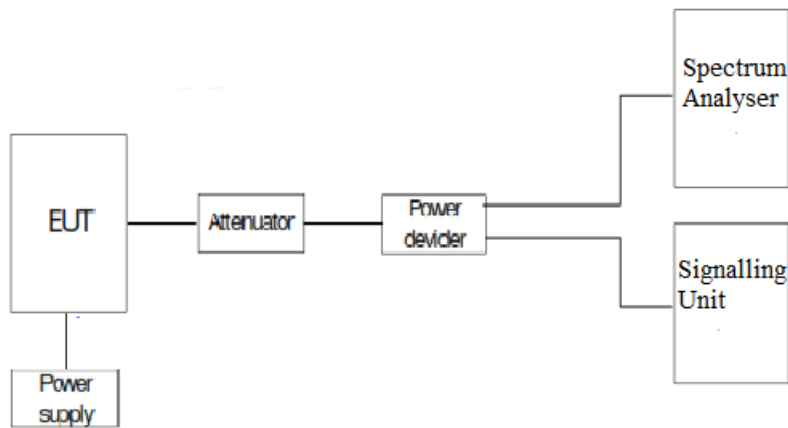

RESULTS (see next plots)

2G Band 850 MHz:

GPRS MODULATION:

	Lowest Channel	Middle Channel	Highest Channel
99% Occupied bandwidth (kHz)	238.00	237.00	237.00
-26 dBc bandwidth (kHz)	306.00	306.00	306.00
Measurement uncertainty (kHz)	<±1.20		

EDGE MODULATION:

	Lowest Channel	Middle Channel	Highest Channel
99% Occupied bandwidth (kHz)	237.00	237.00	237.00
-26 dBc bandwidth (kHz)	293.00	293.00	292.00
Measurement uncertainty (kHz)	<±1.20		

NBLoT BAND 26.

Tone 3.75 kHz. $\pi/2$ - BPSK MODULATION

Channel	Lowest	Middle	Highest
99% Occupied bandwidth (kHz)	37.33	37.36	37.63
-26 dBc bandwidth (kHz)	34.90	34.90	34.90
Measurement uncertainty (kHz)	< \pm 0.13		

Tone 3.75 kHz. $\pi/4$ - QPSK MODULATION

Channel	Lowest	Middle	Highest
99% Occupied bandwidth (kHz)	37.40	37.26	37.43
-26 dBc bandwidth (kHz)	36.93	37.00	37.50
Measurement uncertainty (kHz)	< \pm 0.13		

Tone 15 kHz. $\pi/2$ - BPSK MODULATION

Channel	Lowest	Middle	Highest
99% Occupied bandwidth (kHz)	72.86	73.00	73.13
-26 dBc bandwidth (kHz)	92.33	92.33	92.40
Measurement uncertainty (kHz)	< \pm 0.27		

12 Tones 15 kHz. $\pi/4$ - QPSK MODULATION

Channel	Lowest	Middle	Highest
99% Occupied bandwidth (kHz)	192.13	192.13	192.13
-26 dBc bandwidth (kHz)	276.40	276.80	276.40
Measurement uncertainty (kHz)	< \pm 0.65		

NBLoT BAND 26. (824MHz)

Tone 3.75 kHz. $\pi/2$ - BPSK MODULATION

99% Occupied bandwidth (kHz)	37.50
-26 dBc bandwidth (kHz)	34.86
Measurement uncertainty (kHz)	< \pm 0.13

Tone 3.75 kHz. $\pi/4$ - QPSK MODULATION

99% Occupied bandwidth (kHz)	37.63
-26 dBc bandwidth (kHz)	37.50
Measurement uncertainty (kHz)	< \pm 0.13

Tone 15 kHz. $\pi/2$ - BPSK MODULATION

99% Occupied bandwidth (kHz)	73.13
-26 dBc bandwidth (kHz)	92.40
Measurement uncertainty (kHz)	< \pm 0.27

12 Tones 15 kHz. $\pi/4$ - QPSK MODULATION

99% Occupied bandwidth (kHz)	192.40
-26 dBc bandwidth (kHz)	276.40
Measurement uncertainty (kHz)	< \pm 0.65

NB-IoT BAND 5.

Tone 3.75 kHz. $\pi/2$ - BPSK MODULATION

Channel	Lowest	Middle	Highest
99% Occupied bandwidth (kHz)	37.43	37.53	37.60
-26 dBc bandwidth (kHz)	34.83	34.20	34.81
Measurement uncertainty (kHz)	< \pm 0.13		

Tone 3.75 kHz. $\pi/4$ - QPSK MODULATION

Channel	Lowest	Middle	Highest
99% Occupied bandwidth (kHz)	37.76	37.73	37.63
-26 dBc bandwidth (kHz)	37.03	36.96	37.01
Measurement uncertainty (kHz)	< \pm 0.13		

Tone 15 kHz. $\pi/2$ - BPSK MODULATION

Channel	Lowest	Middle	Highest
99% Occupied bandwidth (kHz)	73.20	73.13	73.13
-26 dBc bandwidth (kHz)	92.40	92.33	92.21
Measurement uncertainty (kHz)	< \pm 0.27		

12 Tones 15 kHz. $\pi/4$ - QPSK MODULATION

Channel	Lowest	Middle	Highest
99% Occupied bandwidth (kHz)	192.53	192.40	192.66
-26 dBc bandwidth (kHz)	276.00	277.33	277.20
Measurement uncertainty (kHz)	< \pm 0.65		

2G Band 850 MHz. GPRS MODULATION.

Low Channel:



Middle Channel:



High Channel:



2G Band 850 MHz. EDGE MODULATION.

Low Channel:



Middle Channel:



High Channel:

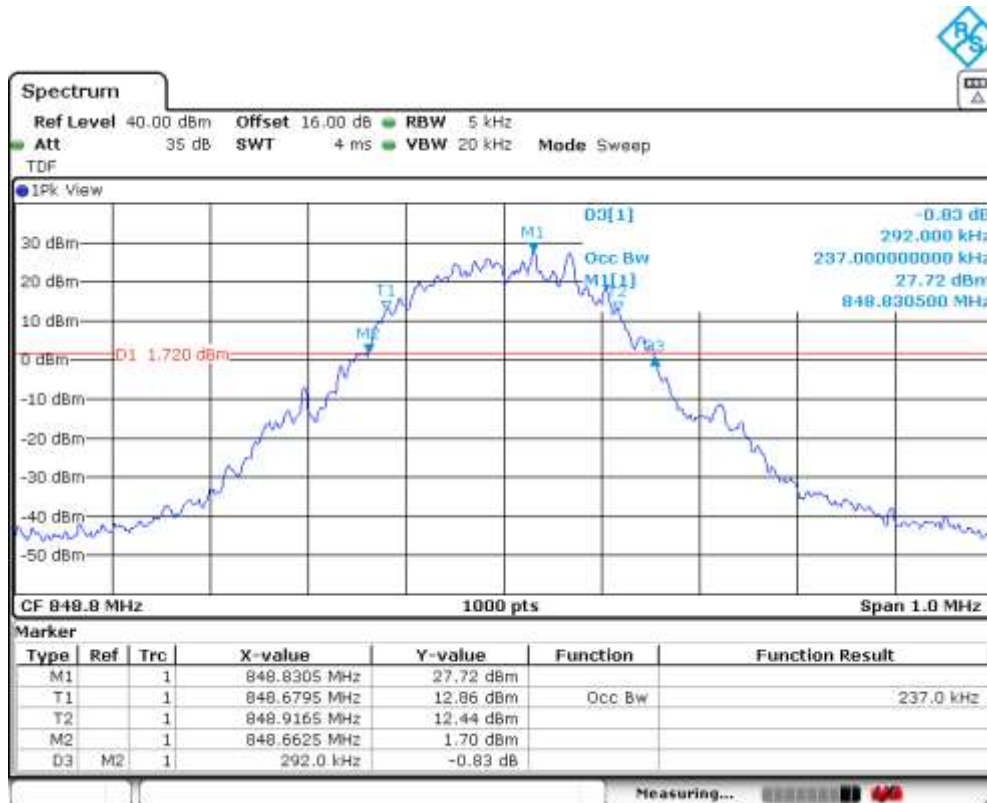

NB IoT BAND 26.

Tone 3.75 kHz. $\pi/2$ - BPSK MODULATION

Lowest Channel

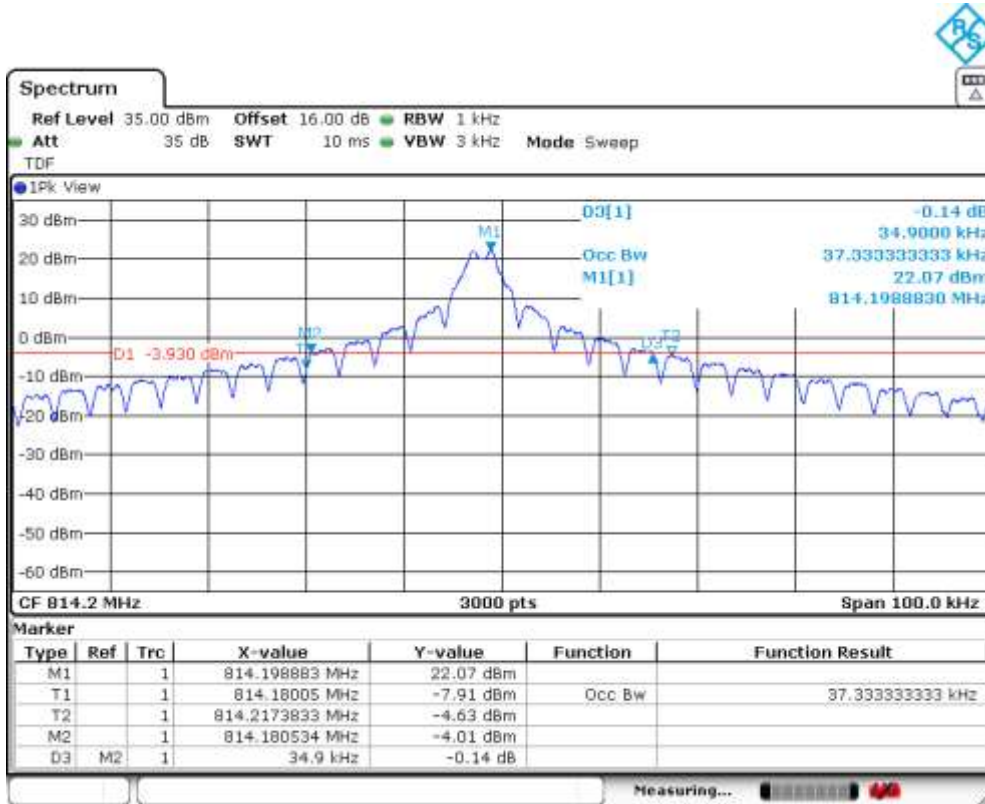

Middle Channel

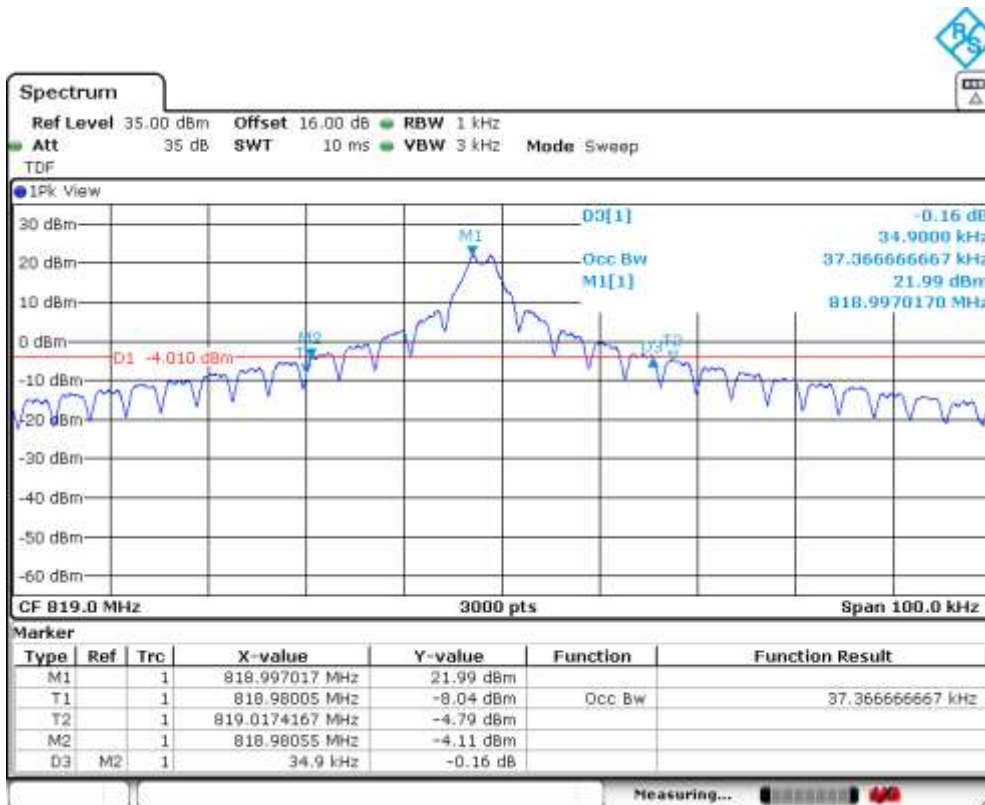

Highest Channel

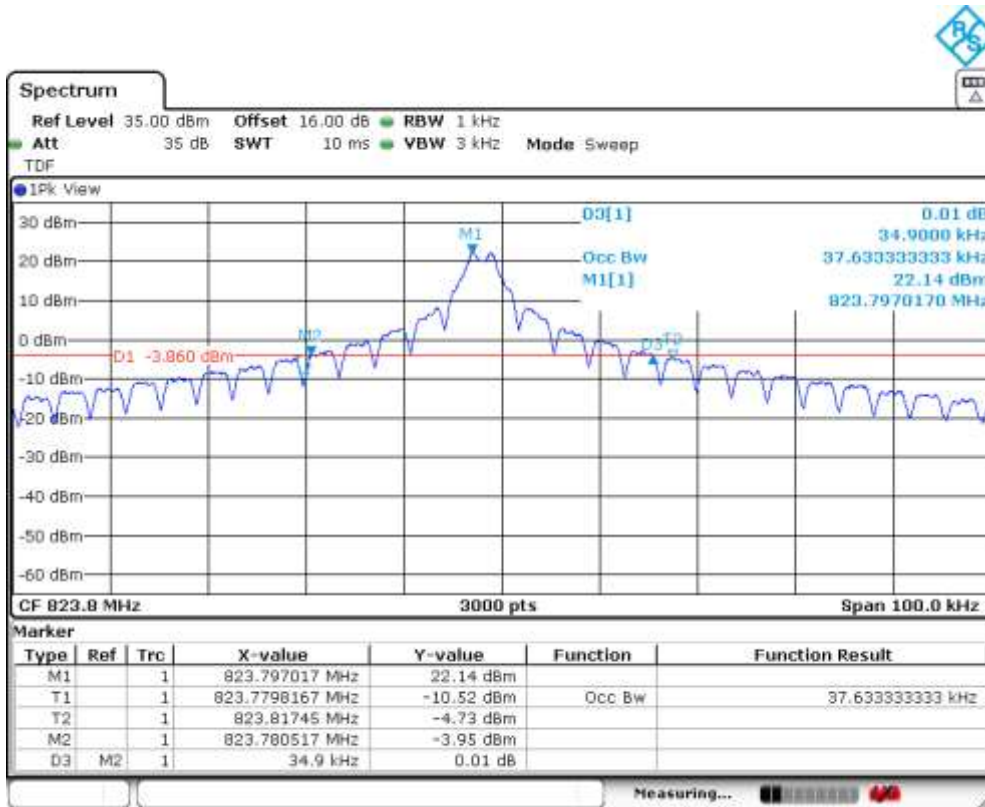

Tone 3.75 kHz. $\pi/4$ - QPSK MODULATION

Lowest Channel

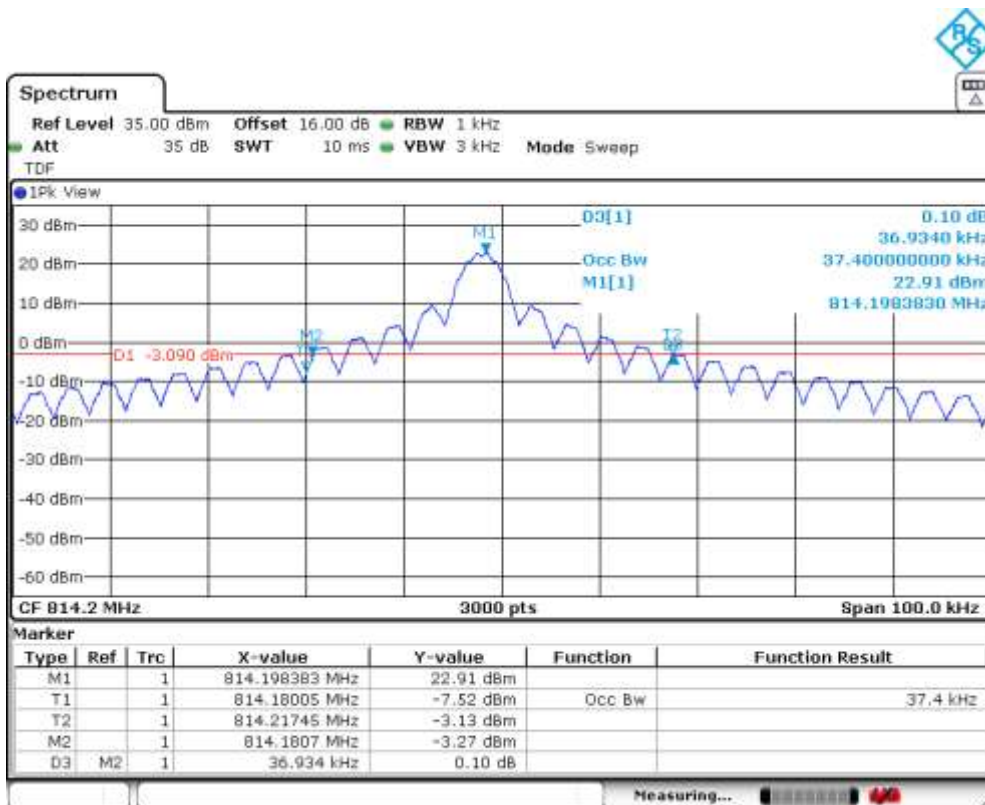

Middle Channel

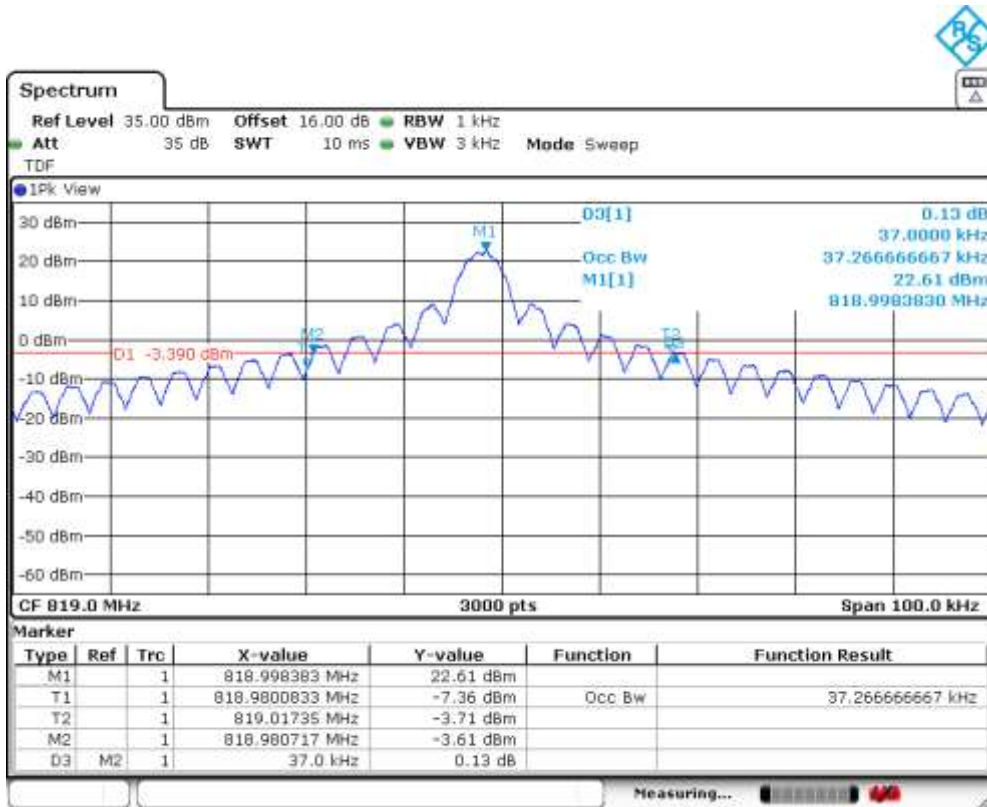

Highest Channel

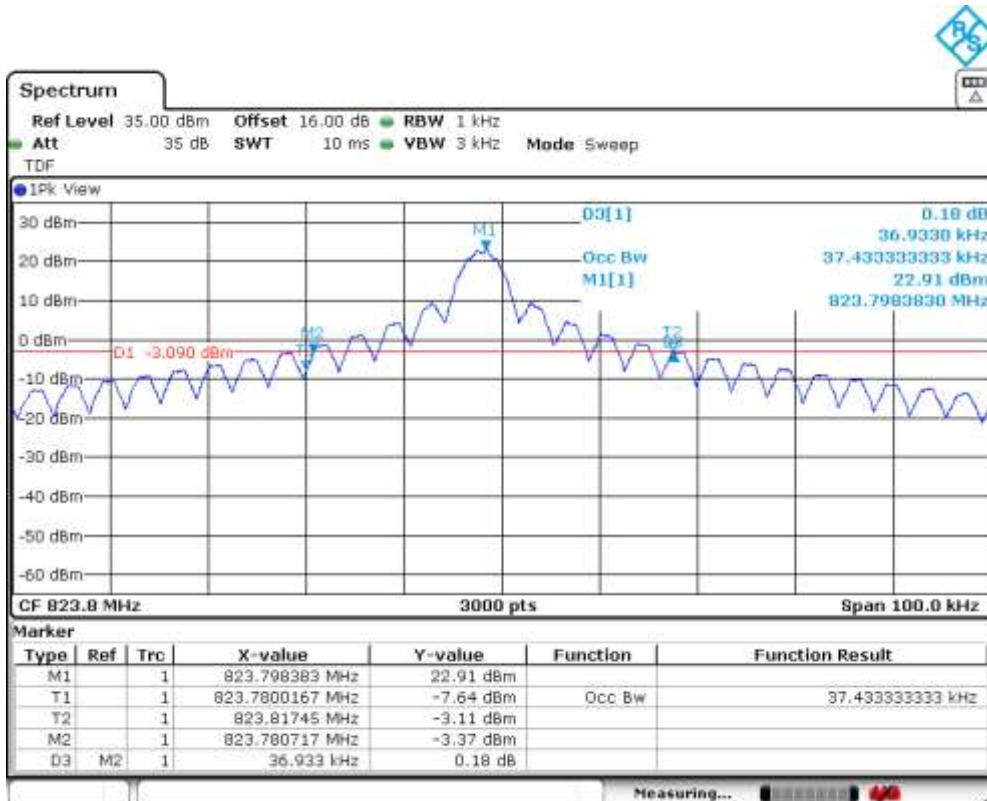

Tone 15 kHz. $\pi/2$ - BPSK MODULATION
 Lowest Channel

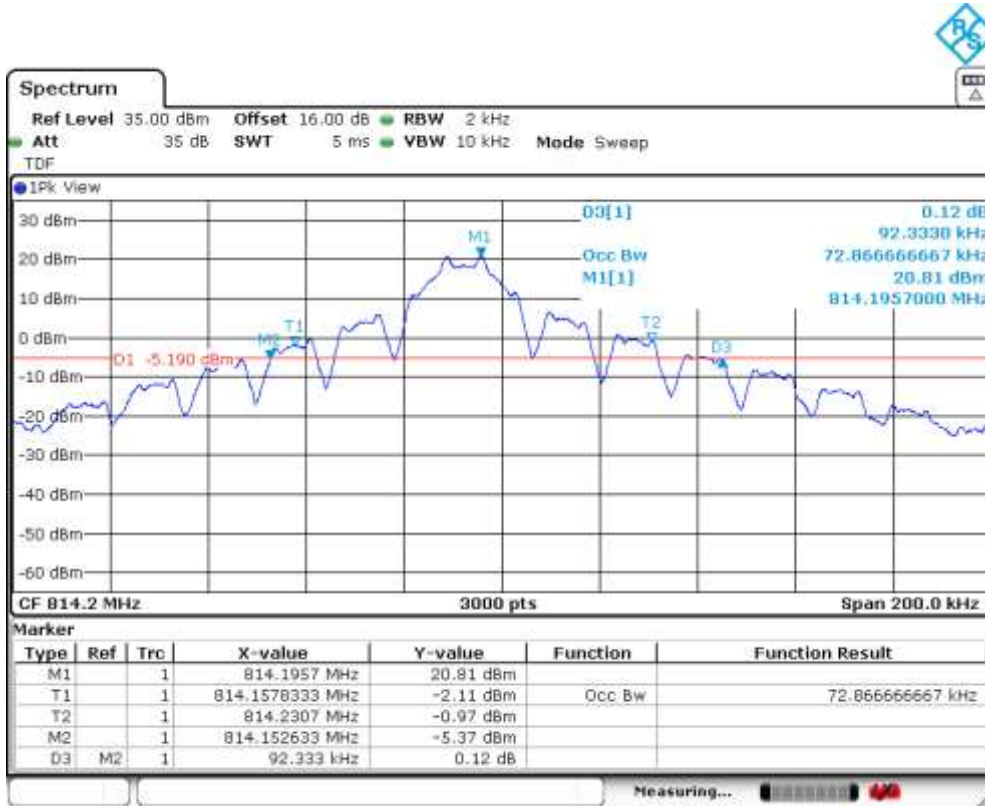

Middle Channel

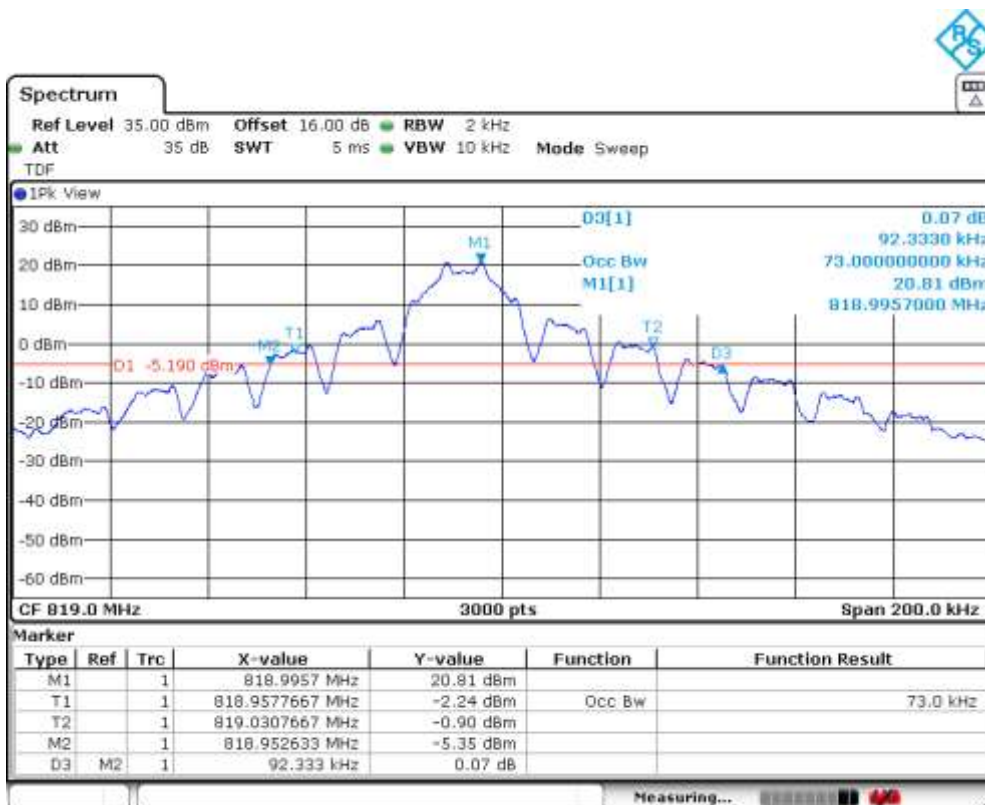

Highest Channel

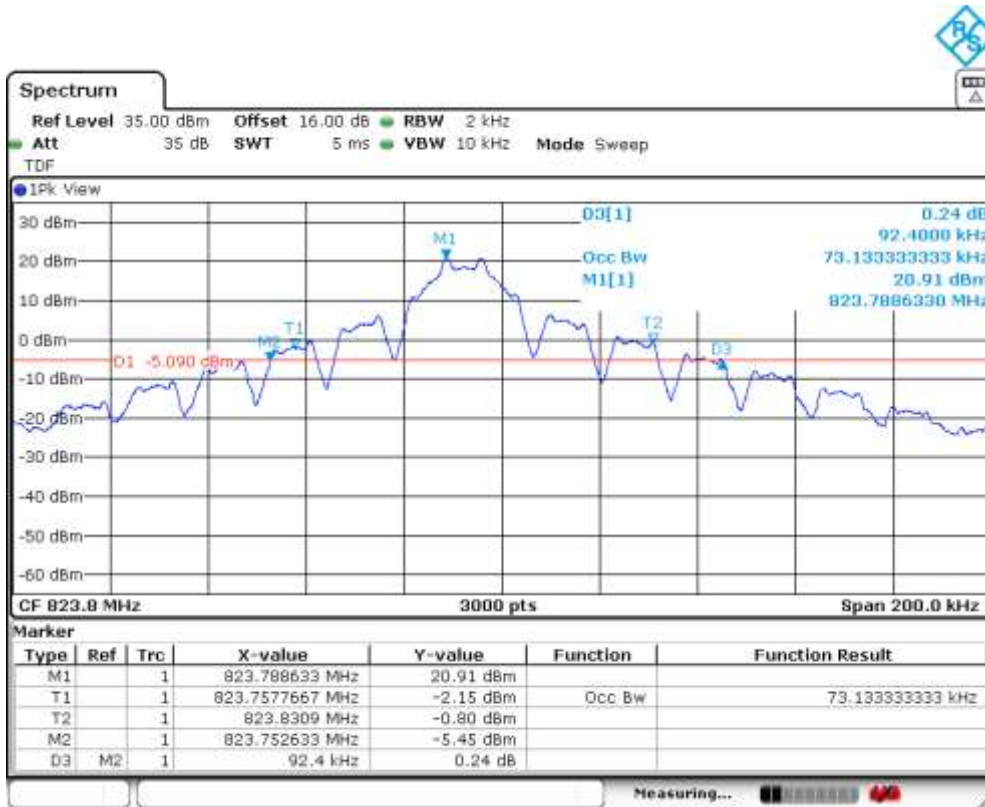

12 Tones 15 kHz. $\pi/4$ - QPSK MODULATION

Lowest Channel



Middle Channel

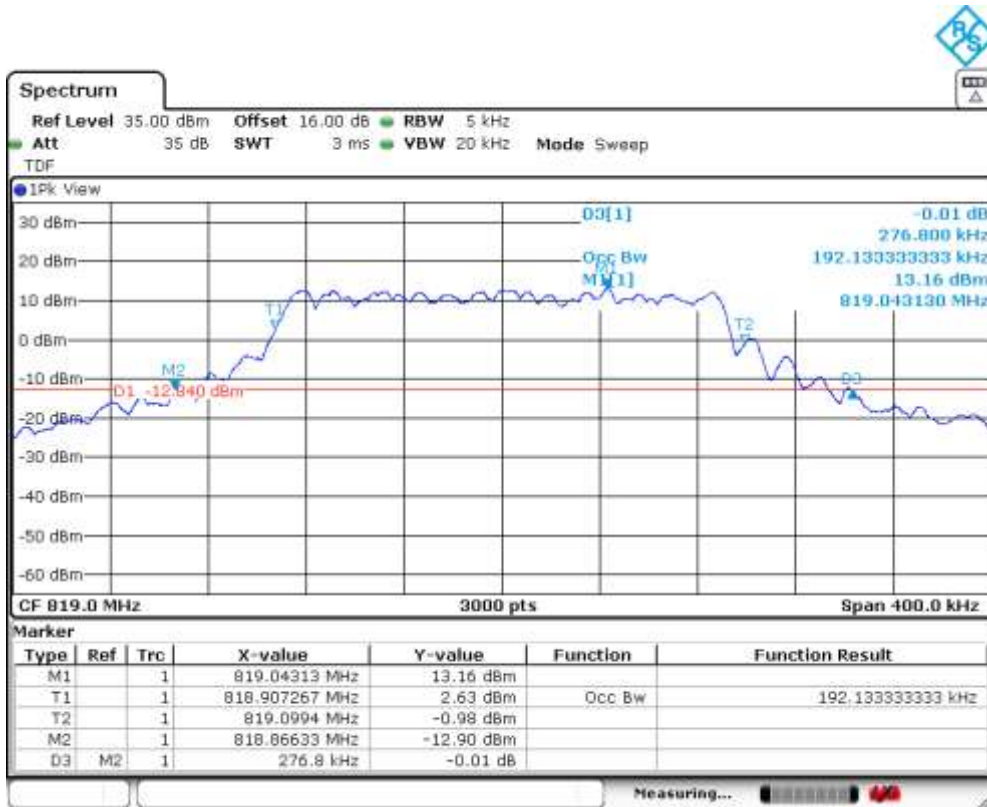

Highest Channel

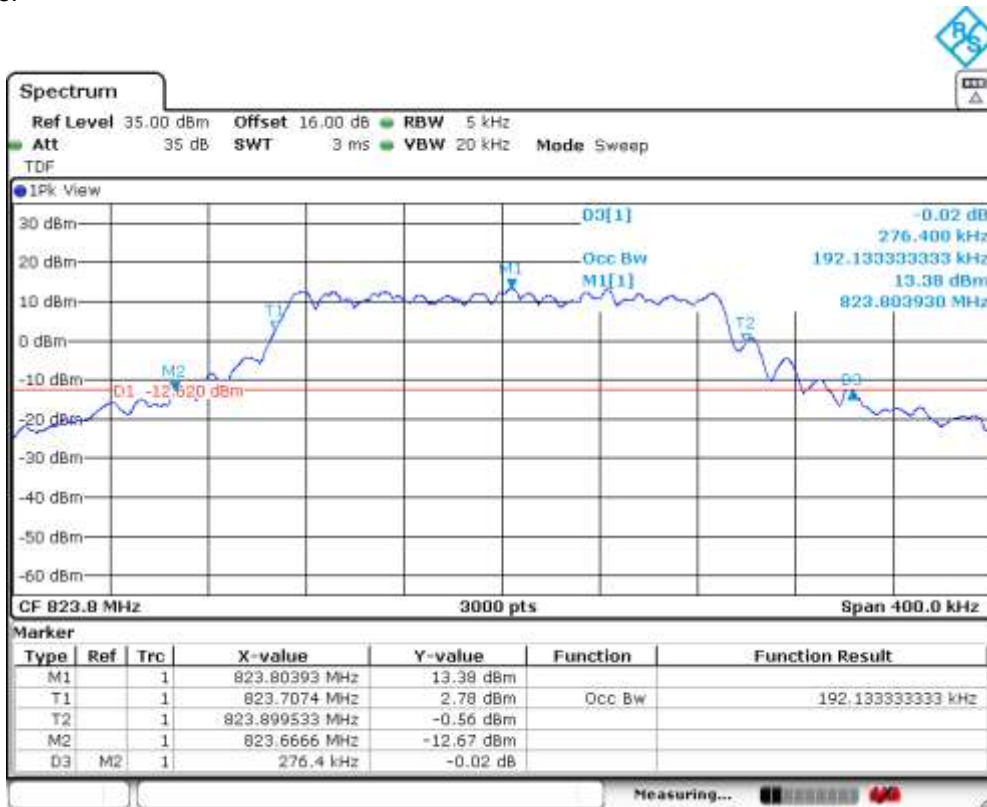

NB IoT BAND 26.
NB IoT BAND 26 (824MHz).

Tone 3.75 kHz. $\pi/2$ - BPSK MODULATION

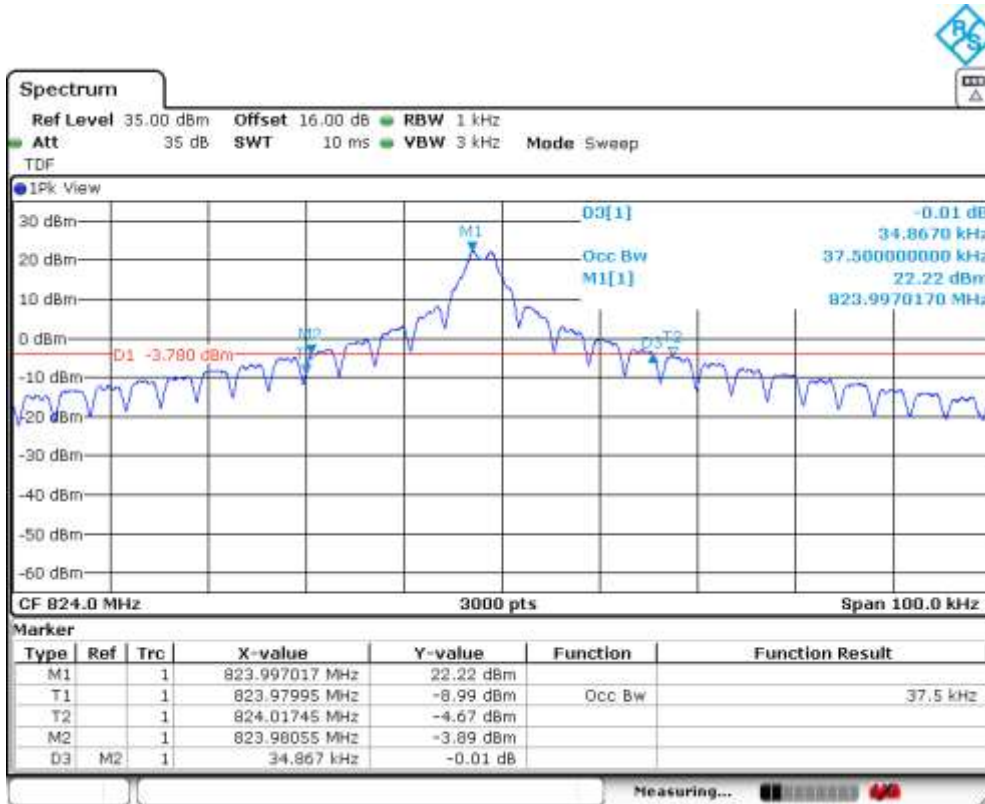

Tone 3.75 kHz. $\pi/4$ - QPSK MODULATION

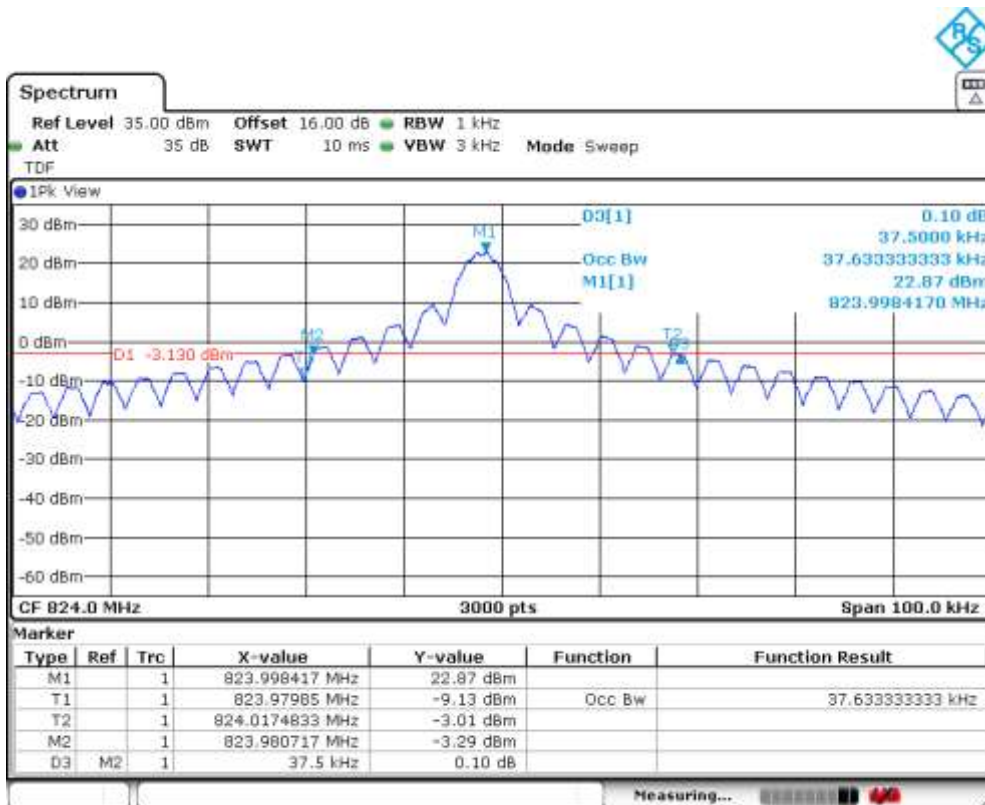

Tone 15 kHz. $\pi/2$ - BPSK MODULATION



12 Tones 15 kHz. $\pi/4$ - QPSK MODULATION



NB-IoT BAND 5.

Tone 3.75 kHz. $\pi/2$ - BPSK MODULATION

Lowest Channel

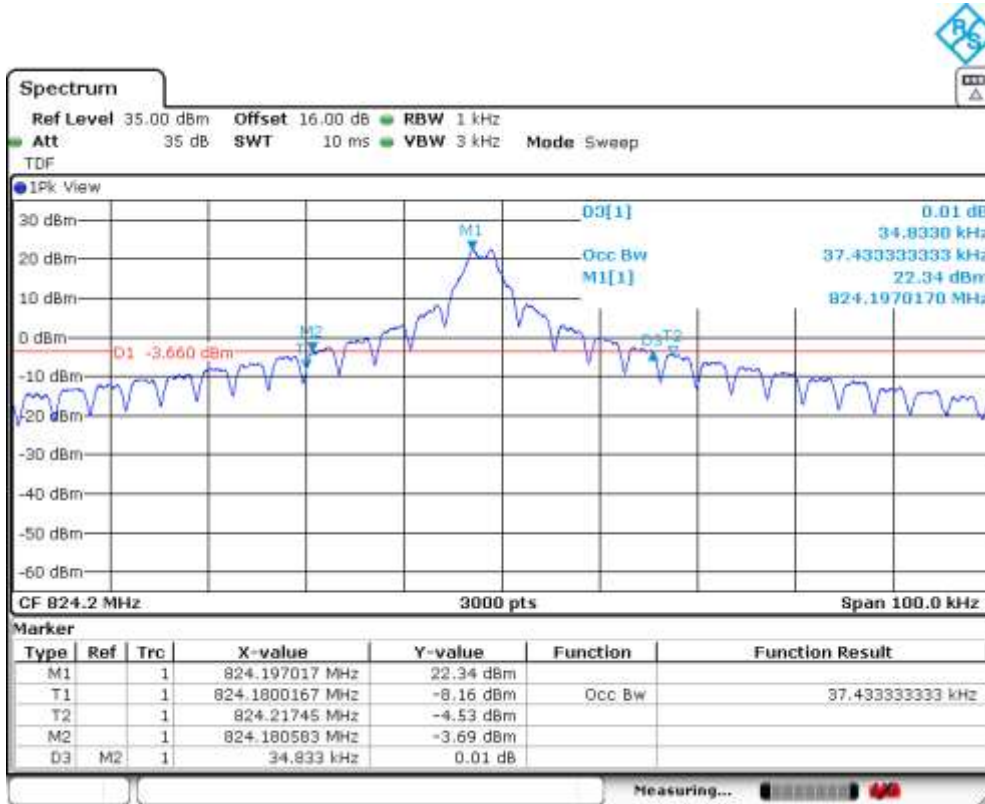

Middle Channel

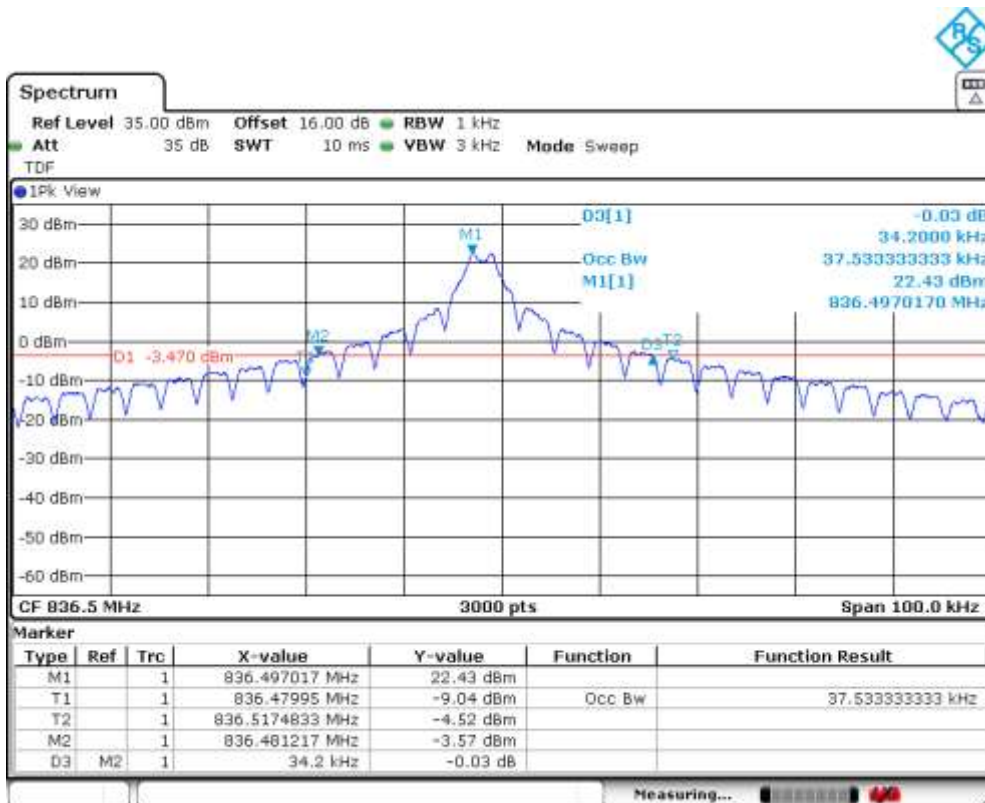

Highest Channel

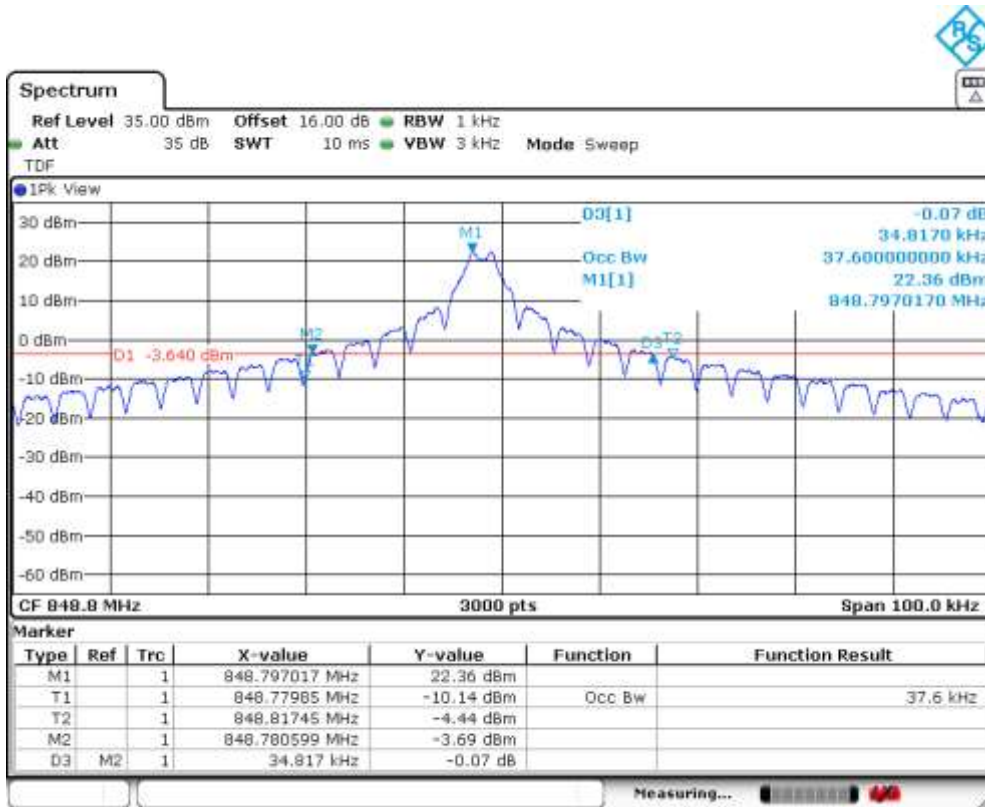

Tone 3.75 kHz. $\pi/4$ - QPSK MODULATION

Lowest Channel

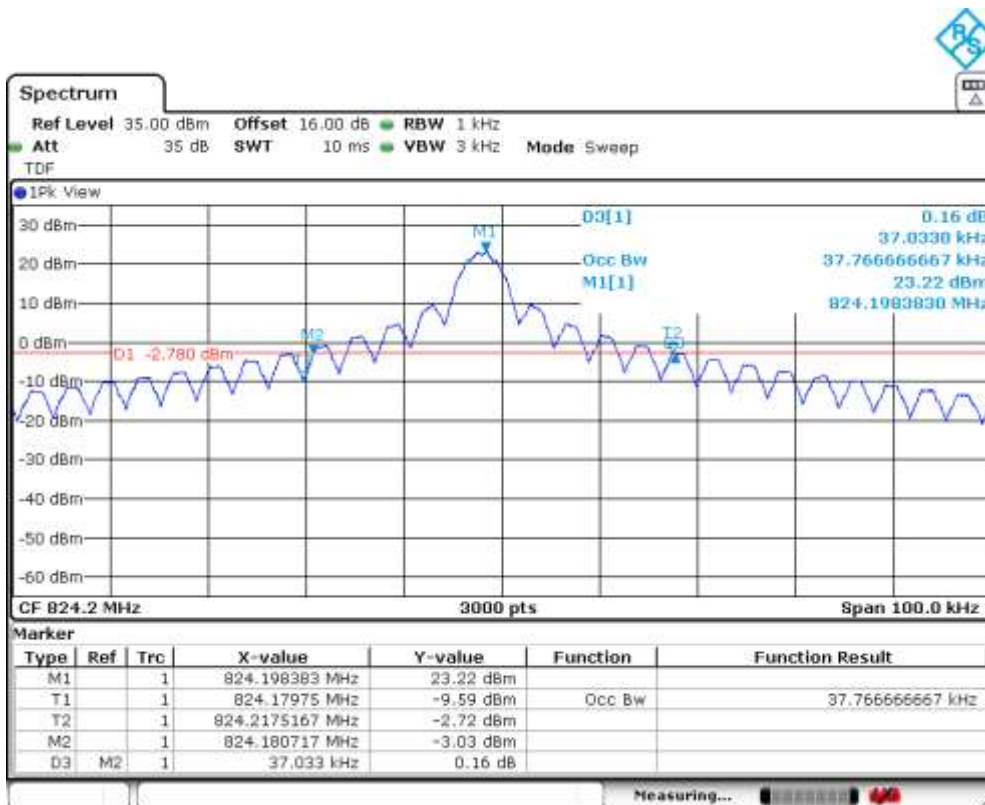

Middle Channel

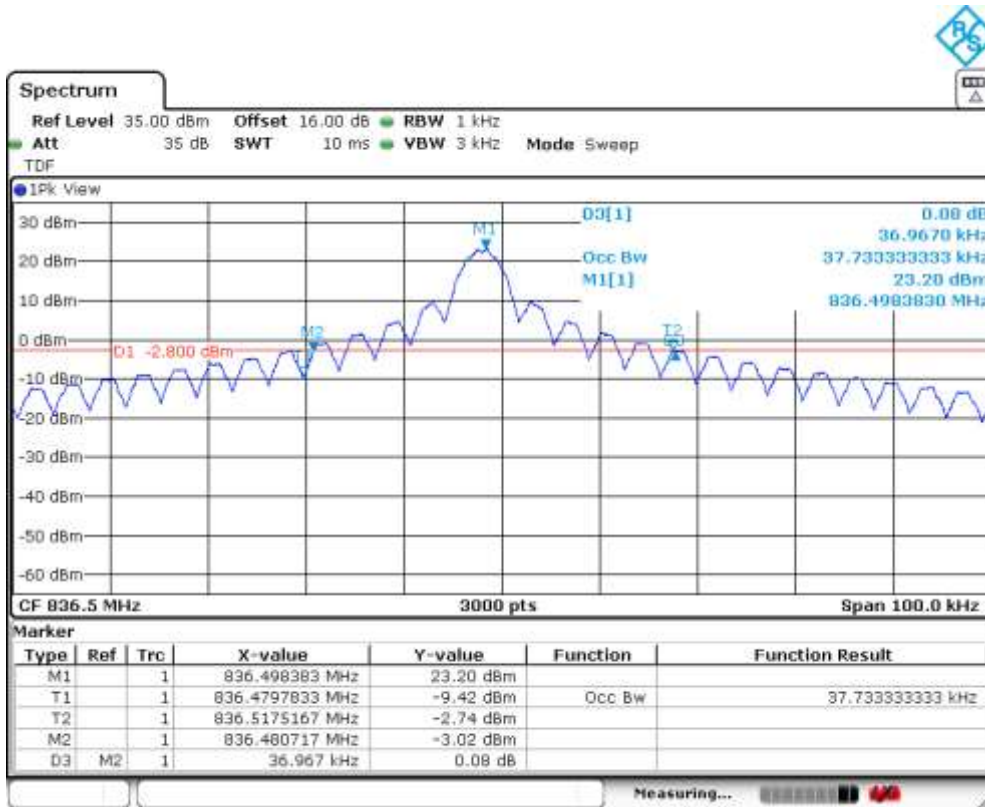

Highest Channel

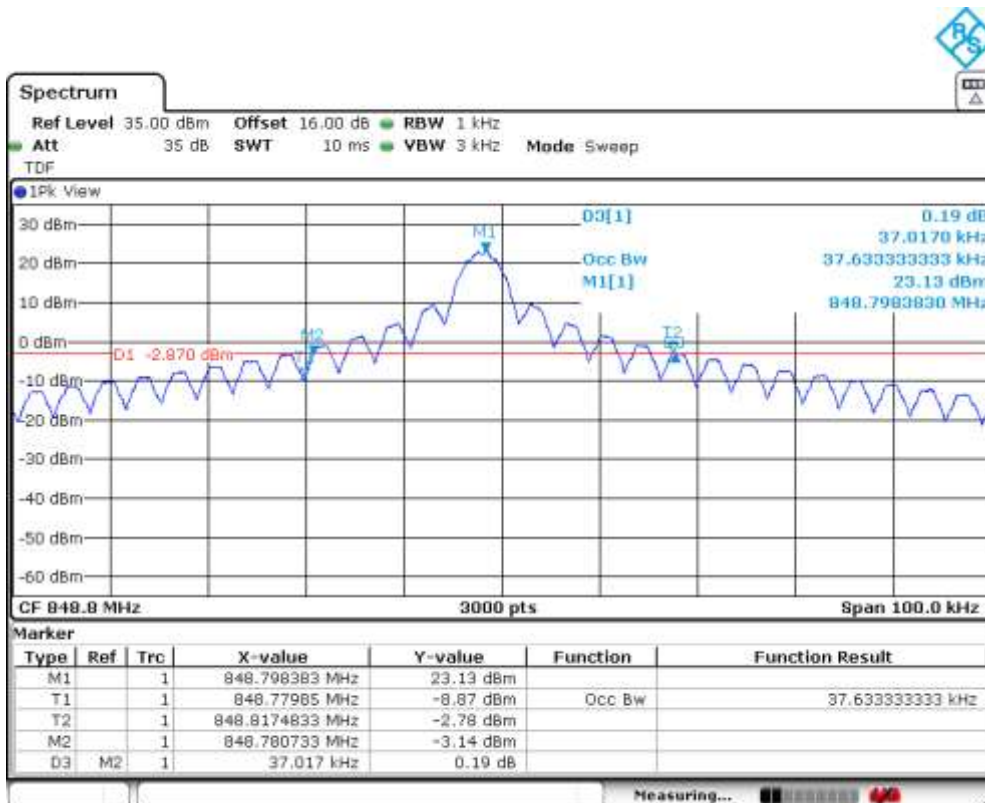

Tone 15 kHz. $\pi/2$ - BPSK MODULATION
 Lowest Channel



Middle Channel

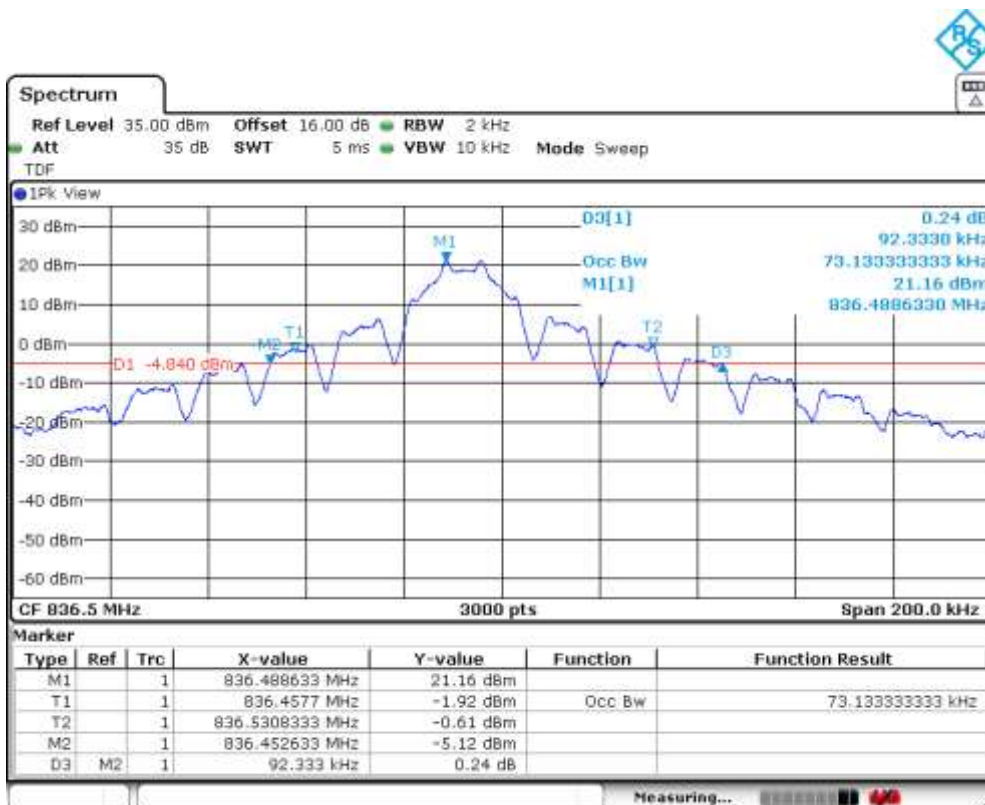

Highest Channel

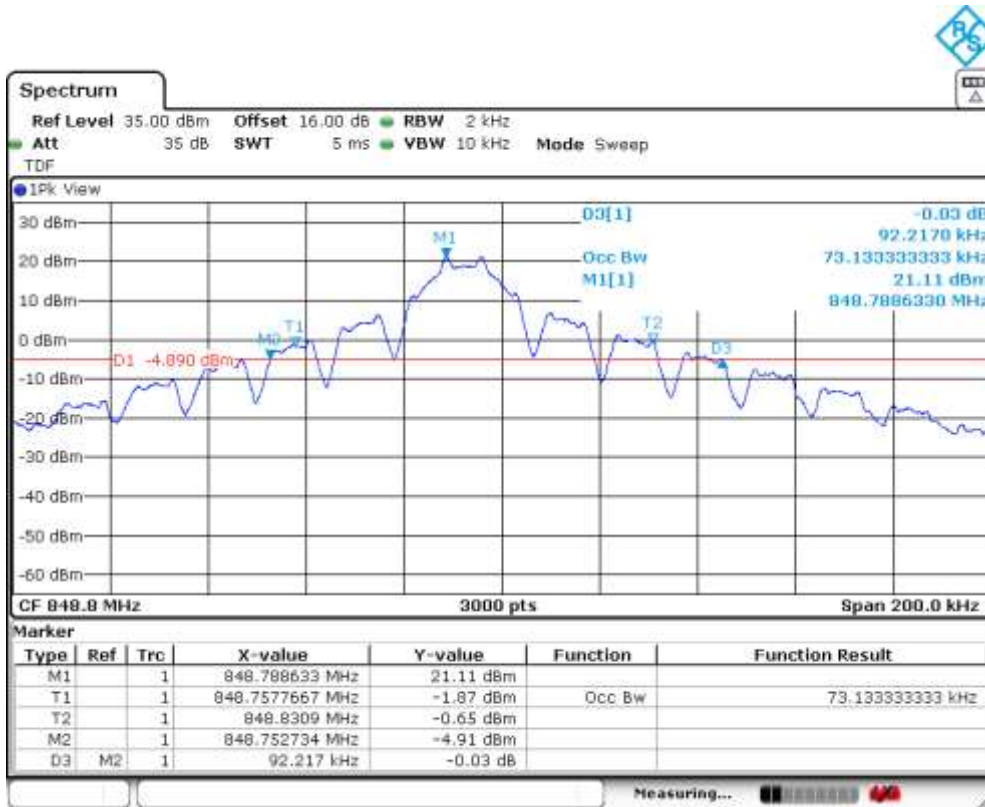

12 Tones 15 kHz. $\pi/4$ - QPSK MODULATION

Lowest Channel



Middle Channel

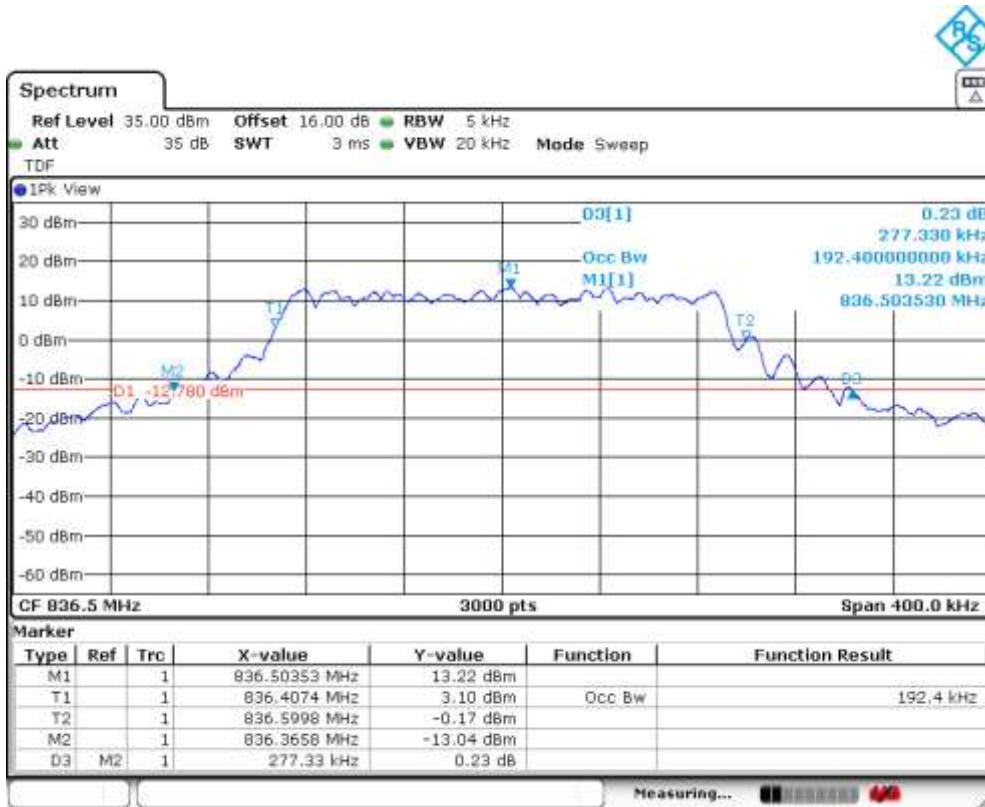

Highest Channel

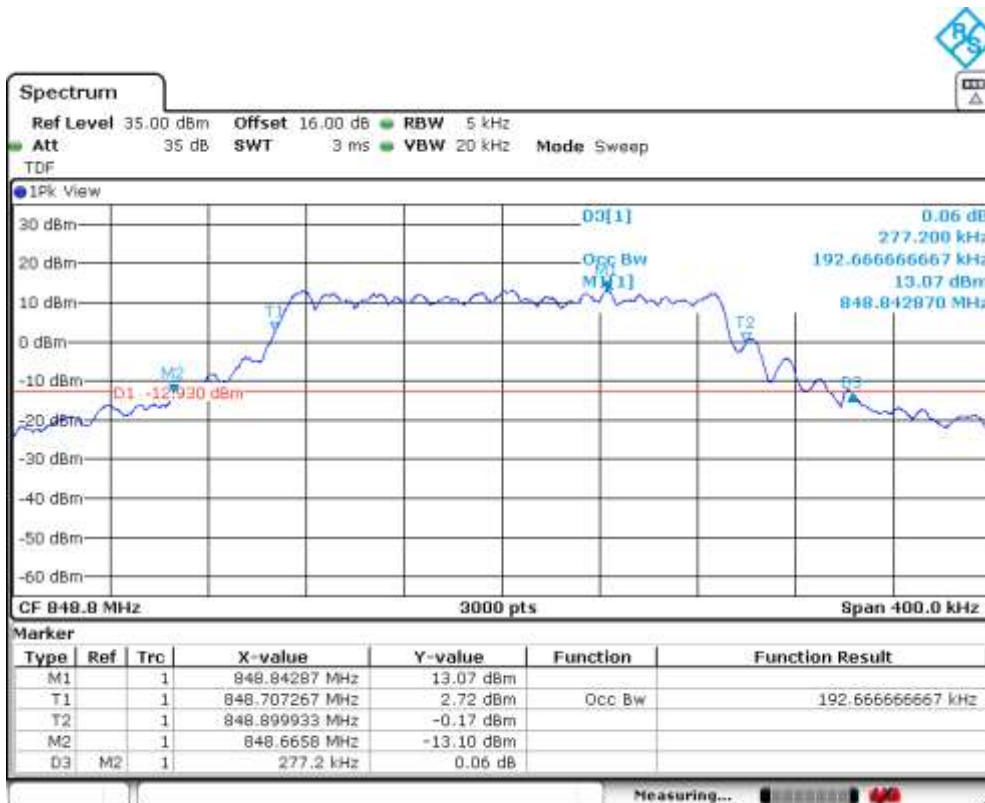

Spurious emissions at antenna terminals

SPECIFICATION:

FCC §2.1051 and §22.917

RSS-132. Clause 5.5.

FCC §90.543 (e) (2) (3) & (5):

(e) For operations in the 758-768 MHz and the 788-798 MHz bands, the power of any emission outside the licensee's frequency band(s) of operation shall be attenuated below the transmitter power (P) within the licensed band(s) of operation, measured in watts, in accordance with the following:

(2) On all frequencies between 769-775 MHz and 799-805 MHz, by a factor not less than $65 + 10 \log (P)$ dB in a 6.25 kHz band segment, for mobile and portable stations.

(3) On any frequency between 775-788 MHz, above 805 MHz, and below 758 MHz, by at least $43 + 10 \log (P)$ dB.

(5) Compliance with the provisions of paragraph (e)(3) of this section is based on the use of measurement instrumentation employing a resolution bandwidth of 100 kHz or greater. However, in the 100 kHz bands immediately outside and adjacent to the frequency block, a resolution bandwidth of 30 kHz may be employed.

FCC §90.691:

(a) Out-of-band emission requirement shall apply only to the "outer" channels included in an EA license and to spectrum adjacent to interior channels used by incumbent licensees. The emission limits are as follows:

(1) For any frequency removed from the EA licensee's frequency block by up to and including 37.5 kHz, the power of any emission shall be attenuated below the transmitter power (P) in watts by at least $116 \log_{10}(f/6.1)$ decibels or $50 + 10 \log_{10}(P)$ decibels or 80 decibels, whichever is the lesser attenuation, where f is the frequency removed from the center of the outer channel in the block in kilohertz and where f is greater than 12.5 kHz.

(2) For any frequency removed from the EA licensee's frequency block greater than 37.5 kHz, the power of any emission shall be attenuated below the transmitter power (P) in watts by at least $43 + 10 \log_{10}(P)$ decibels or 80 decibels, whichever is the lesser attenuation, where f is the frequency removed from the center of the outer channel in the block in kilohertz and where f is greater than 37.5 kHz.

(b) When an emission outside of the authorized bandwidth causes harmful interference, the Commission may, at its discretion, require greater attenuation than specified in this section.

METHOD:

The EUT RF output connector was connected to a spectrum analyser and to the Universal Radio Communication tester R&S CMW500 (selecting maximum transmission power of the EUT and different modes of modulation) using a 50 ohm attenuator and a power divider.

The spectrum was investigated from 9 kHz to 9 GHz for NB-IoT Band 5 and 26.

The reading of the spectrum analyser is corrected with the attenuation loss of connection between output terminal of EUT and input of the spectrum analyser.

The configuration of tones and modulation which is the worst case for conducted power was used.

TEST SETUP:

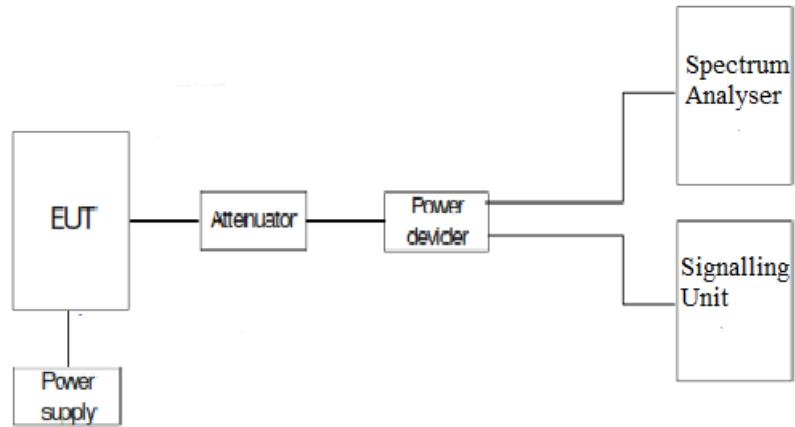

RESULTS (see plots in next pages)

2G Band 850 MHz. GPRS MODULATION.

- Lowest Channel: Spurious frequencies at less than 20 dB below the limit:

Frequency (MHz)	Level (dBm)	Measurement uncertainty (dB)
1648.659	-25.73	< ± 2.77

- Middle Channel: Spurious frequencies at less than 20 dB below the limit:

Frequency (MHz)	Level (dBm)	Measurement uncertainty (dB)
1673.559	-26.13	< ± 2.77

- Highest Channel: Spurious frequencies at less than 20 dB below the limit:

Frequency (MHz)	Level (dBm)	Measurement uncertainty (dB)
1697.859	-26.27	< ± 2.77

2G Band 850 MHz. EDGE MODULATION.

- Lowest Channel: Spurious frequencies at less than 20 dB below the limit:

Frequency (MHz)	Level (dBm)	Measurement uncertainty (dB)
1648.659	25.45	< ± 2.77

- Middle Channel: Spurious frequencies at less than 20 dB below the limit:

Frequency (MHz)	Level (dBm)	Measurement uncertainty (dB)
1673.259	-25.70	< ± 2.77

- Highest Channel: Spurious frequencies at less than 20 dB below the limit:

Frequency (MHz)	Level (dBm)	Measurement uncertainty (dB)
1698.859	-26.35	< ± 2.77

Verdict: PASS

814-824MHz Band:

NBLoT BAND 26 (Tone 3.75 kHz. $\pi/2$ - BPSK MODULATION)

1. CHANNEL: LOWEST

All peaks are more than 20 dB below the limit.

2. CHANNEL: MIDDLE

All peaks are more than 20 dB below the limit.

3. CHANNEL: HIGHEST

All peaks are more than 20 dB below the limit.

NBLoT BAND 26 (Tone 15 kHz. $\pi/2$ - BPSK MODULATION)

1. CHANNEL: LOWEST

All peaks are more than 20 dB below the limit.

2. CHANNEL: MIDDLE

All peaks are more than 20 dB below the limit.

3. CHANNEL: HIGHEST

All peaks are more than 20 dB below the limit.

Cross-rule channel (824MHz):

NBLoT BAND 26 (Tone 3.75 kHz. $\pi/2$ - BPSK MODULATION)

All peaks are more than 20 dB below the limit.

NBLoT BAND 26 (Tone 15 kHz. $\pi/2$ - BPSK MODULATION)

All peaks are more than 20 dB below the limit.

824-849MHz Band:

NBLoT BAND 5 (Tone 3.75 kHz. $\pi/2$ - BPSK MODULATION)

1. CHANNEL: LOWEST

All peaks are more than 20 dB below the limit.

2. CHANNEL: MIDDLE

All peaks are more than 20 dB below the limit.

3. CHANNEL: HIGHEST

All peaks are more than 20 dB below the limit.

NBLoT BAND 5 (Tone 15 kHz. $\pi/2$ - BPSK MODULATION)

1. CHANNEL: LOWEST

All peaks are more than 20 dB below the limit.

2. CHANNEL: MIDDLE

All peaks are more than 20 dB below the limit.

3. CHANNEL: HIGHEST

All peaks are more than 20 dB below the limit.

Measurement uncertainty (dB): $< \pm 2.76$

Verdict: PASS

2G Band 850 MHz. GPRS MODULATION.

Lowest Channel:

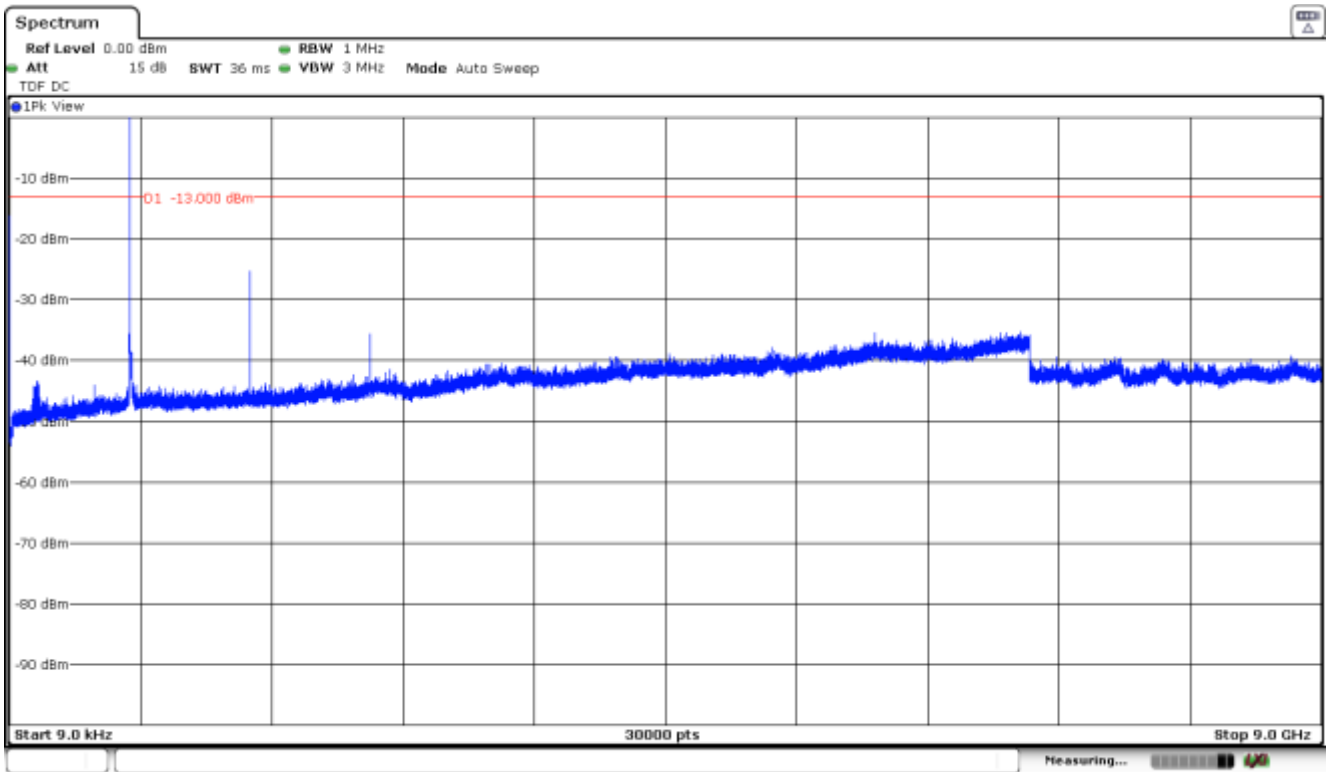

The peak above the limit is the carrier frequency.

Middle Channel:

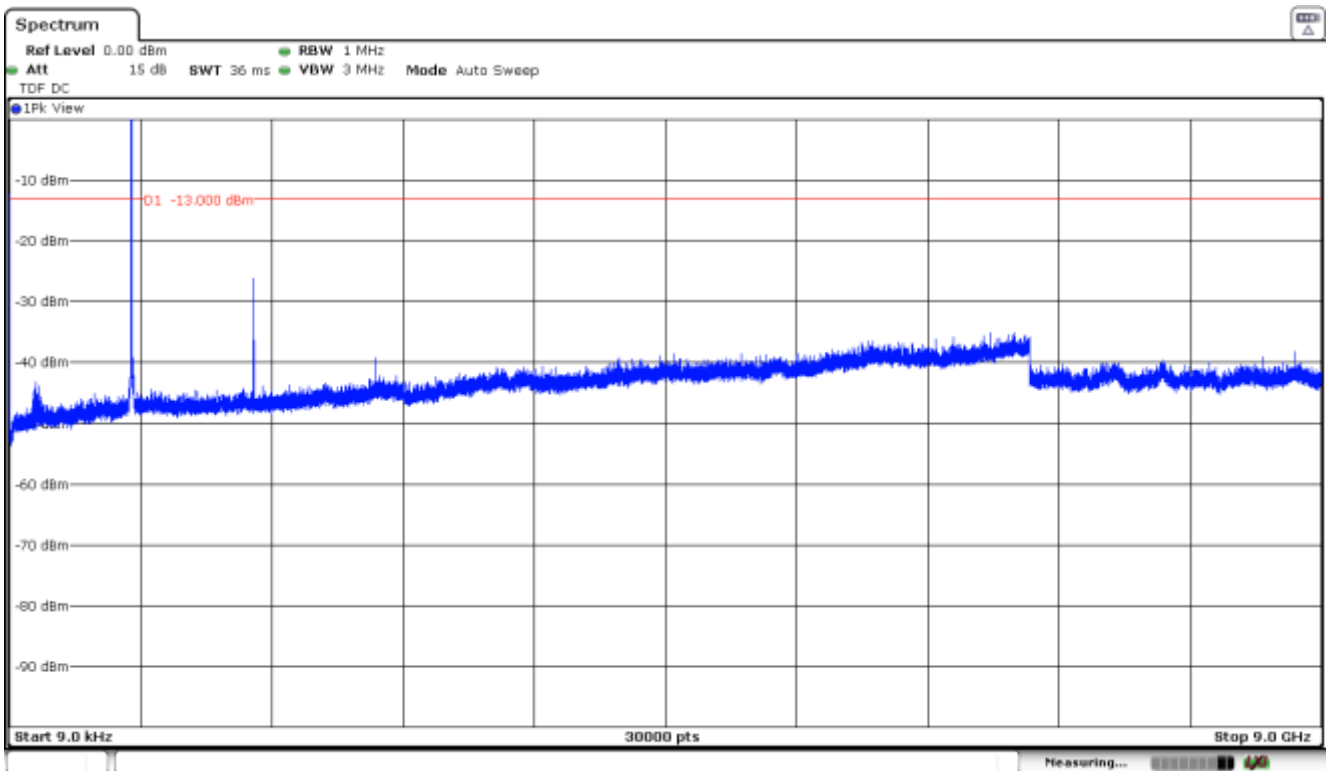

The peak above the limit is the carrier frequency.

Highest Channel:

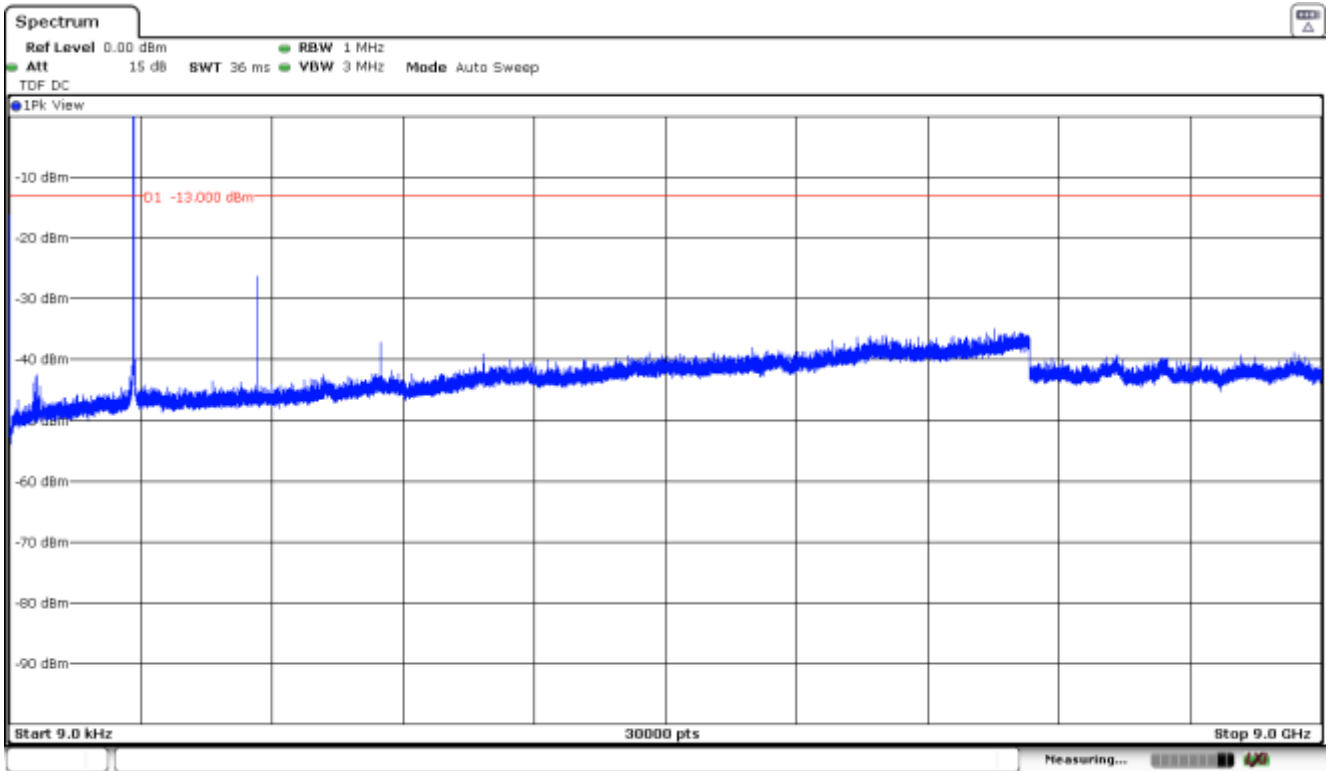

The peak above the limit is the carrier frequency.

2G Band 850 MHz. EDGE MODULATION.

Lowest Channel:

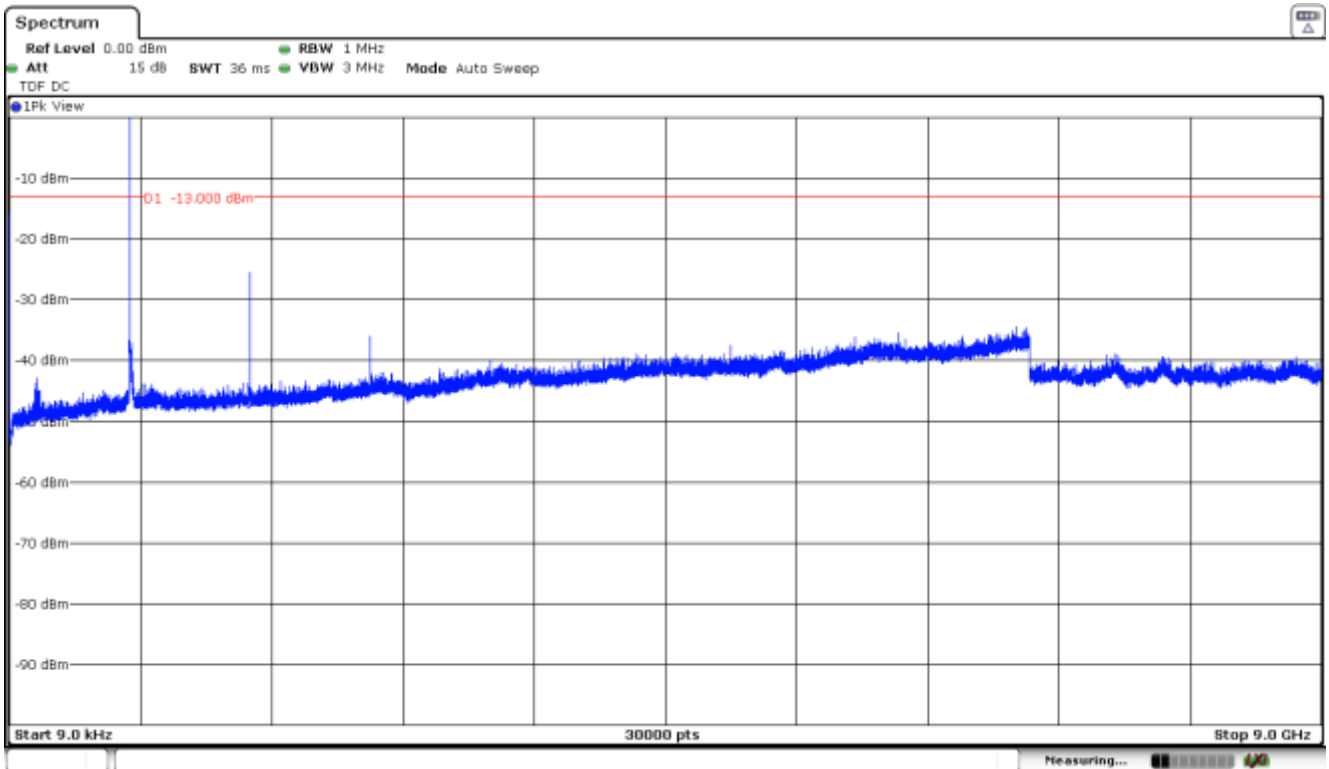

The peak above the limit is the carrier frequency.

Middle Channel:

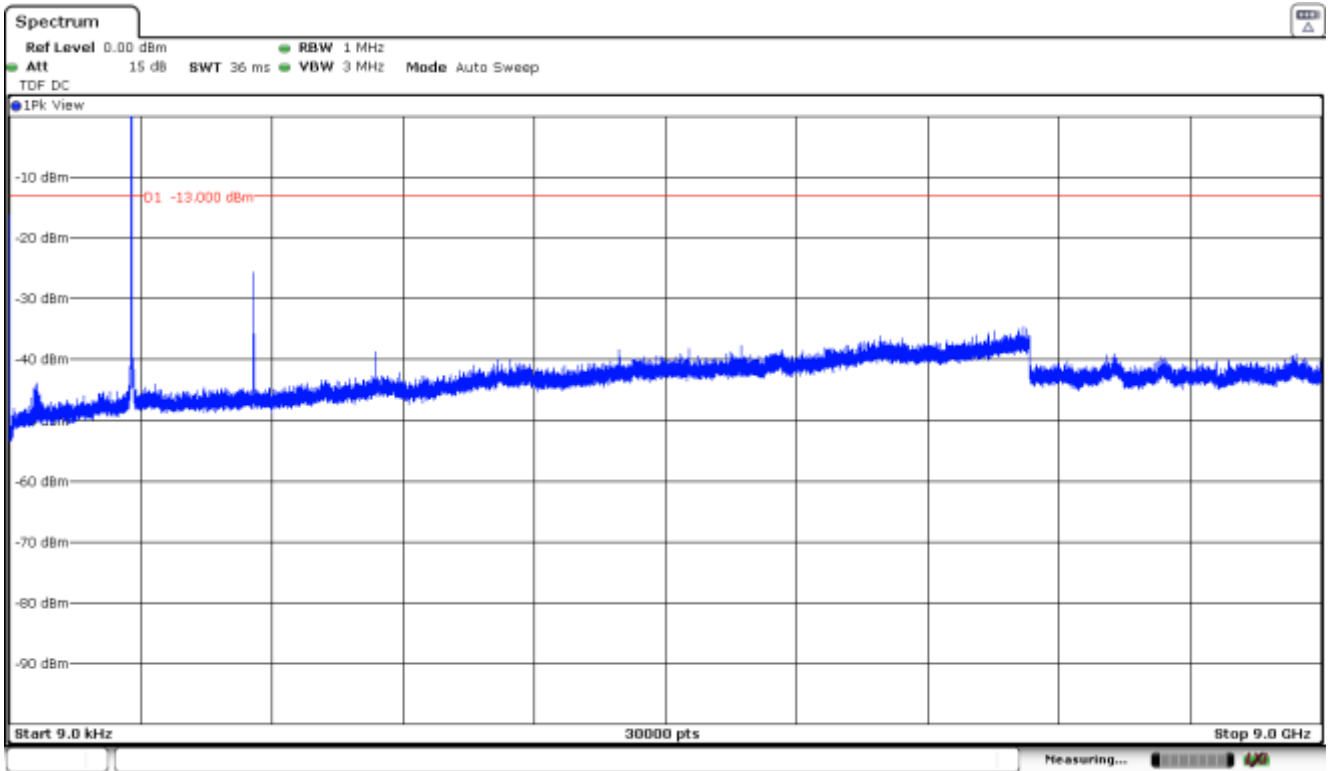

The peak above the limit is the carrier frequency.

Highest Channel:

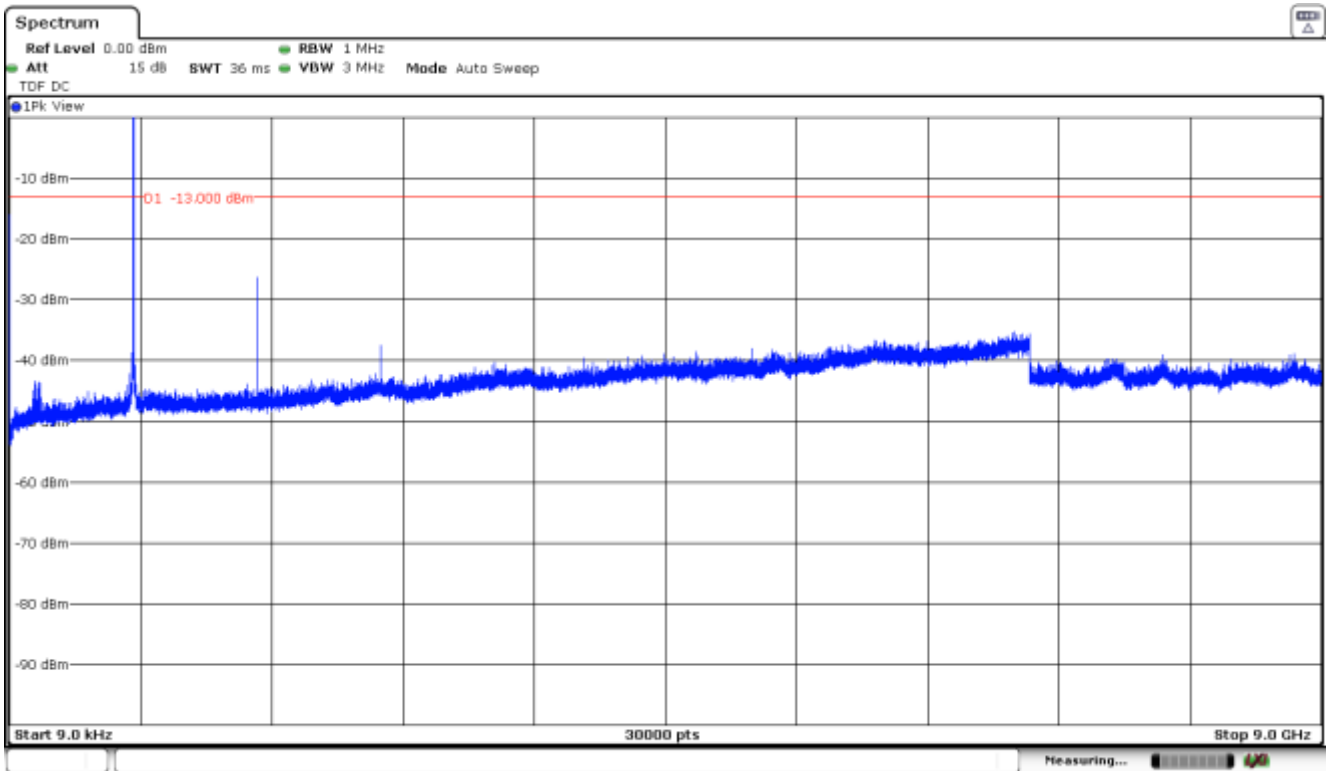

The peak above the limit is the carrier frequency.

814-824MHz Band:
NB IoT BAND 26 (Tone 3.75 kHz. $\pi/2$ - BPSK MODULATION)

1. CHANNEL: LOWEST

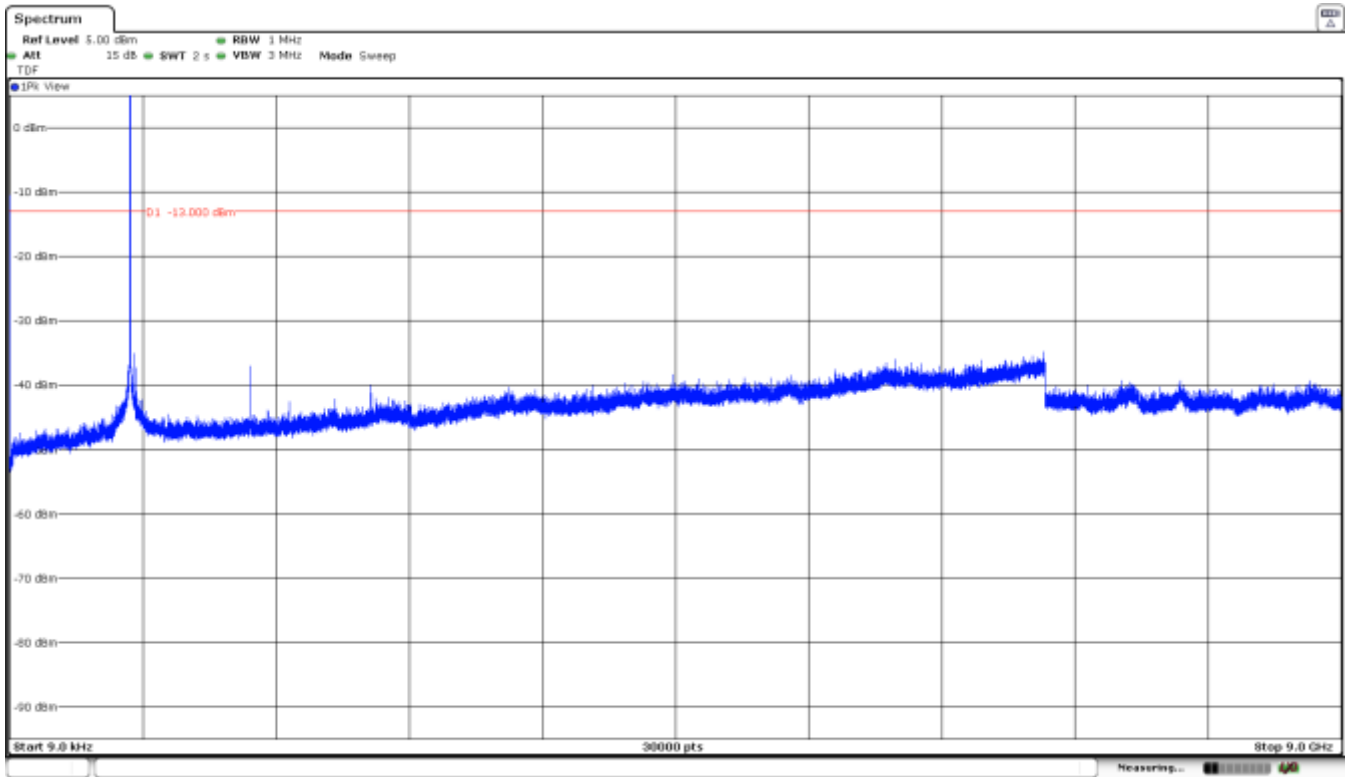

Note: The peak above the limit is the carrier frequency.

2. CHANNEL: MIDDLE

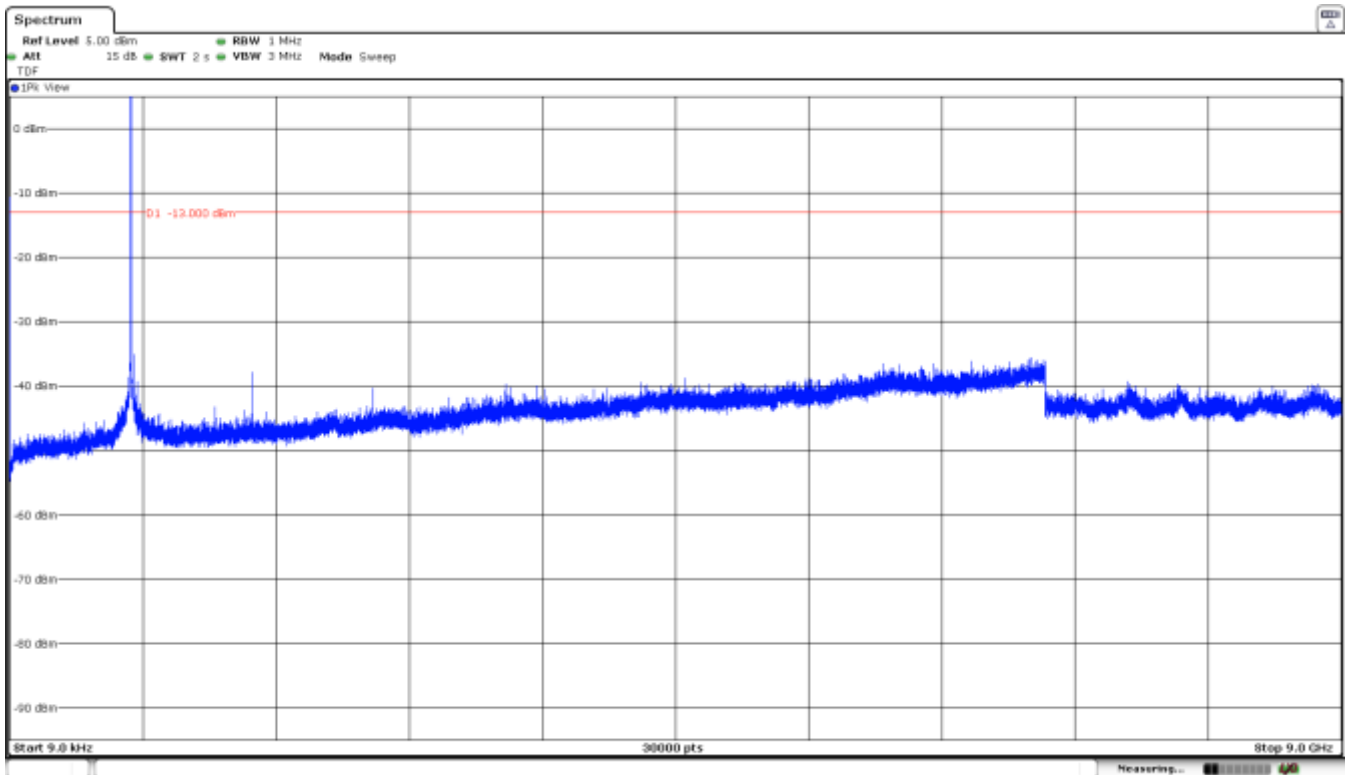

Note: The peak above the limit is the carrier frequency.

3. CHANNEL: HIGHEST

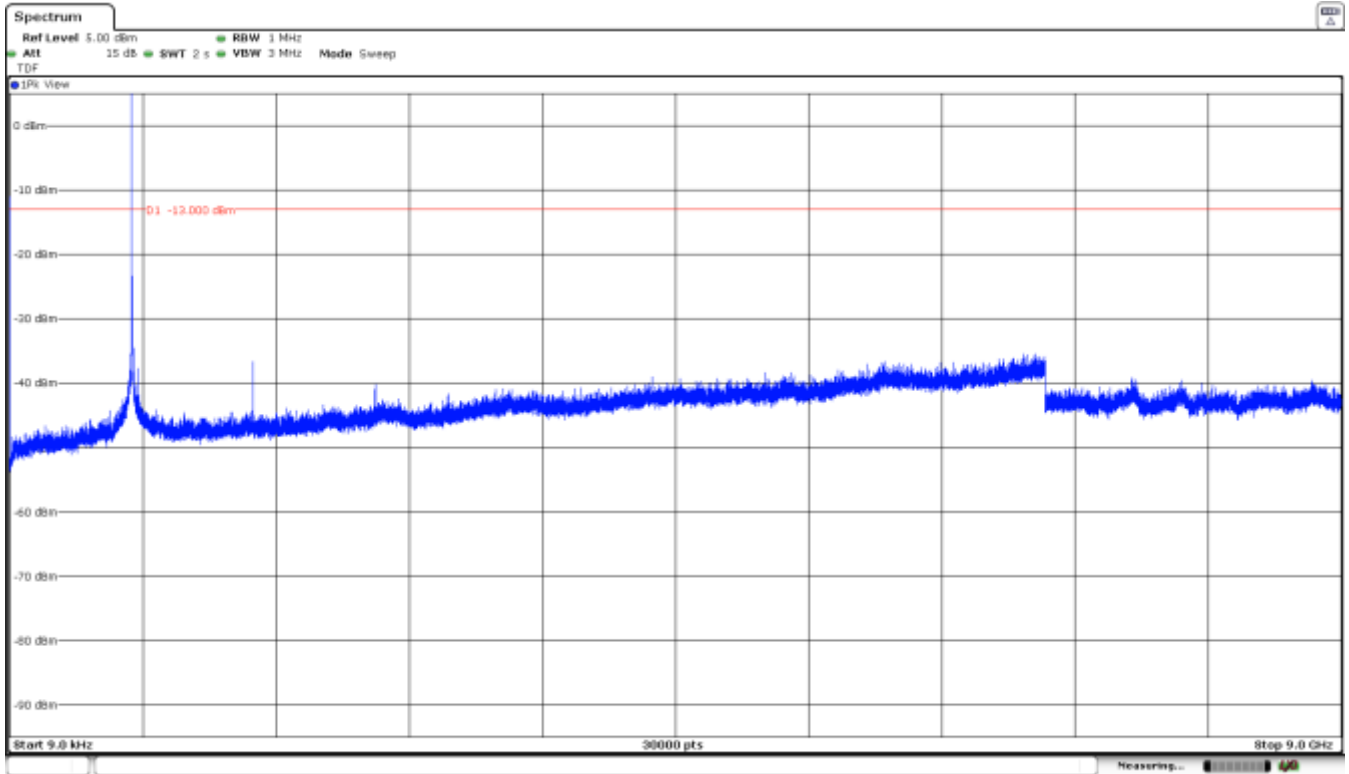

Note: The peak above the limit is the carrier frequency.

NB IoT BAND 26 (Tone 15 kHz. $\pi/2$ - BPSK MODULATION)

1. CHANNEL: LOWEST

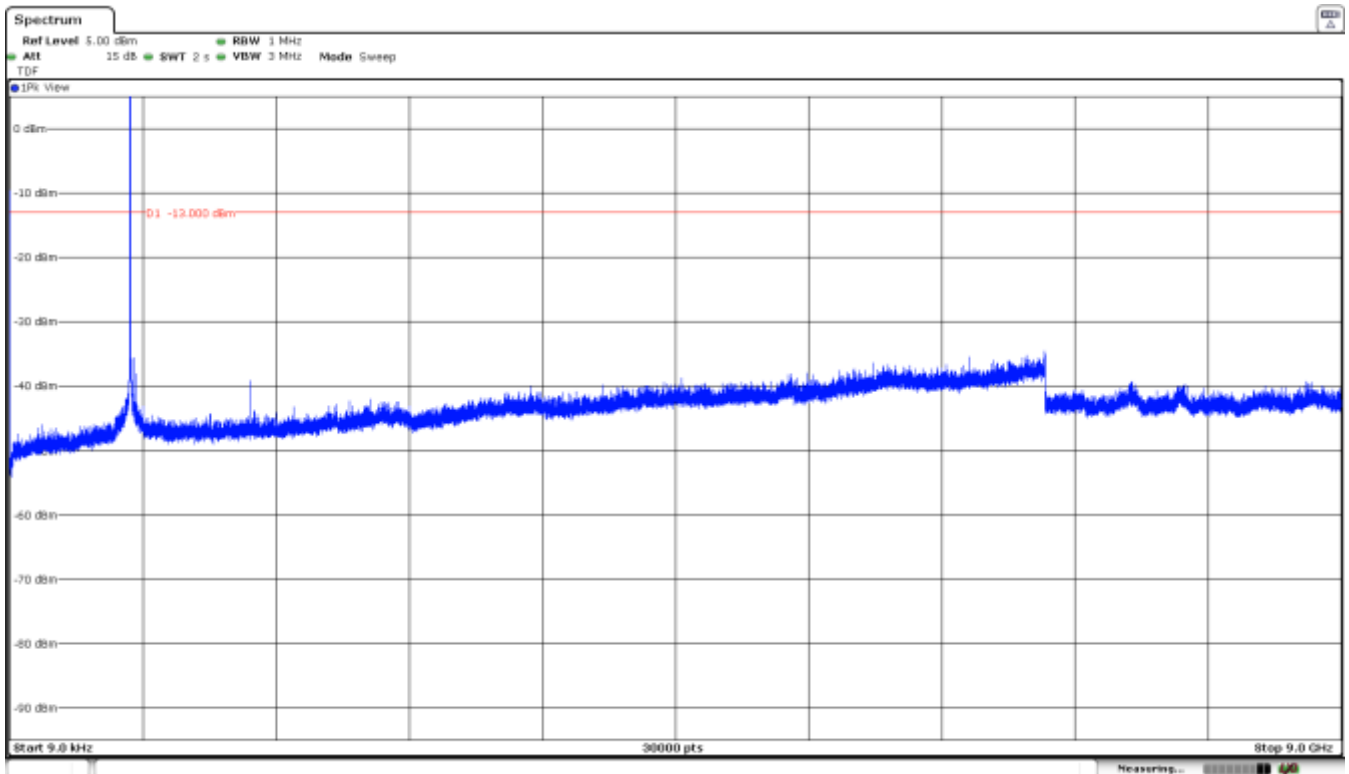

Note: The peak above the limit is the carrier frequency.

2. CHANNEL: MIDDLE

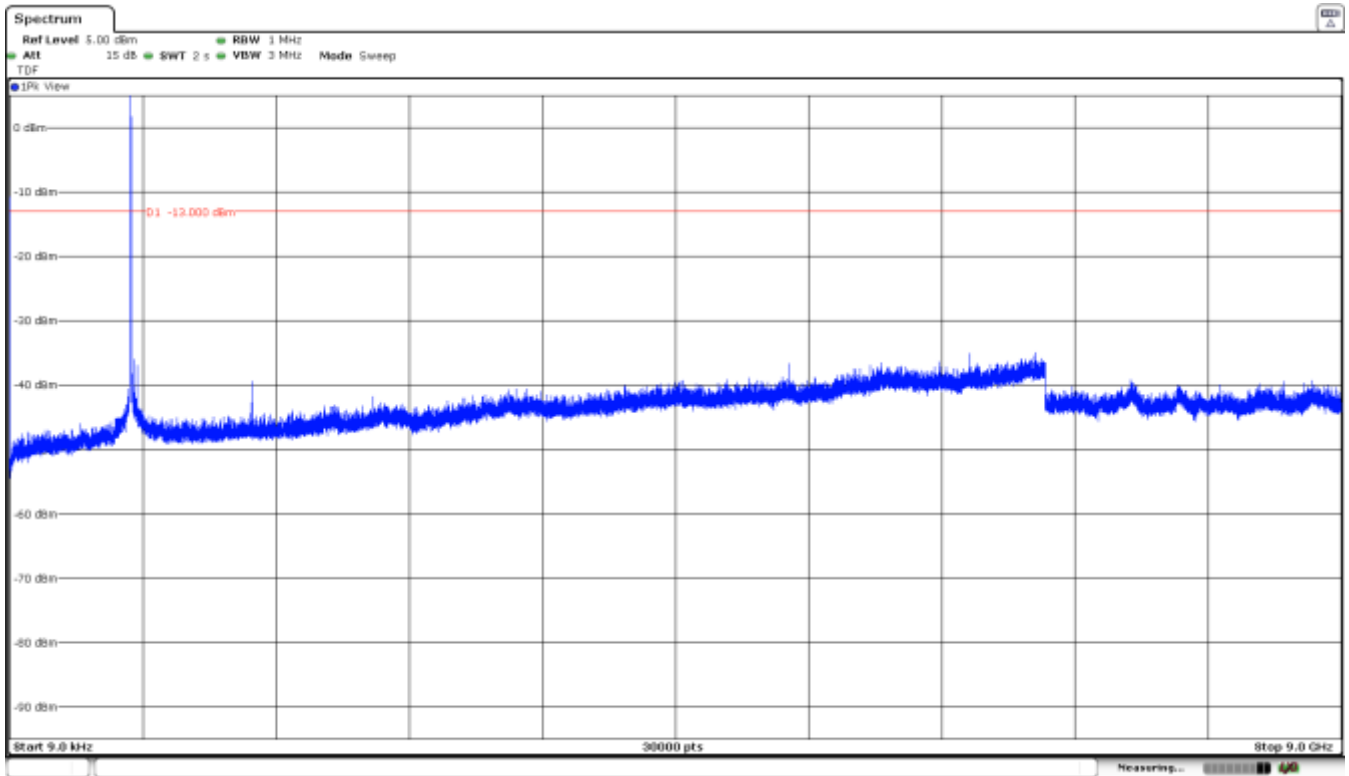

Note: The peak above the limit is the carrier frequency.

3. CHANNEL: HIGHEST

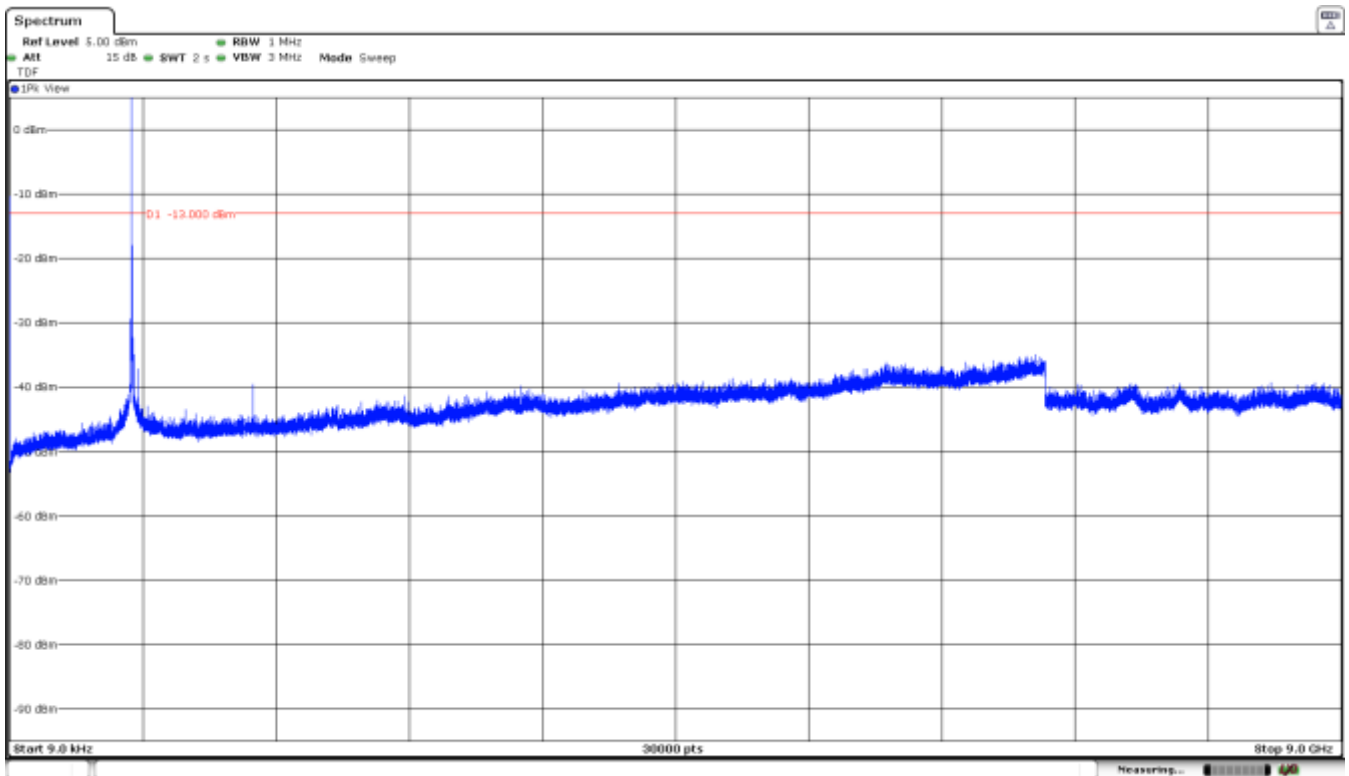

Note: The peak above the limit is the carrier frequency.

Cross-rule channel (824MHz):

NBLoT BAND 26 (Tone 3.75 kHz. $\pi/2$ - BPSK MODULATION)

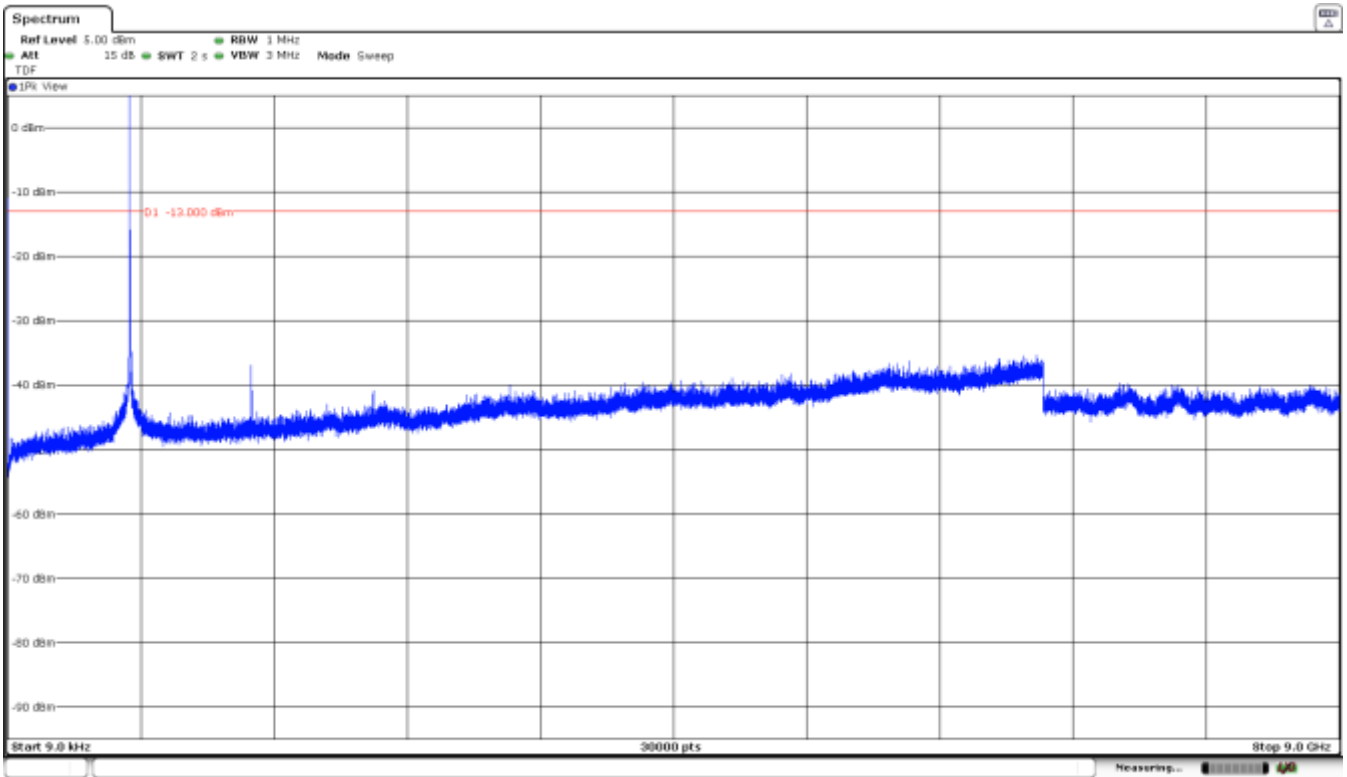

NBLoT BAND 26 (Tone 15 kHz. $\pi/2$ - BPSK MODULATION)

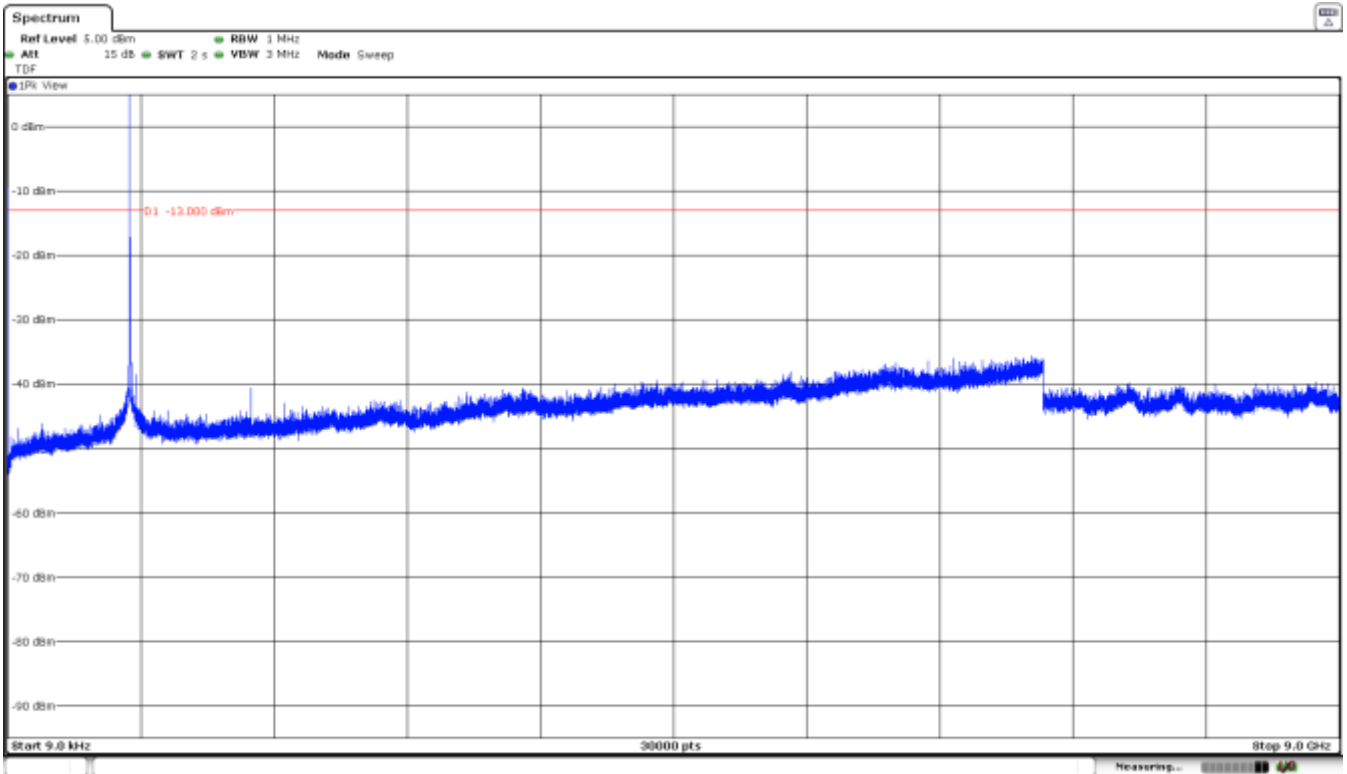

824-849MHz Band: NBLoT BAND 5 (Tone 3.75 kHz. $\pi/2$ - BPSK MODULATION)

1. CHANNEL: LOWEST

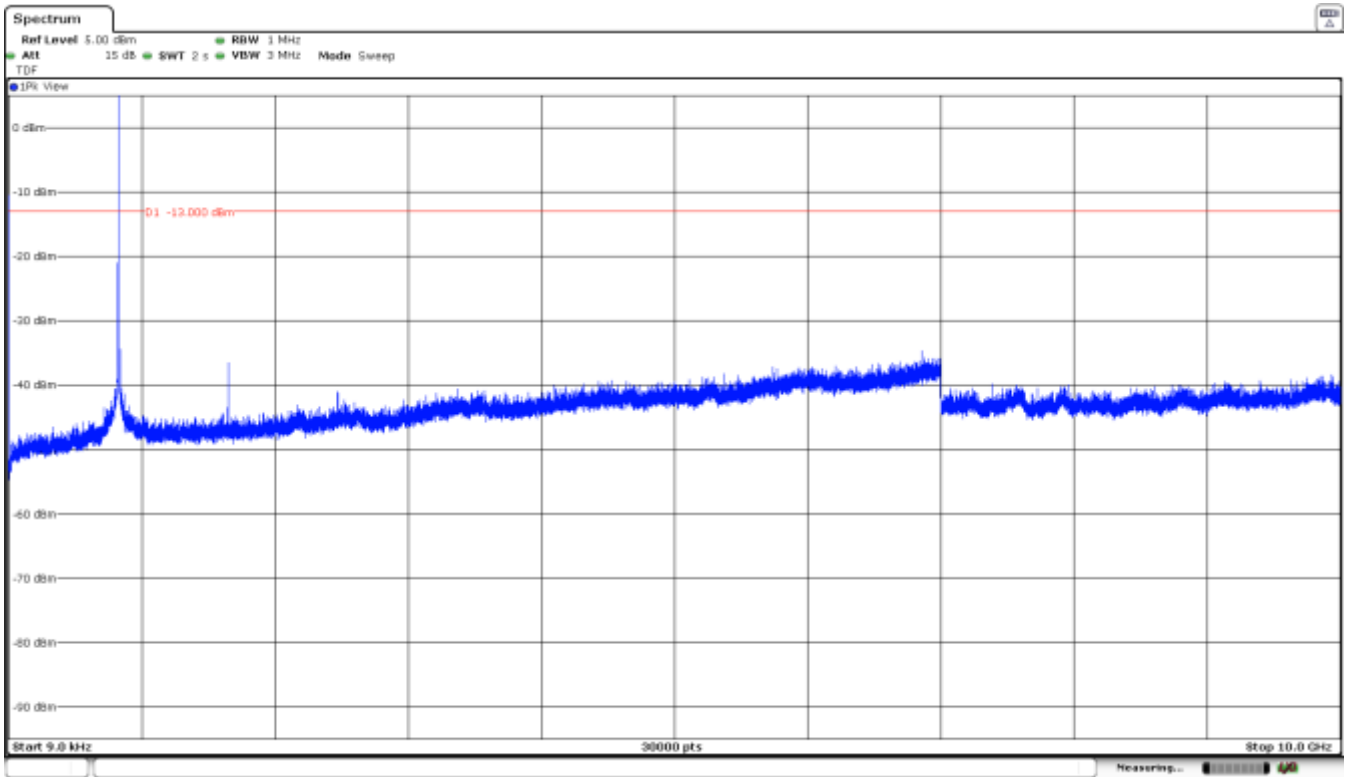

Note: The peak above the limit is the carrier frequency.

2. CHANNEL: MIDDLE

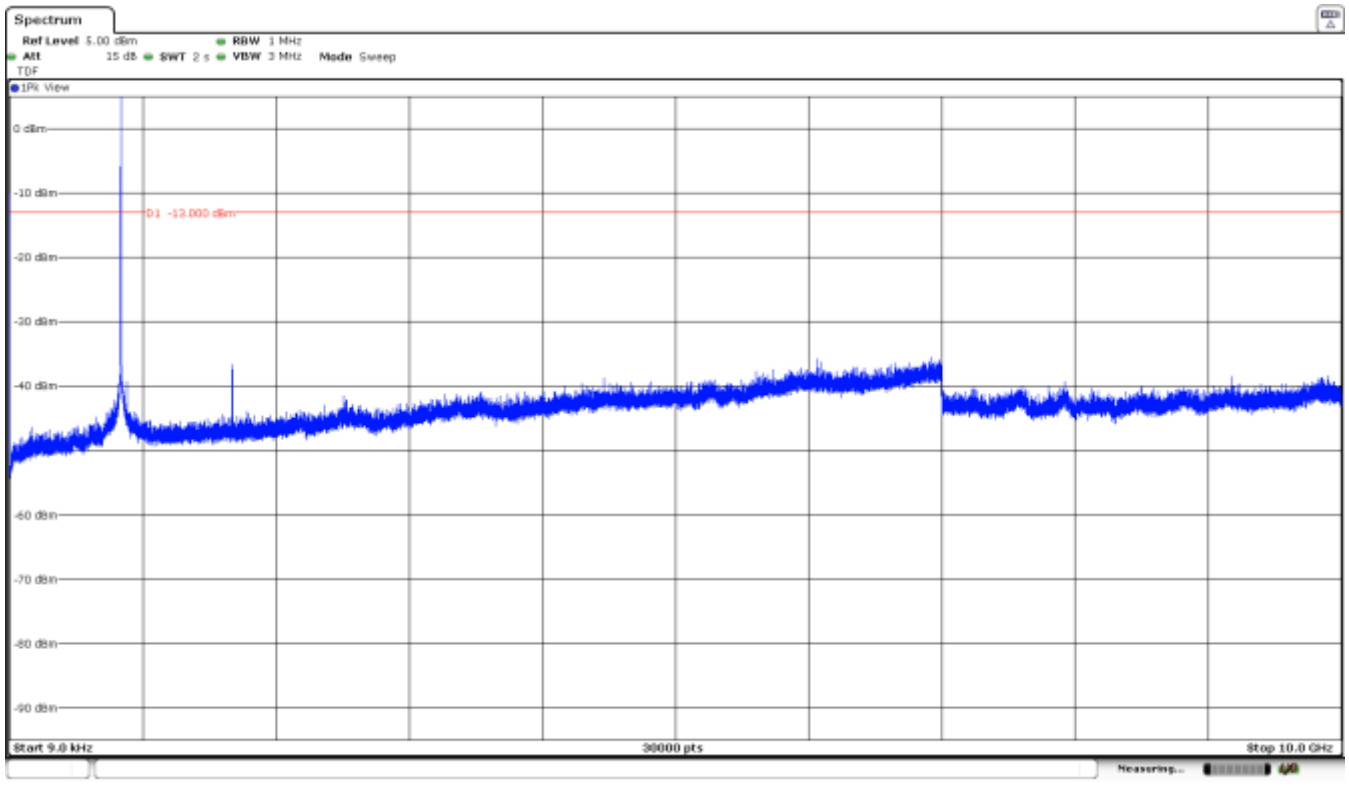

Note: The peak above the limit is the carrier frequency.

3. CHANNEL: HIGHEST

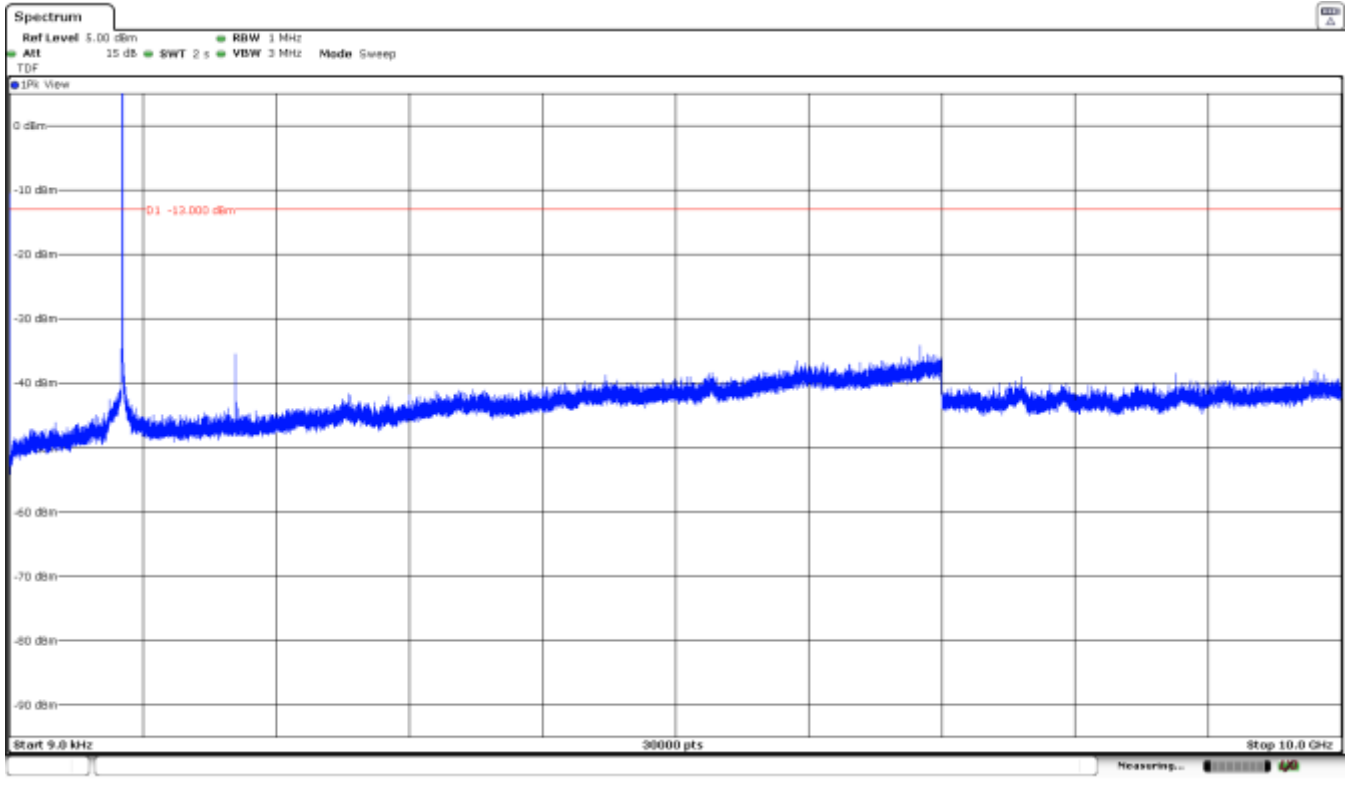

Note: The peak above the limit is the carrier frequency.

NB-IoT BAND 26 (Tone 15 kHz. $\pi/2$ - BPSK MODULATION)

1. CHANNEL: LOWEST

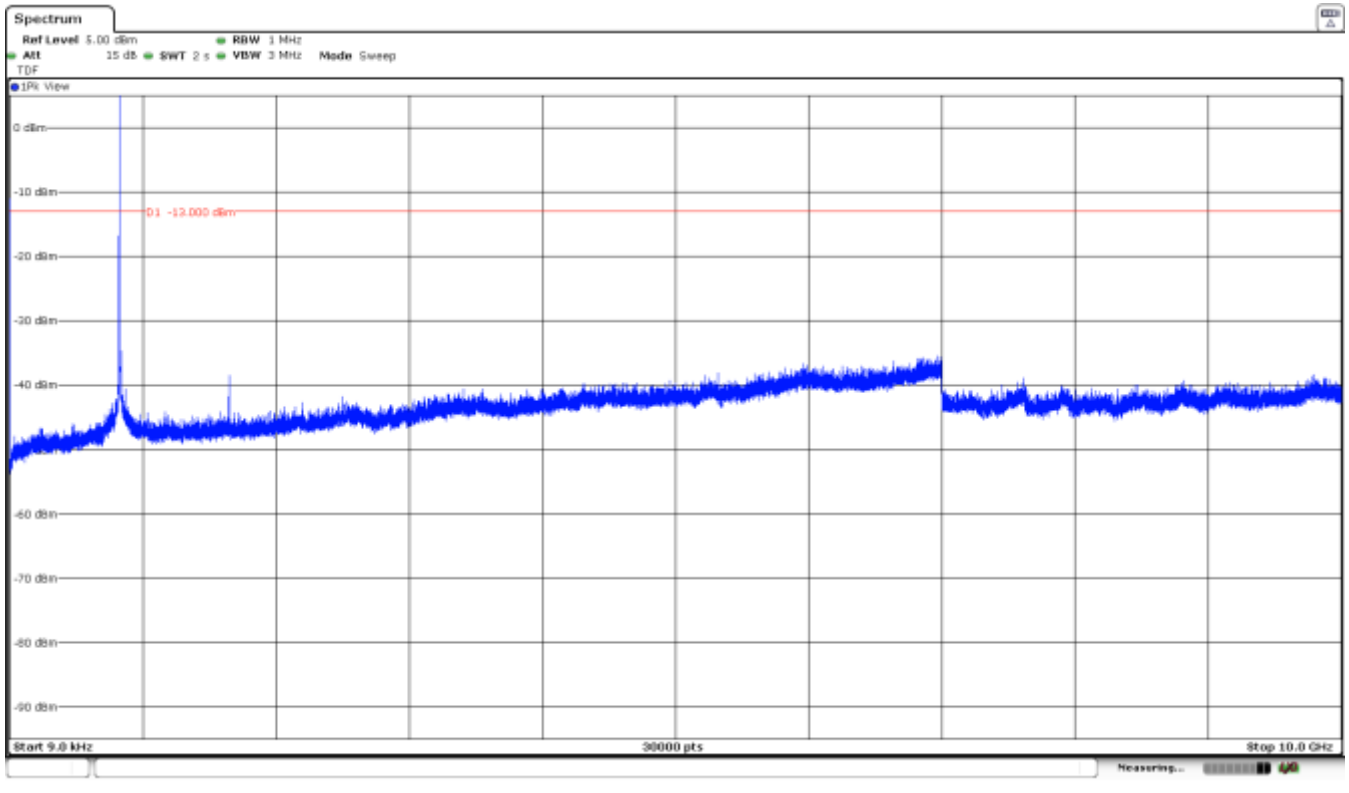

Note: The peak above the limit is the carrier frequency.

2. CHANNEL: MIDDLE

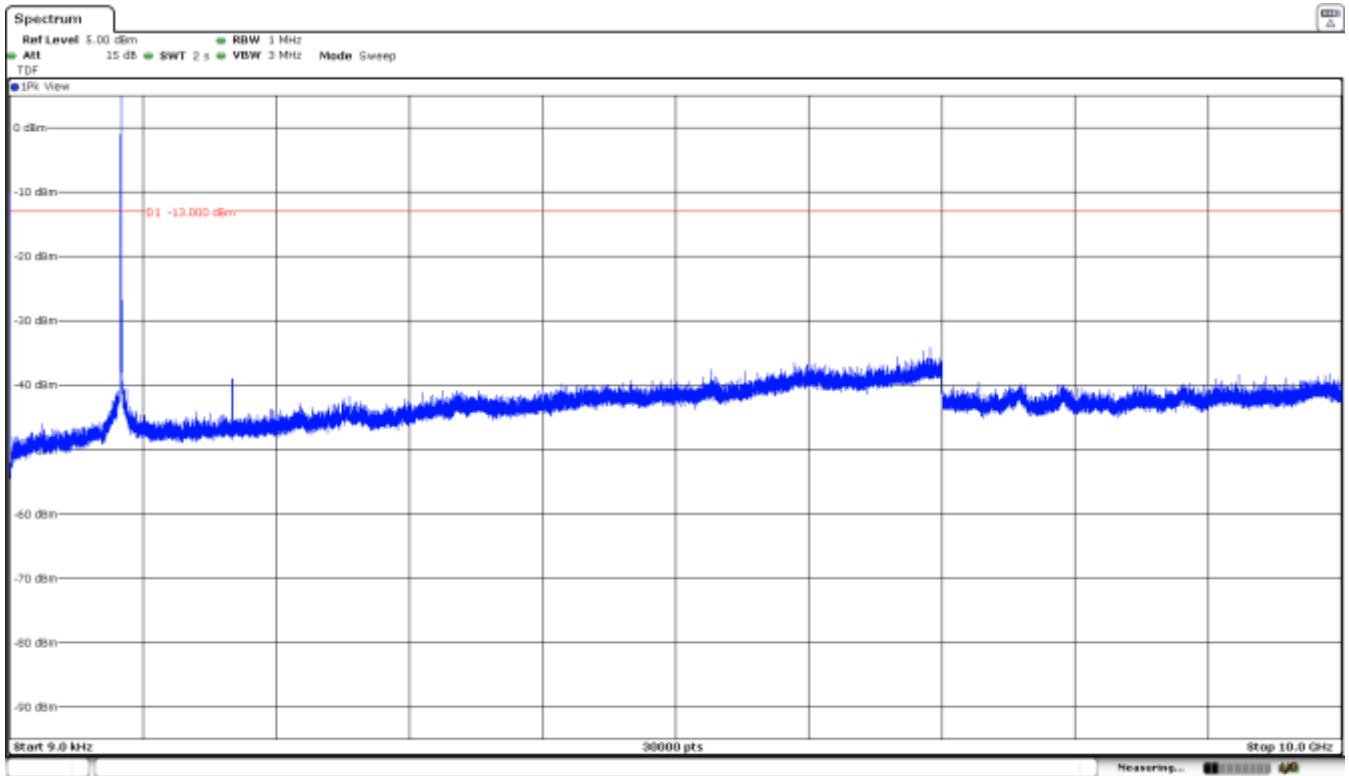

Note: The peak above the limit is the carrier frequency.

3. CHANNEL: HIGHEST

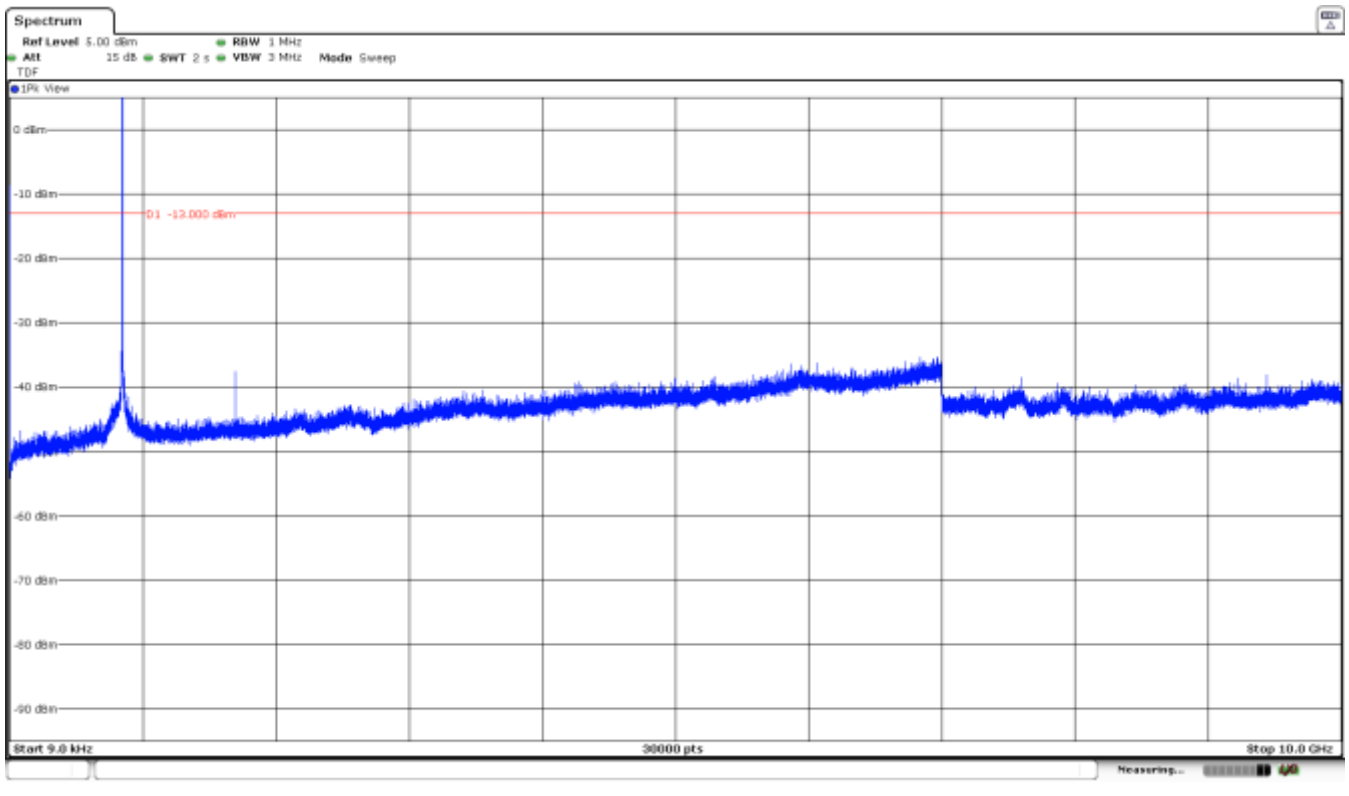

Note: The peak above the limit is the carrier frequency.

Spurious emissions at antenna terminals at Block Edges

SPECIFICATION

FCC §2.1051 and §22.917
RSS-132. Clause 5.5.

The power of emissions shall be attenuated below the transmitter power (P) by a factor of at least $43 + 10 \log (P)$ dB. P in watts.

FCC §90.691. Emission mask requirements for EA-based systems. Out-of-band emission requirement shall apply only to the “outer” channels included in an EA license and to spectrum adjacent to interior channels used by incumbent licensees. The emission limits are as follows:

(1) For any frequency removed from the EA licensee's frequency block by up to and including 37.5 kHz, the power of any emission shall be attenuated below the transmitter power (P) in watts by at least $116 \text{Log}_{10}(f/6.1)$ decibels or $50 + 10 \text{Log}_{10}(P)$ decibels or 80 decibels, whichever is the lesser attenuation, where f is the frequency removed from the center of the outer channel in the block in kilohertz and where f is greater than 12.5 kHz.

(2) For any frequency removed from the EA licensee's frequency block greater than 37.5 kHz, the power of any emission shall be attenuated below the transmitter power (P) in watts by at least $43 + 10\text{Log}_{10}(P)$ decibels or 80 decibels, whichever is the lesser attenuation, where f is the frequency removed from the center of the outer channel in the block in kilohertz and where f is greater than 37.5 kHz.

METHOD

The EUT RF output connector was connected to a spectrum analyser and to the Universal Radio Communication tester R&S CMW500 (selecting maximum transmission power of the EUT and different modes of modulation) using a 50 ohm attenuator and a power splitter.

The reading of the spectrum analyser is corrected with the attenuation loss of connection between output terminal of EUT and input of the spectrum analyser.

The configuration of modulation which is the worst case for conducted power was used.

As indicated in FCC part 22, in the 1 MHz bands immediately outside and adjacent to the frequency block or band a resolution bandwidth of at least one percent of the emission bandwidth of the fundamental emission of the transmitter may be employed.

Measurement Limit:

According to specification. the power of emissions shall be attenuated below the transmitter power (P) by a factor of at least $43 + 10 \log (P)$ dB. P in watts.

At P_o transmitting power. the specified minimum attenuation becomes $43+10\log (P_o)$. and the level in dBm relative P_o becomes:

$$P_o \text{ (dBm)} - [43 + 10 \log (P_o \text{ in mwatts}) - 30] = - 13 \text{ dBm}$$

TEST SETUP

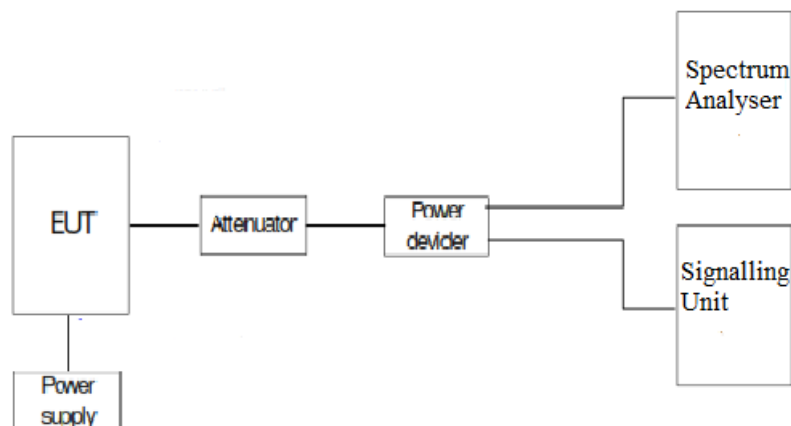

RESULTS (see plots in next pages)

2G Band 850 MHz.

2G Band 850 MHz	GPRS	EDGE
Maximum measured level at <u>Lowest Block Edge</u> at antenna port (dBm)	-15.17	-15.16

2G Band 850 MHz	GPRS	EDGE
Maximum measured level at <u>Highest Block Edge</u> at antenna port (dBm)	-16.72	-16.77

NBLoT:

824-849MHz Band:

NBLoT	Tone 3.75 kHz. $\pi/4$ - QPSK Offset 0 MCS/TBS=3	Tone 15kHz. $\pi/2$ - BPSK Offset 0 MCS/TBS=0	12 Tone 15kHz. $\pi/2$ - BPSK Offset 0 MCS/TBS=0
Maximum measured level at lowest Block Edge at antenna port (dBm)	-41.83	-36.97	-30.36

NBLoT	Tone 3.75 kHz. $\pi/4$ - QPSK Offset 0 MCS/TBS=3	Tone 15kHz. $\pi/2$ - BPSK Offset 0 MCS/TBS=0	12 Tone 15kHz. $\pi/2$ - BPSK Offset 0 MCS/TBS=0
Maximum measured level at highest Block Edge at antenna port (dBm)	-28.65	-36.94	-34.78

Measurement uncertainty = ± 1.57 dB.

814-824 MHz Band “EA MASK”.

NB-IoT BAND 26 (Tone 3.75 kHz. $\pi/4$ - QSK Offset 0)

Lowest Channel:

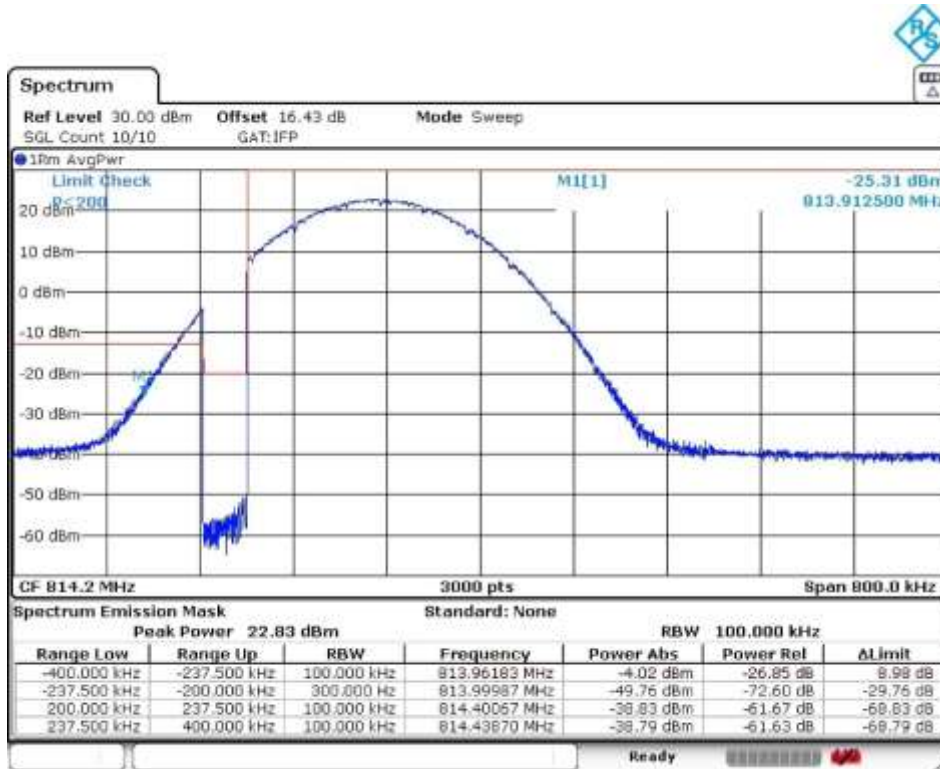

NB-IoT BAND 26 (Tone 15 kHz. $\pi/2$ - BPSK Offset 0 MODULATION)

Lowest Channel:

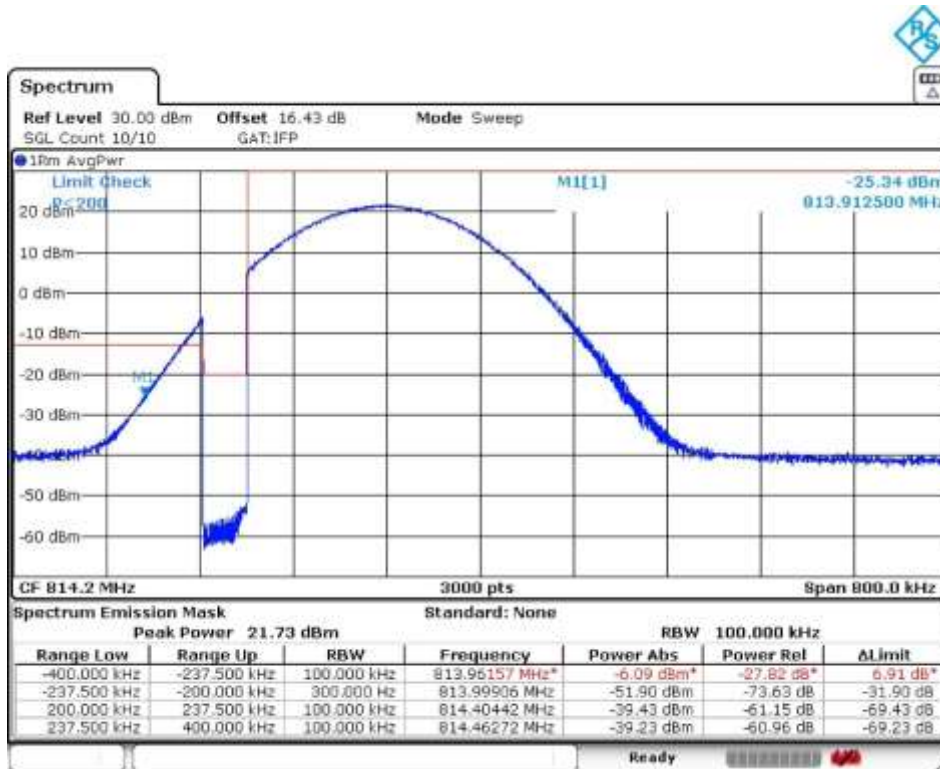

NBLoT BAND 26 (12 Tones 15 kHz. $\pi/4$ - QPSK Offset 0 MODULATION)

Lowest Channel:

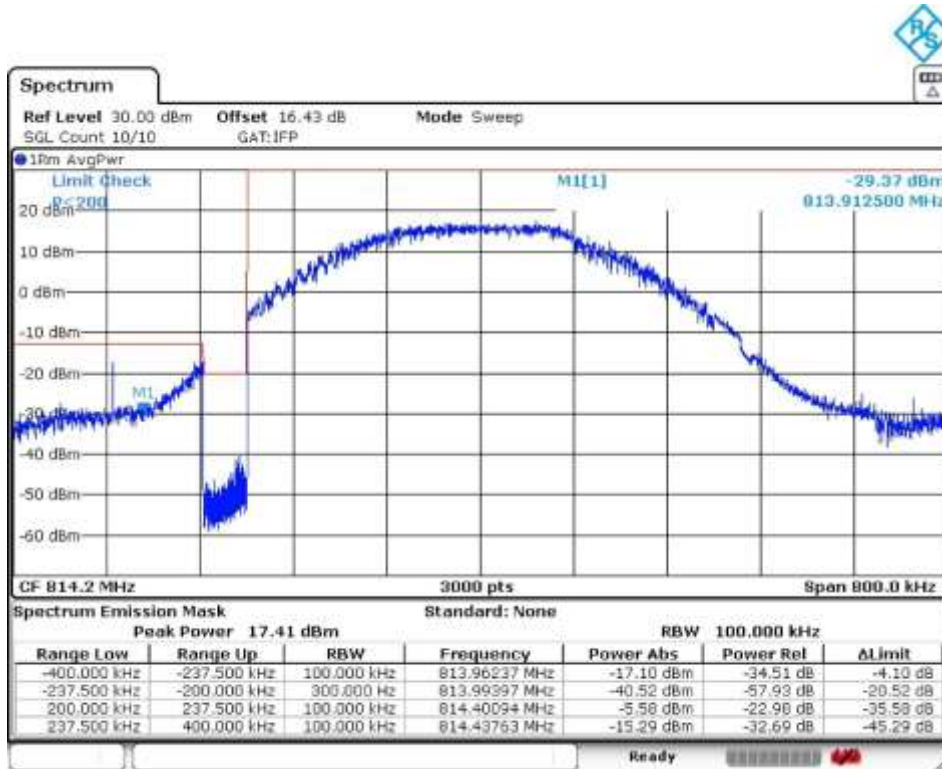

NBLoT BAND 26 (Tone 3.75 kHz. $\pi/2$ - BPSK Offset 47 MODULATION)

Highest Channel:

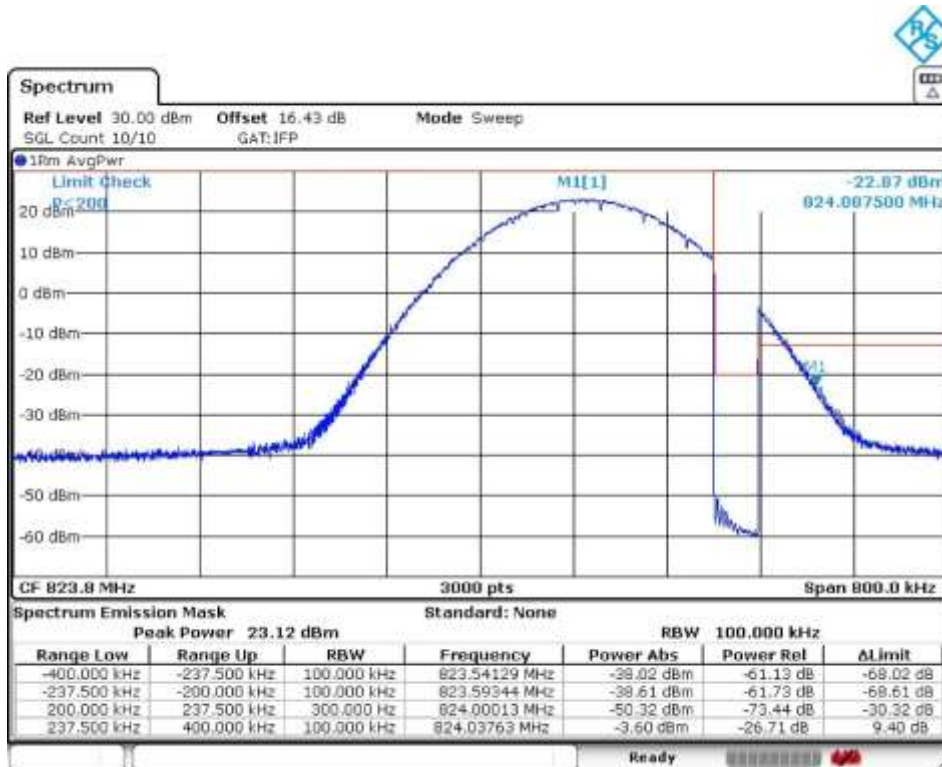

NB-IoT BAND 26 (Tone 15 kHz. $\pi/4$ - QPSK Offset 11 MODULATION)

Highest Channel:

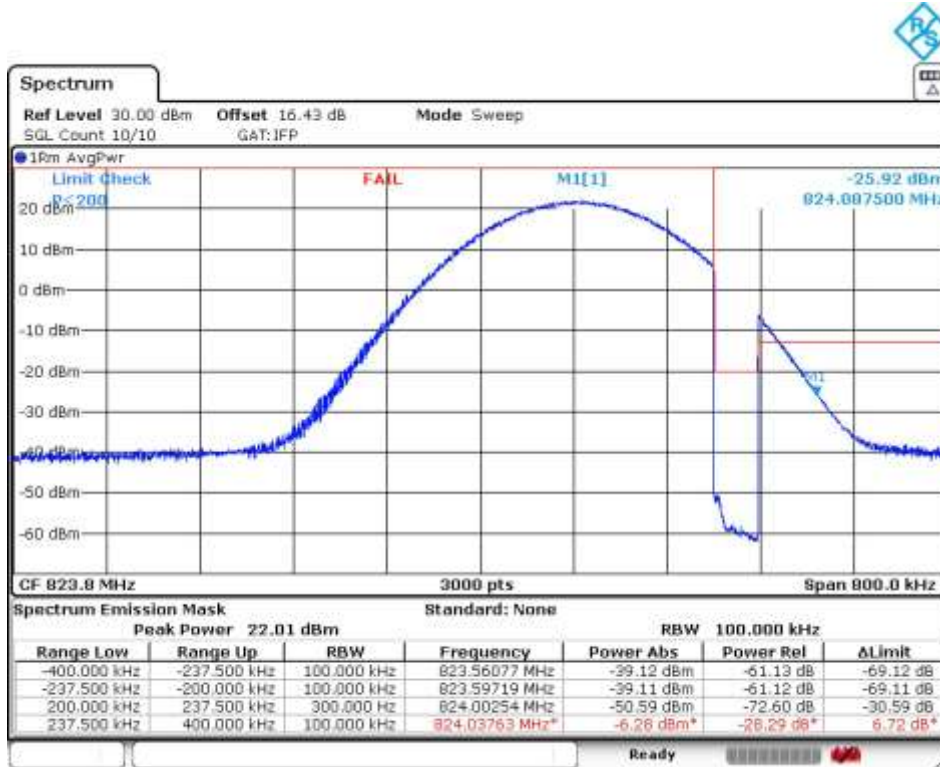

NB-IoT BAND 26 (12 Tones 15 kHz. $\pi/4$ - QPSK Offset 0 MODULATION)

Highest Channel:

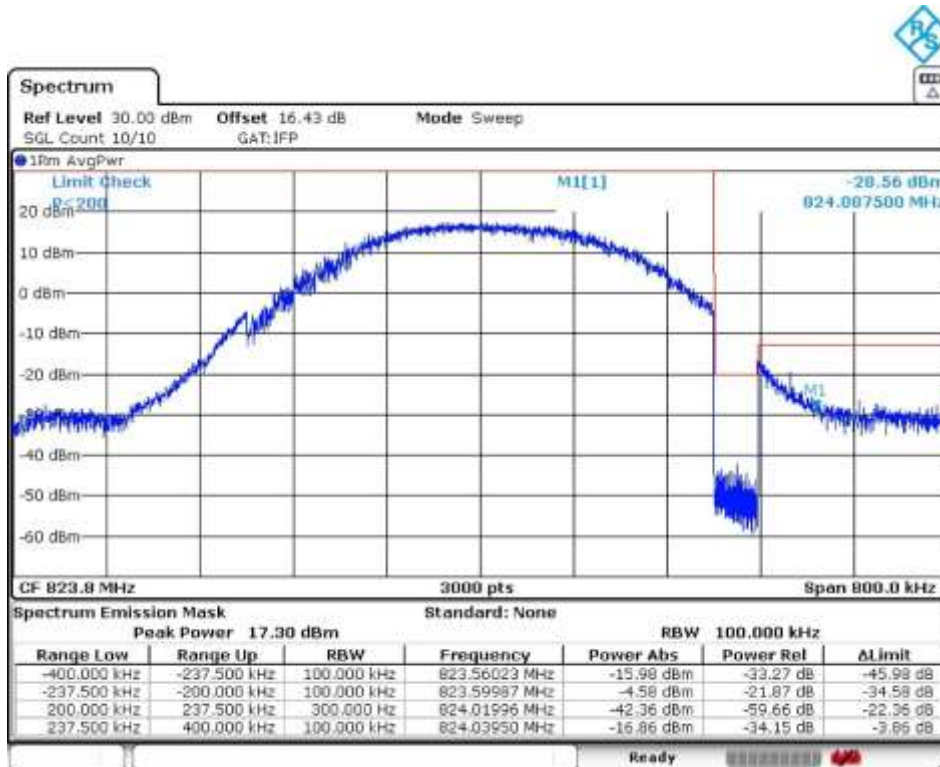

Verdict: PASS

824-849 MHz: NBLoT BAND 5 (Tone 3.75 kHz. $\pi/2$ - BPSK Offset 0 MODULATION)

Lowest Channel:

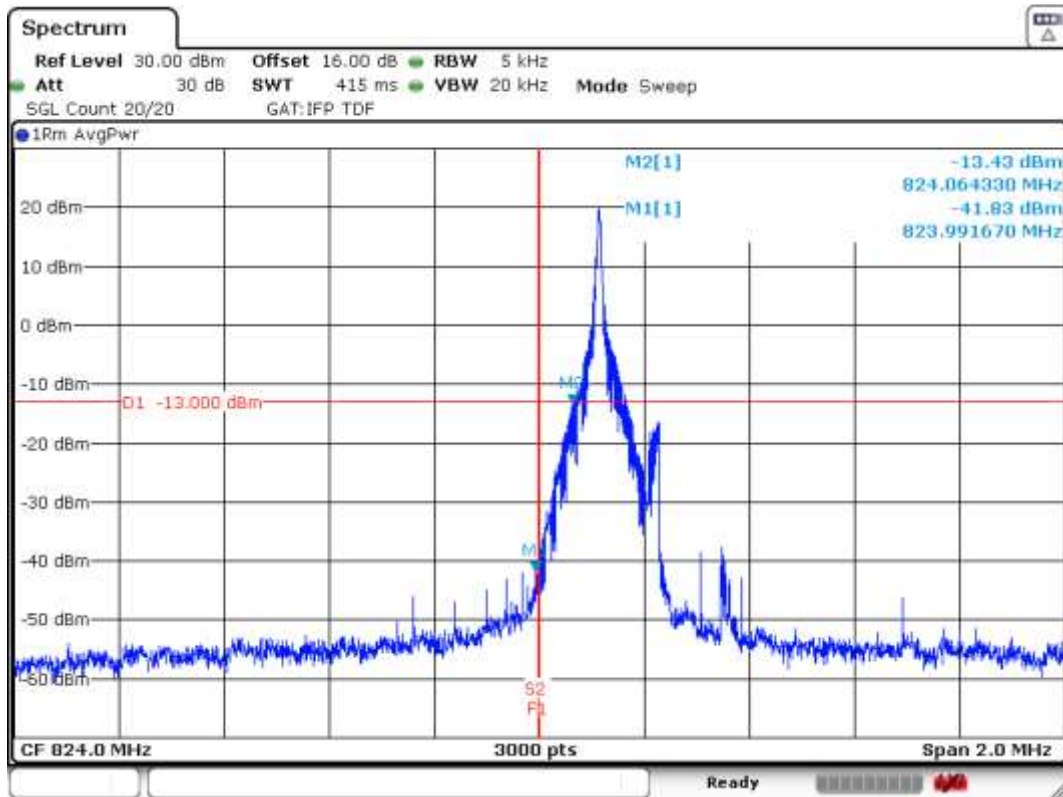

NBLoT BAND 5 (Tone 15 kHz. $\pi/4$ - QPSK Offset 0 MODULATION)

Lowest Channel:

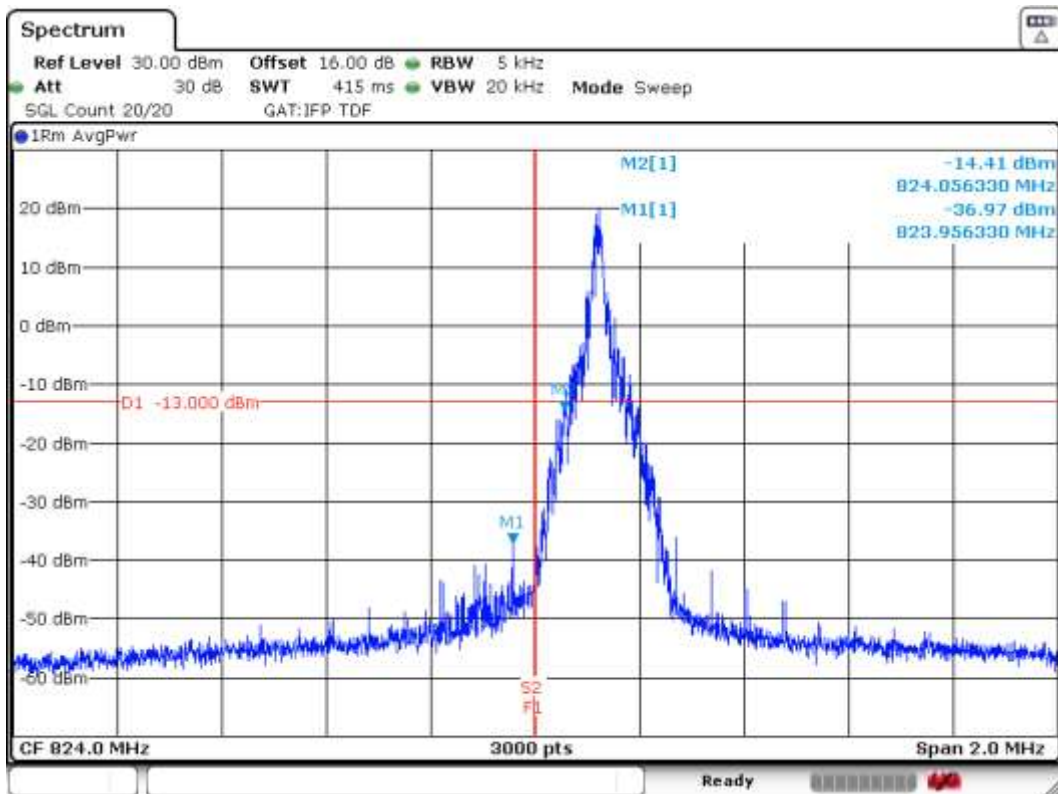

NBLoT BAND 5 (12 Tones 15 kHz. $\pi/4$ - QPSK Offset 0 MODULATION)

Lowest Channel:

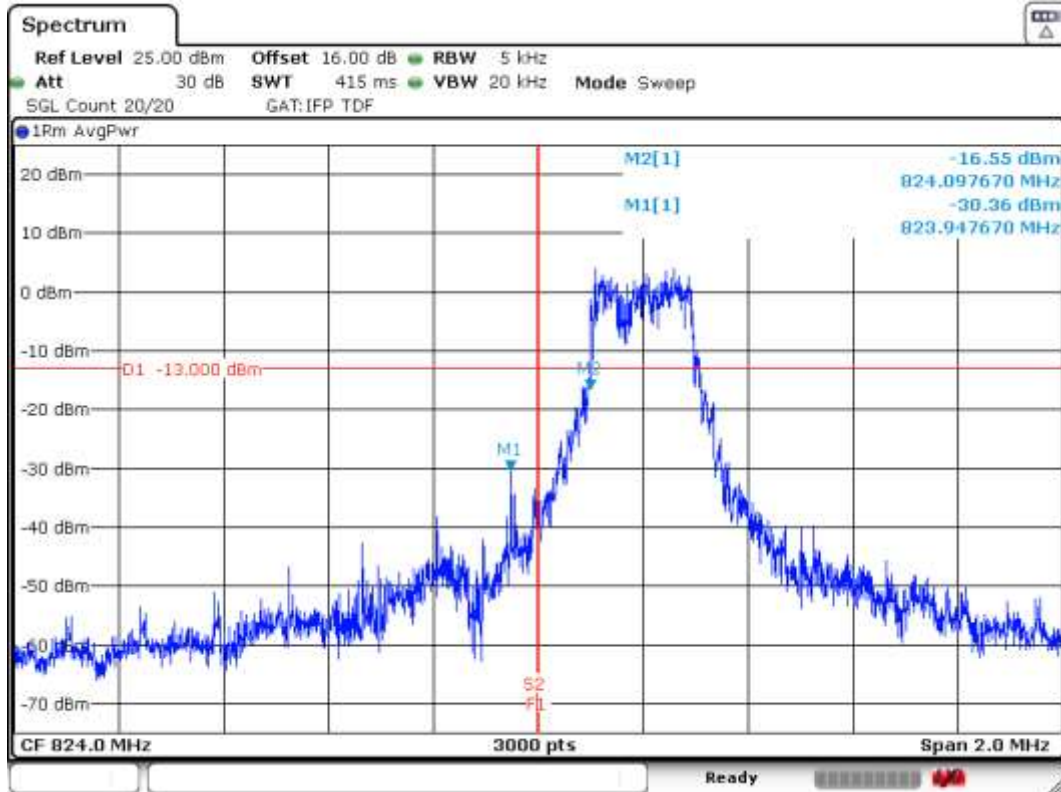

NBLoT BAND 5 (Tone 3.75 kHz. $\pi/2$ - BPSK Offset 47 MODULATION)

Highest Channel:

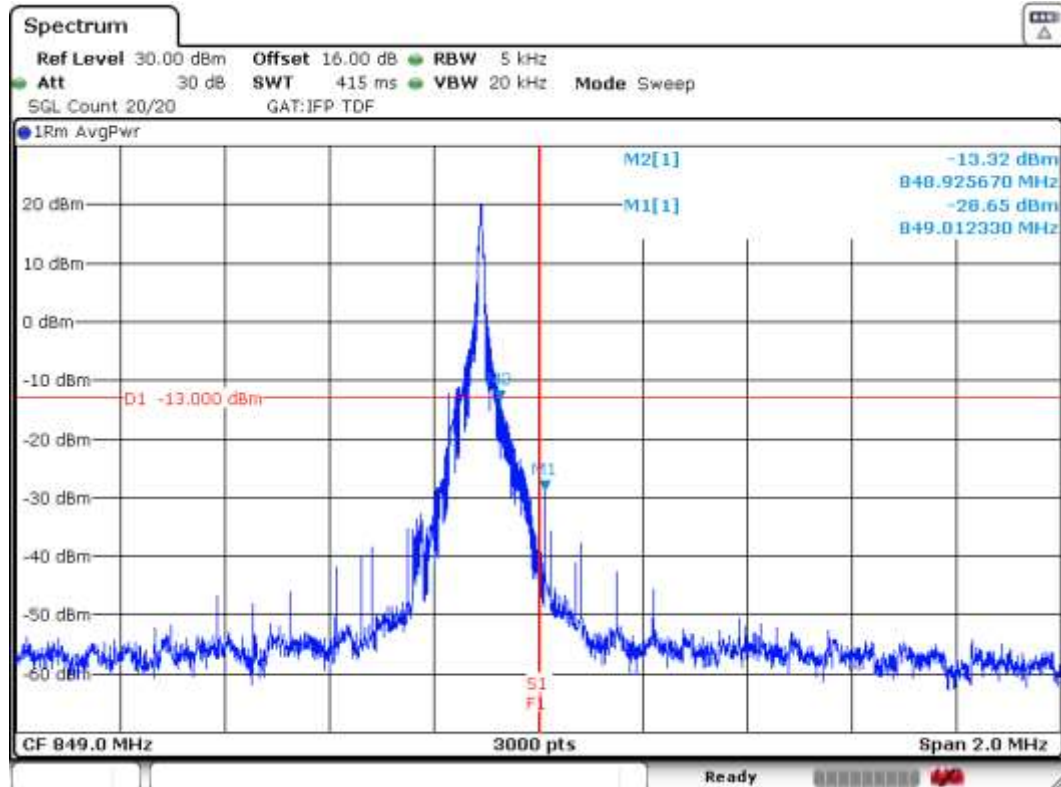

NBLoT BAND 5 (Tone 15 kHz. $\pi/4$ - QPSK Offset 11 MODULATION)

Highest Channel:

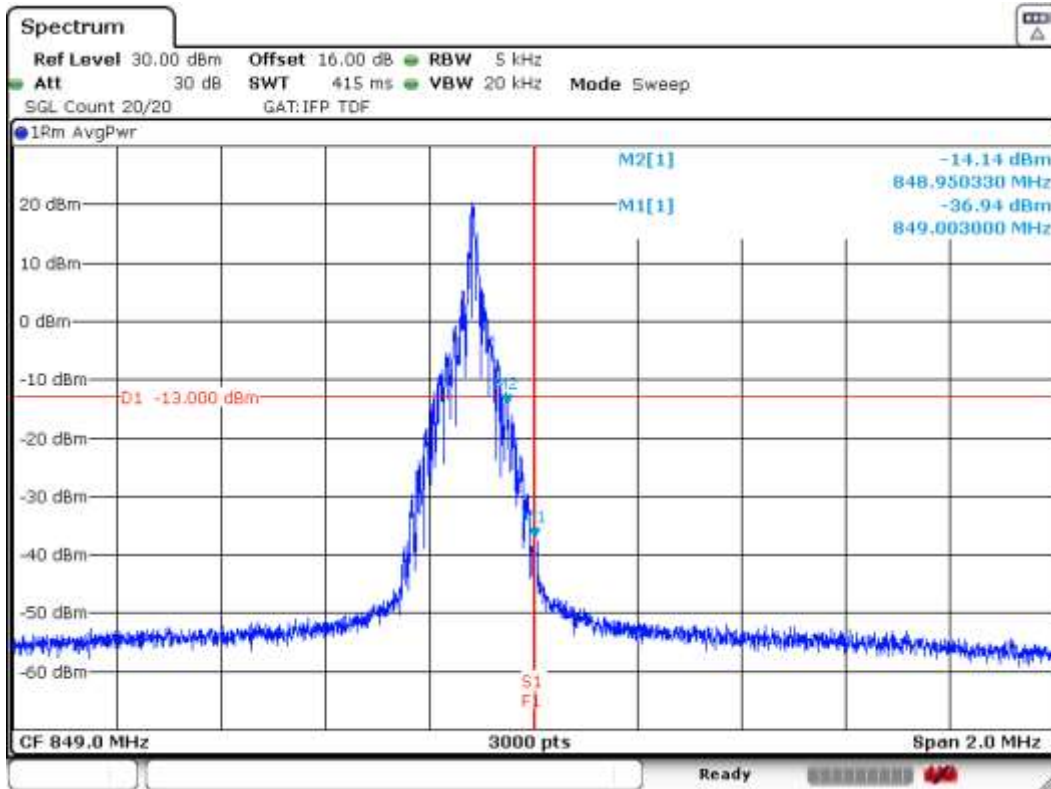

NBLoT BAND 5 (12 Tones 15 kHz. $\pi/4$ - QPSK Offset 0 MODULATION)

Highest Channel:

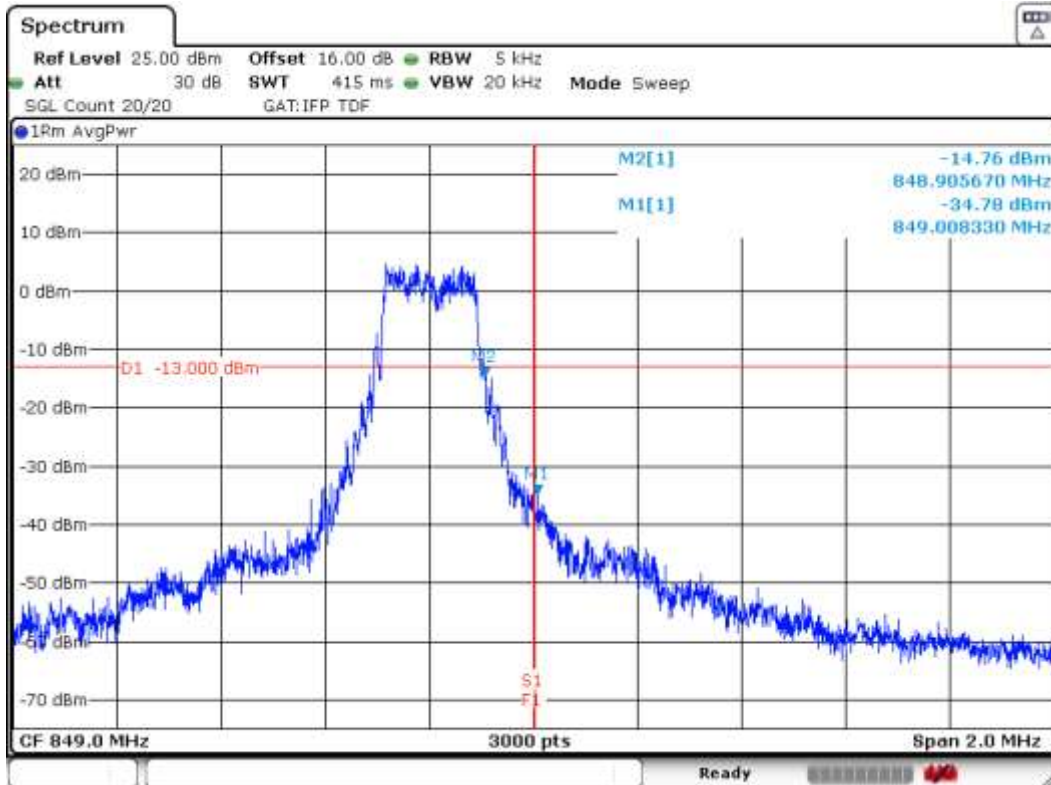

Radiated emissions

SPECIFICATION

FCC § 22.917

RSS-132. Clause 5.5.

FCC §2.1051, §90.691

Emission mask requirements for EA-based systems.

For any frequency removed from the EA licensee's frequency block greater than 37.5 kHz, the power of any emission shall be attenuated below the transmitter power (P) in watts by at least $43 + 10\log_{10}(P)$ decibels or 80 decibels, whichever is the lesser attenuation, where f is the frequency removed from the center of the outer channel in the block in kilohertz and where f is greater than 37.5 kHz.

METHOD

The measurement was performed with the EUT inside an anechoic chamber. The spectrum was scanned from 30 MHz to at least the 10th harmonic of the highest frequency generated within the equipment.

The EUT was placed on a 1 meter high non-conductive stand at a 3 meter distance from the measuring antenna.

Detected emissions were maximized at each frequency by rotating the EUT and adjusting the measuring antenna height and polarization. The maximum field strength (dB μ V/m) is measured and recorded.

The maximum field strength (dB μ V/m) of each detected emission at less than 20 dB respect to the limit is converted to an equivalent EIRP level (dBm) according to ANSI C63.26 with the formula:

$EIRP (dBm) = E (dB\mu V/m) + 20\log(D) - 104.8$; where D is the measurement distance (in the far field region) in m. D = 3 m

Measurement Limit:

According to specification. the power of emissions shall be attenuated below the transmitter power (P) by a factor of at least $43 + 10 \log (P)$ dB. P in watts.

At P_o transmitting power. the specified minimum attenuation becomes $43+10\log (P_o)$. and the level in dBm relative P_o becomes:

$P_o (dBm) - [43 + 10 \log (P_o \text{ in mwatts}) - 30] = - 13 \text{ dBm}$

TEST SETUP

Radiated measurements below 1 GHz.

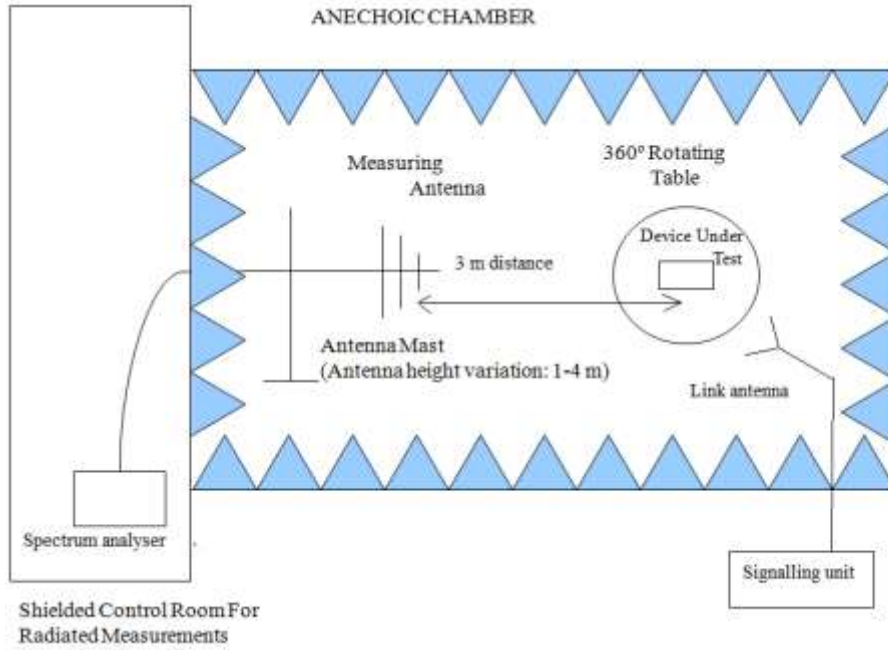

Radiated measurements above 1 GHz.

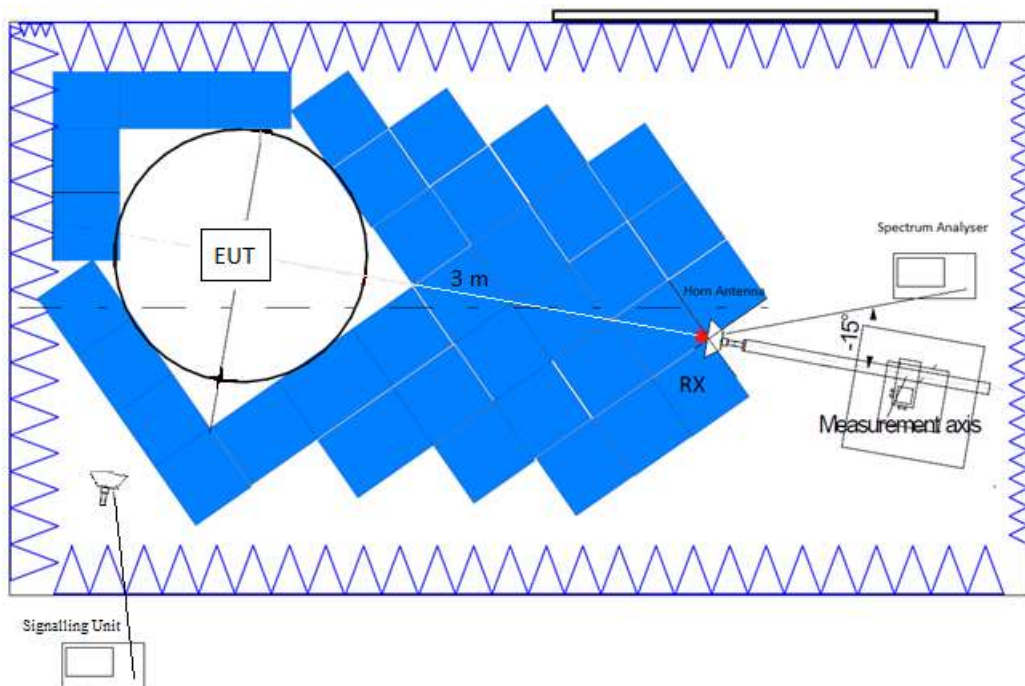

RESULTS

2G Band 850 MHz:

GPRS and EDGE Modulations:

A preliminary scan determined the Tel1 antenna and the GPRS modulation as the worst case. The following tables and plots show the results for the worst case modulation.

- LOW CHANNEL:

Frequency range 30 MHz - 1 GHz

No spurious frequencies at less than 20 dB below the limit.

Frequency range 1 – 8.5 GHz

No spurious frequencies at less than 20 dB below the limit.

- MIDDLE CHANNEL:

Frequency range 30 MHz - 1 GHz

No spurious frequencies at less than 20 dB below the limit.

Frequency range 1 – 8.5 GHz

No spurious frequencies at less than 20 dB below the limit.

- HIGH CHANNEL:

Frequency range 30 MHz - 1 GHz

No spurious frequencies at less than 20 dB below the limit.

Frequency range 1 – 8.5 GHz

No spurious frequencies at less than 20 dB below the limit.

Measurement uncertainty (dB)	<±4.65 for $f < 1\text{GHz}$ <±4.98 for $f \geq 1\text{GHz}$ up to 10 GHz
------------------------------	--

Verdict: PASS

NBloT:

814-824MHz Band:

Preliminary measurements determined that 1 tone of 15kHz (BPSK) as the worst case. The results in the next tables shows the results for this configuration.

1. CHANNEL: LOWEST

Frequency range 30 MHz-1000 MHz.

No radiated spurious signals were detected at less than 20 dB respect to the limit.

Frequency range 1 GHz-8.5 GHz.

No radiated spurious signals were detected at less than 20 dB respect to the limit.

2. CHANNEL: MIDDLE

Frequency range 30 MHz-1000 MHz.

No radiated spurious signals were detected at less than 20 dB respect to the limit.

Frequency range 1 GHz-8.5 GHz.

No radiated spurious signals were detected at less than 20 dB respect to the limit.

3. CHANNEL: HIGHEST

Frequency range 30 MHz-1000 MHz.

No radiated spurious signals were detected at less than 20 dB respect to the limit.

Frequency range 1 GHz-8.5 GHz.

No radiated spurious signals were detected at less than 20 dB respect to the limit.

Measurement uncertainty (dB)	<±4.65 for f < 1GHz <±4.98 for f ≥ 1 GHz up to 10 GHz
------------------------------	--

Verdict: PASS

824-849MHz Band:

Preliminary measurements determined that 1 tone of 15kHz (BPSK) as the worst case. The results in the next tables shows the results for this configuration.

1. CHANNEL: LOWEST

Frequency range 30 MHz-1000 MHz.

No radiated spurious signals were detected at less than 20 dB respect to the limit.

Frequency range 1 GHz-8.5 GHz.

No radiated spurious signals were detected at less than 20 dB respect to the limit.

2. CHANNEL: MIDDLE

Frequency range 30 MHz-1000 MHz.

No radiated spurious signals were detected at less than 20 dB respect to the limit.

Frequency range 1 GHz-8.5 GHz.

No radiated spurious signals were detected at less than 20 dB respect to the limit.

3. CHANNEL: HIGHEST

Frequency range 30 MHz-1000 MHz.

No radiated spurious signals were detected at less than 20 dB respect to the limit.

Frequency range 1 GHz-8.5 GHz.

No radiated spurious signals were detected at less than 20 dB respect to the limit.

Measurement uncertainty (dB)	<±4.65 for $f < 1\text{GHz}$ <±4.98 for $f \geq 1\text{GHz}$ up to 10 GHz
------------------------------	--

Verdict: PASS

**2G Band 850 MHz:
 FREQUENCY RANGE 30 MHz - 1 GHz**

GPRS MODULATION.

- Lowest Channel:

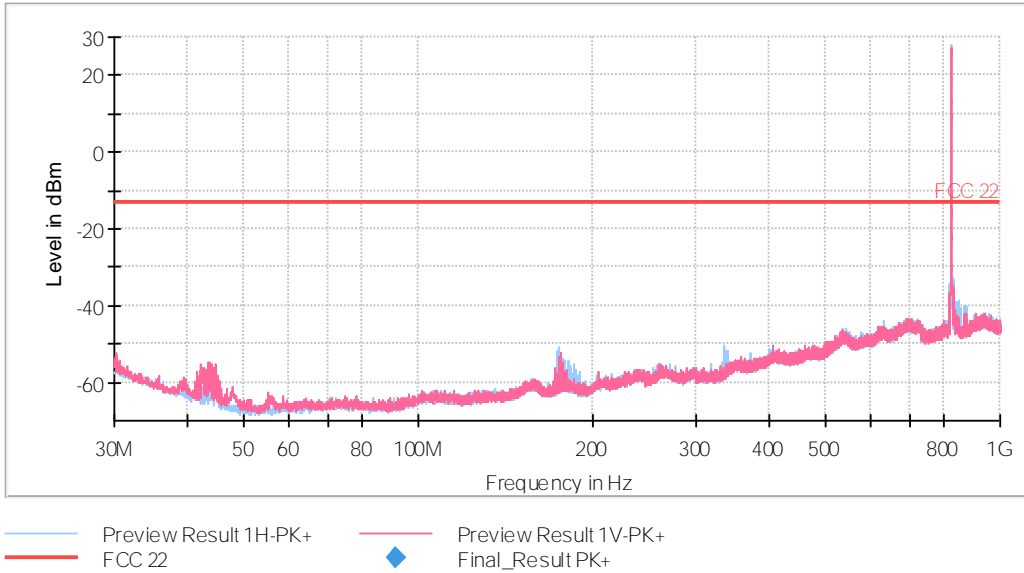

The peak above the limit is the carrier frequency.

- Middle Channel:

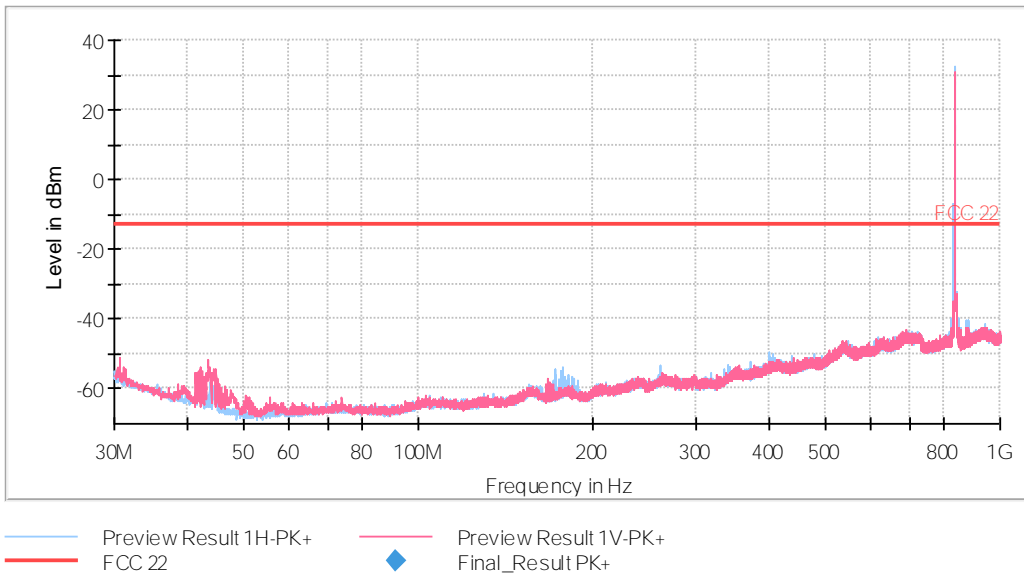

The peak above the limit is the carrier frequency.

- Highest Channel:

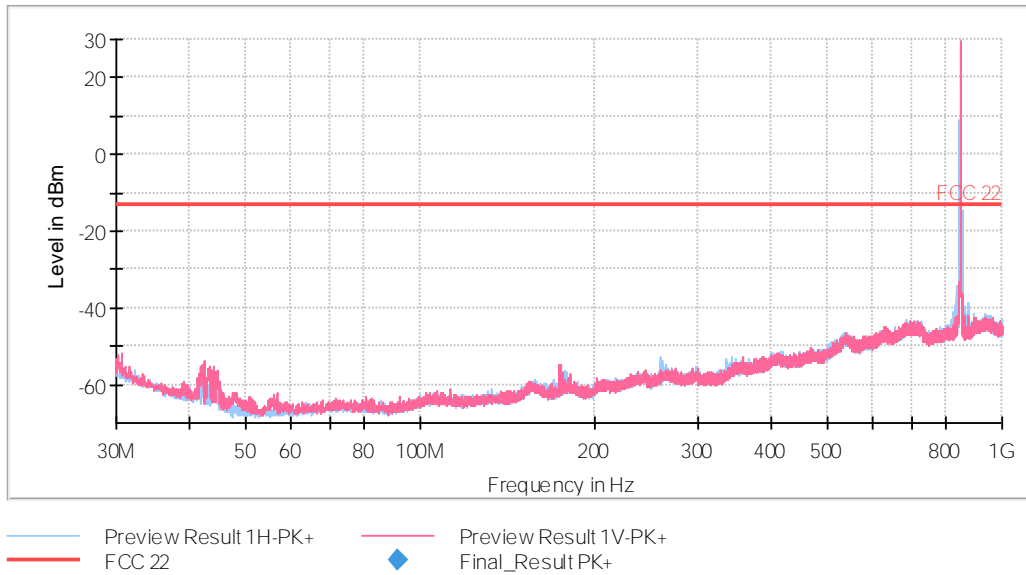

The peak above the limit is the carrier frequency.

FREQUENCY RANGE 1 – 8.5 GHz

GPRS MODULATION.

- Lowest Channel:

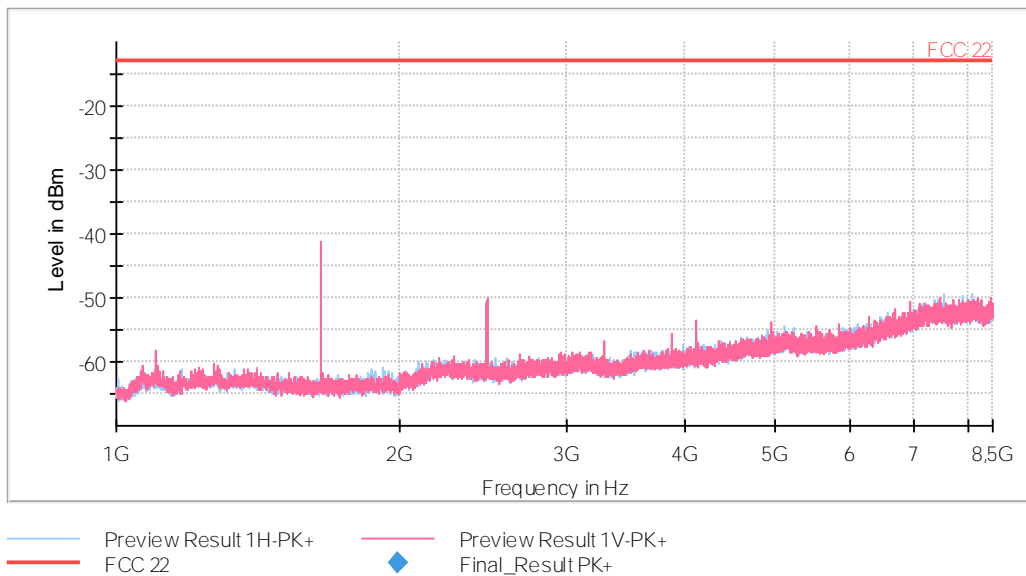

- Middle Channel:

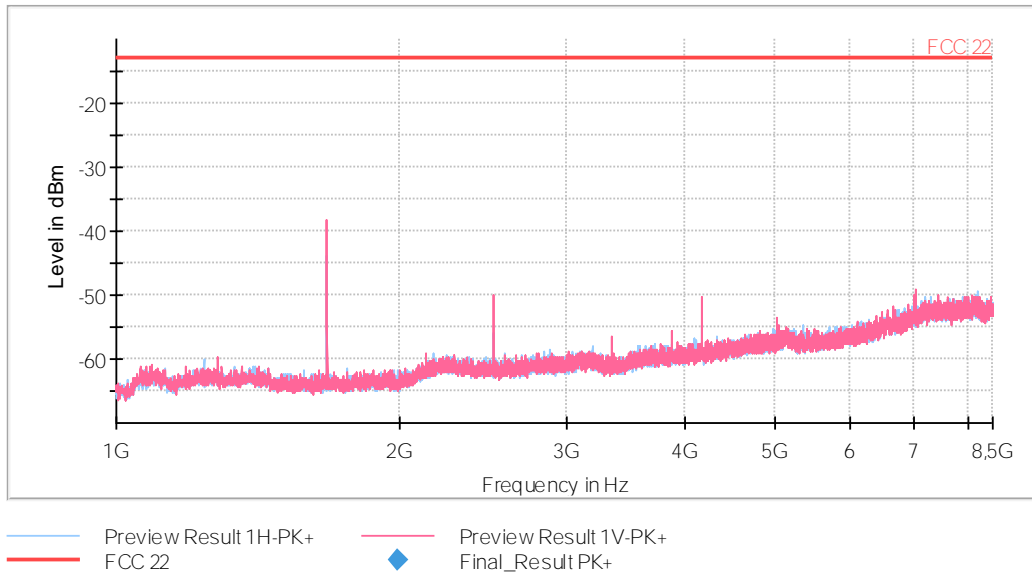

- Highest Channel:

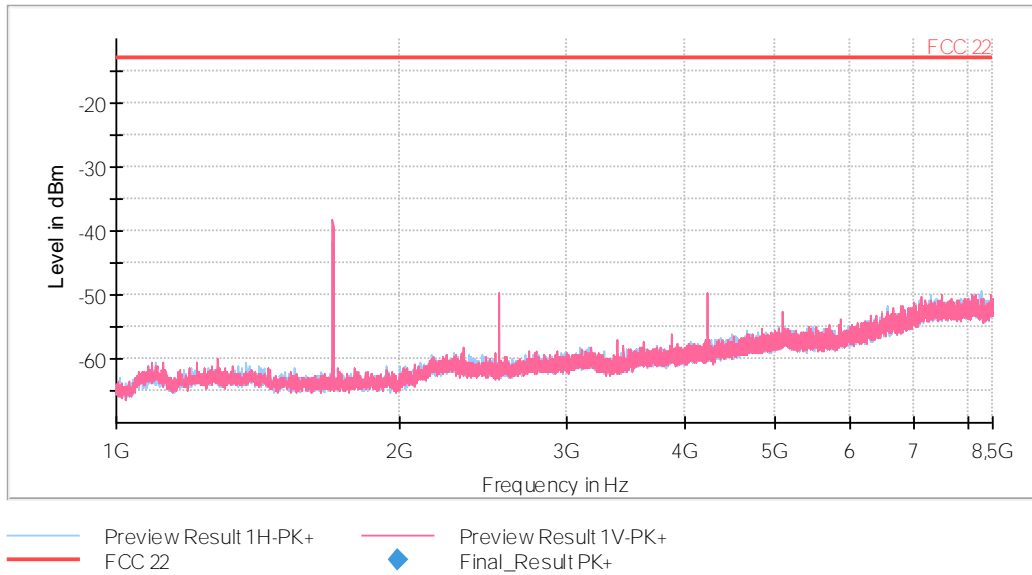

814-824MHz Band:

FREQUENCY RANGE 30 MHz-1000 MHz.

CHANNEL: LOWEST

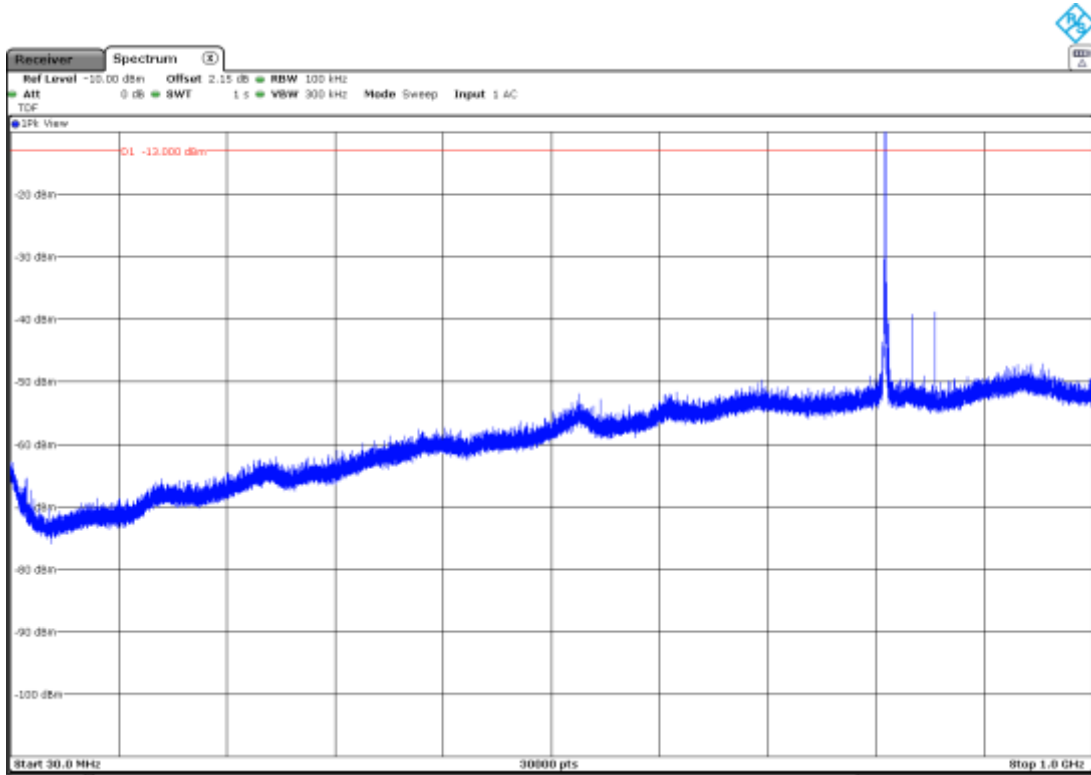

Note: The peak above the limit is the carrier frequency. The peak at 859MHz corresponds to the downlink signal
CHANNEL: MIDDLE

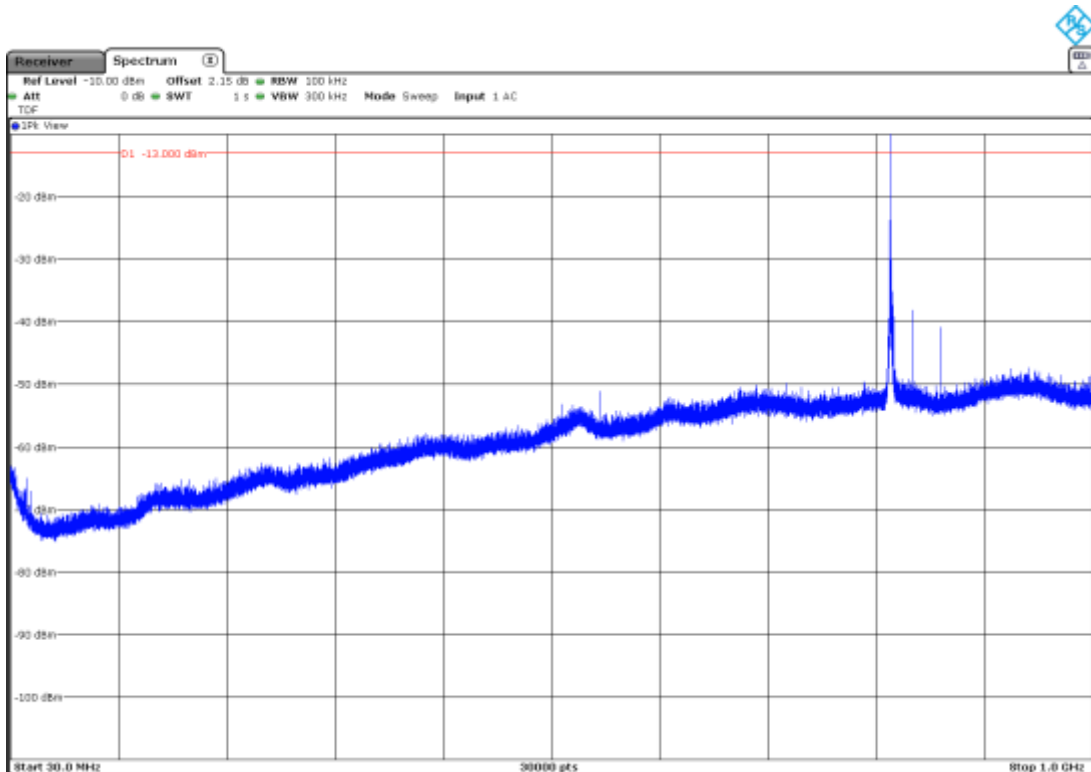

Note: The peak above the limit is the carrier frequency. The peak at 864MHz corresponds to the downlink signal

CHANNEL: HIGHEST

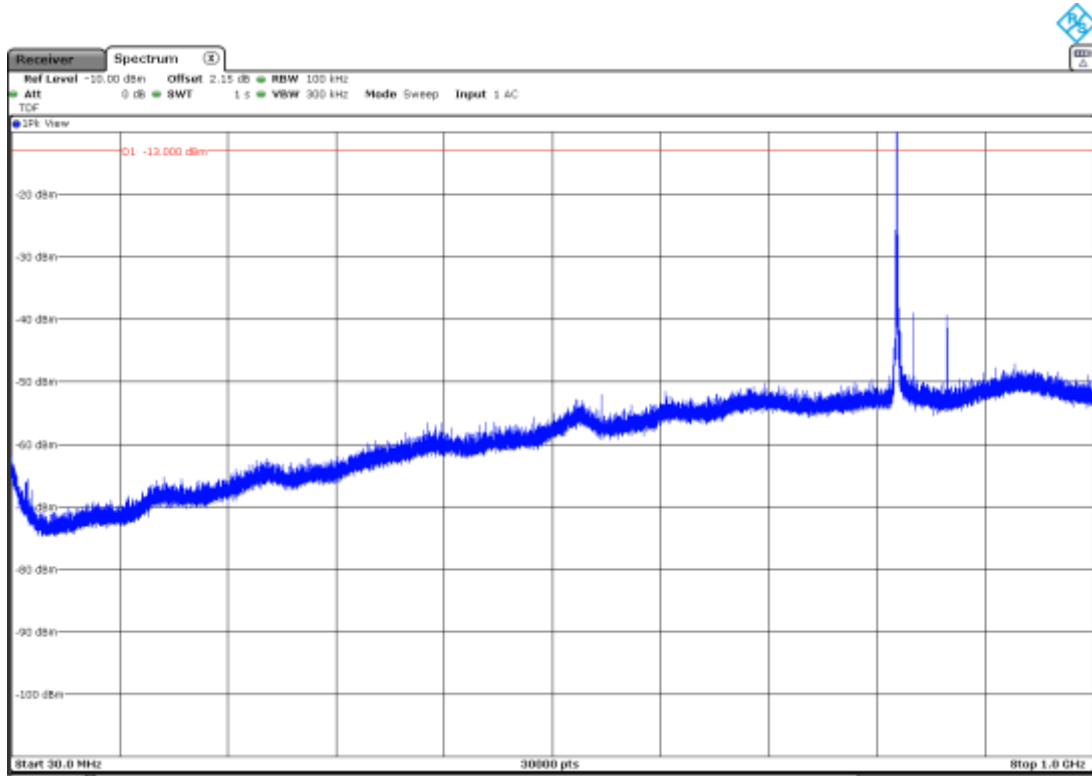

Note: The peak above the limit is the carrier frequency. The peak at 869MHz corresponds to the downlink signal

FREQUENCY RANGE 1 GHz to 8.5 GHz.

CHANNEL: LOWEST

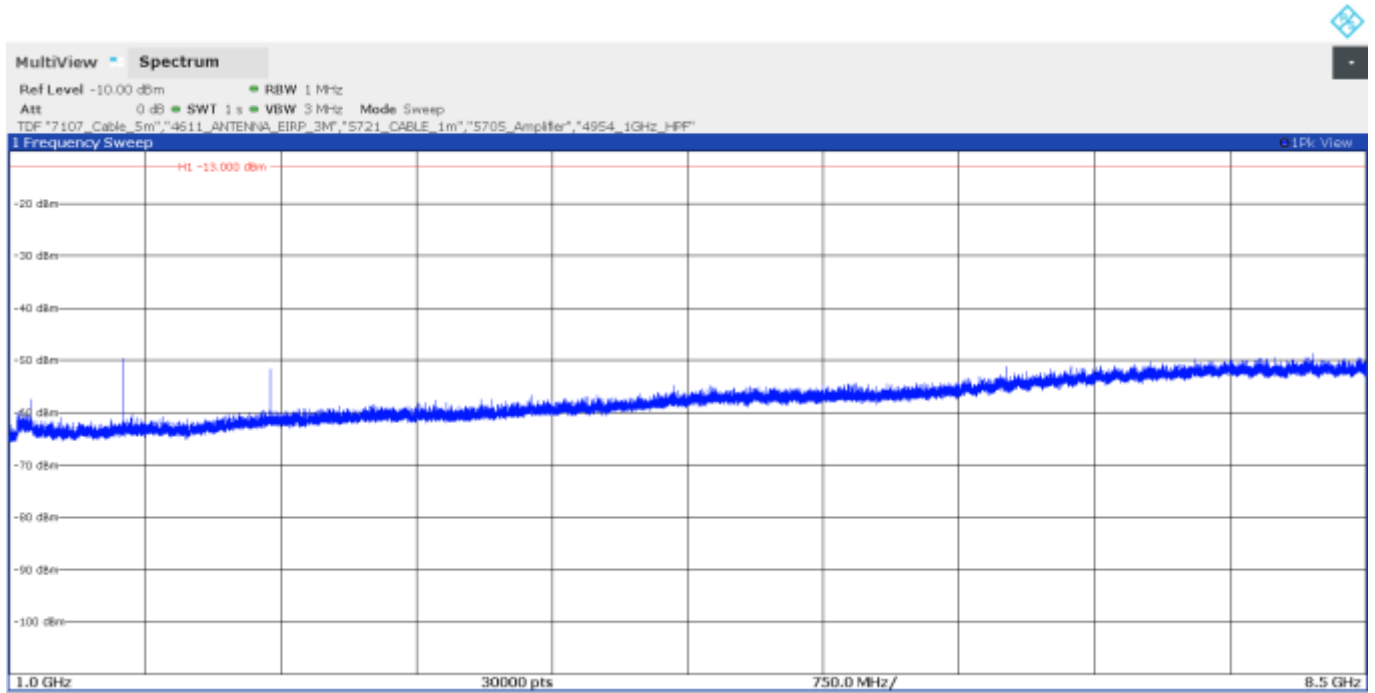

CHANNEL: MIDDLE

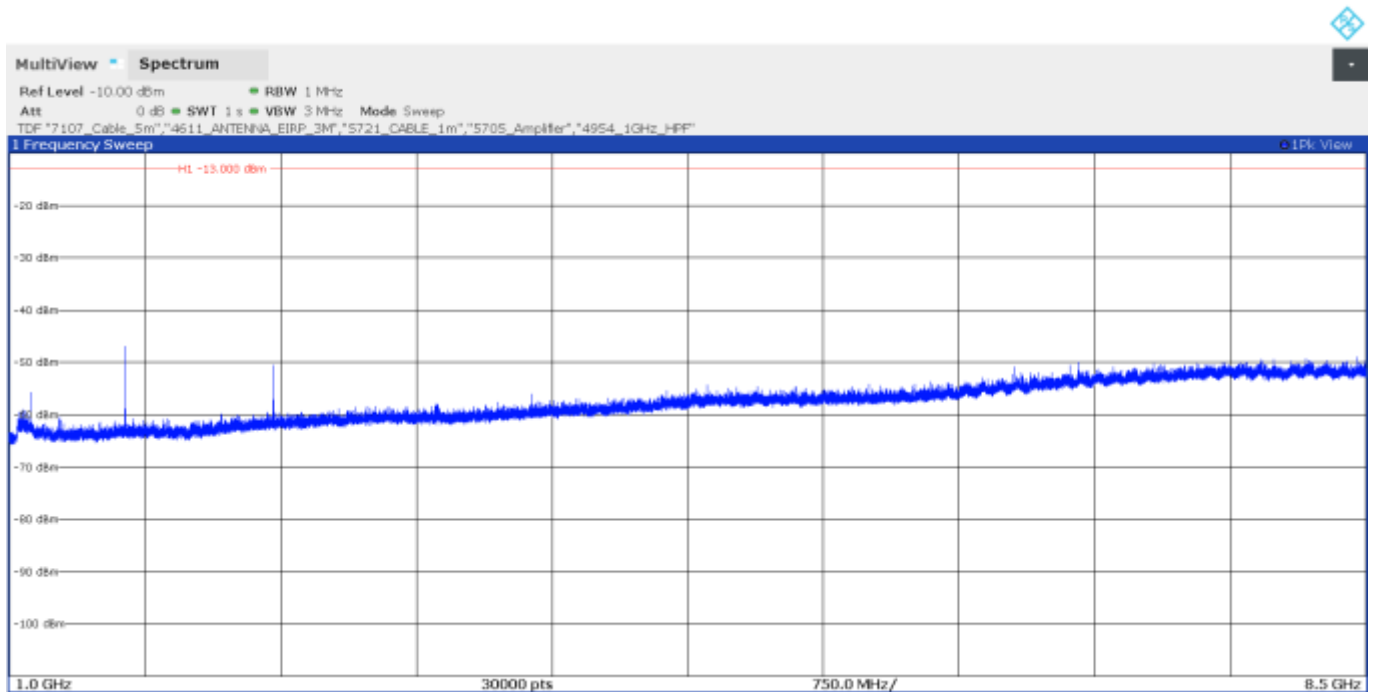

CHANNEL: HIGHEST

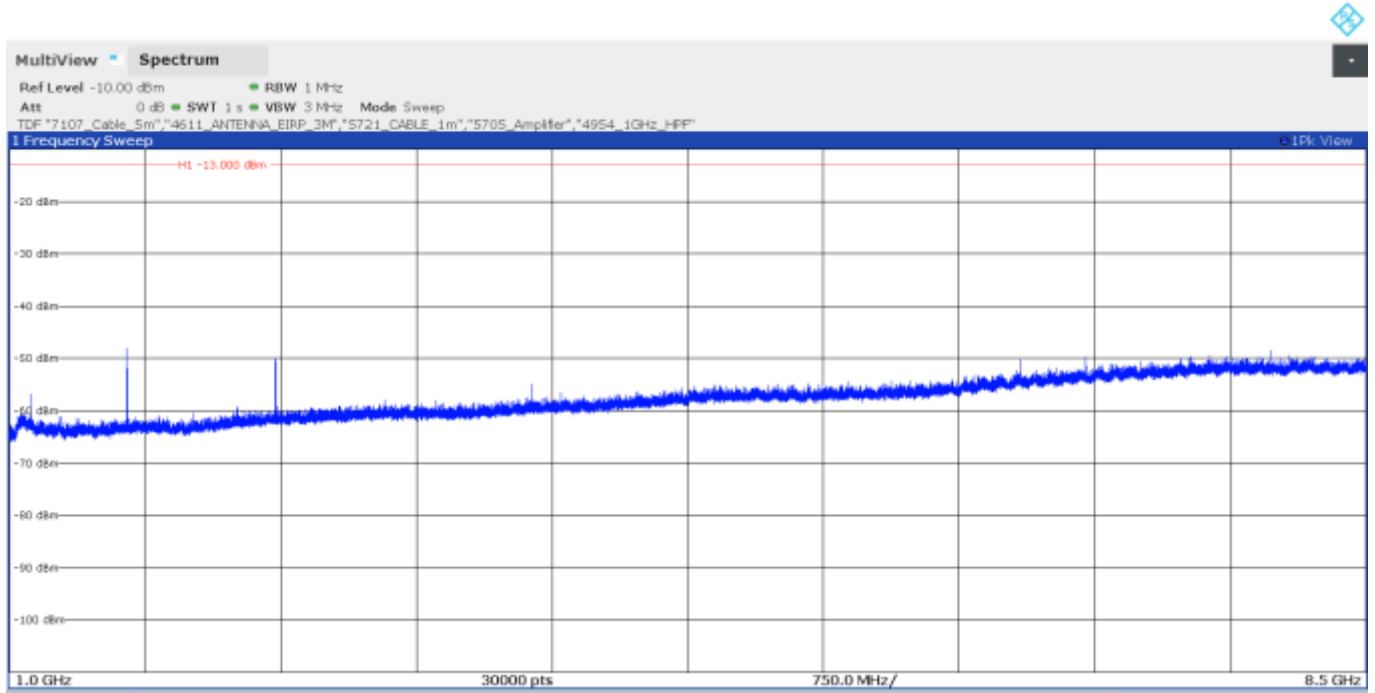

824-849MHz Band:

FREQUENCY RANGE 30 MHz-1000 MHz.

CHANNEL: LOWEST

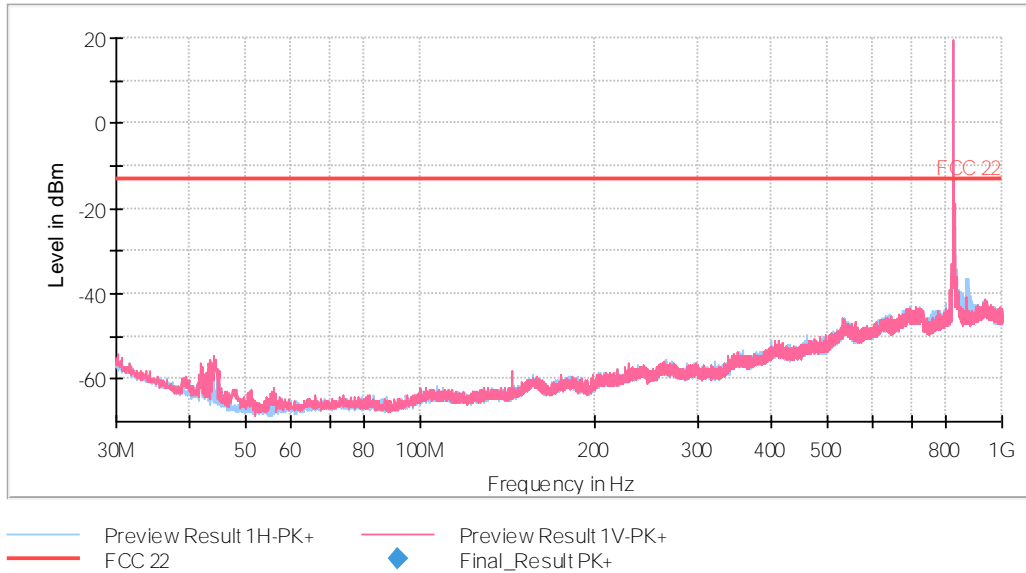

Note: The peak above the limit is the carrier frequency.

CHANNEL: MIDDLE

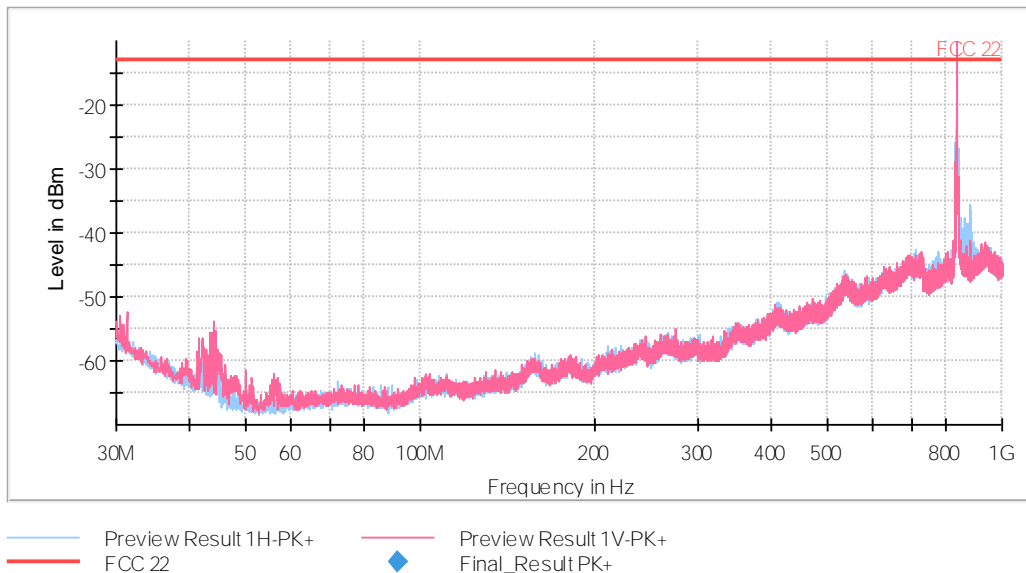

Note: The peak above the limit is the carrier frequency.

CHANNEL: HIGHEST

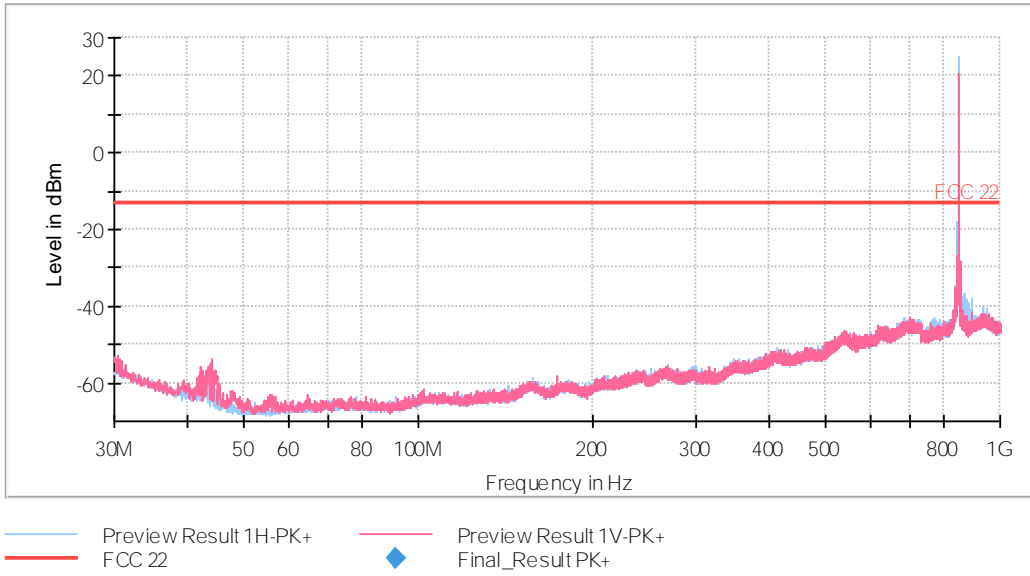

Note: The peak above the limit is the carrier frequency.

FREQUENCY RANGE 1 GHz to 8.5 GHz.

CHANNEL: LOWEST

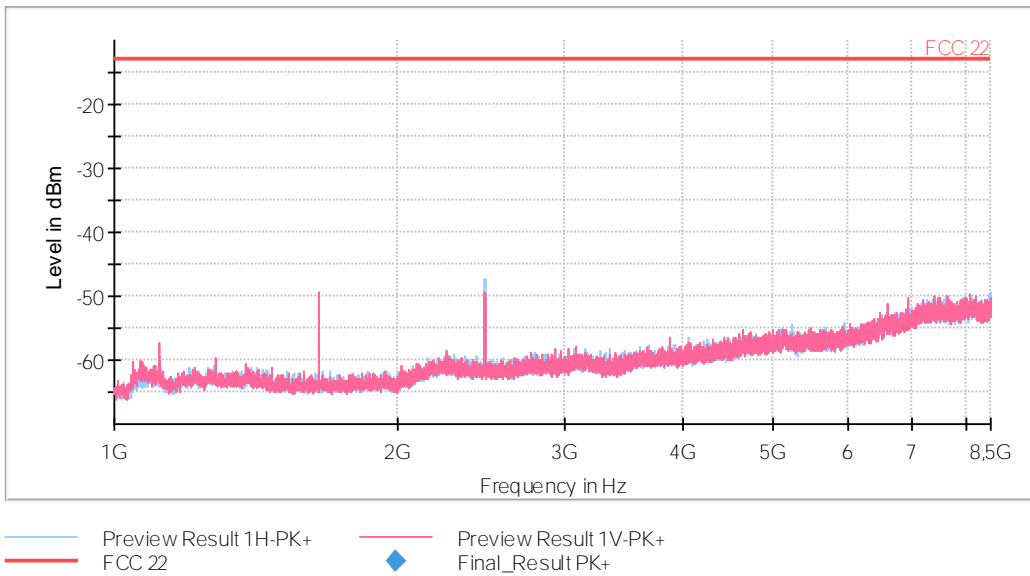

CHANNEL: MIDDLE

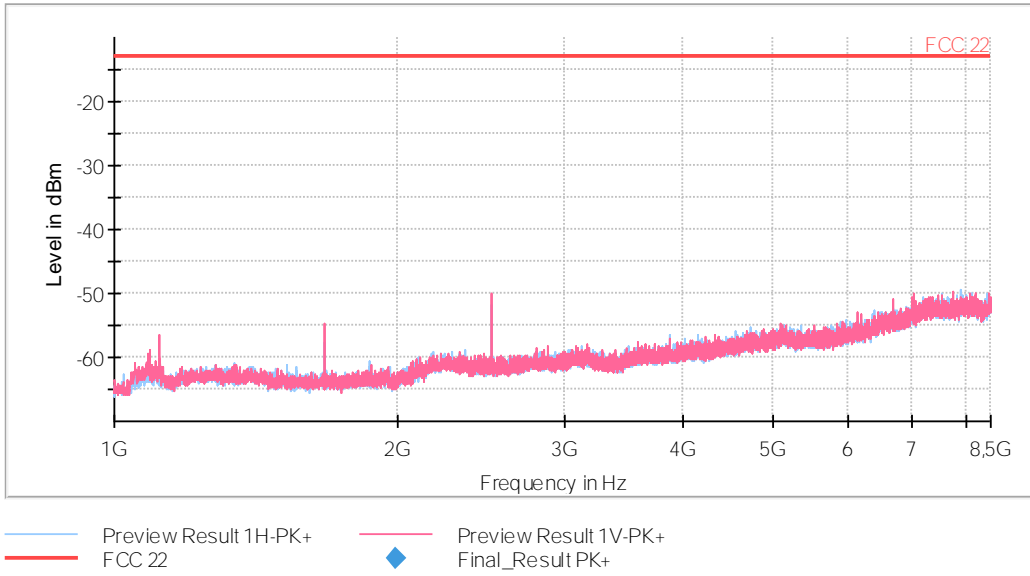

CHANNEL: HIGHEST

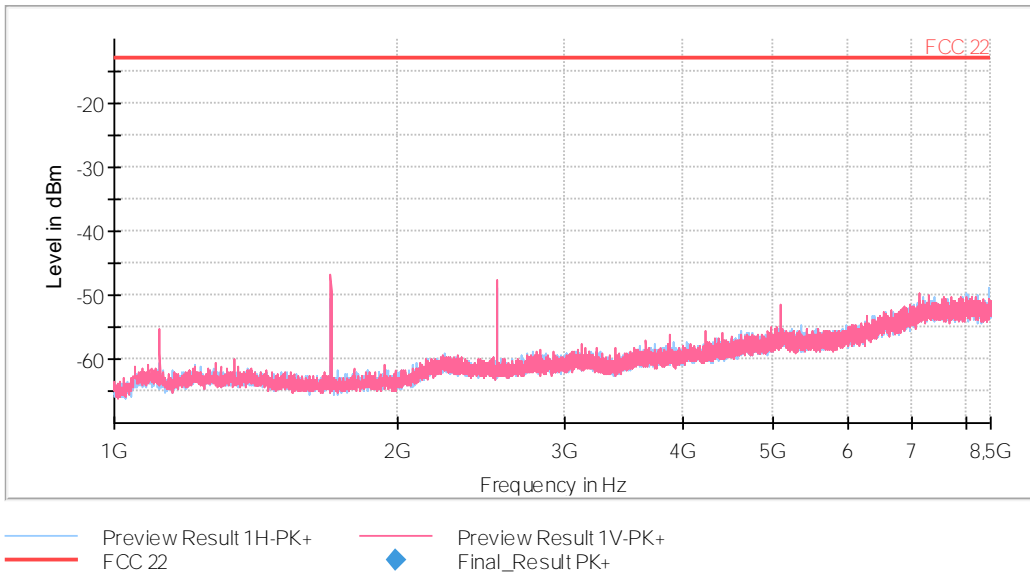

Appendix B: Test results for FCC Part 24 / RSS-133

INDEX

TEST CONDITIONS.....	97
RF Output Power	98
Frequency Stability	109
Modulation Characteristics	113
Occupied Bandwidth.....	116
Spurious emissions at antenna terminals	127
Spurious emissions at antenna terminals at Block Edges.....	135
Radiated emissions	142

TEST CONDITIONS

Vnominal = 3.8 Vdc

Type of power supply = DC Voltage from external power supply

Type of antenna = External antenna.

Declared Gain for antenna = +2.15 dBi.

TEST FREQUENCIES:

2G Band 1900 MHz. GPRS and EDGE MODULATIONS:

Lowest channel (512): 1850.2 MHz

Middle channel (662): 1880.2 MHz

Highest channel (810): 1909.8 MHz

NBLoT. $\pi/2$ - BPSK AND $\pi/4$ - QPSK MODULATION (BAND 2)

Channel (Frequency. MHz)		
Lowest	Middle	Highest
18602 (1850.2)	18900 (1880)	19198 (1909.8)

NOTE: Band 2 is completely included in band 25. so the channels of band 25 were tested to give conformity to the assigned block.

NBLoT. $\pi/2$ - BPSK AND $\pi/4$ - QPSK MODULATION (BAND 25)

Channel (Frequency. MHz)		
Lowest	Middle	Highest
26042 (1850.2)	26365 (1882.5)	26688 (1914.8)

RF Output Power

SPECIFICATION

FCC §2.1046 and §24.232

Mobile/portable stations are limited to 2 Watts (33 dBm) Effective Isotropic Radiated Power (E.I.R.P.).
The peak-to-average ratio (PAR) of the transmission shall not exceed 13 dB.

RSS-133. Clause 6.4.

The peak-to-average power ratio (PAPR) shall not exceed 13 dB for more than 0.1% of the time using a signal corresponding to the highest PAPR during periods of continuous transmission.

METHOD

The conducted RF output power measurements were made at the RF output terminals of the EUT using the power meter of the Universal Radio Communication tester R&S CMW500. selecting maximum transmission power of the EUT and different modes of modulation.

The maximum equivalent isotropically radiated power (e.i.r.p.) is calculated by adding the declared maximum antenna gain (dBi).

The EUT was controlled via the Universal Radio Communication tester R&S CMW500 selecting maximum transmission power of the EUT and different modes of modulation.

TEST SETUP

Conducted average power.



Peak-to-average power ratio (PAPR)

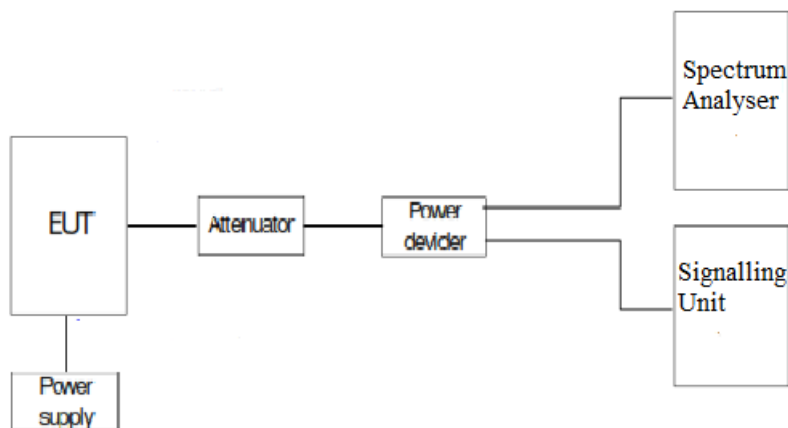

RESULTS

2G Band 1900 MHz :

GPRS MODULATION:

Channel	Lowest	Middle	Highest
Maximum declared antenna gain (dBi)	2.15	2.15	2.15
Measured maximum average power (dBm) at antenna port	30.04	29.81	29.52
Maximum effective isotropically radiated average power E.I.R.P. (dBm)	32.19	31.96	31.67
Peak-to-average ratio (PAR) (dB)	0.41	0.39	0.35
Measurement uncertainty (dB)	<±1.58		

EDGE MODULATION:

Channel	Lowest	Middle	Highest
Maximum declared antenna gain (dBi)	2.15	2.15	2.15
Measured maximum average power (dBm) at antenna port	30.04	29.82	29.50
Maximum effective isotropically radiated average power E.I.R.P. (dBm)	32.19	31.97	31.65
Peak-to-average ratio (PAR) (dB)	0.38	0.37	0.34
Measurement uncertainty (dB)	<±1.58		

NBLoT. BAND 2.

Ch	Freq. (MHz)	Modulation	BW (kHz)	Num. tone	Offset Tone	Average Power (dBm)	PAPR (dB)
26042	1850.2	$\pi/2$ - BPSK	3.75	1	0	23.54	(*)
				1	47	23.52	(*)
			15	1	0	23.87	(*)
				1	11	23.78	(*)
		$\pi/4$ - QPSK	3.75	1	0	23.60	(*)
				1	47	23.57	(*)
			15	1	0	23.65	(*)
				1	11	23.73	(*)
				3	0	23.11	3.93
				3	6	23.80	3.47
				6	0	22.56	4.81
				6	6	22.53	5.04
12	0	21.95	5.82				
26365	1882.5	$\pi/2$ - BPSK	3.75	1	0	23.64	(*)
				1	47	23.63	(*)
			15	1	0	23.99	(*)
				1	11	23.94	(*)
		$\pi/4$ - QPSK	3.75	1	0	23.70	(*)
				1	47	23.75	(*)
			15	1	0	23.89	(*)
				1	11	23.77	(*)
				3	0	23.32	3.44
				3	6	24.10	3.18
				6	0	22.67	4.66
				6	6	22.77	4.68
12	0	22.11	5.45				
26688	1914.8	$\pi/2$ - BPSK	3.75	1	0	23.54	(*)
				1	47	23.54	(*)
			15	1	0	23.53	(*)
				1	11	23.49	(*)
		$\pi/4$ - QPSK	3.75	1	0	23.61	(*)
				1	47	23.60	(*)
			15	1	0	22.62	(*)
				1	11	22.41	(*)
				3	0	23.16	3.40
				3	6	23.76	3.21
				6	0	22.24	4.54
				6	6	22.30	4.57
12	0	21.66	5.37				

(*): Preliminary measurements determined that 3, 6 or 12 tones of 15kHz as the worst case. The results in the next tables shows the results for this configuration.

NBLoT. BAND 25.

Ch	Freq. (MHz)	Modulation	BW (kHz)	Num. tone	Offset Tone	Average Power (dBm)	PAPR (dB)
26042	1850.2	$\pi/2$ - BPSK	3.75	1	0	22.85	(*)
				1	47	22.82	(*)
			15	1	0	23.21	(*)
				1	11	23.10	(*)
		$\pi/4$ - QPSK	3.75	1	0	22.87	(*)
				1	47	22.89	(*)
			15	1	0	22.98	(*)
				1	11	23.09	(*)
				3	0	22.65	3.97
				3	6	23.11	3.59
				6	0	21.97	4.91
				6	6	21.89	5.03
		12	0	21.31	5.73		
		26365	1882.5	$\pi/2$ - BPSK	3.75	1	0
1	47					22.94	(*)
15	1				0	23.36	(*)
	1				11	23.23	(*)
$\pi/4$ - QPSK	3.75			1	0	23.00	(*)
				1	47	23.02	(*)
	15			1	0	23.29	(*)
				1	11	23.23	(*)
				3	0	22.63	3.41
				3	6	23.42	3.25
				6	0	22.01	4.64
				6	6	21.93	4.63
12	0			21.40	5.37		
26688	1914.8			$\pi/2$ - BPSK	3.75	1	0
		1	47			22.89	(*)
		15	1		0	23.08	(*)
			1		11	22.84	(*)
		$\pi/4$ - QPSK	3.75	1	0	22.97	(*)
				1	47	22.97	(*)
			15	1	0	22.95	(*)
				1	11	22.86	(*)
				3	0	23.16	3.44
				3	6	23.77	3.21
				6	0	22.30	4.54
				6	6	22.18	4.52
		12	0	21.66	5.36		

(*): Preliminary measurements determined that 3, 6 or 12 tones of 15kHz as the worst case. The results in the next tables shows the results for this configuration.

NBLoT BAND 2.

Channel	Measured maximum average power (dBm) at antenna port	Maximum declared antenna gain (dBi)	Maximum equivalent isotropically radiated power (E.I.R.P.) (dBm)	Maximum effective radiated power E.R.P. (dBm)
Lowest	23.57	2.15	25.72	23.57
Middle	23.73	2.15	25.88	23.73
Highest	23.63	2.15	25.78	23.63
Measurement uncertainty (dB)	<±0.941			

NBLoT BAND 25.

Channel	Measured maximum average power (dBm) at antenna port	Maximum declared antenna gain (dBi)	Maximum equivalent isotropically radiated power (E.I.R.P.) (dBm)	Maximum effective radiated power E.R.P. (dBm)
Lowest	22.73	2.15	24.85	22.73
Middle	22.80	2.15	24.92	22.80
Highest	22.86	2.15	24.98	22.86
Measurement uncertainty (dB)	<±0.941			

Verdict: PASS

PEAK-TO-AVERAGE POWER RATIO (PAPR).

2G Band 1900 MHz. GPRS MODULATION.

Lowest Channel :

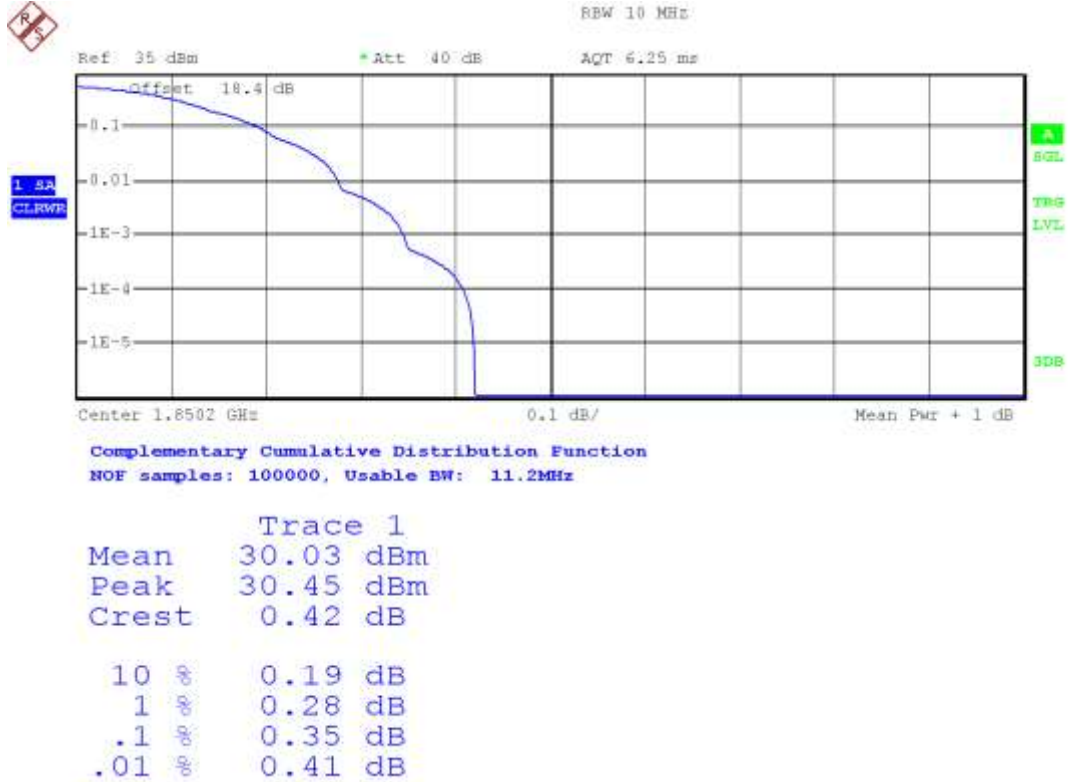

Middle Channel:

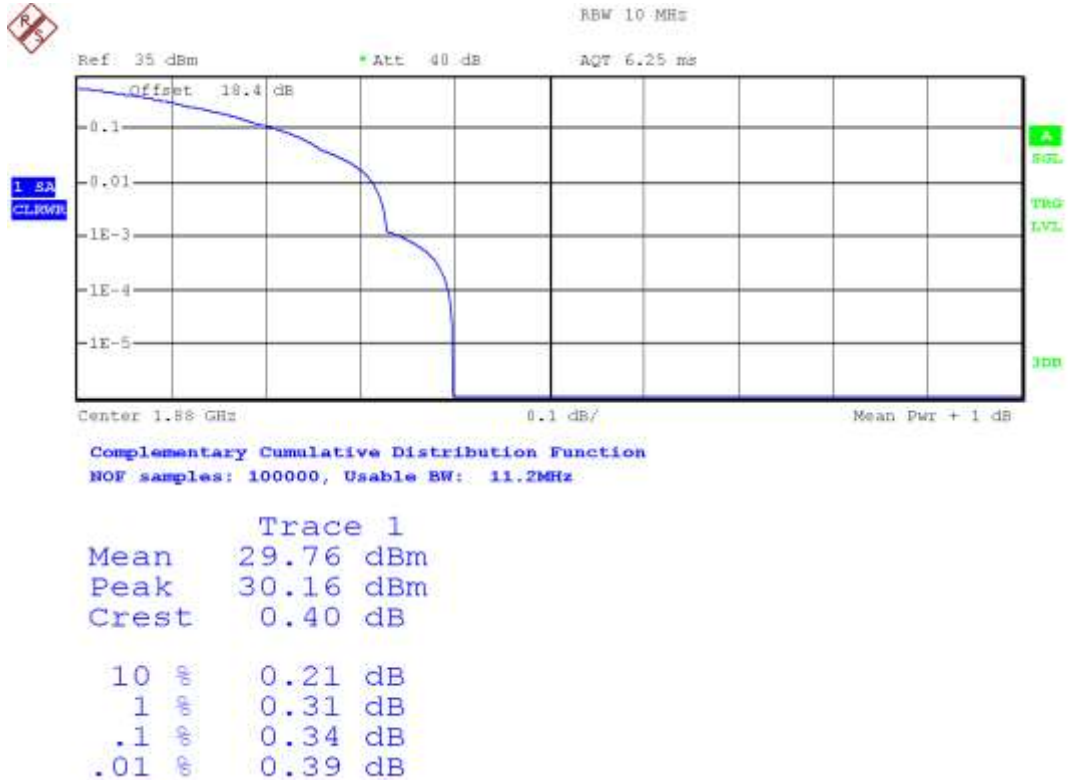

Highest Channel:

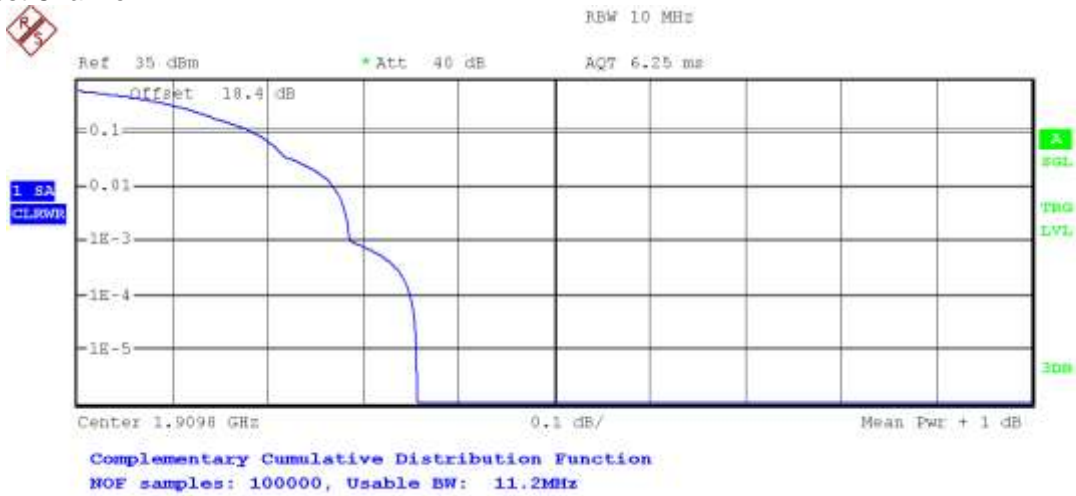

Trace 1	
Mean	29.27 dBm
Peak	29.63 dBm
Crest	0.36 dB
10 %	0.18 dB
1 %	0.27 dB
.1 %	0.29 dB
.01 %	0.35 dB

2G Band 1900 MHz EDGE MODULATION.

Lowest Channel:

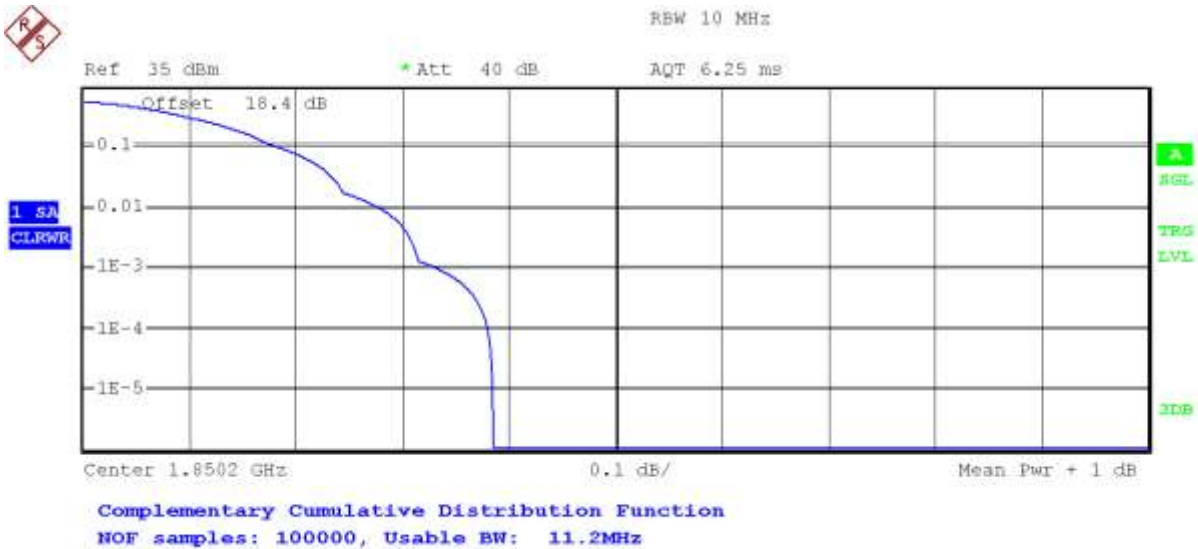

Trace 1	
Mean	30.07 dBm
Peak	30.45 dBm
Crest	0.39 dB
10 %	0.18 dB
1 %	0.28 dB
.1 %	0.33 dB
.01 %	0.38 dB

Middle Channel:



Center 1.88 GHz 0.1 dB/ Mean Pwr + 1 dB
 Complementary Cumulative Distribution Function
 NOF samples: 100000, Usable BW: 11.2MHz

Trace 1	
Mean	29.84 dBm
Peak	30.23 dBm
Crest	0.39 dB
10 %	0.18 dB
1 %	0.27 dB
.1 %	0.32 dB
.01 %	0.37 dB

Highest Channel:

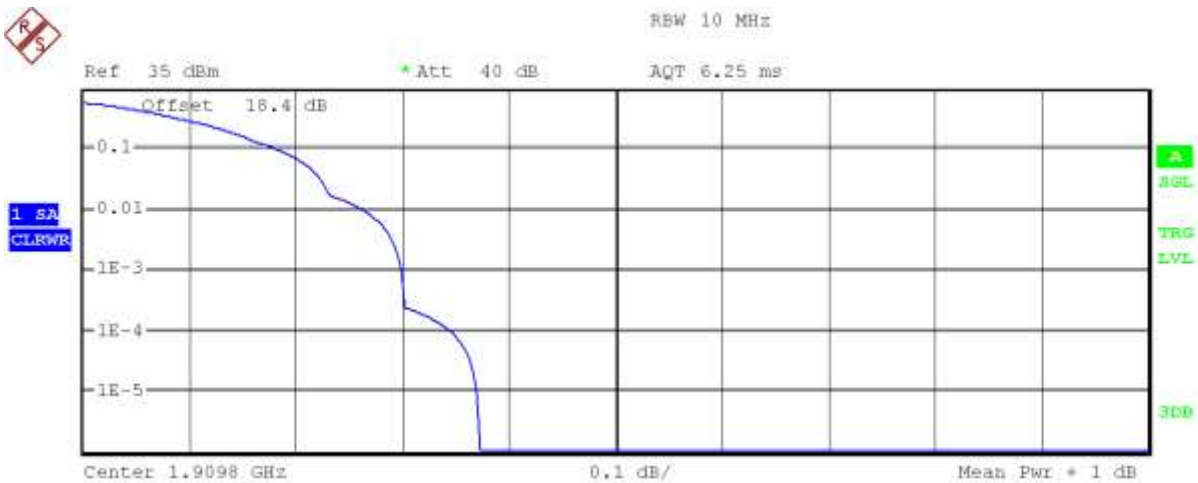

Center 1.9098 GHz 0.1 dB/ Mean Pwr + 1 dB
 Complementary Cumulative Distribution Function
 NOF samples: 100000, Usable BW: 11.2MHz

Trace 1	
Mean	29.33 dBm
Peak	29.70 dBm
Crest	0.37 dB
10 %	0.18 dB
1 %	0.26 dB
.1 %	0.30 dB
.01 %	0.34 dB

NB-IoT BAND 2.

Preliminary measurements determined that 12 tones of 15kHz as the worst case. The results in the next tables shows the results for this configuration.

Channel Low:

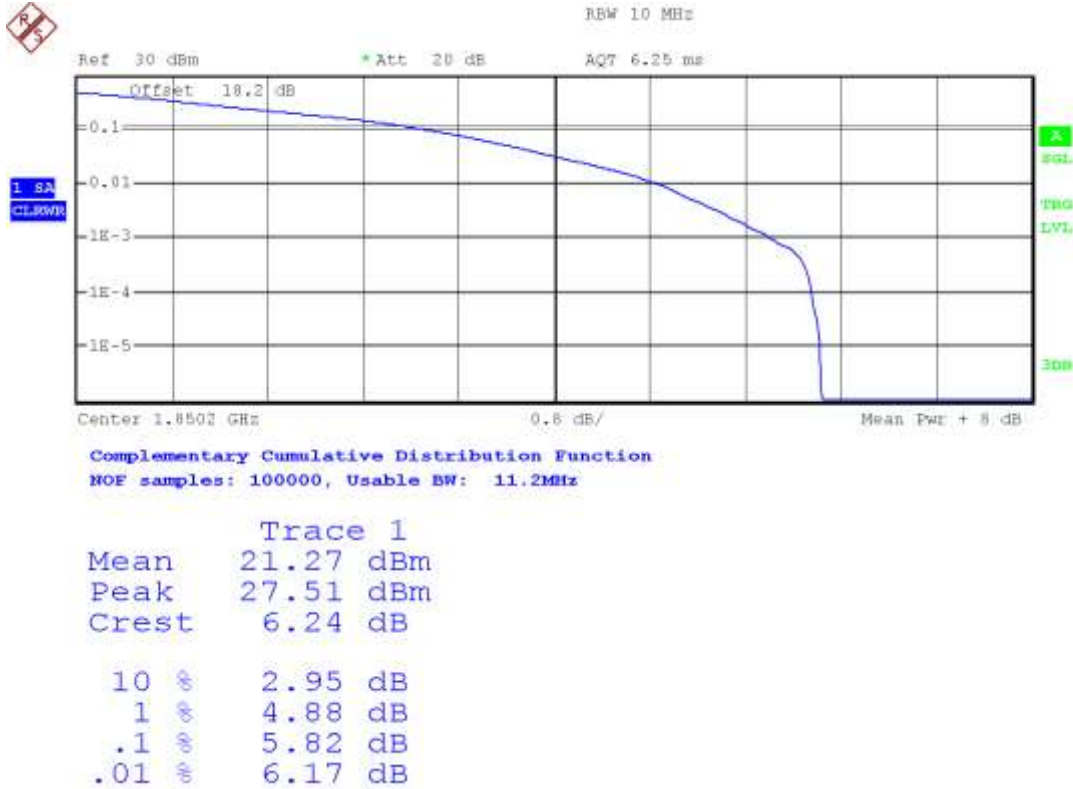

Channel Middle:

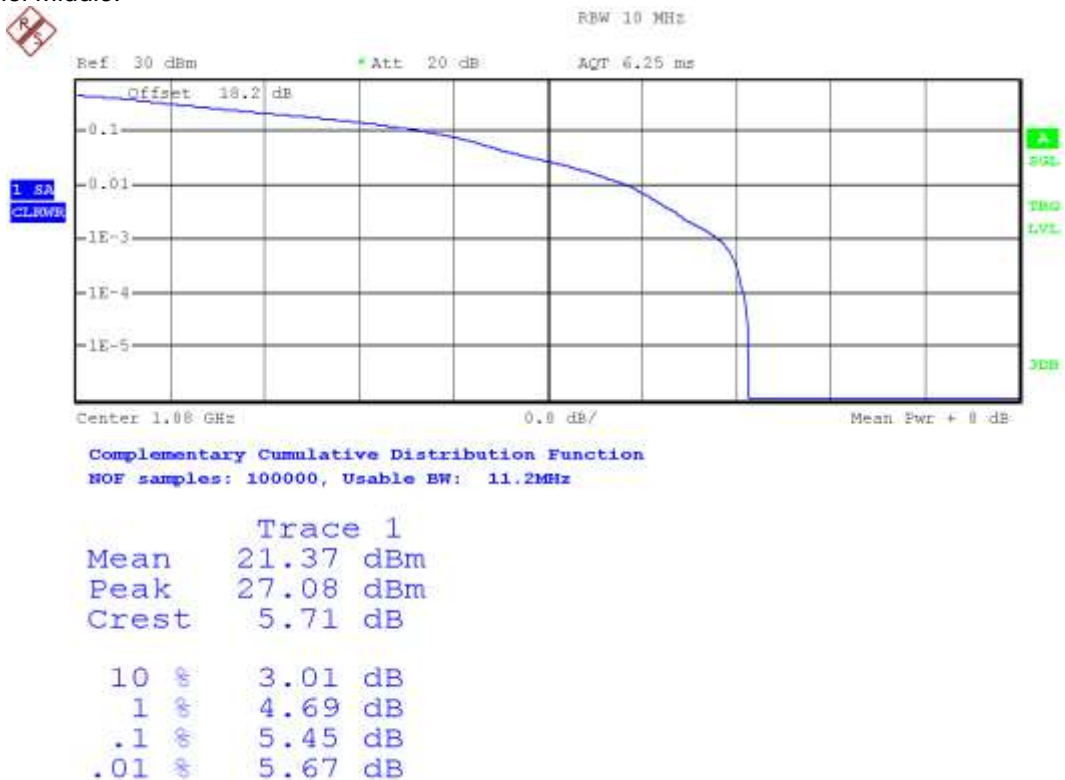

Channel High:

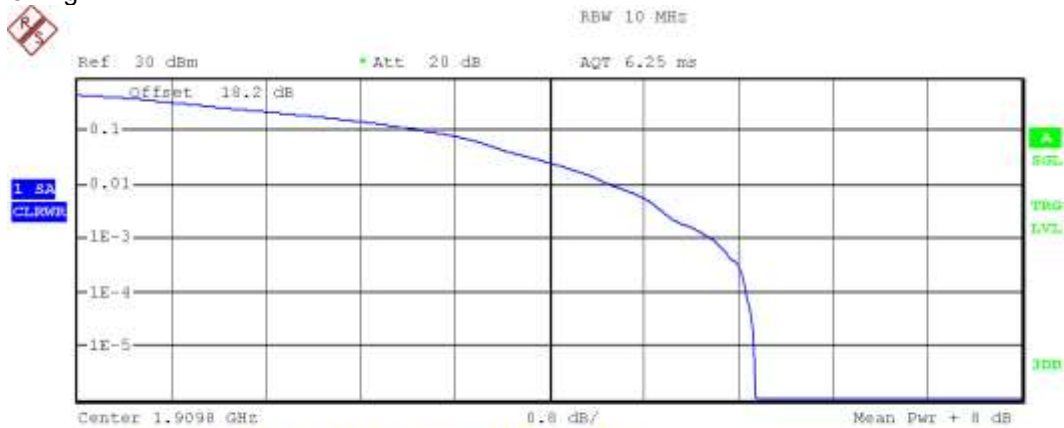

Complementary Cumulative Distribution Function
 NOF samples: 100000, Usable BW: 11.2MHz

Trace 1	
Mean	21.16 dBm
Peak	26.90 dBm
Crest	5.74 dB
10 %	2.99 dB
1 %	4.54 dB
.1 %	5.37 dB
.01 %	5.67 dB

NB IoT BAND 25.

Preliminary measurements determined that 12 tones of 15kHz as the worst case. The results in the next tables shows the results for this configuration.

Channel Low:

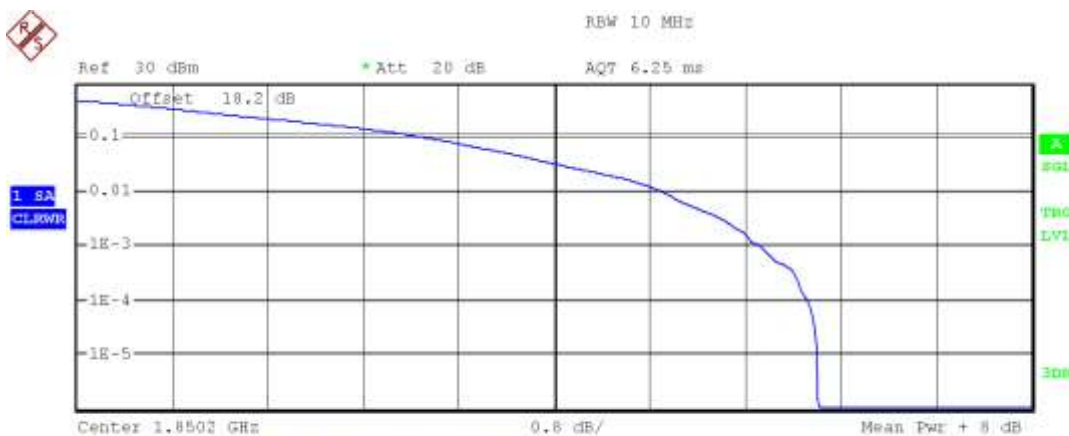

Complementary Cumulative Distribution Function
 NOF samples: 100000, Usable BW: 11.2MHz

Trace 1	
Mean	21.30 dBm
Peak	27.51 dBm
Crest	6.21 dB
10 %	2.94 dB
1 %	4.91 dB
.1 %	5.73 dB
.01 %	6.13 dB

Channel Middle:

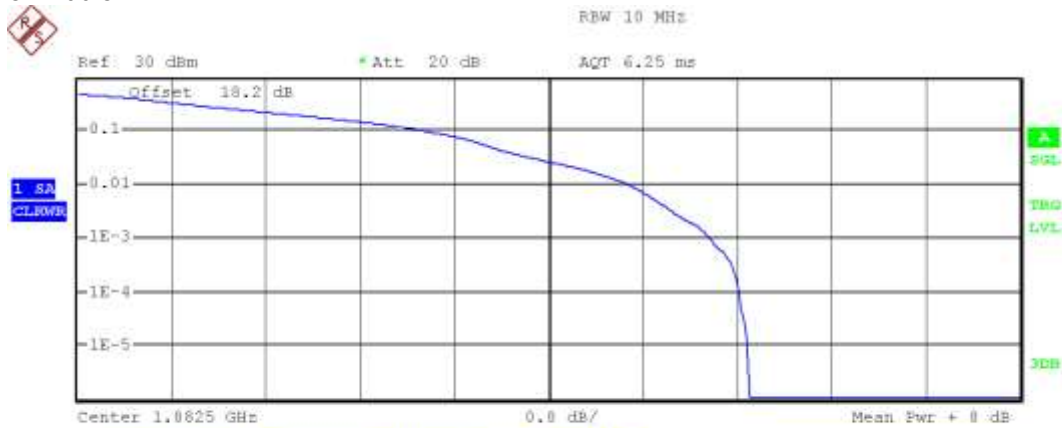

Complementary Cumulative Distribution Function
 NOF samples: 100000, Usable BW: 11.2MHz

Trace 1	
Mean	21.39 dBm
Peak	27.09 dBm
Crest	5.70 dB
10 %	2.97 dB
1 %	4.68 dB
.1 %	5.37 dB
.01 %	5.63 dB

Channel High:



Complementary Cumulative Distribution Function
 NOF samples: 100000, Usable BW: 11.2MHz

Trace 1	
Mean	21.11 dBm
Peak	26.78 dBm
Crest	5.68 dB
10 %	2.96 dB
1 %	4.60 dB
.1 %	5.36 dB
.01 %	5.67 dB

Frequency Stability

SPECIFICATION:

FCC §2.1055 and §24.235. The frequency stability shall be sufficient to ensure that the fundamental emission stays within the authorized frequency block.

RSS-133. Clause 6.3. The carrier frequency shall not depart from the reference frequency in excess of ± 2.5 ppm for mobile stations.

METHOD:

The frequency tolerance measurements over temperature variations were made over the temperature range of -30°C to $+50^{\circ}\text{C}$. The EUT was placed inside a climatic chamber and the temperature was raised hourly in 10°C steps from -30°C up to $+50^{\circ}\text{C}$.

The supply voltage was varied between 85% and 115% of nominal voltage.

The EUT was set in "Radio Resource Control (RRC) mode" in the middle channel using the Universal Radio Communication tester R&S CMW500 and the maximum frequency error was measured using the built-in calibrated frequency meter.

The worst case LTE mode for conducted power was used for the test.

In order to check that the frequency stability is sufficient such that the fundamental emissions stay within the authorized bands of operation, a reference point is established at the applicable unwanted emissions limit using a RBW equal to the RBW required by the unwanted emissions specification of the applicable regulatory standard. These reference points measured using the lowest and highest channel of operation are identified as fL and fH respectively. The worst-case frequency offset determined in the above methods is added or subtracted from the values of fL and fH to check that the resulting frequencies remain within the band.

The reference point measurements were made at the RF output terminals of the EUT using an attenuator, power splitter and spectrum analyser. The EUT was controlled via the Universal Radio Communication tester R&S CMW500 selecting maximum transmission power of the EUT and different modes of modulation.

TEST SETUP:

1. Frequency Tolerance:

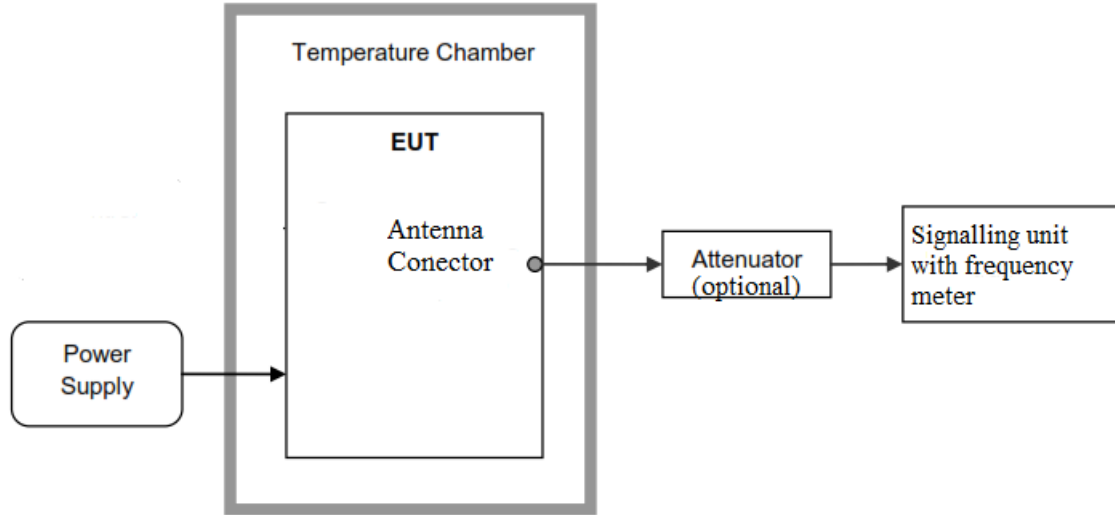

3. Reference Frequency Points f_L and f_H :

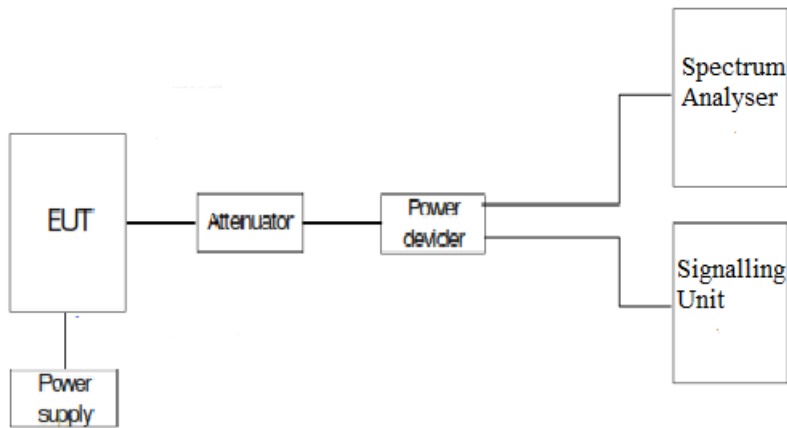

RESULTS:

Frequency stability over temperature variations.

2G Band 1900 MHz. GPRS AND EDGE MODULATIONS.

Temperature (°C)	Frequency Error (Hz)	Frequency Error (ppm)
+50	-0.47	-0.000250000
+40	8.77	0.004664894
+30	-8.74	-0.004668936
+20	-12.52	-0.006659574
+10	-12.40	-0.006595745
0	-22.33	-0.011877660
-10	4.52	0.002404255
-20	-0.74	-0.000393617
-30	25.49	0.013558511

NBLoT Band 25. $\pi/4$ - QPSK modulation. 1 tone 3.75 kHz. Channel: 1882.5 MHz.

Temperature (°C)	Frequency Error (Hz)	Frequency Error (ppm)
+50	1.56	0.000828685
+40	-3.40	-0.001806109
+30	-0.37	-0.000196547
+20	4.76	0.002528552
+10	5.54	0.002942895
0	-2.69	-0.001428951
-10	-1.56	-0.000828685
-20	-0.21	-0.000111554
-30	-5.85	-0.003107570

Measurement uncertainty(Hz)	< \pm 222
-----------------------------	-------------

Frequency stability over voltage variations.

2G Band 1900 MHz. GPRS AND EDGE MODULATIONS.

Battery Supply voltage	Voltage (V)	Frequency Error (Hz)	Frequency Error (ppm)
Vmax	4.2	-20.95	-0.011143617
Vmin	3.2	-1.71	-0.000909575

NBLoT Band 25. $\pi/4$ - QPSK modulation. 1 tone 3.75 kHz. Channel: 1882.5 MHz.

Battery Supply voltage	Voltage (V)	Frequency Error (Hz)	Frequency Error (ppm)
Vmax	4.2	3.58	0.001901726
Vmin	3.2	4.79	0.002544489

Points established at the applicable unwanted emissions limit (worst case):

2G Band 1900 MHz. GPRS AND EDGE MODULATIONS.

f_L (MHz)	1850,0409776700
f_H (MHz)	1909,9590254900

NBLoT Band 25. $\pi/4$ - QPSK modulation. 1 tone 3.75 kHz. Channel: 1882.5 MHz.

f_L (MHz)	1849,9969941500
f_H (MHz)	1915,0056755400

The reference frequency points f_L and f_H stay within the authorized blocks for all the bands above.

2G Band 1900 MHz. GPRS AND EDGE MODULATIONS.

f_L (MHz)	1850,0410
f_H (MHz)	1909,9590

NBLoT Band 25. $\pi/4$ - QPSK modulation. 1 tone 3.75 kHz. Channel: 1882.5 MHz.

f_L (MHz)	1849,9970
f_H (MHz)	1915,0057

Verdict: PASS

Modulation Characteristics

SPECIFICATION:

FCC §2.1047

RSS-133. Clause 6.2. Equipment certified under this standard shall use digital modulation.

METHOD:

For 2G, the EUT operates with GPRS (GMSK), EDGE (8PSK) modulation modes, in which the information is digitized and coded into a bit stream.

For NB-IoT the EUT operates with $\pi/2$ - BPSK and $\pi/4$ - QPSK modulation modes in which the information is digitised and coded into a bit stream.

TEST SETUP:

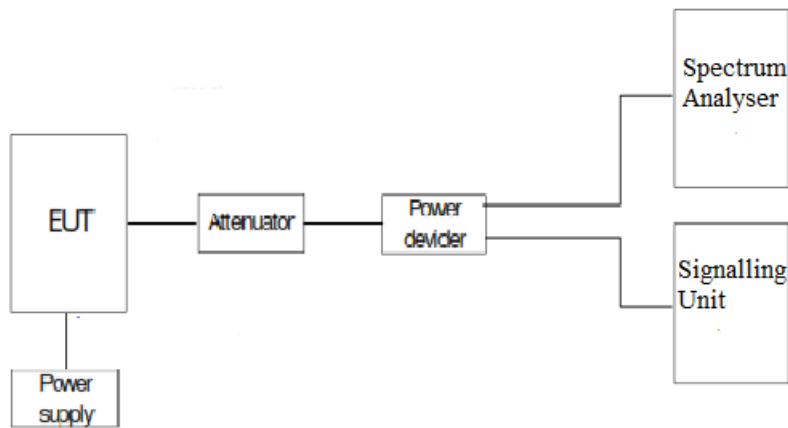

RESULTS:

The following plots show the modulation schemes in the EUT.

2G Band 1900 MHz. GPRS MODULATION.

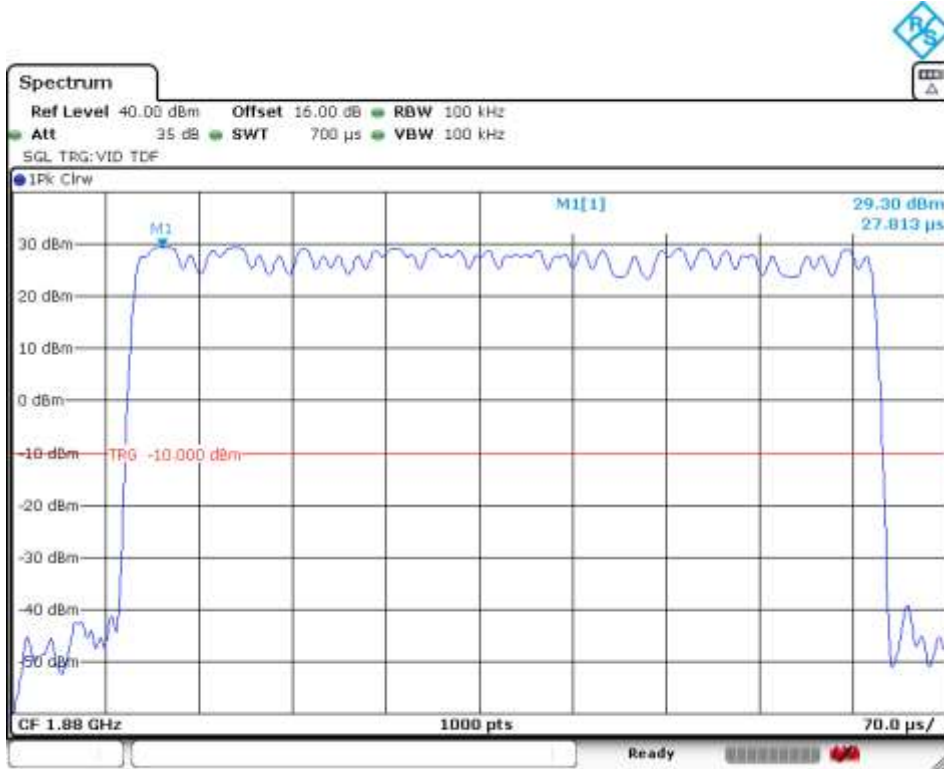

2G Band 1900 MHz. EDGE MODULATION.

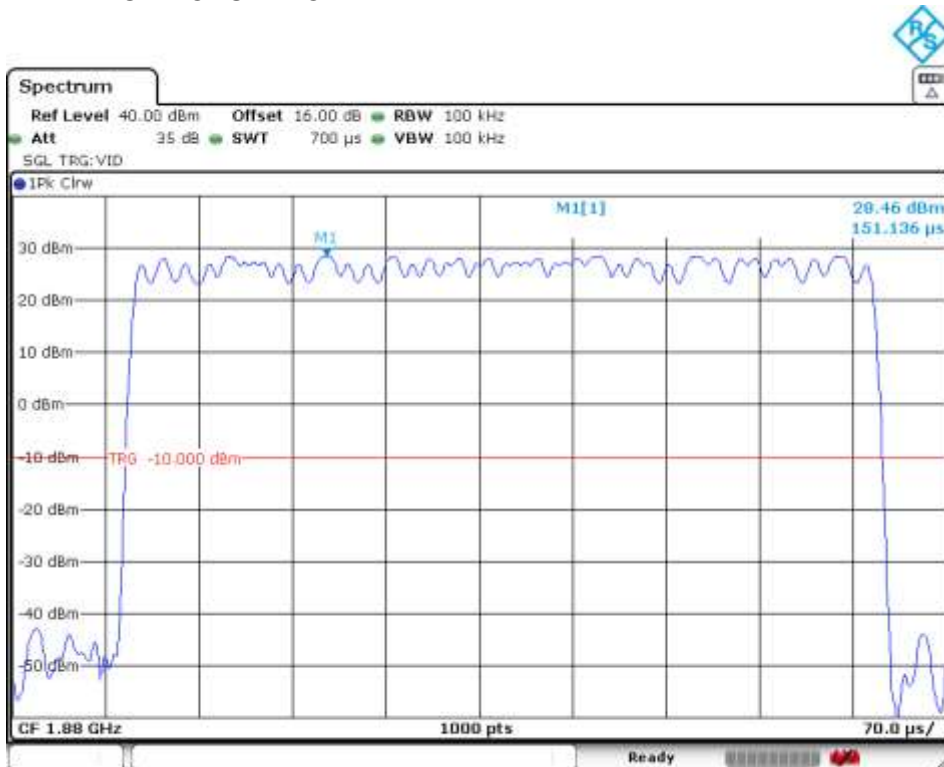

NB IoT MODULATION (Band 25). $\pi/2$ - BPSK.

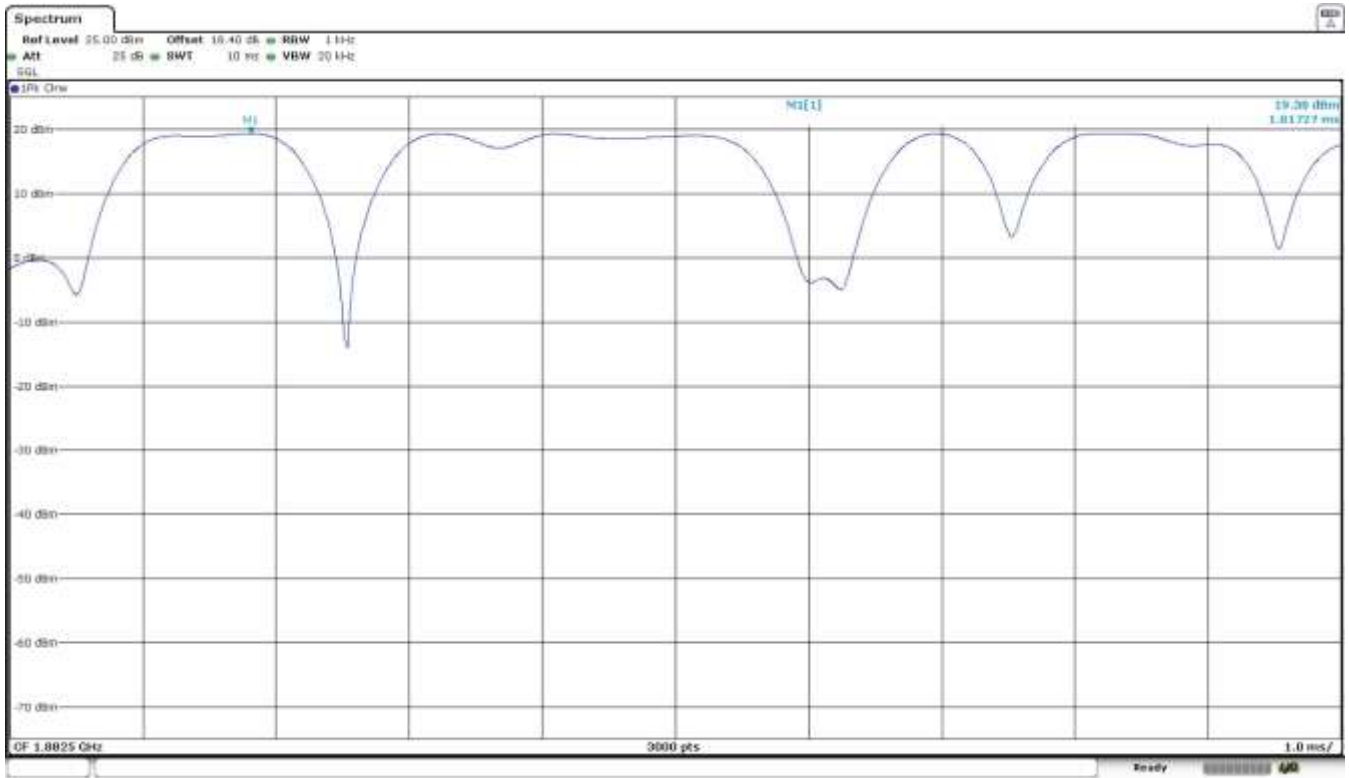

NB IoT MODULATION (Band 25). $\pi/4$ - QPSK.

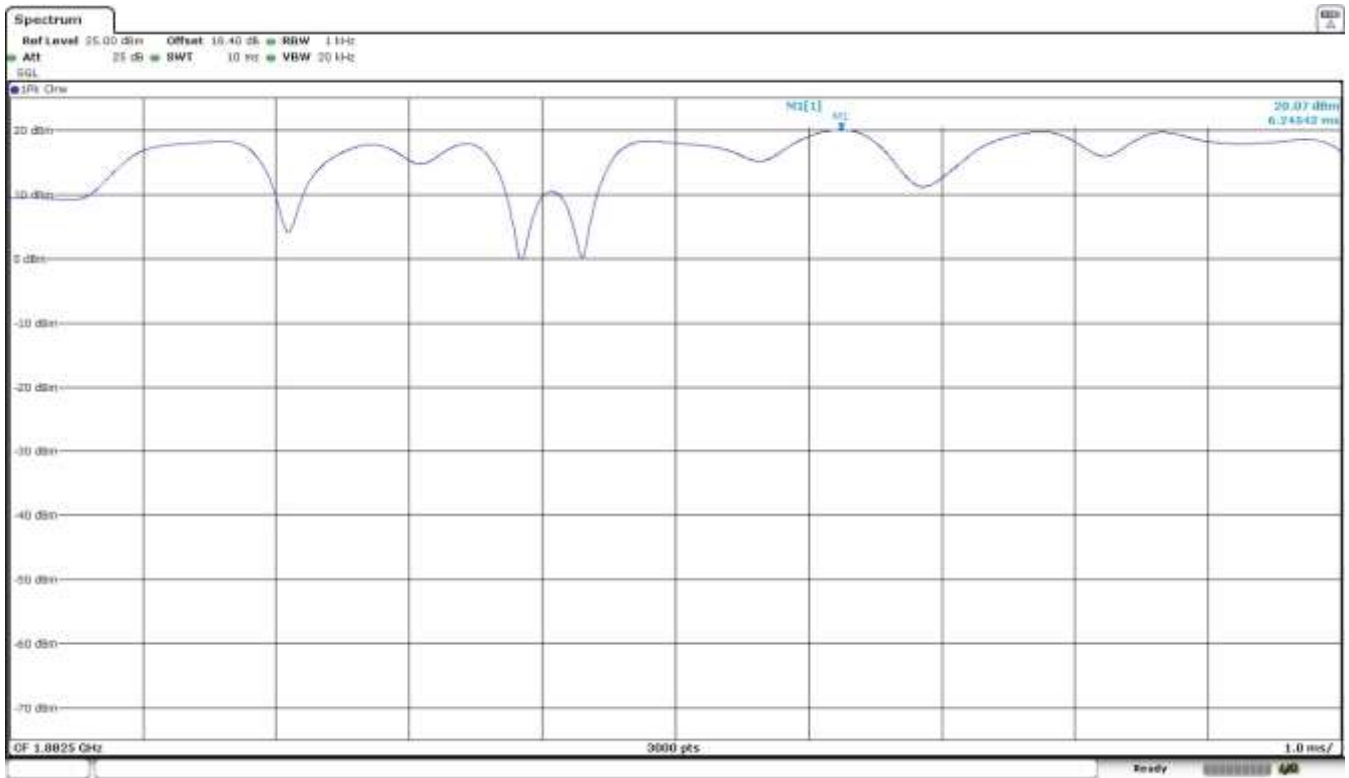

Occupied Bandwidth

SPECIFICATION:

FCC §2.1049. Measurements required: Occupied bandwidth.

RSS-Gen Clause 6.7.

METHOD:

The occupied bandwidth measurement was performed at the output terminals of the EUT using an attenuator, power splitter and spectrum analyser. The EUT was controlled via the Universal Radio Communication tester R&S CMW500 selecting maximum transmission power of the EUT and different modes of modulation. The 99% occupied bandwidth and the -26 dBc bandwidth were measured directly using the built-in bandwidth measuring option of spectrum analyser.

TEST SETUP:

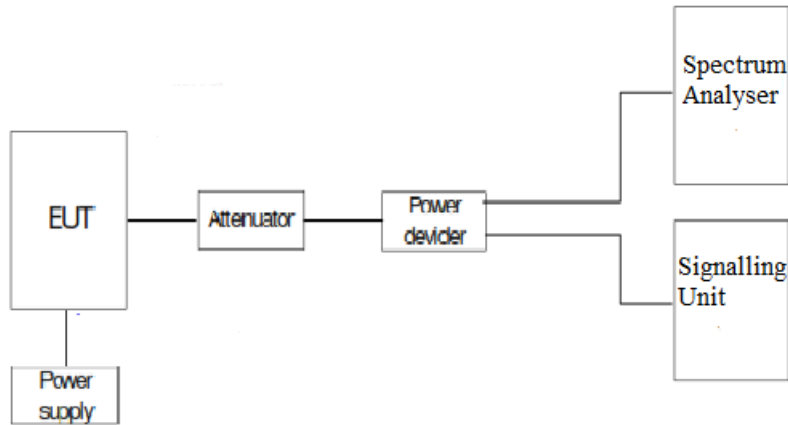

2G Band 1900 MHz:

2G Band 1900 MHz. GPRS MODULATION.

Channel	Lowest	Middle	Highest
99% Occupied bandwidth (kHz)	236.00	235.00	237.00
-26 dBc bandwidth (kHz)	287.00	296.00	296.00
Measurement uncertainty (kHz)	<±1.39		

2G Band 1900 MHz. EDGE MODULATION.

Channel	Lowest	Middle	Highest
99% Occupied bandwidth (kHz)	236.00	235.00	237.00
-26 dBc bandwidth (kHz)	289.00	302.00	298.00
Measurement uncertainty (kHz)	<±1.39		

NBLoT BAND 25.

Tone 3.75 kHz. $\pi/2$ - BPSK MODULATION

Channel	Lowest	Middle	Highest
99% Occupied bandwidth (kHz)	39.06	39.63	38.80
-26 dBc bandwidth (kHz)	34.96	34.96	34.83
Measurement uncertainty (kHz)	<±0.27		

Tone 3.75 kHz. $\pi/4$ - QPSK MODULATION

Channel	Lowest	Middle	Highest
99% Occupied bandwidth (kHz)	38.96	38.83	38.63
-26 dBc bandwidth (kHz)	40.20	40.20	37.86
Measurement uncertainty (kHz)	<±0.27		

Tone 15 kHz. $\pi/2$ - BPSK MODULATION

Channel	Lowest	Middle	Highest
99% Occupied bandwidth (kHz)	73.93	74.20	73.60
-26 dBc bandwidth (kHz)	98.46	98.40	92.33
Measurement uncertainty (kHz)	<±0.28		

12 Tones 15 kHz. $\pi/4$ - QPSK MODULATION

Channel	Lowest	Middle	Highest
99% Occupied bandwidth (kHz)	190.93	192.13	191.86
-26 dBc bandwidth (kHz)	277.00	278.40	278.27
Measurement uncertainty (kHz)	<±0.65		

RESULTS:
2G Band 1900 MHz. GPRS MODULATION.

Lowest Channel:



Middle Channel:



Highest Channel:



2G Band 1900 MHz. EDGE MODULATION.

Lowest Channel:

