

FCC Test Report

Product Name : ML865C1-NA
Trade Name : 
Model No. : ML865C1-NA
FCC ID. : RI7ML865C1NA

Applicant : Telit communications Spa
Address : Via Stazione di Prosecco 5/B
34010 Sgonico
Trieste-Italy

Date of Receipt : Aug. 09, 2018
Issued Date : Oct. 01, 2018
Report No. : 1880135R-RFUSP01V00
Report Version : V1.0



The test results relate only to the samples tested.
The test report shall not be reproduced except in full without the written approval of DEKRA Testing and Certification Co., Ltd..

Test Report Certification

Issued Date : Oct. 01, 2018

Report No. : 1880135R-RFUSP01V00



Product Name : ML865C1-NA
 Applicant : Telit communications Spa
 Address : Via Stazione di Prosecco 5/B
 34010 Sgonico
 Trieste-Italy
 Manufacturer : TELIT WIRELESS SOLUTIONS CO., LTD
 Trade Name :

Model No. : ML865C1-NA
 FCC ID. : RI7ML865C1NA
 EUT Test Voltage : DC 3.8V
 Testing Voltage : DC 3.8V
 Applicable Standard : FCC CFR Title 47 Part 15 Subpart B: 2017 Class B,
 CISPR 22: 2008, , ANSI C63.4: 2014

Laboratory Name : Hsin Chu Laboratory
 Address : No.372-2, Sec. 4, Zhongxing Rd., Zhudong Township, Hsinchu
 County 31061, Taiwan, R.O.C.
 TEL: +886-3-582-8001 / FAX: +886-3-582-8958

Test Result : Complied

Documented By :

 (Carol Tsai / Senior Engineering Adm. Specialist)

Tested By :

 (Andy Tsai / Senior Engineer)

Approved By :

 (Roy Wang / Director)

Revision History

Report No.	Version	Description	Issued Date
1880135R-RFUSP01V00	V1.0	Initial issue of report	Oct. 01, 2018

TABLE OF CONTENTS

Description	Page
1. General Information.....	5
1.1. EUT Description	5
1.2. Test Mode	6
1.3. Tested System Details	7
1.4. Configuration of Tested System.....	7
1.5. EUT Exercise Software	7
1.6. Test Facility.....	8
1.7. List of Test Equipment	9
1.8. Uncertainty	9
2. Conducted Emission	10
2.1. Test Setup	10
2.2. Limits	10
2.3. Test Procedure	11
2.4. Test Specification.....	11
2.5. Test Result.....	11
3. Radiated Emission.....	12
3.1. Test Setup	12
3.2. Limits	13
3.3. Test Procedure	14
3.4. Test Specification.....	15
3.5. Test Result.....	16
Attachment 1	48
Test Setup Photograph	48
Attachment 2	50
EUT External Photograph.....	50

1. General Information

1.1. EUT Description

Product Name	ML865C1-NA
Trade Name	
Model No.	ML865C1-NA
Uplink Frequency Range (MHz)	LTE Band 2: 1850~1910 LTE Band 4: 1710~1755 LTE Band 12: 699~716 LTE Band 13: 777~787
Downlink Frequency Range (MHz)	LTE Band 2: 1930~1990 LTE Band 4: 2110~2115 LTE Band 12: 729~746 LTE Band 13: 746~756
Modulation	LTE : BPSK / QPSK (NBIoT) QPSK / 16QAM (CAT M1)
HW	0.0
SW	M0B.150003

Antenna Information	
Antenna	1 PCS

Accessories Information	
Model No.	ATEL-CAB; T-AT305
Antenna Type	1/4 l Antenna
Antenna Gain	2.14 dBi

Note:

1. Regards to the frequency band operation; the lowest , middle and highest frequency of channel were selected to perform the test, and then shown on this report.

1.2. Test Mode

DERKA has verified the construction and function in typical operation. The preliminary tests were performed in different data rate, and to find the worst condition, which was shown in this test report. The following table is the final test mode.

RX	Mode 1: LTE_NB-IOT_Band 2 Mode 2: LTE_NB-IOT_Band 4 Mode 3: LTE_NB-IOT_Band 12 Mode 4: LTE_NB-IOT_Band 13 Mode 5: LTE_CAT-M1_Band 2 Mode 6: LTE_CAT-M1_Band 4 Mode 7: LTE_CAT-M1_Band 12 Mode 8: LTE_CAT-M1_Band 13
----	--

1.3. Tested System Details

The types for all equipment, plus descriptions of all cables used in the tested system (including inserted cards) are:

Product	Manufacturer	Model No.	Serial No.	FCC ID	Power Cord
1 Fixture	Telit	LE922A6-E2	N/A	DoC	--
2 Horn Antenna	Schwarzbeck	BBHA 9120D	639	DoC	--
3 Wideband Radio Communication Tester	R&S	CMW500	150246	DoC	--

1.4. Configuration of Tested System

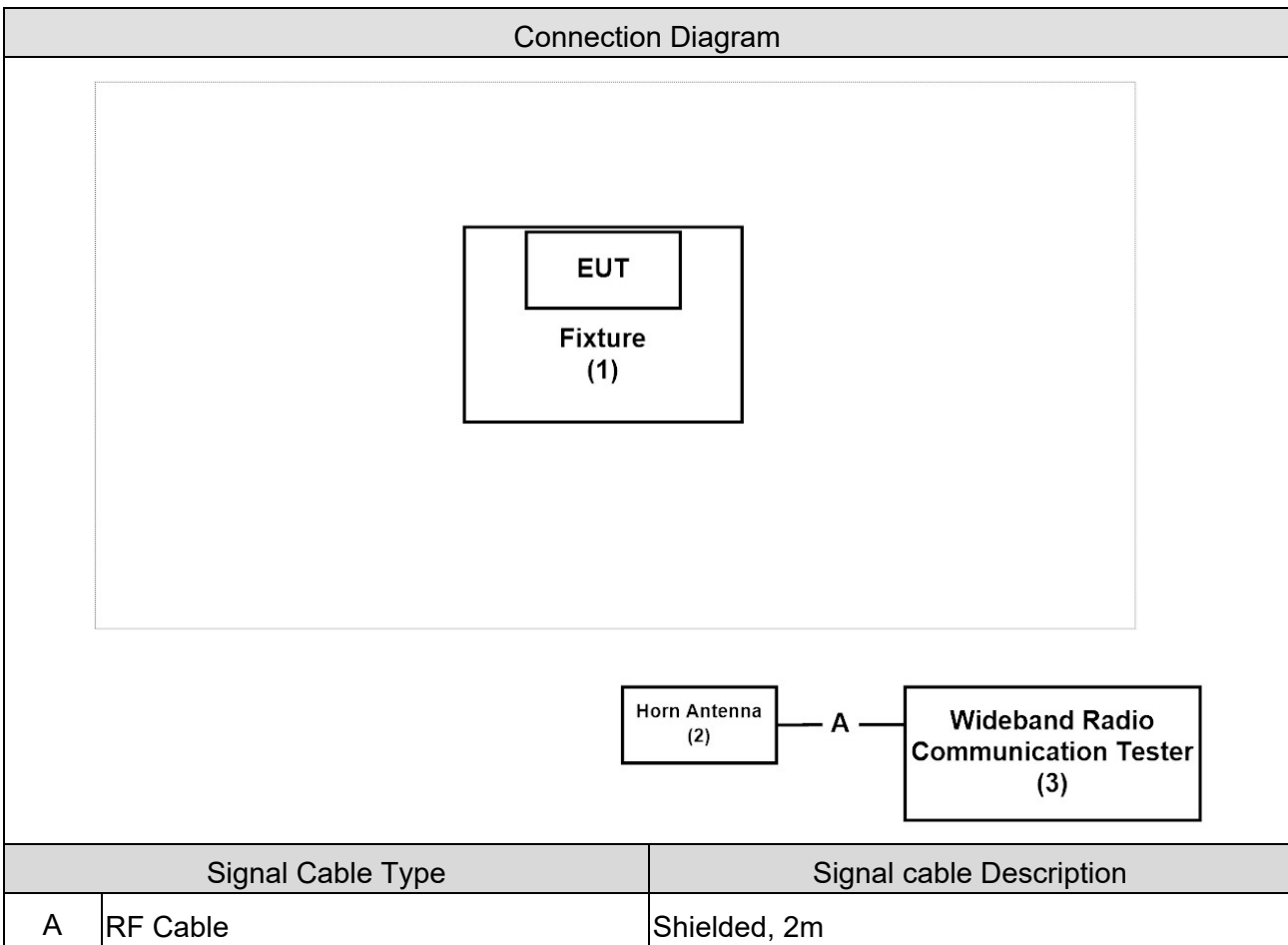

1.5. EUT Exercise Software

1	Setup the EUT and simulators as shown on 1.4.
2	Turn on the power of all equipment.
3	The EUT will continue receive the signal from LTE function.
4	Repeat the above procedure (3)

1.6. Test Facility

Ambient conditions in the laboratory:

Items	Test Item	Required (IEC 68-1)	Actual	Test Site
Temperature (°C)	FCC PART 15 B 15.107 Conducted Emission	15 - 35	25	--
Humidity (%RH)		25 - 75	50	
Barometric pressure mbar)		860 - 1060	950-1000	
Temperature (°C)	FCC PART 15 B 15.109 Radiated Emission	15 - 35	25	2
Humidity (%RH)		25 - 75	65	
Barometric pressure mbar)		860 - 1060	950-1000	

Note: Test site information refers to Laboratory Information.

Laboratory Information

USA : **FCC Registration Number: TW3024**
Canada **IC Registration Number: 22397-1 / 22397-2 / 22397-3**

The related certificate for our laboratories about the test site and management system can be downloaded from DEKRA Testing and Certification Co., Ltd. Web Site:

<http://www.dekra.com.tw/english/about/certificates.aspx?bval=5>

The address and introduction of DEKRA Testing and Certification Co., Ltd. laboratories can be founded in our Web site: http://www.dekra.com.tw/index_en.aspx

If you have any comments, Please don't hesitate to contact us. Our test sites as below:

- No. 75-2, 3rd Lin, WangYe Keng, Yongxing Tsuen, Qionglin Shiang, Hsinchu County 307, Taiwan (R.O.C.)
TEL: +886-3-592-8858 / FAX: +886-3-592-8859 E-Mail : info.tw@dekra.com
- No.372, Sec. 4, Zhongxing Rd., Zhudong Township, Hsinchu County 31061, Taiwan, R.O.C.
TEL: +886-3-582-8001 / FAX: +886-3-582-8958 E-Mail : info.tw@dekra.com
- No.372-2, Sec. 4, Zhongxing Rd., Zhudong Township, Hsinchu County 31061, Taiwan, R.O.C.
TEL: +886-3-582-8001 / FAX: +886-3-582-8958 E-Mail : info.tw@dekra.com

1.7. List of Test Equipment

Radiated Emission / CB2-H

Instrument	Manufacturer	Model No.	Serial No.	Cal. Date	Next Cal. Date
Signal Analyzer	R&S	FSVA40	101455	2017/11/21	2018/11/20
Signal & Spectrum Analyzer	R&S	FSV40	101049	2018/01/10	2019/01/09
EXA Signal Analyzer	Keysight	N9010A	MY51440132	2018/03/05	2019/03/04
Bilog Antenna	Teseq	CBL6112D	23191	2018/06/26	2019/06/25
Horn Antenna	Schwarzbeck	BBHA 9120D	639	2018/06/01	2019/05/31
Horn Antenna	Schwarzbeck	BBHA 9170	202	2018/01/31	2019/01/30
Pre-Amplifier	Dekra	AP-025C	201801236	2018/02/26	2019/02/25
Pre-Amplifier	EMCI	EMC11830I	980366	2018/01/08	2019/01/07
Pre-Amplifier	Dekra	AP-400C	201801231	2017/12/13	2018/12/12

1.8. Uncertainty

Test item	Uncertainty
Radiated Emission	Below 1G is defined as ± 3.8 dB Above 1G is defined as ± 3.9 dB

2. Conducted Emission

2.1. Test Setup

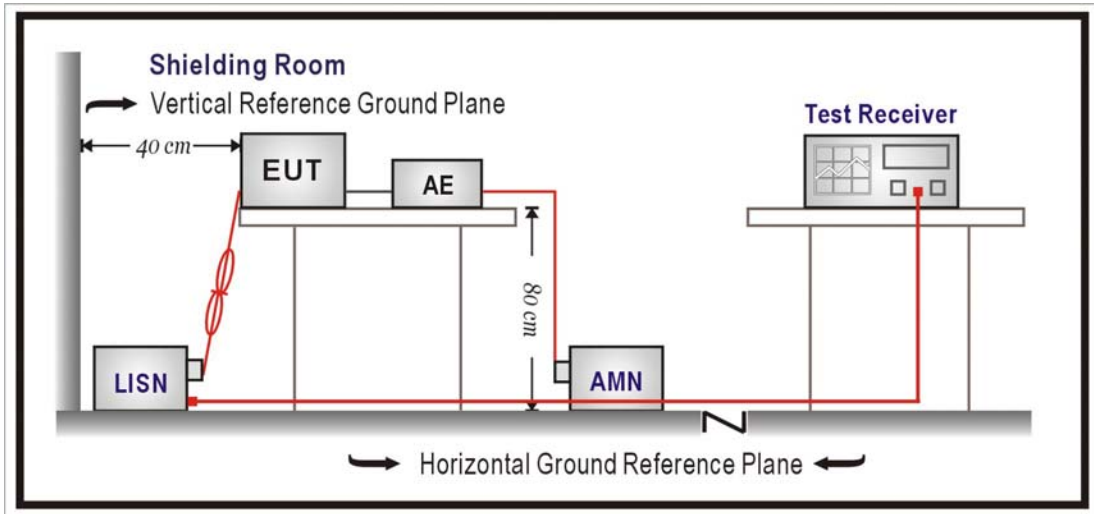

2.2. Limits

FCC Part 15 Subpart B Paragraph 15.107 Limits (dBuV)				
Frequency MHz	Class A		Class B	
	QP	AV	QP	AV
0.15 - 0.50	79	66	66 - 56	56 - 46
0.50 - 5.0	73	60	56	46
5.0 - 30	73	60	60	50

Remarks : In the above table, the tighter limit applies at the band edges.

2.3. Test Procedure

The EUT and simulators are connected to the main power through a line impedance stabilization network (L.I.S.N.). This provides a 50 ohm /50uH coupling impedance for the measuring equipment. The peripheral devices are also connected to the main power through a LISN that provides a 50ohm/50uH coupling impedance with 50ohm termination. (Please refers to the block diagram of the test setup and photographs.)

Both sides of A.C. line are checked for maximum conducted interference. In order to find the maximum emission, the relative positions of equipment and all of the interface cables must be changed according to ANSI C63.4: 2014 on conducted measurement.

Conducted emissions were investigated over the frequency range from 0.15MHz to 30MHz using a receiver bandwidth of 9KHz.

2.4. Test Specification

According to FCC Part 15 Subpart B: 2017

2.5. Test Result

Owing to the DC operation of EUT, this test item is not performed.

3. Radiated Emission

3.1. Test Setup

Under 1GHz Test Setup:

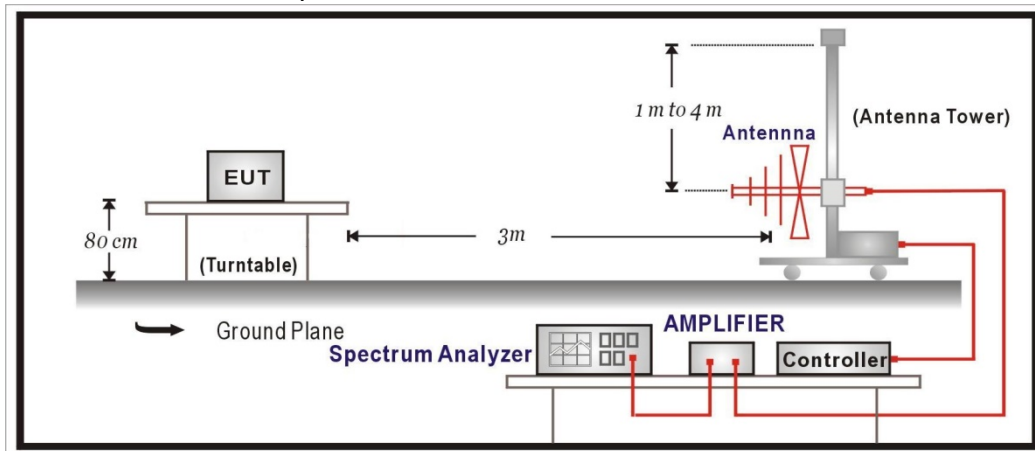

Above 1GHz Test Setup:

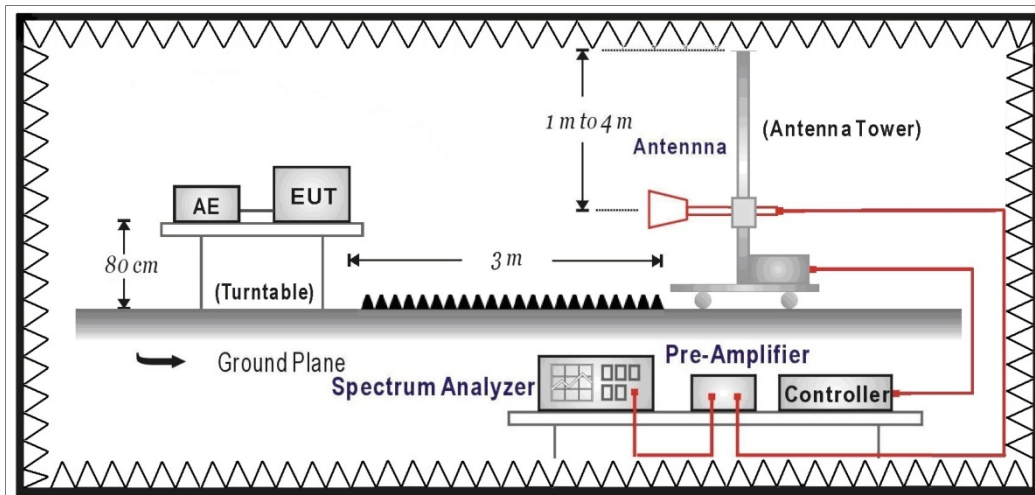

3.2. Limits

CISPR 22 Limits (dBuV/m)				
Frequency MHz	Class A		Class B	
	Distance (m)	dBuV/m	Distance (m)	dBuV/m
30 – 230	10	40	10	30
230 – 1000	10	47	10	37

Remark: 1. The tighter limit shall apply at the edge between two frequency bands.

2. Distance refers to the distance in meters between the measuring instrument antenna and the closed point of any part of the device or system.

3. RF Voltage (dBuV/m) = 20 log RF Voltage (uV/m)

FCC Part 15 Subpart B Paragraph 15.109 Limits				
Frequency MHz	Class A		Class B	
	Distance (m)	dBuV/m	Distance (m)	dBuV/m
30 – 88	10	39	3	40
88 – 216	10	43.5	3	43.5
216 – 960	10	46.4	3	46
Above 960	10	49.5	3	54

Remark: 1. RF Voltage (dBuV) = 20 log RF Voltage (uV)

2. In the Above Table, the tighter limit applies at the band edges.

3. Distance refers to the distance in meters between the measuring instrument antenna and the closed point of any part of the device or system.

Carrier current systems used as unintentional radiators or other unintentional radiators that are designed to conduct their radio frequency emissions via connecting wires or cables and that operate in the frequency range of 9 KHz to 30 MHz, including devices that deliver the radio frequency energy to transducers, such as ultrasonic devices not covered under part 18 of this chapter, shall comply with the radiated emission limits for intentional radiators provided in §15.209 for the frequency range of 9 KHz to 30 MHz. As an alternative, carrier current systems used as unintentional radiators and operating in the frequency range of 525 KHz to 1705 KHz may comply with the radiated emission limits provided in §15.221(a).

3.3. Test Procedure

Under 30MHz Test:

The EUT and its simulators are placed on a turn table which is 1.0 meter above ground. The turn table can rotate 360 degrees to determine the position of the maximum electric field strength. The EUT was positioned such that the distance from antenna to the EUT was 3 meters.

The antenna which is 1.0 meter above ground. All X-axis, Y-axis and Z-axis polarization of the antenna are set on measurement.

The bandwidth below 30MHz setting on the field strength meter (R&S Test Receiver ESCS 30) is 200Hz and above 30MHz is 9 KHz.

The emission limit shown in the above table are based on measurements employing a CISPR quasi-peak detector except for the frequency bands 9-90KHz, 110-490KHz and above 1000MHz. Radiated emission limit in these three bands are based on measurements employing an average detector.

Above 30MHz Test:

The EUT and its simulators are placed on a turn table which is 0.8 meter above ground. The turn table can rotate 360 degrees to determine the position of the maximum emission level.

The antenna can move up and down between 1 meter and 4 meters to find out the maximum emission level.

For class A, the EUT was positioned such that the distance from antenna to the EUT was 10 meters for under 1GHz and above 1GHz.

For class B, the EUT was positioned such that the distance from antenna to the EUT was 3 or 10 meters for under 1GHz and 3 meters for above 1GHz.

The bandwidth below 1GHz setting on the field strength meter is 120 KHz and above 1GHz is 1MHz.

Both horizontal and vertical polarization of the antenna are set on measurement. In order to find the maximum emission.

All of the interface cables must be manipulated according to ANSI C63.4: 2013 on radiated measurement.

For an unintentional radiator, including a digital device, the spectrum shall be investigated from the lowest radio frequency signal generated or used in the device, without going below the lowest frequency for which a radiated emission limit is specified, up to the frequency shown in the following table:

Highest frequency generated or used in the device or on which the device operates or tunes (MHz)	Upper frequency of measurement range (MHz)
Below 1.705	30
1.705 – 108	1000
108 – 500	2000
500 – 1000	5000
Above 1000	5 th harmonic of the highest frequency or 40 GHz, whichever is lower

On any frequency or frequencies below or equal to 1000 MHz, the limits shown are based on measuring equipment employing a CISPR quasi-peak detector function and on any frequency or frequencies above 1000 MHz the radiated limits shown are based upon the use of measurement instrumentation employing an average detector function. When average radiated emission measurement are included emission measurement below 1000 MHz, there also is a limit on the radio frequency emissions, as measured using instrumentation with a peak detector function, corresponding to 20 dB above the maximum permitted average limit.

3.4. Test Specification

According to FCC Part 15 Subpart B: 2017

3.5. Test Result

30MHz-1GHz Spurious:

Site :	CB2-H	Engineer :	Andy Tsai
Model No :	ML865C1-NA	Test Date :	2018/9/30
Test Voltage :	DC 3.8V	Polarity :	Horizontal
Test Mode :	Mode 1: LTE_NB-IOT_Band 2		

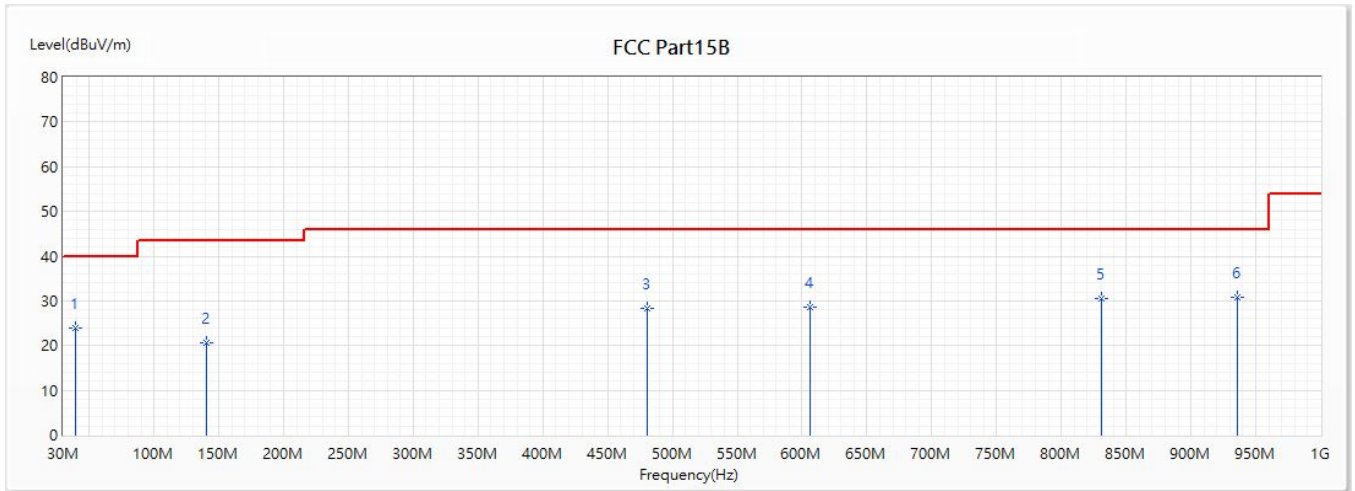

No	Frequency (MHz)	Emission Level (dBuV/m)	Limit (dBuV/m)	Margin (dB)	Reading Level (dBuV)	Correct Factor (dB)	Detector Type
1	39.7	23.97	40.00	-16.03	40.22	-16.25	QP
2	140.58	20.75	43.50	-22.75	42.07	-21.32	QP
3	480.08	28.40	46.00	-17.60	42.32	-13.92	QP
4	606.18	28.46	46.00	-17.54	39.96	-11.50	QP
5	831.22	30.63	46.00	-15.37	40.88	-10.25	QP
* 6	935.98	30.71	46.00	-15.29	39.55	-8.84	QP

Note:

1. All Reading Levels is Quasi-Peak value.
2. “ * ”, means this data is the worst emission level.
3. Emission Level = Reading Level + Correct Factor
4. The Emission under 30MHz were not included is because their levels are too low.

Site :	CB2-H	Engineer :	Andy Tsai
Model No :	ML865C1-NA	Test Date :	2018/9/30
Test Voltage :	DC 3.8V	Polarity :	Vertical
Test Mode :	Mode 1: LTE_NB-IOT_Band 2		

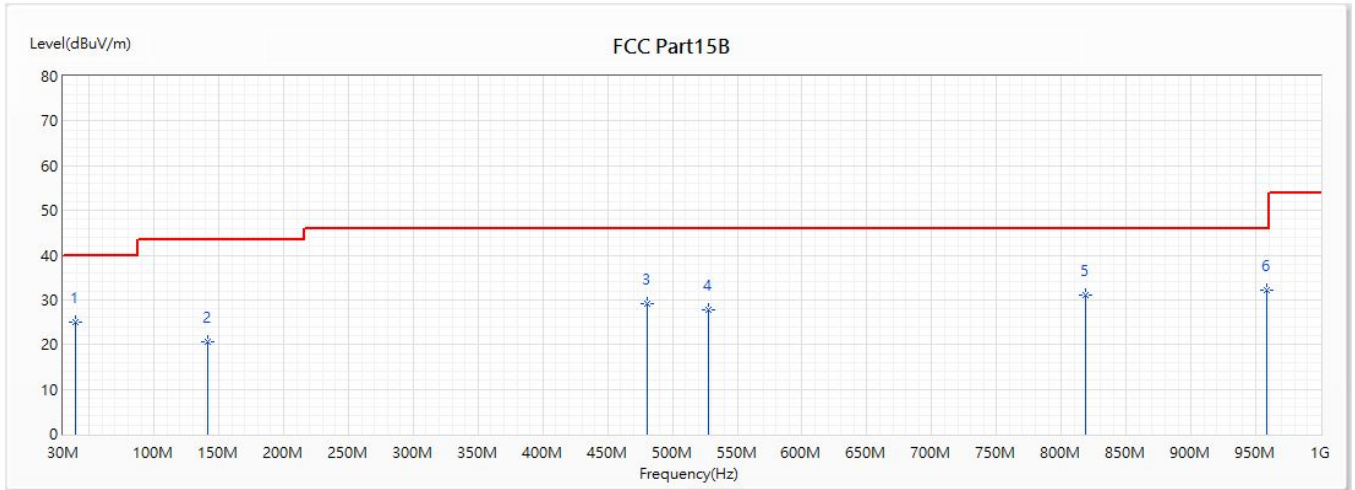

No	Frequency (MHz)	Emission Level (dBuV/m)	Limit (dBuV/m)	Margin (dB)	Reading Level (dBuV)	Correct Factor (dB)	Detector Type
1	39.7	24.99	40.00	-15.01	41.24	-16.25	QP
2	141.55	20.75	43.50	-22.75	42.10	-21.35	QP
3	480.08	29.01	46.00	-16.99	42.93	-13.92	QP
4	527.61	27.89	46.00	-18.11	42.60	-14.71	QP
5	818.61	31.18	46.00	-14.82	41.07	-9.89	QP
* 6	958.29	32.20	46.00	-13.80	40.92	-8.72	QP

Note:

1. All Reading Levels is Quasi-Peak value.
2. “ * ”, means this data is the worst emission level.
3. Emission Level = Reading Level + Correct Factor
4. The Emission under 30MHz were not included is because their levels are too low.

Site :	CB2-H	Engineer :	Andy Tsai
Model No :	ML865C1-NA	Test Date :	2018/9/30
Test Voltage :	DC 3.8V	Polarity :	Horizontal
Test Mode :	Mode 2: LTE_NB-IOT_Band 4		

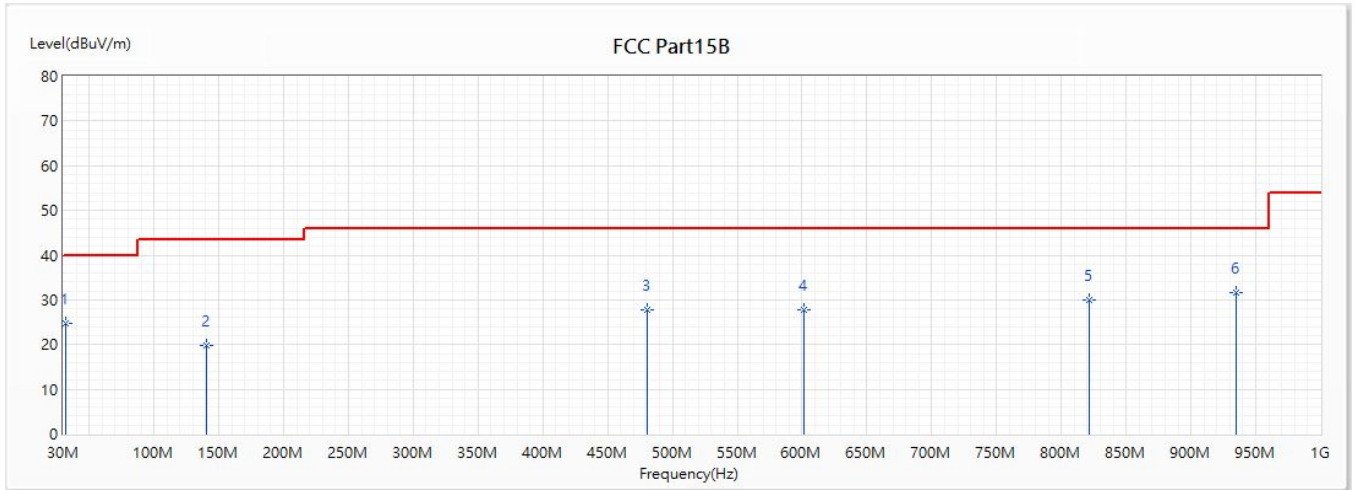

No	Frequency (MHz)	Emission Level (dBuV/m)	Limit (dBuV/m)	Margin (dB)	Reading Level (dBuV)	Correct Factor (dB)	Detector Type
1	31.94	24.85	40.00	-15.15	40.46	-15.61	QP
2	140.58	19.83	43.50	-23.67	41.15	-21.32	QP
3	480.08	27.66	46.00	-18.34	41.58	-13.92	QP
4	601.33	27.64	46.00	-18.36	39.52	-11.88	QP
5	821.52	30.02	46.00	-15.98	39.79	-9.77	QP
* 6	935.01	31.54	46.00	-14.46	40.34	-8.80	QP

Note:

1. All Reading Levels is Quasi-Peak value.
2. “ * ”, means this data is the worst emission level.
3. Emission Level = Reading Level + Correct Factor
4. The Emission under 30MHz were not included is because their levels are too low.

Site :	CB2-H	Engineer :	Andy Tsai
Model No :	ML865C1-NA	Test Date :	2018/9/30
Test Voltage :	DC 3.8V	Polarity :	Vertical
Test Mode :	Mode 2: LTE_NB-IOT_Band 4		

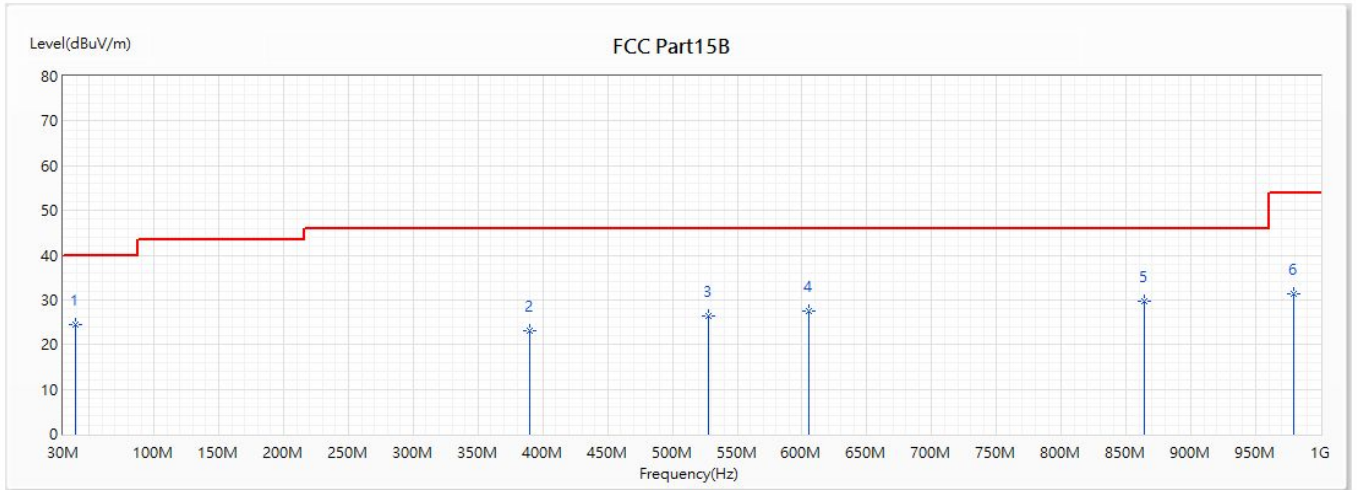

No	Frequency (MHz)	Emission Level (dBuV/m)	Limit (dBuV/m)	Margin (dB)	Reading Level (dBuV)	Correct Factor (dB)	Detector Type
* 1	39.7	24.39	40.00	-15.61	40.64	-16.25	QP
2	389.87	23.01	46.00	-22.99	39.30	-16.29	QP
3	527.61	26.45	46.00	-19.55	41.16	-14.71	QP
4	605.21	27.56	46.00	-18.44	39.09	-11.53	QP
5	864.2	29.70	46.00	-16.30	39.09	-9.39	QP
6	979.63	31.40	54.00	-22.60	39.51	-8.11	QP

Note:

1. All Reading Levels is Quasi-Peak value.
2. “ * ”, means this data is the worst emission level.
3. Emission Level = Reading Level + Correct Factor
4. The Emission under 30MHz were not included is because their levels are too low.

Site :	CB2-H	Engineer :	Andy Tsai
Model No :	ML865C1-NA	Test Date :	2018/9/30
Test Voltage :	DC 3.8V	Polarity :	Horizontal
Test Mode :	Mode 3: LTE_NB-IOT_Band 12		

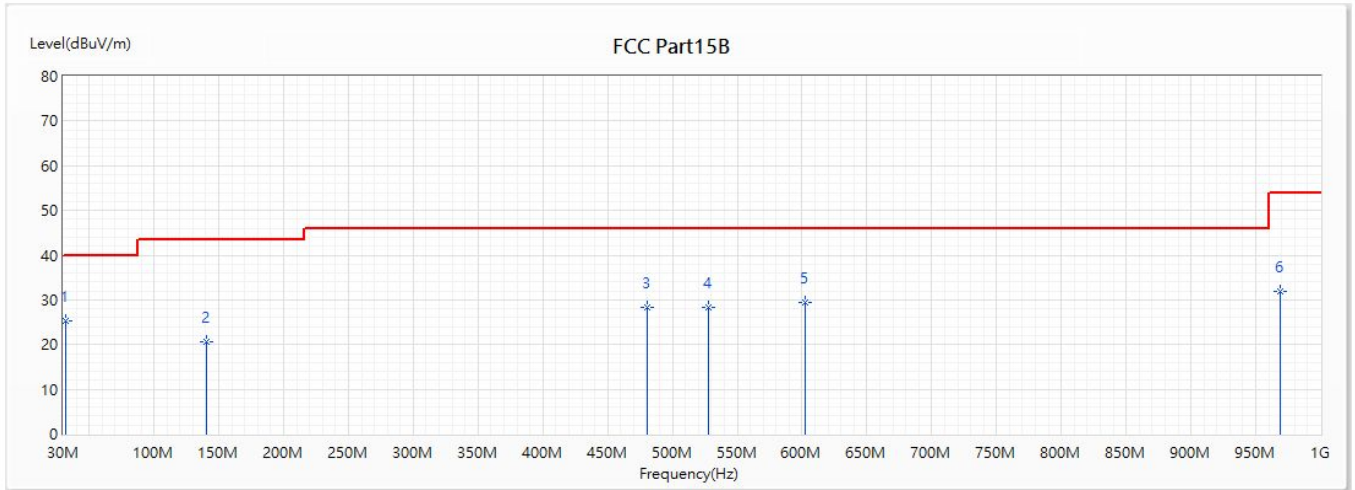

No	Frequency (MHz)	Emission Level (dBuV/m)	Limit (dBuV/m)	Margin (dB)	Reading Level (dBuV)	Correct Factor (dB)	Detector Type
* 1	31.94	25.23	40.00	-14.77	40.84	-15.61	QP
2	140.58	20.59	43.50	-22.91	41.91	-21.32	QP
3	480.08	28.41	46.00	-17.59	42.33	-13.92	QP
4	527.61	28.43	46.00	-17.57	43.14	-14.71	QP
5	602.3	29.42	46.00	-16.58	41.01	-11.59	QP
6	968.96	31.88	54.00	-22.12	40.94	-9.06	QP

Note:

1. All Reading Levels is Quasi-Peak value.
2. “ * ”, means this data is the worst emission level.
3. Emission Level = Reading Level + Correct Factor
4. The Emission under 30MHz were not included is because their levels are too low.

Site :	CB2-H	Engineer :	Andy Tsai
Model No :	ML865C1-NA	Test Date :	2018/9/30
Test Voltage :	DC 3.8V	Polarity :	Vertical
Test Mode :	Mode 3: LTE_NB-IOT_Band 12		

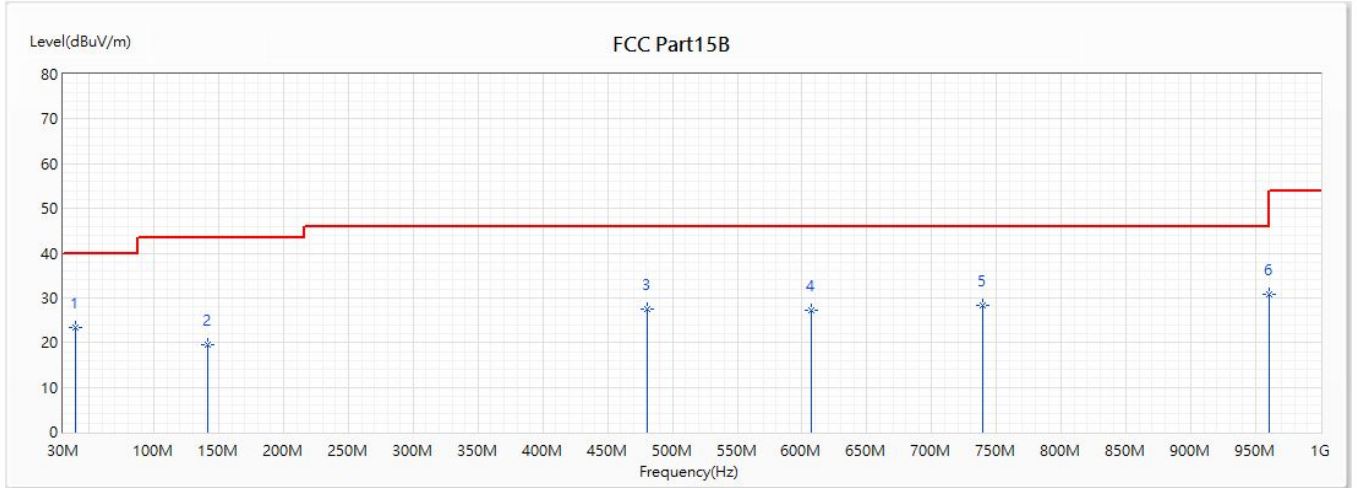

No	Frequency (MHz)	Emission Level (dBuV/m)	Limit (dBuV/m)	Margin (dB)	Reading Level (dBuV)	Correct Factor (dB)	Detector Type
* 1	39.7	23.32	40.00	-16.68	39.57	-16.25	QP
2	141.55	19.39	43.50	-24.11	40.74	-21.35	QP
3	480.08	27.59	46.00	-18.41	41.51	-13.92	QP
4	607.15	27.14	46.00	-18.86	38.63	-11.49	QP
5	739.07	28.26	46.00	-17.74	39.21	-10.95	QP
6	960.23	30.72	54.00	-23.28	39.43	-8.71	QP

Note:

1. All Reading Levels is Quasi-Peak value.
2. “ * ”, means this data is the worst emission level.
3. Emission Level = Reading Level + Correct Factor
4. The Emission under 30MHz were not included is because their levels are too low.

Site :	CB2-H	Engineer :	Andy Tsai
Model No :	ML865C1-NA	Test Date :	2018/9/30
Test Voltage :	DC 3.8V	Polarity :	Horizontal
Test Mode :	Mode 4: LTE_NB-IOT_Band 13		

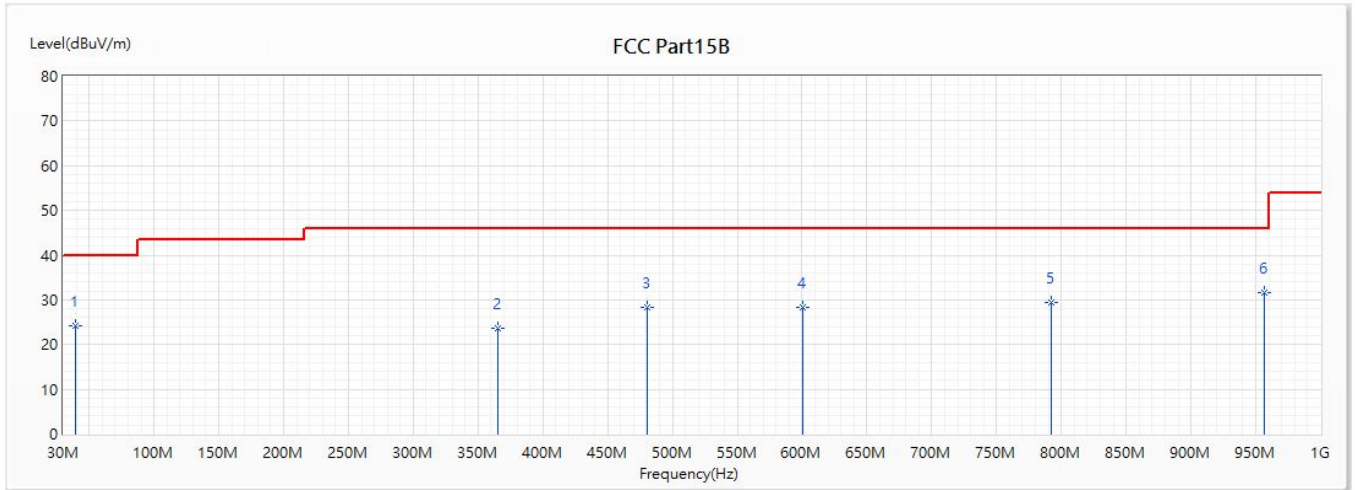

No	Frequency (MHz)	Emission Level (dBuV/m)	Limit (dBuV/m)	Margin (dB)	Reading Level (dBuV)	Correct Factor (dB)	Detector Type
1	39.7	24.09	40.00	-15.91	40.34	-16.25	QP
2	365.62	23.77	46.00	-22.23	40.63	-16.86	QP
3	480.08	28.29	46.00	-17.71	42.21	-13.92	QP
4	600.36	28.28	46.00	-17.72	40.45	-12.17	QP
5	792.42	29.49	46.00	-16.51	39.85	-10.36	QP
* 6	956.35	31.55	46.00	-14.45	40.28	-8.73	QP

Note:

1. All Reading Levels is Quasi-Peak value.
2. “ * ”, means this data is the worst emission level.
3. Emission Level = Reading Level + Correct Factor
4. The Emission under 30MHz were not included is because their levels are too low.

Site :	CB2-H	Engineer :	Andy Tsai
Model No :	ML865C1-NA	Test Date :	2018/9/30
Test Voltage :	DC 3.8V	Polarity :	Vertical
Test Mode :	Mode 4: LTE_NB-IOT_Band 13		

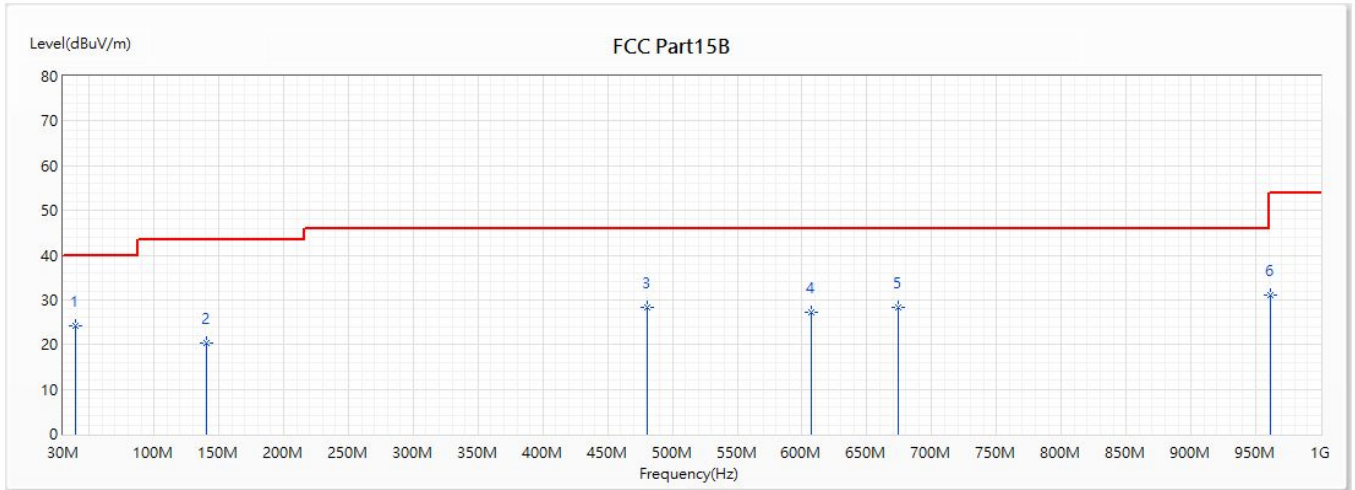

No	Frequency (MHz)	Emission Level (dBuV/m)	Limit (dBuV/m)	Margin (dB)	Reading Level (dBuV)	Correct Factor (dB)	Detector Type
* 1	39.7	24.32	40.00	-15.68	40.57	-16.25	QP
2	140.58	20.31	43.50	-23.19	41.63	-21.32	QP
3	480.08	28.34	46.00	-17.66	42.26	-13.92	QP
4	607.15	27.28	46.00	-18.72	38.77	-11.49	QP
5	674.08	28.45	46.00	-17.55	39.92	-11.47	QP
6	961.2	31.18	54.00	-22.82	39.89	-8.71	QP

Note:

1. All Reading Levels is Quasi-Peak value.
2. “ * ”, means this data is the worst emission level.
3. Emission Level = Reading Level + Correct Factor
4. The Emission under 30MHz were not included is because their levels are too low.

Site :	CB2-H	Engineer :	Andy Tsai
Model No :	ML865C1-NA	Test Date :	2018/9/30
Test Voltage :	DC 3.8V	Polarity :	Horizontal
Test Mode :	Mode 5: LTE_CAT-M1_Band 2		

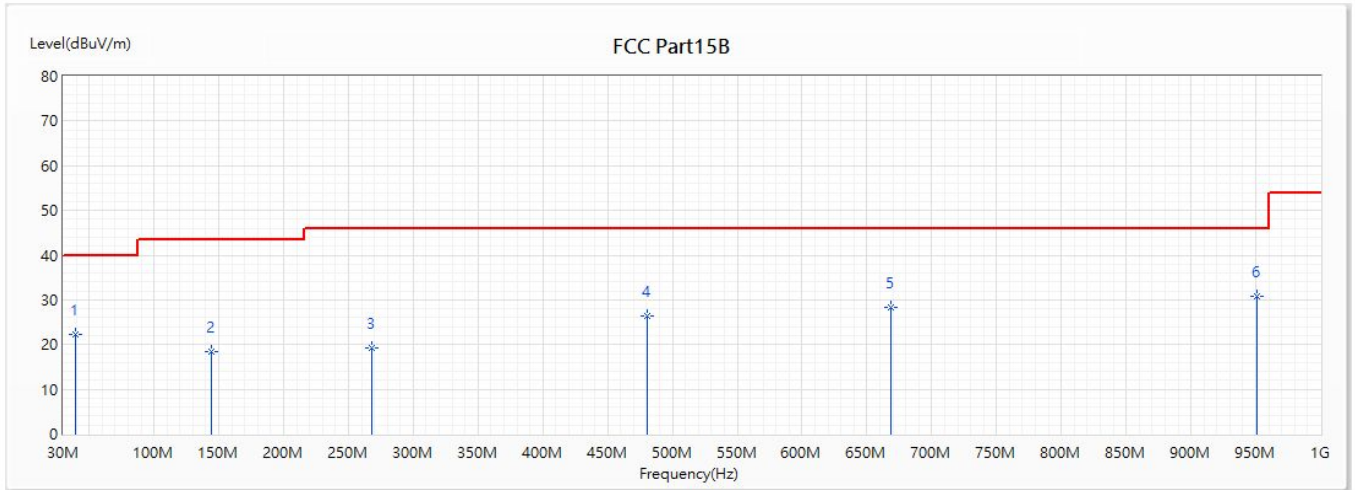

No	Frequency (MHz)	Emission Level (dBuV/m)	Limit (dBuV/m)	Margin (dB)	Reading Level (dBuV)	Correct Factor (dB)	Detector Type
1	39.7	22.23	40.00	-17.77	38.48	-16.25	QP
2	144.46	18.45	43.50	-25.05	39.89	-21.44	QP
3	267.65	19.14	46.00	-26.86	39.34	-20.20	QP
4	480.08	26.39	46.00	-19.61	40.31	-13.92	QP
5	668.26	28.34	46.00	-17.66	39.67	-11.33	QP
* 6	950.53	30.72	46.00	-15.28	39.64	-8.92	QP

Note:

1. All Reading Levels is Quasi-Peak value.
2. “ * ”, means this data is the worst emission level.
3. Emission Level = Reading Level + Correct Factor
4. The Emission under 30MHz were not included is because their levels are too low.

Site :	CB2-H	Engineer :	Andy Tsai
Model No :	ML865C1-NA	Test Date :	2018/9/30
Test Voltage :	DC 3.8V	Polarity :	Vertical
Test Mode :	Mode 5: LTE_CAT-M1_Band 2		

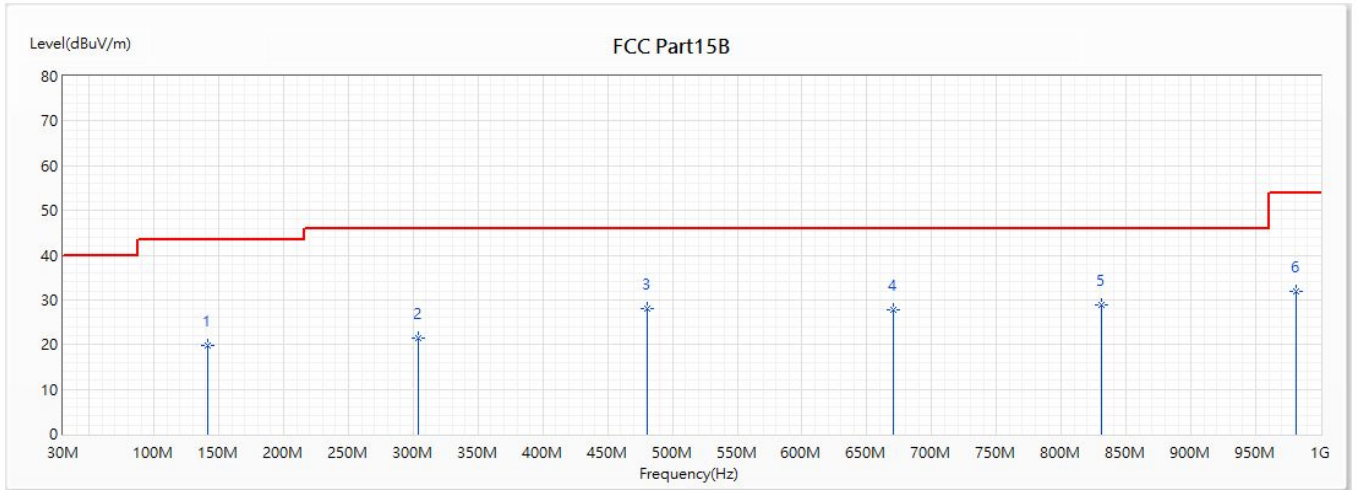

No	Frequency (MHz)	Emission Level (dBuV/m)	Limit (dBuV/m)	Margin (dB)	Reading Level (dBuV)	Correct Factor (dB)	Detector Type
1	141.55	19.72	43.50	-23.78	41.07	-21.35	QP
2	303.54	21.47	46.00	-24.53	41.00	-19.53	QP
3	480.08	28.04	46.00	-17.96	41.96	-13.92	QP
4	670.2	27.69	46.00	-18.31	39.01	-11.32	QP
* 5	831.22	28.92	46.00	-17.08	39.17	-10.25	QP
6	981.57	32.02	54.00	-21.98	39.95	-7.93	QP

Note:

1. All Reading Levels is Quasi-Peak value.
2. “ * ”, means this data is the worst emission level.
3. Emission Level = Reading Level + Correct Factor
4. The Emission under 30MHz were not included is because their levels are too low.

Site :	CB2-H	Engineer :	Andy Tsai
Model No :	ML865C1-NA	Test Date :	2018/9/30
Test Voltage :	DC 3.8V	Polarity :	Horizontal
Test Mode :	Mode 6: LTE_CAT-M1_Band 4		

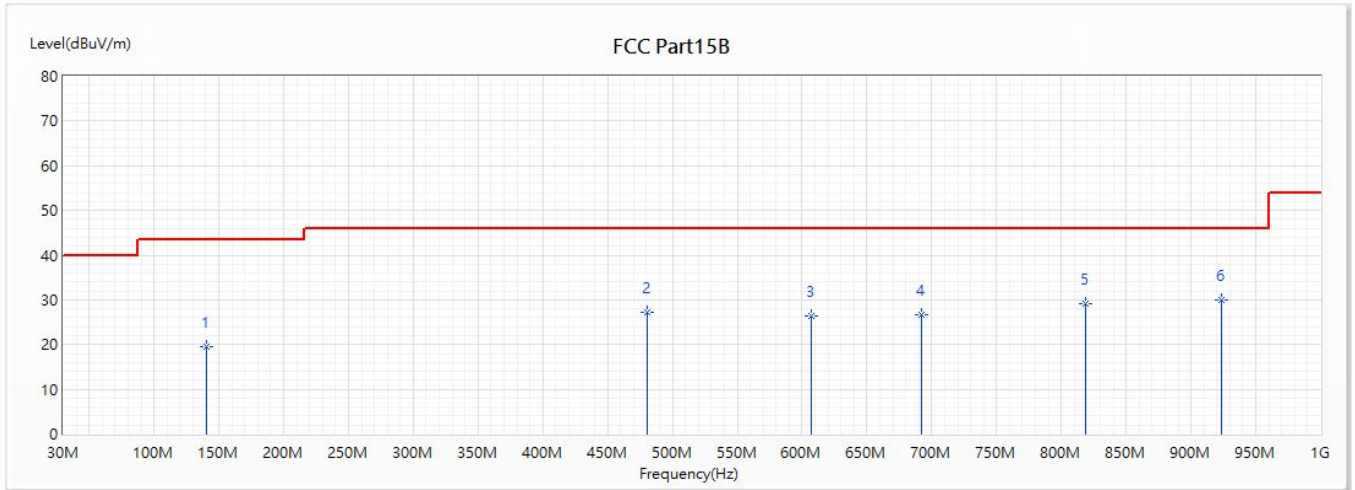

No	Frequency (MHz)	Emission Level (dBuV/m)	Limit (dBuV/m)	Margin (dB)	Reading Level (dBuV)	Correct Factor (dB)	Detector Type
1	140.58	19.52	43.50	-23.98	40.84	-21.32	QP
2	480.08	27.16	46.00	-18.84	41.08	-13.92	QP
3	607.15	26.46	46.00	-19.54	37.95	-11.49	QP
4	692.51	26.57	46.00	-19.43	38.71	-12.14	QP
5	818.61	29.21	46.00	-16.79	39.10	-9.89	QP
* 6	923.37	29.92	46.00	-16.08	39.08	-9.16	QP

Note:

1. All Reading Levels is Quasi-Peak value.
2. “ * ”, means this data is the worst emission level.
3. Emission Level = Reading Level + Correct Factor
4. The Emission under 30MHz were not included is because their levels are too low.

Site :	CB2-H	Engineer :	Andy Tsai
Model No :	ML865C1-NA	Test Date :	2018/9/30
Test Voltage :	DC 3.8V	Polarity :	Vertical
Test Mode :	Mode 6: LTE_CAT-M1_Band 4		

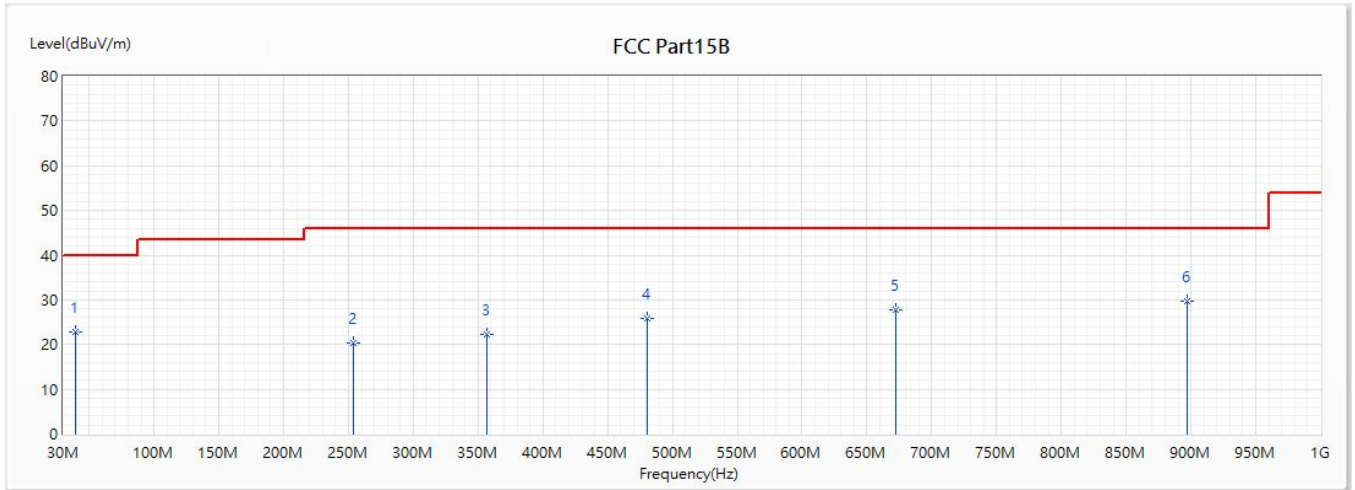

No	Frequency (MHz)	Emission Level (dBuV/m)	Limit (dBuV/m)	Margin (dB)	Reading Level (dBuV)	Correct Factor (dB)	Detector Type
1	39.7	22.86	40.00	-17.14	39.11	-16.25	QP
2	254.07	20.33	46.00	-25.67	40.77	-20.44	QP
3	356.89	22.25	46.00	-23.75	39.17	-16.92	QP
4	480.08	25.75	46.00	-20.25	39.67	-13.92	QP
5	672.14	27.81	46.00	-18.19	39.22	-11.41	QP
* 6	897.18	29.76	46.00	-16.24	39.32	-9.56	QP

Note:

1. All Reading Levels is Quasi-Peak value.
2. “ * ”, means this data is the worst emission level.
3. Emission Level = Reading Level + Correct Factor
4. The Emission under 30MHz were not included is because their levels are too low.

Site :	CB2-H	Engineer :	Andy Tsai
Model No :	ML865C1-NA	Test Date :	2018/9/30
Test Voltage :	DC 3.8V	Polarity :	Horizontal
Test Mode :	Mode 7: LTE_CAT-M1_Band 12		

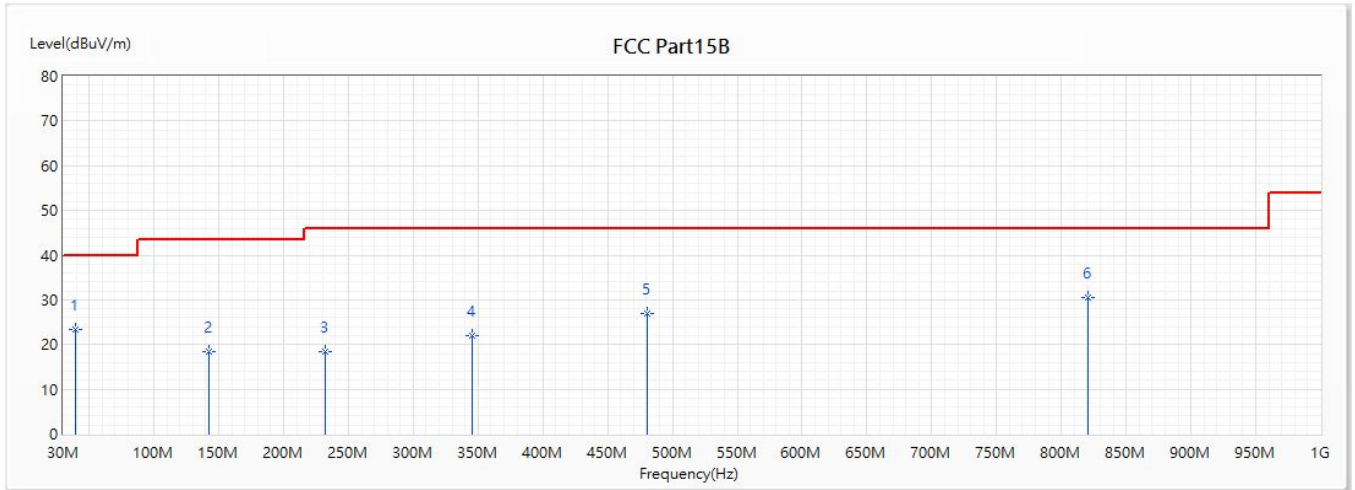

No	Frequency (MHz)	Emission Level (dBuV/m)	Limit (dBuV/m)	Margin (dB)	Reading Level (dBuV)	Correct Factor (dB)	Detector Type
1	39.7	23.27	40.00	-16.73	39.52	-16.25	QP
2	142.52	18.53	43.50	-24.97	39.92	-21.39	QP
3	231.76	18.33	46.00	-27.67	38.90	-20.57	QP
4	345.25	22.05	46.00	-23.95	39.92	-17.87	QP
5	480.08	26.89	46.00	-19.11	40.81	-13.92	QP
* 6	820.55	30.56	46.00	-15.44	40.23	-9.67	QP

Note:

1. All Reading Levels is Quasi-Peak value.
2. “ * ”, means this data is the worst emission level.
3. Emission Level = Reading Level + Correct Factor
4. The Emission under 30MHz were not included is because their levels are too low.

Site :	CB2-H	Engineer :	Andy Tsai
Model No :	ML865C1-NA	Test Date :	2018/9/30
Test Voltage :	DC 3.8V	Polarity :	Vertical
Test Mode :	Mode 7: LTE_CAT-M1_Band 12		

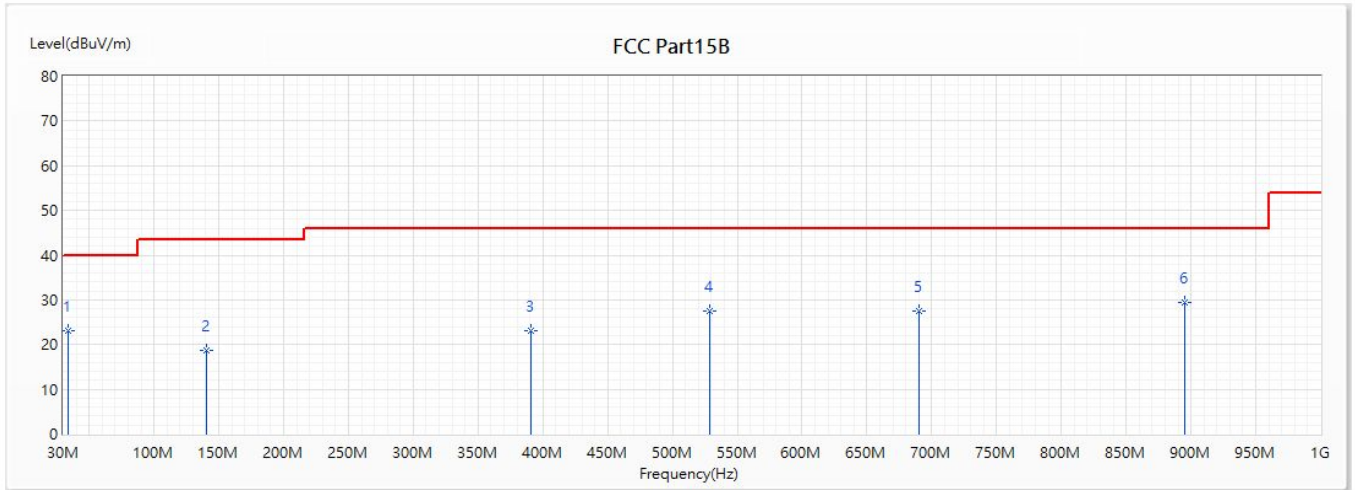

No	Frequency (MHz)	Emission Level (dBuV/m)	Limit (dBuV/m)	Margin (dB)	Reading Level (dBuV)	Correct Factor (dB)	Detector Type
1	33.88	23.10	40.00	-16.90	38.89	-15.79	QP
2	140.58	18.57	43.50	-24.93	39.89	-21.32	QP
3	390.84	23.21	46.00	-22.79	39.48	-16.27	QP
4	528.58	27.39	46.00	-18.61	42.19	-14.80	QP
5	690.57	27.44	46.00	-18.56	39.60	-12.16	QP
* 6	895.24	29.28	46.00	-16.72	38.61	-9.33	QP

Note:

1. All Reading Levels is Quasi-Peak value.
2. “ * ”, means this data is the worst emission level.
3. Emission Level = Reading Level + Correct Factor
4. The Emission under 30MHz were not included is because their levels are too low.

Site :	CB2-H	Engineer :	Andy Tsai
Model No :	ML865C1-NA	Test Date :	2018/9/30
Test Voltage :	DC 3.8V	Polarity :	Horizontal
Test Mode :	Mode 8: LTE_CAT-M1_Band 13		

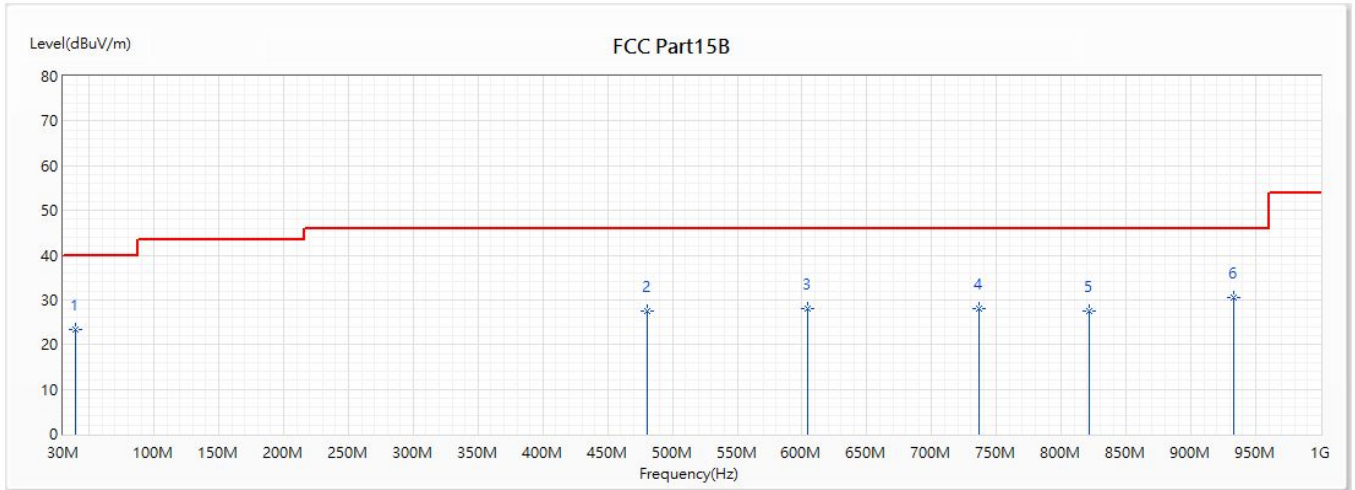

No	Frequency (MHz)	Emission Level (dBuV/m)	Limit (dBuV/m)	Margin (dB)	Reading Level (dBuV)	Correct Factor (dB)	Detector Type
1	39.7	23.49	40.00	-16.51	39.74	-16.25	QP
2	480.08	27.41	46.00	-18.59	41.33	-13.92	QP
3	604.24	27.92	46.00	-18.08	39.46	-11.54	QP
4	736.16	27.97	46.00	-18.03	38.68	-10.71	QP
5	821.52	27.44	46.00	-18.56	37.21	-9.77	QP
* 6	933.07	30.40	46.00	-15.60	39.13	-8.73	QP

Note:

1. All Reading Levels is Quasi-Peak value.
2. “ * ”, means this data is the worst emission level.
3. Emission Level = Reading Level + Correct Factor
4. The Emission under 30MHz were not included is because their levels are too low.

Site :	CB2-H	Engineer :	Andy Tsai
Model No :	ML865C1-NA	Test Date :	2018/9/30
Test Voltage :	DC 3.8V	Polarity :	Vertical
Test Mode :	Mode 8: LTE_CAT-M1_Band 13		

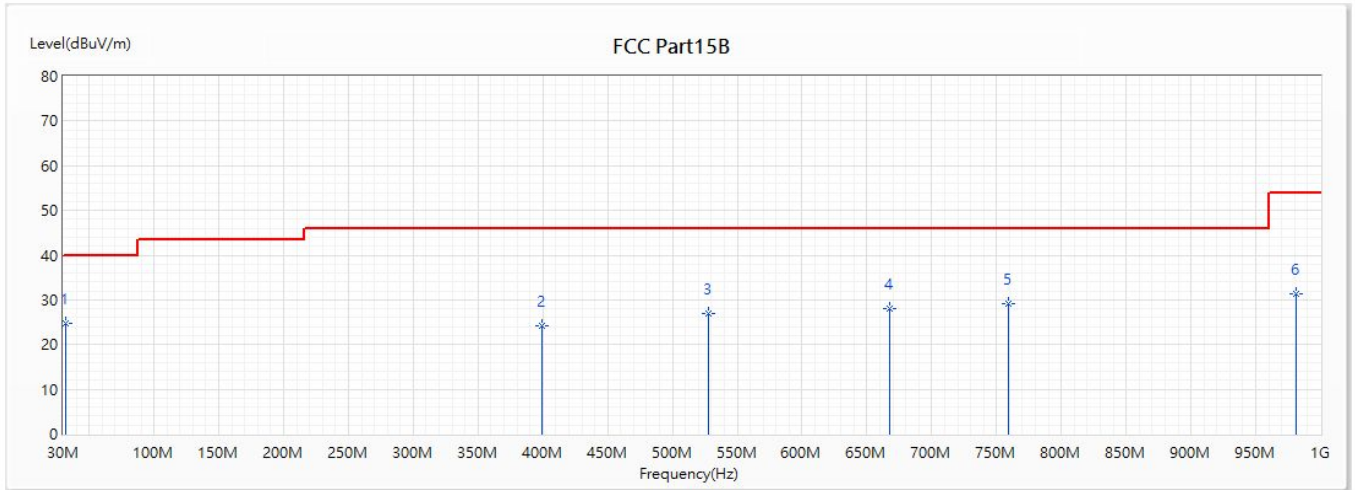

No	Frequency (MHz)	Emission Level (dBuV/m)	Limit (dBuV/m)	Margin (dB)	Reading Level (dBuV)	Correct Factor (dB)	Detector Type
* 1	31.94	24.87	40.00	-15.13	40.49	-15.62	QP
2	399.57	24.32	46.00	-21.68	40.59	-16.27	QP
3	527.61	27.07	46.00	-18.93	41.78	-14.71	QP
4	667.29	28.17	46.00	-17.83	39.51	-11.34	QP
5	759.44	29.01	46.00	-16.99	40.08	-11.07	QP
6	981.57	31.35	54.00	-22.65	39.28	-7.93	QP

Note:

1. All Reading Levels is Quasi-Peak value.
2. “ * ”, means this data is the worst emission level.
3. Emission Level = Reading Level + Correct Factor
4. The Emission under 30MHz were not included is because their levels are too low.

Above 1GHz Spurious:

Site :	CB2-H	Engineer :	Andy Tsai
Model No :	ML865C1-NA	Test Date :	2018/9/30
Test Voltage :	DC 3.8V	Polarity :	Horizontal
Test Mode :	Mode 1: LTE_NB-IOT_Band 2		

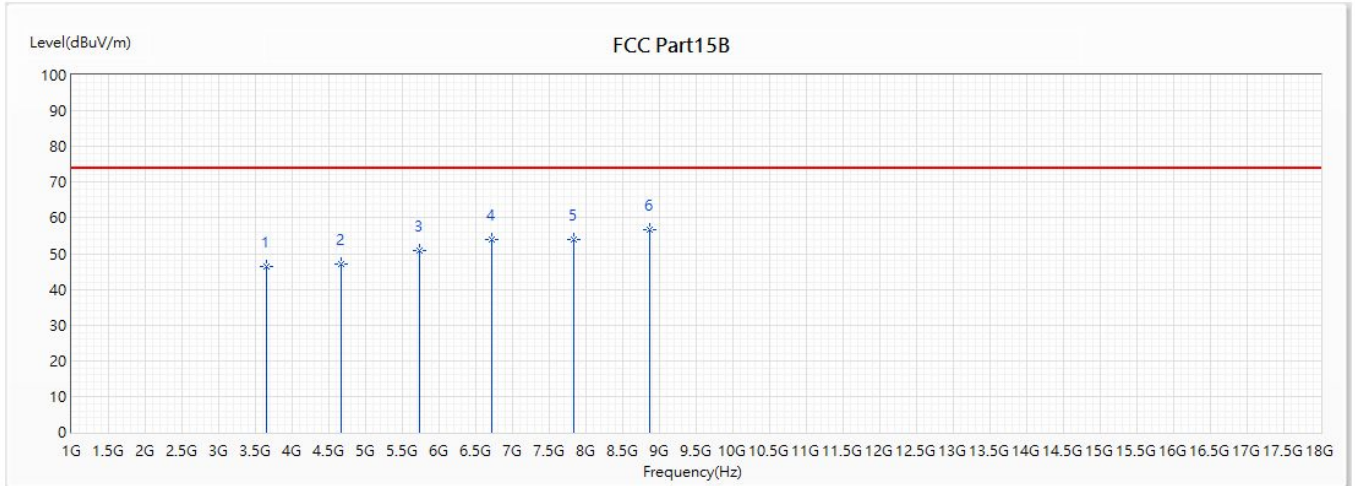

No	Frequency (MHz)	Emission Level (dBuV/m)	Limit (dBuV/m)	Margin (dB)	Reading Level (dBuV)	Correct Factor (dB)	Detector Type
1	3653.7	46.24	74.00	-27.76	40.14	6.10	PK
2	4672	47.14	74.00	-26.86	39.98	7.16	PK
3	5734.5	50.95	74.00	-23.05	41.41	9.54	PK
4	6718.8	53.89	74.00	-20.11	41.25	12.64	PK
5	7827.2	54.03	74.00	-19.97	38.41	15.62	PK
* 6	8869.3	56.69	74.00	-17.31	39.75	16.94	PK

Note:

1. All reading above 1GHz is performed with peak and/or average measurements as necessary.
2. Peak measurements: RBW = 1MHz, VBW = 3 MHz, Sweep: Auto.
3. Average measurements: RBW = 1MHz, VBW = 10 Hz, Sweep: Auto.
4. “ * ”, means this data is the worst emission level.
5. Emission Level = Reading Level + Correct Factor.
6. The average measurement was not performed when the peak measured data under the limit of average detection.
7. The Emission above 13GHz were not included is because their levels are too low.

Site :	CB2-H	Engineer :	Andy Tsai
Model No :	ML865C1-NA	Test Date :	2018/9/30
Test Voltage :	DC 3.8V	Polarity :	Vertical
Test Mode :	Mode 1: LTE_NB-IOT_Band 2		

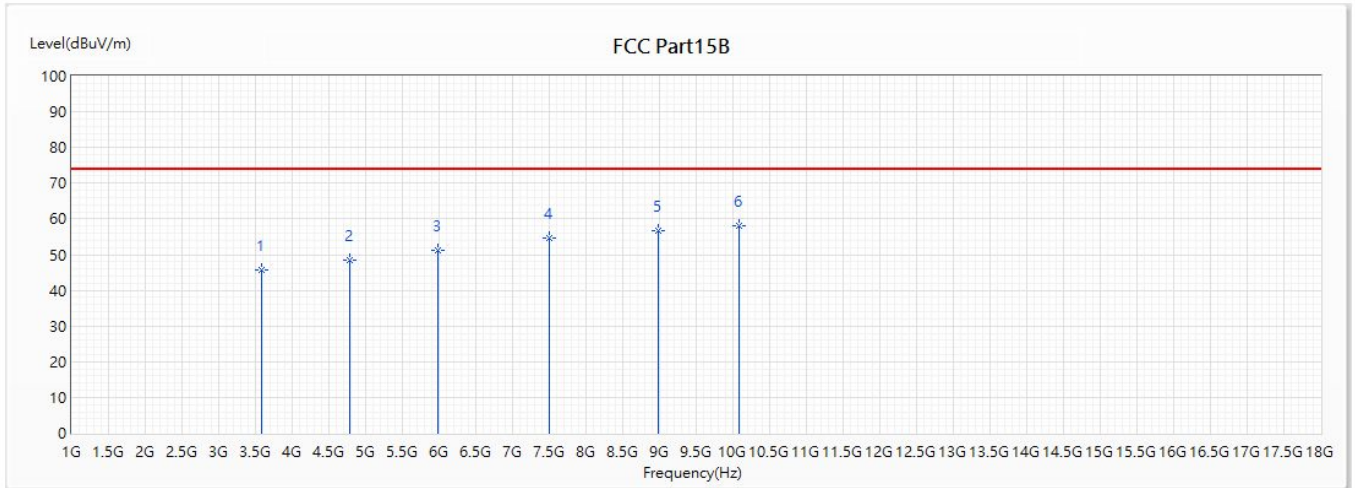

No	Frequency (MHz)	Emission Level (dBuV/m)	Limit (dBuV/m)	Margin (dB)	Reading Level (dBuV)	Correct Factor (dB)	Detector Type
1	3587.4	45.60	74.00	-28.40	39.67	5.93	PK
2	4791	48.61	74.00	-25.39	41.55	7.06	PK
3	5987.8	51.11	74.00	-22.89	42.43	8.68	PK
4	7502.5	54.53	74.00	-19.47	40.55	13.98	PK
5	8978.1	56.69	74.00	-17.31	39.96	16.73	PK
* 6	10081.4	58.05	74.00	-15.95	38.15	19.90	PK

Note:

1. All reading above 1GHz is performed with peak and/or average measurements as necessary.
2. Peak measurements: RBW = 1MHz, VBW = 3 MHz, Sweep: Auto.
3. Average measurements: RBW = 1MHz, VBW = 10 Hz, Sweep: Auto.
4. “ * ”, means this data is the worst emission level.
5. Emission Level = Reading Level + Correct Factor.
6. The average measurement was not performed when the peak measured data under the limit of average detection.
7. The Emission above 13GHz were not included is because their levels are too low.

Site :	CB2-H	Engineer :	Andy Tsai
Model No :	ML865C1-NA	Test Date :	2018/9/30
Test Voltage :	DC 3.8V	Polarity :	Horizontal
Test Mode :	Mode 2: LTE_NB-IOT_Band 4		

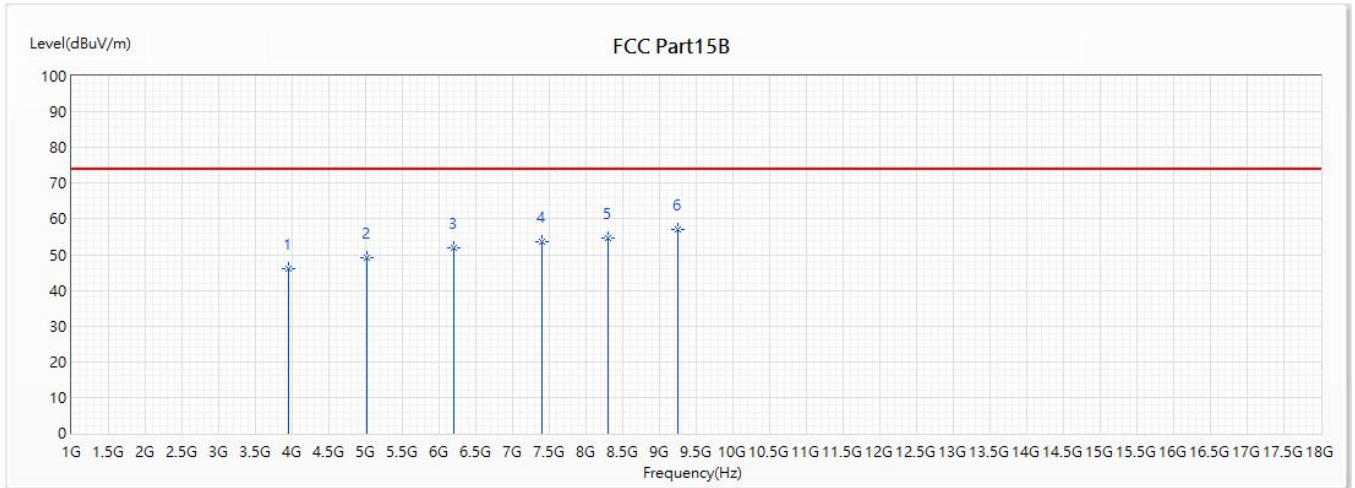

No	Frequency (MHz)	Emission Level (dBuV/m)	Limit (dBuV/m)	Margin (dB)	Reading Level (dBuV)	Correct Factor (dB)	Detector Type
1	3956.3	45.93	74.00	-28.07	40.06	5.87	PK
2	5013.7	49.02	74.00	-24.98	41.08	7.94	PK
3	6207.1	51.89	74.00	-22.11	41.40	10.49	PK
4	7407.3	53.60	74.00	-20.40	38.60	15.00	PK
5	8294.7	54.79	74.00	-19.21	39.23	15.56	PK
* 6	9251.8	57.09	74.00	-16.91	38.75	18.34	PK

Note:

1. All reading above 1GHz is performed with peak and/or average measurements as necessary.
2. Peak measurements: RBW = 1MHz, VBW = 3 MHz, Sweep: Auto.
3. Average measurements: RBW = 1MHz, VBW = 10 Hz, Sweep: Auto.
4. “ * ”, means this data is the worst emission level.
5. Emission Level = Reading Level + Correct Factor.
6. The average measurement was not performed when the peak measured data under the limit of average detection.
7. The Emission above 13GHz were not included is because their levels are too low.

Site :	CB2-H	Engineer :	Andy Tsai
Model No :	ML865C1-NA	Test Date :	2018/9/30
Test Voltage :	DC 3.8V	Polarity :	Vertical
Test Mode :	Mode 2: LTE_NB-IOT_Band 4		

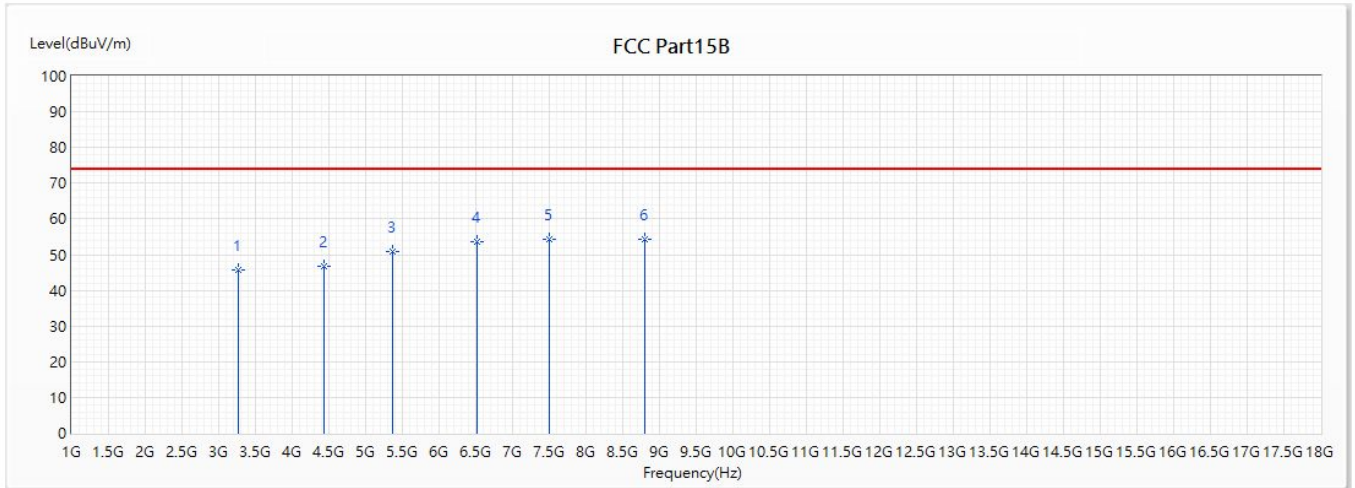

No	Frequency (MHz)	Emission Level (dBuV/m)	Limit (dBuV/m)	Margin (dB)	Reading Level (dBuV)	Correct Factor (dB)	Detector Type
1	3274.6	45.61	74.00	-28.39	40.24	5.37	PK
2	4440.8	46.88	74.00	-27.12	40.43	6.45	PK
3	5362.2	50.84	74.00	-23.16	42.42	8.42	PK
4	6514.8	53.64	74.00	-20.36	43.77	9.87	PK
5	7505.9	54.22	74.00	-19.78	40.24	13.98	PK
* 6	8804.7	54.34	74.00	-19.66	38.49	15.85	PK

Note:

1. All reading above 1GHz is performed with peak and/or average measurements as necessary.
2. Peak measurements: RBW = 1MHz, VBW = 3 MHz, Sweep: Auto.
3. Average measurements: RBW = 1MHz, VBW = 10 Hz, Sweep: Auto.
4. “ * ”, means this data is the worst emission level.
5. Emission Level = Reading Level + Correct Factor.
6. The average measurement was not performed when the peak measured data under the limit of average detection.
7. The Emission above 13GHz were not included is because their levels are too low.

Site :	CB2-H	Engineer :	Andy Tsai
Model No :	ML865C1-NA	Test Date :	2018/9/30
Test Voltage :	DC 3.8V	Polarity :	Horizontal
Test Mode :	Mode 3: LTE_NB-IOT_Band 12		

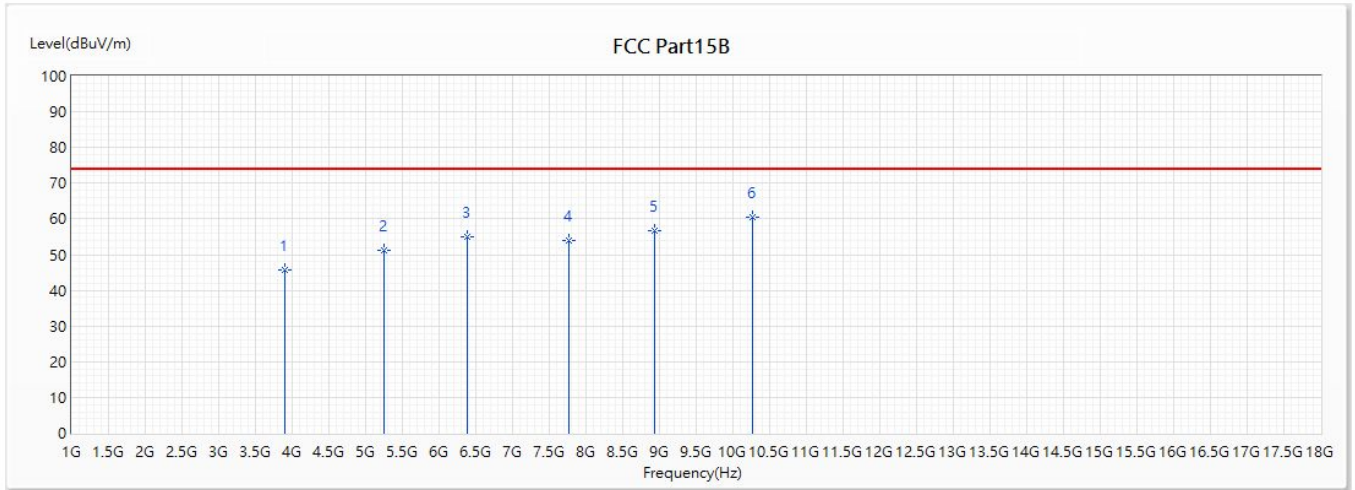

No	Frequency (MHz)	Emission Level (dBuV/m)	Limit (dBuV/m)	Margin (dB)	Reading Level (dBuV)	Correct Factor (dB)	Detector Type
1	3898.5	45.76	74.00	-28.24	39.86	5.90	PK
2	5243.2	51.31	74.00	-22.69	42.66	8.65	PK
3	6389	54.93	74.00	-19.07	43.68	11.25	PK
4	7762.6	53.88	74.00	-20.12	38.33	15.55	PK
5	8940.7	56.62	74.00	-17.38	39.38	17.24	PK
* 6	10265	60.58	74.00	-13.42	39.84	20.74	PK

Note:

1. All reading above 1GHz is performed with peak and/or average measurements as necessary.
2. Peak measurements: RBW = 1MHz, VBW = 3 MHz, Sweep: Auto.
3. Average measurements: RBW = 1MHz, VBW = 10 Hz, Sweep: Auto.
4. “ * ”, means this data is the worst emission level.
5. Emission Level = Reading Level + Correct Factor.
6. The average measurement was not performed when the peak measured data under the limit of average detection.
7. The Emission above 13GHz were not included is because their levels are too low.

Site :	CB2-H	Engineer :	Andy Tsai
Model No :	ML865C1-NA	Test Date :	2018/9/30
Test Voltage :	DC 3.8V	Polarity :	Vertical
Test Mode :	Mode 3: LTE_NB-IOT_Band 12		

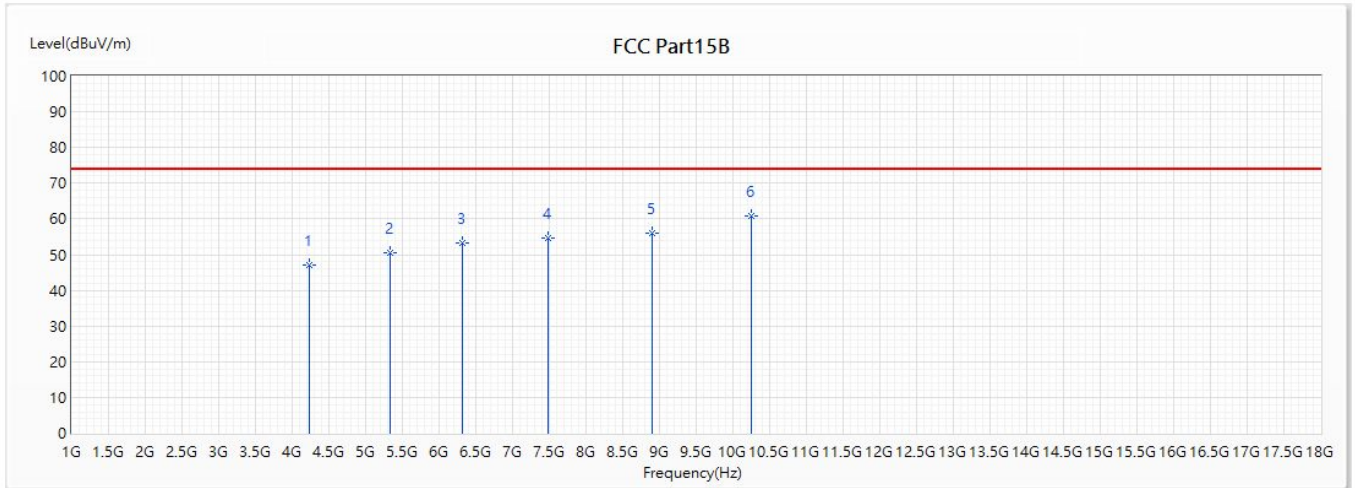

No	Frequency (MHz)	Emission Level (dBuV/m)	Limit (dBuV/m)	Margin (dB)	Reading Level (dBuV)	Correct Factor (dB)	Detector Type
1	4228.3	46.96	74.00	-27.04	40.92	6.04	PK
2	5326.5	50.59	74.00	-23.41	42.27	8.32	PK
3	6312.5	53.39	74.00	-20.61	44.02	9.37	PK
4	7490.6	54.68	74.00	-19.32	40.73	13.95	PK
5	8903.3	55.95	74.00	-18.05	39.60	16.35	PK
* 6	10248	60.75	74.00	-13.25	40.35	20.40	PK

Note:

1. All reading above 1GHz is performed with peak and/or average measurements as necessary.
2. Peak measurements: RBW = 1MHz, VBW = 3 MHz, Sweep: Auto.
3. Average measurements: RBW = 1MHz, VBW = 10 Hz, Sweep: Auto.
4. “ * ”, means this data is the worst emission level.
5. Emission Level = Reading Level + Correct Factor.
6. The average measurement was not performed when the peak measured data under the limit of average detection.
7. The Emission above 13GHz were not included is because their levels are too low.

Site :	CB2-H	Engineer :	Andy Tsai
Model No :	ML865C1-NA	Test Date :	2018/9/30
Test Voltage :	DC 3.8V	Polarity :	Horizontal
Test Mode :	Mode 4: LTE_NB-IOT_Band 13		

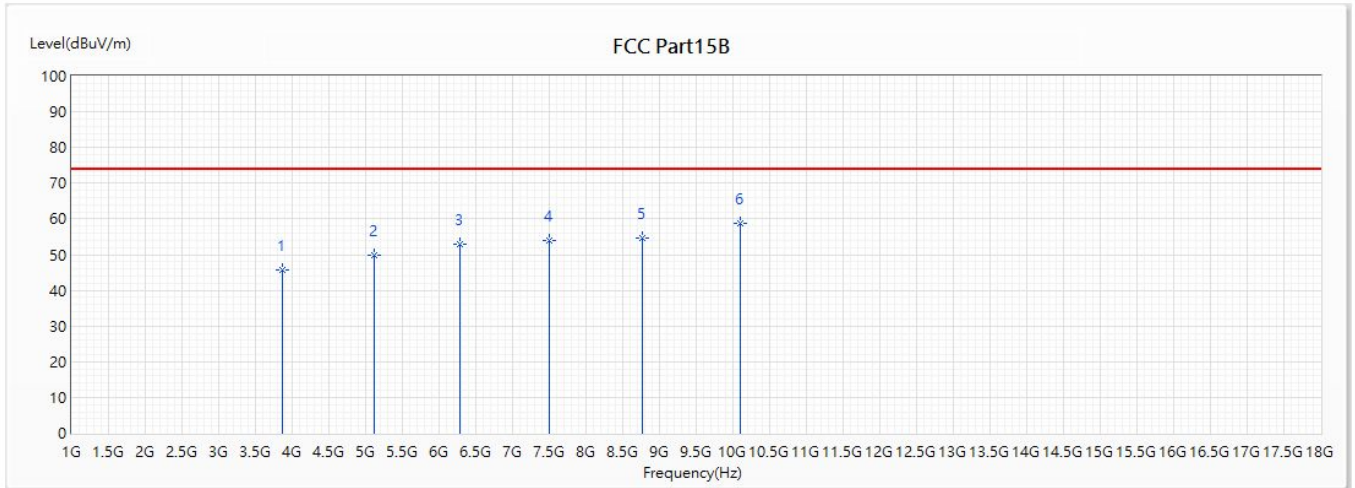

No	Frequency (MHz)	Emission Level (dBuV/m)	Limit (dBuV/m)	Margin (dB)	Reading Level (dBuV)	Correct Factor (dB)	Detector Type
1	3867.9	45.68	74.00	-28.32	39.74	5.94	PK
2	5117.4	49.90	74.00	-24.10	41.64	8.26	PK
3	6276.8	52.88	74.00	-21.12	42.10	10.78	PK
4	7504.2	53.81	74.00	-20.19	38.53	15.28	PK
5	8774.1	54.75	74.00	-19.25	38.21	16.54	PK
* 6	10095	58.69	74.00	-15.31	38.49	20.20	PK

Note:

1. All reading above 1GHz is performed with peak and/or average measurements as necessary.
2. Peak measurements: RBW = 1MHz, VBW = 3 MHz, Sweep: Auto.
3. Average measurements: RBW = 1MHz, VBW = 10 Hz, Sweep: Auto.
4. “ * ”, means this data is the worst emission level.
5. Emission Level = Reading Level + Correct Factor.
6. The average measurement was not performed when the peak measured data under the limit of average detection.
7. The Emission above 13GHz were not included is because their levels are too low.

Site :	CB2-H	Engineer :	Andy Tsai
Model No :	ML865C1-NA	Test Date :	2018/9/30
Test Voltage :	DC 3.8V	Polarity :	Vertical
Test Mode :	Mode 4: LTE_NB-IOT_Band 13		

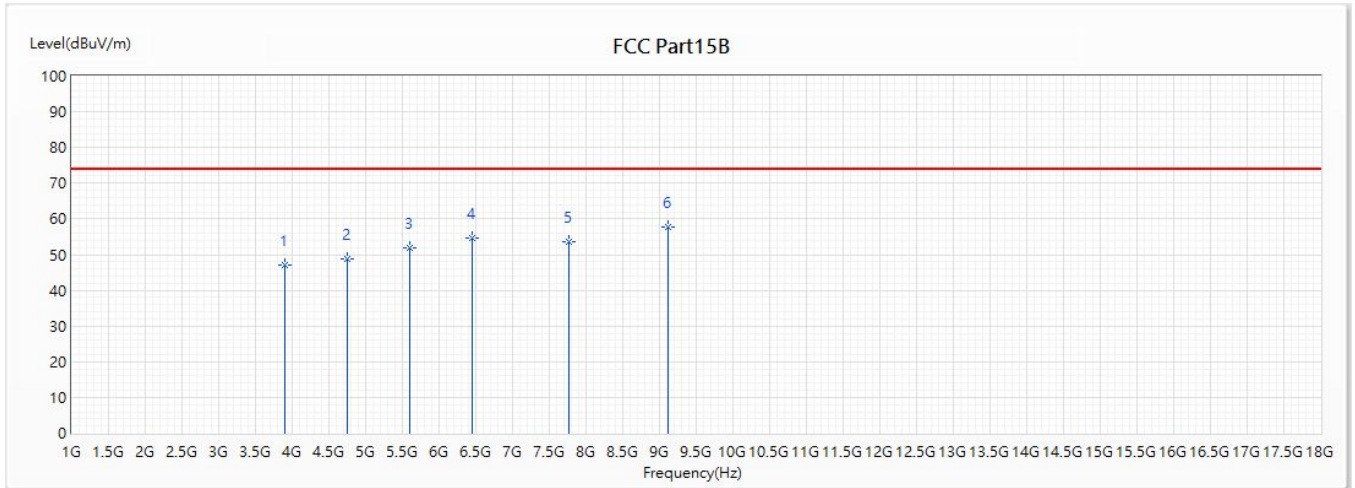

No	Frequency (MHz)	Emission Level (dBuV/m)	Limit (dBuV/m)	Margin (dB)	Reading Level (dBuV)	Correct Factor (dB)	Detector Type
1	3905.3	46.95	74.00	-27.05	41.29	5.66	PK
2	4755.3	48.68	74.00	-25.32	41.68	7.00	PK
3	5607	51.92	74.00	-22.08	43.15	8.77	PK
4	6453.6	54.50	74.00	-19.50	44.81	9.69	PK
5	7766	53.47	74.00	-20.53	39.14	14.33	PK
* 6	9122.6	57.69	74.00	-16.31	40.57	17.12	PK

Note:

1. All reading above 1GHz is performed with peak and/or average measurements as necessary.
2. Peak measurements: RBW = 1MHz, VBW = 3 MHz, Sweep: Auto.
3. Average measurements: RBW = 1MHz, VBW = 10 Hz, Sweep: Auto.
4. “ * ”, means this data is the worst emission level.
5. Emission Level = Reading Level + Correct Factor.
6. The average measurement was not performed when the peak measured data under the limit of average detection.
7. The Emission above 13GHz were not included is because their levels are too low.

Site :	CB2-H	Engineer :	Andy Tsai
Model No :	ML865C1-NA	Test Date :	2018/9/30
Test Voltage :	DC 3.8V	Polarity :	Horizontal
Test Mode :	Mode 5: LTE_CAT-M1_Band 2		

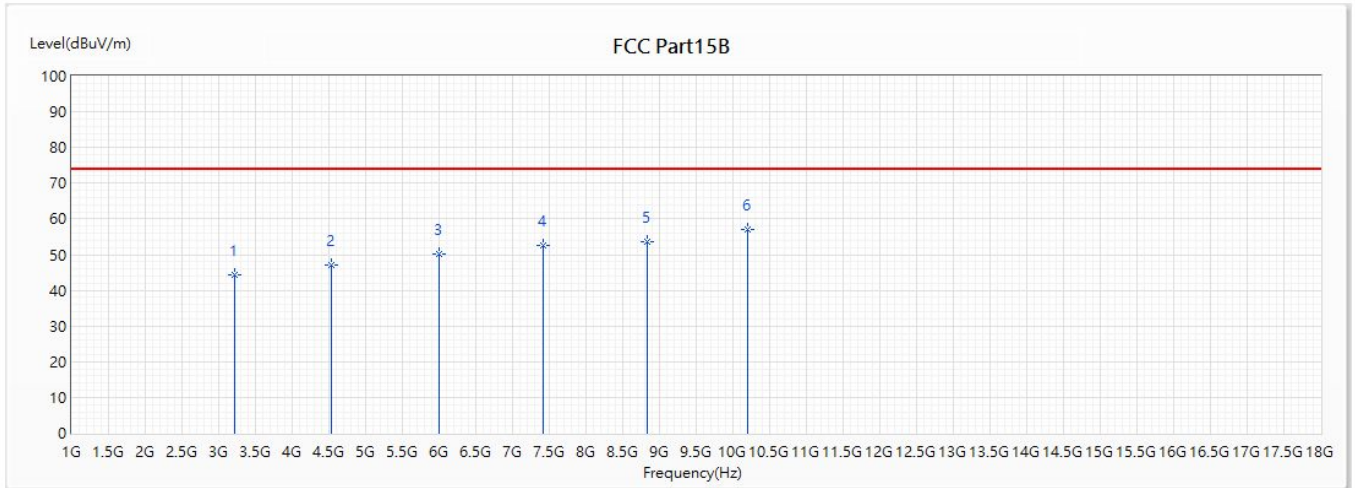

No	Frequency (MHz)	Emission Level (dBuV/m)	Limit (dBuV/m)	Margin (dB)	Reading Level (dBuV)	Correct Factor (dB)	Detector Type
1	3221.9	44.36	74.00	-29.64	38.86	5.50	PK
2	4529.2	46.98	74.00	-27.02	40.14	6.84	PK
3	6004.8	50.28	74.00	-23.72	40.62	9.66	PK
4	7412.4	52.48	74.00	-21.52	37.45	15.03	PK
5	8828.5	53.74	74.00	-20.26	36.98	16.76	PK
* 6	10198.7	57.11	74.00	-16.89	36.58	20.53	PK

Note:

1. All reading above 1GHz is performed with peak and/or average measurements as necessary.
2. Peak measurements: RBW = 1MHz, VBW = 3 MHz, Sweep: Auto.
3. Average measurements: RBW = 1MHz, VBW = 10 Hz, Sweep: Auto.
4. “ * ”, means this data is the worst emission level.
5. Emission Level = Reading Level + Correct Factor.
6. The average measurement was not performed when the peak measured data under the limit of average detection.
7. The Emission above 13GHz were not included is because their levels are too low.

Site :	CB2-H	Engineer :	Andy Tsai
Model No :	ML865C1-NA	Test Date :	2018/9/30
Test Voltage :	DC 3.8V	Polarity :	Vertical
Test Mode :	Mode 5: LTE_CAT-M1_Band 2		

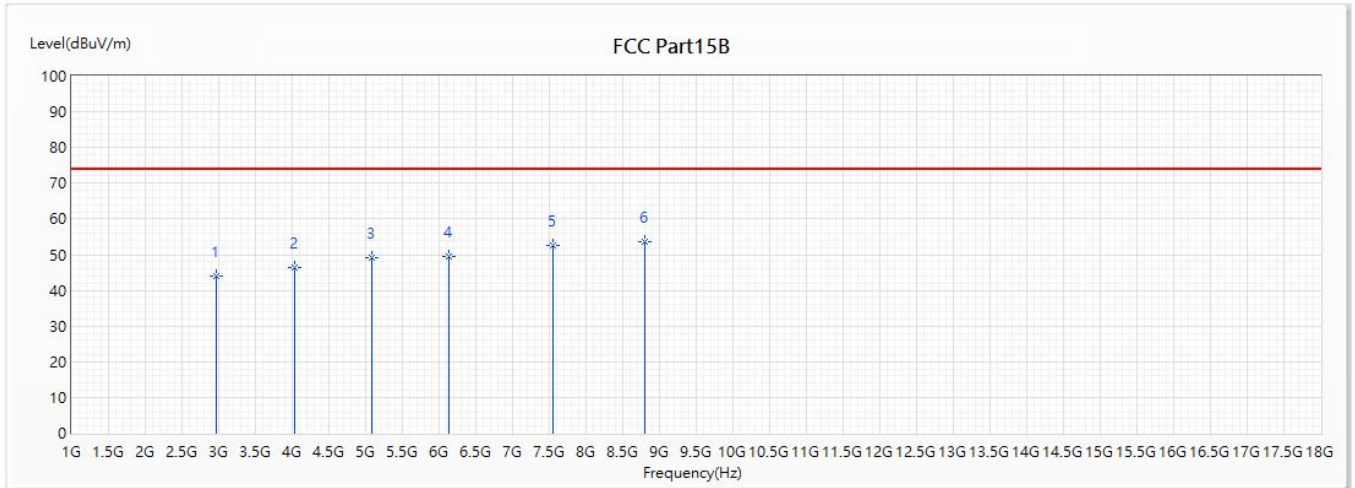

No	Frequency (MHz)	Emission Level (dBuV/m)	Limit (dBuV/m)	Margin (dB)	Reading Level (dBuV)	Correct Factor (dB)	Detector Type
1	2965.2	43.86	74.00	-30.14	39.34	4.52	PK
2	4041.3	46.35	74.00	-27.65	40.67	5.68	PK
3	5088.5	49.07	74.00	-24.93	41.40	7.67	PK
4	6127.2	49.65	74.00	-24.35	40.70	8.95	PK
5	7555.2	52.56	74.00	-21.44	38.51	14.05	PK
* 6	8797.9	53.49	74.00	-20.51	37.67	15.82	PK

Note:

1. All reading above 1GHz is performed with peak and/or average measurements as necessary.
2. Peak measurements: RBW = 1MHz, VBW = 3 MHz, Sweep: Auto.
3. Average measurements: RBW = 1MHz, VBW = 10 Hz, Sweep: Auto.
4. “ * ”, means this data is the worst emission level.
5. Emission Level = Reading Level + Correct Factor.
6. The average measurement was not performed when the peak measured data under the limit of average detection.
7. The Emission above 13GHz were not included is because their levels are too low.

Site :	CB2-H	Engineer :	Andy Tsai
Model No :	ML865C1-NA	Test Date :	2018/9/30
Test Voltage :	DC 3.8V	Polarity :	Horizontal
Test Mode :	Mode 6: LTE_CAT-M1_Band 4		

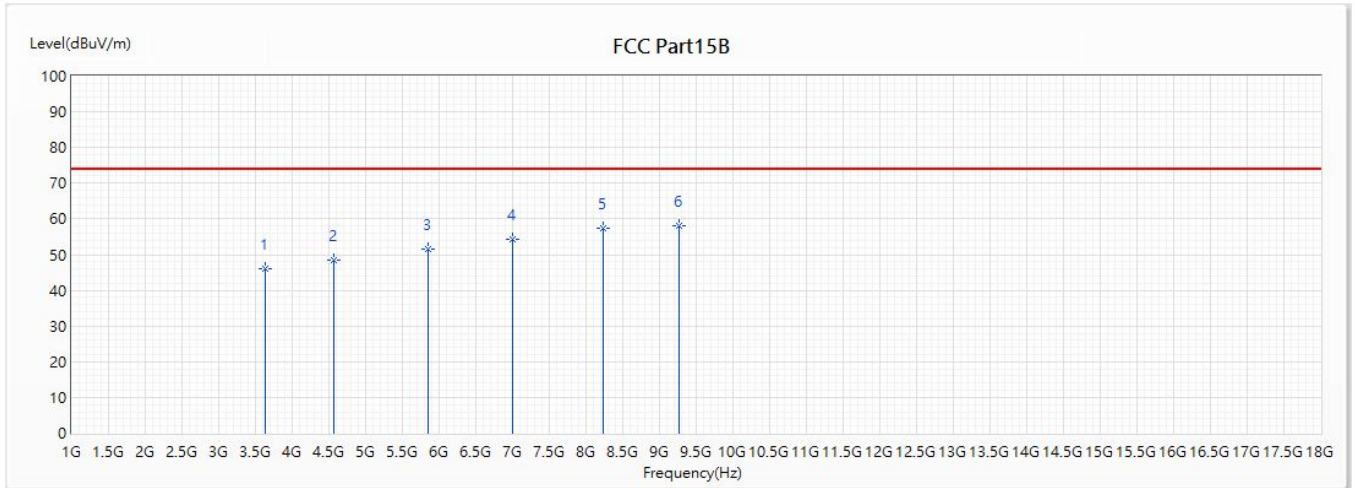

No	Frequency (MHz)	Emission Level (dBuV/m)	Limit (dBuV/m)	Margin (dB)	Reading Level (dBuV)	Correct Factor (dB)	Detector Type
1	3628.2	46.01	74.00	-27.99	39.89	6.12	PK
2	4561.5	48.35	74.00	-25.65	41.45	6.90	PK
3	5850.1	51.68	74.00	-22.32	42.10	9.58	PK
4	6992.5	54.38	74.00	-19.62	40.58	13.80	PK
5	8230.1	57.30	74.00	-16.70	41.70	15.60	PK
* 6	9260.3	58.06	74.00	-15.94	39.70	18.36	PK

Note:

1. All reading above 1GHz is performed with peak and/or average measurements as necessary.
2. Peak measurements: RBW = 1MHz, VBW = 3 MHz, Sweep: Auto.
3. Average measurements: RBW = 1MHz, VBW = 10 Hz, Sweep: Auto.
4. “ * ”, means this data is the worst emission level.
5. Emission Level = Reading Level + Correct Factor.
6. The average measurement was not performed when the peak measured data under the limit of average detection.
7. The Emission above 13GHz were not included is because their levels are too low.

Site :	CB2-H	Engineer :	Andy Tsai
Model No :	ML865C1-NA	Test Date :	2018/9/30
Test Voltage :	DC 3.8V	Polarity :	Vertical
Test Mode :	Mode 6: LTE_CAT-M1_Band 4		

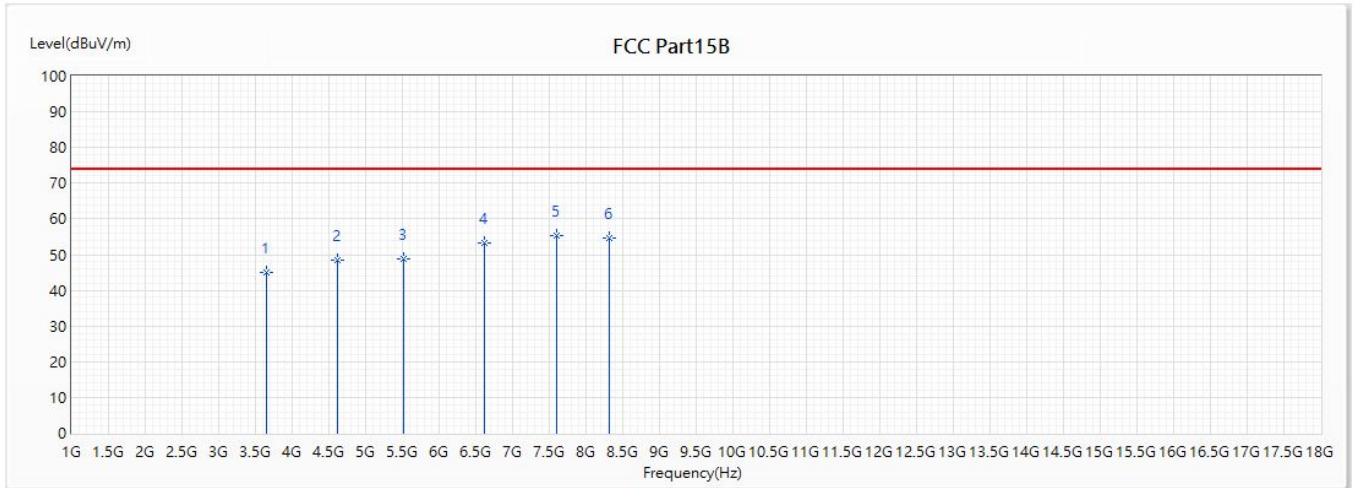

No	Frequency (MHz)	Emission Level (dBuV/m)	Limit (dBuV/m)	Margin (dB)	Reading Level (dBuV)	Correct Factor (dB)	Detector Type
1	3641.8	44.92	74.00	-29.08	39.04	5.88	PK
2	4621	48.30	74.00	-25.70	41.53	6.77	PK
3	5510.1	48.72	74.00	-25.28	39.94	8.78	PK
4	6618.5	53.41	74.00	-20.59	43.00	10.41	PK
* 5	7607.9	55.25	74.00	-18.75	41.13	14.12	PK
6	8320.2	54.78	74.00	-19.22	40.33	14.45	PK

Note:

1. All reading above 1GHz is performed with peak and/or average measurements as necessary.
2. Peak measurements: RBW = 1MHz, VBW = 3 MHz, Sweep: Auto.
3. Average measurements: RBW = 1MHz, VBW = 10 Hz, Sweep: Auto.
4. “ * ”, means this data is the worst emission level.
5. Emission Level = Reading Level + Correct Factor.
6. The average measurement was not performed when the peak measured data under the limit of average detection.
7. The Emission above 13GHz were not included is because their levels are too low.

Site :	CB2-H	Engineer :	Andy Tsai
Model No :	ML865C1-NA	Test Date :	2018/9/30
Test Voltage :	DC 3.8V	Polarity :	Horizontal
Test Mode :	Mode 7: LTE_CAT-M1_Band 12		

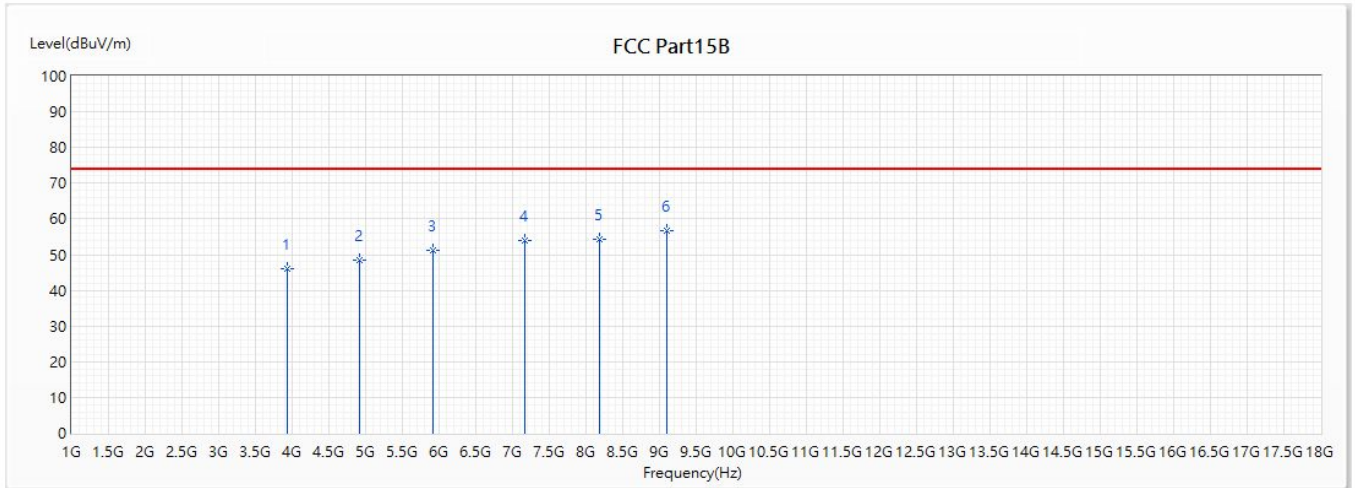

No	Frequency (MHz)	Emission Level (dBuV/m)	Limit (dBuV/m)	Margin (dB)	Reading Level (dBuV)	Correct Factor (dB)	Detector Type
1	3932.5	46.05	74.00	-27.95	40.17	5.88	PK
2	4923.6	48.60	74.00	-25.40	40.87	7.73	PK
3	5909.6	51.08	74.00	-22.92	41.47	9.61	PK
4	7171	53.83	74.00	-20.17	39.50	14.33	PK
5	8177.4	54.33	74.00	-19.67	38.67	15.66	PK
* 6	9102.2	56.82	74.00	-17.18	38.98	17.84	PK

Note:

1. All reading above 1GHz is performed with peak and/or average measurements as necessary.
2. Peak measurements: RBW = 1MHz, VBW = 3 MHz, Sweep: Auto.
3. Average measurements: RBW = 1MHz, VBW = 10 Hz, Sweep: Auto.
4. “ * ”, means this data is the worst emission level.
5. Emission Level = Reading Level + Correct Factor.
6. The average measurement was not performed when the peak measured data under the limit of average detection.
7. The Emission above 13GHz were not included is because their levels are too low.

Site :	CB2-H	Engineer :	Andy Tsai
Model No :	ML865C1-NA	Test Date :	2018/9/30
Test Voltage :	DC 3.8V	Polarity :	Vertical
Test Mode :	Mode 7: LTE_CAT-M1_Band 12		

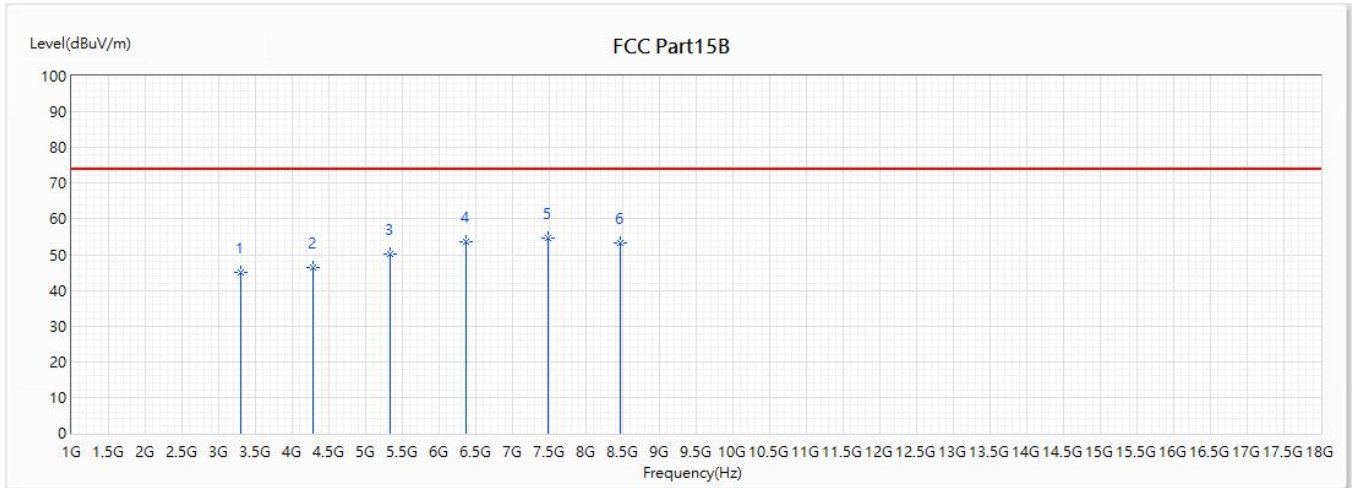

No	Frequency (MHz)	Emission Level (dBuV/m)	Limit (dBuV/m)	Margin (dB)	Reading Level (dBuV)	Correct Factor (dB)	Detector Type
1	3293.3	44.98	74.00	-29.02	39.55	5.43	PK
2	4291.2	46.47	74.00	-27.53	40.31	6.16	PK
3	5340.1	50.08	74.00	-23.92	41.73	8.35	PK
4	6368.6	53.78	74.00	-20.22	44.29	9.49	PK
* 5	7483.8	54.47	74.00	-19.53	40.54	13.93	PK
6	8469.8	53.29	74.00	-20.71	38.92	14.37	PK

Note:

1. All reading above 1GHz is performed with peak and/or average measurements as necessary.
2. Peak measurements: RBW = 1MHz, VBW = 3 MHz, Sweep: Auto.
3. Average measurements: RBW = 1MHz, VBW = 10 Hz, Sweep: Auto.
4. “ * ”, means this data is the worst emission level.
5. Emission Level = Reading Level + Correct Factor.
6. The average measurement was not performed when the peak measured data under the limit of average detection.
7. The Emission above 13GHz were not included is because their levels are too low.

Site :	CB2-H	Engineer :	Andy Tsai
Model No :	ML865C1-NA	Test Date :	2018/9/30
Test Voltage :	DC 3.8V	Polarity :	Horizontal
Test Mode :	Mode 8: LTE_CAT-M1_Band 13		

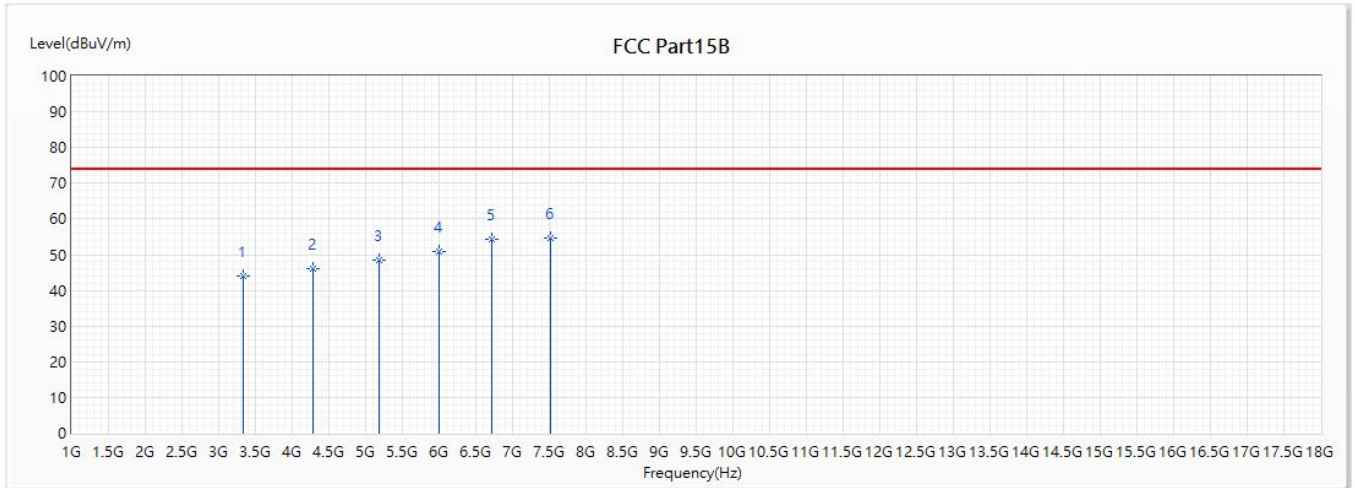

No	Frequency (MHz)	Emission Level (dBuV/m)	Limit (dBuV/m)	Margin (dB)	Reading Level (dBuV)	Correct Factor (dB)	Detector Type
1	3332.4	44.05	74.00	-29.95	38.26	5.79	PK
2	4281	45.95	74.00	-28.05	39.59	6.36	PK
3	5180.3	48.48	74.00	-25.52	40.02	8.46	PK
4	5998	50.88	74.00	-23.12	41.23	9.65	PK
5	6717.1	54.44	74.00	-19.56	41.81	12.63	PK
* 6	7521.2	54.66	74.00	-19.34	39.36	15.30	PK

Note:

1. All reading above 1GHz is performed with peak and/or average measurements as necessary.
2. Peak measurements: RBW = 1MHz, VBW = 3 MHz, Sweep: Auto.
3. Average measurements: RBW = 1MHz, VBW = 10 Hz, Sweep: Auto.
4. “ * ”, means this data is the worst emission level.
5. Emission Level = Reading Level + Correct Factor.
6. The average measurement was not performed when the peak measured data under the limit of average detection.
7. The Emission above 13GHz were not included is because their levels are too low.

Site :	CB2-H	Engineer :	Andy Tsai
Model No :	ML865C1-NA	Test Date :	2018/9/30
Test Voltage :	DC 3.8V	Polarity :	Vertical
Test Mode :	Mode 8: LTE_CAT-M1_Band 13		

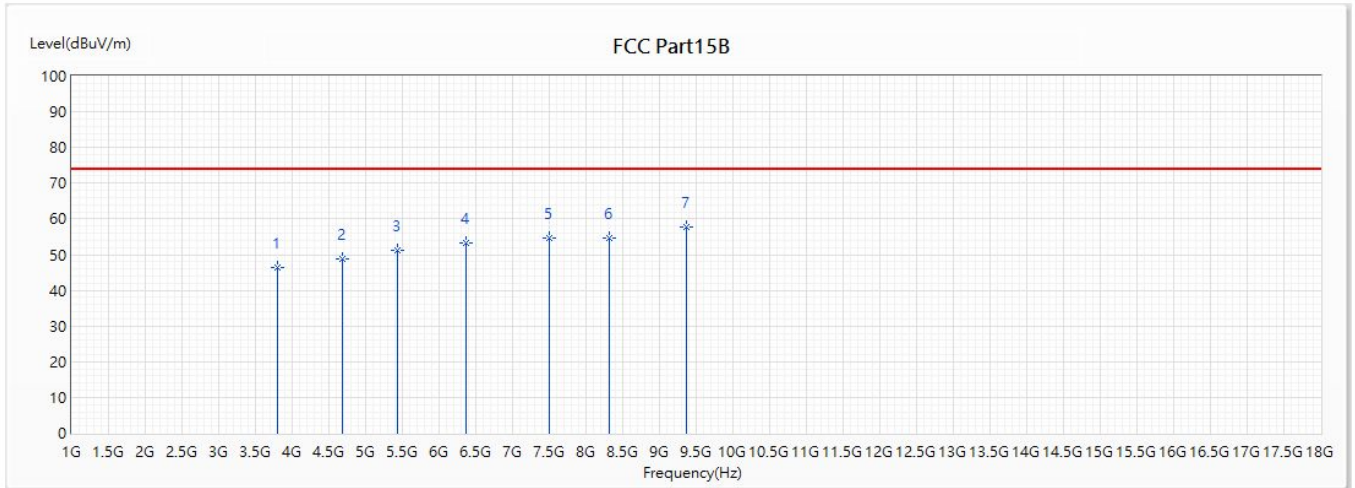

No	Frequency (MHz)	Emission Level (dBuV/m)	Limit (dBuV/m)	Margin (dB)	Reading Level (dBuV)	Correct Factor (dB)	Detector Type
1	3803.3	46.29	74.00	-27.71	40.54	5.75	PK
2	4680.5	48.66	74.00	-25.34	41.79	6.87	PK
3	5425.1	51.16	74.00	-22.84	42.58	8.58	PK
4	6363.5	53.32	74.00	-20.68	43.84	9.48	PK
5	7507.6	54.81	74.00	-19.19	40.82	13.99	PK
6	8311.7	54.77	74.00	-19.23	40.31	14.46	PK
* 7	9370.8	57.79	74.00	-16.21	40.10	17.69	PK

Note:

1. All reading above 1GHz is performed with peak and/or average measurements as necessary.
2. Peak measurements: RBW = 1MHz, VBW = 3 MHz, Sweep: Auto.
3. Average measurements: RBW = 1MHz, VBW = 10 Hz, Sweep: Auto.
4. “ * ”, means this data is the worst emission level.
5. Emission Level = Reading Level + Correct Factor.
6. The average measurement was not performed when the peak measured data under the limit of average detection.
7. The Emission above 13GHz were not included is because their levels are too low.