

Band41\_15MHz\_16QAM\_RB75\_0\_CH39725

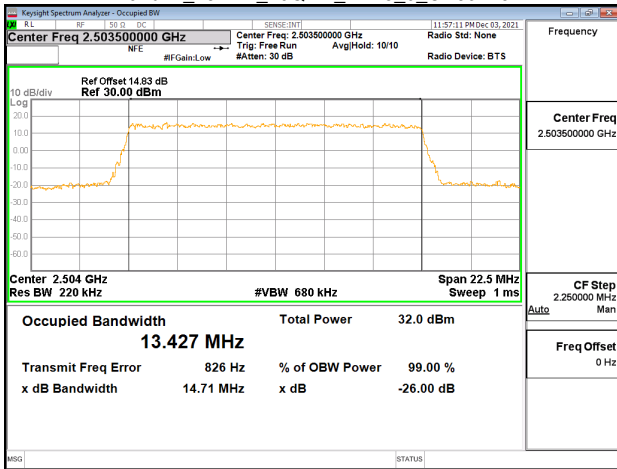

Band41\_15MHz\_64QAM\_RB75\_0\_CH39725

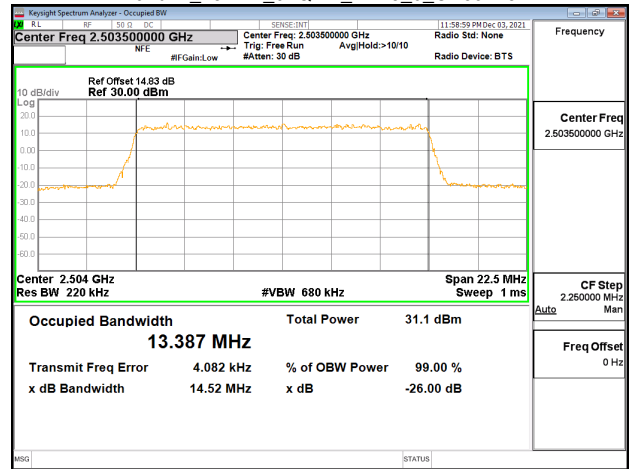

Band41\_15MHz\_16QAM\_RB75\_0\_CH40620

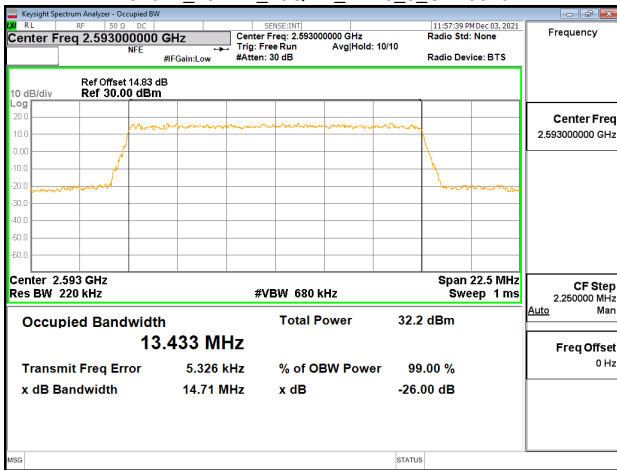

Band41\_15MHz\_64QAM\_RB75\_0\_CH40620

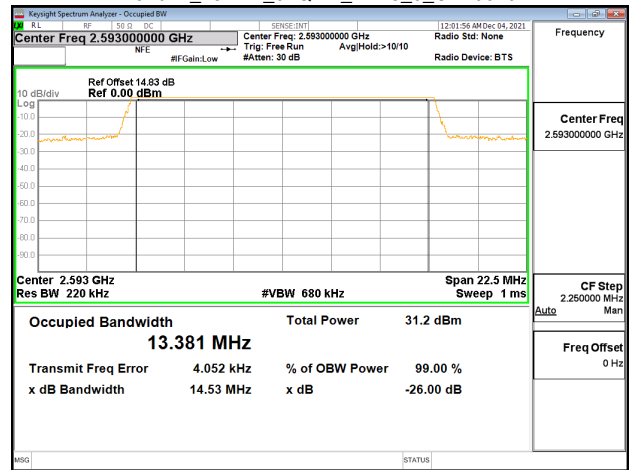

Band41\_15MHz\_16QAM\_RB75\_0\_CH41515

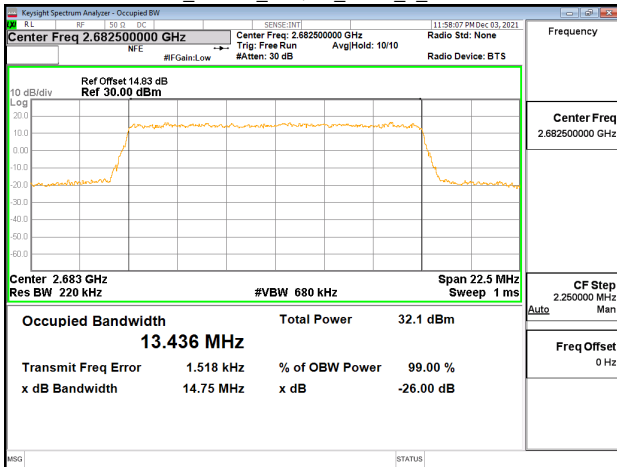

Band41\_15MHz\_64QAM\_RB75\_0\_CH41515

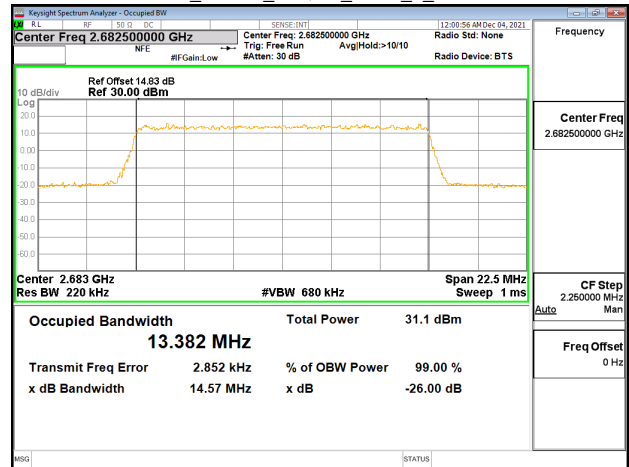

Unless otherwise stated the results shown in this test report refer only to the sample(s) tested and such sample(s) are retained for 90 days only.

除非另有說明，此報告結果僅對測試之樣品負責，同時此樣品僅保留90天。本報告未經本公司書面許可，不可部份複製。

This document is issued by the Company subject to its General Conditions of Service printed overleaf, available on request or accessible at <http://www.sgs.com.tw/Terms-and-Conditions> and for electronic format documents, subject to Terms and Conditions for Electronic Documents at <http://www.sgs.com.tw/Terms-and-Conditions>. Attention is drawn to the limitation of liability, indemnification and jurisdiction issues defined therein. Any holder of this document is advised that information contained herein reflects the Company's findings at the time of its intervention only and within the limits of Client's instructions, if any. The Company's sole responsibility is to its Client and this document does not exonerate parties to a transaction from exercising all their rights and obligations under the transaction documents. This document cannot be reproduced except in full, without prior written approval of the Company. Any unauthorized alteration, forgery or falsification of the content or appearance of this document is unlawful and offenders may be prosecuted to the fullest extent of the law.

Band41\_20MHz\_QPSK\_RB100\_0\_CH39750

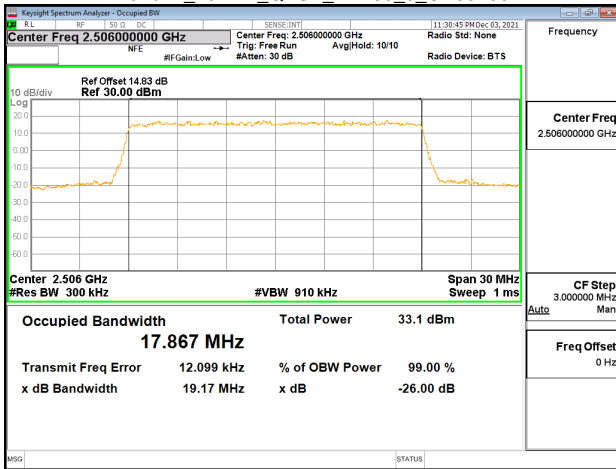

Band41\_20MHz\_16QAM\_RB100\_0\_CH39750

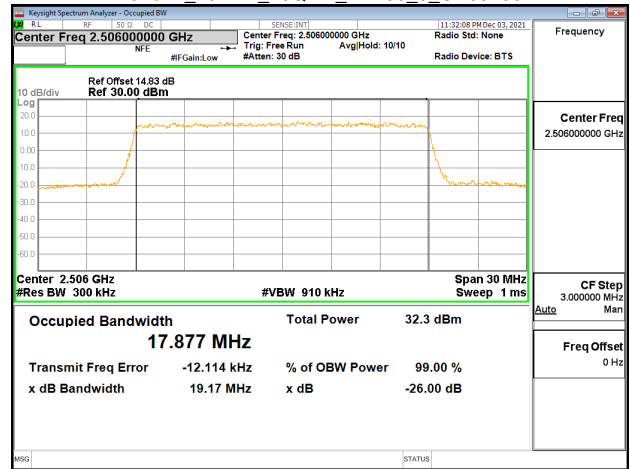

Band41\_20MHz\_QPSK\_RB100\_0\_CH40620

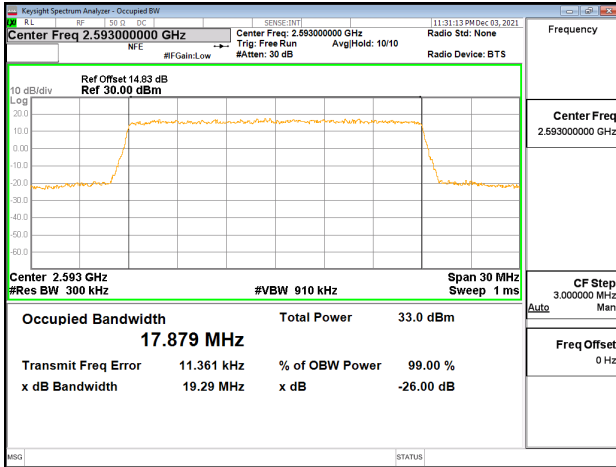

Band41\_20MHz\_16QAM\_RB100\_0\_CH40620

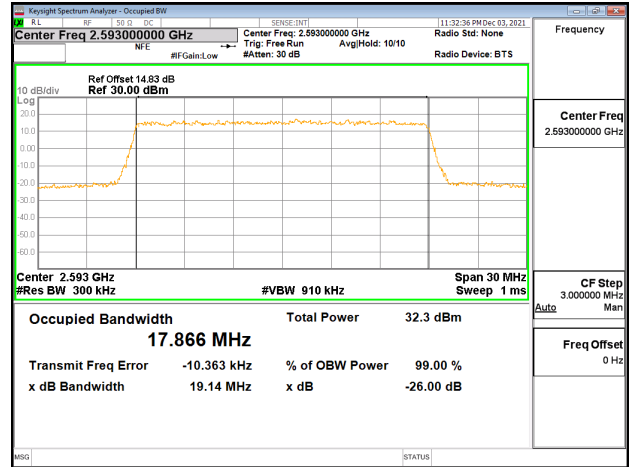

Band41\_20MHz\_QPSK\_RB100\_0\_CH41490

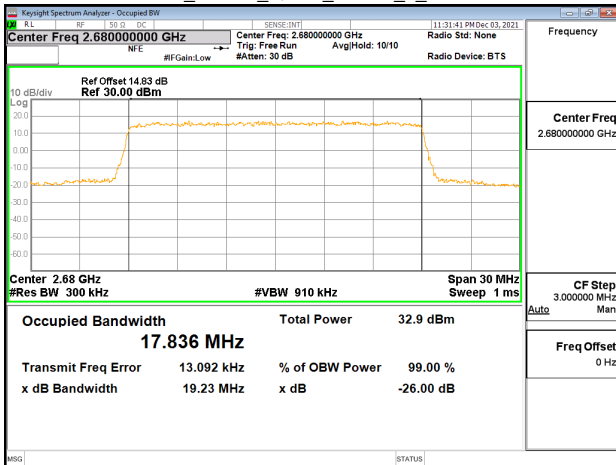

Band41\_20MHz\_16QAM\_RB100\_0\_CH41490

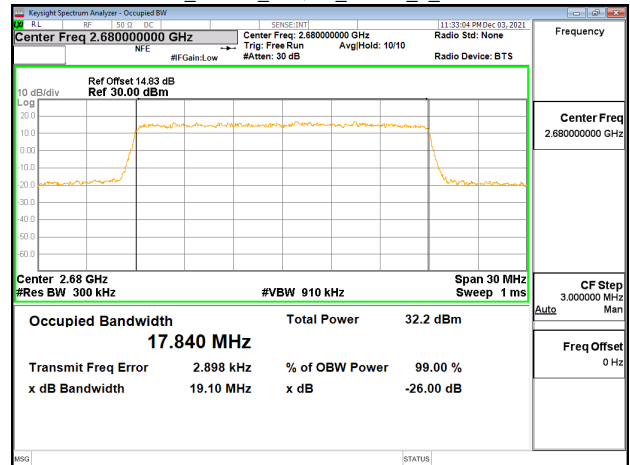

Unless otherwise stated the results shown in this test report refer only to the sample(s) tested and such sample(s) are retained for 90 days only.

除非另有說明，此報告結果僅對測試之樣品負責，同時此樣品僅保留90天。本報告未經本公司書面許可，不可部份複製。

This document is issued by the Company subject to its General Conditions of Service printed overleaf, available on request or accessible at <http://www.sgs.com.tw/Terms-and-Conditions> and for electronic format documents, subject to Terms and Conditions for Electronic Documents at <http://www.sgs.com.tw/Terms-and-Conditions>. Attention is drawn to the limitation of liability, indemnification and jurisdiction issues defined therein. Any holder of this document is advised that information contained herein reflects the Company's findings at the time of its intervention only and within the limits of Client's instructions, if any. The Company's sole responsibility is to its Client and this document does not exonerate parties to a transaction from exercising all their rights and obligations under the transaction documents. This document cannot be reproduced except in full, without prior written approval of the Company. Any unauthorized alteration, forgery or falsification of the content or appearance of this document is unlawful and offenders may be prosecuted to the fullest extent of the law.

Band41\_20MHz\_64QAM\_RB100\_0\_CH39750

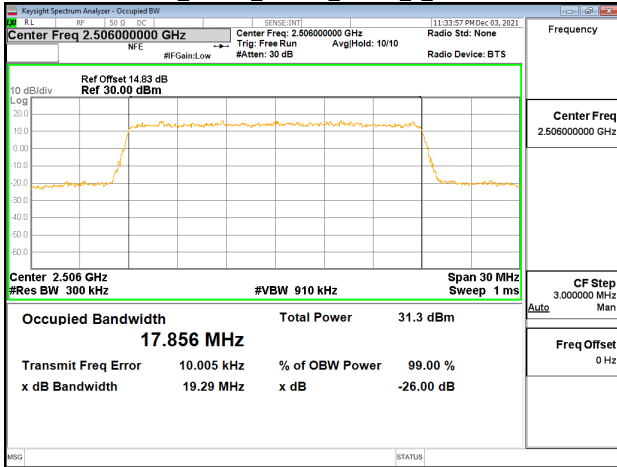

Band66\_1.4MHz\_QPSK\_RB6\_0\_CH131979

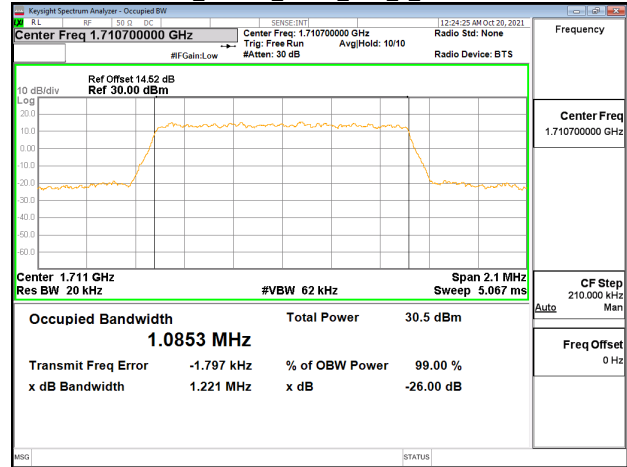

Band41\_20MHz\_64QAM\_RB100\_0\_CH40620

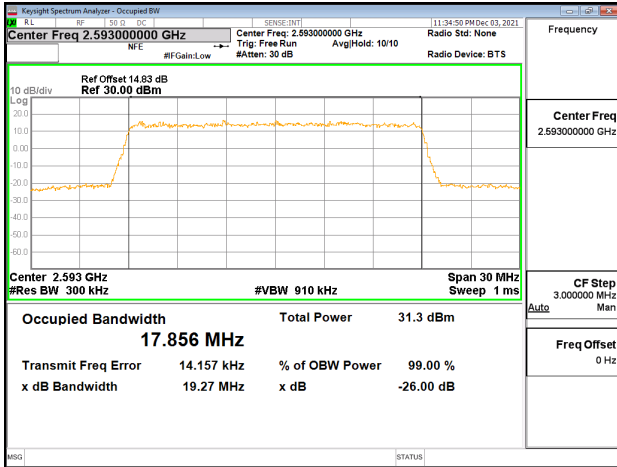

Band66\_1.4MHz\_QPSK\_RB6\_0\_CH132322

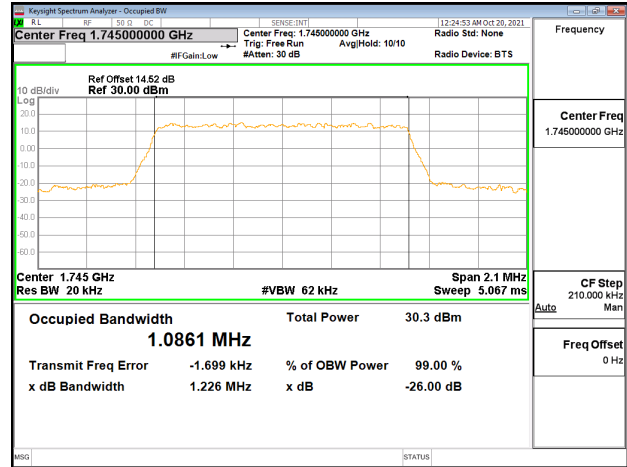

Band41\_20MHz\_64QAM\_RB100\_0\_CH41490

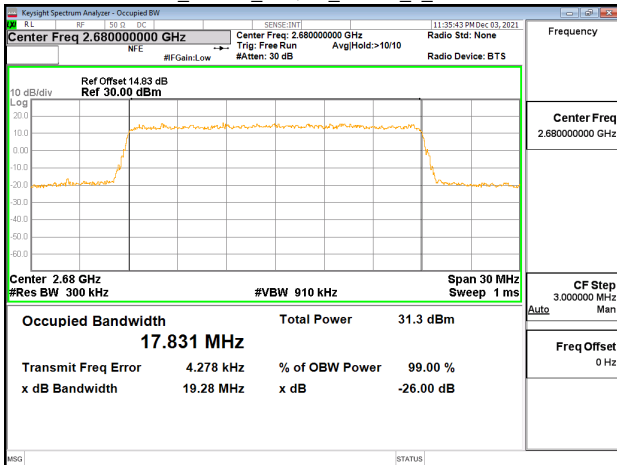

Band66\_1.4MHz\_QPSK\_RB6\_0\_CH132665

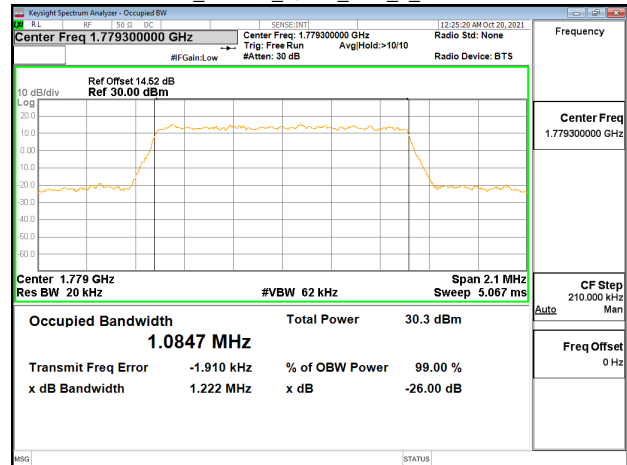

Unless otherwise stated the results shown in this test report refer only to the sample(s) tested and such sample(s) are retained for 90 days only.

除非另有說明，此報告結果僅對測試之樣品負責，同時此樣品僅保留90天。本報告未經本公司書面許可，不可部份複製。

This document is issued by the Company subject to its General Conditions of Service printed overleaf, available on request or accessible at <http://www.sgs.com.tw/Terms-and-Conditions> and for electronic format documents, subject to Terms and Conditions for Electronic Documents at <http://www.sgs.com.tw/Terms-and-Conditions>. Attention is drawn to the limitation of liability, indemnification and jurisdiction issues defined therein. Any holder of this document is advised that information contained hereon reflects the Company's findings at the time of its intervention only and within the limits of Client's instructions, if any. The Company's sole responsibility is to its Client and this document does not exonerate parties to a transaction from exercising all their rights and obligations under the transaction documents. This document cannot be reproduced except in full, without prior written approval of the Company. Any unauthorized alteration, forgery or falsification of the content or appearance of this document is unlawful and offenders may be prosecuted to the fullest extent of the law.

Band66 1.4MHz 16QAM\_RB6\_0\_CH131979

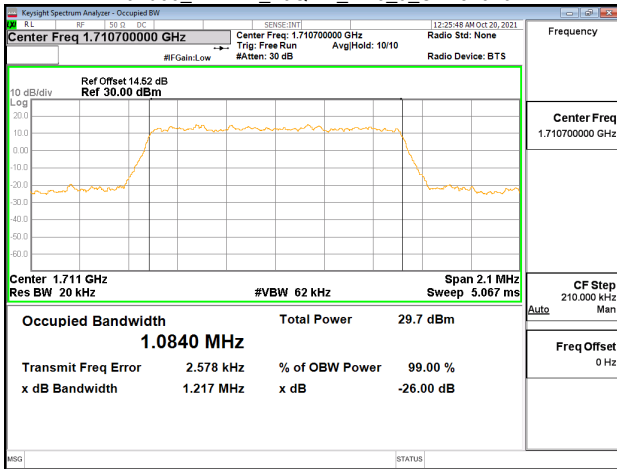

Band66 1.4MHz 64QAM\_RB6\_0\_CH131979

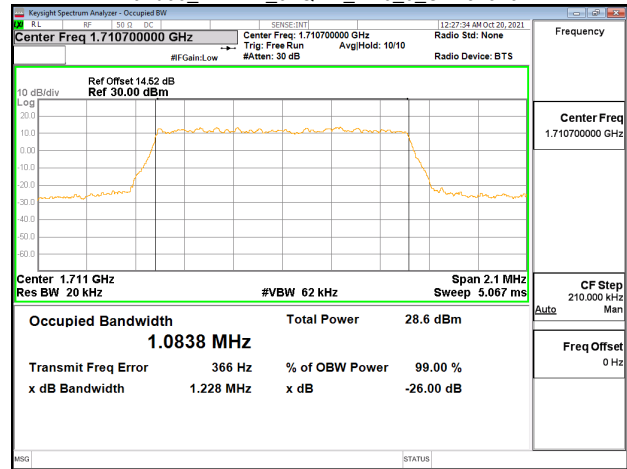

Band66 1.4MHz 16QAM\_RB6\_0\_CH132322

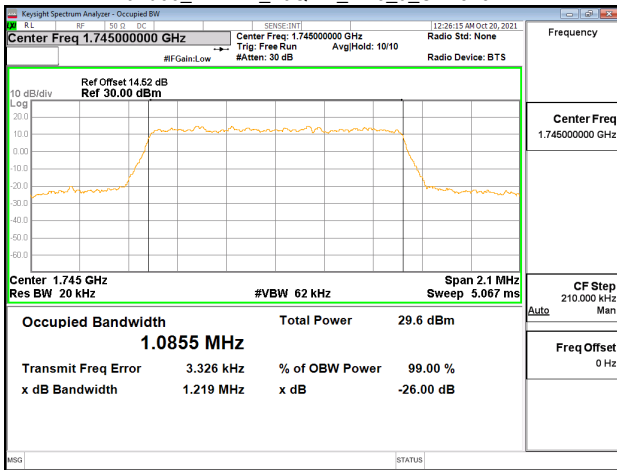

Band66 1.4MHz 64QAM\_RB6\_0\_CH132322

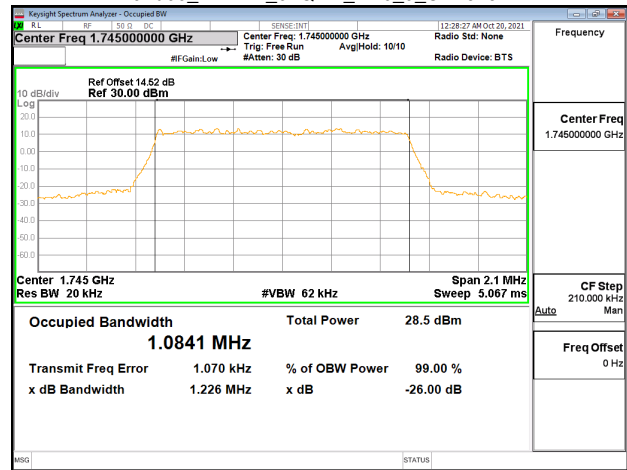

Band66 1.4MHz 16QAM\_RB6\_0\_CH132665

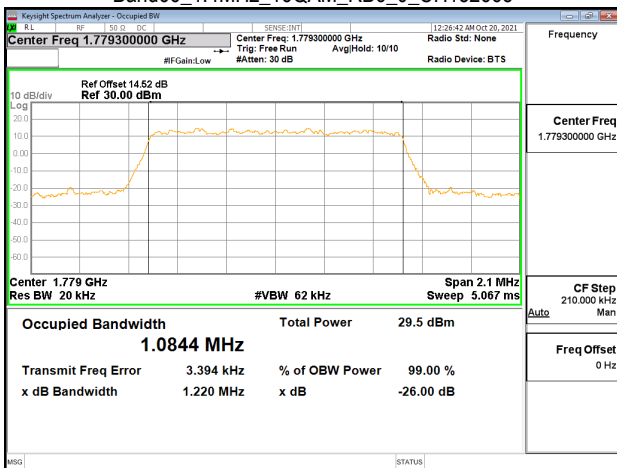

Band66 1.4MHz 64QAM\_RB6\_0\_CH132665

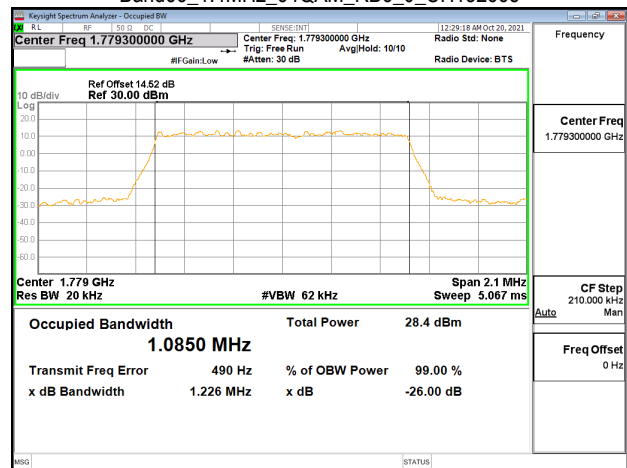

Unless otherwise stated the results shown in this test report refer only to the sample(s) tested and such sample(s) are retained for 90 days only.

除非另有說明，此報告結果僅對測試之樣品負責，同時此樣品僅保留90天。本報告未經本公司書面許可，不可部份複製。

This document is issued by the Company subject to its General Conditions of Service printed overleaf, available on request or accessible at <http://www.sgs.com.tw/Terms-and-Conditions> and for electronic format documents, subject to Terms and Conditions for Electronic Documents at <http://www.sgs.com.tw/Terms-and-Conditions>. Attention is drawn to the limitation of liability, indemnification and jurisdiction issues defined therein. Any holder of this document is advised that information contained herein reflects the Company's findings at the time of its intervention only and within the limits of Client's instructions, if any. The Company's sole responsibility is to its Client and this document does not exonerate parties to a transaction from exercising all their rights and obligations under the transaction documents. This document cannot be reproduced except in full, without prior written approval of the Company. Any unauthorized alteration, forgery or falsification of the content or appearance of this document is unlawful and offenders may be prosecuted to the fullest extent of the law.

Band66\_3MHz\_QPSK\_RB15\_0\_CH131987

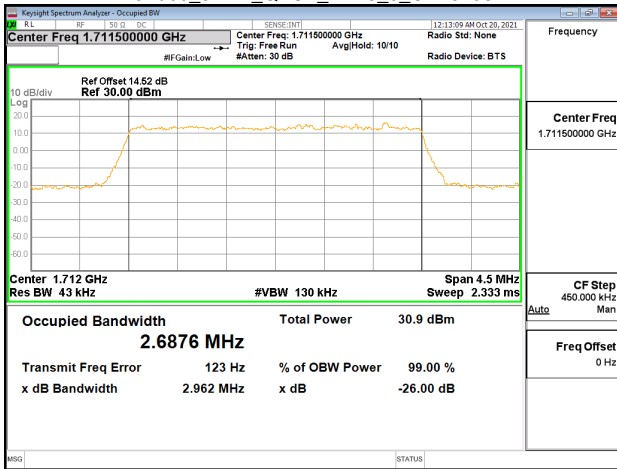

Band66\_3MHz\_16QAM\_RB15\_0\_CH131987

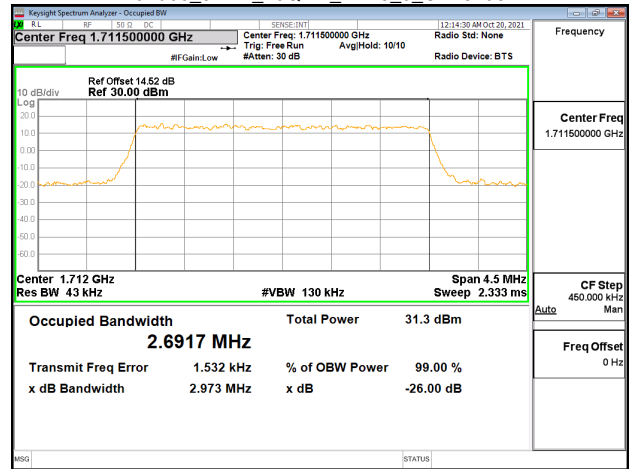

Band66\_3MHz\_QPSK\_RB15\_0\_CH132322

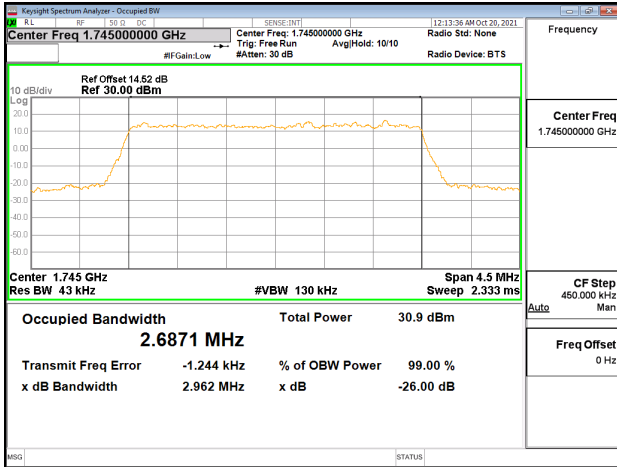

Band66\_3MHz\_16QAM\_RB15\_0\_CH132322

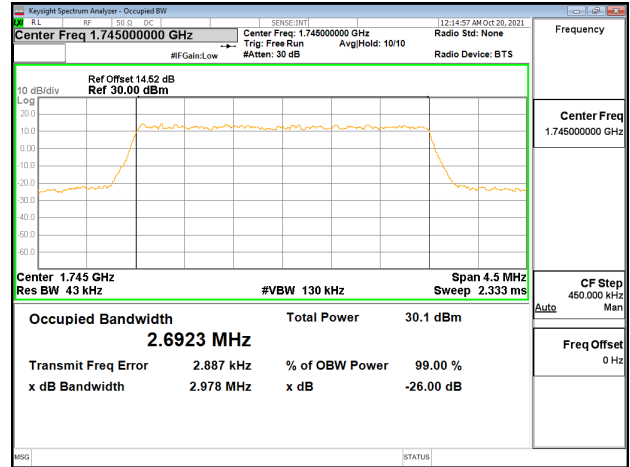

Band66\_3MHz\_QPSK\_RB15\_0\_CH132657

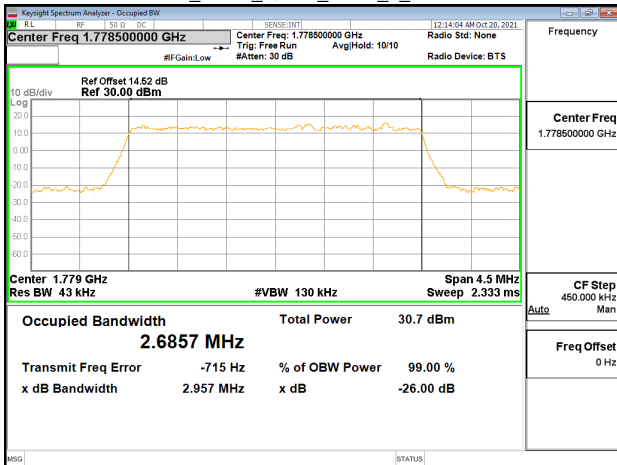

Band66\_3MHz\_16QAM\_RB15\_0\_CH132657

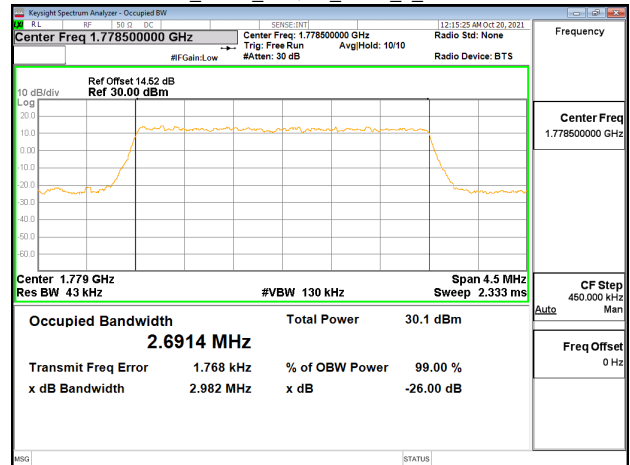

Unless otherwise stated the results shown in this test report refer only to the sample(s) tested and such sample(s) are retained for 90 days only.

除非另有說明，此報告結果僅對測試之樣品負責，同時此樣品僅保留90天。本報告未經本公司書面許可，不可部份複製。

This document is issued by the Company subject to its General Conditions of Service printed overleaf, available on request or accessible at <http://www.sgs.com.tw/Terms-and-Conditions> and for electronic format documents, subject to Terms and Conditions for Electronic Documents at <http://www.sgs.com.tw/Terms-and-Conditions>. Attention is drawn to the limitation of liability, indemnification and jurisdiction issues defined therein. Any holder of this document is advised that information contained herein reflects the Company's findings at the time of its intervention only and within the limits of Client's instructions, if any. The Company's sole responsibility is to its Client and this document does not exonerate parties to a transaction from exercising all their rights and obligations under the transaction documents. This document cannot be reproduced except in full, without prior written approval of the Company. Any unauthorized alteration, forgery or falsification of the content or appearance of this document is unlawful and offenders may be prosecuted to the fullest extent of the law.

Band66\_3MHz\_64QAM\_RB15\_0\_CH131987

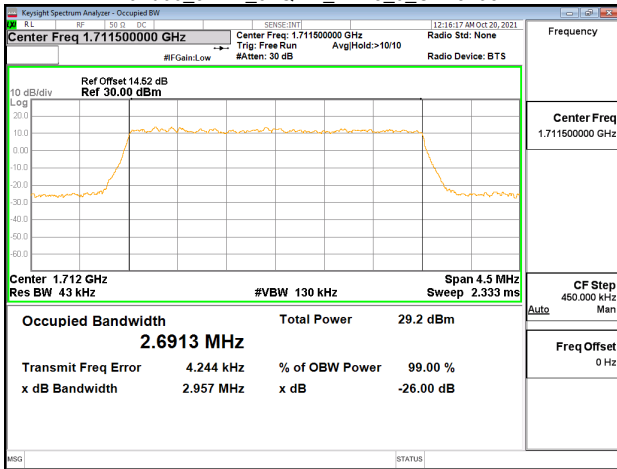

Band66\_5MHz\_QPSK\_RB25\_0\_CH131997

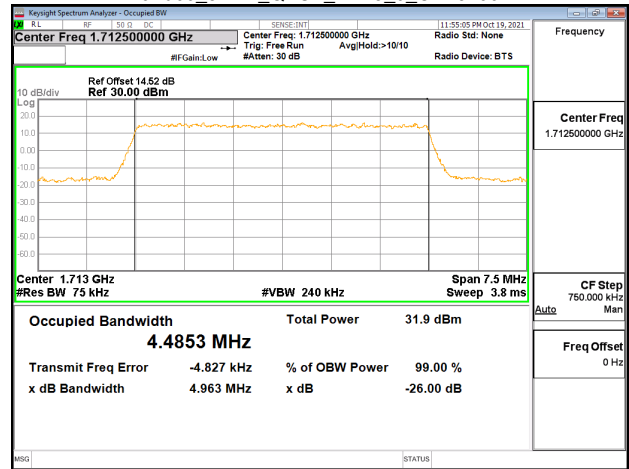

Band66\_3MHz\_64QAM\_RB15\_0\_CH132322

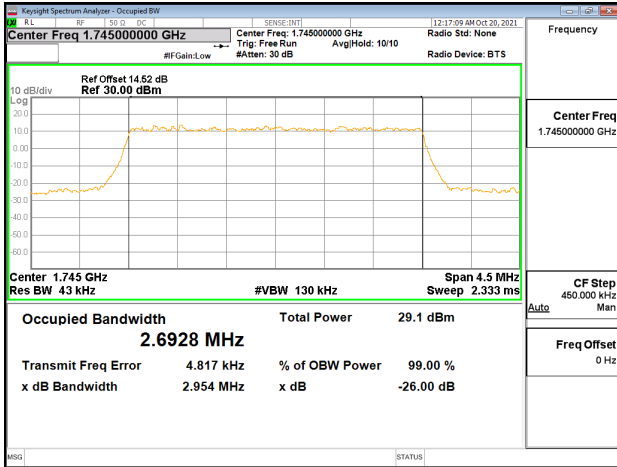

Band66\_5MHz\_QPSK\_RB25\_0\_CH132322

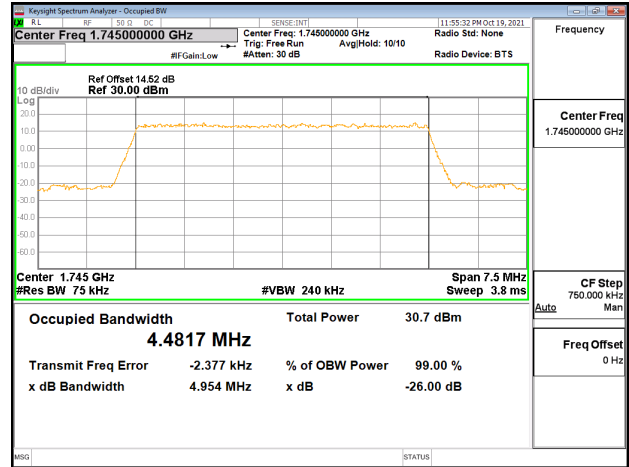

Band66\_3MHz\_64QAM\_RB15\_0\_CH132657

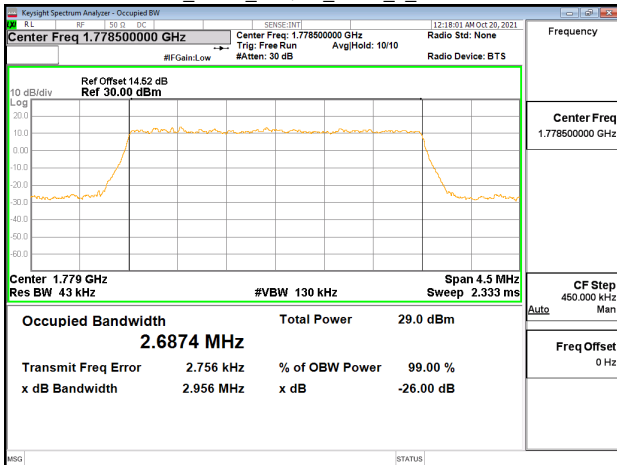

Band66\_5MHz\_QPSK\_RB25\_0\_CH132647

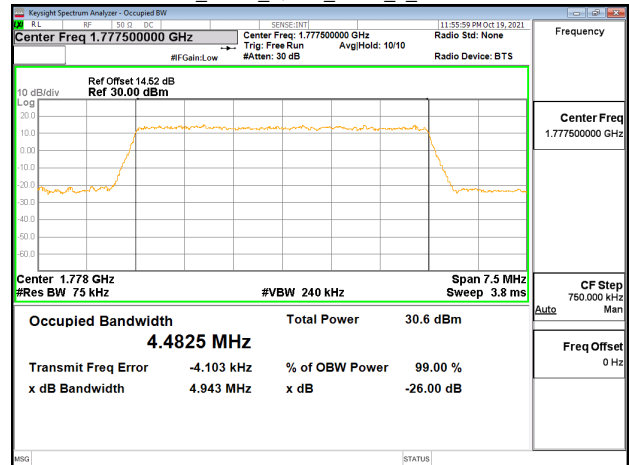

Unless otherwise stated the results shown in this test report refer only to the sample(s) tested and such sample(s) are retained for 90 days only.

除非另有說明，此報告結果僅對測試之樣品負責，同時此樣品僅保留90天。本報告未經本公司書面許可，不可部份複製。

This document is issued by the Company subject to its General Conditions of Service printed overleaf, available on request or accessible at <http://www.sgs.com.tw/Terms-and-Conditions> and for electronic format documents, subject to Terms and Conditions for Electronic Documents at <http://www.sgs.com.tw/Terms-and-Conditions>. Attention is drawn to the limitation of liability, indemnification and jurisdiction issues defined therein. Any holder of this document is advised that information contained herein reflects the Company's findings at the time of its intervention only and within the limits of Client's instructions, if any. The Company's sole responsibility is to its Client and this document does not exonerate parties to a transaction from exercising all their rights and obligations under the transaction documents. This document cannot be reproduced except in full, without prior written approval of the Company. Any unauthorized alteration, forgery or falsification of the content or appearance of this document is unlawful and offenders may be prosecuted to the fullest extent of the law.

Band66\_5MHz\_16QAM\_RB25\_0\_CH131997

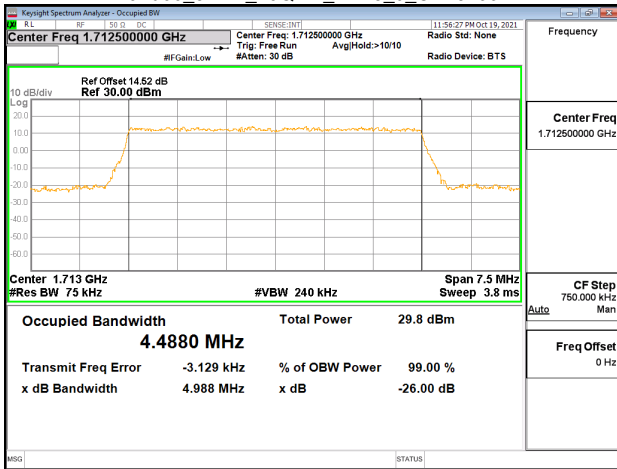

Band66\_5MHz\_64QAM\_RB25\_0\_CH131997

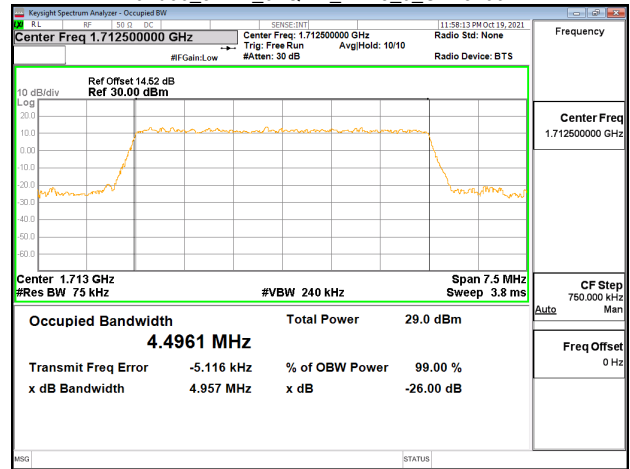

Band66\_5MHz\_16QAM\_RB25\_0\_CH132322

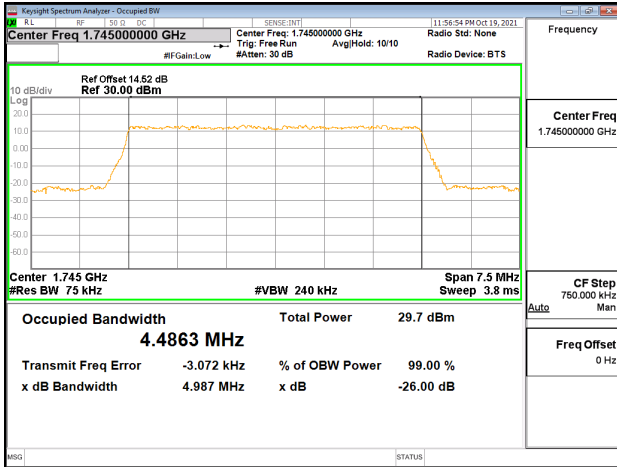

Band66\_5MHz\_64QAM\_RB25\_0\_CH132322

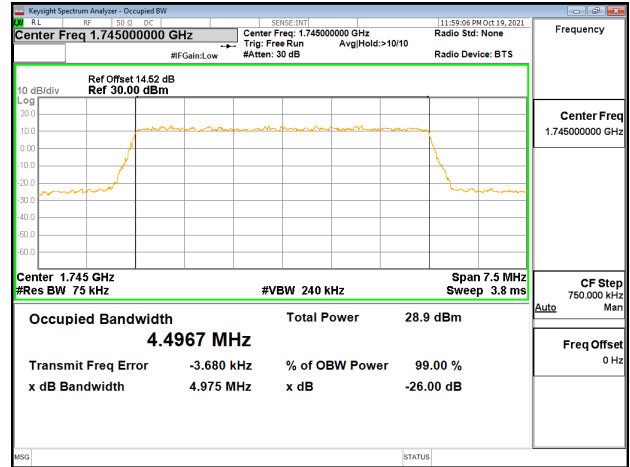

Band66\_5MHz\_16QAM\_RB25\_0\_CH132647

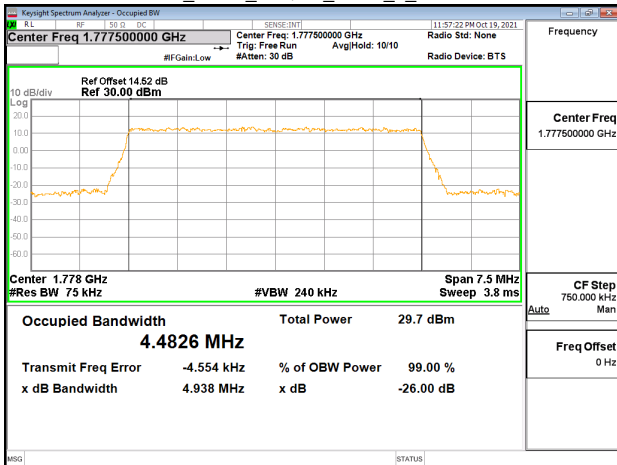

Band66\_5MHz\_64QAM\_RB25\_0\_CH132647

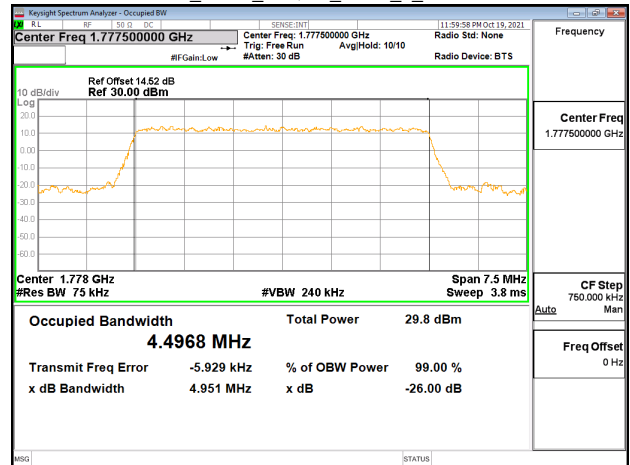

Unless otherwise stated the results shown in this test report refer only to the sample(s) tested and such sample(s) are retained for 90 days only.

除非另有說明，此報告結果僅對測試之樣品負責，同時此樣品僅保留90天。本報告未經本公司書面許可，不可部份複製。

This document is issued by the Company subject to its General Conditions of Service printed overleaf, available on request or accessible at <http://www.sgs.com.tw/Terms-and-Conditions> and for electronic format documents, subject to Terms and Conditions for Electronic Documents at <http://www.sgs.com.tw/Terms-and-Conditions>. Attention is drawn to the limitation of liability, indemnification and jurisdiction issues defined therein. Any holder of this document is advised that information contained herein reflects the Company's findings at the time of its intervention only and within the limits of Client's instructions, if any. The Company's sole responsibility is to its Client and this document does not exonerate parties to a transaction from exercising all their rights and obligations under the transaction documents. This document cannot be reproduced except in full, without prior written approval of the Company. Any unauthorized alteration, forgery or falsification of the content or appearance of this document is unlawful and offenders may be prosecuted to the fullest extent of the law.

Band66\_10MHz\_QPSK\_RB50\_0\_CH132022

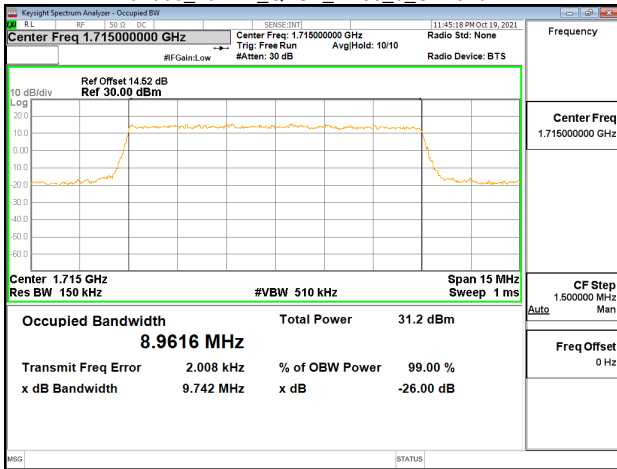

Band66\_10MHz\_16QAM\_RB50\_0\_CH132022

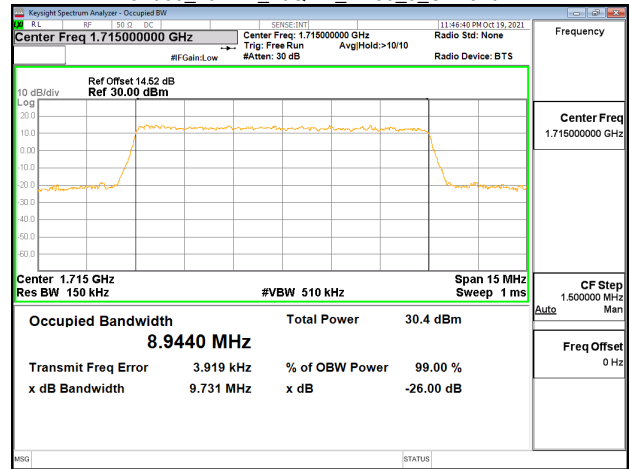

Band66\_10MHz\_QPSK\_RB50\_0\_CH132322

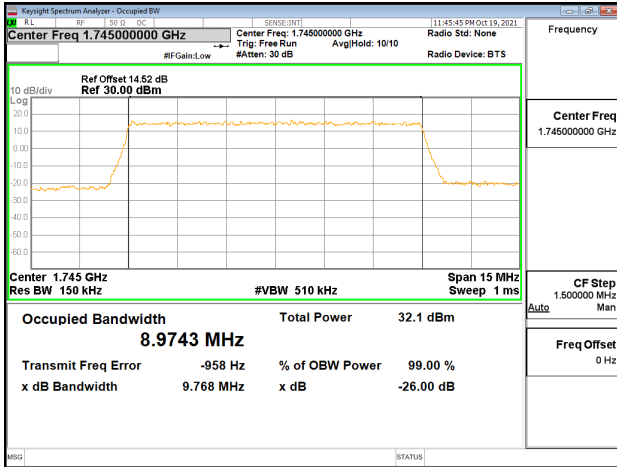

Band66\_10MHz\_16QAM\_RB50\_0\_CH132322

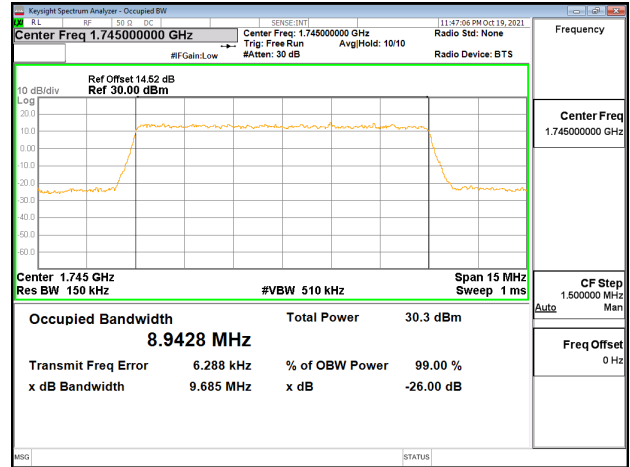

Band66\_10MHz\_QPSK\_RB50\_0\_CH132622

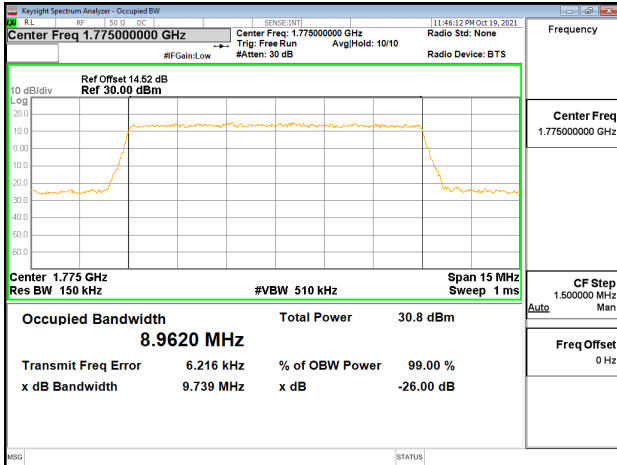

Band66\_10MHz\_16QAM\_RB50\_0\_CH132622

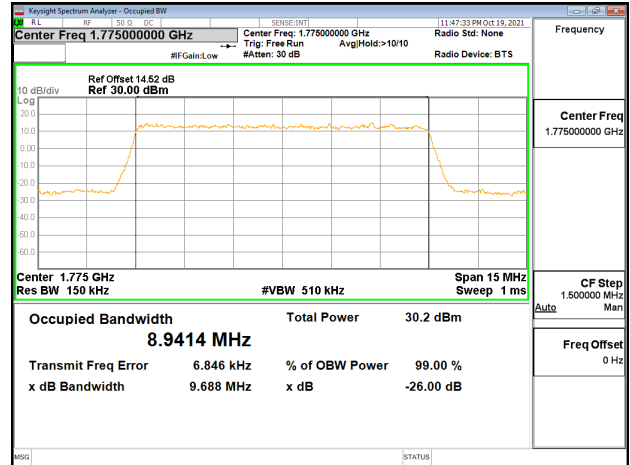

Unless otherwise stated the results shown in this test report refer only to the sample(s) tested and such sample(s) are retained for 90 days only.

除非另有說明，此報告結果僅對測試之樣品負責，同時此樣品僅保留90天。本報告未經本公司書面許可，不可部份複製。

This document is issued by the Company subject to its General Conditions of Service printed overleaf, available on request or accessible at <http://www.sgs.com.tw/Terms-and-Conditions> and for electronic format documents, subject to Terms and Conditions for Electronic Documents at <http://www.sgs.com.tw/Terms-and-Conditions>. Attention is drawn to the limitation of liability, indemnification and jurisdiction issues defined therein. Any holder of this document is advised that information contained herein reflects the Company's findings at the time of its intervention only and within the limits of Client's instructions, if any. The Company's sole responsibility is to its Client and this document does not exonerate parties to a transaction from exercising all their rights and obligations under the transaction documents. This document cannot be reproduced except in full, without prior written approval of the Company. Any unauthorized alteration, forgery or falsification of the content or appearance of this document is unlawful and offenders may be prosecuted to the fullest extent of the law.



Band66\_10MHz\_64QAM\_RB50\_0\_CH132022

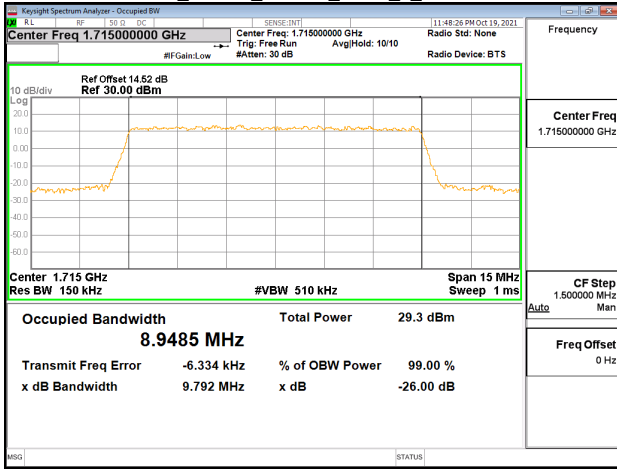

Band66\_15MHz\_QPSK\_RB75\_0\_CH132047

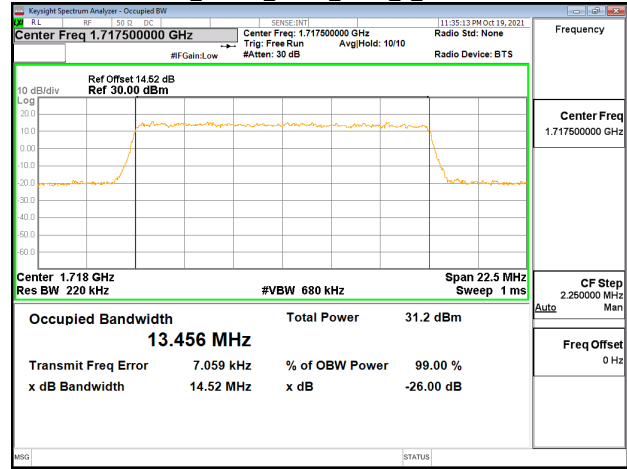

Band66\_10MHz\_64QAM\_RB50\_0\_CH132322

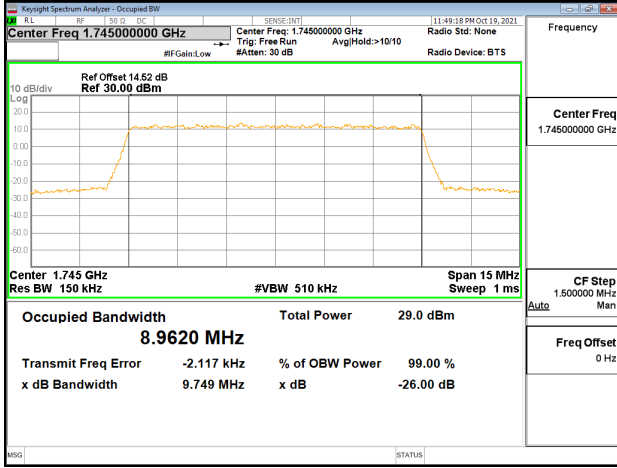

Band66\_15MHz\_QPSK\_RB75\_0\_CH132322

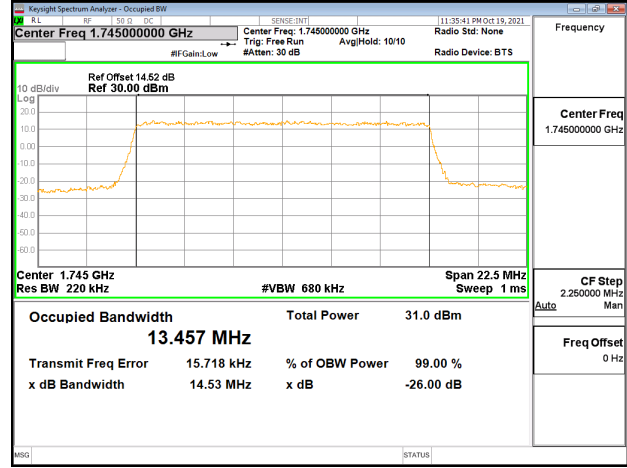

Band66\_10MHz\_64QAM\_RB50\_0\_CH132622

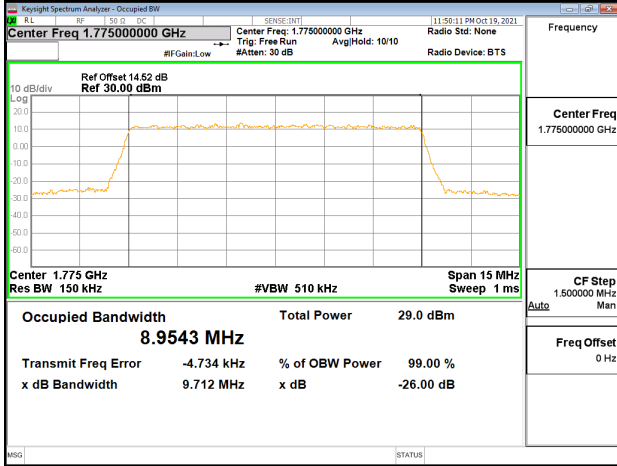

Band66\_15MHz\_QPSK\_RB75\_0\_CH132597

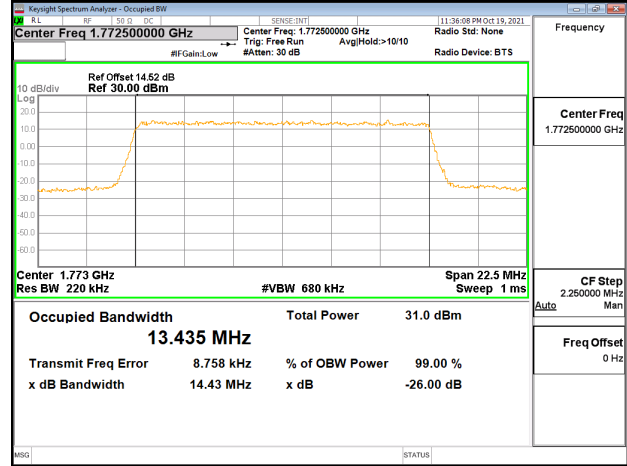

Unless otherwise stated the results shown in this test report refer only to the sample(s) tested and such sample(s) are retained for 90 days only.

除非另有說明，此報告結果僅對測試之樣品負責，同時此樣品僅保留90天。本報告未經本公司書面許可，不可部份複製。

This document is issued by the Company subject to its General Conditions of Service printed overleaf, available on request or accessible at <http://www.sgs.com.tw/Terms-and-Conditions> and for electronic format documents, subject to Terms and Conditions for Electronic Documents at <http://www.sgs.com.tw/Terms-and-Conditions>. Attention is drawn to the limitation of liability, indemnification and jurisdiction issues defined therein. Any holder of this document is advised that information contained herein reflects the Company's findings at the time of its intervention only and within the limits of Client's instructions, if any. The Company's sole responsibility is to its Client and this document does not exonerate parties to a transaction from exercising all their rights and obligations under the transaction documents. This document cannot be reproduced except in full, without prior written approval of the Company. Any unauthorized alteration, forgery or falsification of the content or appearance of this document is unlawful and offenders may be prosecuted to the fullest extent of the law.

Band66\_15MHz\_16QAM\_RB75\_0\_CH132047

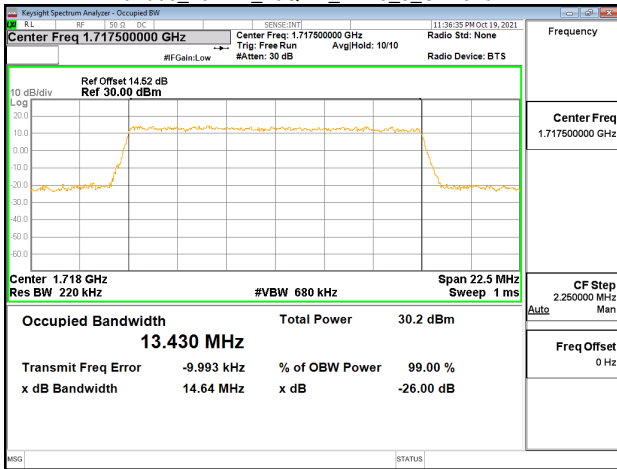

Band66\_15MHz\_64QAM\_RB75\_0\_CH132047

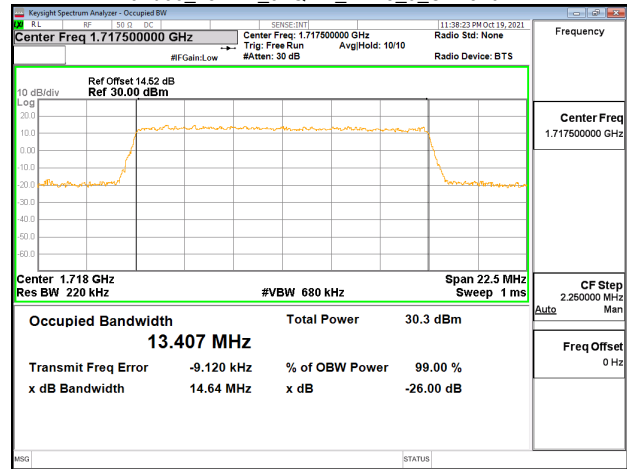

Band66\_15MHz\_16QAM\_RB75\_0\_CH132322

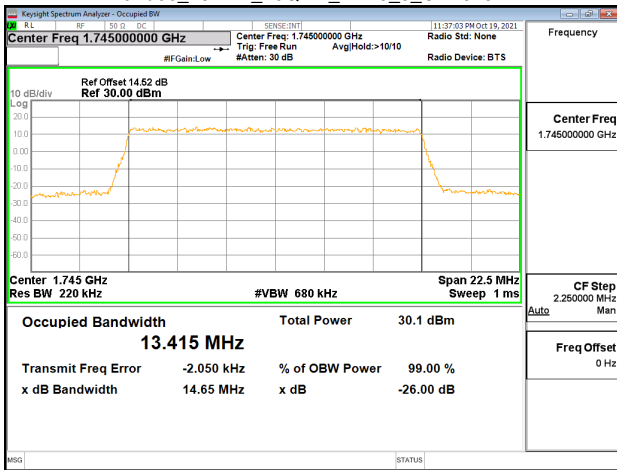

Band66\_15MHz\_64QAM\_RB75\_0\_CH132322

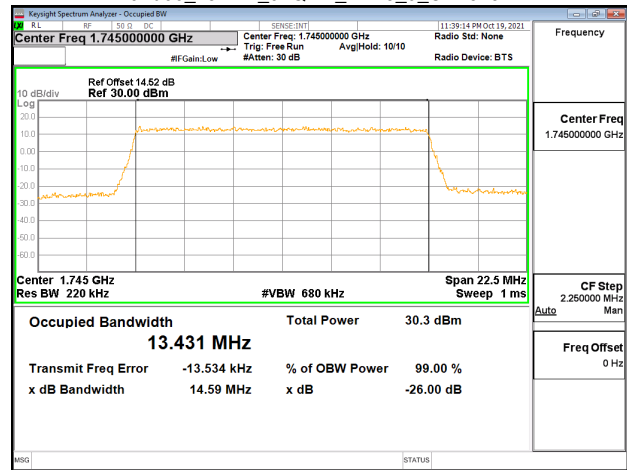

Band66\_15MHz\_16QAM\_RB75\_0\_CH132597

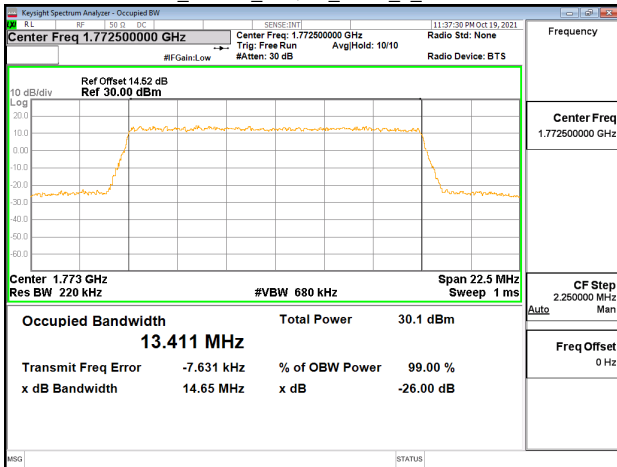

Band66\_15MHz\_64QAM\_RB75\_0\_CH132597

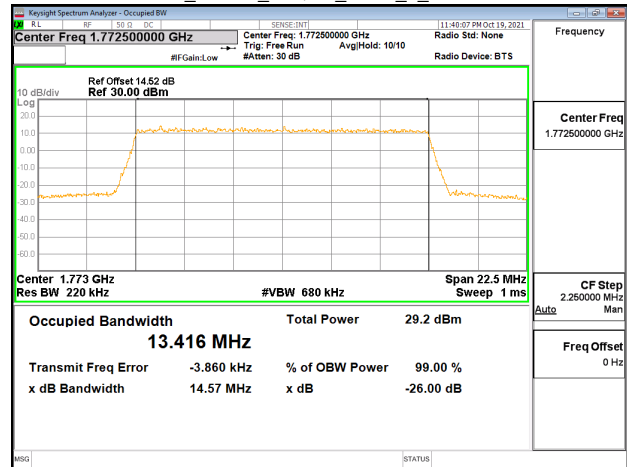

Unless otherwise stated the results shown in this test report refer only to the sample(s) tested and such sample(s) are retained for 90 days only.

除非另有說明，此報告結果僅對測試之樣品負責，同時此樣品僅保留90天。本報告未經本公司書面許可，不可部份複製。

This document is issued by the Company subject to its General Conditions of Service printed overleaf, available on request or accessible at <http://www.sgs.com.tw/Terms-and-Conditions> and for electronic format documents, subject to Terms and Conditions for Electronic Documents at <http://www.sgs.com.tw/Terms-and-Conditions>. Attention is drawn to the limitation of liability, indemnification and jurisdiction issues defined therein. Any holder of this document is advised that information contained herein reflects the Company's findings at the time of its intervention only and within the limits of Client's instructions, if any. The Company's sole responsibility is to its Client and this document does not exonerate parties to a transaction from exercising all their rights and obligations under the transaction documents. This document cannot be reproduced except in full, without prior written approval of the Company. Any unauthorized alteration, forgery or falsification of the content or appearance of this document is unlawful and offenders may be prosecuted to the fullest extent of the law.

Band66\_20MHz\_QPSK\_RB100\_0\_CH132072

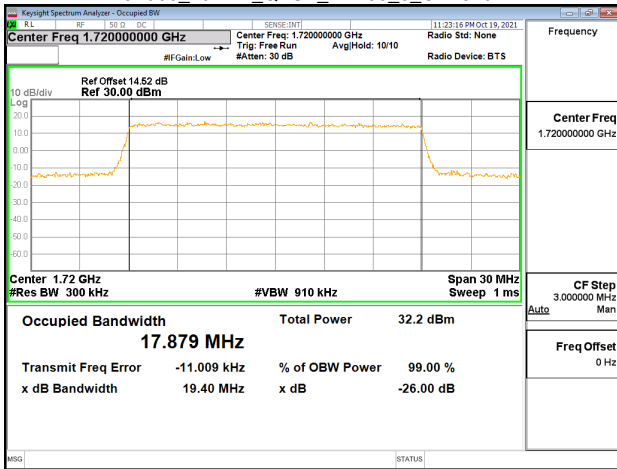

Band66\_20MHz\_16QAM\_RB100\_0\_CH132072

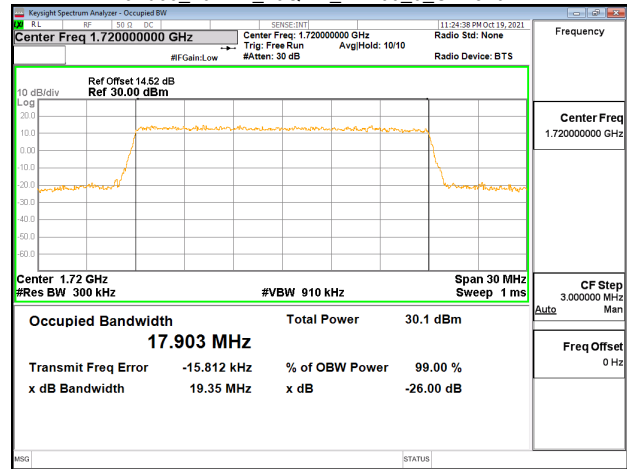

Band66\_20MHz\_QPSK\_RB100\_0\_CH132322

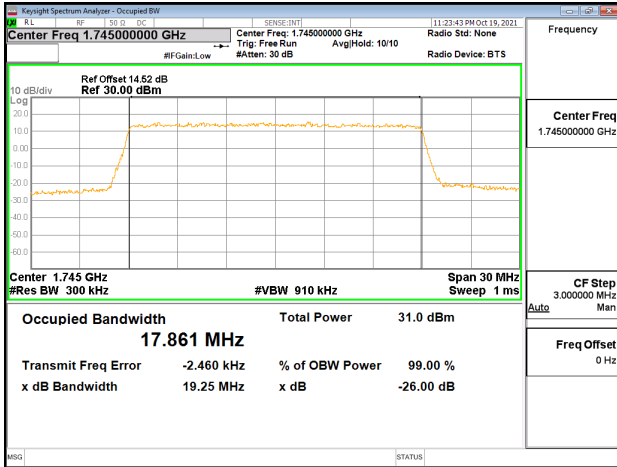

Band66\_20MHz\_16QAM\_RB100\_0\_CH132322

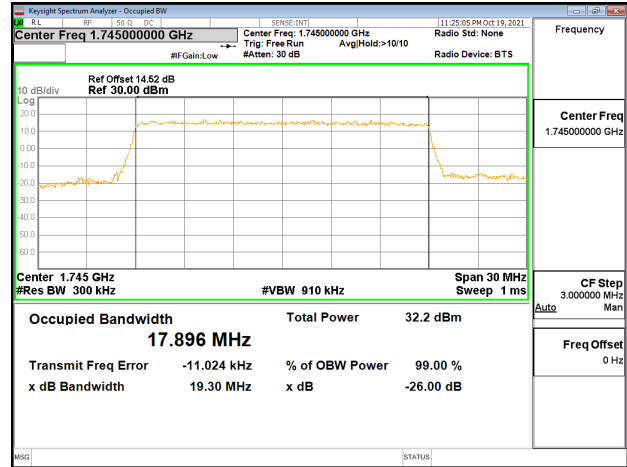

Band66\_20MHz\_QPSK\_RB100\_0\_CH132572

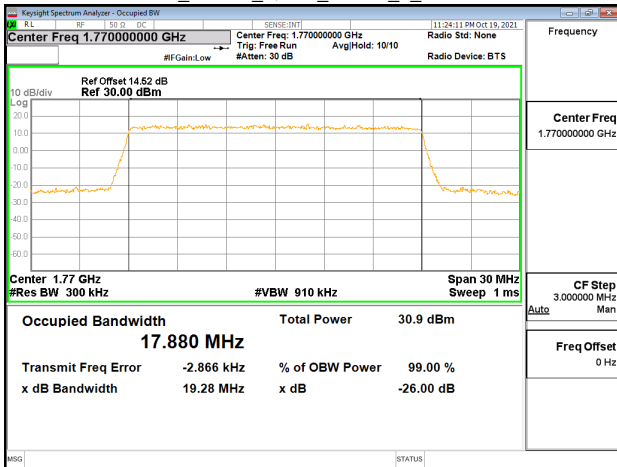

Band66\_20MHz\_16QAM\_RB100\_0\_CH132572

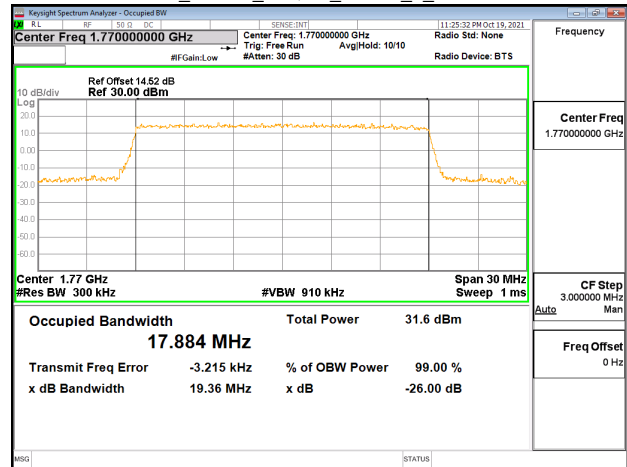

Unless otherwise stated the results shown in this test report refer only to the sample(s) tested and such sample(s) are retained for 90 days only.

除非另有說明，此報告結果僅對測試之樣品負責，同時此樣品僅保留90天。本報告未經本公司書面許可，不可部份複製。

This document is issued by the Company subject to its General Conditions of Service printed overleaf, available on request or accessible at <http://www.sgs.com.tw/Terms-and-Conditions> and for electronic format documents, subject to Terms and Conditions for Electronic Documents at <http://www.sgs.com.tw/Terms-and-Conditions>. Attention is drawn to the limitation of liability, indemnification and jurisdiction issues defined therein. Any holder of this document is advised that information contained herein reflects the Company's findings at the time of its intervention only and within the limits of Client's instructions, if any. The Company's sole responsibility is to its Client and this document does not exonerate parties to a transaction from exercising all their rights and obligations under the transaction documents. This document cannot be reproduced except in full, without prior written approval of the Company. Any unauthorized alteration, forgery or falsification of the content or appearance of this document is unlawful and offenders may be prosecuted to the fullest extent of the law.

Band66\_20MHz\_64QAM\_RB100\_0\_CH132072

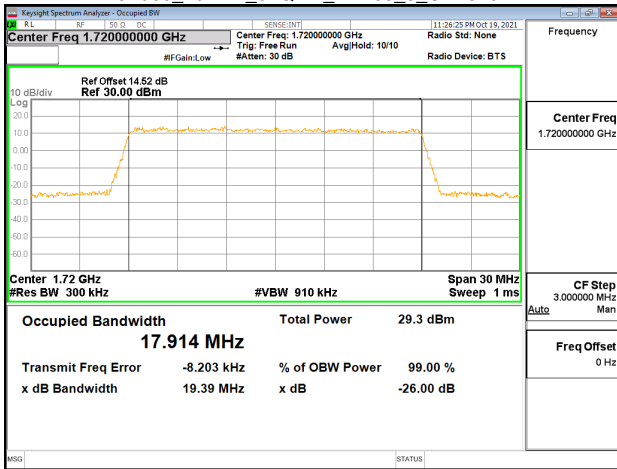

Band71\_5MHz\_QPSK\_RB25\_0\_CH133147

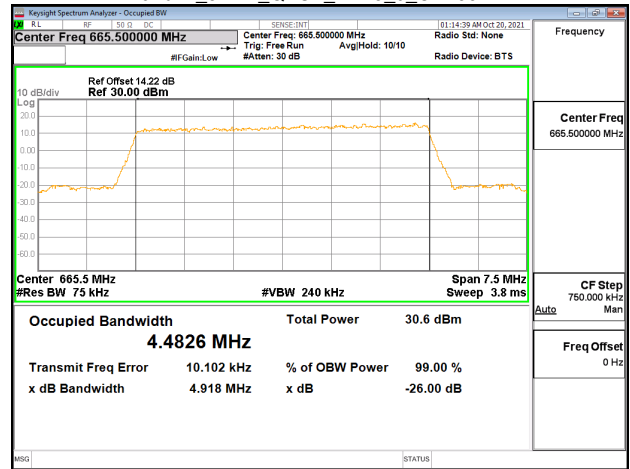

Band66\_20MHz\_64QAM\_RB100\_0\_CH132322

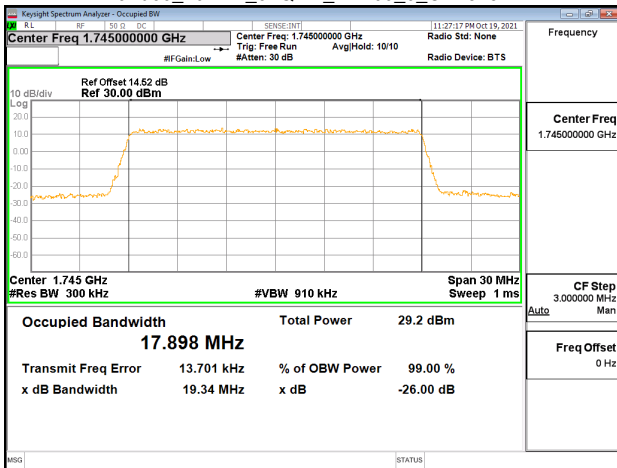

Band71\_5MHz\_QPSK\_RB25\_0\_CH133297

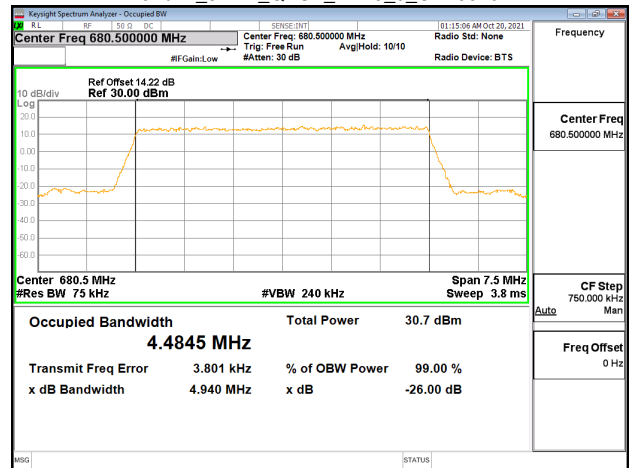

Band66\_20MHz\_64QAM\_RB100\_0\_CH132572

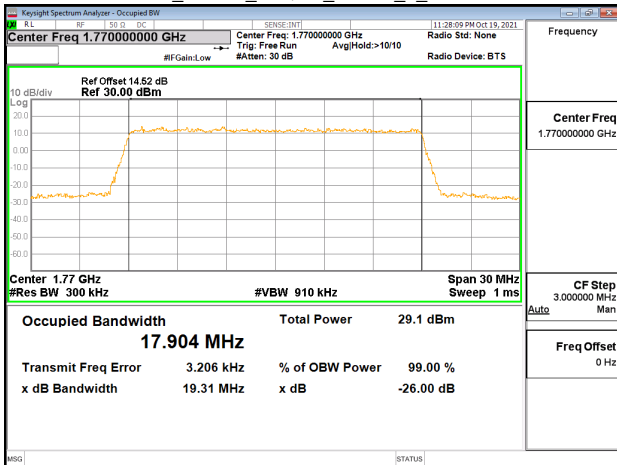

Band71\_5MHz\_QPSK\_RB25\_0\_CH133447

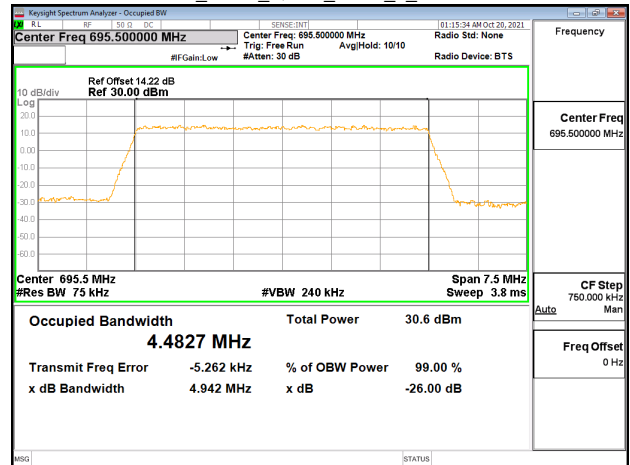

Unless otherwise stated the results shown in this test report refer only to the sample(s) tested and such sample(s) are retained for 90 days only.

除非另有說明，此報告結果僅對測試之樣品負責，同時此樣品僅保留90天。本報告未經本公司書面許可，不可部份複製。

This document is issued by the Company subject to its General Conditions of Service printed overleaf, available on request or accessible at <http://www.sgs.com.tw/Terms-and-Conditions> and for electronic format documents, subject to Terms and Conditions for Electronic Documents at <http://www.sgs.com.tw/Terms-and-Conditions>. Attention is drawn to the limitation of liability, indemnification and jurisdiction issues defined therein. Any holder of this document is advised that information contained herein reflects the Company's findings at the time of its intervention only and within the limits of Client's instructions, if any. The Company's sole responsibility is to its Client and this document does not exonerate parties to a transaction from exercising all their rights and obligations under the transaction documents. This document cannot be reproduced except in full, without prior written approval of the Company. Any unauthorized alteration, forgery or falsification of the content or appearance of this document is unlawful and offenders may be prosecuted to the fullest extent of the law.

Band71\_5MHz\_16QAM\_RB25\_0\_CH133147

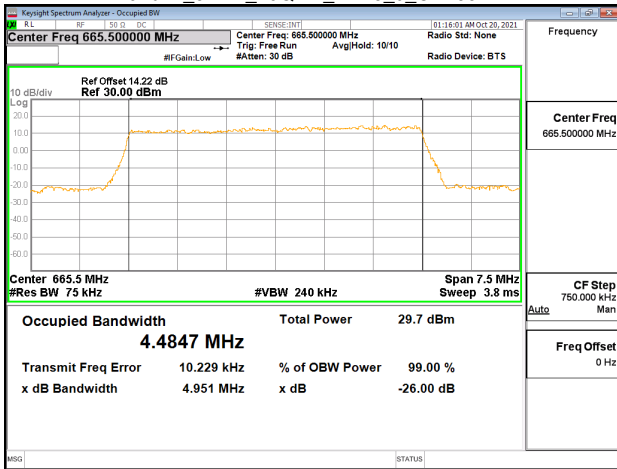

Band71\_5MHz\_64QAM\_RB25\_0\_CH133147

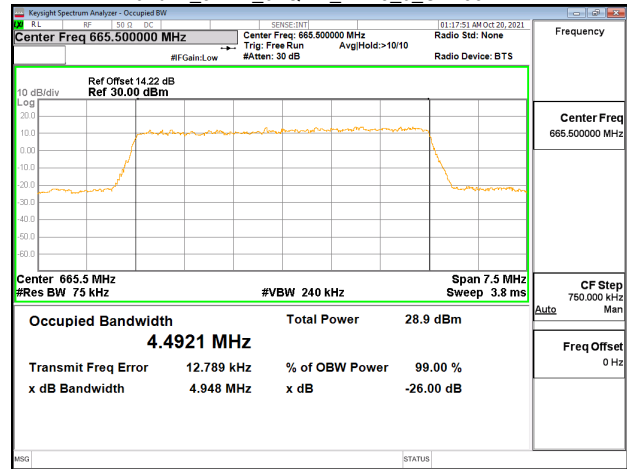

Band71\_5MHz\_16QAM\_RB25\_0\_CH133297

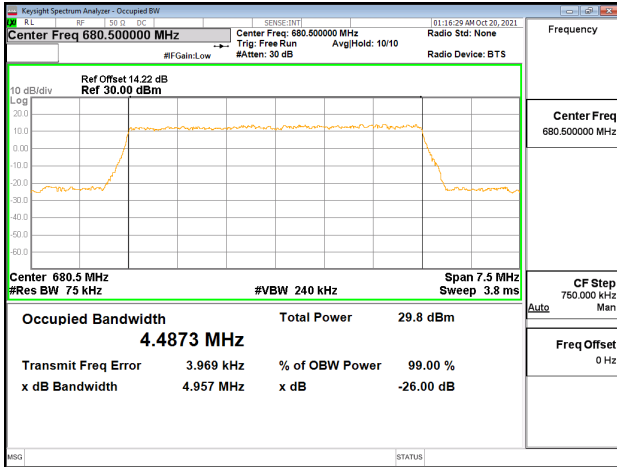

Band71\_5MHz\_64QAM\_RB25\_0\_CH133297

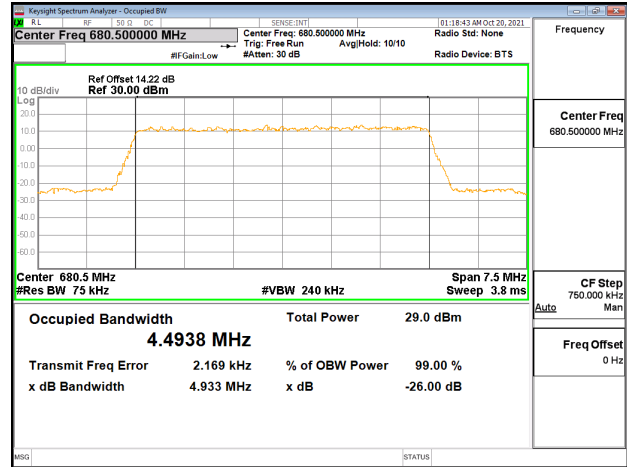

Band71\_5MHz\_16QAM\_RB25\_0\_CH133447

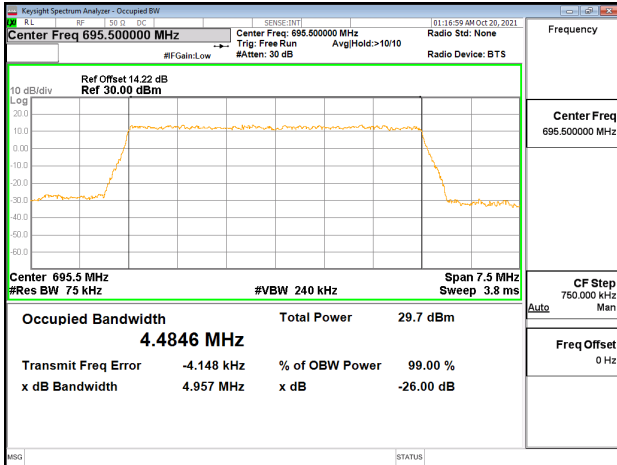

Band71\_5MHz\_64QAM\_RB25\_0\_CH133447

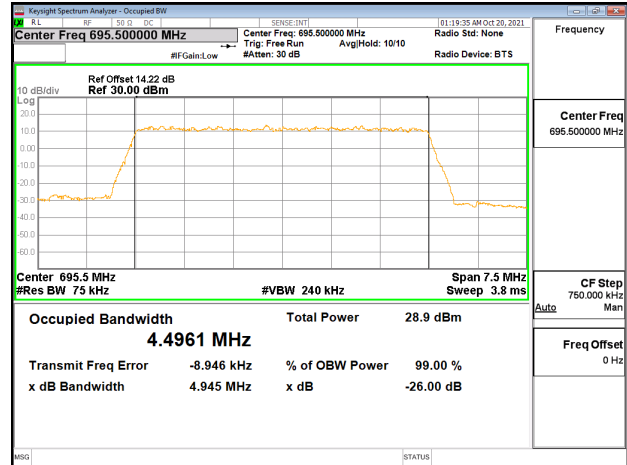

Unless otherwise stated the results shown in this test report refer only to the sample(s) tested and such sample(s) are retained for 90 days only.

除非另有說明，此報告結果僅對測試之樣品負責，同時此樣品僅保留90天。本報告未經本公司書面許可，不可部份複製。

This document is issued by the Company subject to its General Conditions of Service printed overleaf, available on request or accessible at <http://www.sgs.com.tw/Terms-and-Conditions> and for electronic format documents, subject to Terms and Conditions for Electronic Documents at <http://www.sgs.com.tw/Terms-and-Conditions>. Attention is drawn to the limitation of liability, indemnification and jurisdiction issues defined therein. Any holder of this document is advised that information contained herein reflects the Company's findings at the time of its intervention only and within the limits of Client's instructions, if any. The Company's sole responsibility is to its Client and this document does not exonerate parties to a transaction from exercising all their rights and obligations under the transaction documents. This document cannot be reproduced except in full, without prior written approval of the Company. Any unauthorized alteration, forgery or falsification of the content or appearance of this document is unlawful and offenders may be prosecuted to the fullest extent of the law.

Band71\_10MHz\_QPSK\_RB50\_0\_CH133172

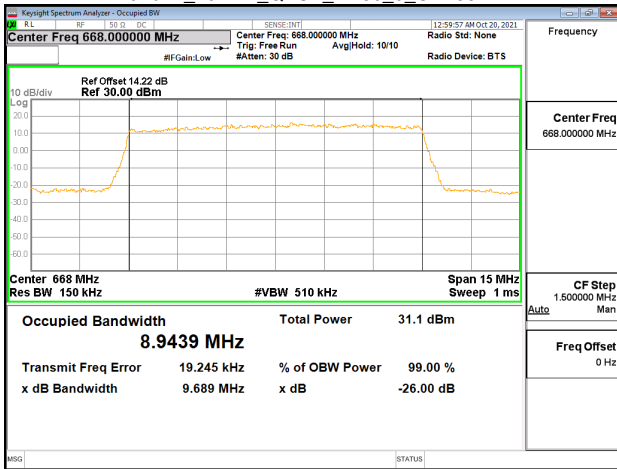

Band71\_10MHz\_16QAM\_RB50\_0\_CH133172

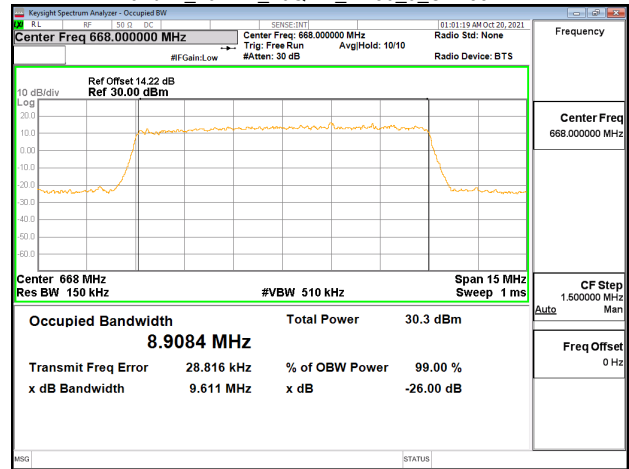

Band71\_10MHz\_QPSK\_RB50\_0\_CH133297

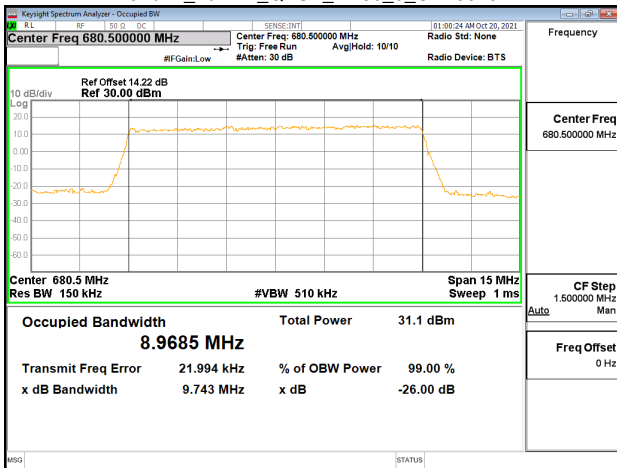

Band71\_10MHz\_16QAM\_RB50\_0\_CH133297

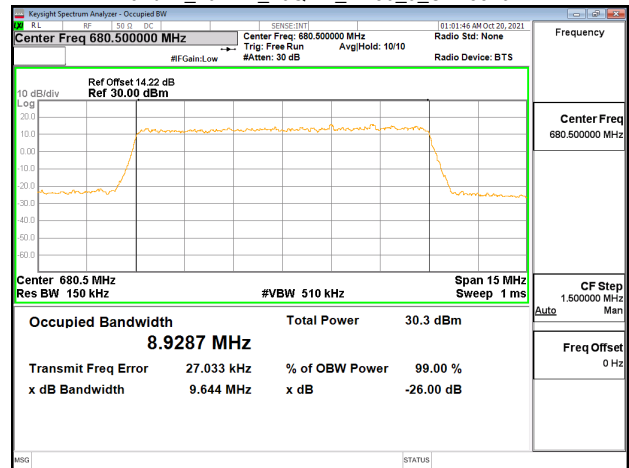

Band71\_10MHz\_QPSK\_RB50\_0\_CH133422

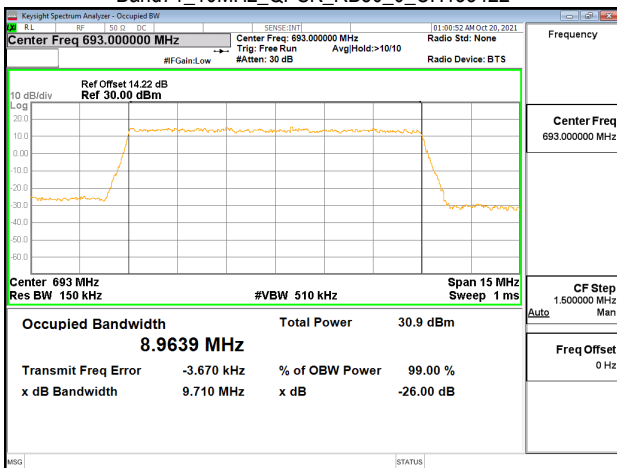

Band71\_10MHz\_16QAM\_RB50\_0\_CH133422

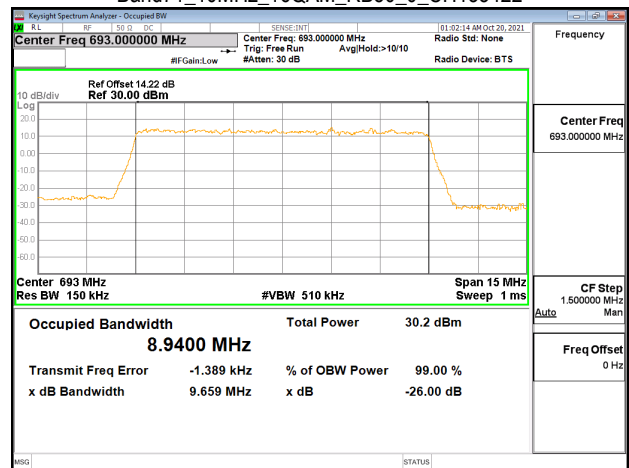

Unless otherwise stated the results shown in this test report refer only to the sample(s) tested and such sample(s) are retained for 90 days only.

除非另有說明，此報告結果僅對測試之樣品負責，同時此樣品僅保留90天。本報告未經本公司書面許可，不可部份複製。

This document is issued by the Company subject to its General Conditions of Service printed overleaf, available on request or accessible at <http://www.sgs.com.tw/Terms-and-Conditions> and for electronic format documents, subject to Terms and Conditions for Electronic Documents at <http://www.sgs.com.tw/Terms-and-Conditions>. Attention is drawn to the limitation of liability, indemnification and jurisdiction issues defined therein. Any holder of this document is advised that information contained herein reflects the Company's findings at the time of its intervention only and within the limits of Client's instructions, if any. The Company's sole responsibility is to its Client and this document does not exonerate parties to a transaction from exercising all their rights and obligations under the transaction documents. This document cannot be reproduced except in full, without prior written approval of the Company. Any unauthorized alteration, forgery or falsification of the content or appearance of this document is unlawful and offenders may be prosecuted to the fullest extent of the law.

Band71\_10MHz\_64QAM\_RB50\_0\_CH133172

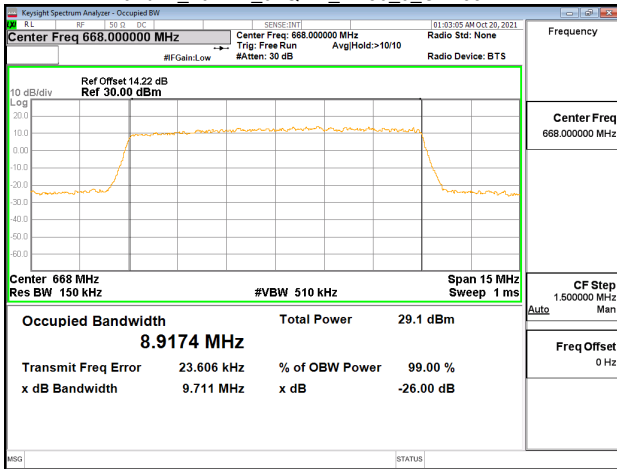

Band71\_15MHz\_QPSK\_RB75\_0\_CH133197

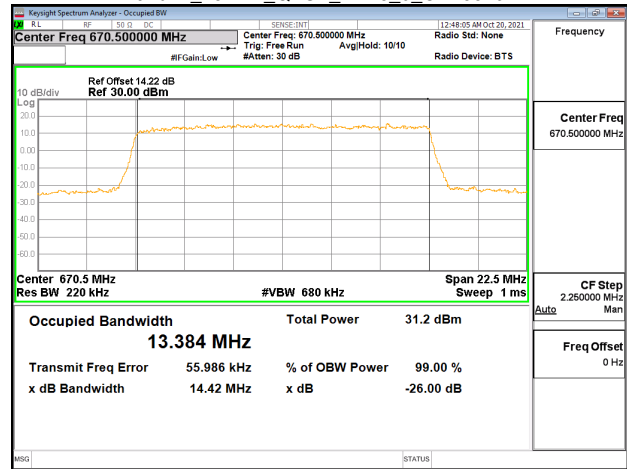

Band71\_10MHz\_64QAM\_RB50\_0\_CH133297

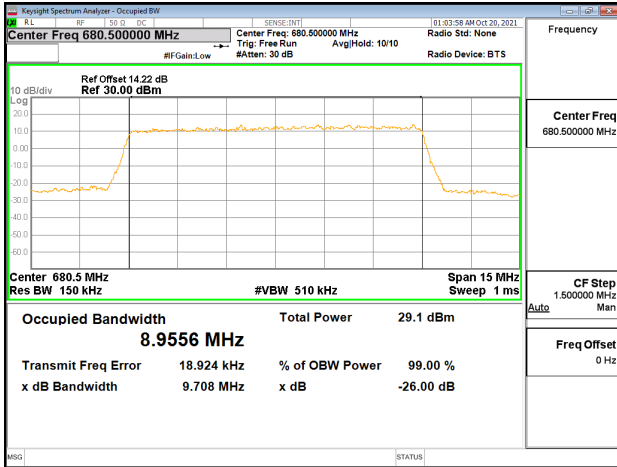

Band71\_15MHz\_QPSK\_RB75\_0\_CH133297

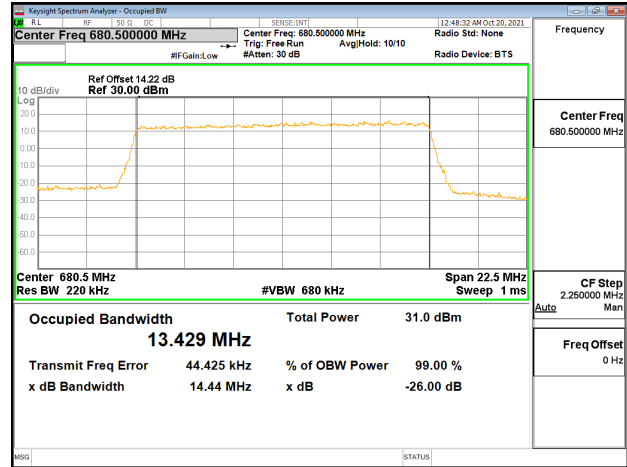

Band71\_10MHz\_64QAM\_RB50\_0\_CH133422

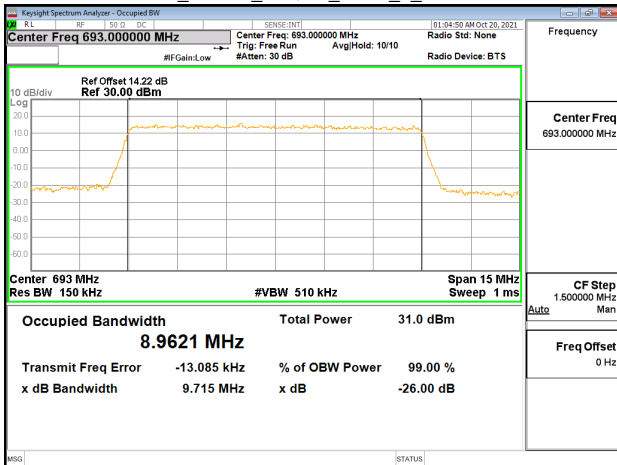

Band71\_15MHz\_QPSK\_RB75\_0\_CH133397

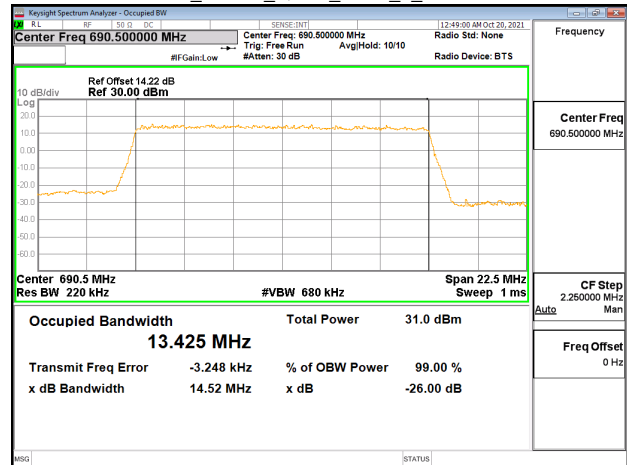

Unless otherwise stated the results shown in this test report refer only to the sample(s) tested and such sample(s) are retained for 90 days only.

除非另有說明，此報告結果僅對測試之樣品負責，同時此樣品僅保留90天。本報告未經本公司書面許可，不可部份複製。

This document is issued by the Company subject to its General Conditions of Service printed overleaf, available on request or accessible at <http://www.sgs.com.tw/Terms-and-Conditions> and for electronic format documents, subject to Terms and Conditions for Electronic Documents at <http://www.sgs.com.tw/Terms-and-Conditions>. Attention is drawn to the limitation of liability, indemnification and jurisdiction issues defined therein. Any holder of this document is advised that information contained herein reflects the Company's findings at the time of its intervention only and within the limits of Client's instructions, if any. The Company's sole responsibility is to its Client and this document does not exonerate parties to a transaction from exercising all their rights and obligations under the transaction documents. This document cannot be reproduced except in full, without prior written approval of the Company. Any unauthorized alteration, forgery or falsification of the content or appearance of this document is unlawful and offenders may be prosecuted to the fullest extent of the law.

Band71\_15MHz\_16QAM\_RB75\_0\_CH133197

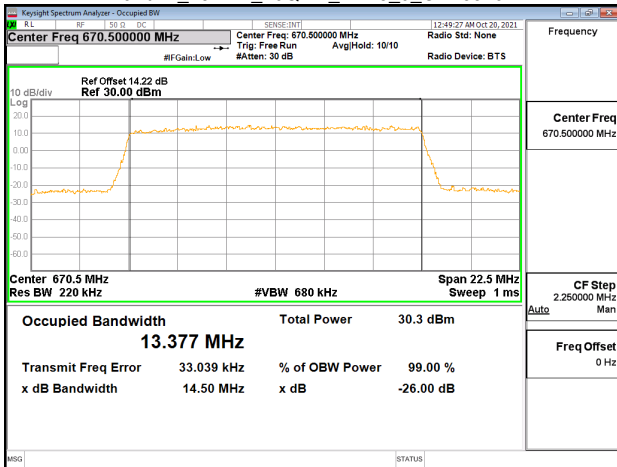

Band71\_15MHz\_64QAM\_RB75\_0\_CH133197

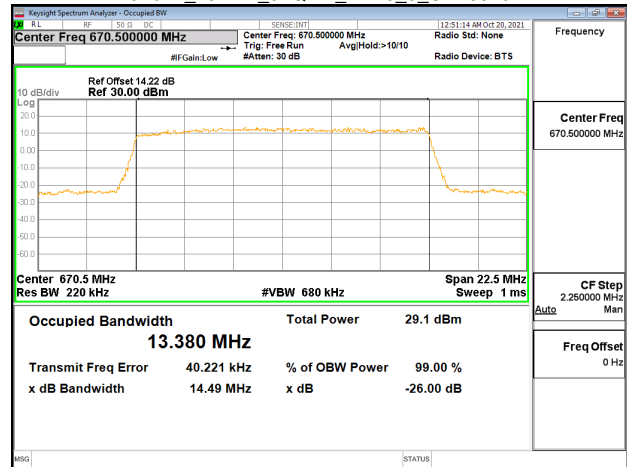

Band71\_15MHz\_16QAM\_RB75\_0\_CH133297

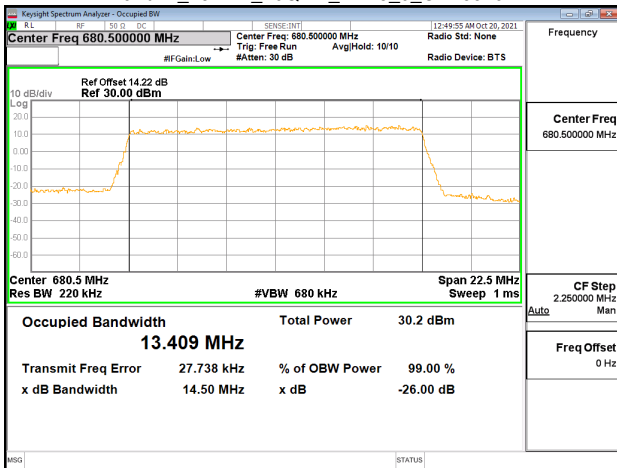

Band71\_15MHz\_64QAM\_RB75\_0\_CH133297

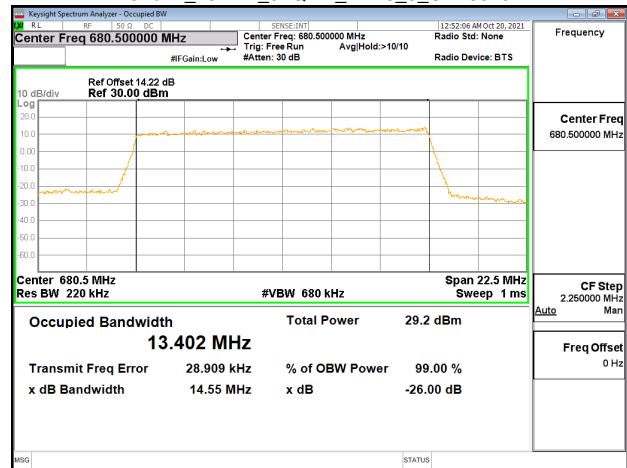

Band71\_15MHz\_16QAM\_RB75\_0\_CH133397

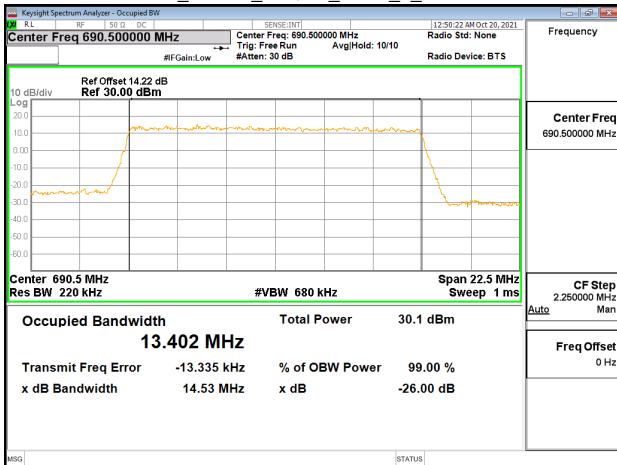

Band71\_15MHz\_64QAM\_RB75\_0\_CH133397

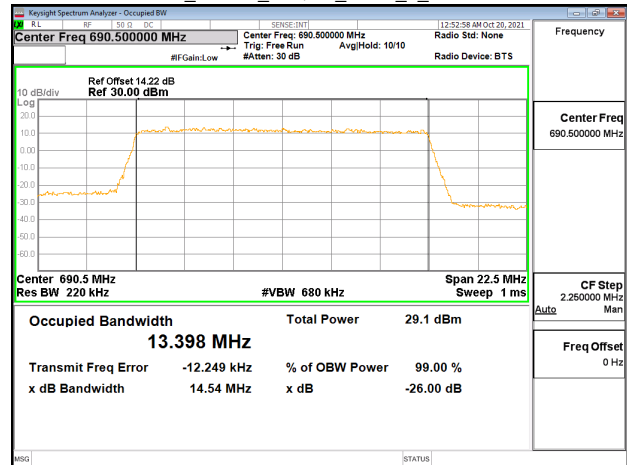

Unless otherwise stated the results shown in this test report refer only to the sample(s) tested and such sample(s) are retained for 90 days only.

除非另有說明，此報告結果僅對測試之樣品負責，同時此樣品僅保留90天。本報告未經本公司書面許可，不可部份複製。

This document is issued by the Company subject to its General Conditions of Service printed overleaf, available on request or accessible at <http://www.sgs.com.tw/Terms-and-Conditions> and for electronic format documents, subject to Terms and Conditions for Electronic Documents at <http://www.sgs.com.tw/Terms-and-Conditions>. Attention is drawn to the limitation of liability, indemnification and jurisdiction issues defined therein. Any holder of this document is advised that information contained herein reflects the Company's findings at the time of its intervention only and within the limits of Client's instructions, if any. The Company's sole responsibility is to its Client and this document does not exonerate parties to a transaction from exercising all their rights and obligations under the transaction documents. This document cannot be reproduced except in full, without prior written approval of the Company. Any unauthorized alteration, forgery or falsification of the content or appearance of this document is unlawful and offenders may be prosecuted to the fullest extent of the law.



Band71\_20MHz\_QPSK\_RB100\_0\_CH133222

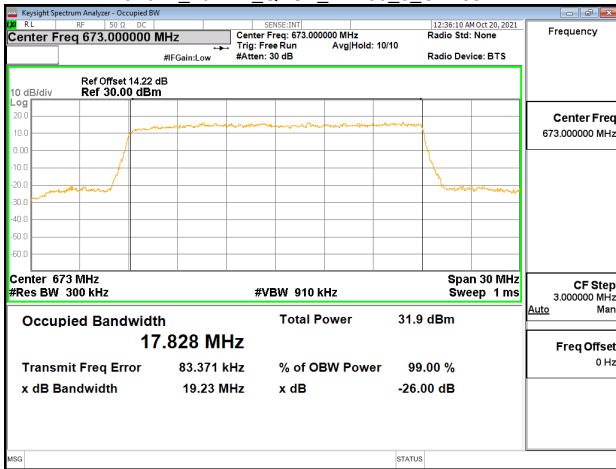

Band71\_20MHz\_16QAM\_RB100\_0\_CH133222

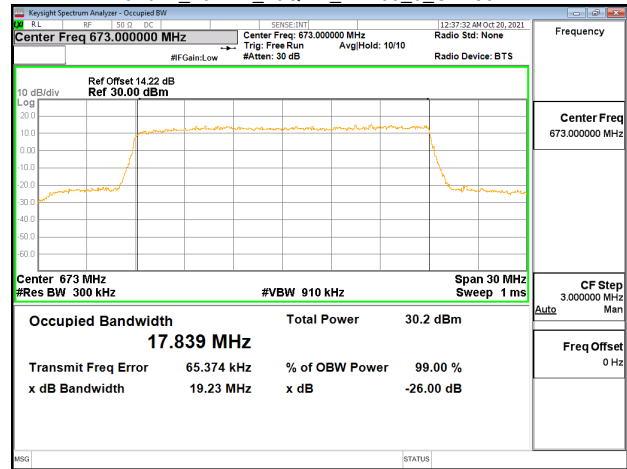

Band71\_20MHz\_QPSK\_RB100\_0\_CH133297

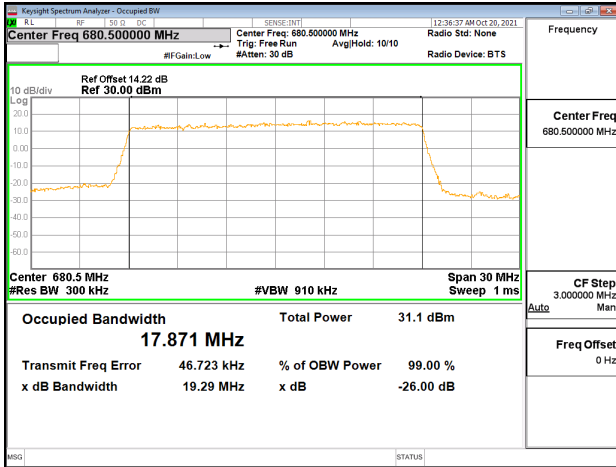

Band71\_20MHz\_16QAM\_RB100\_0\_CH133297

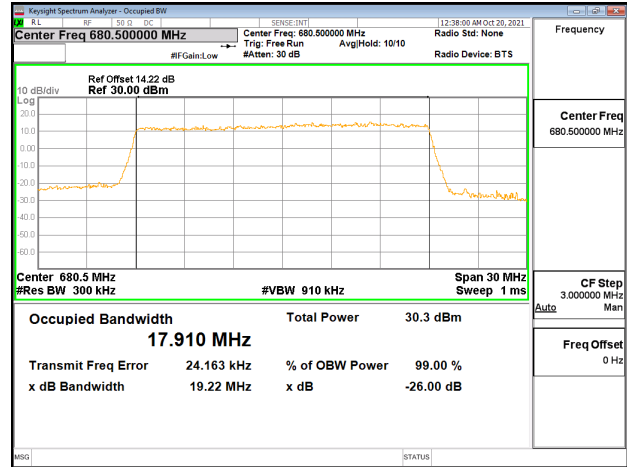

Band71\_20MHz\_QPSK\_RB100\_0\_CH133372

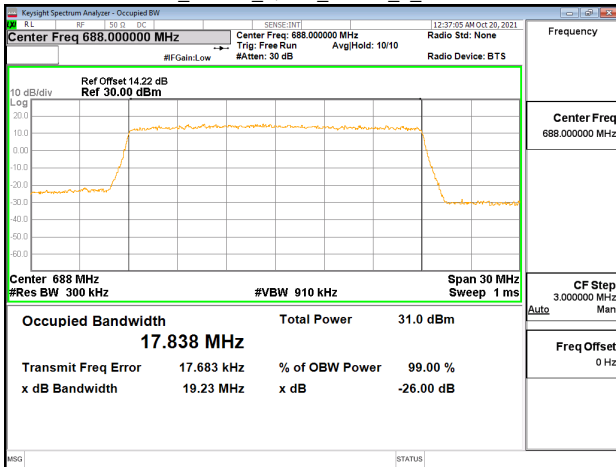

Band71\_20MHz\_16QAM\_RB100\_0\_CH133372

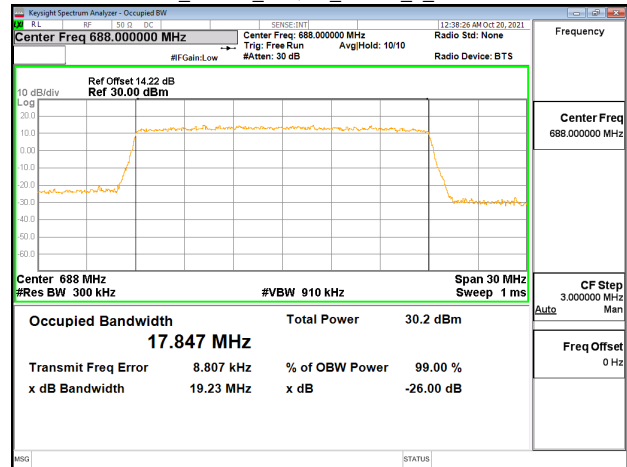

Unless otherwise stated the results shown in this test report refer only to the sample(s) tested and such sample(s) are retained for 90 days only.

除非另有說明，此報告結果僅對測試之樣品負責，同時此樣品僅保留90天。本報告未經本公司書面許可，不可部份複製。  
This document is issued by the Company subject to its General Conditions of Service printed overleaf, available on request or accessible at <http://www.sgs.com.tw/Terms-and-Conditions> and for electronic format documents, subject to Terms and Conditions for Electronic Documents at <http://www.sgs.com.tw/Terms-and-Conditions>. Attention is drawn to the limitation of liability, indemnification and jurisdiction issues defined therein. Any holder of this document is advised that information contained herein reflects the Company's findings at the time of its intervention only and within the limits of Client's instructions, if any. The Company's sole responsibility is to its Client and this document does not exonerate parties to a transaction from exercising all their rights and obligations under the transaction documents. This document cannot be reproduced except in full, without prior written approval of the Company. Any unauthorized alteration, forgery or falsification of the content or appearance of this document is unlawful and offenders may be prosecuted to the fullest extent of the law.

Band71\_20MHz\_64QAM\_RB100\_0\_CH133222

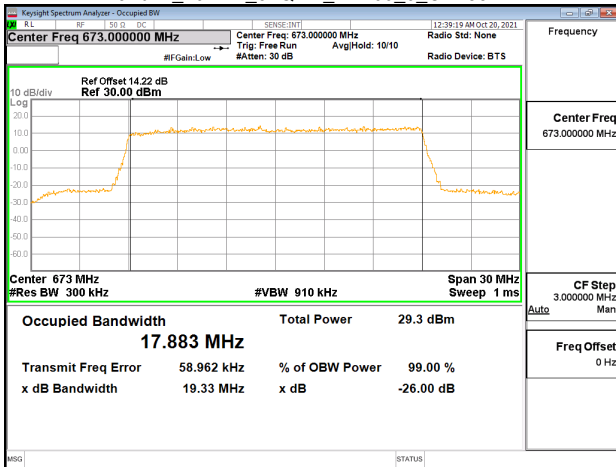

Band71\_20MHz\_64QAM\_RB100\_0\_CH133297

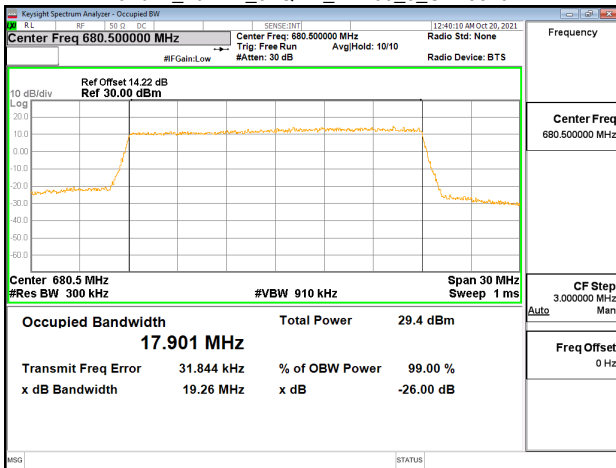

Band71\_20MHz\_64QAM\_RB100\_0\_CH133372

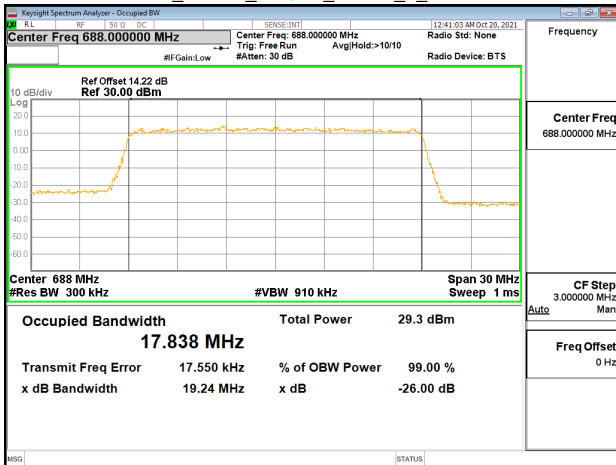

Unless otherwise stated the results shown in this test report refer only to the sample(s) tested and such sample(s) are retained for 90 days only.

除非另有說明，此報告結果僅對測試之樣品負責，同時此樣品僅保留90天。本報告未經本公司書面許可，不可部份複製。

This document is issued by the Company subject to its General Conditions of Service printed overleaf, available on request or accessible at <http://www.sgs.com.tw/Terms-and-Conditions> and for electronic format documents, subject to Terms and Conditions for Electronic Documents at <http://www.sgs.com.tw/Terms-and-Conditions>. Attention is drawn to the limitation of liability, indemnification and jurisdiction issues defined therein. Any holder of this document is advised that information contained hereon reflects the Company's findings at the time of its intervention only and within the limits of Client's instructions, if any. The Company's sole responsibility is to its Client and this document does not exonerate parties to a transaction from exercising all their rights and obligations under the transaction documents. This document cannot be reproduced except in full, without prior written approval of the Company. Any unauthorized alteration, forgery or falsification of the content or appearance of this document is unlawful and offenders may be prosecuted to the fullest extent of the law.

## 9 OUT OF BAND EMISSION AT ANTENNA TERMINALS

### 9.1 Standard Applicable

FCC §22.917(a), §24.238(a), §27.53(h), §90.543(e)(3)

RSS-130 §4.7, RSS-132 §5.5, RSS-133 §6.5.1, RSS-139 §6.6, RSS-140 §4.4, RSS-195 §5.6, RSS-199 §4.5

Out of band emissions. The power of any emission outside of the authorized operating frequency ranges must be attenuated below the transmitting power (P) by a factor of at least  $43 + 10 \log(P)$  dB.

#### FCC §27.53(a)

For operations in the 2305-2320 MHz band and the 2345-2360 MHz band, the power of any emission outside a licensee's frequency band(s) of operation shall be attenuated below the transmitter power P (with averaging performed only during periods of transmission) within the licensed band(s) of operation, in watts, by the following amounts:

- (4) For mobile and portable stations operating in the 2305-2315 MHz and 2350-2360 MHz bands:
- (i) By a factor of not less than:  $43 + 10 \log(P)$  dB on all frequencies between 2305 and 2320 MHz and on all frequencies between 2345 and 2360 MHz that are outside the licensed band(s) of operation, not less than  $55 + 10 \log(P)$  dB on all frequencies between 2320 and 2324 MHz and on all frequencies between 2341 and 2345 MHz, not less than  $61 + 10 \log(P)$  dB on all frequencies between 2324 and 2328 MHz and on all frequencies between 2337 and 2341 MHz, and not less than  $67 + 10 \log(P)$  dB on all frequencies between 2328 and 2337 MHz;
  - (ii) By a factor of not less than  $43 + 10 \log(P)$  dB on all frequencies between 2300 and 2305 MHz,  $55 + 10 \log(P)$  dB on all frequencies between 2296 and 2300 MHz,  $61 + 10 \log(P)$  dB on all frequencies between 2292 and 2296 MHz,  $67 + 10 \log(P)$  dB on all frequencies between 2288 and 2292 MHz, and  $70 + 10 \log(P)$  dB below 2288 MHz;
  - (iii) By a factor of not less than  $43 + 10 \log(P)$  dB on all frequencies between 2360 and 2365 MHz, and not less than  $70 + 10 \log(P)$  dB above 2365 MHz.

#### FCC §27.53(c)

For operations in the 746-758 MHz band and the 776-788 MHz band, the power of any emission outside the licensee's frequency band(s) of operation shall be attenuated below the transmitter power (P) within the licensed band(s) of operation, measured in watts, in accordance with the following:

- (2) On any frequency outside the 776-788 MHz band, the power of any emission shall be attenuated outside the band below the transmitter power (P) by at least  $43 + 10 \log(P)$  dB (-13dBm)
- (4) On all frequencies between 763-775 MHz and 793-805 MHz, by a factor not less than  $65 + 10 \log(P)$  dB in a 6.25 kHz band segment, for mobile and portable stations;

#### FCC §27.53(g)

Compliance for operations in the 600 MHz, 698-746 MHz, 746-758 MHz and the 776-788 MHz band with this provision is based on the use of measurement instrumentation employing a resolution bandwidth of 100 kilohertz or greater. However, in the 100 kilohertz bands immediately outside and adjacent to a licensee's frequency block, a resolution bandwidth of at least 30 kHz may be employed.

- (2) On any frequency outside the 776-788 MHz band, the power of any emission shall be attenuated outside the band below the transmitter power (P) by at least  $43 + 10 \log(P)$  dB;
- (3) On all frequencies between 763-775 MHz and 793-805 MHz, by a factor not less than  $76 + 10 \log(P)$  dB in a 6.25 kHz band segment, for base and fixed stations;
- (4) On all frequencies between 763-775 MHz and 793-805 MHz, by a factor not less than  $65 + 10 \log(P)$  dB in a 6.25 kHz band segment, for mobile and portable stations;

Unless otherwise stated the results shown in this test report refer only to the sample(s) tested and such sample(s) are retained for 90 days only.

除非另有說明，此報告結果僅對測試之樣品負責，同時此樣品僅保留90天。本報告未經本公司書面許可，不可部份複製。

This document is issued by the Company subject to its General Conditions of Service printed overleaf, available on request or accessible at <http://www.sgs.com.tw/Terms-and-Conditions> and for electronic format documents, subject to Terms and Conditions for Electronic Documents at <http://www.sgs.com.tw/Terms-and-Conditions>. Attention is drawn to the limitation of liability, indemnification and jurisdiction issues defined therein. Any holder of this document is advised that information contained hereon reflects the Company's findings at the time of its intervention only and within the limits of Client's instructions, if any. The Company's sole responsibility is to its Client and this document does not exonerate parties to a transaction from exercising all their rights and obligations under the transaction documents. This document cannot be reproduced except in full, without prior written approval of the Company. Any unauthorized alteration, forgery or falsification of the content or appearance of this document is unlawful and offenders may be prosecuted to the fullest extent of the law.

**ISED RSS-130 §4.7.1**

Compliance for operations in the 617-652 MHz, 663-698 MHz, 698-756 MHz and the 777-787 MHz band, the unwanted emissions in any 100 kHz bandwidth on any frequency outside the low frequency edge and the high frequency edge of each frequency block range(s), shall be attenuated below the transmitter power, P (dBW), by at least  $43 + 10 \log_{10} p$  (watts), dB. However, in the 100 kHz band immediately outside of the equipment's frequency block range, a resolution bandwidth of 30 kHz may be employed.

**ISED RSS-130 §4.7.2**

In addition to the limit outlined in section 4.7.1 above, equipment operating in the frequency bands 746-756 MHz and 777-787 MHz shall also comply with the following restrictions:

the power of any unwanted emissions in any 6.25 kHz bandwidth for all frequencies between 763-775 MHz and 793-806 MHz shall be attenuated below the transmitter power, P (dBW), by at least:

$76 + 10 \log_{10} p$  (watts), dB, for base and fixed equipment and

$65 + 10 \log_{10} p$  (watts), dB, for mobile and portable equipment

the e.i.r.p. in the band 1559-1610 MHz shall not exceed  $-70$  dBW/MHz for wideband signal and  $-80$  dBW for discrete emission with bandwidth less than 700 Hz.

**ISED RSS-132 §5.5**

Mobile and base station equipment shall comply with the limits in (i) and (ii) below.

- i. In the first 1.0 MHz band immediately outside and adjacent to each of the sub-bands specified in Section 5.1, the power of emissions per any 1% of the occupied bandwidth shall be attenuated (in dB) below the transmitter output power P (dBW) by at least  $43 + 10 \log_{10} p$  (watts).
- ii. After the first 1.0 MHz immediately outside and adjacent to each of the sub-bands, the power of emissions in any 100 kHz bandwidth shall be attenuated (in dB) below the transmitter output power P (dBW) by at least  $43 + 10 \log_{10} p$  (watts). If the measurement is performed using 1% of the occupied bandwidth, power integration over 100 kHz is required.

**ISED RSS-133 §6.5.1**

Equipment shall comply with the limits in (i) and (ii) below.

- i. In the 1.0 MHz bands immediately outside and adjacent to the equipment's operating frequency block, the emission power per any 1% of the emission bandwidth shall be attenuated (in dB) below the transmitter output power P (dBW) by at least  $43 + 10 \log_{10} p$  (watts).
- ii. After the first 1.0 MHz, the emission(s) power in any 1 MHz bandwidth shall be attenuated (in dB) below the transmitter output power P (dBW) by at least  $43 + 10 \log_{10} p$  (watts). If the measurement is performed using 1% of the emission bandwidth, power integration over 1.0 MHz is required.

**FCC §27.53(h)(1)**

(h) *AWS emission limits*—(1) *General protection levels*. Except as otherwise specified below, for operations in the 1695-1710 MHz, 1710-1755 MHz, 1755-1780 MHz, 1915-1920 MHz, 1995-2000 MHz, 2000-2020 MHz, 2110-2155 MHz, 2155-2180 MHz, and 2180-2200 bands, the power of any emission outside a licensee's frequency block shall be attenuated below the transmitter power (P) in watts by at least  $43 + 10 \log_{10} (P)$  dB.

**RSS-139 §6.6**

In the first 1.0 MHz bands immediately outside and adjacent to the equipment's smallest operating frequency block, Footnote 2 which can contain the equipment's occupied bandwidth, the emission

Unless otherwise stated the results shown in this test report refer only to the sample(s) tested and such sample(s) are retained for 90 days only.

除非另有說明，此報告結果僅對測試之樣品負責，同時此樣品僅保留90天。本報告未經本公司書面許可，不可部份複製。

This document is issued by the Company subject to its General Conditions of Service printed overleaf, available on request or accessible at <http://www.sgs.com.tw/Terms-and-Conditions> and for electronic format documents, subject to Terms and Conditions for Electronic Documents at <http://www.sgs.com.tw/Terms-and-Conditions>. Attention is drawn to the limitation of liability, indemnification and jurisdiction issues defined therein. Any holder of this document is advised that information contained hereon reflects the Company's findings at the time of its intervention only and within the limits of Client's instructions, if any. The Company's sole responsibility is to its Client and this document does not exonerate parties to a transaction from exercising all their rights and obligations under the transaction documents. This document cannot be reproduced except in full, without prior written approval of the Company. Any unauthorized alteration, forgery or falsification of the content or appearance of this document is unlawful and offenders may be prosecuted to the fullest extent of the law.

power per any 1% of the emission bandwidth shall be attenuated below the transmitter output power  $P$  (in dBW) by at least  $43 + 10 \log_{10} p$  (watts) dB.

After the first 1.0 MHz outside the equipment's smallest operating frequency block, which can contain the equipment's occupied bandwidth, the emission power in any 1 MHz bandwidth shall be attenuated below the transmitter output power  $P$  (in dBW) by at least  $43 + 10 \log_{10} p$  (watts) dB.

#### ISED RSS-140 §4.4

- a. For any frequency between 769-775 MHz and 799-806 MHz:
  - i.  $76 + 10 \log(p)$ , dB in a 6.25 kHz band for fixed and base station equipment
  - ii.  $65 + 10 \log(p)$ , dB in a 6.25 kHz band for mobile and portable/hand-held equipment
- b. For any frequency between 775-788 MHz, above 806 MHz, and below 758 MHz:  
 $43 + 10 \log(p)$ , dB in a bandwidth of 100 kHz or greater. However, in the 100 kHz bands immediately outside and adjacent to the frequency bands 758-768 MHz and 788-798 MHz, a resolution bandwidth of 30 kHz may be employed.

#### FCC §27.53(m) (4) (6)

For mobile digital stations, the attenuation factor shall be not less than  $40 + 10 \log(P)$  dB on all frequencies between the channel edge and 5 megahertz from the channel edge,  $43 + 10 \log(P)$  dB on all frequencies between 5 megahertz and  $X$  megahertz from the channel edge, and  $55 + 10 \log(P)$  dB on all frequencies more than  $X$  megahertz from the channel edge, where  $X$  is the greater of 6 megahertz or the actual emission bandwidth as defined in paragraph (m)(6) of this section. In addition, the attenuation factor shall not be less than  $43 + 10 \log(P)$  dB on all frequencies between 2490.5 MHz and 2496 MHz and  $55 + 10 \log(P)$  dB at or below 2490.5 MHz. Mobile Satellite Service licensees operating on frequencies below 2495 MHz may also submit a documented interference complaint against BRS licensees operating on channel BRS Channel 1 on the same terms and conditions as adjacent channel BRS or EBS licensees.

Measurement procedure. Compliance with these rules is based on the use of measurement instrumentation employing a resolution bandwidth of 1 megahertz or greater. However, in the 1 MHz bands immediately outside and adjacent to the frequency block a resolution bandwidth of at least one percent of the emission bandwidth of the fundamental emission of the transmitter may be employed; for mobile digital stations, in the 1 megahertz bands immediately outside and adjacent to the frequency block a resolution bandwidth of at least two percent may be employed, except when the 1 megahertz band is 2495-2496 MHz, in which case a resolution bandwidth of at least one percent may be employed. A narrower resolution bandwidth is permitted in all cases to improve measurement accuracy provided the measured power is integrated over the full required measurement bandwidth (i.e. 1 megahertz or 1 percent of emission bandwidth, as specified; or 1 megahertz or 2 percent for mobile digital stations, except in the band 2495-2496 MHz). The emission bandwidth is defined as the width of the signal between two points, one below the carrier center frequency and one above the carrier center frequency, outside of which all emissions are attenuated at least 26 dB below the transmitter power. With respect to television operations, measurements must be made of the separate visual and aural operating powers at sufficiently frequent intervals to ensure compliance with the rules.

#### ISED RSS-195 §5.6

The power of any emission outside the frequency range(s) in which the equipment operates shall be attenuated below the transmitter power,  $P$ (dBW), by the amount indicated in Table 2, where  $p$  is the transmitter output power measured in watts.

Unless otherwise stated the results shown in this test report refer only to the sample(s) tested and such sample(s) are retained for 90 days only.

除非另有說明，此報告結果僅對測試之樣品負責，同時此樣品僅保留90天。本報告未經本公司書面許可，不可部份複製。

This document is issued by the Company subject to its General Conditions of Service printed overleaf, available on request or accessible at <http://www.sgs.com.tw/Terms-and-Conditions> and for electronic format documents, subject to Terms and Conditions for Electronic Documents at <http://www.sgs.com.tw/Terms-and-Conditions>. Attention is drawn to the limitation of liability, indemnification and jurisdiction issues defined therein. Any holder of this document is advised that information contained hereon reflects the Company's findings at the time of its intervention only and within the limits of Client's instructions, if any. The Company's sole responsibility is to its Client and this document does not exonerate parties to a transaction from exercising all their rights and obligations under the transaction documents. This document cannot be reproduced except in full, without prior written approval of the Company. Any unauthorized alteration, forgery or falsification of the content or appearance of this document is unlawful and offenders may be prosecuted to the fullest extent of the law.

**Table 2 — Unwanted Emissions for Mobile, Portable and Low-Power Fixed Subscriber Equipment**

Frequency (MHz)	Attenuation (dB)	Frequency (MHz)	Attenuation (dB)
<2200	43 + 10 log <sub>10</sub> (p)	2324 - 2328	61 + 10 log <sub>10</sub> (p)
2200 - 2288	70 + 10 log <sub>10</sub> (p)	2328 - 2337	67 + 10 log <sub>10</sub> (p)
2288 - 2292	67 + 10 log <sub>10</sub> (p)	2337 - 2341	61 + 10 log <sub>10</sub> (p)
2292 - 2296	61 + 10 log <sub>10</sub> (p)	2341 - 2345	55 + 10 log <sub>10</sub> (p)
2296 - 2300	55 + 10 log <sub>10</sub> (p)	2345 - 2360	43 + 10 log <sub>10</sub> (p) FootnoteNote
2300 - 2305	43 + 10 log <sub>10</sub> (p)	2360 - 2365	43 + 10 log <sub>10</sub> (p)
2305 - 2320	43 + 10 log <sub>10</sub> (p) FootnoteNote	2365 - 2395	70 + 10 log <sub>10</sub> (p)
2320 - 2324	55 + 10 log <sub>10</sub> (p)	>2395	43 + 10 log <sub>10</sub> (p)

**Note** -- Mobile and portable equipment are prohibited from transmitting in the bands 2315-2320 MHz and 2345-2350 MHz. In addition, mobile and portable equipment employing FDD technology shall be restricted to transmitting in the band 2305-2315 MHz.

**RSS-199 §4.5**

In the 1 MHz band immediately outside and adjacent to the channel edge, the unwanted emission power shall be measured with a resolution bandwidth of at least 1% of the occupied bandwidth for base station and fixed subscriber equipment, and 2% for mobile subscriber equipment. Beyond the 1 MHz band, a resolution bandwidth of 1 MHz shall be used. A narrower resolution bandwidth can be used, provided that the measured power is integrated over the full required measurement bandwidth of 1 MHz, or 1% or 2% of the occupied bandwidth, as applicable.

Equipment shall comply with the following unwanted emission limits:

for base station and fixed subscriber equipment, the power of any unwanted emissions measured as above shall be attenuated (in dB) below the transmitter power, P (dBW), by at least 43 + 10 log<sub>10</sub> p for mobile subscriber equipment, the power of any unwanted emissions measured as above shall be attenuated (in dB) below the transmitter power, P (dBW), by at least:

40 + 10 log<sub>10</sub> p from the channel edges to 5 MHz away

43 + 10 log<sub>10</sub> p between 5 MHz and X MHz from the channel edges, and

55 + 10 log<sub>10</sub> p at X MHz and beyond from the channel edges

In addition, the attenuation shall not be less than 43 + 10 log<sub>10</sub> p on all frequencies between 2490.5 MHz and 2496 MHz, and 55 + 10 log<sub>10</sub> p at or below 2490.5 MHz.

In (a) and (b), p is the transmitter power measured in watts and X is 6 MHz or the equipment occupied bandwidth, whichever is greater.

**FCC §90.543 (e)**

For operations in the 758-768 MHz and the 788-798 MHz bands, the power of any emission outside the

licensee's frequency band(s) of operation shall be attenuated below the transmitter power (P) within the

licensed band(s) of operation, measured in watts, in accordance with the following:

- (1) On all frequencies between 769-775 MHz and 799-805 MHz, by a factor not less than 76 + 10 log (P) dB in a 6.25 kHz band segment, for base and fixed stations.
- (2) On all frequencies between 769-775 MHz and 799-805 MHz, by a factor not less than 65 + 10 log (P) dB in a 6.25 kHz band segment, for mobile and portable stations.
- (3) On any frequency between 775-788 MHz, above 805 MHz, and below 758 MHz, by at least 43 + 10 log (P) dB.

**FCC §90.691 Emission mask requirements for EA-based systems**

(a) Out-of-band emission requirement shall apply only to the “outer” channels included in an EA

Unless otherwise stated the results shown in this test report refer only to the sample(s) tested and such sample(s) are retained for 90 days only.

除非另有說明，此報告結果僅對測試之樣品負責，同時此樣品僅保留90天。本報告未經本公司書面許可，不可部份複製。

This document is issued by the Company subject to its General Conditions of Service printed overleaf, available on request or accessible at <http://www.sgs.com.tw/Terms-and-Conditions> and for electronic format documents, subject to Terms and Conditions for Electronic Documents at <http://www.sgs.com.tw/Terms-and-Conditions>. Attention is drawn to the limitation of liability, indemnification and jurisdiction issues defined therein. Any holder of this document is advised that information contained hereon reflects the Company's findings at the time of its intervention only and within the limits of Client's instructions, if any. The Company's sole responsibility is to its Client and this document does not exonerate parties to a transaction from exercising all their rights and obligations under the transaction documents. This document cannot be reproduced except in full, without prior written approval of the Company. Any unauthorized alteration, forgery or falsification of the content or appearance of this document is unlawful and offenders may be prosecuted to the fullest extent of the law.

license and to spectrum adjacent to interior channels used by incumbent licensees. The emission limits are as follows:

(1) For any frequency removed from the EA licensee's frequency block by up to and including 37.5 kHz, the power of any emission shall be attenuated below the transmitter power (P) in watts by at least  $116 \text{ Log}_{10}(f/6.1)$  decibels or  $50 + 10 \text{ Log}_{10}(P)$  decibels or 80 decibels, whichever is the lesser attenuation, where f is the frequency removed from the center of the outer channel in the block in kilohertz and where f is greater than 12.5 kHz.

(2) For any frequency removed from the EA licensee's frequency block greater than 37.5 kHz, the power of any emission shall be attenuated below the transmitter power (P) in watts by at least  $43 + 10 \text{ Log}_{10}(P)$  decibels or 80 decibels, whichever is the lesser attenuation, where f is the frequency removed from the center of the outer channel in the block in kilohertz and where f is greater than 37.5 kHz.

## 9.2 Test SET-UP

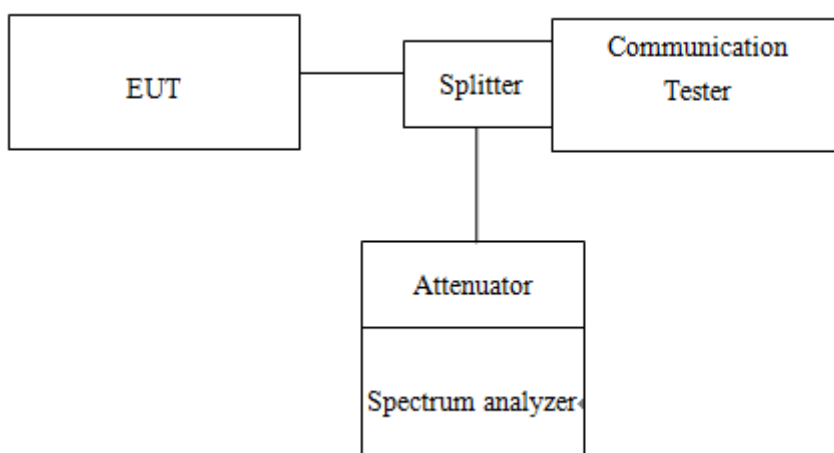

Unless otherwise stated the results shown in this test report refer only to the sample(s) tested and such sample(s) are retained for 90 days only.

除非另有說明，此報告結果僅對測試之樣品負責，同時此樣品僅保留90天。本報告未經本公司書面許可，不可部份複製。

This document is issued by the Company subject to its General Conditions of Service printed overleaf, available on request or accessible at <http://www.sgs.com.tw/Terms-and-Conditions> and for electronic format documents, subject to Terms and Conditions for Electronic Documents at <http://www.sgs.com.tw/Terms-and-Conditions>. Attention is drawn to the limitation of liability, indemnification and jurisdiction issues defined therein. Any holder of this document is advised that information contained hereon reflects the Company's findings at the time of its intervention only and within the limits of Client's instructions, if any. The Company's sole responsibility is to its Client and this document does not exonerate parties to a transaction from exercising all their rights and obligations under the transaction documents. This document cannot be reproduced except in full, without prior written approval of the Company. Any unauthorized alteration, forgery or falsification of the content or appearance of this document is unlawful and offenders may be prosecuted to the fullest extent of the law.

### 9.3 Measurement Procedure

#### 9.3.1 Conducted Emission

The RF output of the transceiver was connected to a spectrum analyzer through appropriate attenuation. The resolution bandwidth of the spectrum analyzer was set at 1MHz, sufficient scans were taken to show the out of band Emissions if any up to 10th harmonic.

1. To connect Antenna Port of EUT to Spectrum.
2. Set RBW = 1MHz & VBW = 1MHz on Spectrum.
3. Allow trace to fully stabilize
4. Repeat above procedures until all default test channel measured were complete.

#### 9.3.2 Band Edge

1. To connect Antenna Port of EUT to Spectrum.
2. The band edge of low and high channels for the highest RF powers was measured. Setting RBW  $\geq$  1% EBW.
3. Allow trace to fully stabilize
4. Repeat above procedures until all default test channel measured were complete.

### 9.4 Band Edge Measurement Result:

Refer to next pages.

Unless otherwise stated the results shown in this test report refer only to the sample(s) tested and such sample(s) are retained for 90 days only.

除非另有說明，此報告結果僅對測試之樣品負責，同時此樣品僅保留90天。本報告未經本公司書面許可，不可部份複製。

This document is issued by the Company subject to its General Conditions of Service printed overleaf, available on request or accessible at <http://www.sgs.com.tw/Terms-and-Conditions> and for electronic format documents, subject to Terms and Conditions for Electronic Documents at <http://www.sgs.com.tw/Terms-and-Conditions>. Attention is drawn to the limitation of liability, indemnification and jurisdiction issues defined therein. Any holder of this document is advised that information contained hereon reflects the Company's findings at the time of its intervention only and within the limits of Client's instructions, if any. The Company's sole responsibility is to its Client and this document does not exonerate parties to a transaction from exercising all their rights and obligations under the transaction documents. This document cannot be reproduced except in full, without prior written approval of the Company. Any unauthorized alteration, forgery or falsification of the content or appearance of this document is unlawful and offenders may be prosecuted to the fullest extent of the law.



Band Edge\_Band2\_1.4MHz\_QPSK\_RB1\_0\_CH18607

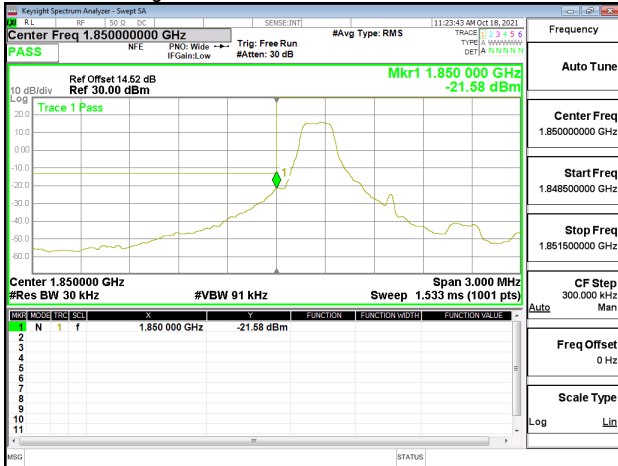

Band Edge\_Band2\_1.4MHz\_QPSK\_RB6\_0\_CH19193

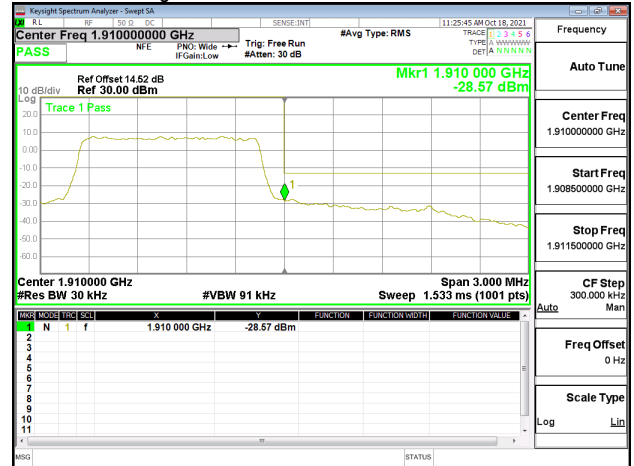

Band Edge\_Band2\_1.4MHz\_QPSK\_RB1\_5\_CH19193



Band Edge\_Band2\_3MHz\_QPSK\_RB1\_0\_CH18615

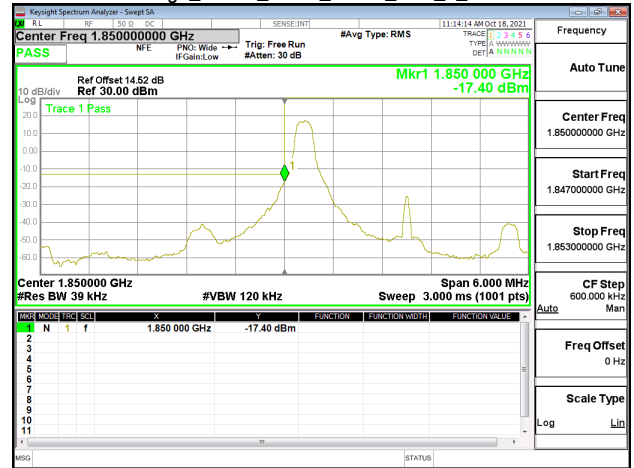

Band Edge\_Band2\_1.4MHz\_QPSK\_RB6\_0\_CH18607

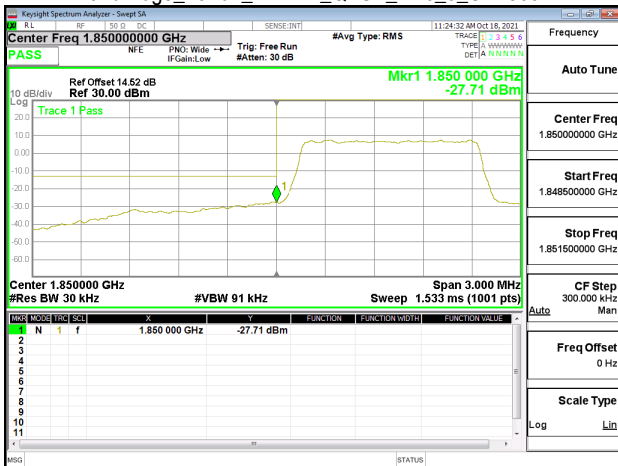

Band Edge\_Band2\_3MHz\_QPSK\_RB1\_14\_CH19185

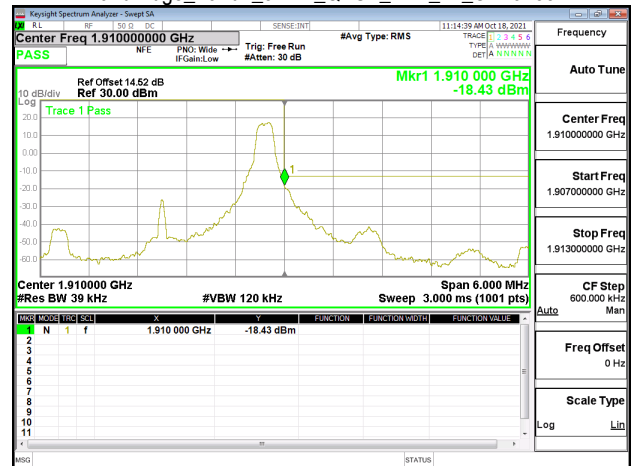

Unless otherwise stated the results shown in this test report refer only to the sample(s) tested and such sample(s) are retained for 90 days only.

除非另有說明，此報告結果僅對測試之樣品負責，同時此樣品僅保留90天。本報告未經本公司書面許可，不可部份複製。

This document is issued by the Company subject to its General Conditions of Service printed overleaf, available on request or accessible at <http://www.sgs.com.tw/Terms-and-Conditions> and for electronic format documents, subject to Terms and Conditions for Electronic Documents at <http://www.sgs.com.tw/Terms-and-Conditions>. Attention is drawn to the limitation of liability, indemnification and jurisdiction issues defined therein. Any holder of this document is advised that information contained herein reflects the Company's findings at the time of its intervention only and within the limits of Client's instructions, if any. The Company's sole responsibility is to its Client and this document does not exonerate parties to a transaction from exercising all their rights and obligations under the transaction documents. This document cannot be reproduced except in full, without prior written approval of the Company. Any unauthorized alteration, forgery or falsification of the content or appearance of this document is unlawful and offenders may be prosecuted to the fullest extent of the law.

Band Edge\_Band2\_3MHz\_QPSK\_RB15\_0\_CH18615

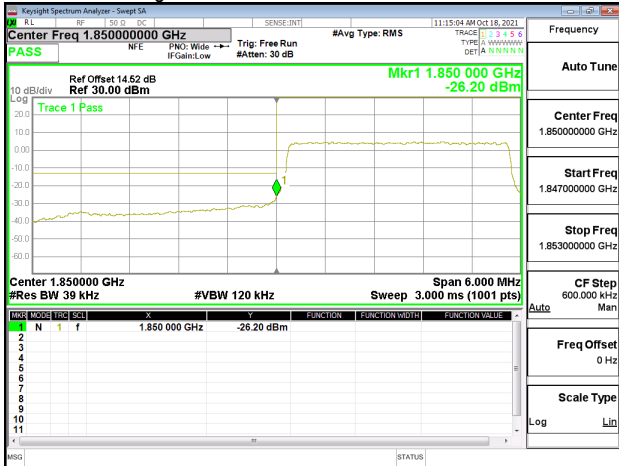

Band Edge\_Band2\_5MHz\_QPSK\_RB1\_24\_CH19175

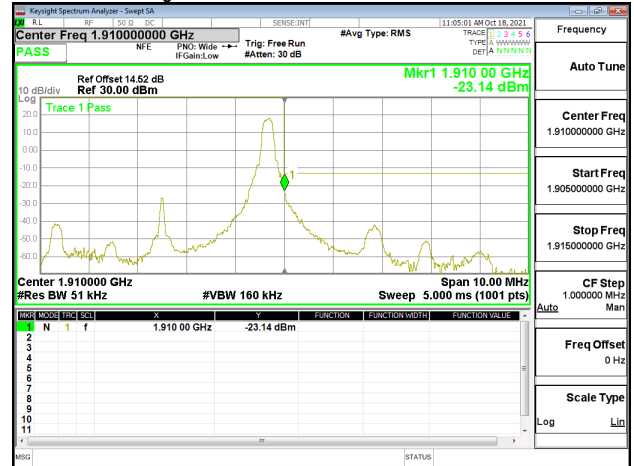

Band Edge\_Band2\_3MHz\_QPSK\_RB15\_0\_CH19185

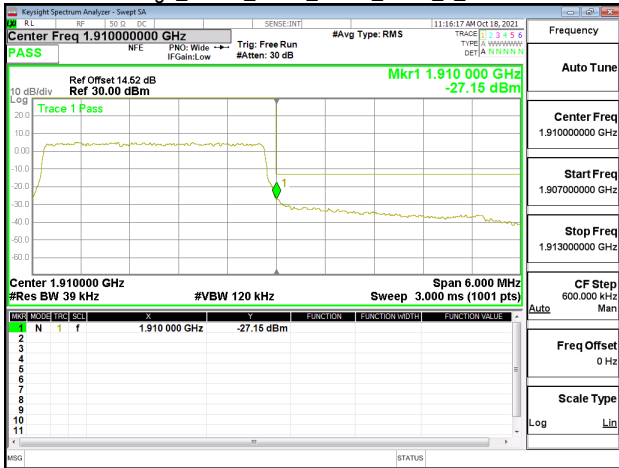

Band Edge\_Band2\_5MHz\_QPSK\_RB25\_0\_CH18625

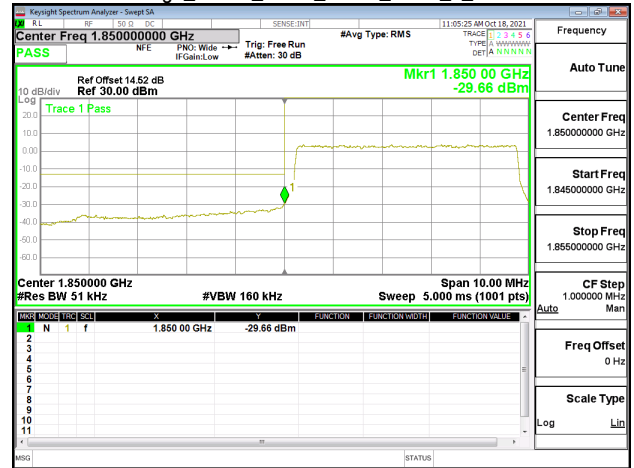

Band Edge\_Band2\_5MHz\_QPSK\_RB1\_0\_CH18625

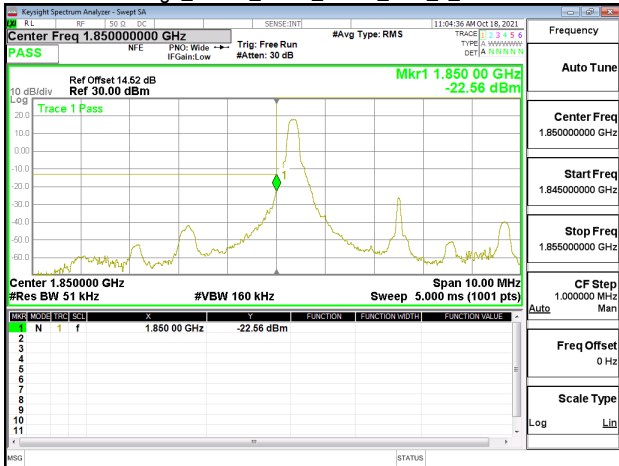

Band Edge\_Band2\_5MHz\_QPSK\_RB25\_0\_CH19175

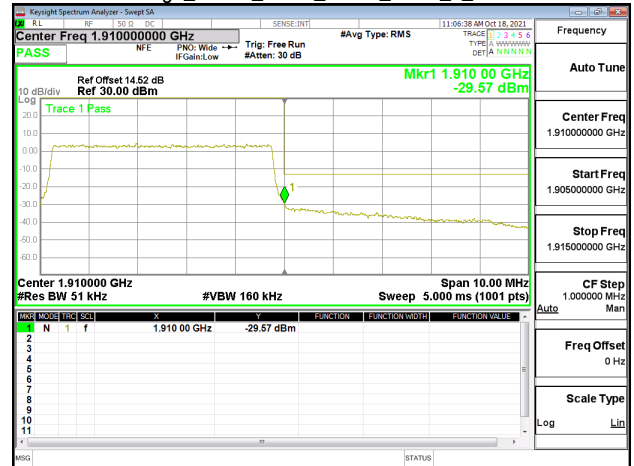

Unless otherwise stated the results shown in this test report refer only to the sample(s) tested and such sample(s) are retained for 90 days only.

除非另有說明，此報告結果僅對測試之樣品負責，同時此樣品僅保留90天。本報告未經本公司書面許可，不可部份複製。

This document is issued by the Company subject to its General Conditions of Service printed overleaf, available on request or accessible at <http://www.sgs.com.tw/Terms-and-Conditions> and for electronic format documents, subject to Terms and Conditions for Electronic Documents at <http://www.sgs.com.tw/Terms-and-Conditions>. Attention is drawn to the limitation of liability, indemnification and jurisdiction issues defined therein. Any holder of this document is advised that information contained herein reflects the Company's findings at the time of its intervention only and within the limits of Client's instructions, if any. The Company's sole responsibility is to its Client and this document does not exonerate parties to a transaction from exercising all their rights and obligations under the transaction documents. This document cannot be reproduced except in full, without prior written approval of the Company. Any unauthorized alteration, forgery or falsification of the content or appearance of this document is unlawful and offenders may be prosecuted to the fullest extent of the law.